



Three Years of Atmospheric Characterization at Ka/Q-band with the NASA/POLIMI Alphasat Receiver in Milan, Italy

Environmental Effects on Radio Propagation (T09-1)

Michael Zemba,¹ James Nessel,¹ Lorenzo Luini,² Carlo Riva²

¹NASA Glenn Research Center, Cleveland, Ohio

²Politecnico di Milano, Milano MI, Italy

Presented by Michael Zemba
NASA Glenn Research Center
Advanced High Frequency Branch

+1.216.433.5357
michael.j.zemba@nasa.gov

EuCAP 2018



London, United Kingdom



April 9th, 2018



Presentation Overview

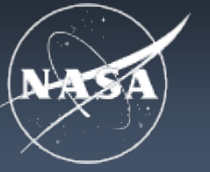

*Alphasat in Ariane 5 fairing.
(Photo: ESA)*

1. Motivation & Experiment Goals
2. Site of Study
3. Instrumentation
4. Beacon Receiver Design
5. Disdrometer Specifications
6. Derivation of Scaling Factor from DSD Data
7. Results & Analysis
8. Concluding Remarks

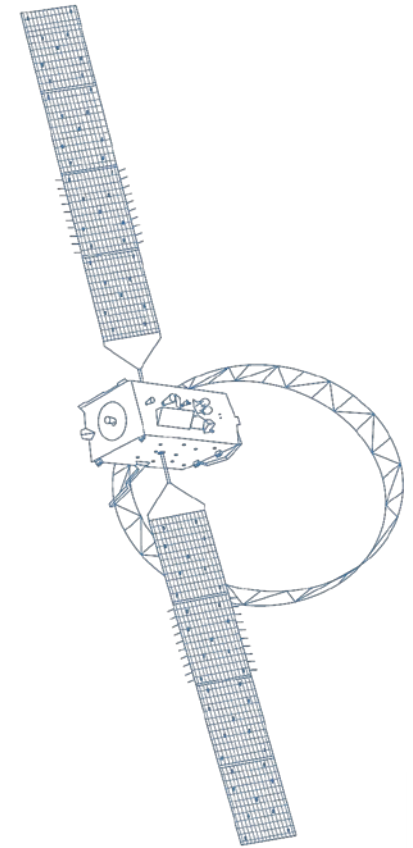

*Alphasat wireframe model (deployed).
(Photo: ESA)*

Motivation & Goals



Launch of Alphasat on an Ariane 5, July 2013.
(Photo: ESA / CNES / ARIANESPACE)

Experiment Goals

- To **assess the impact** of atmospheric effects on links operating in the Q-band (rain attenuation, scintillation, etc.) in various climatological regions through distributed measurement campaigns.
- To assist the **development of physical models** to improve predictions of atmospheric attenuation within the Q-band.

NASA Motivation

- Preliminary architecture studies of the next generation TDRSS system will require higher downlink bandwidths than available in the current Ku-band allocation
- The allocation of 4 GHz of contiguous bandwidth in the Q-band provides an opportunity to meet these requirements
- NASA mission planning benefits greatly from Q-band measurements near NASA frequency allocations at Deep Space Network sites.

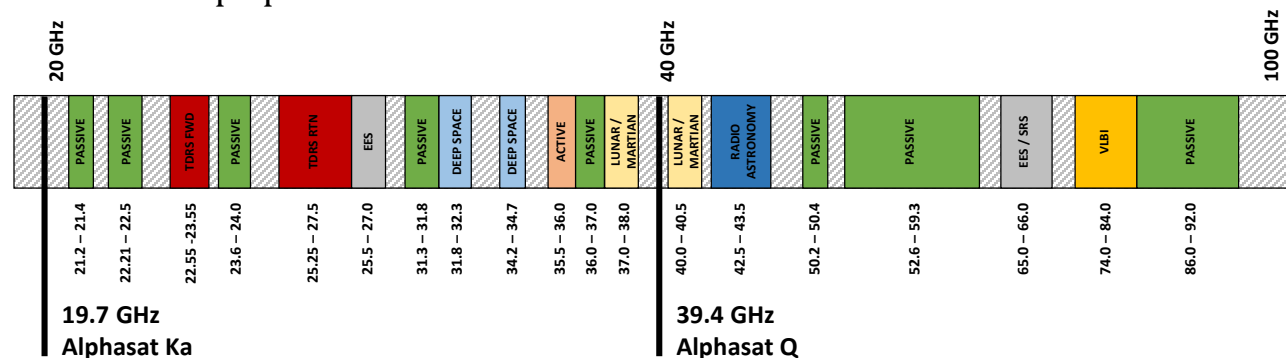

Site of Study

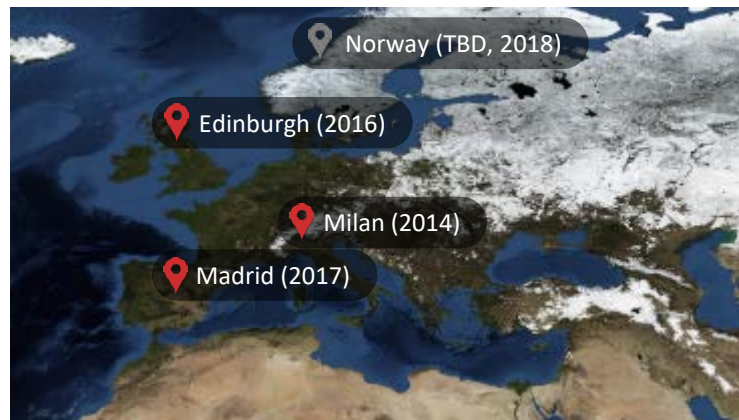
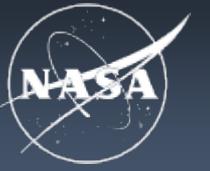

NASA Alphasat Stations



Beacon Receivers, Disdrometer, and Weather Station at the POLIMI DEIB Building

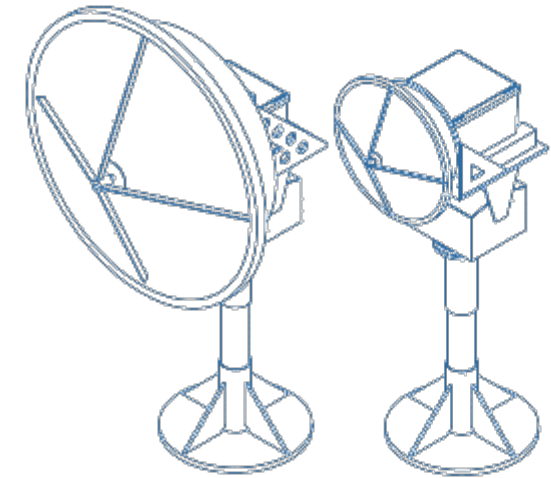

Milan, Italy		
Ground Station	Installation Date	April 2014
	Latitude	45.4787° N
	Longitude	9.2327° E
Satellite	Altitude	138 m
	Name	Alphasat
	Nom. Elevation	35°
	Nom. Azimuth	158°
	Beacon Freqs.	19.701 GHz 39.402 GHz

Instrumentation



Beacon Receivers



Antenna Gain	45.6 dBi
Antenna Beamwidth	0.9 deg
Antenna Tracking Resolution	0.01°
LNA Gain	33 dB
LNA Noise Figure	2.5 dB
Beacon Frequencies	19.701 GHz / 39.402 GHz

Optical Disdrometer



Final IF Frequency	5 MHz
Measurement Rates	8 Hz and 1 Hz
Dynamic Range	38 dB
Temperature Control	0.01 °C (plate) / 0.1 °C (LNA) / 2 °C (air)
Weather Station	RM Young
Disdrometer	Thies Clima 5.4110

Weather Instrumentation



- Anemometer:**
Young 05178A
- Temp/RH Sensor:**
Young 41382VC
- Pressure Sensor:**
Young BPV3000
- Tipping Bucket:**
Young 52203

Beacon Receiver Design



Beacon Receiver Specifications	
Downconversion (Ka)	2-step down to 5 MHz
Downconversion (Q)	3-step down to 5 MHz
System Noise Temperature	504 K (Ka-band) 720 K (Q-band)
Dynamic Range	38 dB (Ka-band) 40 dB (Q-band)
ADC Sampling Rate	3.077 MHz
ADC # of Samples	2^{17}
Time Series Output Rate	8 Hz / 1 Hz (averaged)

Updated November 2017

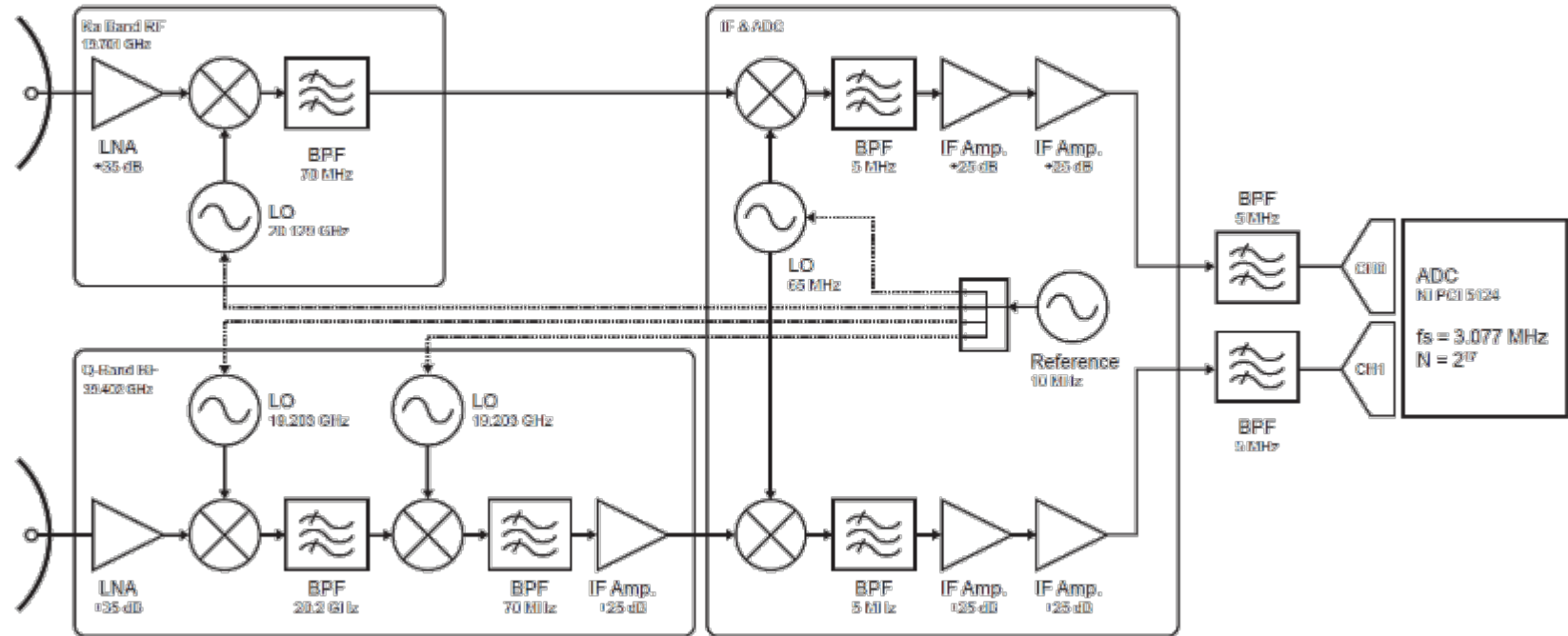

The beacons are downconverted from 19.701 GHz and 39.402 GHz to 70 MHz in at the feed. The Q channel is converted in two stages, first to 20.199 GHz, then to 70 MHz. The signal is run a short distance (< 5m) over shielded coaxial cable fiber to the final downconversion stage (5 MHz) and then another coaxial run (< 30m) before digitization. All LOs are referenced to a common ultra-stable 10 MHz reference oscillator.

Temperature Stability

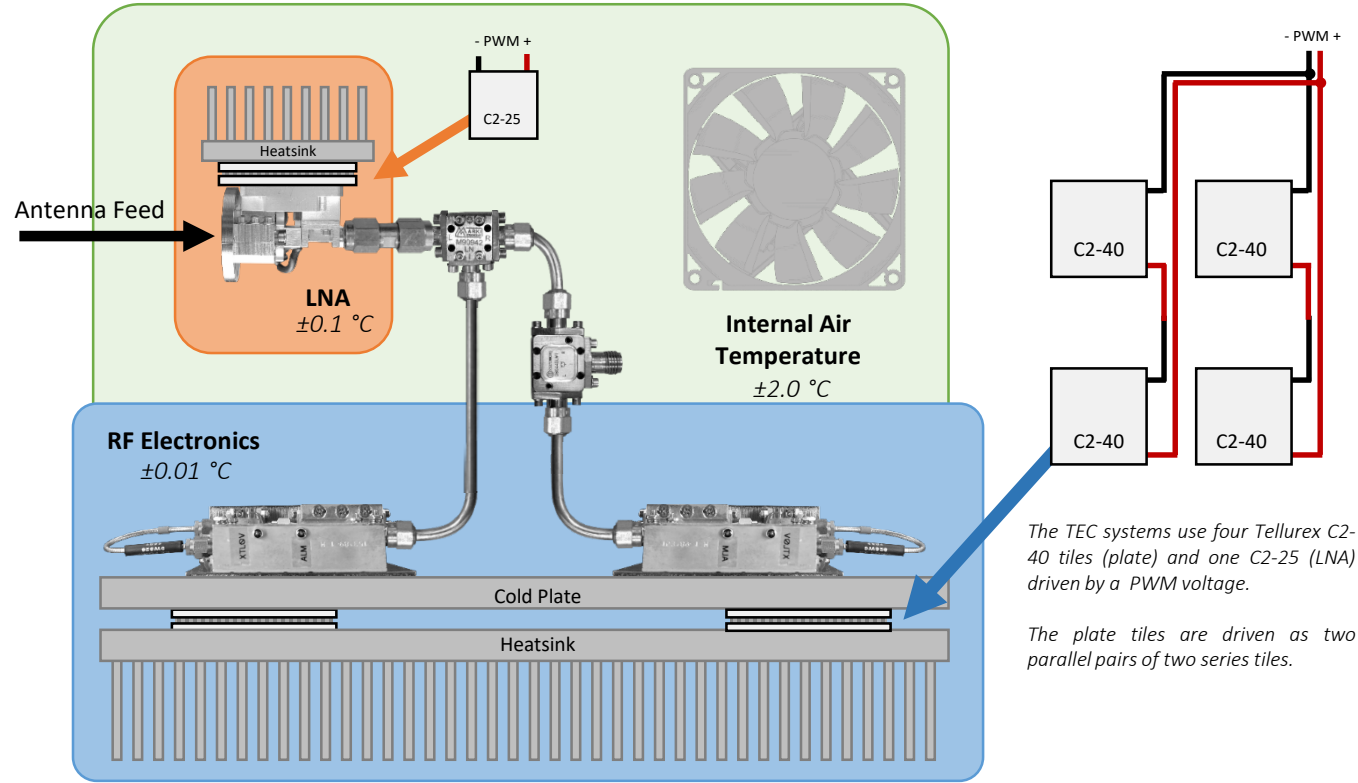

The TEC systems use four Tellurex C2-40 tiles (plate) and one C2-25 (LNA) driven by a PWM voltage.

The plate tiles are driven as two parallel pairs of two series tiles.

4 Day Temperature Stability

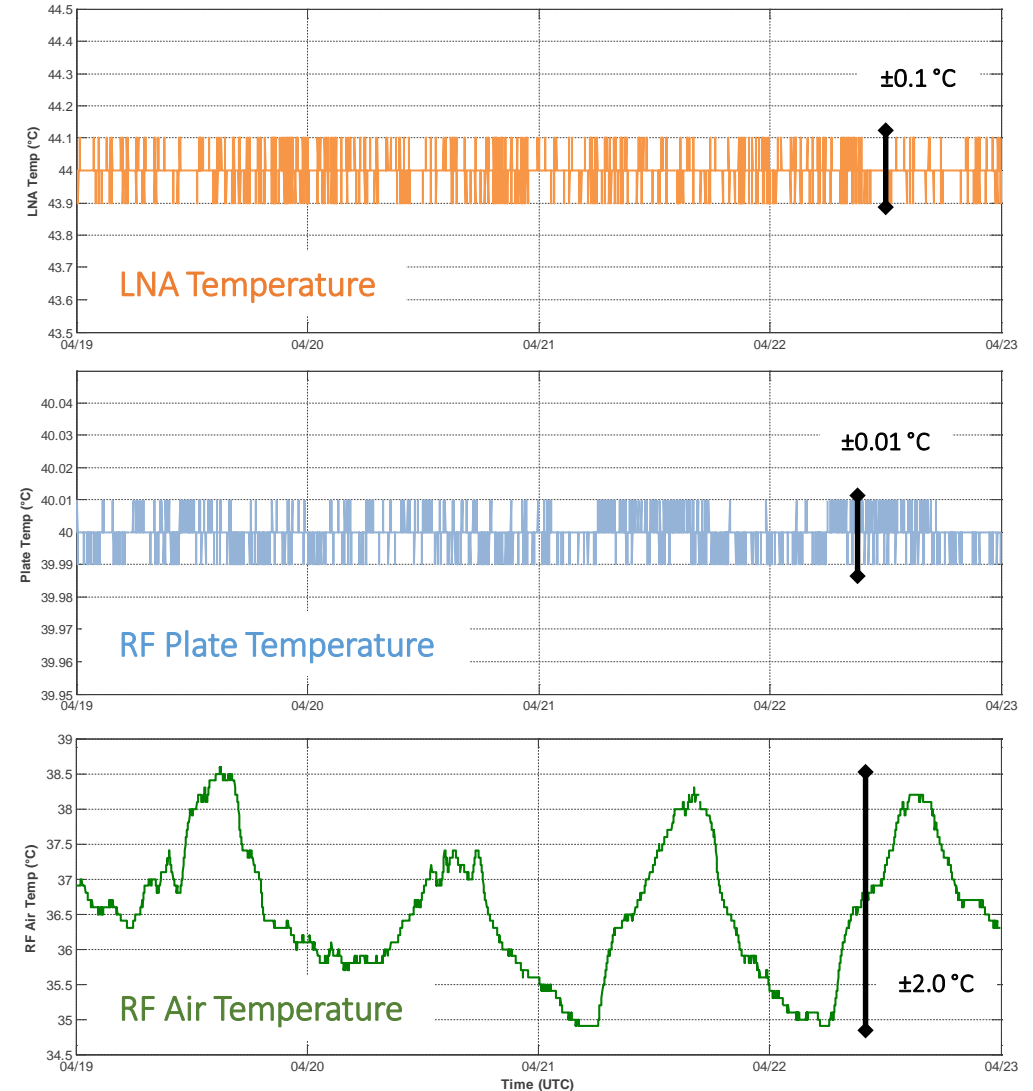

System temperature is tightly controlled to limit gain variation. A primary thermoelectric cooling (TEC) system controls a cold-plate within each RF enclosure to within $\pm 0.01^\circ\text{C}$.

All mountable RF components are heatsinked to this plate including LOs, IF amplifiers, and filters. The noise diode is also heatsinked to this plate. The LNA is mounted directly to the feed and cannot be heatsinked to the cold plate. Instead, a secondary TEC system controls the LNA to within $\pm 0.1^\circ\text{C}$.

The internal air temperature of the enclosure is circulated with a fan and maintains stability within about $\pm 2.0^\circ\text{C}$ day-to-day with some larger seasonal drift.

Signal Tracking (Q from Ka)

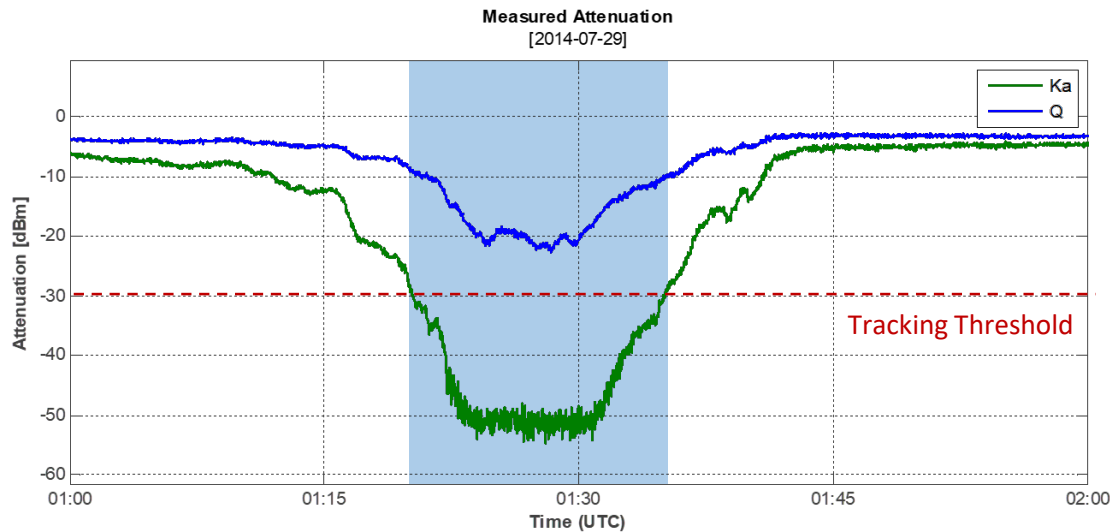
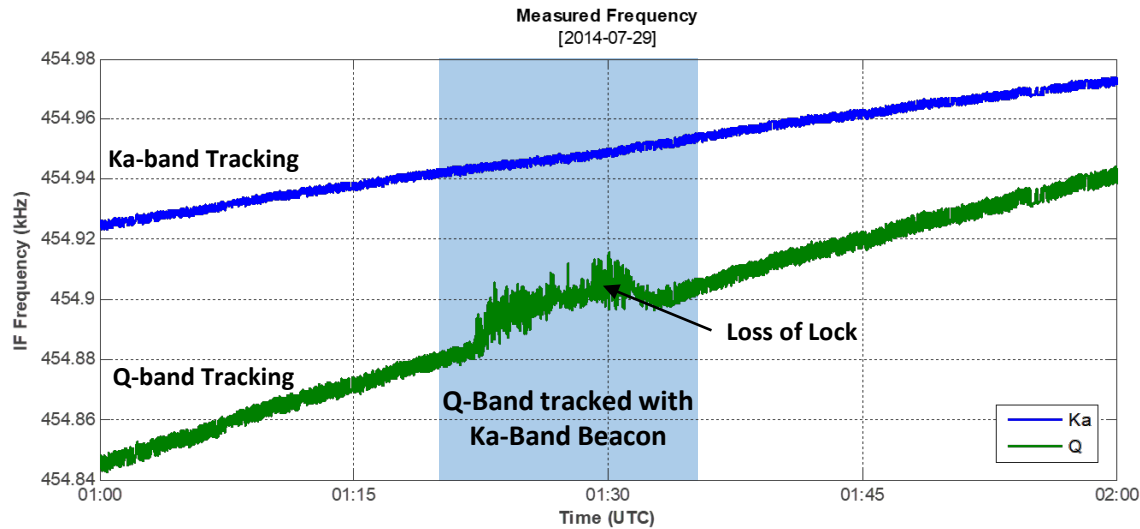

Under normal operating conditions, the K-band and Q-band receivers track their respective beacon signals independently.

When attenuation exceeds 30 dB on the Q-band channel, the receiver utilizes the coherent K-band channel to maintain lock on the Q-band (region shown in blue).

Eventually, for deep rain fades, lock can no longer be maintained and the noise floor of the Q-band receiver is reached.

Signal lock is immediately regained when the signal reappears above the noise floor.

Digital Radiometer Implementation

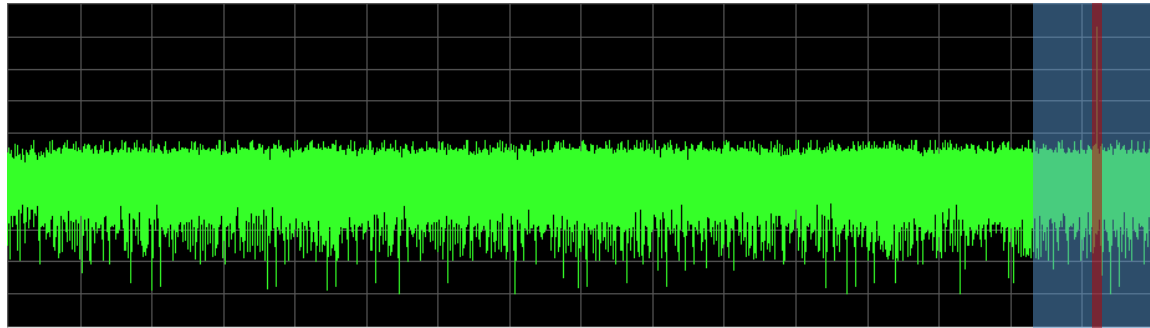

Nyquist Sampled Spectrum
 $(f_s/2 = 1.55 \text{ MHz})$

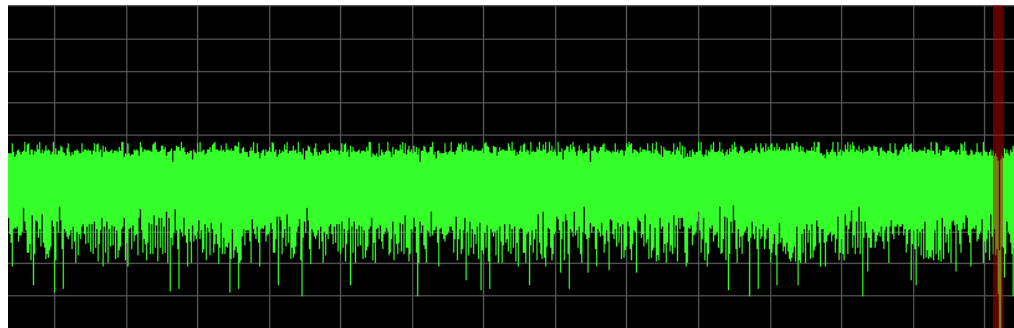

Noise Power Spectrum
 Notch Filter @ Beacon Frequency →
 Integrate Noise Power

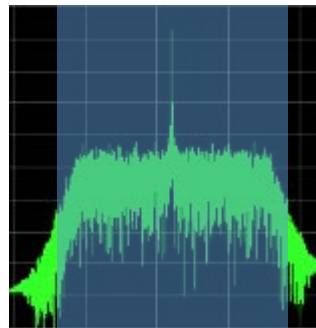

Signal Spectrum
 BPF @ Beacon Frequency →
 Decimate / Undersample →
 Estimate Frequency (QNF) →
 Calculate Signal Power

A digital radiometer measurement is implemented by pre-processing the sampled data before calculating the signal power.

Noise Power - The full bandwidth output from the final-stage filter is Nyquist sampled to obtain the noise power measurement. A digital notch filter is applied, centered on a moving average of past beacon frequency estimates, to remove the signal power. The remaining noise power is then integrated to produce the noise power measurement.

Signal Power - The signal power is obtained by applying a digital band-pass sampling around the beacon frequency, then decimating to reduce the computational demand of the FFT / frequency estimators used to estimate signal power.

f_s	3.1 MHz
N	2^{17} (113,072)
Decimation	2^5 (32)
BPF Bandwidth	0.888 MHz
Notch Bandwidth	25 kHz

Statistics (2014 - 2017)

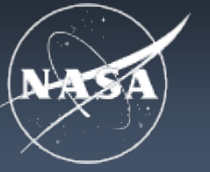

Ka-Band

Q-Band

Annual

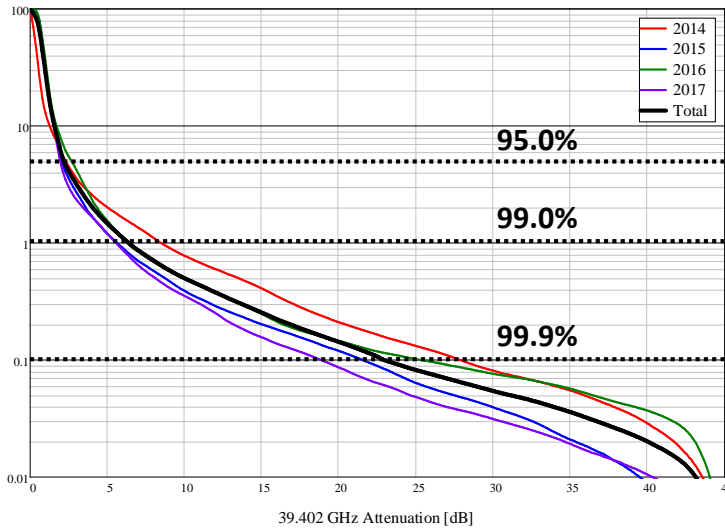
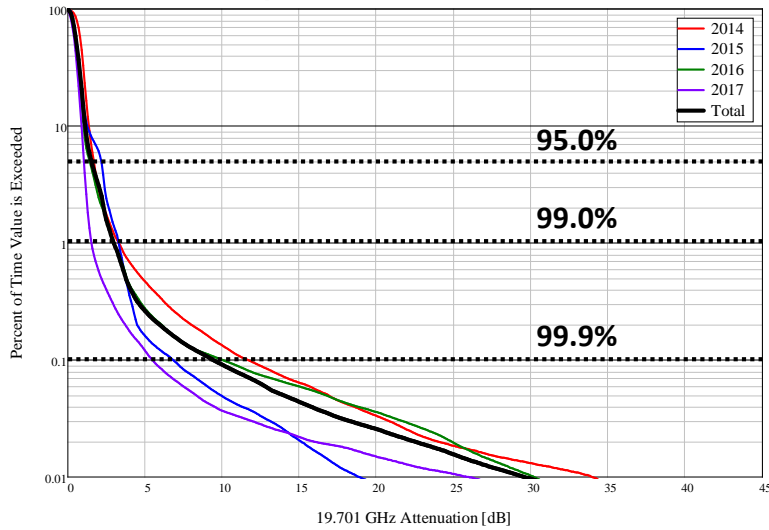

Monthly

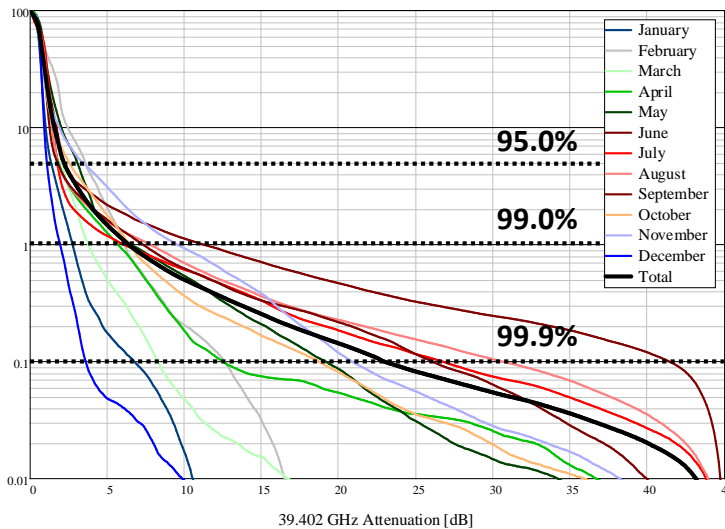
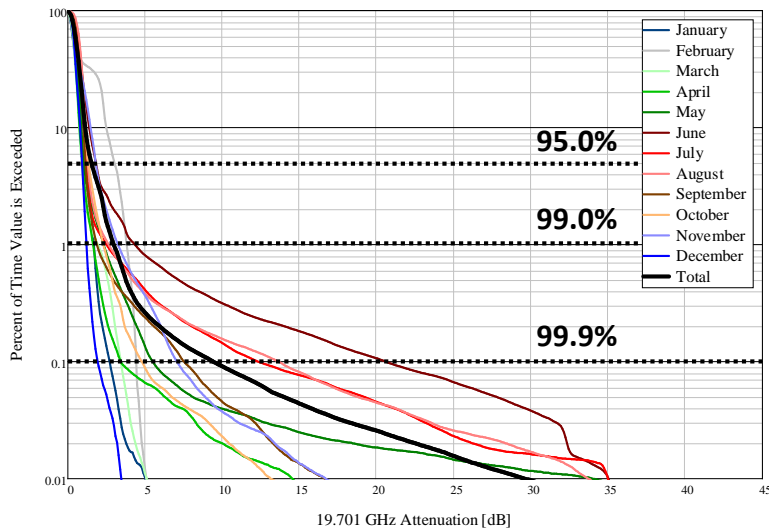

	Ka-Band			Q-Band			
	95%	99%	99.9%	95%	99%	99.9%	
Monthly Averages	January	1.26	1.69	2.72	1.36	2.76	6.76
	February	3.03	3.82	4.45	3.59	6.14	12.64
	March	0.89	1.95	3.44	2.12	3.77	8.29
	April	0.96	1.64	3.45	1.85	5.71	12.52
	May	1.05	2.33	5.51	3.07	6.55	19.19
	June	1.82	4.36	20.61	2.25	11.25	41.50
	July	1.22	2.52	12.34	1.77	6.08	26.78
	August	1.29	2.65	13.66	1.80	7.79	30.67
	September	1.15	1.89	7.53	1.79	7.32	26.13
	October	1.34	2.31	4.80	2.54	6.44	18.75
	November	1.81	3.26	7.09	3.43	9.54	20.90
	December	0.93	1.22	1.94	1.09	1.95	3.61
Annual	2014	1.69	3.31	11.69	2.30	8.50	27.93
	2015	2.17	3.31	6.83	2.06	5.65	21.60
	2016	1.42	3.01	10.05	2.70	6.31	25.40
	2017	1.05	1.54	5.49	1.95	5.58	18.88
Total	1.53	2.98	9.44	2.19	6.39	22.99	

For 99% availability, the associated link margin was 2.98 dB (Ka-band) and 6.39 dB (Q-band).

On a monthly basis, the highest attenuation was observed in the wetter summer and fall months (July, August, September) and the smallest attenuation in the drier winter months (December, January, February).

Concluding Remarks



Conclusions:

- Alphasat Milan Station has operated reliably since May 2014 with maintenance and upgrades in November 2017.
- Data collection expected to continue for a minimum of five years and/or through remainder of Alphasat TDP#5 propagation experiment.
- Collected attenuation and scintillation data is used to validate and update propagation models, as well as to contribute to ITU databanks at higher frequencies
- Digital radiometer measurement added in 2017 upgrades provides valuable clear sky reference level which may be referenced to local radiometer.

Future Work:

- Continued analysis of attenuation, scintillation data, including emphasis on fade duration and fade slope.
- Validation of digital radiometer with water vapor radiometer data for derivation of clear sky reference level.

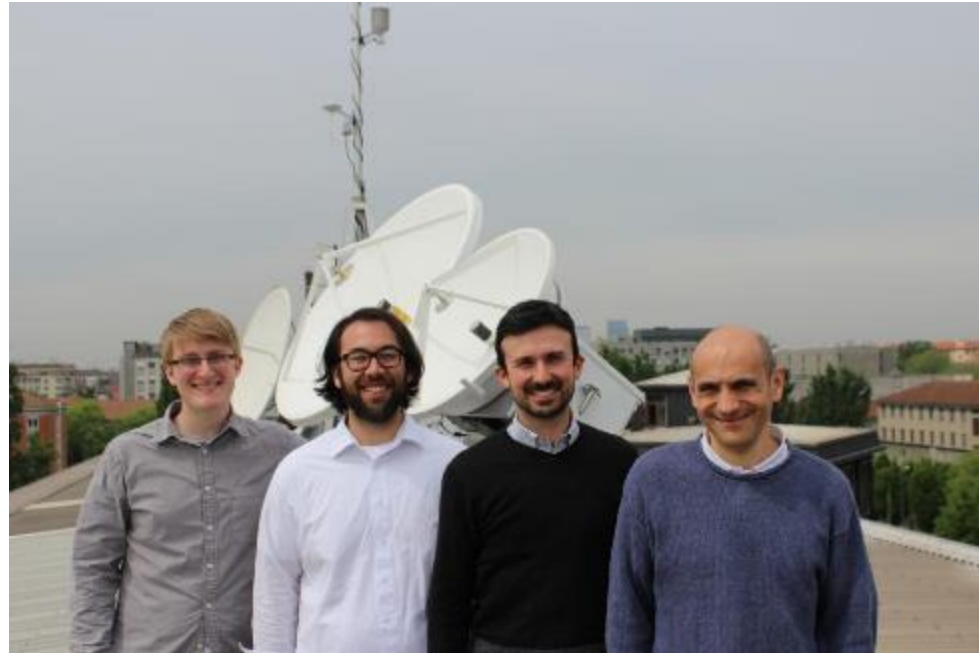

Thank you!



Appendix Charts

Contact Information



 NASA Glenn Research Center
21000 Brookpark Rd. MS 54-1
Cleveland, Ohio 44135, USA

James Nessel

Principal Investigator, RF Propagation Task

 216.433.2546

 james.a.nessel@nasa.gov

Michael Zemba

Co Investigator, RF Propagation Task

 216.433.5357

 michael.j.zemba@nasa.gov

Statistics (Monthly by Year)

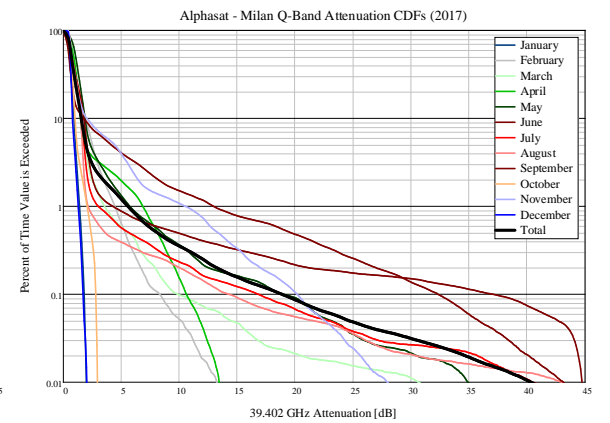
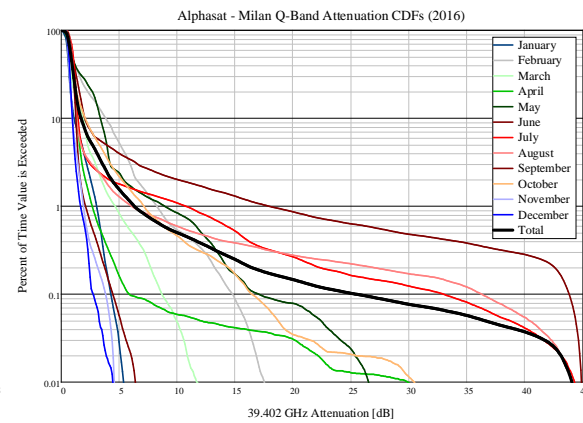
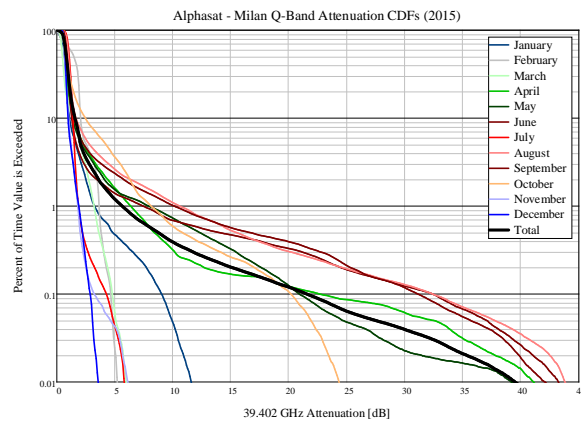
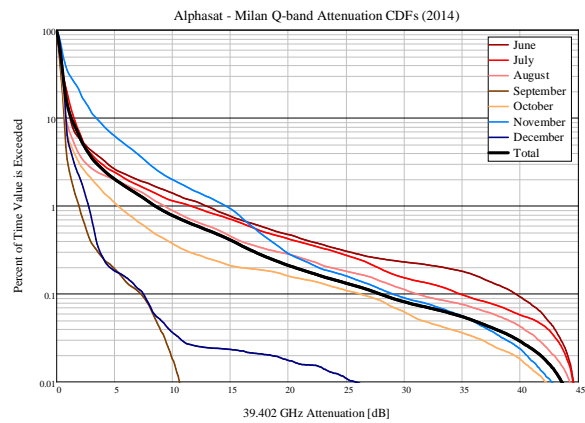
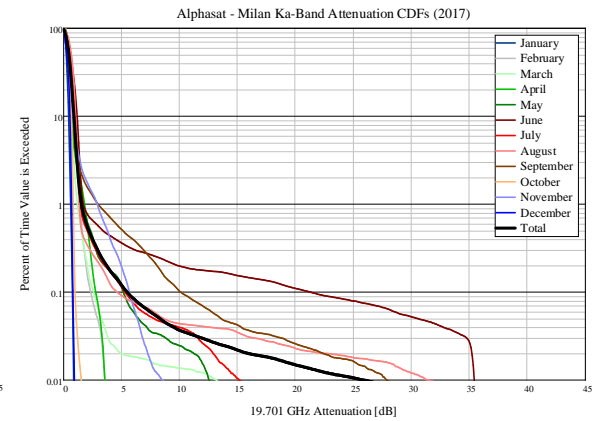
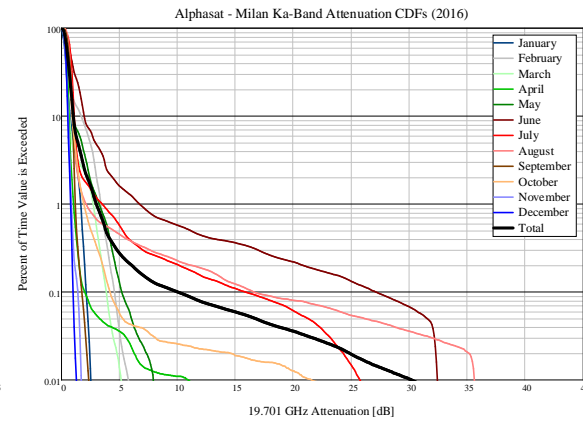
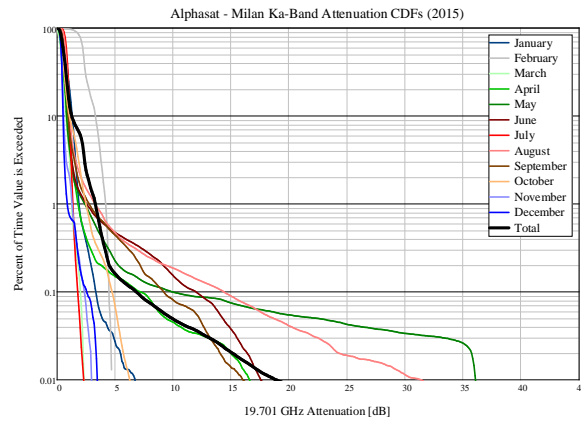
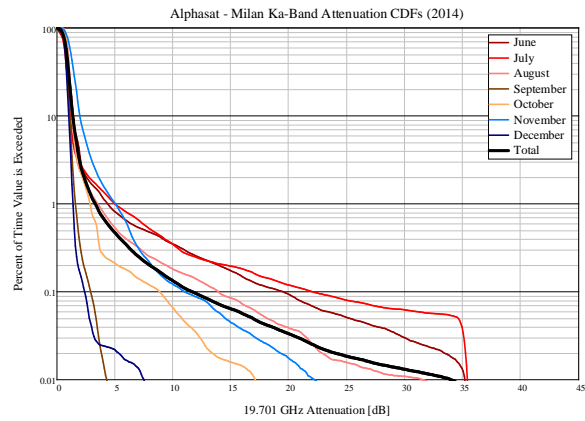

Measurement Spectral Density

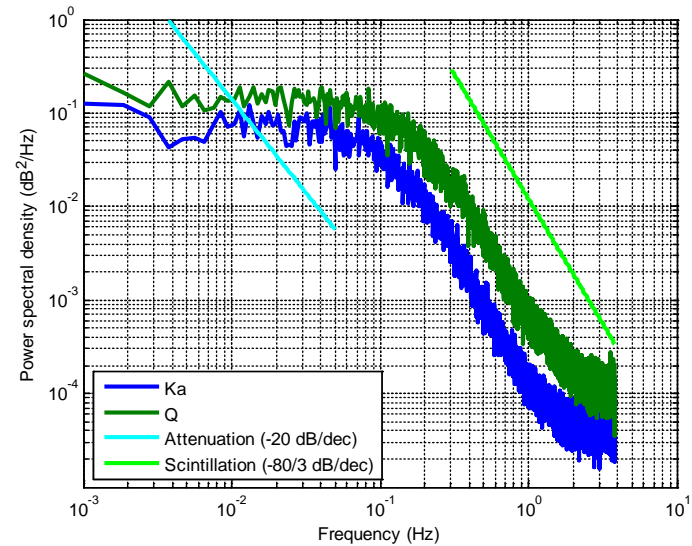
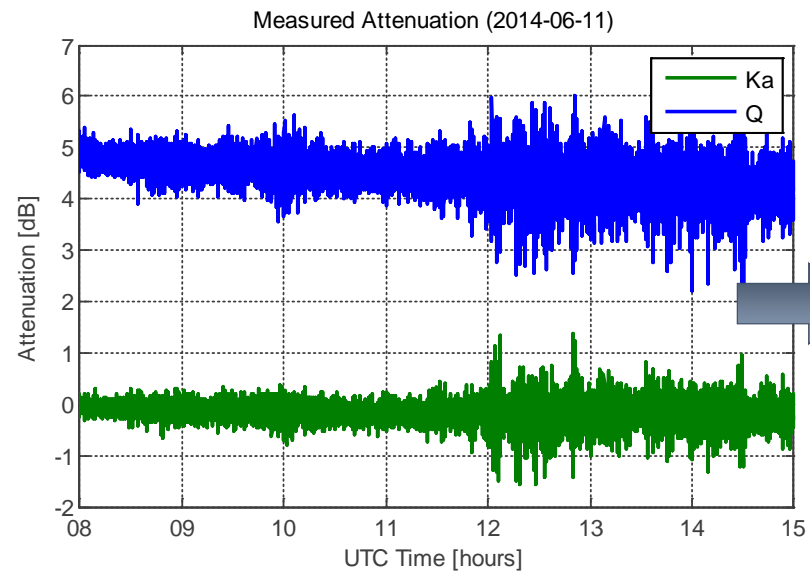
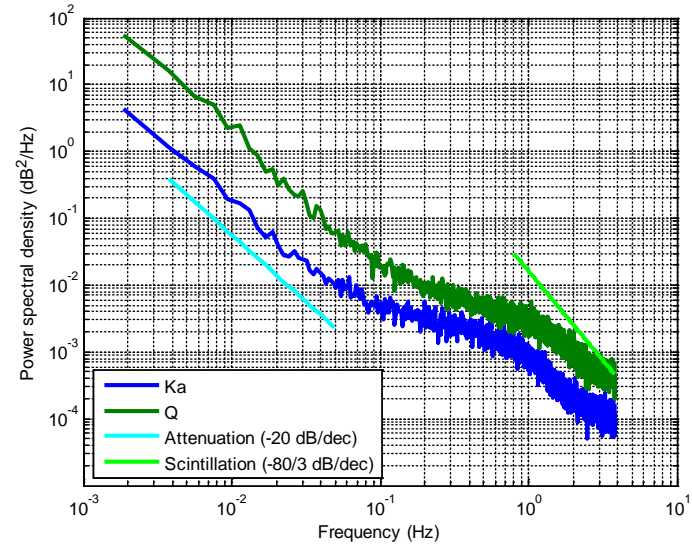
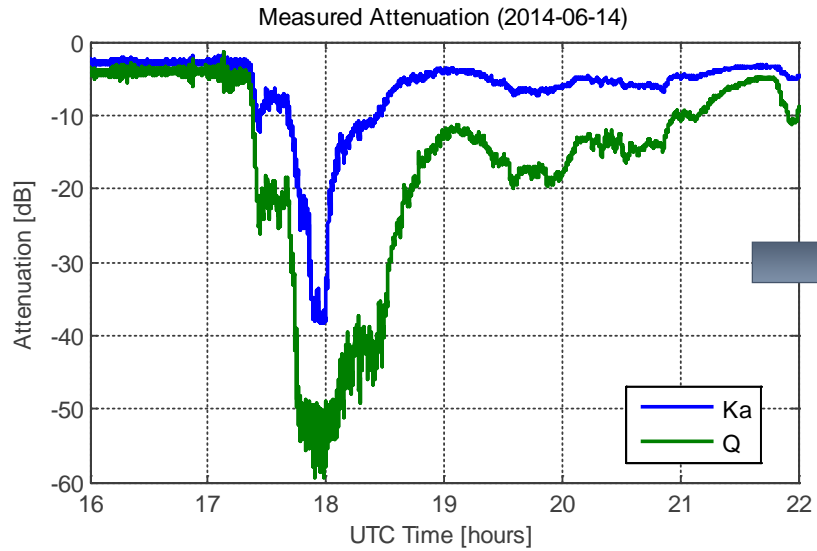

Reference Attenuation Level

Due to the absence of a radiometer the attenuation reference level is calculated using radiosonde observations and National Weather Prediction products. The total attenuation is then calculated using:

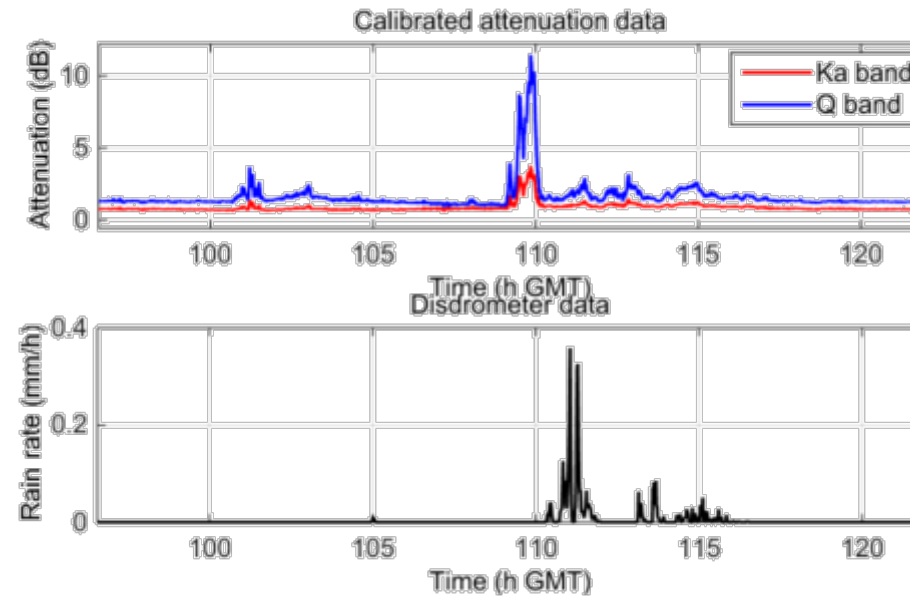
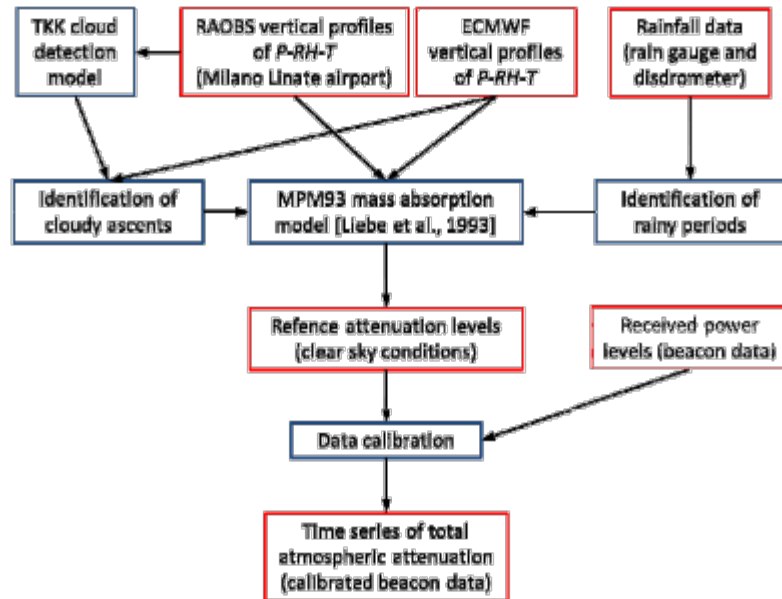

Monthly Results



Alphasat - Milan Ka-B and S Scintillation CDFs (2014)

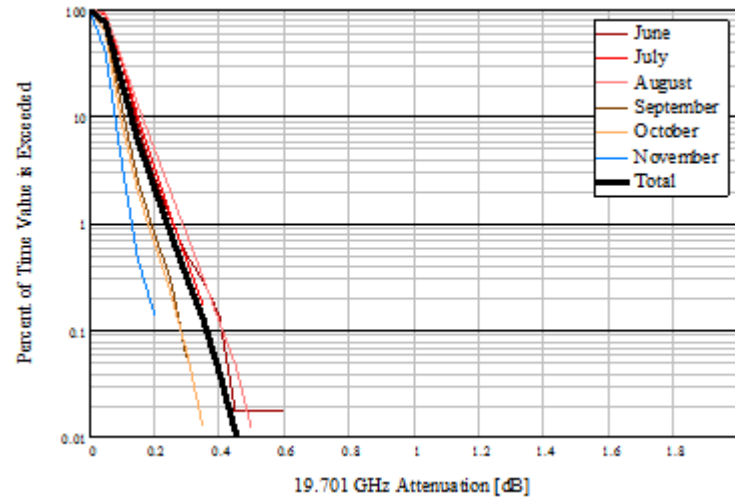

Alphasat - Milan Ka-B and Attenuation CDFs (2014)

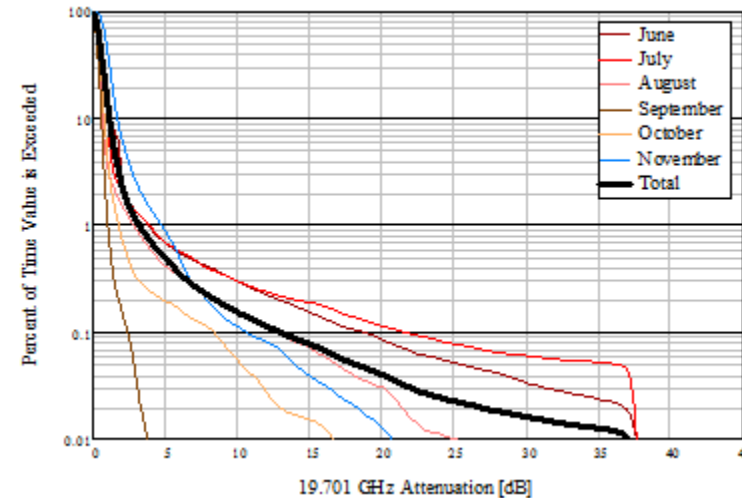

Alphasat - Milan Q-band Scintillation CDFs (2014)

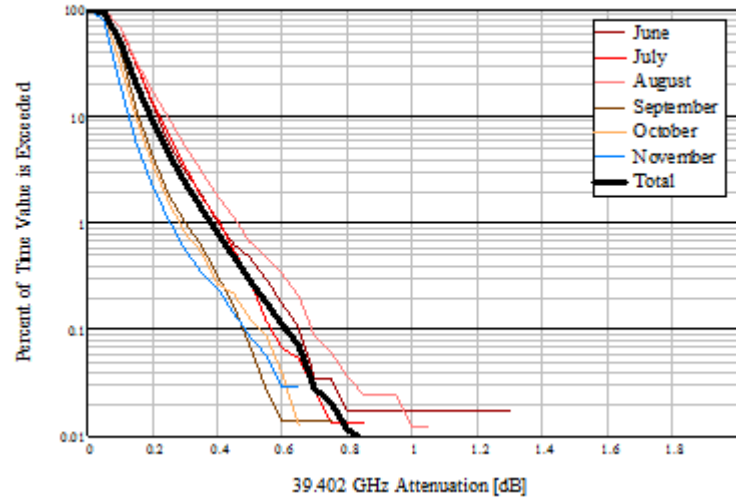

Alphasat - Milan Q-band Attenuation CDFs (2014)

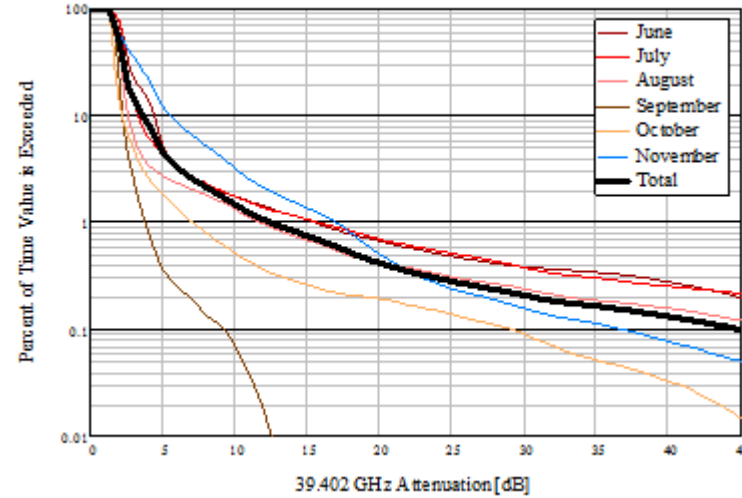

Total Results



Scintillation CDFs

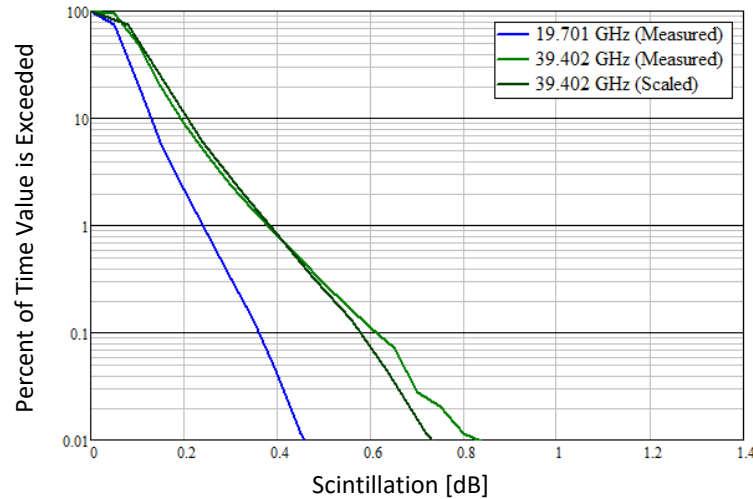

Attenuation CDFs

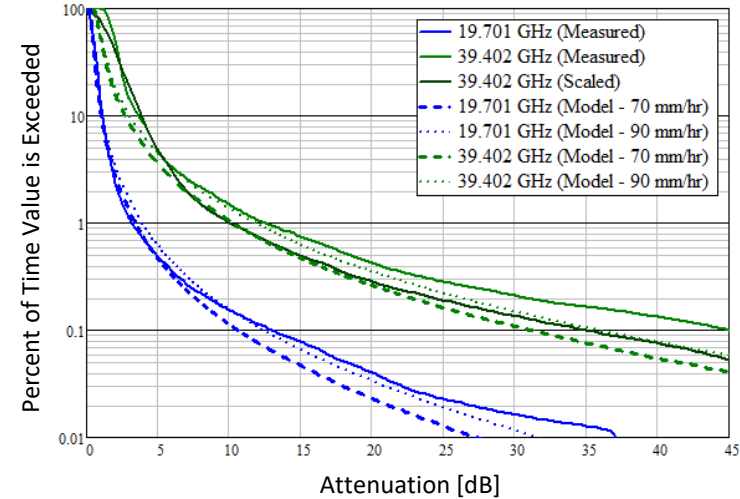

Measurements agree well with the ITU-R P.618-11 model (derived from the rain rate measurements), but start to diverge toward higher availabilities. This may be due to rain events present along the propagation path not detected by the rain sensors, as well as the incomplete year of data collection.

The frequency scaling ratio for scintillation observed in the data was 1.60 and is in close agreement with the expected value of 1.53 suggested by the model.

Rain Rate CDFs

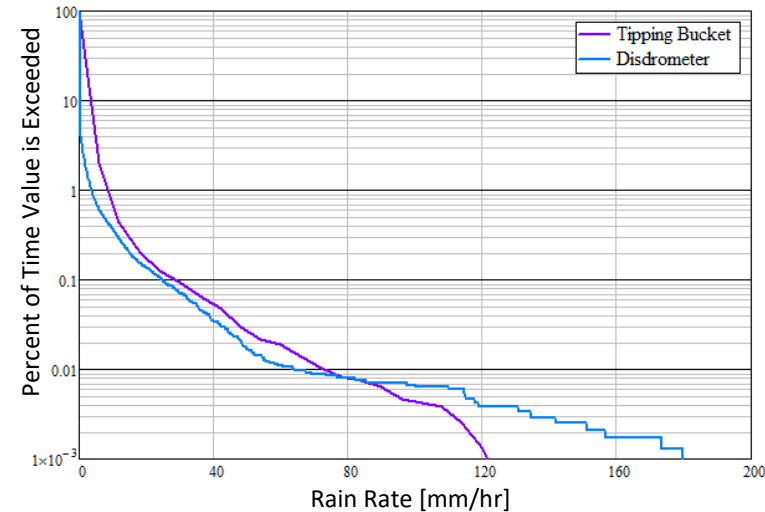

Link Budgets

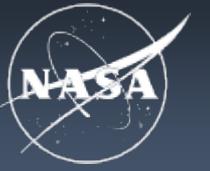

19.701 GHz Beacon

Parameter	User Inputs	Calculated	
Frequency of Operation	19.701 GHz		
Wavelength		0.015	m
Effective Isotropic Radiated Power (EIRP)		19.50	dBW
Propagation Channel Parameters			
Transmitter → Receiver Range	38600 km		
Gaseous Absorption Loss	0.5 dB		
Rain Attenuation	0.0 dB		
Pointing Loss	0.0 dB		
Polarization Loss	0.0 dB		
Free Space Loss		210.06	dB
Receive Antenna Parameters			
Antenna Diameter	1.2 m		
Illumination Taper Factor	70 deg		
Half Power Beamwidth		0.888	deg
Antenna Efficiency	60 %		
Antenna Gain		45.66	dB
<i>Noise Temperature Contributions:</i>			
Cosmic Background Noise Temperature	2.8 K		
Atmosphere Physical Temperature	290 K		
Antenna Noise Temperature (Clear Sky)		34.03	K
Antenna Noise Temperature (Rain)		34.03	K
Receiver Noise Temperature	600 K		
System Temperature		634.03	K
		28.02	dBK
Boltzmann's Constant		-228.60	dBW/K·Hz
Noise Spectral Density		-200.58	dB
Gain over Noise Temperature Ratio (G/T)		17.63	dB/K
Received Carrier Power (C)		-145.41	dBW
Carrier to Noise Density (C/N0)		55.17	dBHz

39.402 GHz Beacon

Parameter	User Inputs	Calculated	
Frequency of Operation	39.402 GHz		
Wavelength		0.008	m
Effective Isotropic Radiated Power (EIRP)		26.50	dBW
Propagation Channel Parameters			
Transmitter → Receiver Range	38600 km		
Gaseous Absorption Loss	0.5 dB		
Rain Attenuation	0.0 dB		
Pointing Loss	0.0 dB		
Polarization Loss	0.0 dB		
Free Space Loss		216.08	dB
Receive Antenna Parameters			
Antenna Diameter	0.6 m		
Illumination Taper Factor	70 deg		
Half Power Beamwidth		0.888	deg
Antenna Efficiency	60 %		
Antenna Gain		45.66	dB
<i>Noise Temperature Contributions:</i>			
Cosmic Background Noise Temperature	2.8 K		
Atmosphere Physical Temperature	290 K		
Antenna Noise Temperature (Clear Sky)		34.03	K
Antenna Noise Temperature (Rain)		34.03	K
Receiver Noise Temperature	800 K		
System Temperature		834.03	K
		29.21	dBK
Boltzmann's Constant		-228.60	dBW/K·Hz
Noise Spectral Density		-199.39	dB
Gain over Noise Temperature Ratio (G/T)		16.44	dB/K
Received Carrier Power (C)		-144.43	dBW
Carrier to Noise Density (C/N0)		54.96	dBHz

Measured Frequency

