

Orion European Structural Test Article Propellant Tank Fill and Drain Carts

Mark D. Cmar
HX5-Sierra LLC, NASA Plum Brook Station

Stanley P. Grisnik
NASA Plum Brook Station

ABSTRACT

Environmental testing of the Orion European Structural Test Article (E-STA), which contains the Orion European Service Module (ESM), required that the onboard propellant tanks be filled and drained with fuel and oxidizer simulant fluids as well as pressurized and depressurized with an ullage gas. This conference paper will elaborate on how these objectives were fulfilled by presenting the development of derived requirements definition, initial fill and drain concepts, selection of simulant fluids, finalization of pump and pressurization design, selection of components, and selection of transfer hoses and interface connections as well as development and maintenance of budgets, schedules, reviews, construction, documentation, and test procedures. This paper also describes the implementation of checkout and commissioning activities leading to successful fluid cart pumping and pressurization operations for the test campaign.

The development, construction, and operation of the fluid cart pumping and pressurization systems for the environmental testing of the Orion E-STA, took place at NASA's Plum Brook Station Space Environments Complex (SEC) during 2015 and 2016.

KEY WORDS: Ground support equipment, test equipment, fluid transfer, pressurization, fill, drain, propellant tanks

INTRODUCTION

Environmental testing of the Orion European Structural Test Article (E-STA), which contains the Orion European Service Module (ESM), required that the onboard propellant tanks be filled and drained with fuel and oxidizer simulant fluids as well as pressurized and depressurized with an ullage gas. This conference paper will elaborate on how these objectives were fulfilled by first discussing the requirements, rationale for the chosen fill and drain method, component selection, and design calculations. The discussion will then include the design review, system construction, and check out operations. Lastly, project budget, schedule, and scope changes will be presented.

ORION BACKGROUND

Orion Spacecraft [1], [2]

Orion will serve as the primary crew vehicle for missions in Low Earth Orbit (LEO) and Beyond Earth Orbit (BEO). The vehicle will be capable of conducting regular in-space operations in conjunction with payloads delivered by the Space Launch System (SLS) for all missions. The configurations described are designed to demonstrate the capability required to meet the Exploration Systems Development (ESD) requirements.

Orion consists of a Crew Module (CM), a Service Module (SM), a Spacecraft Adaptor (SA), and a Launch Abort System (LAS). The CM provides a habitable pressurized volume to support the crew during transport to LEO and BEO destinations and the return to Earth's surface. Potential Orion destinations include LEO points of interest, Near-Earth Objects, lunar orbit, Earth-Moon Lagrange points, and the International Space Station (ISS) (deferred capability). Orion provides all services necessary to support as many as four crew members for 21 days while onboard; however, actual mission crew complement and duration may vary based on mission design, according to vehicle capabilities. Orion will also support an architecture that, with the addition of habitation and lander elements, is capable of carrying a crew to an asteroid, the lunar surface, a Martian moon, and eventually the surface of Mars (refer to Figures 1 and 2).

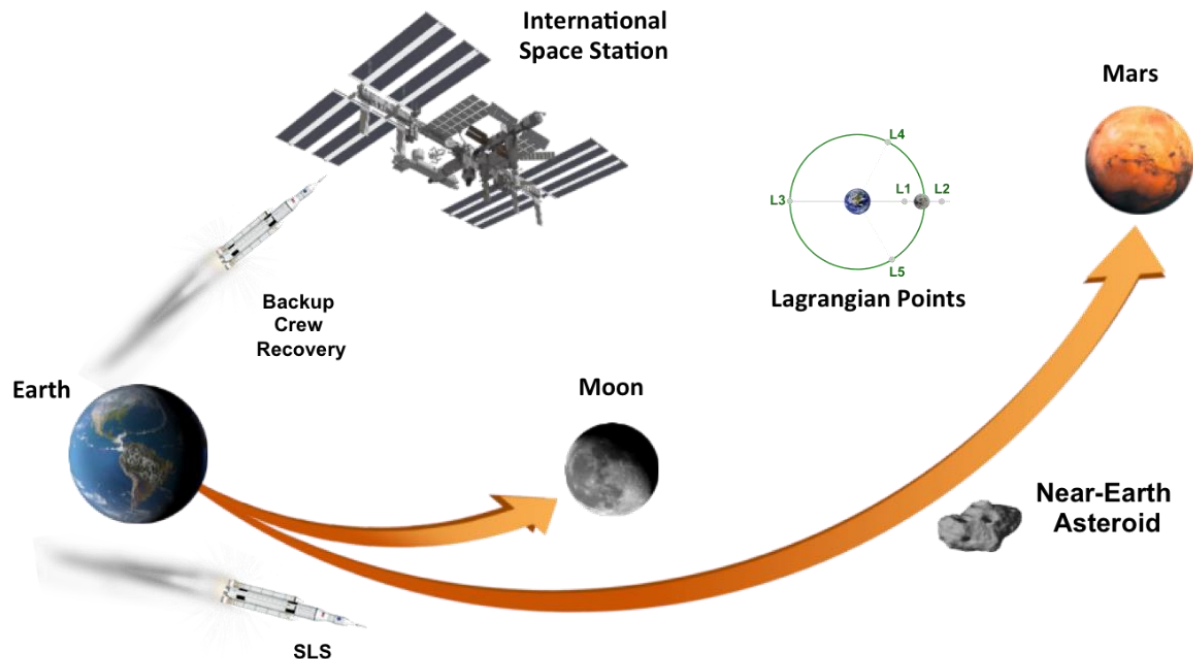

Figure 1: Orion exploration missions. SLS, Space Launch System.

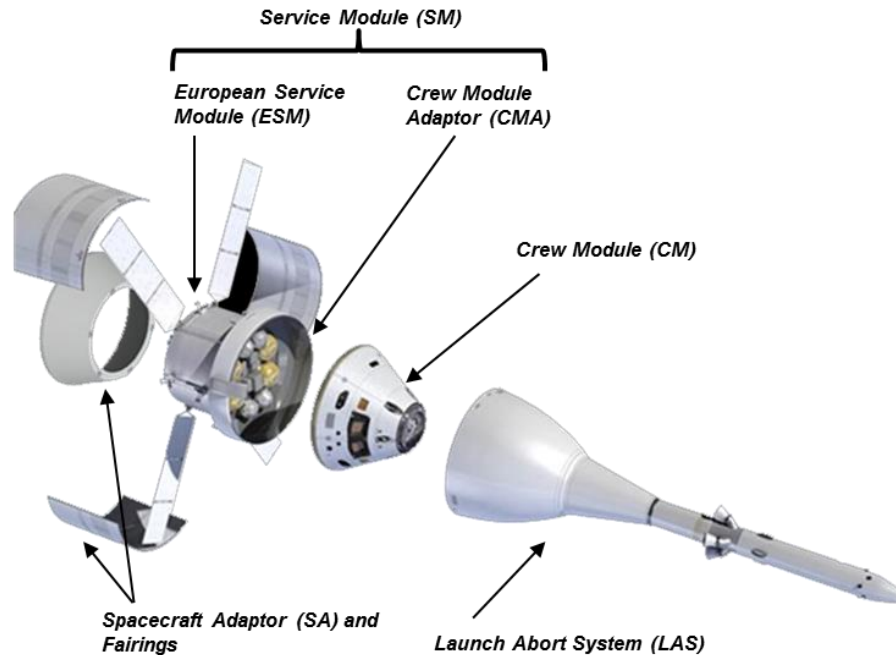

Figure 2: The Orion system.

TEST ARTICLE BACKGROUND

European Service Module (ESM) [3], [4]

The ESM is the European Space Agency's (ESA's) contribution to NASA's Orion spacecraft that will send astronauts to the Moon and beyond. It provides electricity, water, oxygen and nitrogen, temperature and humidity control, and keeps the spacecraft on course (refer to Figure 3).



Figure 3: Orion European Service Module (ESM) test article.

The cylindrical module is unpressurized and 4 m long, including the main engine and tanks for gas and propellant. During launch, the SA is fastened to the SM, which in turn is attached to the Crew Module Adaptor (CMA). Sitting on top of the CMA is the capsule, which houses the astronauts.

The main body of the SM is approximately 2 m high, but its main engine, the Orbital Maneuvering System Engine, extends into the SA. Likewise, some of the equipment in ESA's SM protrudes into the CMA.



Figure 4: Automated Transfer Vehicle 4 (ATV-4) docking.

During launch, the SM fits into a 5.2-m-diameter housing. Once Orion is above the atmosphere and the rocket fairing is jettisoned, the SM's solar array unfolds to span 19 m.

The spacecraft resembles ESA's Automated Transfer Vehicle (ATV), from which it evolved (refer to Figure 4). Five ATVs have delivered supplies to the ISS, helping to keep the outpost in orbit.

Three types of engines propel Orion to its destination with the capability to gimbal for aligning the spacecraft as needed.



Figure 5: European Service Module (ESM) test article.

Inside the SM, large tanks hold fuel as well consumables for the astronauts: oxygen, nitrogen, and water (refer to Figure 5).

Radiators and heat exchangers keep the astronauts and equipment at a comfortable temperature, while the module's structure is the backbone of the entire vehicle, similar to a car chassis.

The ESM is built by main contractor Airbus Defence and Space, with many companies all over Europe supplying components. The final product is assembled in Europe before being shipped to NASA in the United States of America.

TESTING COMPLETED ON ORION SERVICE MODULE (SM) [5]



Figure 6: Sensing Orion – ESM test article.

The module sits directly below Orion’s crew capsule and provides propulsion, power, thermal control, water, and air for four astronauts. The solar array spans 19 m and provides enough electricity to power the equivalent of two households (refer to Figure 7).

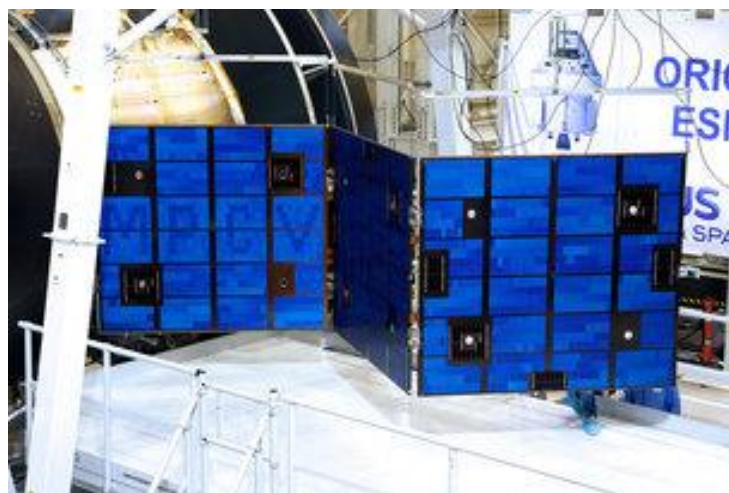

Figure 7: Orion’s wings.

This version was built in Turin, Italy, and shipped to the United States in November 2015 for a comprehensive series of tests at Plum Brook in Sandusky, Ohio. It is over 5 m in diameter and 4 m high, the SM weighs 13.5 tons.

Successful testing was completed on the test article. The testing involved reproducing the vibrations of a launch by utilizing the world's largest vibration table (refer to Figure 6) and subjecting it to the extreme sounds of a rocket ascent inside the world's most powerful acoustic chamber (refer to Figure 8).

The solar wings were also unfurled as they would be shortly after launch to make sure that the system worked as planned (refer to Figure 7).

When Orion is launched, it will be bolted to an SA that keeps it in place inside NASA's SLS rocket. A separation system will fire to break it away from the vehicle. This separation system was successfully tested at Plum Brook as well.



Figure 8: Orion Service Module (SM) test article acoustic test.

The module has passed its rigorous testing and will be used by NASA in conjunction with the Orion CM STA for further testing at the vehicle level.

More than 20 companies around Europe are working on the project, most building on their expertise earned from the five ATVs that delivered cargo to the ISS and boosted its orbit from 2009 to 2015.

FACILITY BACKGROUND

Space Environments Complex (SEC) [6]

Space Simulation Vacuum Chamber



Figure 9: Space Environments Complex (SEC) aerial view.

The vacuum chamber was designed and constructed to test both nuclear and nonnuclear space hardware in a simulated LEO environment. Although the facility (refer to Figure 9) was designed for testing nuclear hardware, only nonnuclear tests have been performed throughout its history. Some of the test programs that have been performed at the facility include high-energy

experiments, full-scale rocket-fairing separation tests, Mars Lander system tests, deployable solar sail tests, and ISS hardware tests.

The chamber can sustain a high vacuum (10^{-6} torr) and provide an optically tight, high-emissive, thermal background environment of -160 to 60 °C (-250 to 140 °F) within the 12-m- (40-ft-) diameter by 12-m- (40-ft-) high variable-geometry cryogenic shroud. The facility can also provide power systems and thermal controllers for customer-provided thermal heaters or solar simulators.

The vacuum chamber has a volume of $22,653$ m³ ($800,000$ ft³) and measures 30.5 m (100 ft) in diameter and 37.2 m (122 ft) high with 15.24 -m (50 -ft) by 15.24 -m (50 -ft) loading doors on each side, leading to high bays. The chamber features all-aluminum construction, including a removable polar crane with an 18.1 t (20 ton) critical lift trolley and a 9.1 t (10 ton) auxiliary hook, and a removable, reconfigurable, cryoshroud system. The chamber cryoshroud system can provide both warm and cold thermal background environment, data acquisition, and test monitoring capabilities.

The vacuum chamber is surrounded by an equal-volume concrete enclosure, which is typically reduced in pressure to 20 torr during chamber operations. The vacuum chamber incorporates several electrical and instrumentation penetrations and several blank penetrations at various locations around the chamber perimeter. Removable rail tracks inside the chamber can be used in conjunction with rail dollies or the cryoshroud floor(s) to transport hardware or test articles through the facility and chamber. The facility provides a visually clean environment. The chamber provides an empty-chamber vacuum capability of 2×10^{-6} torr using a combination of roughing pumps and high-vacuum equipment. The roughing system consists of two identical 5-stage, parallel trains of rotary-lobe blowers and rotary-piston mechanical pumps, which evacuate the chamber and annulus simultaneously to 20 torr and subsequently the chamber only to 30 mtorr. High-vacuum is achieved using 5 turbomolecular pumps and 10 cryogenic pumps. The chamber can reach a vacuum level of 2×10^{-6} torr in less than 8 hr.

The facility uses a removable, reconfigurable cryoshroud for background heating and cooling. The cryoshroud is warmed and cooled using a recirculating gaseous nitrogen (GN₂) system. The system utilizes compressor heat-of-compression to provide up to 60 °C (140 °F) wall temperatures and a heat exchanger/liquid-nitrogen (LN₂) desuperheater to provide temperatures down to -160 °C (-250 °F). The facility has a cryoshroud of 12-m- (40-ft-) diameter by 12-m- (40-ft-) high cylinder centered in the test chamber. The chamber provides in-chamber “low-power” connections and closed-loop controls for up to 33 channels of $1,200$ W heater power and additional “high-power” connections with closed-loop controls for up to 10 channels of $50,000$ W heater power.

Data are acquired at the vacuum chamber via the Mobile Data Acquisition System (MDAS), a 256-channel high-speed digital system.

Reverberant Acoustic Test Facility (RATF)

The RATF chamber is located within the Vibroacoustic High Bay (refer to Figure 10), taking advantage of the 1.8-m- (6-ft-) thick surrounding concrete walls to help attenuate sound migration through the SEC. The high bay also serves as redundant protection from the RATF nitrogen atmosphere during operation. The RATF is a 2,860-m³ (101,189-ft³) reverberant acoustic chamber capable of achieving an empty-chamber acoustic overall sound pressure level (OASPL) of 163 dB. The facility structure is designed for a future upgrade to 166-dB OASPL, including areas in the horn room wall which have blank panels for future installation of additional modulators and horns. The RATF includes various supporting subsystems, including a GN₂ generation system, horn room with acoustic modulators and horns, acoustic control system (ACS), and hydraulic supply system. Test articles are mounted onto elevated, customer-provided mounting fixtures for testing. The chamber has access to a 30-ton bridge crane to accurately position test article within the RATF. The chamber can meet the requirements of a Class 300,000 clean room once the access doors are closed. The combinations of servohydraulic and electropneumatic noise modulators utilize GN₂ capable of producing a tailored wide range of acoustic spectra in the frequency range from 31.5 Hz to 10 kHz, One Third Octave Bands. The RATF chamber internal dimensions are 11.4 m wide by 14.5 m deep by 17.4 m high (37.5 by 47.5 by 57 ft).



Figure 10: Reverberant Acoustic Test Facility (RATF) horn wall is shown at left, and the overall chamber is shown at right.

A maximum of 19 control microphones can be placed around the test article for closed-loop control using the ACS. The control microphones or other response instrumentation (accelerometers, microphones) may be input into the analog abort system (AAS) to provide automatic shutdown capability. Each of 23 servohydraulic acoustic modulators is coupled with individual horns of six different cutoff frequencies. Each of 13 electropneumatic acoustic modulators is coupled with individual horns of one cutoff frequency. This combination of modulators and horns provides for an extremely variable and tailored acoustic spectrum. Threaded inserts are located in the floor for attachment of test article mounting fixtures.

The east side of the chamber has a large rolling door and hinged door to provide access to the chamber up to 10.5 m (34.5 ft) in width. A 5.5-m-wide by 4.2-m-high (18- by 14-ft) door is located on the west side of the chamber for loading equipment when the vacuum chamber is occupied.

The Vibroacoustic High Bay is secured, and support systems (hydraulics, compressed air, LN₂, GN₂, HVAC (heating, ventilation and air conditioning), and video) are set up and energized. A watchdog facility control system (FCS) monitors these subsystems and ensures that all permissives and interlocks are verified. The acoustic chamber is filled to a predetermined level with GN₂. The FCS verifies that a matching modulator selection file agrees with the ACS and subsequently provides a run permit to the ACS. The ACS performs a self-check, and the operator initiates testing using the tailored choice of modulators and horns. The nitrogen generation system automatically vaporizes LN₂, converting it into GN₂ as required, at up to 1,981 standard cubic meters per minute (70,000 scfm). At the conclusion of testing, fresh air is force ventilated into the chamber via the HVAC system to purge the chamber of nitrogen for safe entry. Temperature, humidity, and oxygen monitors are located in the chamber and high bay.

Data is acquired at the RATF via the facility data acquisition system (FDAS), a 1,024-channel high-speed digital system.

Mechanical Vibration Facility (MVF)

The MVF is a three-axis, 6-degree-of-freedom, servohydraulic, sinusoidal base-shake vibration system located within the same Vibroacoustic High Bay as the RATF on the west side of the vacuum chamber (refer to Figure 11). The proximity to the RATF allows shared use of the hydraulic system, safety systems, high-speed data acquisition system, and surveillance system. The MVF system consists of reaction mass, 4 horizontal servohydraulic actuators, 16 vertical servohydraulic actuators mounted on double-spherical couplings, an aluminum table, a hydraulic supply system, table control system (TCON), vibration control system (VCON), and the same FCS used by the RATF.

The MVF reaction mass includes an embedded steel plate for modal testing. The 2,100,000-kg (4,650,000-lb) reaction mass is used to resist the vibratory energy from the hydraulic actuators, table, and test article, transferring the energy into the shale bedrock foundation. The reaction mass

has been sized such that it has sufficient inertia mass and stiffness to react against the forces applied by the actuators and couplings during sine vibration testing. The reaction mass has been designed to accommodate future growth in vibration system and test article mass. The existing actuator and table design is for sine sweep capability of 0 to 1.25g (peak), from 5 to 150 Hz in the vertical axis and 0 to 1.0g from 5 to 150 Hz in each of the horizontal axes for a test article mass of 34,000 kg (75,000 lb) with a center of gravity elevation of 7 m (23 ft). Currently, the MVF controller is capable of sinusoidal control in three independent axes.

The MVF system design uses a large aluminum table approximately 6.7 m (22 ft) in diameter with a 0.61-m- (2-ft-) wide annular mounting surface centered about a 5.5-m (18-ft) nominal diameter. Table weight is partially offloaded from the system via four inflatable airbags.

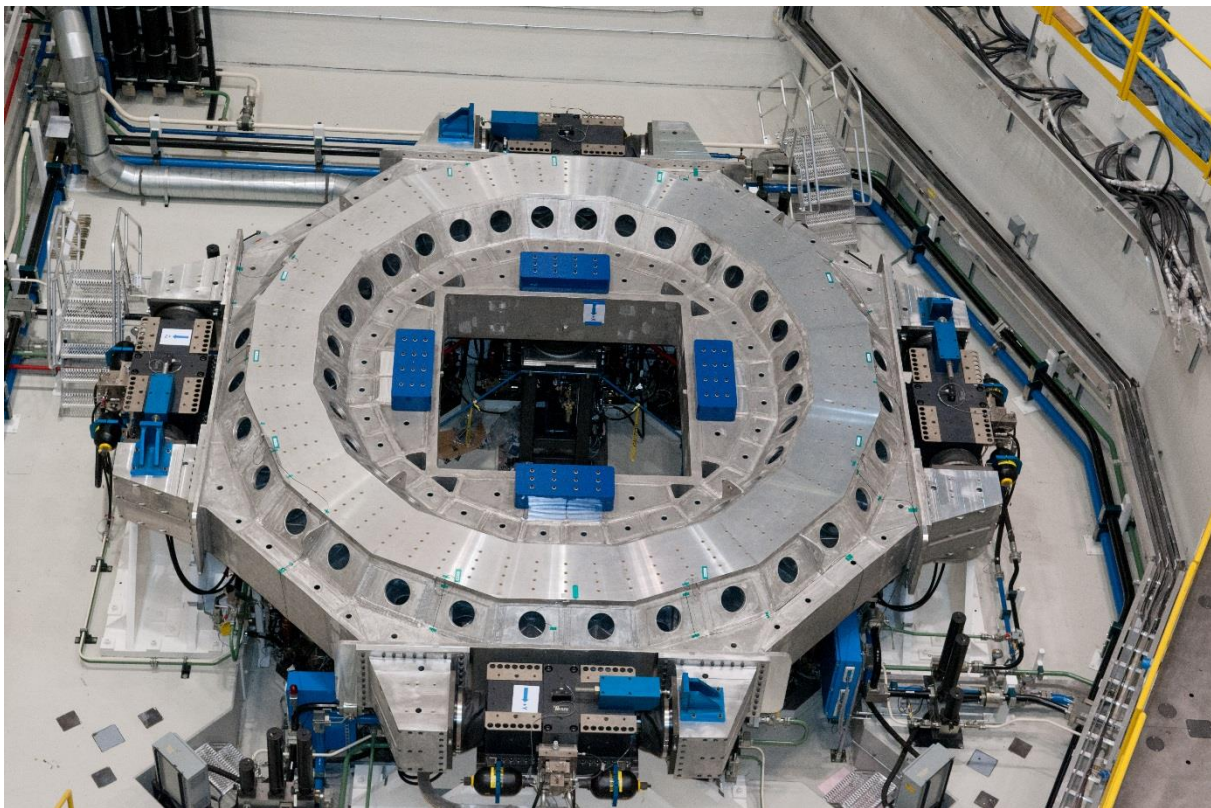

Figure 11: Overhead view of the Mechanical Vibration Facility (MVF) system.

The table vertical actuation is provided by 16 hydraulic cylinder actuators attached to the reaction mass onto which 16 double-spherical couplings are attached. The vertical actuator assemblies provide the controlled vertical sine vibration, enable horizontal vibration, and provide overturning constraints during horizontal vibration. The table rests on the double-spherical couplings. The double-spherical couplings couple each vertical actuator to the table and provide high-axial stiffness to deliver the vertical vibratory force during vertical excitation. Each double-spherical coupling has internal pressure sensors to enable the vibration controller to limit forces. Four horizontal actuators provide the controlled horizontal sine vibration and comprise two single-

ended pistons, which maintain outward force through hydrostatic pad-bearings to the table. The horizontal actuator assemblies provide vertical alignment during vertical actuation. The system is designed to permit testing in three independent axes without removing or lifting the test article from the table.

A customer-supplied adapter ring is necessary to attach the test article to the vibration table mounting holes. The Vibroacoustic High Bay is secured, the support systems (hydraulics, compressed air, life safety, video, and table mode) are setup and energized and interlocks are verified (including vibratory mode-choice setup) using the FCS. The TCON and FCS communicate with the table actuator servovalve drivers; position the table to a lifted, centered, and ready position; and verify all servodrivers are started and ready. Operators then initiate the VCON to generate the sine wave inputs to the servovalve controllers, establishing vibration. The VCON controller generates drive voltage waveforms for each servovalve driver to satisfy the control and limit channel constraints from the test article (outer-loop control), and each servovalve driver maintains a closed-loop control to each actuator (inner-loop control). The VCON has 64 analog input channels, which can be assigned to control channels, limit channels, or response channels, where the control and limit channels can be set to alarm and/or abort a test. Up to 31 of the 64 analog input channels can be available for test article limit channels. Data are acquired at the MVF via the FDAS, a 1,024-channel high-speed digital system.

EUROPEAN STRUCTURAL TEST ARTICLE (E-STA) TEST DERIVED REQUIREMENTS

Overall Requirement

Pressurize, fill, and drain propellant tanks with simulant fluids for vibroacoustic testing.

A. Pressurization of Oxidizer and Fuel Tanks

In order to meet the pressurization of the oxidizer and fuel tanks, the team needed to consider the safety, contamination, and operational aspects of this equipment. The following subsections describe the considerations to meet these requirements.

(1) Safety requirements

Pressurizing of the oxidizer and fuel tanks needs to take in consideration the design of the propellant tanks in terms of allowable working pressures, proof pressures, and type of compatible pressurant gases.

- (a) System pressure not to exceed maximum allowable working pressure (MAWP) of the oxidizer and fuel tanks
- (b) Relief valve and regulators placed within pressurization system
- (c) Components rated for design pressures
 - (i) Bottle supply

- (ii) Regulators
- (iii) Filters
- (iv) Valves
- (v) Relief valves
- (vi) Tubing and fittings

(2) Contamination requirements

Pressurant gas does not contaminate the vessel or fluids to the greatest extent possible in terms of:

- (a) Interaction with vessel material
- (b) Does not leave a residual when emptied
- (c) Saturation into simulant fluids
- (d) Verification of purity

(3) Operational requirements

The pressurization system needs to be portable. The gases can be readily procurable per MIL-PRF-27401 Grade C—MPCV 70156 [7]. The gas supplies need to be adequate to fill two oxidizer and two fuel tanks to operational pressures without fluids. The pressurization system is required to interface with the top of the test tanks. The pressurization system must have the proper adapters and fittings available to interface with the propellant tanks.

B. Fill and Drain of Oxidizer Tanks

To fill and drain the oxidizer tanks, the team needed to consider the safety, contamination, and operational aspects of this equipment. The following subsections describe the considerations to meet these requirements.

(1) Safety requirements

Determine and meet equipment and personnel safety requirements when handling and pumping oxidizer simulant fluid.

- (a) Fluid system pressures not to exceed MAWP of the test article
- (b) Isolation, fill, drain, vent, and relief valves as required and variable speed pump placed within fluid system
- (c) Components rated for design pressures
 - (i) Fluid tote storage
 - (ii) Regulators
 - (iii) Filters
 - (iv) Valves
 - (v) Relief valves
 - (vi) Tubing and fittings

- (d) Personnel protection from hazardous fluids and vapors.
 - (i) Vapors vented away from personnel work areas
 - (ii) System is leak tight
 - (iii) System design such that it can be emptied and purged for maintenance or repair

(2) Contamination requirements

Oxidizer simulant fluid does not contaminate the vessel to the greatest extent possible in terms of:

- (a) Interaction with vessel material
- (b) Simulant fluid does not leave a residual when emptied
- (c) Saturation with pressurant gas
- (d) Verification of purity

The fluid system cleanliness verification was performed prior to use.

(3) Operational requirements

The team also took into consideration the following criteria when filling and draining the oxidizer simulant fluid to and from the oxidizer tanks.

- (a) Portable to various areas of the facility
- (b) HFE—A-A-59150 – MPCV 70156 [7]
- (c) Enough fluid simulant supply to fill two oxidizer tanks
- (d) Recover and reuse fluid from tanks
- (e) Able to fill and drain tanks from bottom fill lines
- (f) Measure amount of fluid filled into or drained from each oxidizer tank—weight and volume measurements
- (g) Storage tote containers
- (h) Transfer fluid from manufacturer’s containers to storage tote containers
- (i) Fluid pump type, capacity, and flow rates
- (j) Electrical power supply

C. Fill and Drain of Fuel Tanks

To fill and drain the fuel tanks, the team needed to consider the safety, contamination, and operational aspects of this equipment. The following subsections describe the considerations to meet these requirements.

(1) Safety requirements:

The fuel tanks needed to meet the same oxidizer safety requirements as listed above with the exception of the personal protective equipment (PPE) requirements since the fluid is deionized (DI) water.

(2) Contamination requirements:

The fuel simulant needed to meet the same oxidizer contamination requirements as listed above.

(3) Operational requirements:

The fuel simulant needed to meet the same oxidizer operational requirements as listed above by replacing the oxidizer simulant fluid with DI water per ASTM D1193 Standard Specification for Reagent Water MPCV 70156 [7].

INITIAL FILL AND DRAIN CONCEPTS

Many fill and drain scenarios were discussed based on the types of simulant fluids as well as propellant tank design and test article placement within the test facility. Refer to Figure 12 of the basic propellant tank configuration where fill and drain concepts were considered as listed below.

- A. Lift fluid storage tanks above the test article with crane and fill propellant tanks via gravity feed
- B. Place empty storage tanks below test article to drain
- C. Use pumps to fill and drain tanks
- D. Pressurize tanks from top of tank
- E. Top fills—pump type selection
- F. Bottom fill—pump type selection

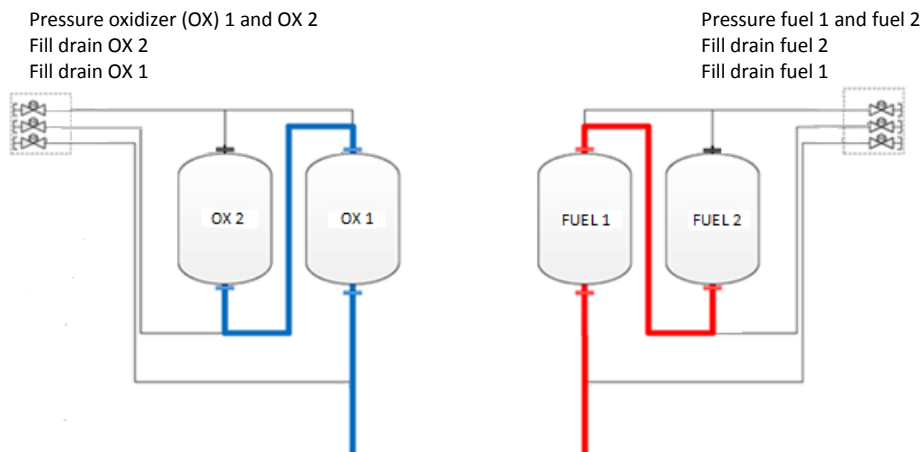

Figure 12: Basic propellant tank configuration [4].

SELECTION OF SIMULANT FLUIDS

Due to the toxicity, flammability, and other hazards associated with the actual fuel and oxidizer, simulated fluids were required to be selected for environmental testing. The simulant fluids would have to mimic the rough densities of the oxidizer and fuel where the oxidizer specific gravity is about 1.4 and the fuel specific gravity is about 1.0.

With these criteria in mind, this led an open and “out of the box” discussion of what type of simulant fluids would be selected. Some criteria that went into the selection ranged from flow

characteristics, density, viscosity, pumping and draining schemes, reuse ability, condition of tanks after exposure to the fluid, contamination potential, reactivity, flammability, and toxicity to name a few.

Oxidizer simulant thoughts ranged from honey, lead shot, alcohol based fluids, glycerin, 3M™ Novec™ 7100 Engineered Fluid (HFE-7100), and Type II DI water. Fuel simulant thoughts ranged from bean bag shot, alcohol based fluids, and DI water. In terms of the oxidizer, Novec™ HFE-7100 [8] was chosen due to its density, non-flammability, viscosity, and non-toxic characteristics. With respect to the fuel simulant, DI water [9] was chosen due to its density, non-flammability, viscosity, and non-toxic characteristics as well.

PUMP FILL, DRAIN, PRESSURIZATION, FLUID STORAGE, AND MEASUREMENT SYSTEMS DESIGN

A. Fill and Drain Pressure Drop Flow Rate Calculations

Upon completion of the fluid system design, the physical location of the system with respect to the ESM during filling and draining operations was determined. Locating the equipment involves several considerations, the first being safety. Inhalation of fluid vapor, flammability issues, spill prevention and containment, and trip hazards are some of the concerns that must be addressed. The second consideration is operation and repair of the system. All of the components must be easily serviceable in the event of a component failure and the system must be capable of being completely drained of fluid before repairs are undertaken. The manually operated components must be easily reachable to allow for safe operation of the system. A pipe route from the fluid reservoirs to the vessels being filled or drained is planned. Pipe components such as elbows, and so forth are determined. Once the above items are addressed, the system can be sized to supply the required fluid flow rate.

A pump-fed system was determined to be the best method of filling and draining the simulant fluids. The constraints on the system are the size of the inlet piping to the vessels, the required fill and drain time for the vessels, and the height to which the liquid must be pumped. Proper design of the system piping is critical for a pump-fed system to operate as required. The required pump discharge pressure and flow rate must be determined for pump selection. The possibility of cavitation at the pump suction must be eliminated by proper choice and routing of suction piping based on the chosen pump. Flashing of the fluid due to rapid pressure changes in the system must be prevented. Accurate pressure drop calculations are necessary to ensure that the system will operate correctly.

A software package based on the Crane Technical Paper No. 410 [10], Flow of Fluids through valves, fittings and pipe, was used to perform the design calculations. Included with the software were data libraries of various fluid and pipe component properties. Custom fluids or components can be added as required. The properties of water are in the software library, but

HFE-7100 fluid is not. The density, viscosity, and saturation pressure versus temperature of HFE-7100 is required to be input into the software library. With the fluid data input into the software, the piping components can be entered. Pipe sizes can be easily changed in the software and a new pressure drop will be calculated. The software does not inform the programmer if the fluid will change state; that is left up to the programmer.

B. Gaseous Nitrogen (GN₂) Pressurization Panel

The ullage volume of the fuel and oxidizer vessels must be pressurized with GN₂ before testing of the E-STA and ESM. The ullage volume is dependent upon the quantity of fluid added to the vessels. The time required to reach the final pressure determines to a large extent the necessary flow rate of GN₂. The solubility of HFE-7100 with nitrogen will affect the rate of pressurization of the vessels. As GN₂ is being added to the ullage, it will also begin to saturate the HFE-7100. Depending upon the vapor-liquid equilibrium point, the ullage pressure may be affected. If the rate is slow after reaching the desired ullage pressure with a subsequent termination of the GN₂ flow, the pressure will decay as the vapor-liquid equilibrium is reestablished. It may require several pressurization steps to reach the desired ullage pressure. If a pressure-regulated system is used as opposed to a flow-regulated system, the risk of overshooting the desired pressure can be avoided. The regulator can be sized based on the approximate time desired to pressurize the ullage. A simple flow rate versus pressure drop calculation will determine the appropriate pipe size for the pressurization system. Venting the ullage must be directed outside the occupied area as it may be saturated with the vessel fluid vapor.

C. Oxidizer Tank Pump and Cart and Components

Considering the safety, contamination and operational constraints previously listed for the oxidizer fill and drain system, the following applies:

- (1) Portable—roll around cart
- (2) Able to pump fuel simulant fluid
 - (a) Impeller design and pump curves—centrifugal pump selected with low viscosity fluid Novec[™] HFE-7100
 - (b) Supply sufficient head Pressure to fill tanks—capable of exceeding required lift height
 - (c) Pump parts compatible with simulant fluids—wetted parts must withstand exposure to Novec[™] HFE-7100.
- (3) Simulant fluid transfer hoses do not degrade and contaminate when exposed to fluid—fluid does not extract chemicals from hoses
- (4) Electrical power supply conforms to available facility power of 208/120 VAC 3-phase
- (5) Capability to fill and drain with accurate measurement of quantities transferred—wetted parts must withstand exposure to Novec[™] HFE-7100

D. Fuel Pump and Cart and Components

In like manner, the fuel pump and cart and components criteria follow the oxidizer pump and cart and components applied to the fuel pump and cart and components, with tailoring them for DI water instead of Novec™ HFE-7100.

E. Oxidizer Simulant Fluid Storage

Handling and use of bulk oxidizer simulant fluid required the following:

- (1) Portable via forklift
- (2) Materials compatible with simulant fluid—passivated 304 stainless steel for Novec™ HFE-7100 (3M™)
- (3) Storage vessel structure capable of holding fluid weigh—350 gal capacity
- (4) Supply and vent hose connections—2 in. National Pipe Tapered threads (NPT) using 1 in. supply Tygon® (Saint Gobain) tubing and ½-in. nylon tubing
- (5) Commercial drums (55-gal drums) with container transfer pump to transfer Novec™ HFE-7100
- (6) Fluid transfer procedures
- (7) Fluid transfer area for 55-gal drums to 350-gal totes

F. Fuel Simulant Fluid Storage

Handling and use of bulk fuel simulant fluid required the following:

- (1) Portable via forklift
- (2) Materials compatible with simulant fluid—high-density polyethylene (HDPE) for DI water
- (3) Storage vessel structure capable of holding fluid weight—275-gal tote
- (4) Supply and vent hose connections—2 in. NPT using 1 in. supply linear low-density polyethylene (LLDPE) High Purity hose and ½-in. nylon hoses

G. Weight Scales for Fluid Measurement

Weight scales for simulant fluid weight readings had to meet the following criteria:

- (1) Portable for use on level floor
- (2) Calibration—five point calibration
- (3) Handle combined tote and fluid weights with the required minimum accuracy ± 5 lb or better (± 2 lb achieved)
- (4) Capable of 10,000-lb overall weight measurement

H. Flowmeter for Fluid Volume Measurement

The flowmeter for fuel or oxidizer simulant fluid volume measurement had to meet the following criteria:

- (1) Proper size for anticipated flow rates
- (2) Required accuracy of 1%
- (3) Materials compatible with simulant fluid

SELECTION OF COMPONENTS—VALVES, PUMPS, CARTS, AND ELECTRICAL

Component selection required considerable searching and review based on the following criteria.

- A. Commercial off-the-shelf (COTS) components—readily available
- B. Material compatible with simulant fluids—safety, contamination, and operation
- C. Pressure rating—rated for 100 psig or greater for safety
- D. Weight capacity rating—operation
- E. Pumping capacity and flow rates—operation

Refer to Figures 13 and 14 for typical pump curves for the chosen simulant fluids pumps.

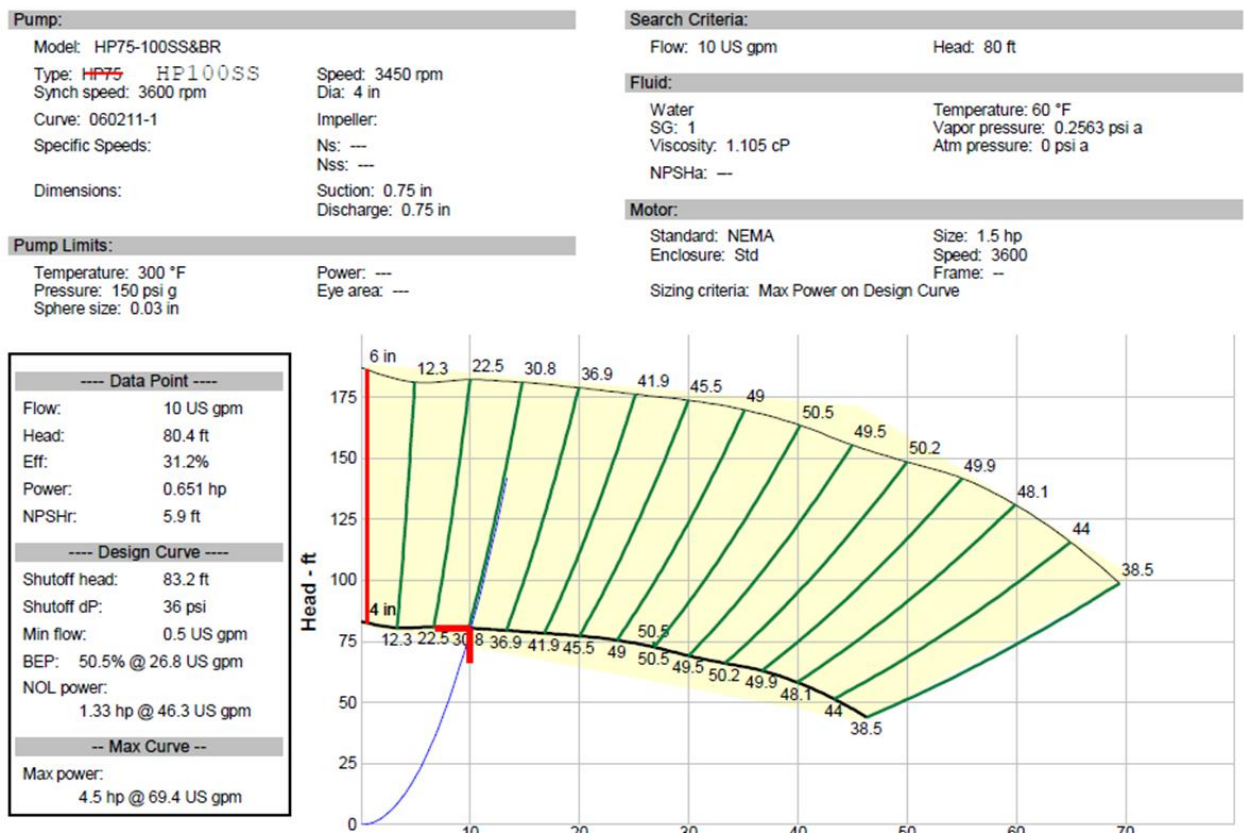

Figure 13: Deionized (DI) water pump curve [11].

Pump:
 Model: HP100MDSS
 Type: HP-MD
 Synch speed: 3800 rpm
 Curve: 080809-1
 Specific Speeds:
 Dimensions:
 Speed: 3450 rpm
 Dia: 5.125 in
 Impeller:
 Ns: ---
 Nss: ---
 Suction: 1 in
 Discharge: 1 in

Search Criteria:
 Flow: 8 US gpm
 Head: 108.1 ft

Fluid:
 HFE 7100
 SG: 1.5
 Viscosity: 0.38 cP
 NPSHa: ---
 Temperature: 70 °F
 Vapor pressure: 14.7 psi a
 Atm pressure: 0 psi a

Pump Limits:
 Temperature: 350 °F
 Pressure: 300 psi g
 Sphere size: 0.15 in
 Power: ---
 Eye area: ---

Motor:
 Standard: NEMA
 Enclosure: Std
 Sizing criteria: Max Power on Design Curve
 Size: 5 hp
 Speed: 3800
 Frame: --

---- Data Point ----	
Flow:	8 US gpm
Head:	109 ft
Eff:	11.2%
Power:	2.94 hp
NPSHr:	4.52 ft
---- Design Curve ----	
Shutoff head:	114 ft
Shutoff dP:	73.8 psi
Min flow:	0.5 US gpm
BEP:	32.3% @ 36.6 US gpm
NOL power:	4.63 hp @ 53.1 US gpm
-- Max Curve --	
Max power:	6.86 hp @ 65 US gpm

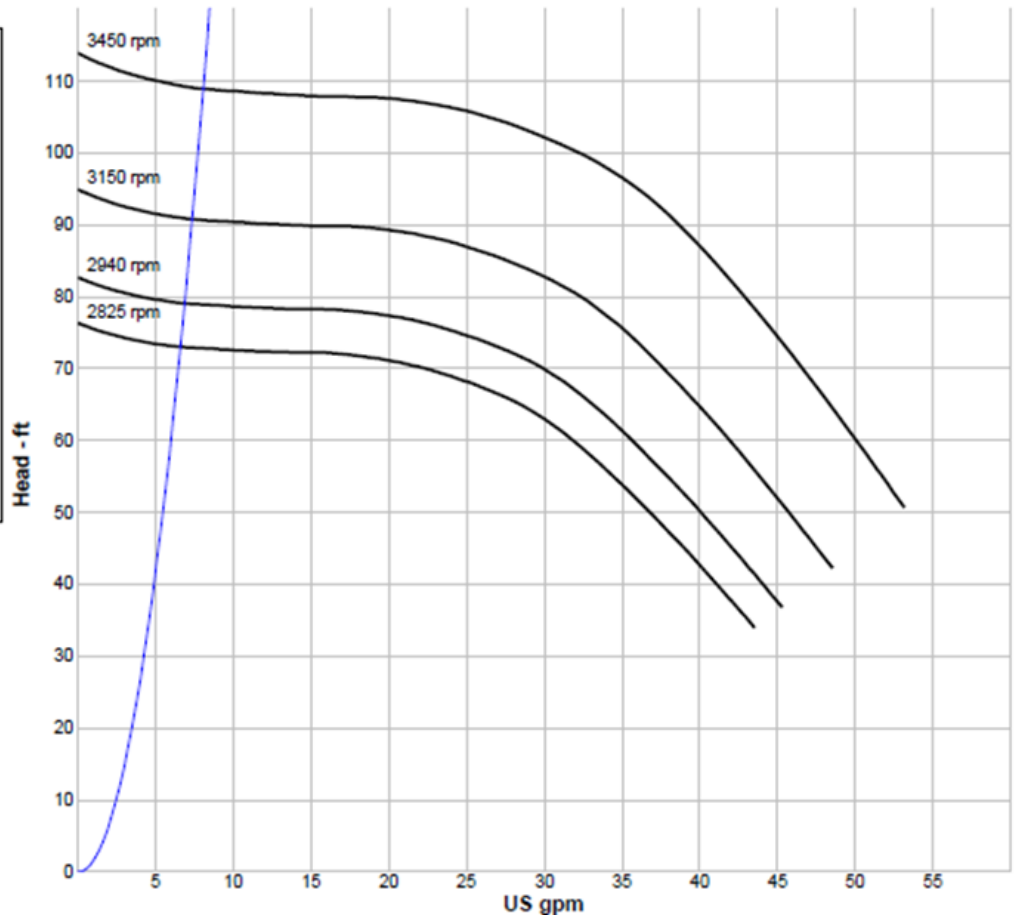

Figure 14: Novec™ HFE-7100 pump curve [11].

SELECTION OF TRANSFER HOSES, INTERFACE CONNECTORS, AND OTHER COMPONENTS

Component selection required considerable searching and review based on the following criteria.

- A. COTS components—readily available
- B. Material compatible with simulant fluids—safety, contamination, operation-LLDPE high purity, and Tygon®
- C. Pressure ratings—rated for 100 psig or greater for safety

- D. Pressure drop—keep pressure drops to a minimum to compensate for the pressure drop across the inlet valves. 1-in. hose provides minimal pressure drops during operation
- E. Quick disconnects—operation

BUDGETS, SCHEDULES, AND CHANGE OF SCOPE

The time and materials estimate considered skill labor mix and available resources.

- A. Initial DI water and HFE estimates and budget
 - (a) Cost fluid simulants—DI water and Novec™ HFE-7100 and quantities
 - (b) Skills and labor time estimates
 - (c) Reviews, documentation, and other procurements
 - (d) Assembly and checkout
- B. Schedule—refer to Table 1 and Table 2

Table 1: Deionized (DI) water and gaseous nitrogen (GN₂) pressurization fluid carts schedule.

Task	Start	Finish	Comment
Design revisions and reviews	01/06/15	02/06/15	-Initial piping & instrumentation diagram (P&ID) Design
		03/17/15	-Internal Design Review
		04/07/15	-Added recommendations
		06/27/15	-Added panel views
		08/15/15	-Improved DI water P&ID based on HFE initial design
	08/24/15	9/11/15	-Amend DI water P&ID after HFE Internal Design Review Recommendations
Initial documentation	8/24/15	10/16/15	-P&ID, bill of materials (BOM) and other drawings
Equipment procurement	7/16/15	9/11/15	
DI water (including spec) and GN ₂ procurement process	10/19/15	12/11/15	
DI water fill and drain and GN ₂ pressurization assembly	12/1/15	1/29/16	
Operations procedure and final documentation	1/4/16	1/29/16	
Simulated DI water and GN ₂ fill and drain, checkouts and training	2/1/16	2/26/16	

Table 2: Novec™ HFE-7100 fluid cart schedule.

Task	Start	Finish	Comment
Initial design	8/10/15	11/13/15	Preliminary Initial Design complete: 8/15/15 Initial Design Update: to be determined (TBD) based on internal review recommendations
Reviews and design revisions	8/24/15	11/13/15	- Internal Review scheduled for 8/24/15 - ERB: TBD
Initial documentation	8/24/15	11/13/15	Initial documentation for ERB
HFE-7100 fluid procurement process (including spec ~1,000 gal)	7/15/15	9/8/15	Received twenty-two 600-lb Novec™ HFE-7100 drums on 8/14/15. Drums stored in Building 9206. Currently processing procurement paperwork including final costing and performing chemical inventory update.
Equipment procurement	10/19/15	12/11/15	
HFE-7100 300-gal tote procurement	10/19/15	12/11/15	
HFE-7100 fill and drain cart assembly	12/1/15	1/29/16	
Transfer and operations procedures and final documentation	1/4/16	2/26/16	
HFE-7100 drum to tote transfer	2/1/16	2/26/16	Lewis Field Building 215 is preferred location, Plum Brook Building 9206 is alternate
Simulated fill and drain and checkouts and training	2/29/16	3/25/16	

C. Change of scope

- (a) Customer requirements change replaced the propellant tanks' ½-in. fill and drain valves with ¼ in valves. Pump system design was affected but there was minor impact. The estimated flow rates dropped from 5 to 10 gal/min to 1 to 3 gal/min. This was acceptable to the program. Replacing ¾-in. supply lines with 1-in. lines helped to minimize the reduction in flow rates. The fill and drain valves became the only appreciable pressure drop. A trial run of the system obtained a flow rate of approximately 3 gal/min.

REVIEWS

The following are the NASA internal review processes as described by existing standards for design, safety, and operational readiness.

- A. Review Process—refer to NASA Review Process Standards/Business Management System (BMS) Procedures [12], [13].
 - (a) Design reviews—verify pressurization, fill, and drain carts meet design requirements to fill, drain, and pressurize the test article tanks.
 - (b) Safety reviews—review hazards analysis and determine if equipment and personnel safety been adequately addressed.
 - (c) Operational readiness review—verify that equipment operational procedures been developed and approved as well as the crew trained.

CONSTRUCTION

Verify that NASA and the contractor buildup follows NASA workmanship standards and practices.

- A. COTS components
 - (a) Search for components
 - (b) Meet requirements
- B. Team effort
 - (a) Technician skill mix (plumbing, electrical, mechanical, controls, and instrumentation)
 - (b) Review design concept with technicians and seek input
 - (c) “Hands on” work effort
- C. Field adaptations
 - (a) Assembly and field fit-ups
 - (b) Other items that were not considered

DOCUMENTATION AND TEST PROCEDURES

Required documentation according to NASA ORION project standards:

- A. Piping & instrumentation diagrams (P&IDs)
- B. Panel, cart, and box layout diagrams
- C. Bill of materials (BOM)
- D. Operations procedures
 - (a) HFE-7100 55-gal drum to 350-gal SS tote
 - (b) Cart fluid transfer procedures
 - (c) PBSPF-092, DI water cart operation
 - (d) PBSPF-093, HFE-7100 cart operation
 - (e) PBSPF-094, GN₂ pressurizing system operation

CHECKOUT AND COMMISSIONING

Started initial checkouts with procedures and then made operational redlines where applicable to improve fluid cart operations and train operations crew.

- A. Initial fluid checkouts of both fuel and oxidizer carts with DI water only

- B. Priming pump is most important step
- C. Actual fluid checkouts with respective simulant fluids
- D. Fluid measurement weight calibration and verifications
- E. Novec™ HFE-7100 55-gal drum transfer to 350-gal SS tote (refer to Figures 15 and 16)



Figure 15: Novec™ HFE-7100 barrel to 350-gal SS tote [14] transfer operations.



Figure 16: Barrel to storage tote pump [15].

TEST CAMPAIGN OPERATIONS

Conducted a very successful campaign where multiple fill, drains, and pressurizations were performed, which met the test matrix requirements as follows:

- A. Completed multiple fills, drains, and pressurizations.
- B. Performed at multiple locations.

- C. Confirmed measurement accuracy and consistency in fill and drain operations. Prefilled transfer hoses with simulant fluids before conducting test tank fill and drain measurement operations.
- D. Refer to Figures 17, 18, and 19 for major Novec™ HFE-7100 or DI Water Fill and Drain System components.

NOTE: When initially pressurizing the oxidizer propellant tanks filled with the Novec™ HFE-7100 simulant fluid, it was noted that the tank pressure would drop a few psi when left overnight as the nitrogen would adsorb into the simulant fluid since nitrogen is soluble into HFE-7100. Operations personnel would then pressurize the oxidizer tank in small pressure increments until vapor and liquid equilibrium was reached where the tank pressure would be stable and not drop. Also, it was visually verified that gas bubbles were noticed in the transfer line back to the vented storage tanks as part of the drain operations. This is where the nitrogen was liberating itself from the simulant fluid as the pressure changed when transferring the simulant fluid from the pressurized propellant tank to the vented storage totes.



Figure 17: Deionized (DI) water and Novec™ HFE-7100 storage totes [9], [14] on weight scales [16].



Figure 18: Deionized (DI) water fill and drain cart.



Figure 19: Deionized (DI) water portable panel.

REFERENCES

- (1) National Aeronautics and Space Administration, “Orion Spacecraft,” (September 2018). <https://www.nasa.gov/exploration/systems/orion/index.html>
- (2) MPCV 72514, “Orion Multi-Purpose Crew Vehicle (MPCV) Design Reference Missions (DRM) and Concept of Operations (CONOPS) for the European Space Agency Service Module (ESM).”
- (3) European Space Agency (ESA), “Orion European Service Module,” (November 2015). https://www.esa.int/Our_Activities/Human_Spaceflight/Orion/European_Service_Module
- (4) Airbus, “Defence and Space,” (2018). <https://orionesm.airbusdefenceandspace.com/>
- (5) European Space Agency (ESA), “Testing Completed on Orion Service Module,” (December 2016). https://www.esa.int/Our_Activities/Human_Spaceflight/Orion/Testing_completed_on_Orion_service_module
- (6) NASA Glenn Research Center, “Space Environments Complex (SEC),” (July 2018). <https://www1.grc.nasa.gov/facilities/spf/>
- (7) MPCV 70156, “Cross Program Fluid Procurement and Use Control Specification.”
- (8) 3M Company, “Novec HFE–7100,” (2018). www.3M.com/Novec (3M and Novec are trademarks of 3M Company. Used with permission by trademark owners.)
- (9) Chemworld, “DI Water,” (2018). <https://www.chemworld.com/DeIonized-Water-s/2622.htm>
- (10) ABZ Incorporated, “CRANE Technical Paper 410 Based Software,” (2018). <https://www.abzinc.com/index.php>
- (11) Price Pump Company, (2018). <http://www.pricepump.com/Home.aspx>
- (12) NASA Review Process Standards/Business Management System Procedures. (Design Reviews—GLP-H-7320.2; Safety Review: NASA Glenn Safety Manual—GLP-QS-8715.1; and Operational/Test Readiness Reviews—GLP-H-8720.1)
- (13) MPCV 72205, “NASA Orion Project Standards.”
- (14) Hoover Container Solutions, (2018). <http://www.HooverSolutions.com/>
- (15) Goat Throat Pumps, (2018). <https://www.goatthroat.com/>
- (16) Triner Scale & Manufacturing Company, (2018). <http://www.trinerscale.com/index.html>

BIOGRAPHIES

Mr. Cmar works for the contractor HX5-Sierra, LLC at NASA Plum Brook Station in Sandusky, Ohio. He currently is serving as a Facility and Data Systems Engineer for the Space Environments Complex (SEC). He has over 29 years NASA experience as an instrumentation and controls engineer, data systems, project manager, deputy test program manager, and facility engineer at Plum Brook. He holds a Bachelor of Science (BS) in Electrical Engineering from the University of Pittsburgh and is a registered Professional Engineer in the State of Ohio. He is a member of the International Society of Automation (ISA).

Mr. Grisnik is a civil servant at the NASA Plum Brook Station in Sandusky, Ohio. He is currently serving as the Senior Thermal Vacuum Systems Engineer for the In Space Propulsion Facility (ISP). He has 35 years of experience as a thermal vacuum systems engineer at NASA Glenn Research Center Lewis Field and Plum Brook. He holds a BS in Chemical Engineering from the University of Pittsburgh and a Master of Science (MS) in Chemical Engineering from the University of Toledo.