



TIRS-2 Instrument Project

Thermal Infrared Sensor-2



Landsat 9 TIRS-2 Architecture and Design

Melody Djam– TIRS-2 Instrument Deputy Project Manager

Jason H. Hair¹, Dennis C. Reuter¹, Synthia L. Tonn¹, Joel McCorkel¹, Amy A. Simon¹, Melody Djam², David Alexander³, Kevin Ballou¹, Richard Barclay¹, Phillip Coulter¹, Michael Edick⁴, Boryana Efremova⁵, Paul Finneran⁶, Jose Florez⁴, Steven Graham¹, Kenneth Harbert⁴, Dennis Hewitt², Michael Hickey¹, Samantha Hicks¹, William Hoge⁴, Murzy Jhabvala¹, Carol Lilly⁷, Allen Lunsford⁸, Laurie Mann¹, Candace Masters⁹, Matthew Montanaro¹⁰, Theodore Muench¹, Veronica Otero¹, Fil Parong¹, Aaron Pearlman⁵, Jonathan Penn¹¹, Danielle Vigneau¹, Brian Wenny¹²

¹NASA Goddard Space Flight Center, ²Bay Engineering Innovations, Inc.,

³ASRC Federal Space and Defense, ⁴Florez Engineering, LLC, ⁵GeoThinkTank, LLC,

⁶Jackson and Tull, Inc., ⁷Alcyon Technical Services, LLC, ⁸Catholic University of America,

⁹General Dynamics C4 Systems, Inc., ¹⁰Rochester Institute of Technology,

¹¹Stinger Ghaffarian Technologies, Inc., ¹²Science Systems and Applications, Inc.



Landsat History

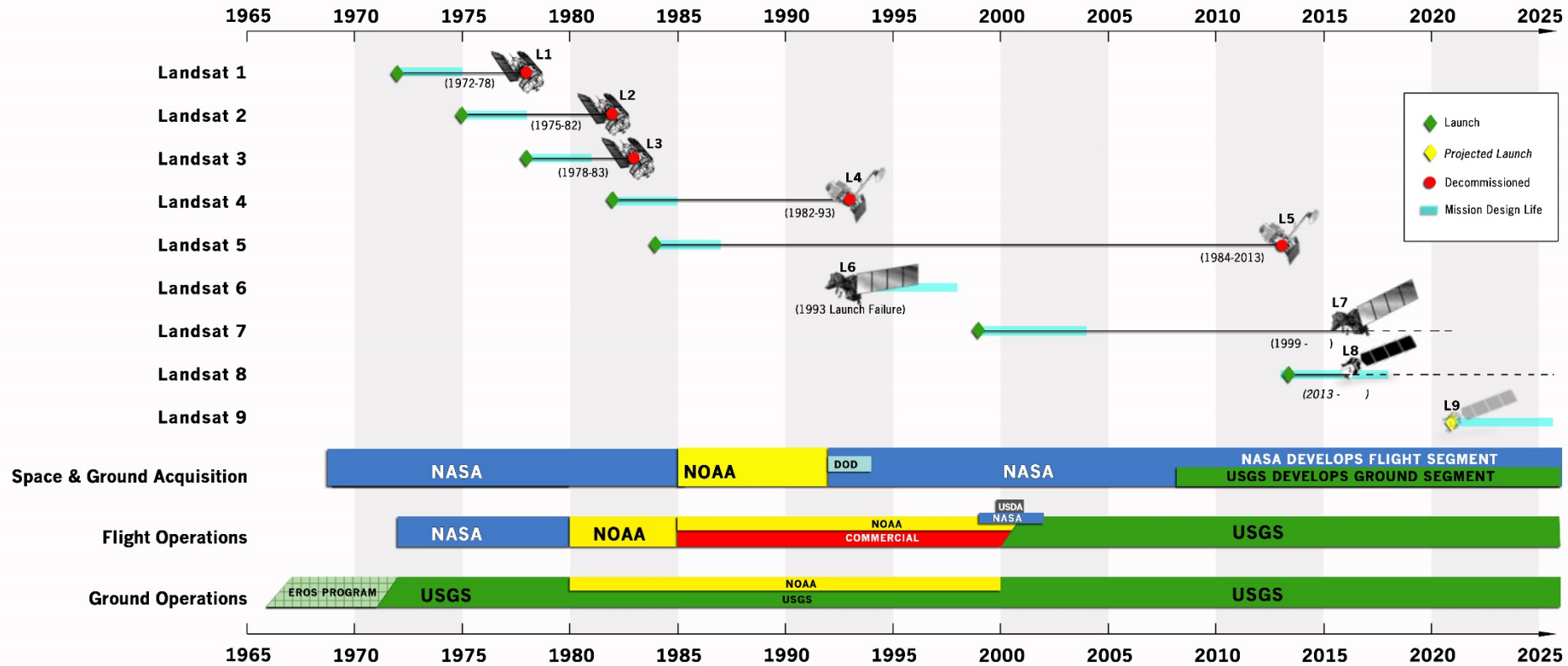



TIRS-2 Instrument Overview



• Instrument Characteristics

- 2 channel (10.6-11.2 μm and 11.5-12.5 μm) thermal imaging instrument
- Quantum Well Infrared Photodetector (QWIP) detector Focal Plane Array (FPA)
 - Second flight use of GSFC developed QWIPs (First was TIRS)
- 100 m Ground Sample Distance
- 185 km ground swath (15° field of view)
- Operating cadence: 70 frames per second
- Precision Scene Select Mirror (SSM) to select between nadir view, onboard variable temperature blackbody and space view
 - Repeatability better than 10 microradians
- Passively cooled telescope assembly operating at $\sim 190\text{K}$ (nominal)
- Actively cooled FPA operating at $\sim 38\text{ K}$
- Thermal stability key to radiometric stability
- Absolute accuracy requirement: 2% for target temperatures 260K to 330K
- $\text{NE}\Delta\text{T} < 0.4\text{ K @ } 300\text{ K}$ (required), $\text{NE}\Delta\text{T} < 0.1\text{ K @ } 300\text{ K}$ (expected)



TIRS-2 Overall Status

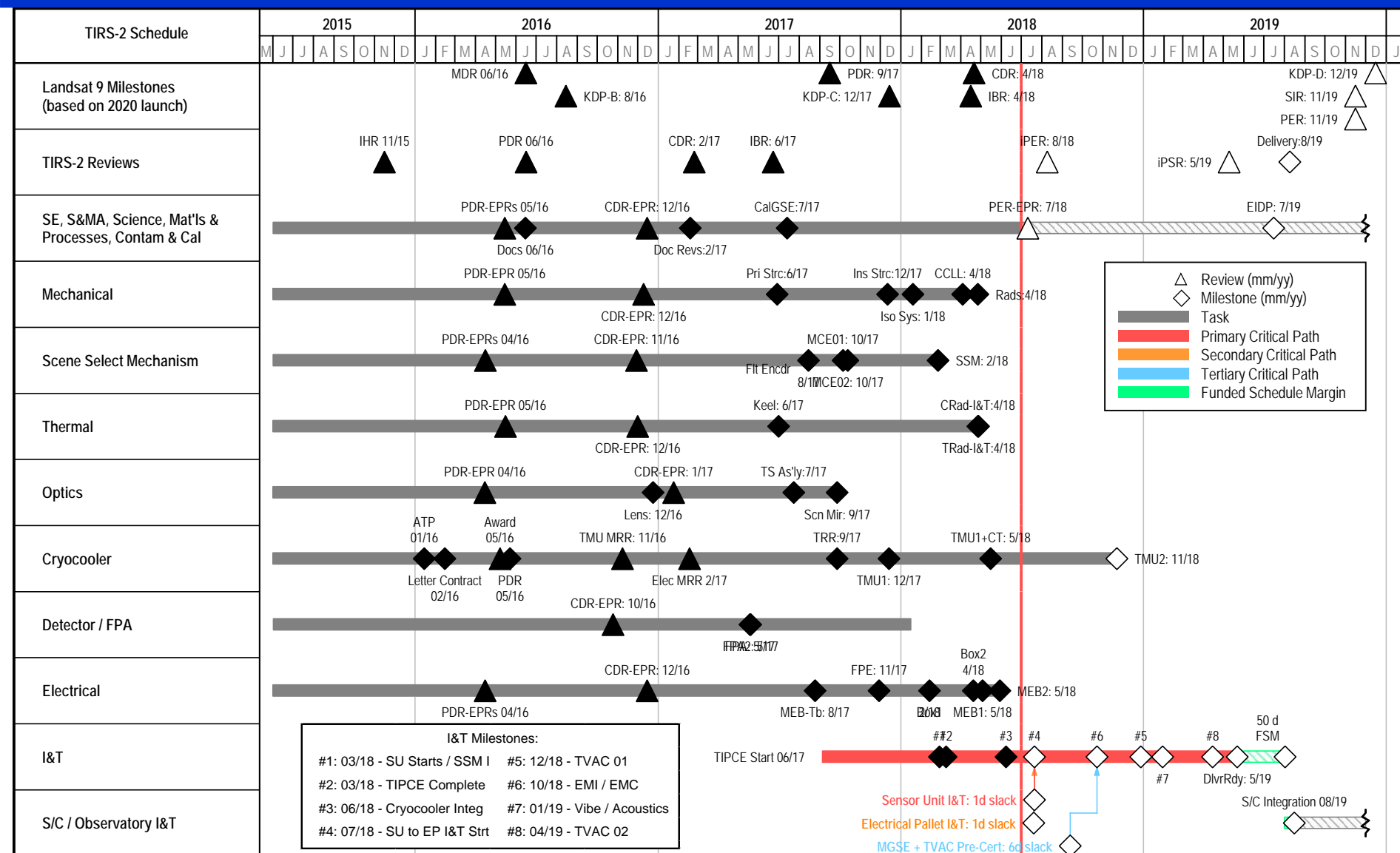



TIRS-2 Roles and Responsibilities



- **Goddard Space Flight Center**

- Overall Instrument Responsibility
- Management & Systems Engineering
- Instrument Scientist and Deputy Instrument Scientist
- Focal Plane Assembly (Detectors)
- Electrical System
 - MEB – CDH, PCB, TCB, HSIB, MCE
 - Harness
- Mechanical Structure, Blackbody, Cryo Isolation, Earth Shield, Launch Lock
- Radiators, Heat Pipes, Thermal Hardware
- Scene Select Mechanism
- Telescope and Optics
- TIRS-2 Integration and Environmental Qualification
- TIRS-2 Performance Testing, Calibration and Characterization

- **Ball Aerospace:** Cryocooler

- Thermal Mechanical Unit, Cryocooler Electronics, Harness

- **Jackson and Tull:** Focal Plane Electronics

- FPE, FIB, SIDECAR Assembly Code

- **Gurley Precision Instruments:** SSM Encoder





TIRS to TIRS-2: Change Sources



- Same science / performance requirements
- Top Level Requirements changes
 - Reliability improvement from Class C for 3.25 years to Class B for 5.25 years
 - Increase in scenes collected per orbit to 83
 - Launch load environment changed to Atlas V Mass Acceleration Curve
 - Thermal survival environment changed
 - Environmental changes for Micrometeorite protection, space charging, radiation environment
- TIRS on-orbit performance
 - Evaluated TIRS on-orbit performance for design changes to meet requirements
 - Eliminate stray light
 - SSM encoder reliability
 - Thermal margins
- TIRS lessons learned / build record redlines / residual risk / waiver / PFR / PR dispositions
 - Evaluated TIRS history for sources of design / requirements changes
 - Initiate trades to authorize design changes
 - Work with Science and L9 teams to update requirements



TIRS to TIRS-2: Strategy



- Minimize design changes
 - Design stays the same unless specifically approved and driven by a change in requirement or by a trade driven by on-orbit performance or a lesson learned
 - Utilize trade study process to assess and approve changes due to requirements changes, lessons learned, risk, waiver, PFR, and PR dispositions, and on-orbit performance
- Make as much use of TIRS design, documentation, hardware as possible
- Enforce existing interfaces and environmental limits on spacecraft
- Build from past experience, learn lessons from TIRS and maintain strong connection to TIRS team
- Determine the most effective approach to upgrade the architecture to meet the Class B requirement
- Review on-orbit performance and devise methods for changes where needed to meet requirements



TIRS to TIRS-2: Design Change Summary



- **Electrical System Reliability for Class B:**
 - Make fully redundant with two MEBs and CCEs plus CCE RSE to connect two CCEs to a single Cryocooler TMU
 - Selectively cross strap MEB-CCE, MEB-Encoder, MEB-FPE
 - FIB added for FPE to MEB cross strap interface
- **Thermal Control System Reliability for Class B:**
 - Increase operational heater sizes and circuits so control margin met with one side
 - Increase in Telescope Radiator area to meet Telescope temperature control margin
 - Corresponding reduction in Cryocooler Radiator area, which had excessive margin
 - Thermal coating and blanket outer layers changed to meet surface conductivity requirement
- **Structure Robustness:**
 - Re-assessed system to show positive margins to Atlas V MAC loads with minor changes to provide maximum flexibility for spacecraft selection
 - Added structure survival heaters and increased structure core density to maintain structural integrity through off-nominal spacecraft orientations
- **Telescope Stray Light Performance:**
 - Add baffles to telescope to block scattered light
 - Perform detailed, independent stray light analysis and ambient tests to confirm results
- **Encoder Reliability:**
 - Selected a different source with different processes to mitigate reliability risk



TIRS-2 Electrical System Reliability Trade Study



- Electrical System Reliability Trade Study result was to add block redundancy with selective cross strapping
 - MEB will be cross-strapped to the CCE, FPE and Encoder, with a block redundant interface to SSM motor
 - Influenced by TIRS Lessons Learned of having to leave a well working and calibrated detector read system (FPE) due to an encoder problem
 - Held multiple redundancy and cross strapping reviews to ensure no hidden single point failures

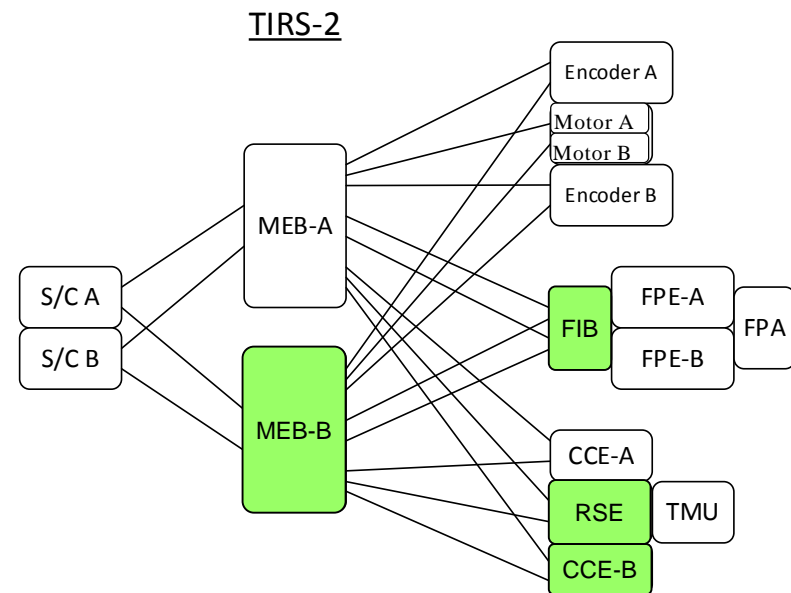
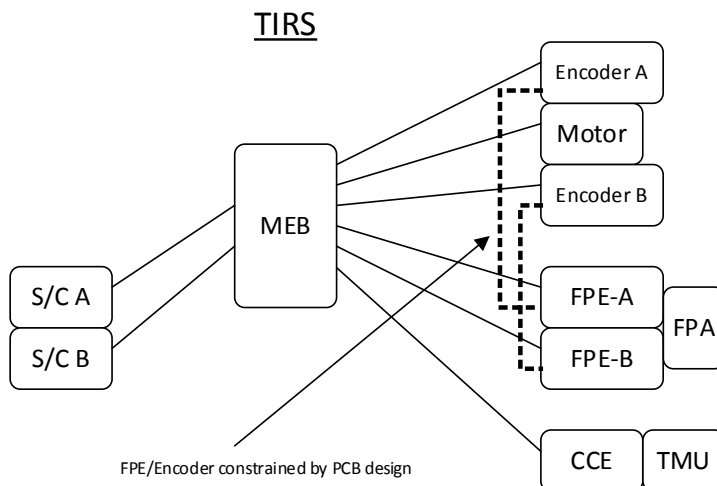

 New for TIRS-2



TIRS Encoder On-Orbit Performance



- The team lead by TIRS-2 and GSFC Mission Assurance was able to reach root cause for the TIRS on-orbit encoder performance, enabling TIRS-2 to positively avoid recurrence
- The root cause is a bad lot of ceramic capacitors from prior to 2012
 - The TIRS on-orbit anomaly was repeated with very high confidence on one side of one of the flight spare encoder boards.
 - Thermal analysis and subsequent circuit analysis showed that ceramic capacitors on the board were the source of the leakage currents.
 - Internal cracks and delamination at the terminations were found in these capacitors.
 - Examination of a batch of spares from the flight lot indicated that about 10% of the pristine capacitors showed the same flaw.
- TIRS-2 has eliminated pre-2012 capacitors from Flight assemblies, benefiting the Encoder, as well as a number of other boards in the Main Electronics Box

Telescope Baffles

- Stray light baffles added to Lens 2 & 3 Preload Spreaders

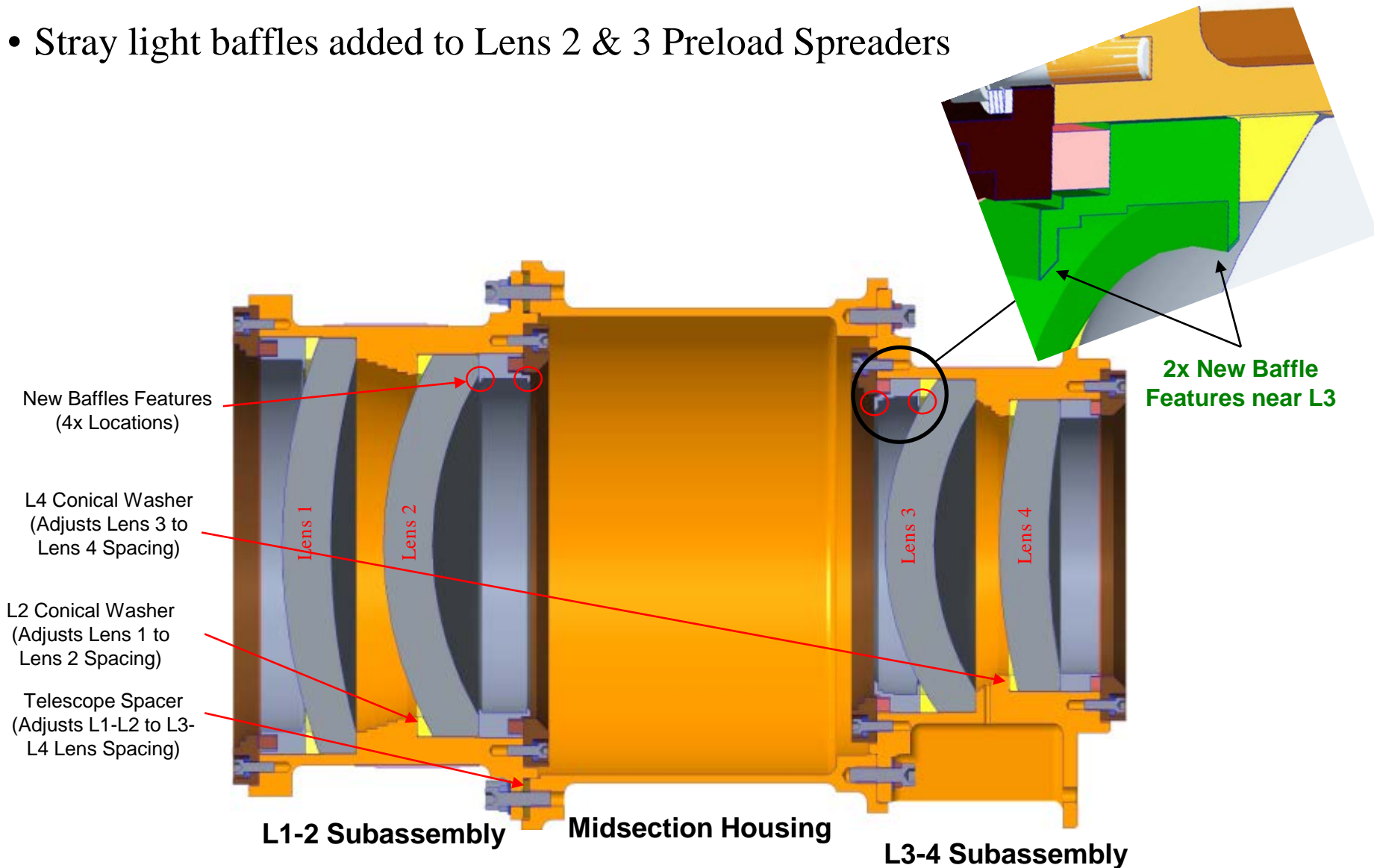



TIRS-2 Stray Light Status



- The scattering from 13 degree annular feature seen on TIRS has been reduced by more than an order of magnitude on TIRS-2
 - A scene dependent correction for this effect was developed for TIRS which allows the observations to meet requirements
- The 22 degree annular feature observed in TIRS-2 Imaging Performance Cryoshell Evaluation (TIPCE) testing was not initially observed on TIRS and is not used in the correction
 - After the TIPCE results, the TIRS lunar data were analyzed again and the feature was seen in the extended approach scans at a much lower intensity than the 13 degree feature
 - TIPCE results indicate the 22 degree feature on TIRS-2 is lower than that on TIRS
- Effects of stray light have been reduced enough that TIRS-2 can meet absolute radiometric requirements without a scene-dependent correction like the one needed for TIRS
- Forward work
 - Continue to process the measured stray light results along with the optical model to determine the variance of the stray light effects from the 22 degree feature
- Final performance will be evaluated in flight and possible correction schemes using methodologies in place at USGS will be determined in conjunction with the Landsat cal/val and Science teams



TIRS-2 Block Diagram

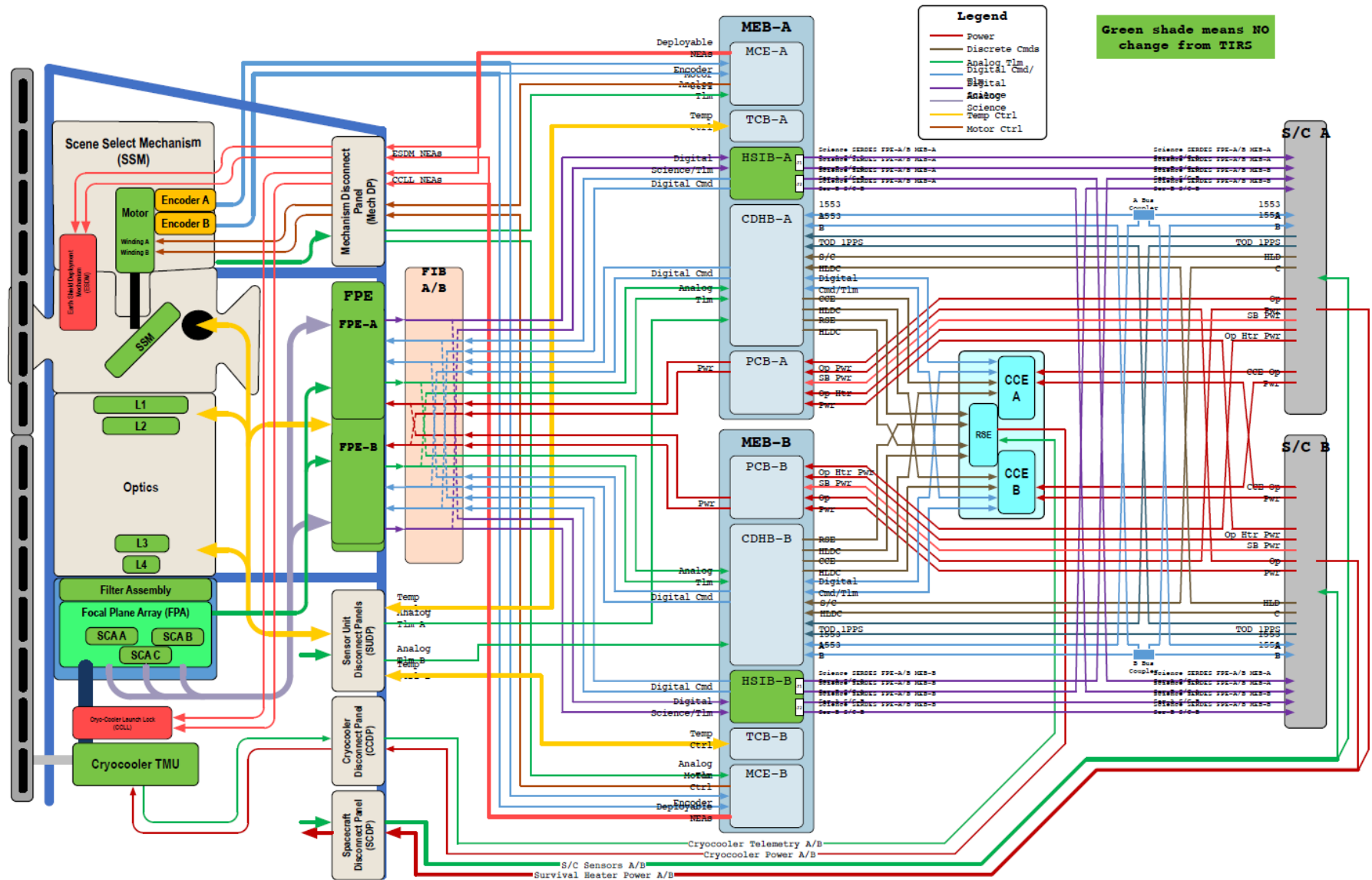



TIRS-2 Sensor Unit Design Overview

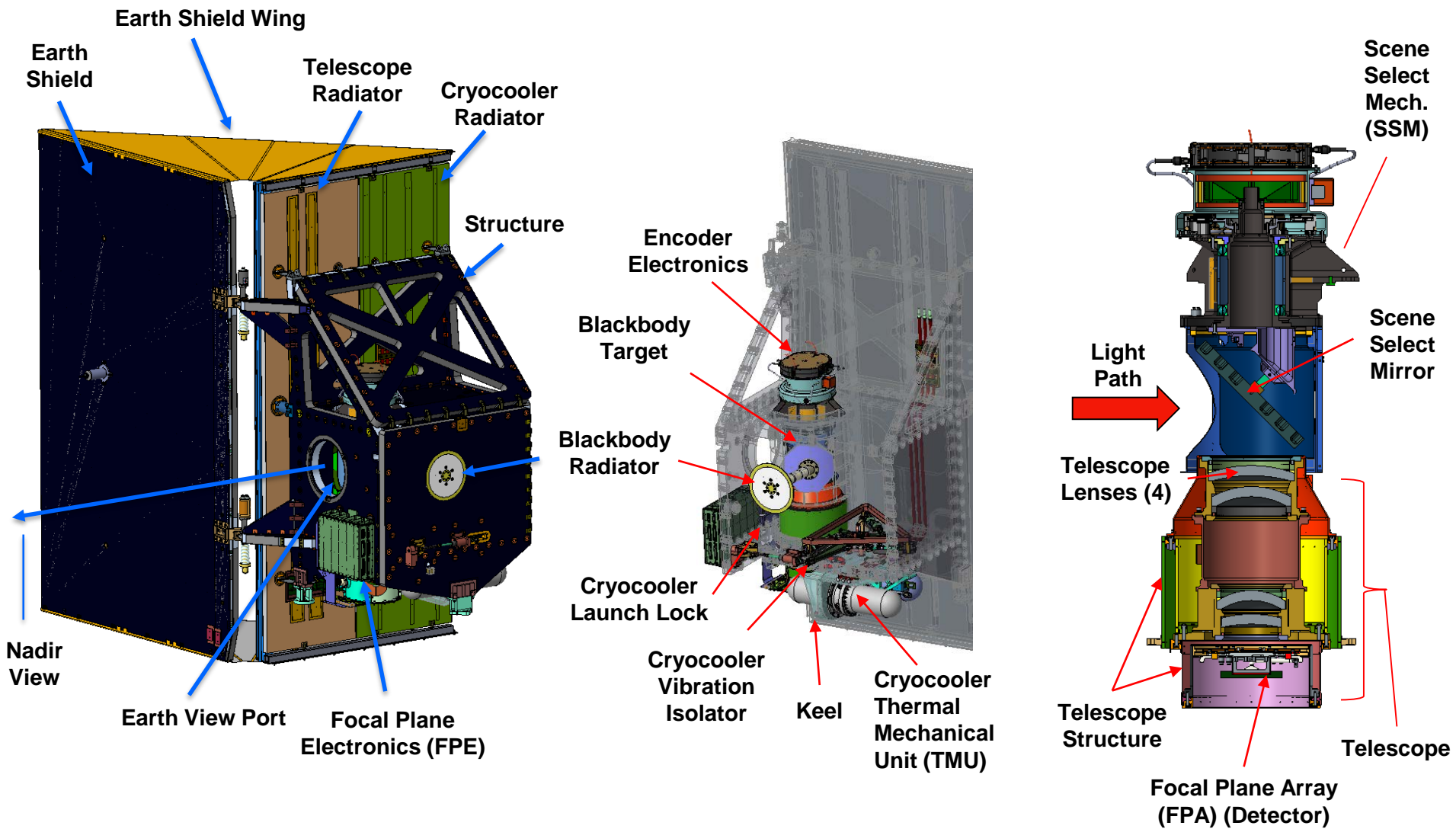

TIRS-2 Flight Hardware

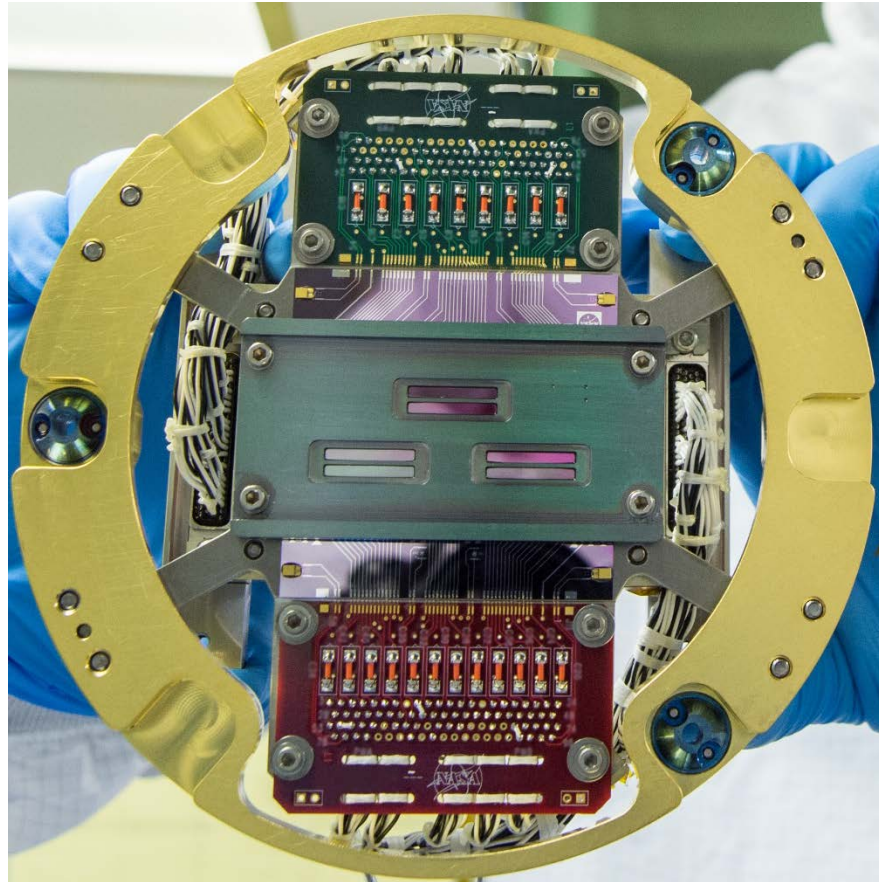

Front of Flight Detector with Filter segments installed, showing the 3 arrays with 2 channels each

TIRS-2 Flight Hardware

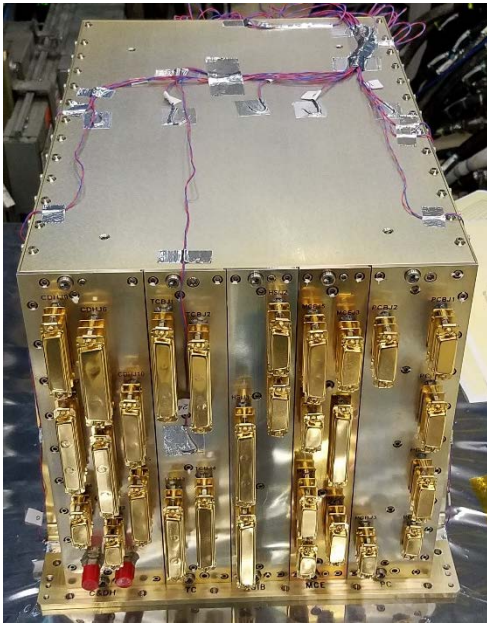

Flight MEB 1

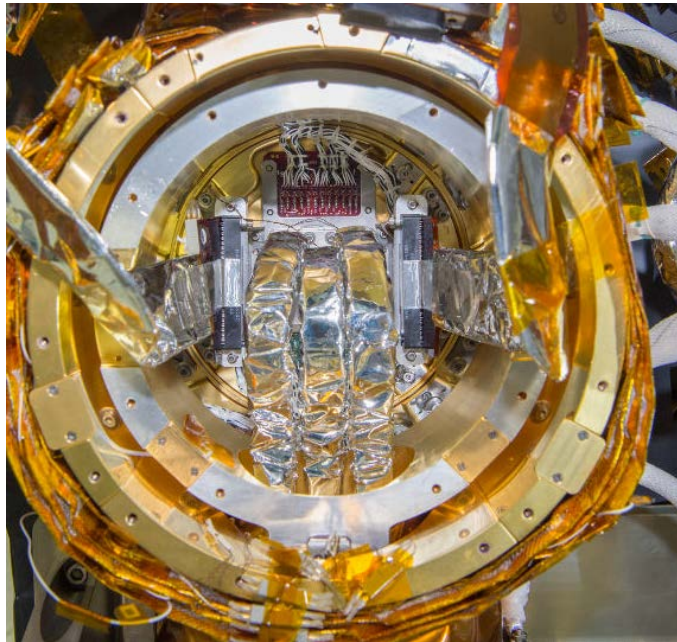

Flight Detector Installed behind Telescope

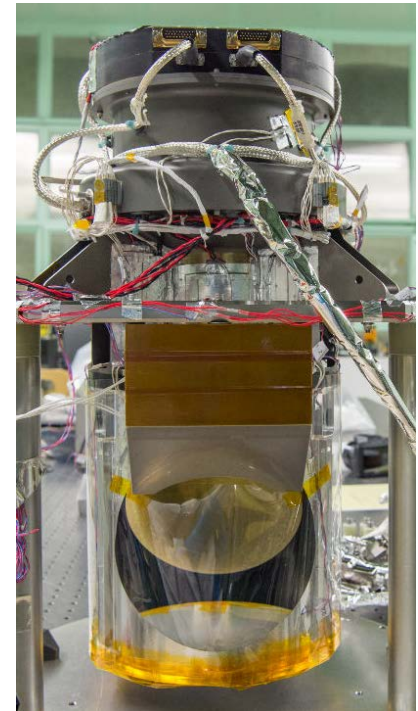

Flight Scene Select Mechanism



Flight Cryocooler Control Electronics, Redundancy Switch Electronics, and Thermal Mechanical Unit at GSFC

TIRS-2 Flight Hardware

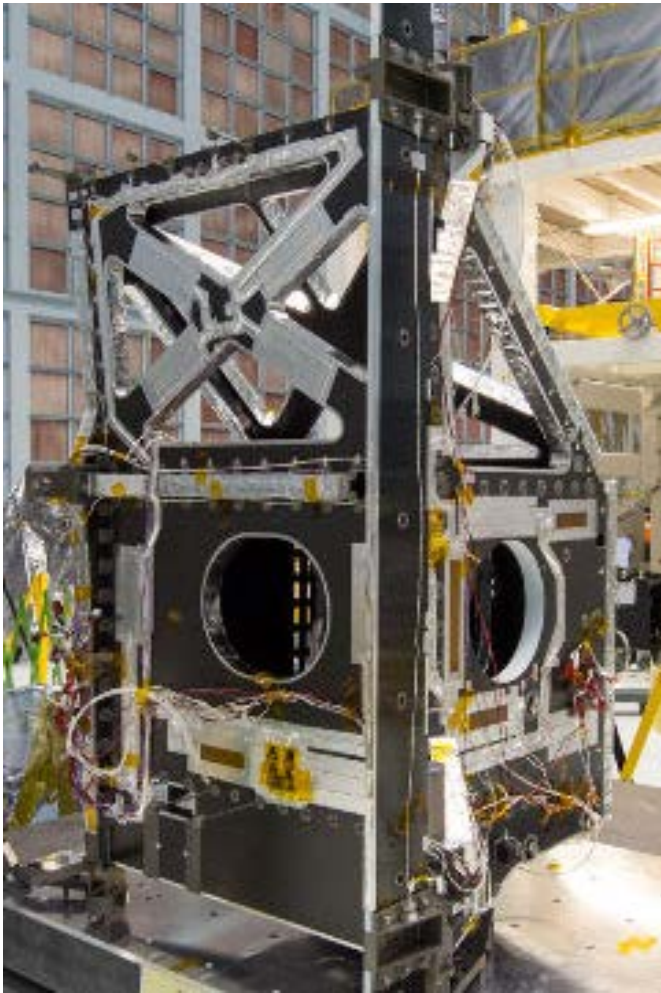

Flight Structure with Thermal Hardware Installed and Earth Shield Hinges and Strong Back

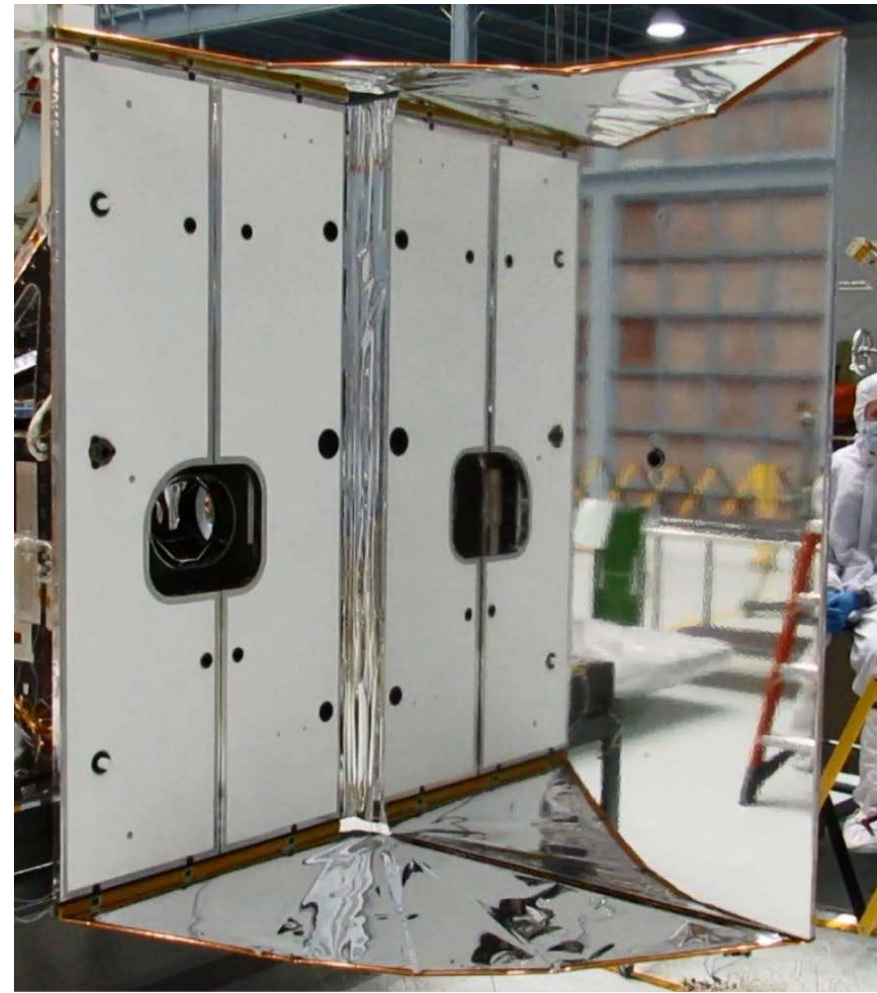

Flight Radiators on Structure with Earth Shield Deployed with Wing Blankets



Lessons Learned

- Even proven, heritage interfaces that have not changed pose a functionality risk, just like new interfaces
 - Focal Plane Array (FPA) – Flexible Printed Wiring (FPW) – Focal Plane Electronics (FPE) interface was build to print from TIRS and believed to be low risk
 - Upon the first test of the full Flight system, the FPA did not function properly
 - During TIRS development, a signal from the FPE to FPA was disconnected, but not captured in the documentation
 - These interfaces should be verified as early as possible to minimize this risk
- All changes have add risk to a project
 - Each change must be tested and verified
 - There is a higher risk that a problem will be found later in the development when an aspect is different or new
 - Changes should be screened carefully to justify the possible downstream impact
- New start projects will have different risk decisions than the heritage project, adding to design and plan changes
 - When risks develop late in a project, they are more likely accepted as the impacts to mitigate the risk are too great
 - The new start project will ultimately have to face the risks that were accepted by the heritage project and will likely have to take mitigation steps as the possible impact to the future plan is too great to leave them unmitigated
 - These accepted risks should be evaluated early in the new project planning stage to capture these additional changes and scope in the plan



Conclusion



- TIRS-2 will have the same performance as TIRS, except better in some cases
- TIRS-2 carefully made strategic changes to the TIRS design to respond to requirement changes and improve science performance
 - Electrical System Reliability for Class B
 - Thermal Control System Reliability for Class B
 - Structure Robustness
 - Telescope Stray Light Performance
 - Encoder Reliability
- All of the subsystem elements have been completed and delivered to instrument system level integration and test
- Instrument-level testing plan is mature and will begin Fall 2019
- Landsat 9 with TIRS-2 launch expected December 2020 to continue Landsat data record



Thermal Infrared Sensor - 2 • Landsat 9

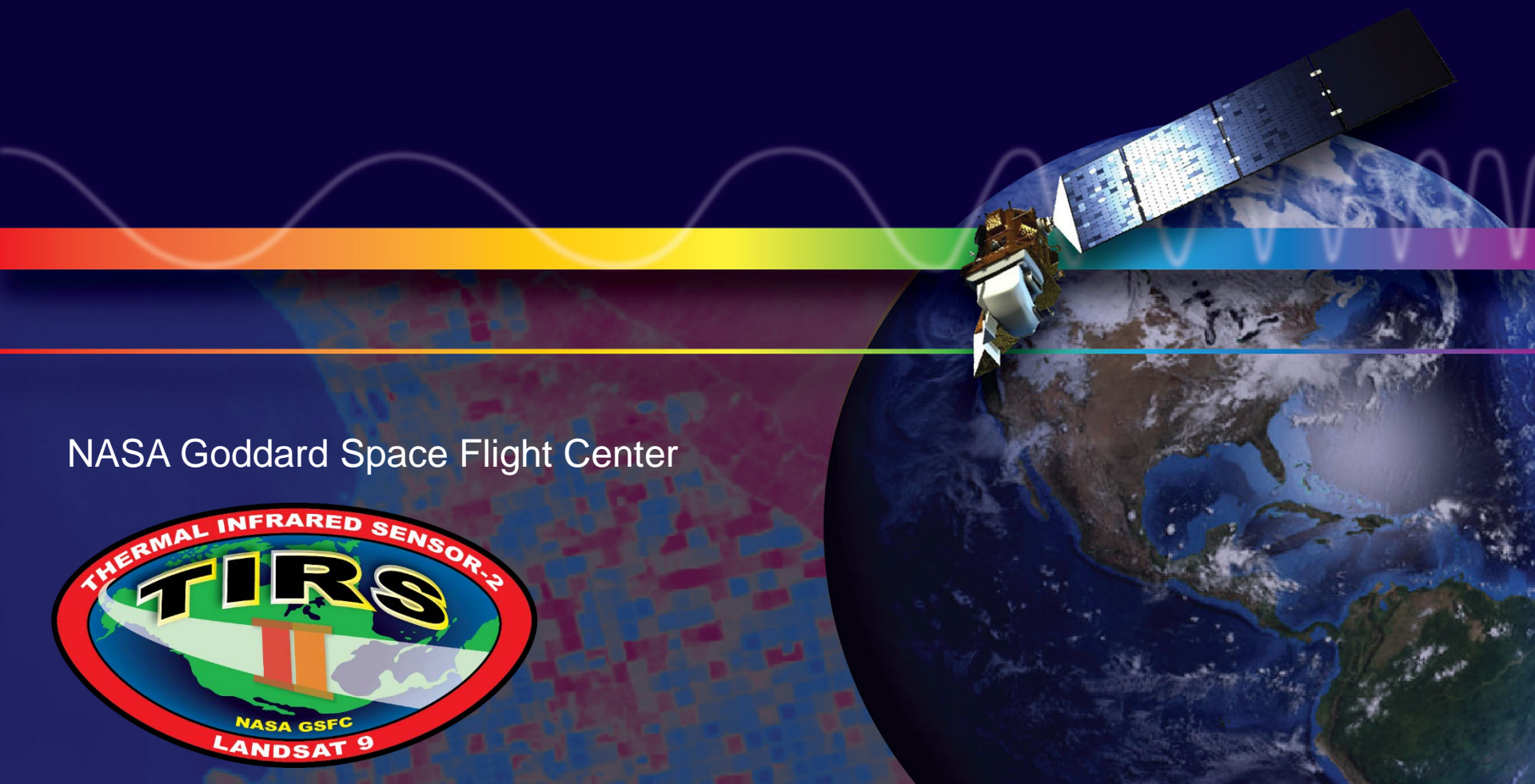

NASA Goddard Space Flight Center



TIRS-2 Science Objectives

- Monitoring of evapotranspiration, water use on a regional and field-by-field basis in the U.S. and internationally
- Mapping urban heat fluxes for air quality modeling
- Volcanic hazard assessment, monitoring, and recovery
- Cloud detection, screening to process OLI-2 image data
- Mapping waterway thermal plumes from power plants
- Burnt area mapping / Wildfire risk assessment
- Identifying mosquito breeding areas, vector-borne illness potential
- Forestry and land use management

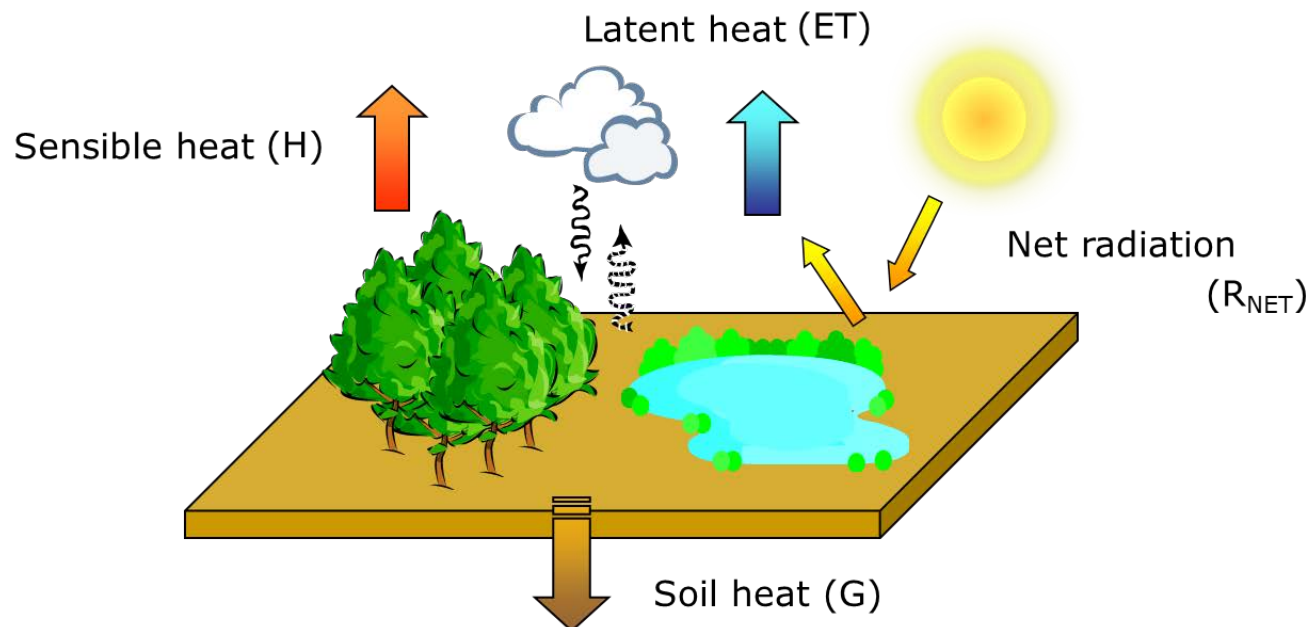



Evapotranspiration and Surface Temperature

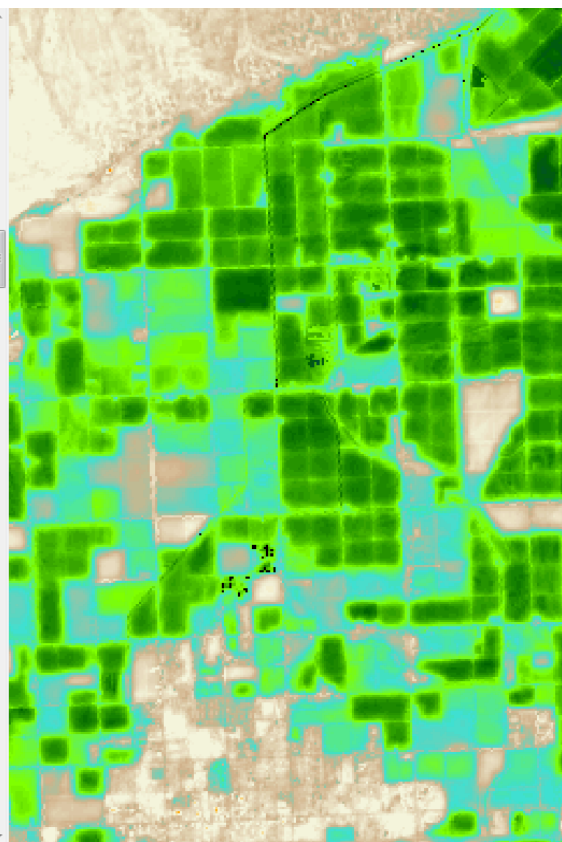

Typical TIRS Evapotranspiration Data Product – darker green shows Fields with more Irrigation

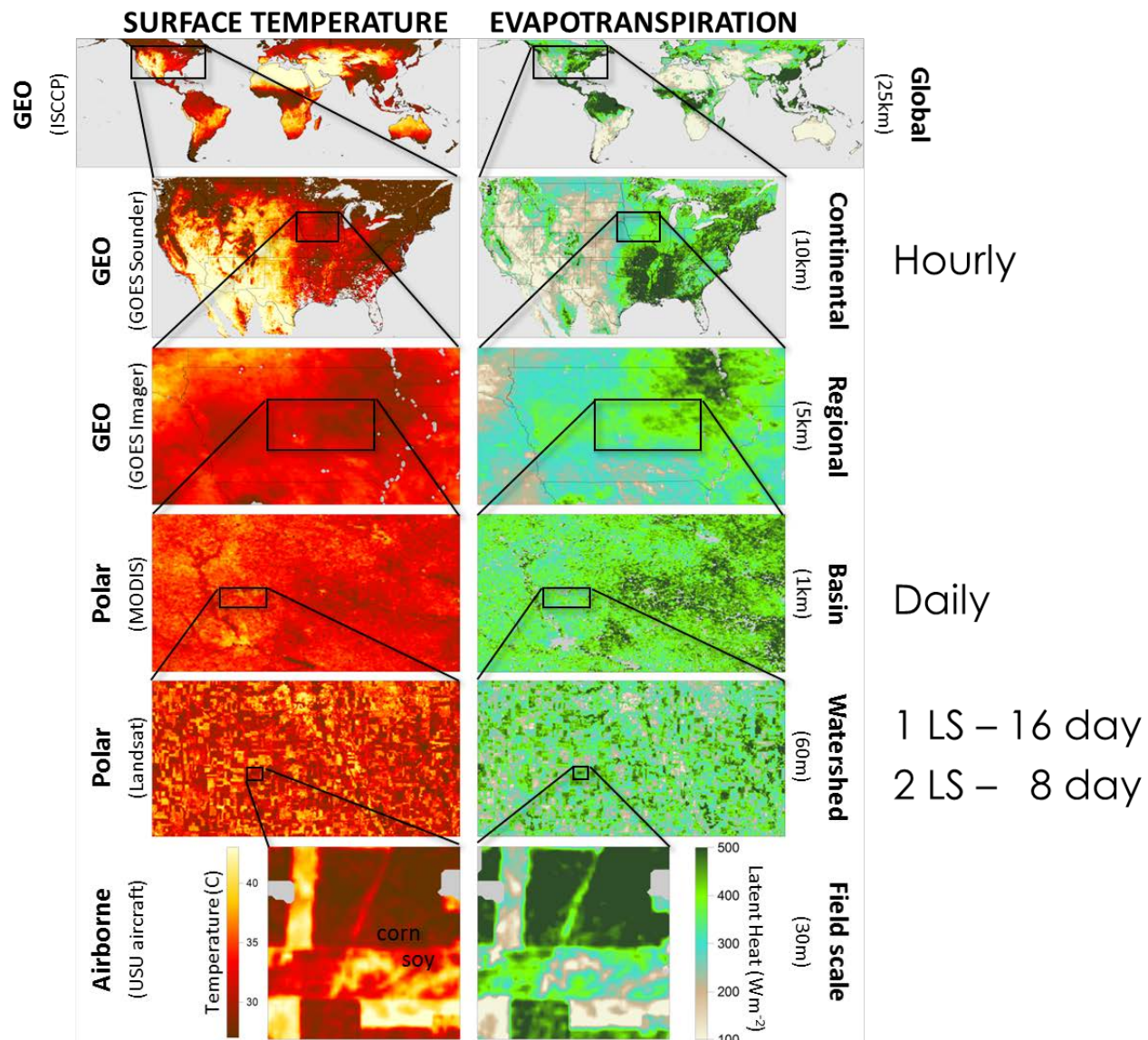



— Active fires

— Interstate 15

San Bernardino

5 km



Larsen C Ice Shelf, Antarctica
Landsat 8 / TIRS
07/26/2017

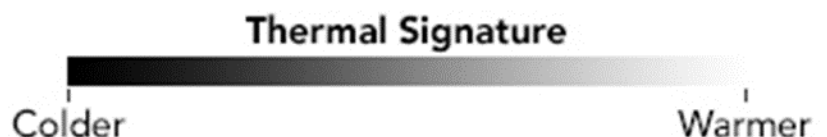
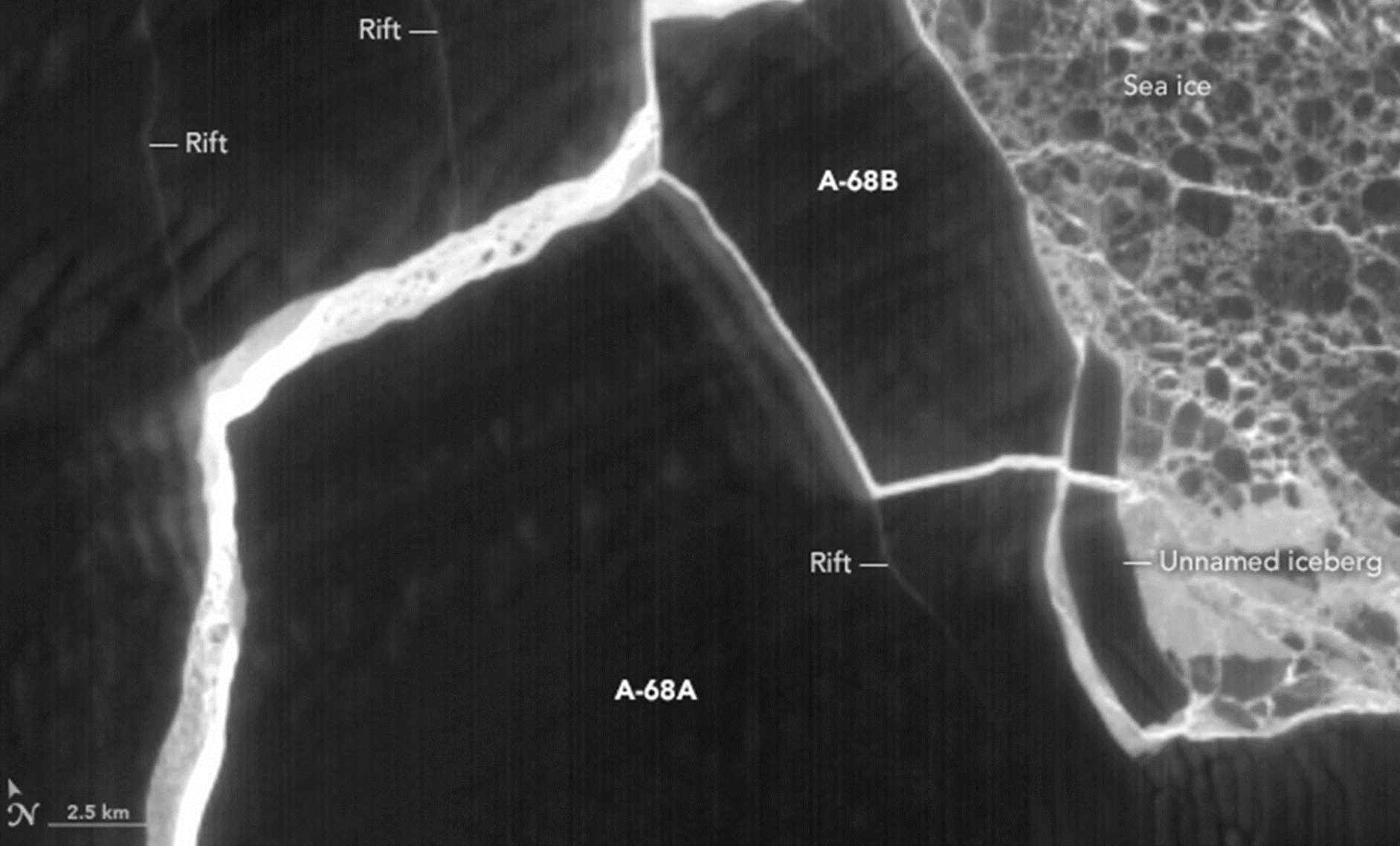



Driving Requirements



	Title	Requirement	Expected Compliance
Spectral	Thermal Spectral Band and Width	Band 10.8 Center 10.8 +/- .2, min/max edge 10.3/11.3 um Band 12.0 Center 12.0 +/- .2, min/max edge 11.5/12.5 um Waiver Approved for 12.5 um Level 3 Requirement	= 10.9 nm center, 10.6 um to 11.2 um = 12.05 nm center, 11.5 um to 12.6 um Model shows band edge around 12.55 um, analysis shows negligible impact on science
Radiometry	Absolute Radiometric Accuracy	Absolute radiometric uncertainty relative to a NIST traceable standard < 2% (1-sigma)	CBE = 1.8% (1-sigma)
	Radiometric Stability	12.0 um < 0.70% (1-sigma) 10.8 um < 0.70% (1-sigma)	= 0.53% (1-sigma) = 0.51% (1-sigma)
	Noise Equivalent Delta Radiance - NEΔL	10.8um 0.059 W/m2 sr μm 12um 0.049 W/m2 sr μm	Radiance < 0.008 (360K, flood source) Radiance < 0.008 (360K, flood source)
Spatial	Ground Sample Distance	185 km cross track swath width 120 m cross and in track for each detector element	185 km 100 m per detector element
	Relative Edge Response	AT > 0.047/m XT > 0.047/m	10.9 um: XT: .0059 m AT: .0058m 12um: XT: .0059 m, AT: .0060 m TIRS-2 performance same as TIRS, which met science objectives.
	Edge Extent (10 to 90%)	AT < 240m XT < 240m	10.9 um: XT: 215.6 m, AT: 222.9 m 12um: XT: 214.9 m, AT: 205.5 m TIRS-2 performance same as TIRS, which met science objectives.
Pointing	Absolute Pointing	2 mrad (3-sigma, per axis)	XT= 556.6 urad, AT= 688.0 urad
	Alignment Knowledge	< 600 urad each axis	XT= 279.3 urad, AT= 400.0 urad
	Pointing Stability	< 27 urad (3-sigma, per axis) over 16 days	XT= 7.16 urad, AT= 4.14 urad
	Timing Accuracy	Timing of each detector column shall be known < 1.5 ms	CBE < 1.5 ms



TIRS-2 Design Status and Change Summary



Subsystem	Heritage or Change Description	Design Changes and Justification
Optics	Heritage design remains the same except for stray light baffles	On-Orbit Performance: Add baffle behind lens 2 and in front of lens 3 for stray light mitigation
Detector	Heritage design remains the same. Inherited TIRS flight spare Focal Plane Assembly and Sensor Chip Arrays that were assembled in to a new FPA	No changes
Filter	Heritage design remains the same. Inherited TIRS flight spare	No changes
Scene Select Mechanism	Heritage design remains the same except for encoder. Inherited motor housing assembly, mirror housing assembly, and bearing housing	On-Orbit Performance: New encoder vendor, minor change for new encoder optical disk and electronics interface Requirement Change: Additional MCE encoder interface for cross strap
Cryocooler	Vendor heritage design for Thermal Mechanical Unit remains the same except for minor changes for ground operation and manufacturability. Cryocooler Control Electronics upgraded to improve functionality based on lessons learned from TIRS and add redundancy	Requirement Change: Addition of RSE for redundancy and cross strap Lesson Learned: Redundant CCE design and control algorithm updated for TIRS-2, Minor TMU changes to balance springs, fill tube seal, bottle wall thickness
Mechanical System	Heritage design for primary structure, radiators, earth shield, launch lock, and keel remain the same except for changes need to meet margin requirements from requirements changes	Requirement Change: Analyze full system to increased design limit launch environment and new thermal survival limit, including 3D finite element model of critical joints. Structure and Earth shield insert design changes and panel core density increase to survive extreme thermal and launch environment Lesson Learned: Use a different graphite epoxy material due to availability, change release mechanism from TiNi ERM to NEA due to lead time
Thermal	Heritage design remains the same except for changes need to meet margin requirements and due to requirements changes	Requirement Change: Increased operational heater allocations and redundancy. Added structure survival heaters. Conductive blanket outer layer and radiator coatings. Add thicker Kevlar to select blankets Lesson Learned: Radiator area re-allocation to improve telescope temperature control margin and reduce excessive margin on cry cooler radiator
Electrical	Heritage design remains the same except for changes due to addition of redundancy and cross strapping	Requirement Change: Addition of second MEB for redundancy, Implement cross-strapping for MEB-CCE, MEB-FPE, MEB-Encoder, Limited board level changes to PCB, CDH, MCE, TCB changes for added heaters, heat dissipation, control sensor commanding, Firing circuit for NEA
FPE	Heritage design remains the same	FPE is unchanged – already redundant Requirement Change: FIB added to provide cross-strapping capability
Calibration		On-Orbit Performance: Add wide angle stray light test at telescope – detector assembly level