

# Radiation Protection and Shielding: Space Fission Systems



Presented by:  
Michael Houts, PhD  
NASA MSFC  
[Michael.houts@nasa.gov](mailto:Michael.houts@nasa.gov)



# Nuclear Thermal Propulsion (NTP)

---

[STMD \(GCD\) Nuclear Thermal Propulsion Video](#)

<https://www.youtube.com/watch?feature=youtu.be&v=miy2mbs2zAQ&app=desktop>



## Background: *NTP Benefits*

---

- For human Mars missions, first generation NTP can reduce crew time away from earth from >900 days to <500 days while still allowing ample time for surface exploration
  - Reduce crew exposure to space radiation, microgravity, other hazards
- First generation NTP can enable abort modes not available with other architectures
  - Potential to return to earth anytime within 3 months of earth departure burn, also to return immediately upon arrival at Mars
- Stage/habitat optimized for use with NTP could further reduce crew exposure to cosmic rays and provide shielding against any conceivable solar flare
- NTP can reduce cadence and total number of SLS launches
- NTP has potential for reducing cost, increasing flexibility, and enabling faster response times in cis-lunar space
- First generation NTP is a stepping stone to fission power systems and highly advanced nuclear propulsion systems that could further improve crew safety and architectural robustness

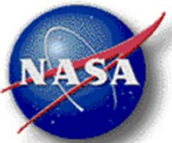

# Why is NTP Attractive for Human Missions to Mars?

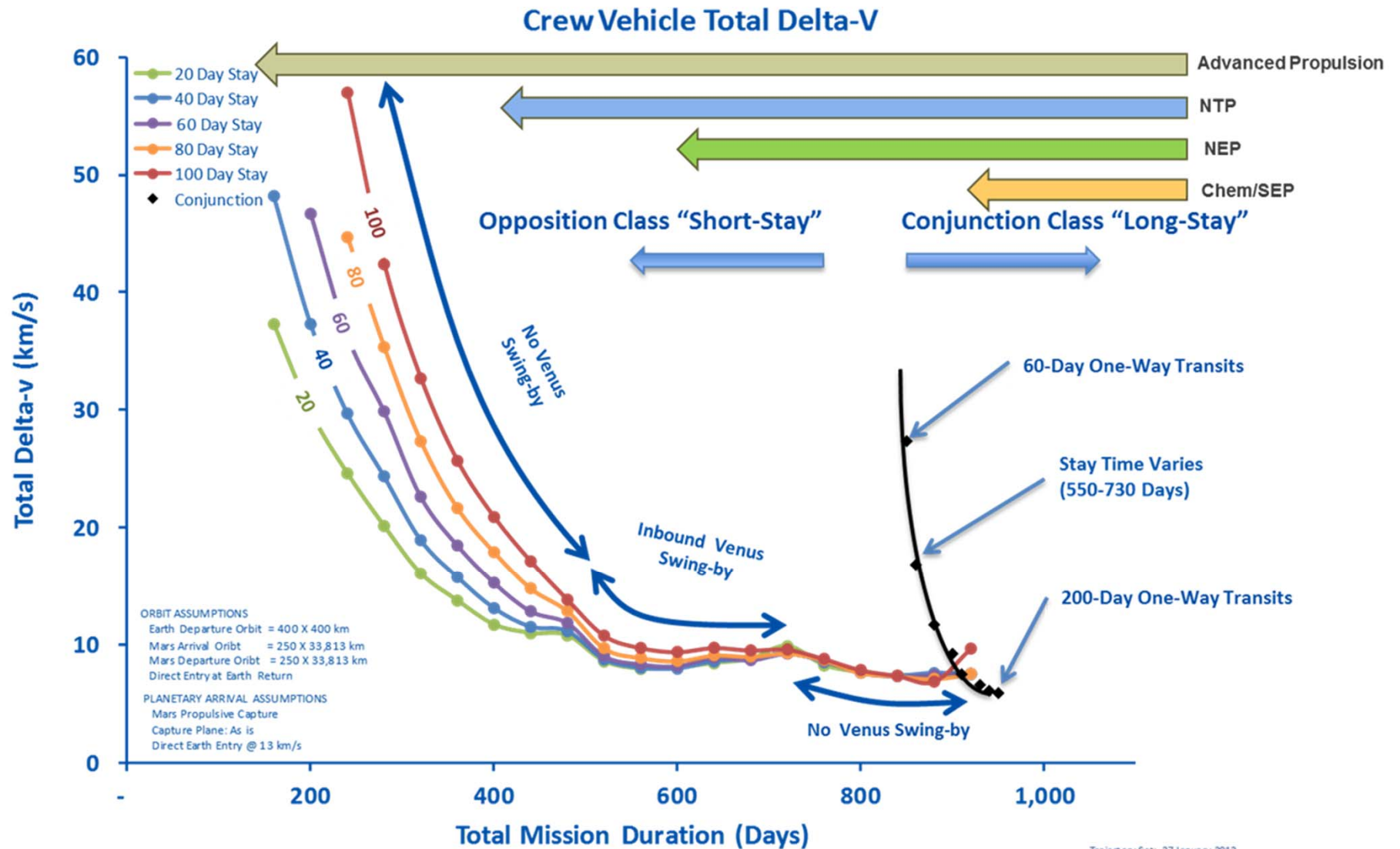



# Basics of Nuclear Systems

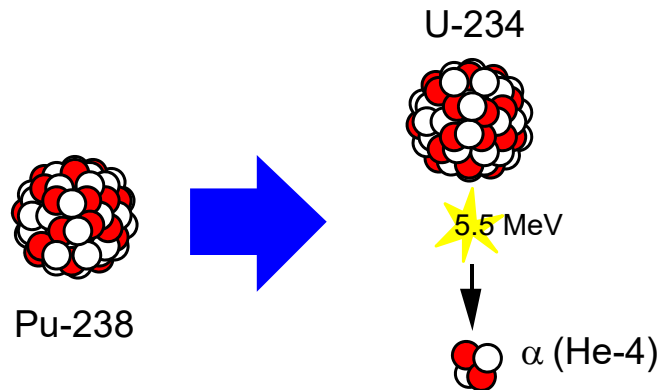

*Heat Energy = 0.023 MeV/nucleon (0.558 W/g Pu-238)*  
*Natural decay rate (87.7-year half-life)*

Long history of use on Apollo and space science missions

44 RTGs and hundreds of RHUs launched by U.S. since the 1960s

Heat produced from natural alpha (α) particle decay of Plutonium (Pu-238)

Used for both thermal management and electricity production

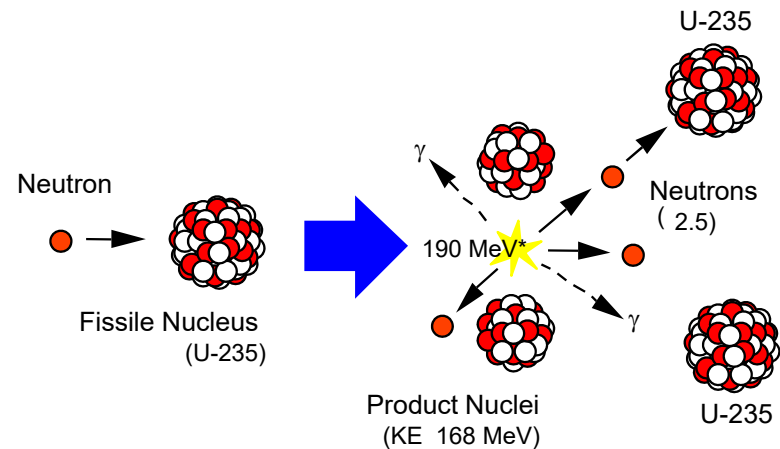

*Heat Energy = 0.851 MeV/nucleon*  
*Controllable reaction rate (variable power levels)*

Used terrestrially for over 70 years

Fissioning 1 kg of uranium yields as much energy as burning 2,700,000 kg of coal

One US space reactor (SNAP-10A) flown (1965)

Former U.S.S.R. flew 33 space reactors

Heat produced from neutron-induced splitting of a nucleus (e.g. U-235)

At steady-state, 1 of the 2 to 3 neutrons released in the reaction causes a subsequent fission in a "chain reaction" process

Heat converted to electricity, or used directly to heat a propellant

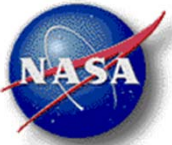

# How Might Initial NTP Systems Work?

- Propellant heated directly by a nuclear reactor and thermally expanded/accelerated through a nozzle
- Low molecular weight propellant – typically Hydrogen
- Thrust directly related to thermal power of reactor:  $100,000 \text{ N} \approx 450 \text{ MW}_{\text{th}}$  at 900 sec
- Specific Impulse directly related to exhaust temperature: 830 - 1000 sec (2300 - 3100K) for solid core, much higher for liquid or gas core
- NTP-derived systems could be used for high power / high performance production of electricity

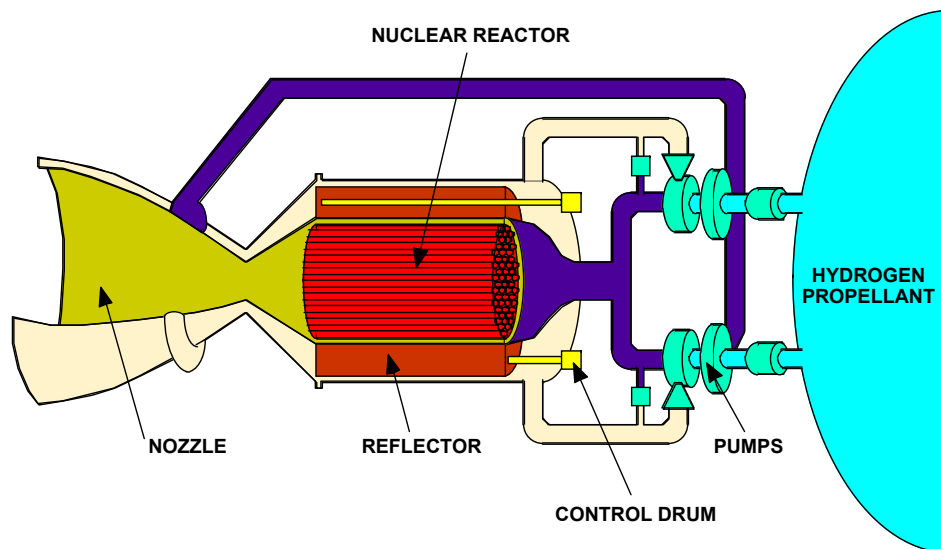

Major Elements of a Nuclear Thermal Rocket



NERVA Nuclear Thermal Rocket Prototype

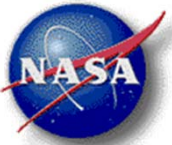

# How Might Initial NTP Systems Work?

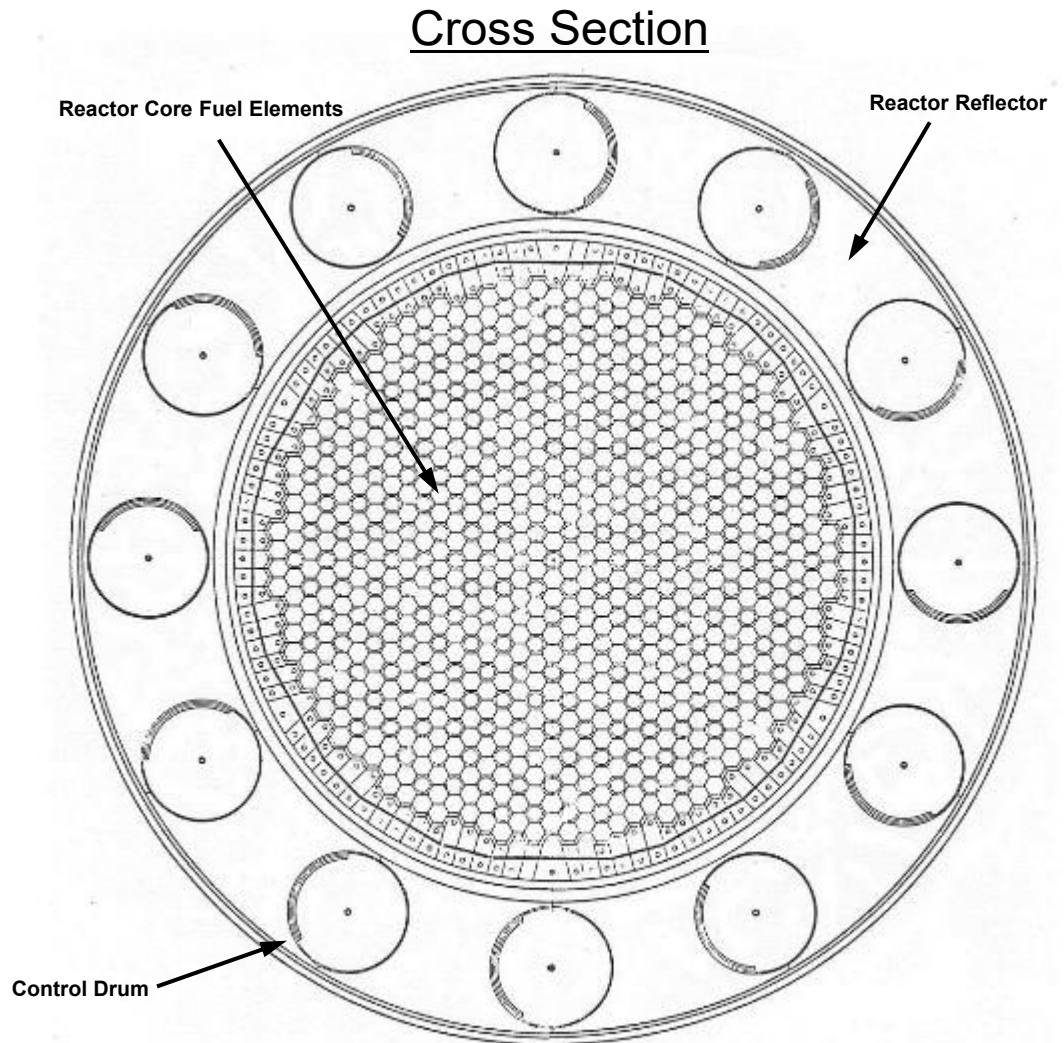
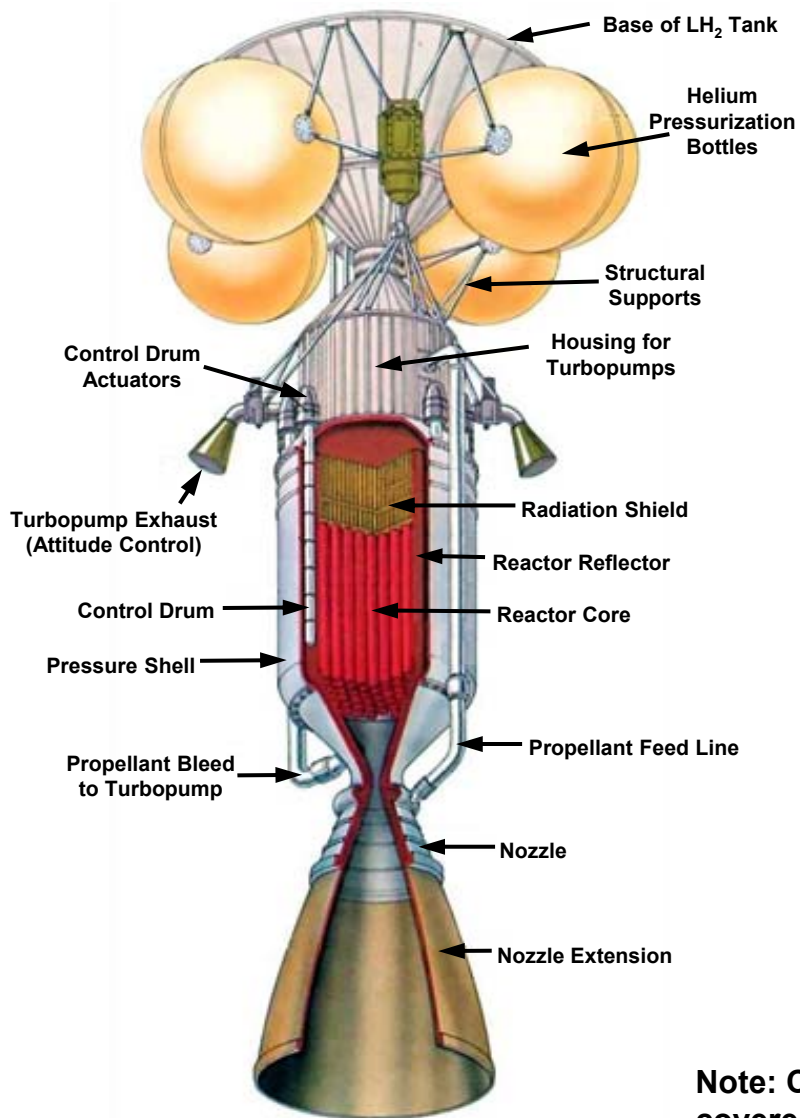

**Note: Control drums rotate to control reactivity. Portion of circumference covered with neutron absorber and remainder is reflector.**



# 20 NTP Engines Designed, Built, and Tested During the Rover/NERVA Program (1955-1973)

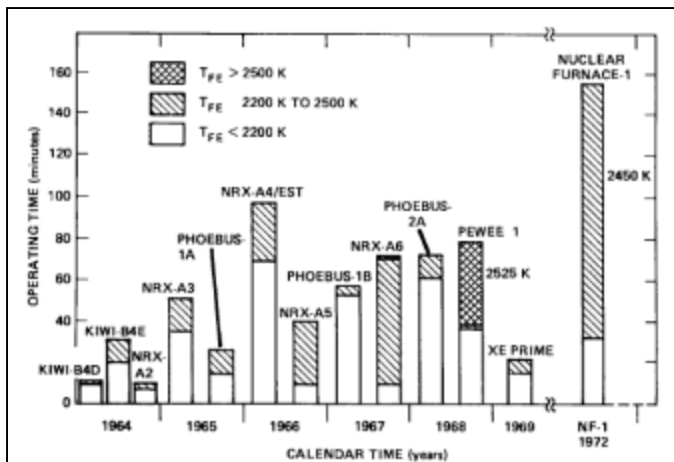
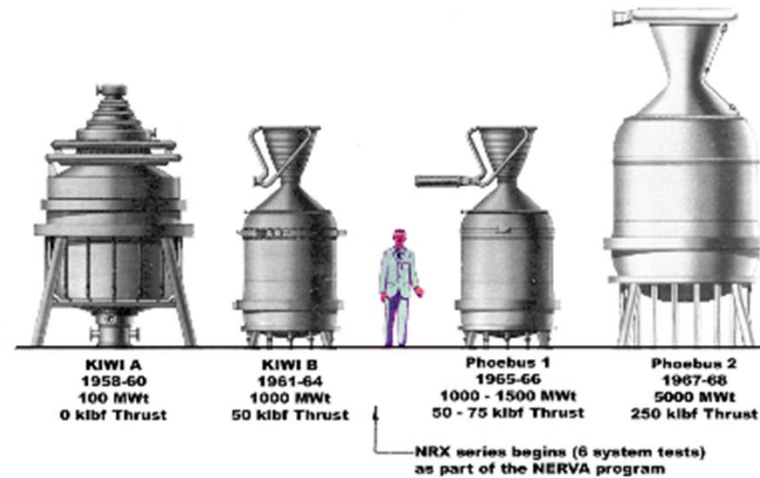
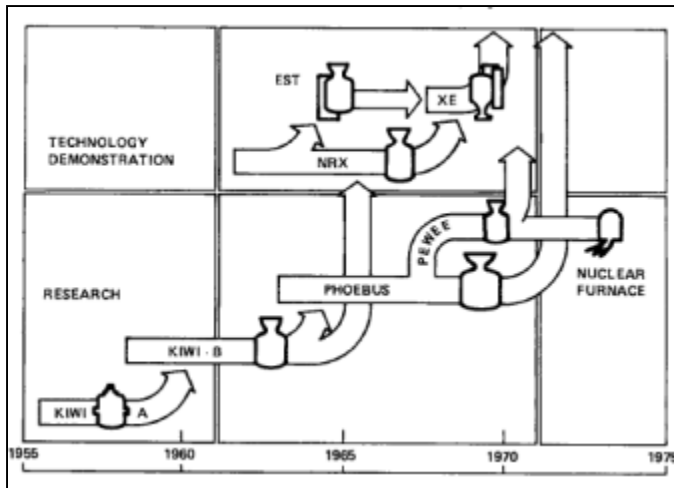





# NTP Ground Testing Exhaust Capture Concept

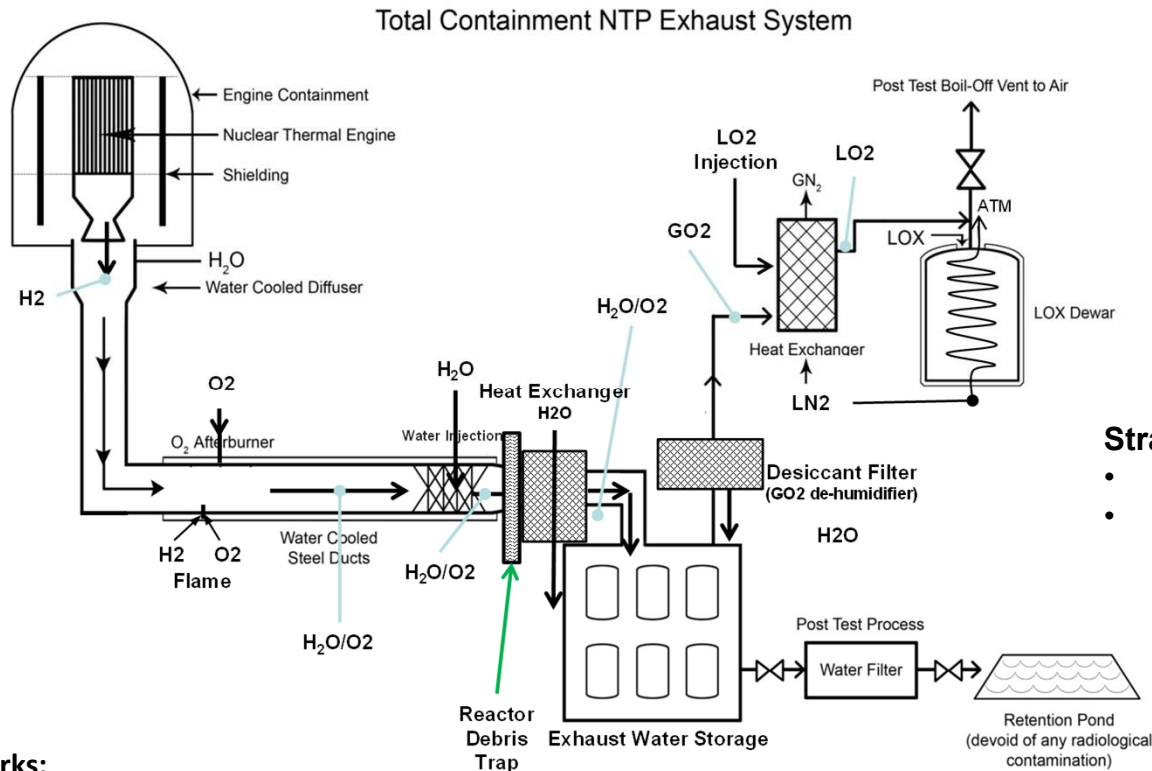

## Strategy:

- Fully Contain engine exhaust
- Slowly drain containment vessels after test

## How it works:

- Hot hydrogen exhaust from the NTP engine flows through a water cooled diffuser that transitions the flow from supersonic to subsonic to enable stable burning with injected LO<sub>2</sub>
  - Products include steam, excess O<sub>2</sub> and potentially, a small fraction of noble gases (e.g., xenon and krypton)
- Water spray and heat exchanger dissipates heat from steam/O<sub>2</sub>/noble gas mixture to lower the temperature and condense steam
- Water tank farm collects H<sub>2</sub>O and any radioactive particulates potentially present in flow.
  - Drainage is filtered post test.
- Heat exchanger-cools residual gases to LN<sub>2</sub> temperatures (freezes and collects noble gases) and condenses O<sub>2</sub>.
  - LOX Dewar stores LO<sub>2</sub>, to be drained post test via boil-off



# NTP Ground Test Exhaust Capture Concept

## Conceptual System Design Layout

### One Potential Option: Stennis Space Center's (SSC's) A3 Test Stand

- Most of the infrastructure required by ground test facility (including exhaust capture) is already in place:
  - Tower, test cell, propellant, HPIW & data and controls infrastructure, the Test Control Center, electric power, etc.
  - Major modifications, procurements, and construction work will be required and are captured in the ROM estimate.

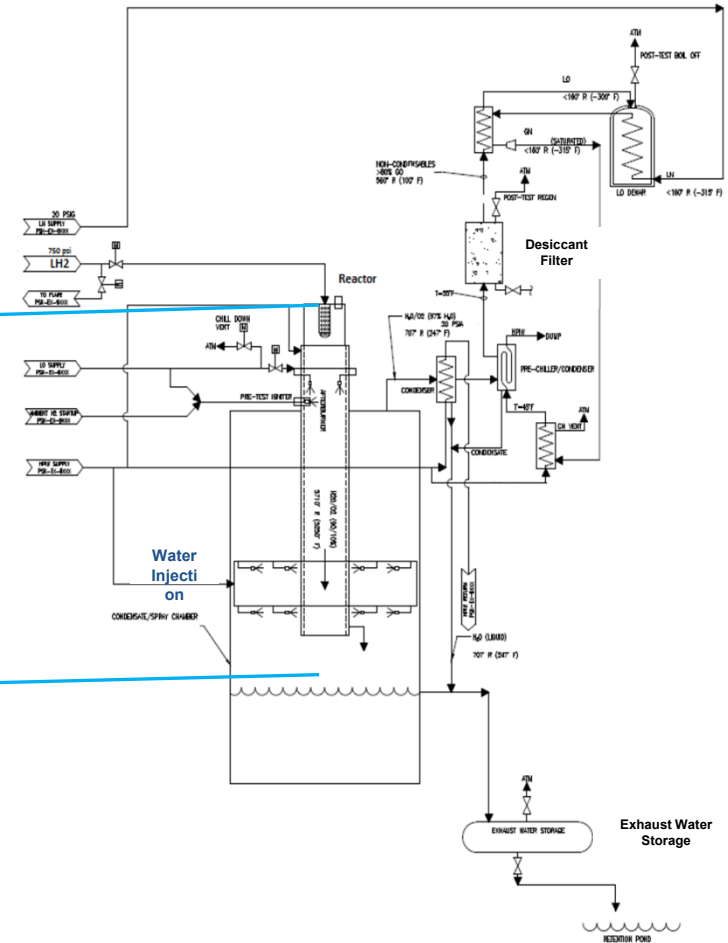
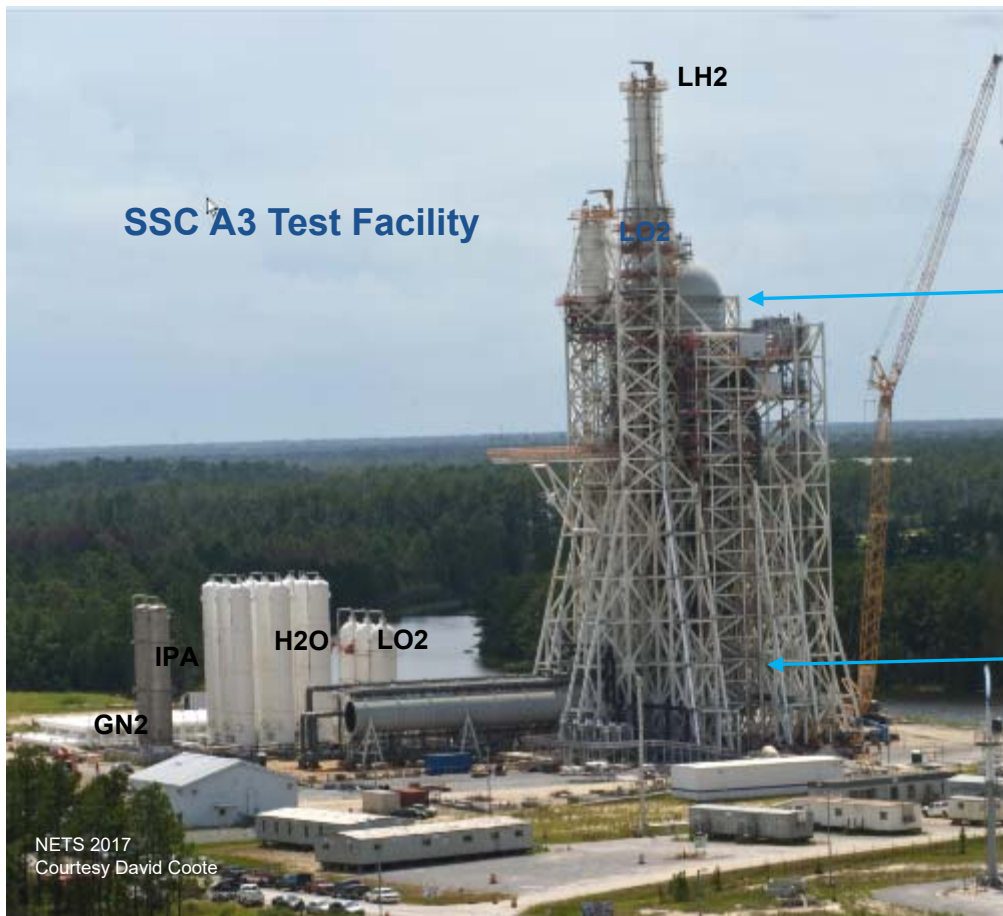



# SSC's Acoustic Buffer Zone

## Illustration of Comparable NRC-Designated Planning Zones

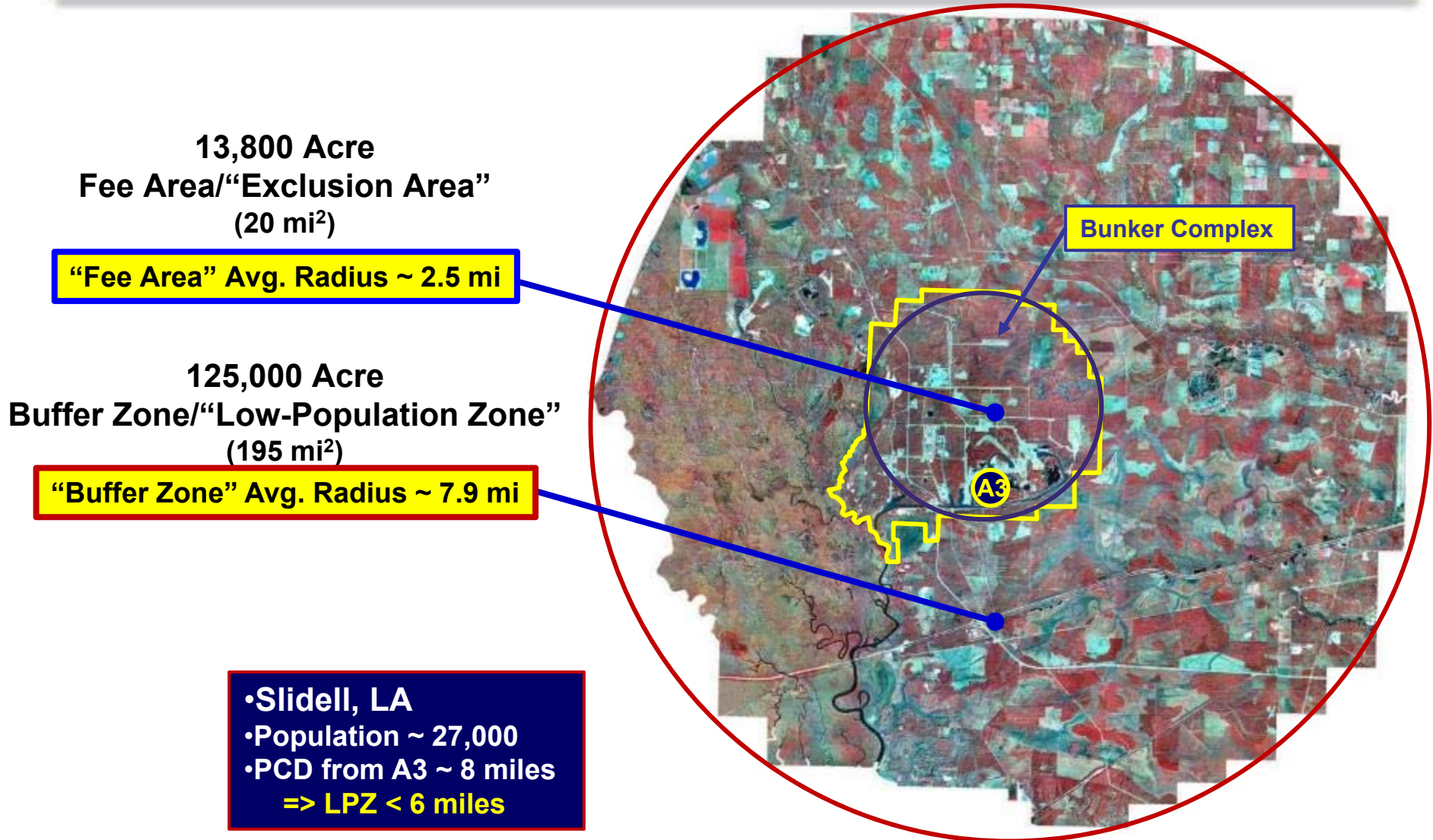

PCD (Population Center Distance ~8 miles) > 1.333 x LPZ ~ 1.333 x 6 miles ~ 8.0 miles

Ref.: NRC Regulatory Guide 4.7



# Optimize Shielding Approach for Multiple Purposes

- Baseline approach: External shield for neutron and gamma shielding
  - Potentially  $\sim 1$  mT / engine
  - Mitigates potential of nucleate boiling within propellant tank
- Consider: No external shield
  - Energy absorbed by propellant is used to help autogenously pressurize tank
    - Constant pressure requires 290 W of latent heat of vaporization / 1 MW reactor power
  - Challenge is to effectively harness energy so that it goes directly into heat of vaporization of propellant
    - May not require any modifications to standard tank design
- Use boost pump to maintain desired turbopump inlet conditions

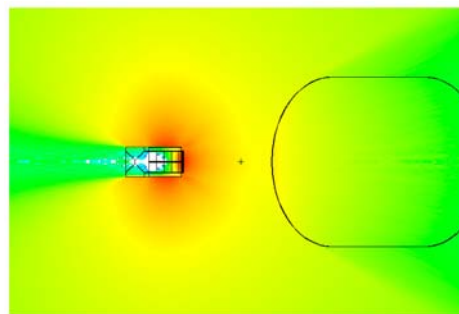

Example of Radiation Flux without External Shield

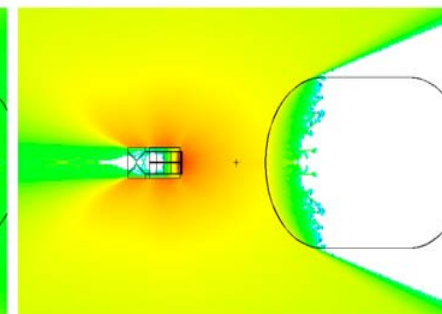

Example of Radiation Flux with External Shield

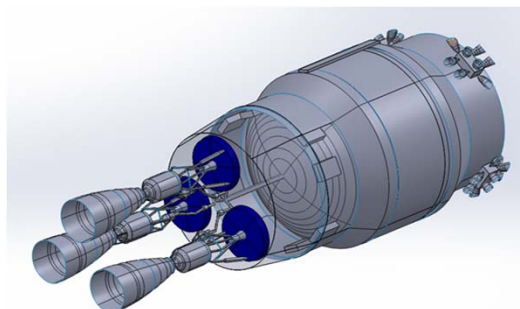

Engine Configurations with External Shields

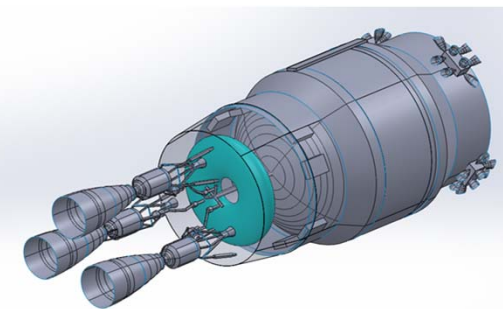

Engine Configuration with Secondary Pressurization Tank





# Transitioning Shielding Mass from Inert Weight to ECLSS Water

- Mass reduction in the habitat strains water reclamation requirements
  - Pushes technology requirements of ECLSS system
- External shield mass allocation may be transitioned to useable water for the ECLSS system
  - Serves as a radiation “storm” shelter
  - Reduces water reclamation requirement
- Water reclamation requirement may be reduced from  $>0.95$  to  $<0.65$

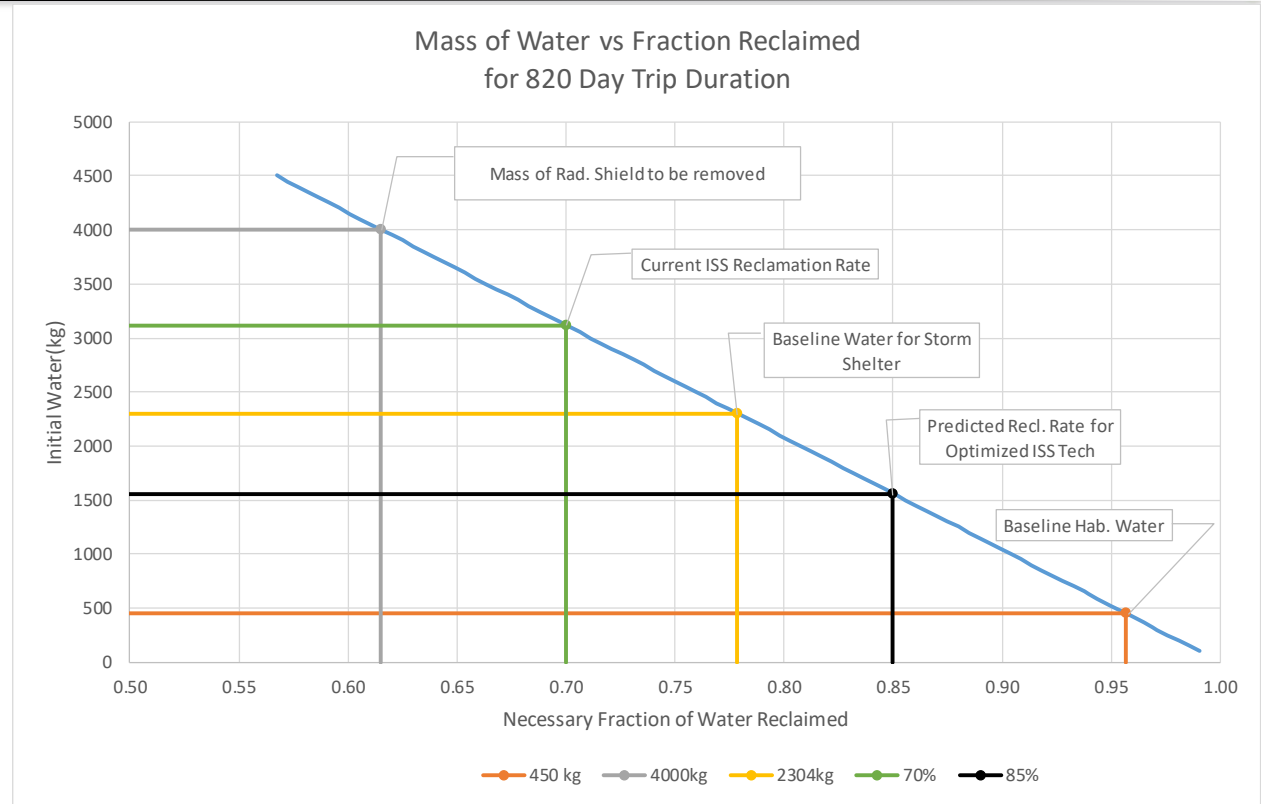

#### References:

- Simon, Molly et al. “NASA’s Advanced Exploration Systems Mars Transit Habitat Refinement Point of Departure Design.” 38th 2017 IEEE Aerospace Conference; 4-11 Mar. 2017; Big Sky, MT; United States
- Curley, Su et al. “Deep Space Habitat ECLSS Design Concept.” 42nd International Conference on Environmental Systems; 15-19 Jul. 2010; San Diego, CA; United States

Changing the neutron and gamma shielding approach to a “storm” shelter has the added benefit of reducing water reclamation requirements in the crew habitat.





# Boost Pumps Condition the Propellant

- Autogenous pressurization may not be able to maintain steady state pressure of the tank
  - Analysis indicates a drop of ~12 psia during longest burn
  - Boost pump brings propellant back up to turbopump inlet conditions
  - Allows some saturated vapor to exit from the main propellant tank (risk mitigation to nucleate boiling)
- Investigating electric or hydraulic options
  - May have relatively small impact to system mass
  - May add additional approach to engine control

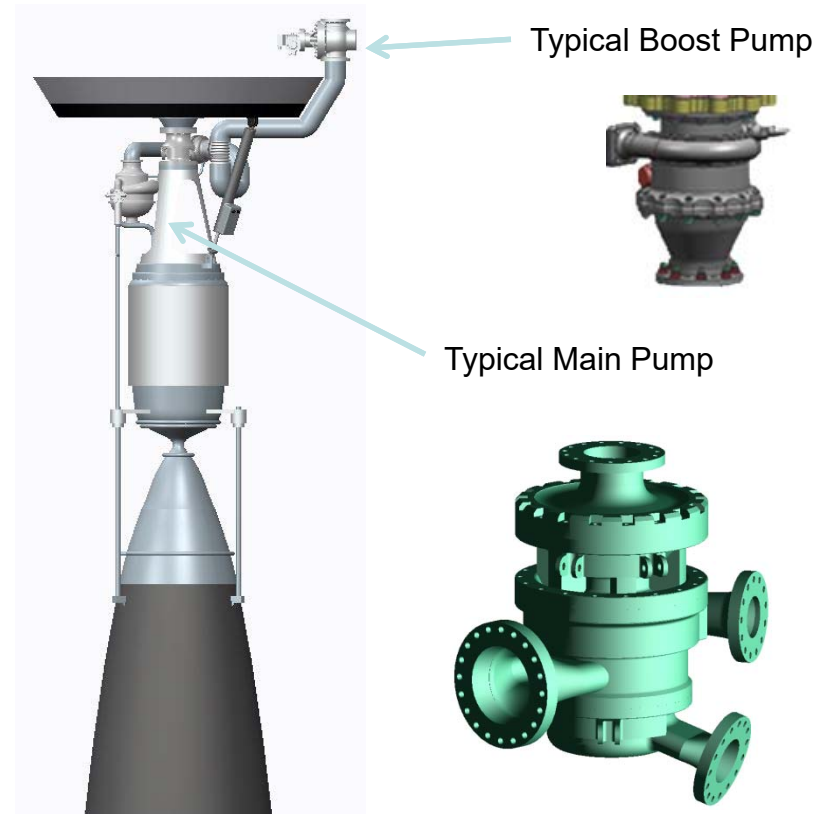

Introduction of a boost pump prior to main turbo pump allows for a wider range of propellant outlet conditions from the propellant tank.





# Can NTP systems using Low-Enriched Uranium (LEU) be Developed?

---

- Directly reduce cost through savings related to safeguards and security
- Indirectly (and more significantly) reduced cost through enabling use of an optimal development approach and team
- Consistent with ongoing programs to convert operational Highly Enriched Uranium (HEU) systems to LEU
- Consistent with US policy. “The United States is committed to eliminating the use of HEU in all civilian applications, including in the production of medical radioisotopes, because of its direct significance for potential use in nuclear weapons, acts of nuclear terrorism, or other malevolent purposes.” (2012 White House “Fact Sheet”)

**Initial LEU Conceptual Designs Very Promising**

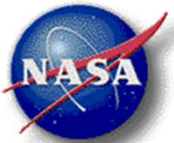

# LEU Fission System Considerations

---

- Greatly reduced safeguards considerations if LEU is used. US encourages use of LEU in nuclear programs around the world.
- No uniquely hazardous materials in fission systems prior to operation. LEU toxicity comparable to depleted uranium. Depleted uranium used in shielding for industrial radiography cameras, trim weights in aircraft (up to 1500 kg in Boeing 747-100), sailboat keels, ammunition, armor plating, etc. Beryllium used in most modern spacecraft. James Webb telescope contains ~300 lbs of beryllium.
- Primary potential hazard from space fission systems is inadvertent criticality while personnel are in very close proximity (i.e. ground processing). Highly affected radius is  $< 10$  m. System design and procedures for precluding inadvertent criticality during ground processing can be made independent of launch vehicle specifics.
- For criticality (with significant fissions) to occur during a launch failure the system must remain geometrically intact while safety mechanisms are simultaneously removed. Designs to preclude this can be made independent of launch vehicle specifics.





# Fission Has Tremendous Growth Potential

- The first flight of a modern space fission system will be a tremendous first step towards the development and utilization of highly advanced space fission systems (analogous to DC-3 helping enable SR-71)
- Advanced fission systems include potential options for liquid, gas, or plasma core reactors (very high performance)
- Advanced NTP systems could potentially use any volatile as propellant
  - Move asteroids or Kuiper Belt objects using volatiles from the object as propellant?
  - Combination of NTP and gravity assists to relocate objects anywhere in solar system?
  - Refueling depots? Terraforming?





# Technology Advances Could Help Enable Extremely Advanced Propulsion Systems

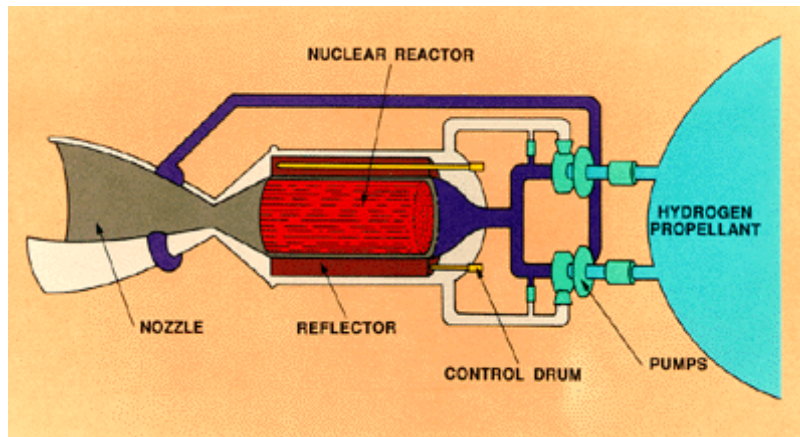

SOLID CORE NUCLEAR ROCKET

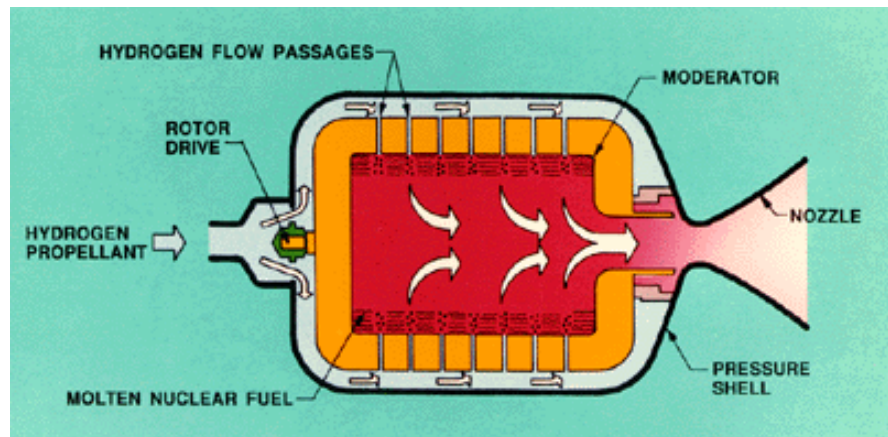

LIQUID CORE NUCLEAR ROCKET

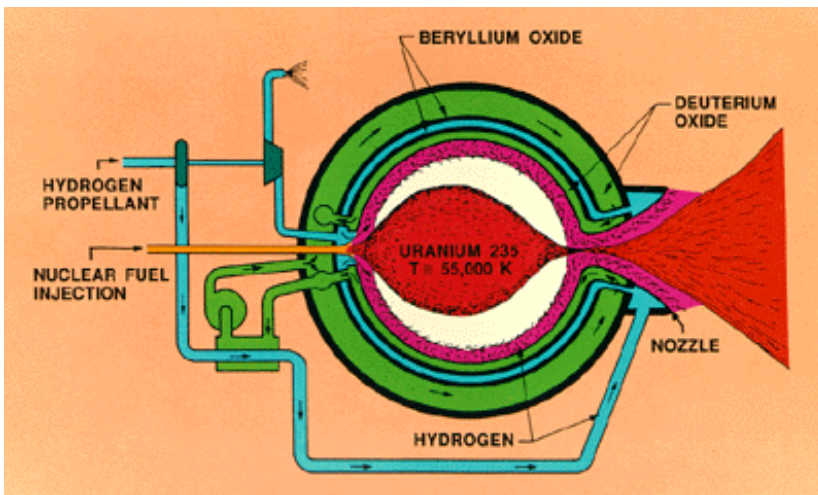

Open-Cycle Gas Core Nuclear Rocket

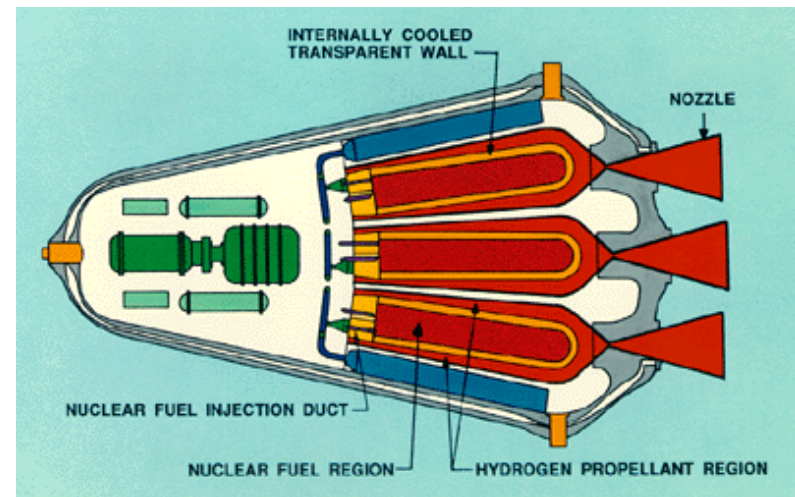

Closed-Cycle Gas Core Nuclear Rocket



# Fission Can Provide the Energy for Either Nuclear Thermal or Nuclear Electric Propulsion Systems

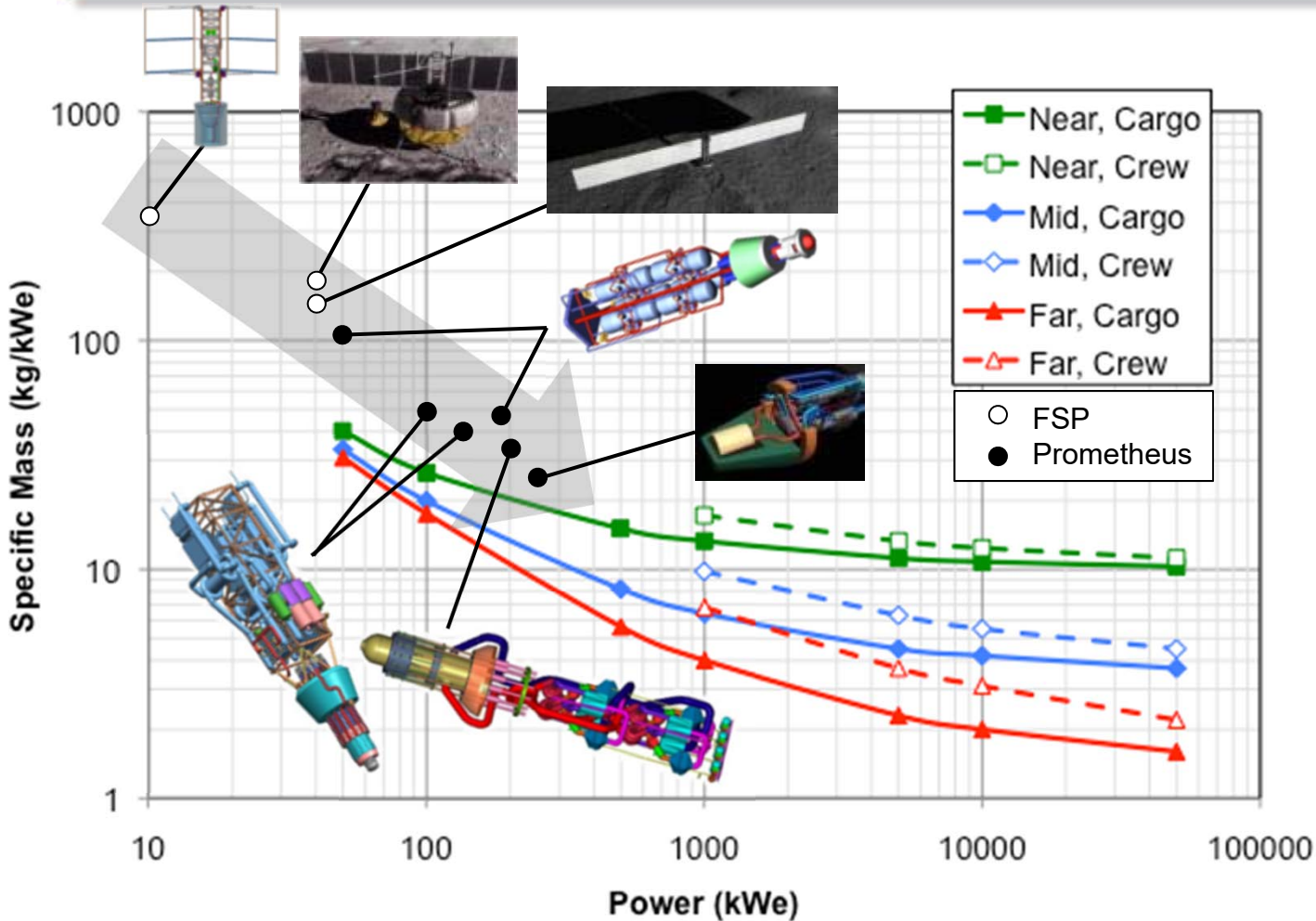

- NEP Power System Performance Projections from 2001 STAIF Conference
- Fission Surface Power and Prometheus Concepts Superimposed

Near=Liq Metal Rx, Brayton, 1300K, 6 kg/m<sup>2</sup>, 200 Vac (Available ~10 yrs)  
 Mid=Liq Metal Rx, Brayton, 1500K, 3 kg/m<sup>2</sup>, 1000 Vac (Available ~ 15-20 yrs)  
 Far=Liq Metal Rx, Brayton, 2000K, 1.5 kg/m<sup>2</sup>, 5000 Vac (Available ~ 25-30 yrs)  
 Cargo=Instrument rated shielding, 1.6x10<sup>15</sup> nvt, 1.2x10<sup>8</sup> rad @ 2 m  
 Crew=Human rated shielding, 5 rem/yr @ 100 m, 7.5° half angle

Chart courtesy  
 Lee Mason,  
 NASA GRC



# What is Kilopower?

- Small and simple approach for long-duration, sun-independent electric power for space or extra-terrestrial surfaces
  - Produces from 1 to 10 kilowatts, continuously for 10 years or more
  - Weighs about 400 kg at 1 kW or 1500 kg at 10 kW, for complete system
  - Uses solid, cast uranium-235 reactor core, about the size of a paper towel roll
  - Transfers reactor heat with passive sodium heat pipes
  - Converts heat to electricity with high efficiency Stirling engines
  - Leverages current DOE fuel production processes and abundant material supply from dismantled nuclear weapons
  - Launches as a radiologically benign, non-operating (cold) payload
- Represents NASA's first attempt at building and testing a REAL space reactor since the 1960s SNAP Program

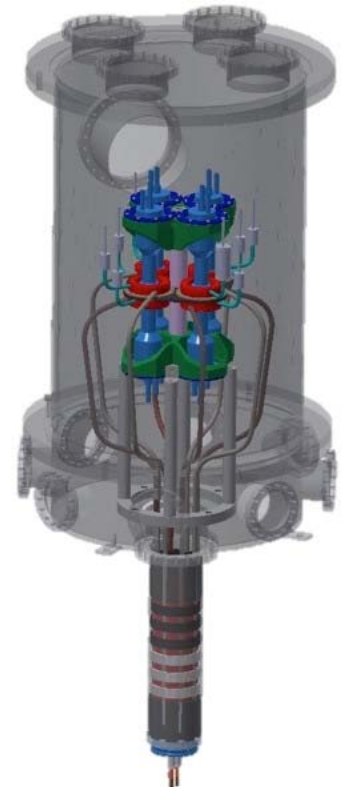

Chart courtesy Lee Mason, NASA GRC



# Nuclear Test Assembly



Chart courtesy Lee Mason, NASA GRC

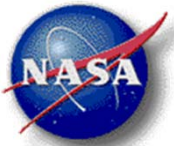

# Design Configuration & Shielding

The Emplaced option uses regolith shielding to reduce mass and permit near outpost siting. The Landed option reduces the reliance on crew and equipment for installation.

Ref.

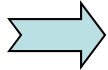

## Emplaced Configuration

Off-Loaded from Lander  
Below-Grade, Axial Shield  
Augmented by Lunar Regolith  
<5 rem/yr at 100 m (360° )  
Boom Deployed Radiator  
400 V Power Transmission

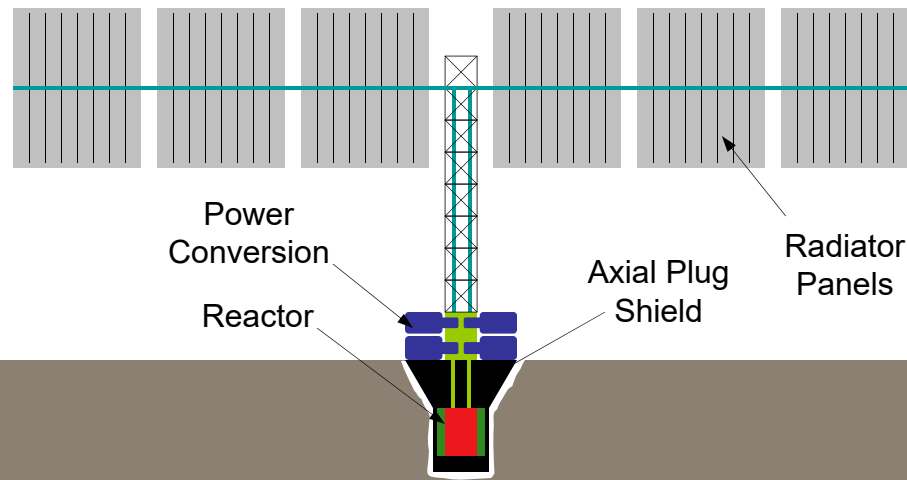

Option

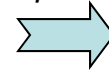

## Landed Configuration

Dedicated Lander  
Above-Grade, Shaped 4-Pi Shield  
<5 rem/yr at 1 km (Habitat Area)  
<50 rem/yr at 1 km (Non-Habitat)  
Boom Deployed Radiator  
2 kV Power Transmission

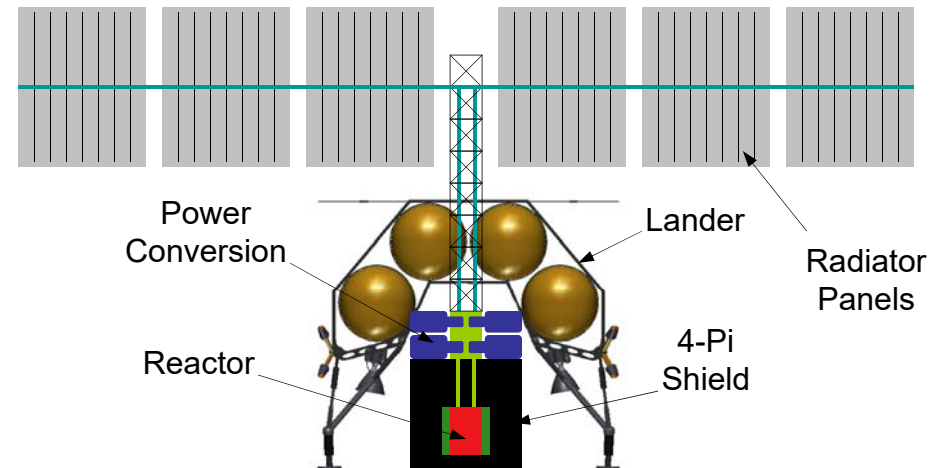

Chart courtesy  
Lee Mason,  
NASA GRC



# Shielding Comparison

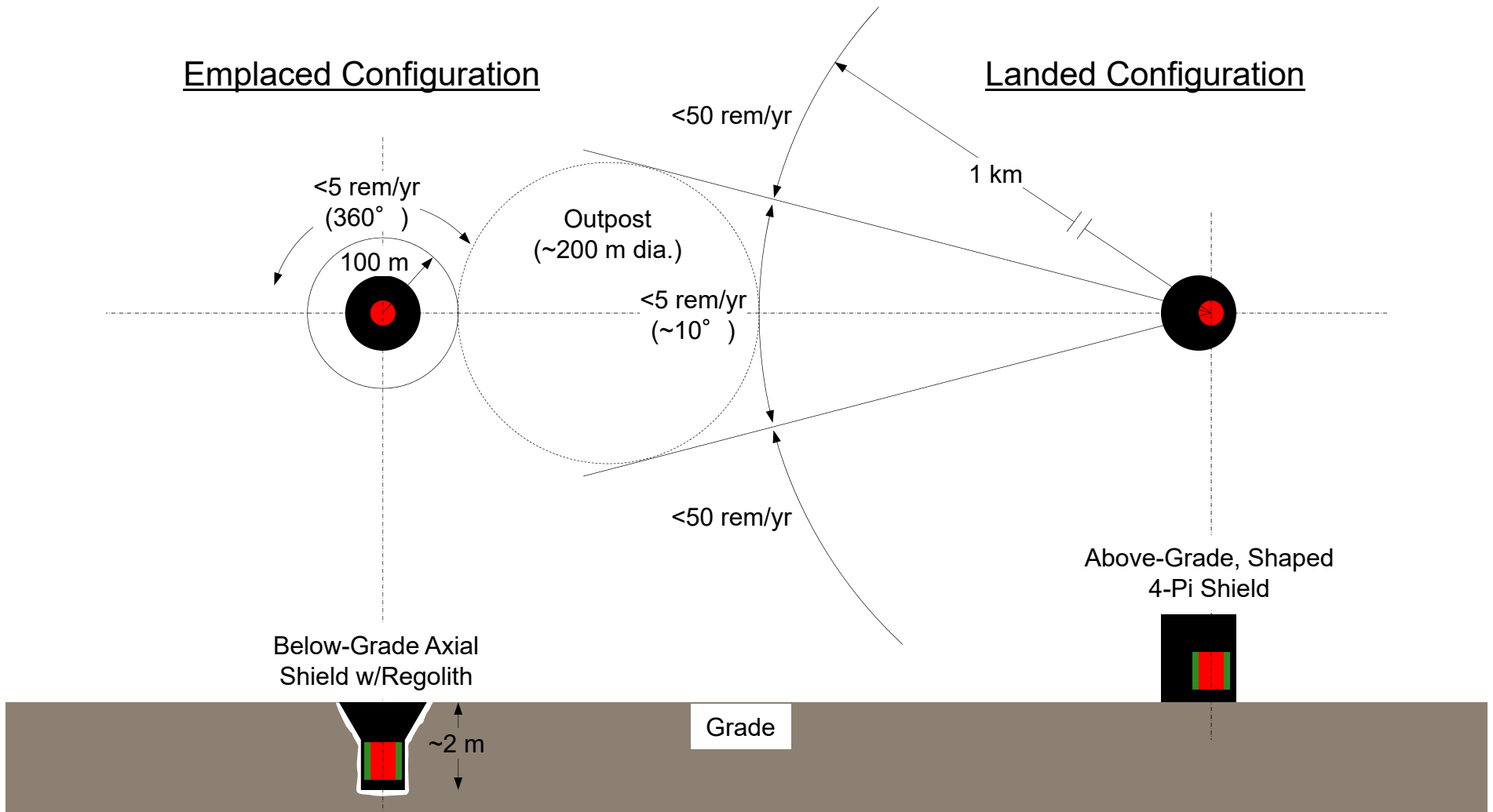
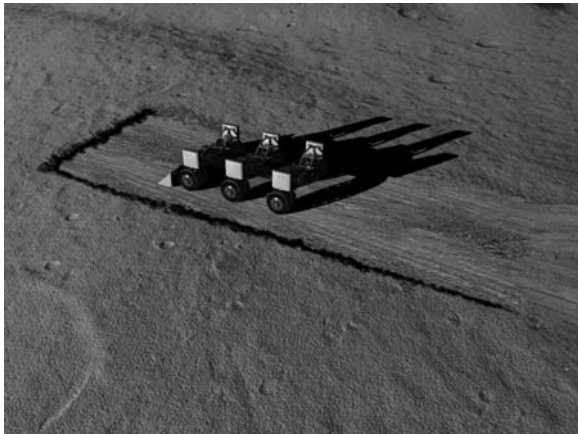

Chart courtesy  
Lee Mason,  
NASA GRC



# FSPS Installation (Lunar Architecture Team)



1. Site Selection

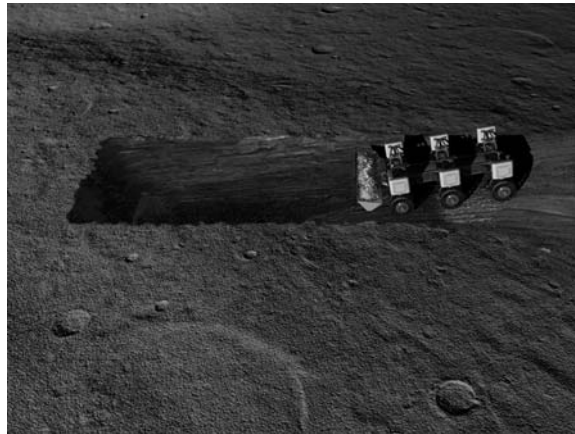

2. Excavation

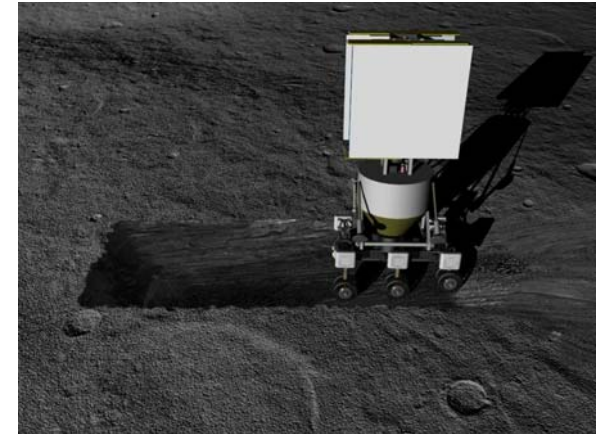

3. Delivery

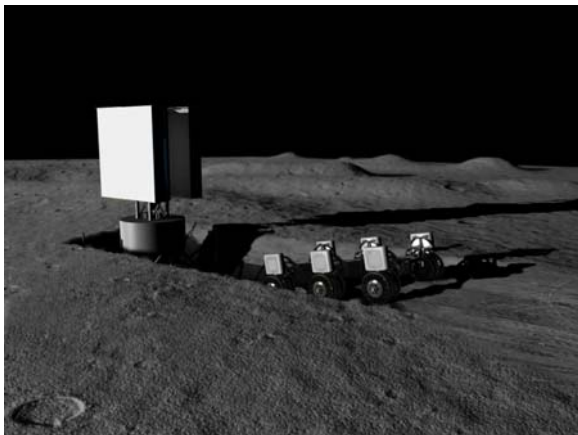

4. Emplacement

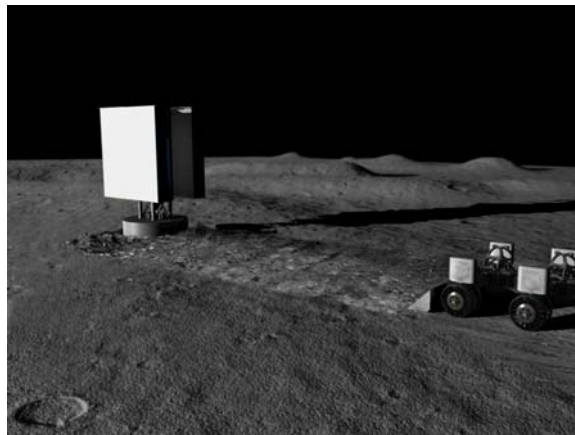

5. Back-filling

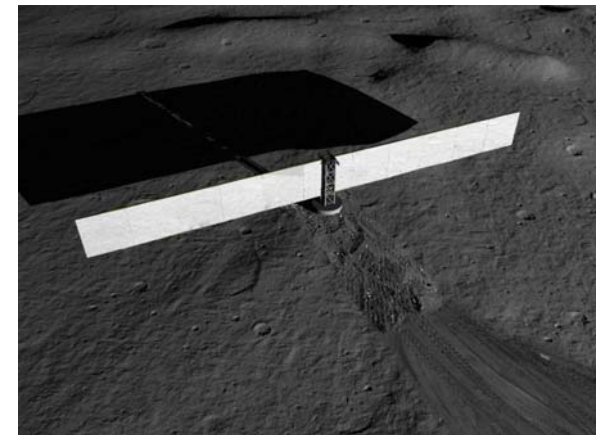

6. Startup

Chart courtesy Lee Mason, NASA GRC





# Observations

---

- Space fission power and propulsion systems are game changing technologies for space exploration.
- First generation NTP systems could provide significant benefits to sustained human Mars exploration and other missions.
  - Potential for Earth-Mars transit times of 120 days; 540 day total Mars mission times; reduced crew health effects from cosmic radiation and exposure to microgravity; robust Mars architectures including abort capability.
  - Faster response times, improved capability, and reduced cost for cis-lunar operations. NTP derivatives could enable very high power systems on lunar surface (ISRU) and in space.
- Advanced space fission power and propulsion systems could enable extremely ambitious space exploration and development.



# Backup

---



# Space Technology Mission Directorate (STMD) Game Changing Development (GCD) Program Nuclear Thermal Propulsion (NTP) Project Overview

Project Manager: Sonny Mitchell, NASA MSFC

## Project Objective:

Determine the feasibility and affordability of a Low Enriched Uranium (LEU)-based NTP engine with solid cost and schedule confidence

## Approach:

- Evaluate the implications of using LEU fuel on NTP engine design
- Fuel element, reactor, and engine conceptual designs and feasibility analyses
- Mature critical technologies associated with LEU fuel element materials & manufacturing
- Develop an exhaust capture method to facilitate ground testing
- Develop relevant cryogenic propellant management technologies

## Roles and Responsibilities

- **MSFC:** PM, SE & Analysis Lead, Cryo ConOps Lead, FE Testing
- **GRC:** Cryocooler Testing, Cryo ConOps Support, Sys. Analysis Support
- **SSC:** Rocket Exhaust Capture System Subscale (RECSS)
- **KSC:** Ground Processing ConOps / Propellant Densification
- **Aerojet Rocketdyne:** LEU Engine Analysis
- **AMA:** Engine Cost Lead
- **Aerospace:** Engine Cost Independent Review
- **BWXT:** Fuel Element (FE) / Reactor Design/Fabrication
- **DOE:** FE / Reactor Design and Fabrication Support

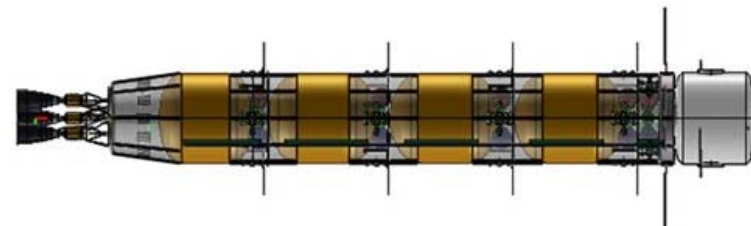
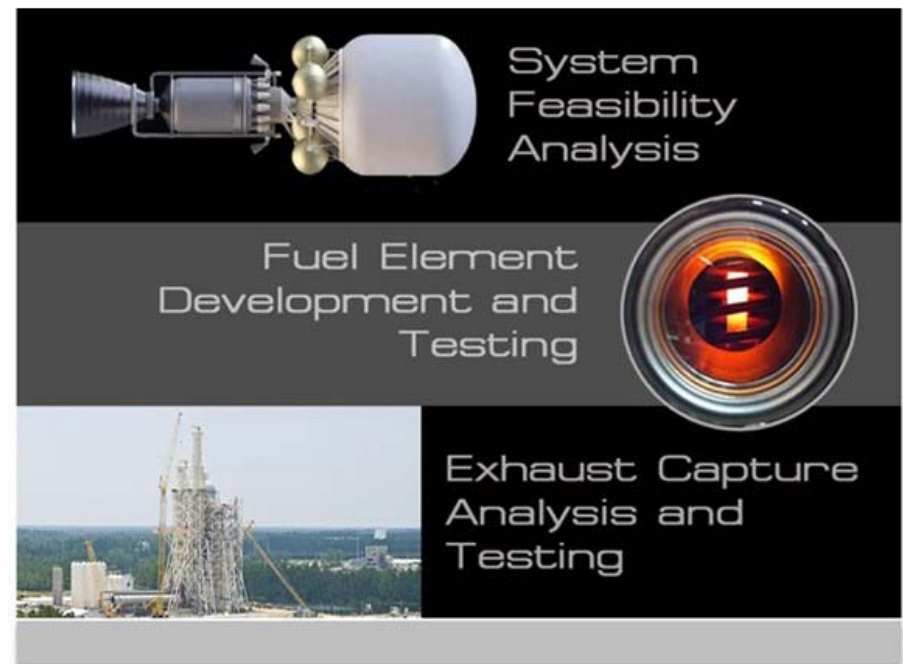
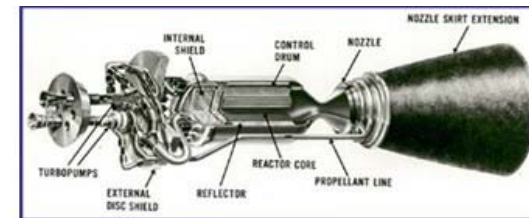

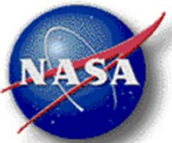

# CFEET Segment Test

- Completed successful test of the first fuel element (FE) specimen, C0, in the MSFC Compact Fuel Element Environmental Tester (CFEET) on 8/9/18
  - C0 specimen was a pathfinder for FE fabrication techniques
  - C0 was a 0.75 inch hexagonal “can” with solid laser-welded end caps filled with a surrogate powder
  - Reached the specimen target temperature of 2200K with a hold time of 20 minutes.
  - Next test of the specimen is planned to reach a temperature of 2400K

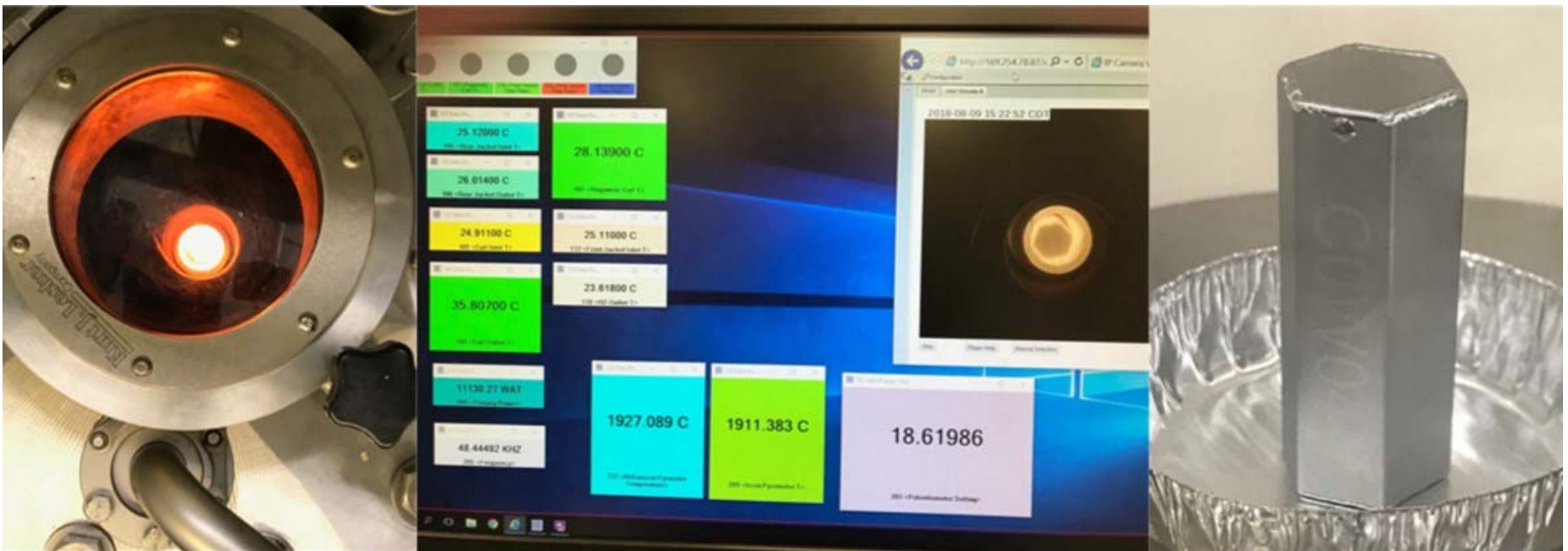



# Reactor Energy for Hot H<sub>2</sub> Orbital Maneuvering

- Leveraged for Mars and Earth Sphere of Influence
  - E.g. NRHO to LDRO, Mars plane changes
- Hydrogen flow path through existing tie tubes
  - Integrates with core without changing fuel element or tie tubes
  - Additional valves on tie tube circuit
- Performance exceeds storable bi-propellant
  - Isp = ~500s
  - Benefit of removing mass and overhead of bi-propellant systems
- Investigating approaches to leverage hot H<sub>2</sub> for RCS, e.g. attitude control
- Including heat exchanger provides potential for power generation.

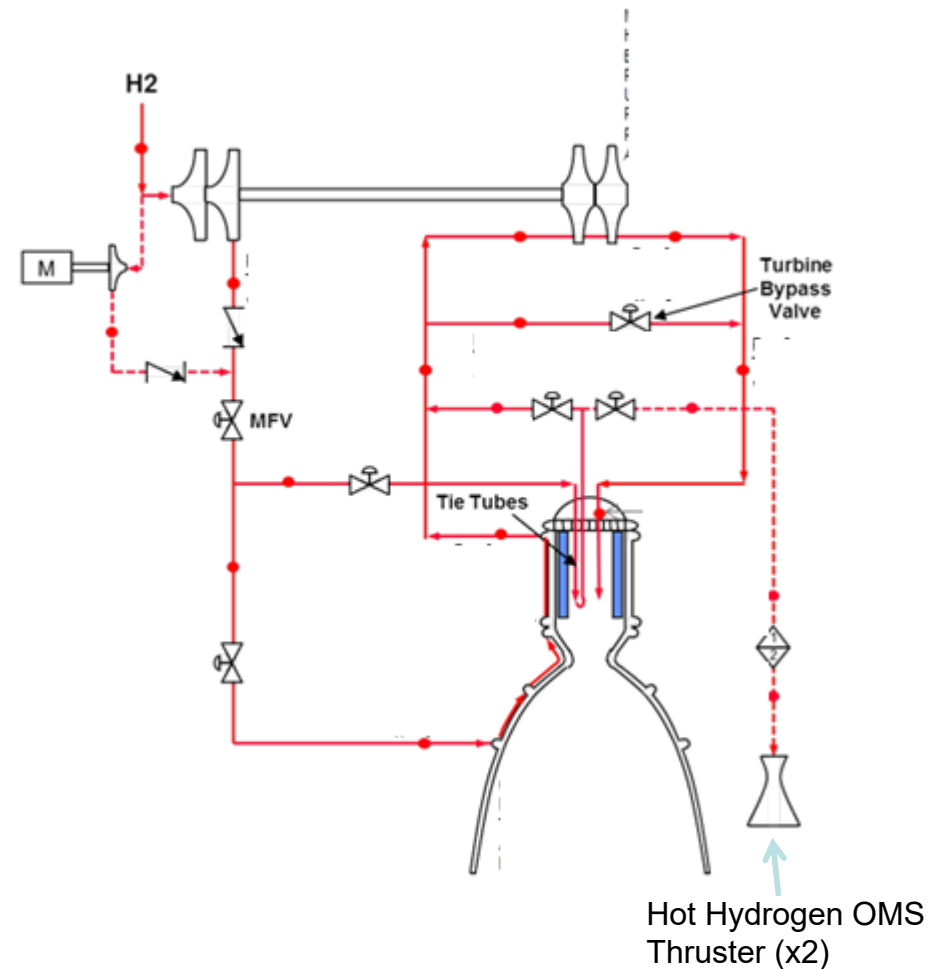

The low molecular weight of hydrogen combined with the superfluous power of NTP creates an opportunity for low-impulse orbital maneuvering.





# Evaluating New Mission Architectures

- Reduce staging orbit from LDHEO / LDRO to 407x13,400 km
  - Provides 68.5 mT vehicles with 8.4m SLS fairing
- Consider staging of in-line tanks at Mars
- Reduction in trip time reduces radiation exposure
- Evaluation of orbital debris and thermal environmental impacts pending

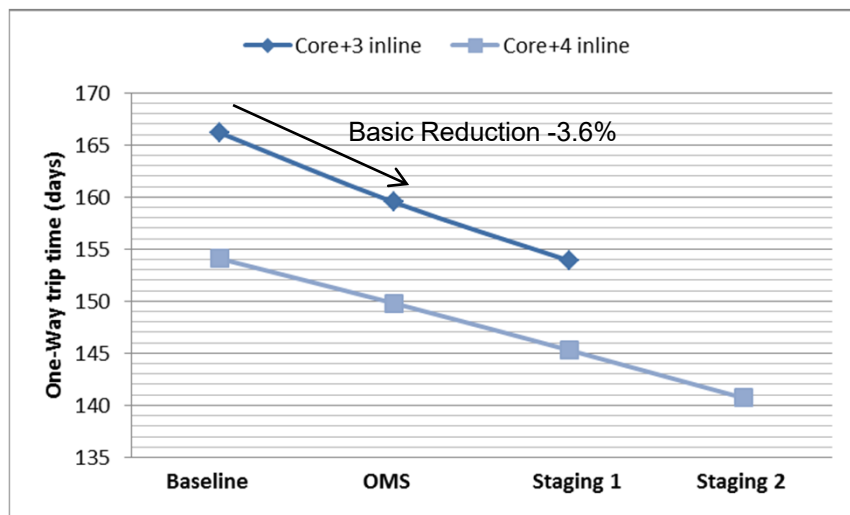
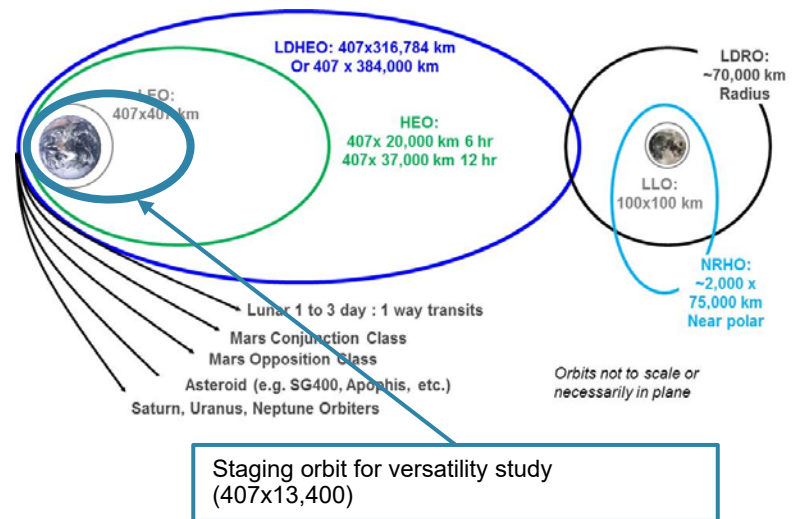

Baseline PoD 45 mT Stage Vehicle  
JANNAF In-Space Chemical Propulsion TIM

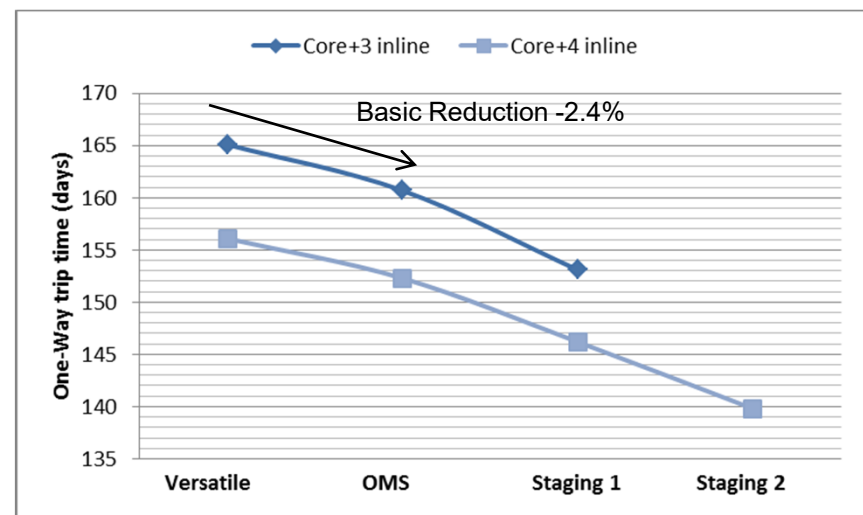

Versatile 68.5 mT Stage Vehicle





# Opposition Class Mission Architectures

- Reduced systems (higher prop) mass fraction and performance enables greater delta-V
- Some opposition class missions are achievable
  - Core + 3 or 4 inline stages (68.5 mT wet mass) or
  - Staging, e.g., leaving, stages at Mars provides additional capability

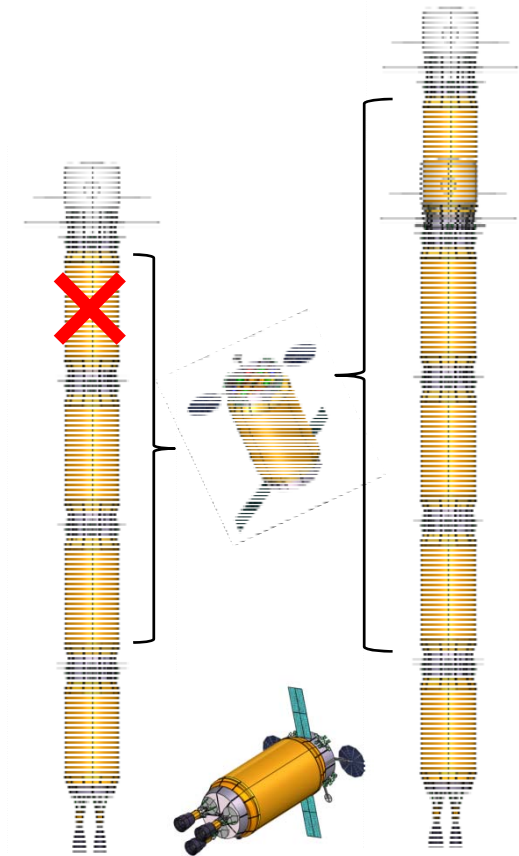
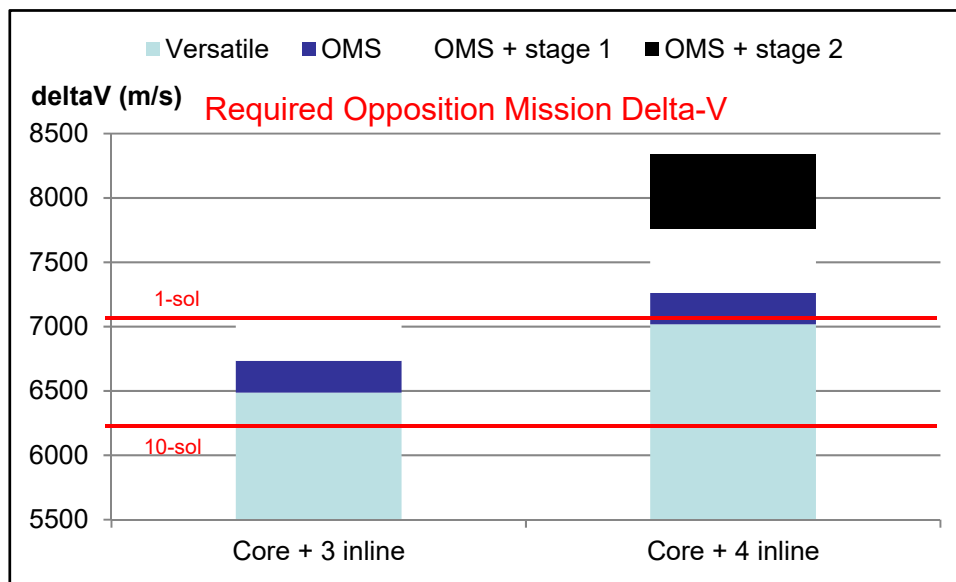

68.5 mT Versatile Stage Elements

Versatile NTP may enable “short” stay opposition class mission architectures.

