

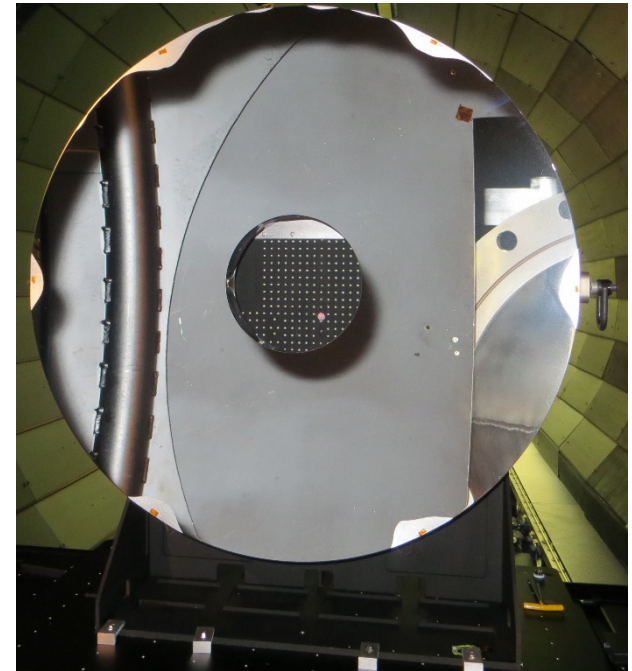

Future space telescope development at NASA

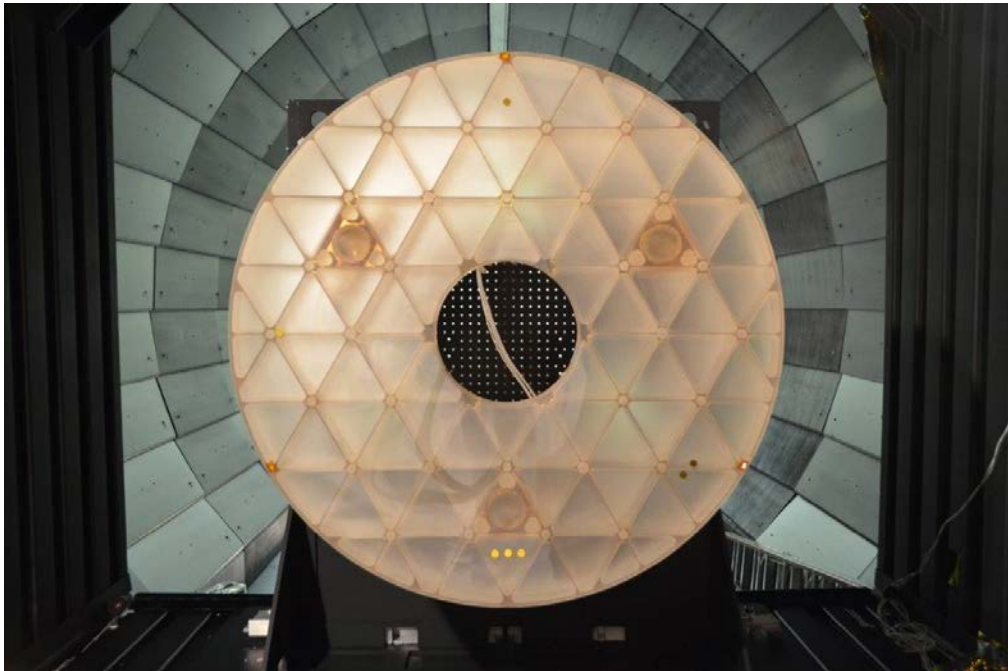

Ron Eng

Optics and Imaging Branch

NASA Marshall Space Flight Center

Korean Space Science Society (KSSS) 2018 fall conference



NASA Marshall Space Flight Center

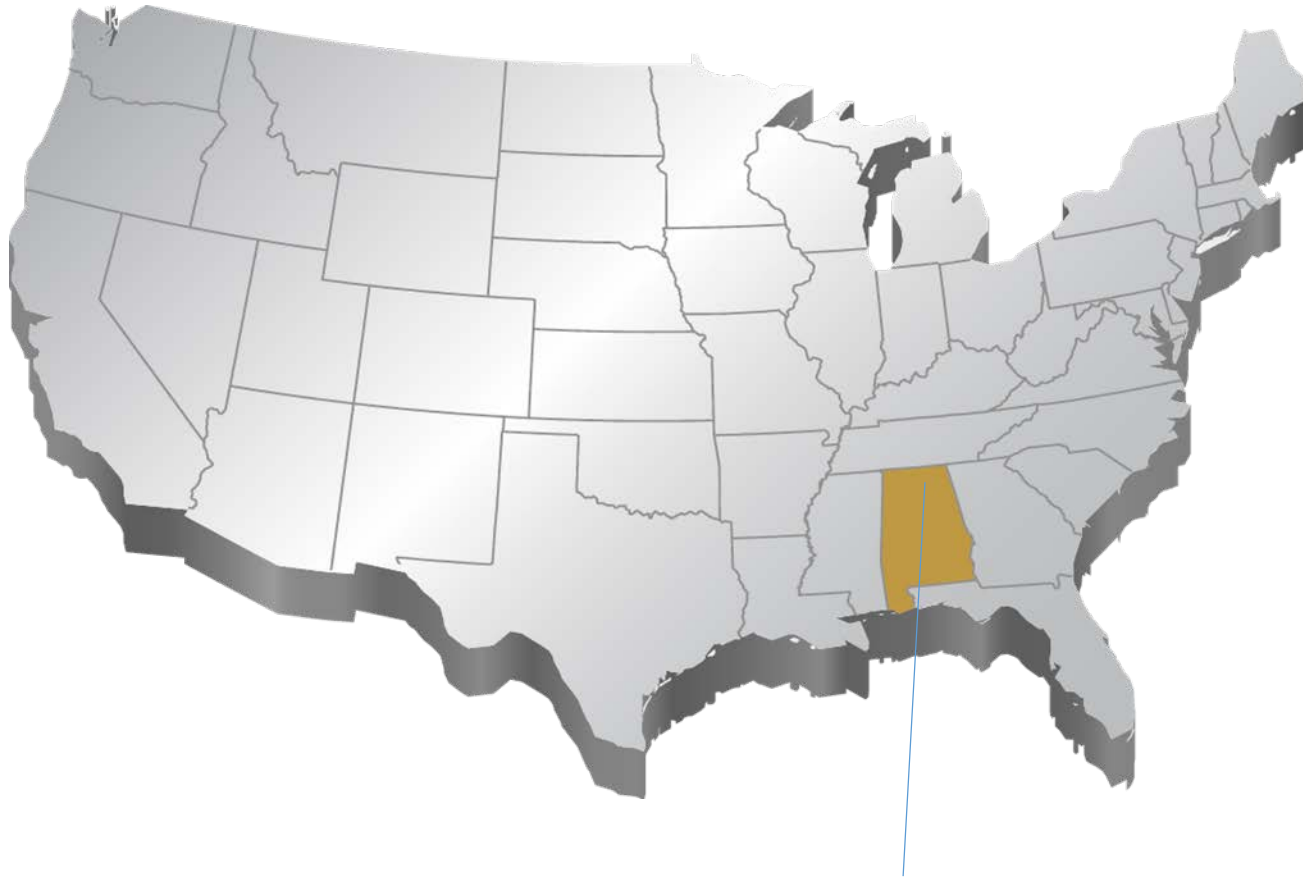

Marshall Space Flight Center
Space Transportation, Propulsion Systems, Space Systems, and Science
Huntsville, Alabama



Space Transportation, Propulsion Systems





High Energy Astronomy Observatories (1977-1981)

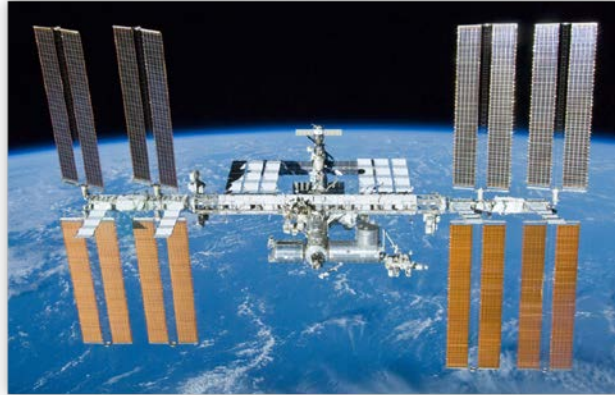

International Space Station (1998-present)

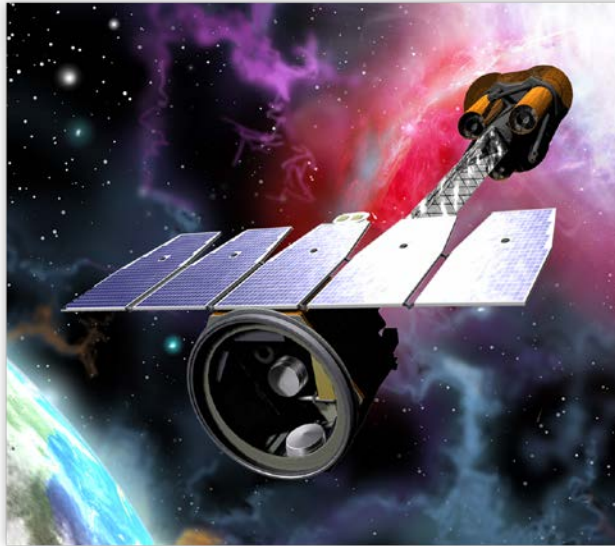

**Imaging X-ray Polarimetry Explorer (IXPE)
Under development**



**Chandra X-Ray Observatory
(1999-present)**



Hubble Space Telescope (1990-present)





Current and planned astrophysics missions





ASTROPHYSICS

Decadal Survey Missions

1972
Decadal Survey
Hubble
4/24/1990

1982
Decadal Survey
Chandra
7/23/1999

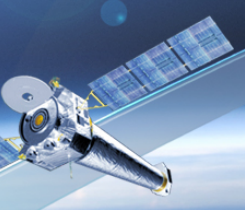
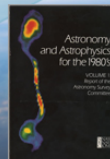

Launch 2003

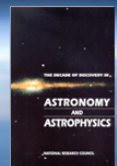

1991
Decadal Survey
Spitzer, SOFIA



2001
Decadal Survey
JWST



2010
Decadal Survey
WFIRST

2021

Mid 2020s



Detecting exoplanet



Imaging exoplanet (a planet orbiting a sun-like star) is a tremendous technological challenge, since the Earth is 10 billion times fainter than the sun. The Cassini wide-angle camera used Saturn as an external occulter to block the sun.

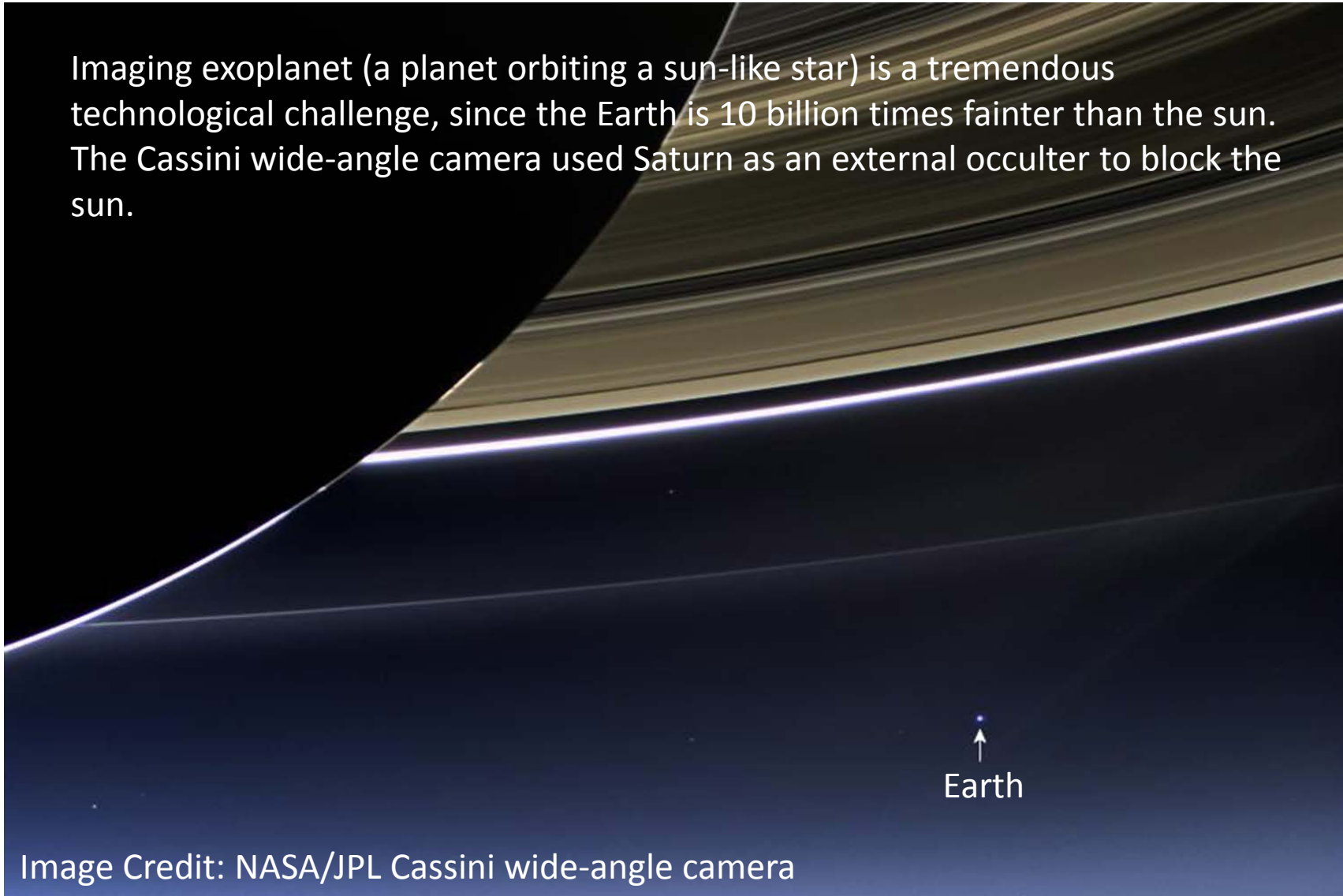
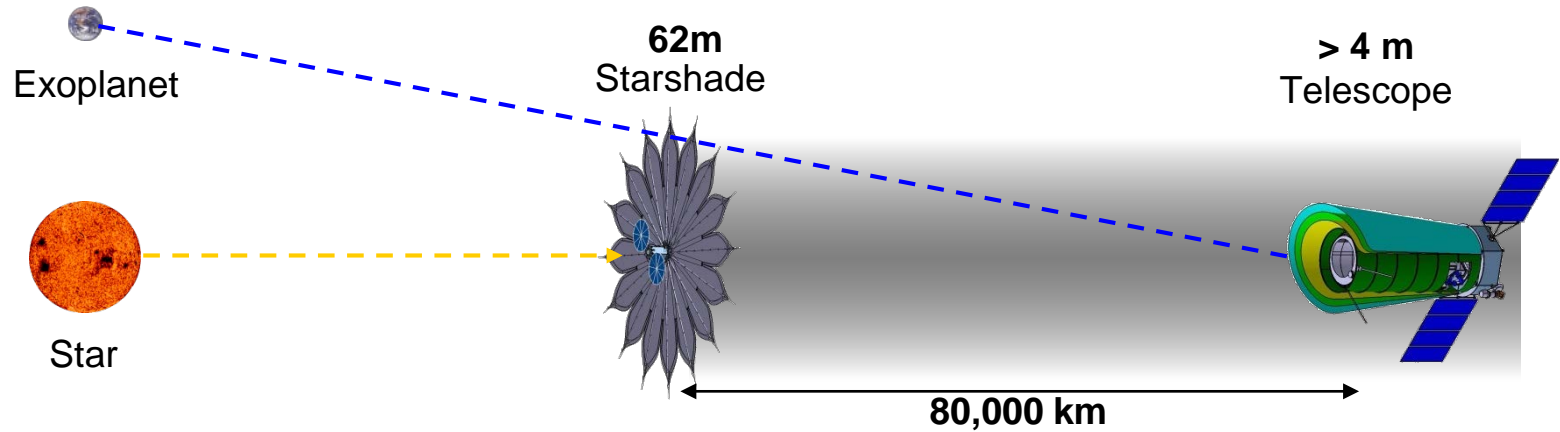
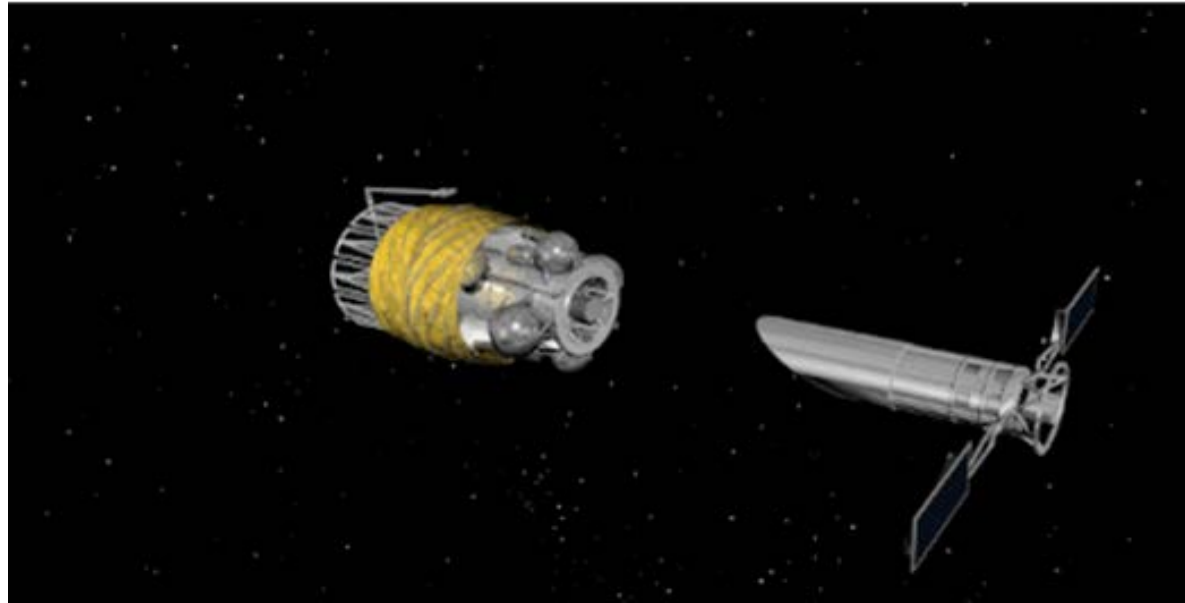

Image Credit: NASA/JPL Cassini wide-angle camera



Direct imaging technique with external starshade





Chandra X-Ray Observatory





X-ray & Cryogenic facility (XRCF)



Large test chamber:

- 7.3 x 22.9 m (O.D. x L) horizontal cylinder
- 6 x 18.3 m (I.D. x L) test volume
- 4.25 x 9.4 m (I.D. x L) Helium shroud
- < 22.5 m ROC without modification
- Up to 30 m ROC with modifications

Cryo shroud enclosure: 320° to 20° K

Refrigeration system: 2 gaseous helium refrigerators; each capable of ~1 kW at 20K.

Vacuum systems: 10⁻⁸ Torr

X-ray source: 527 m guide tube

History

Testing grazing-incidence x-ray telescopes (Chandra, Solar X-ray Imager, Solar B) since 1992.

Cryogenic optical testing of normal incidence, visible & IR optics (JWST) since 1999.

JWST PMSA test configuration

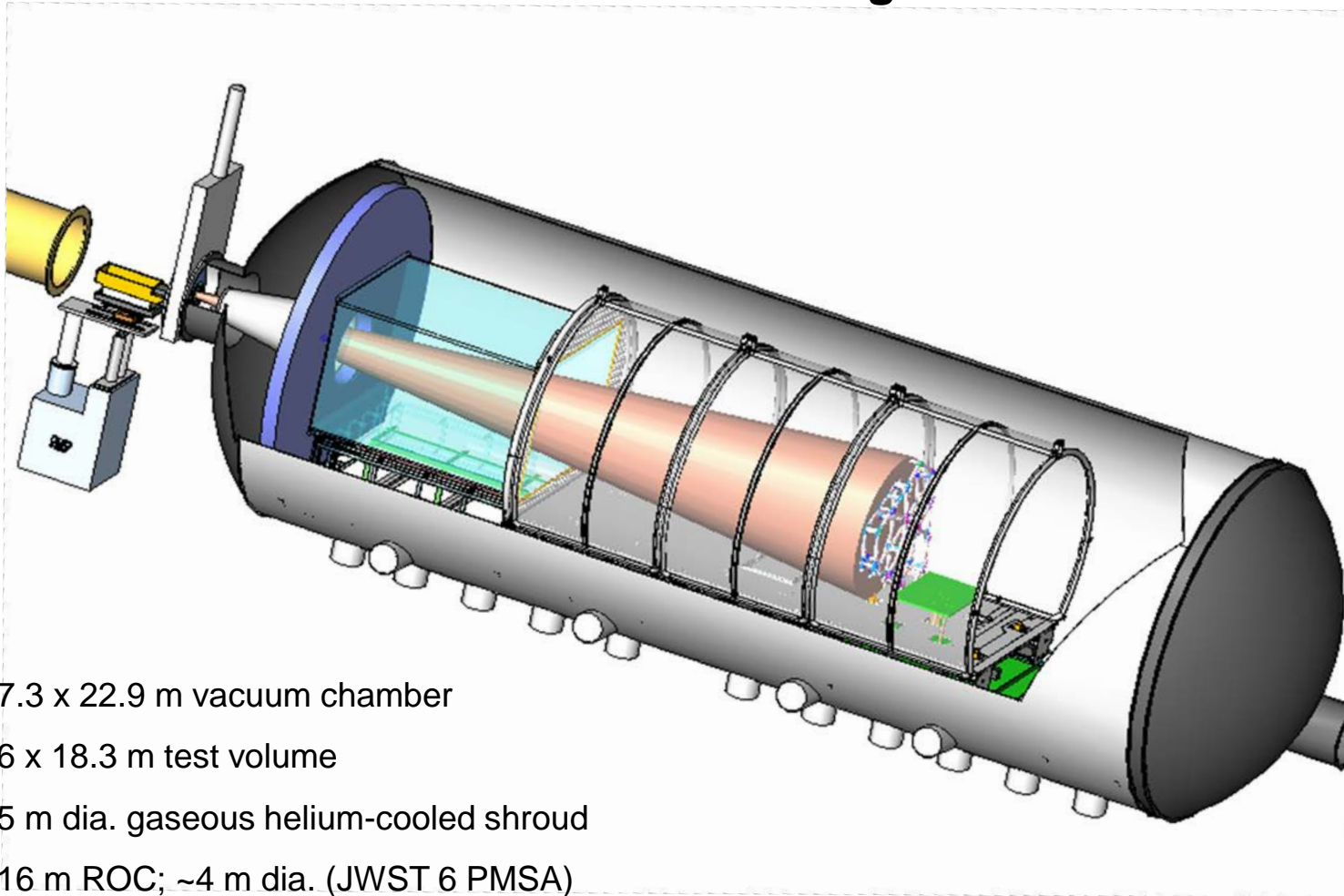

7.3 x 22.9 m vacuum chamber

6 x 18.3 m test volume

5 m dia. gaseous helium-cooled shroud

16 m ROC; ~4 m dia. (JWST 6 PMSA)

2 closed-loop helium cryogenic refrigeration systems <20 deg. K (2 KW capacity)

Existing structure prevents testing mirrors with ROC < 3.5 meters

A pressure tight enclosure (PTE) configuration to test mirror with short ROC < 3.5 meter



XRCF class 2K clean room





James Webb Space Telescope (JWST)

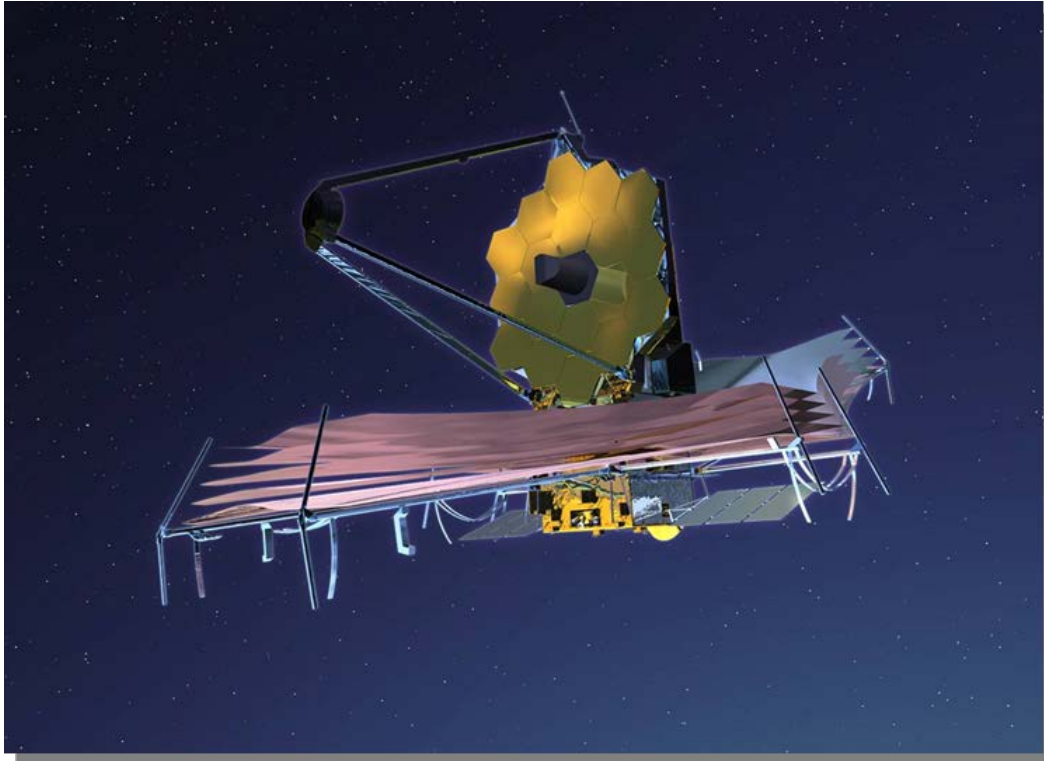

NASA, ESA, and CSA

Planned launch date 3/30/2021

0.6 – 30 microns (visible to mid IR)

4 scientific instruments

6.5m primary mirror

L2 orbit, 1,500,000 km

Science objectives: first light, formation of galaxies, birth of stars and planets, and origin of life.

Technical challenges: deployable segmented telescope and structure, lightweight yet stable optics at 40 degrees Kelvin operational temperature.

James Webb Space Telescope (JWST)

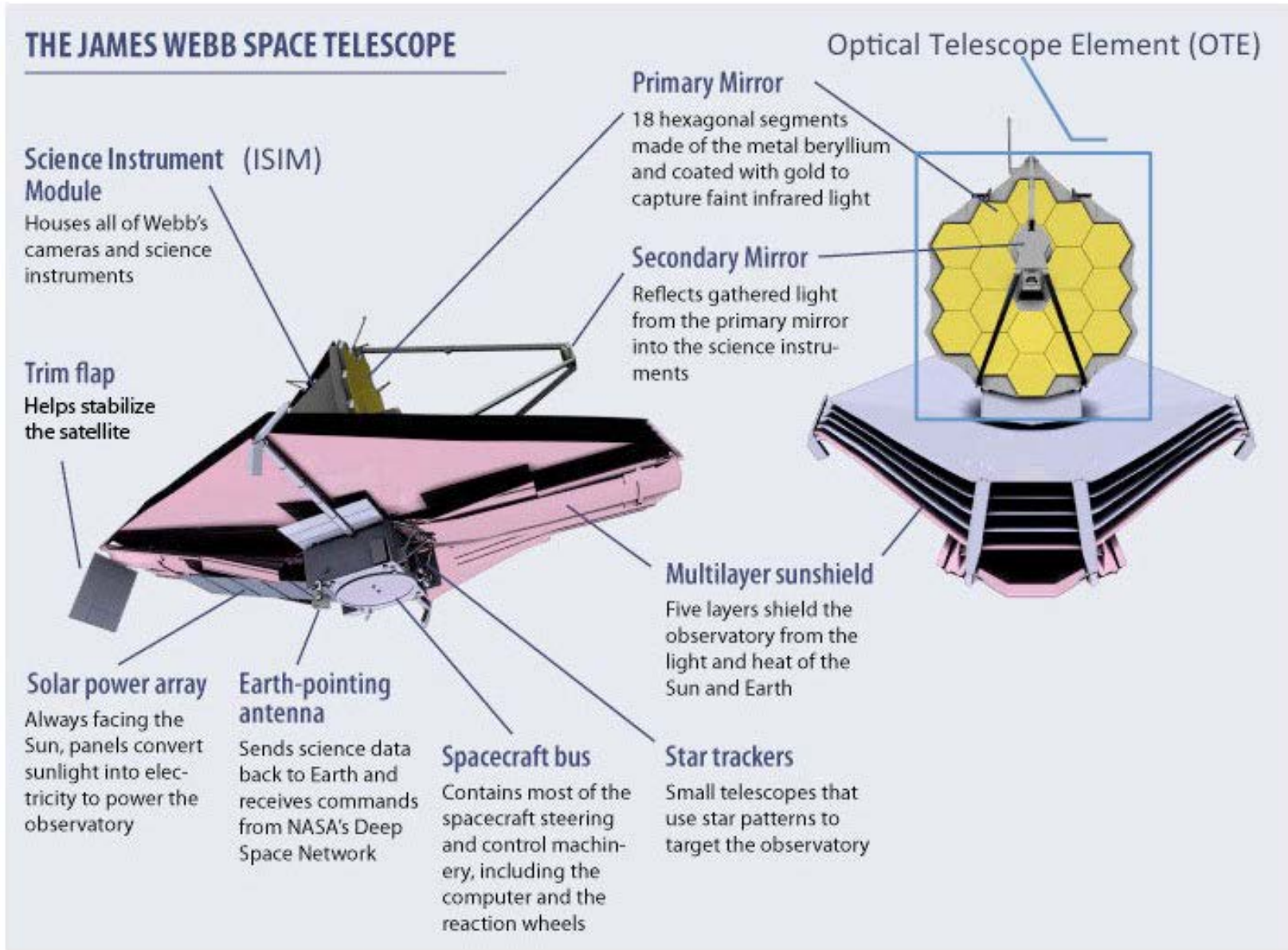



JWST orbit

- ~1,500,000 km from earth vs ~650 km for Hubble
- 30 to 60 deg. K operational temperature

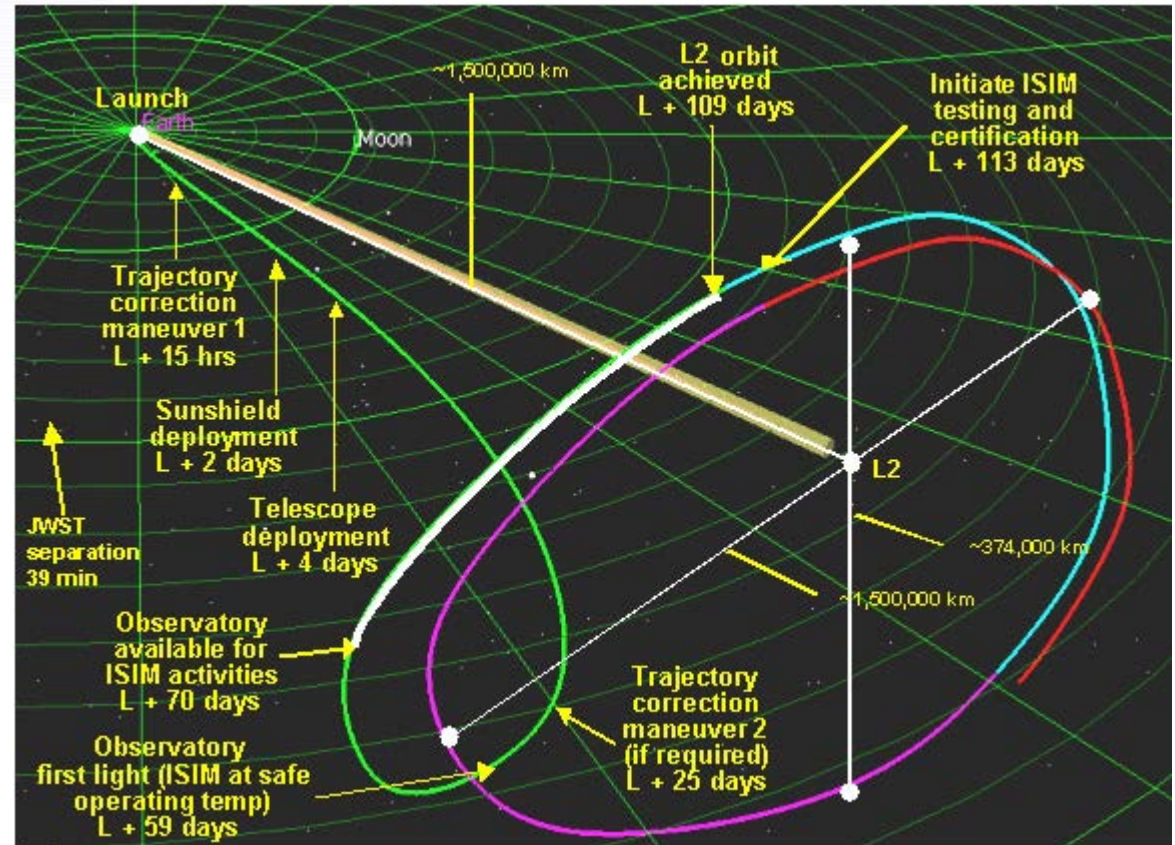
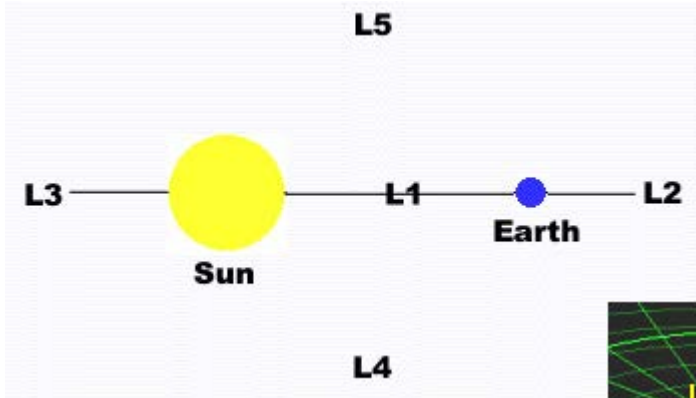



HST & JWST primary mirror comparison

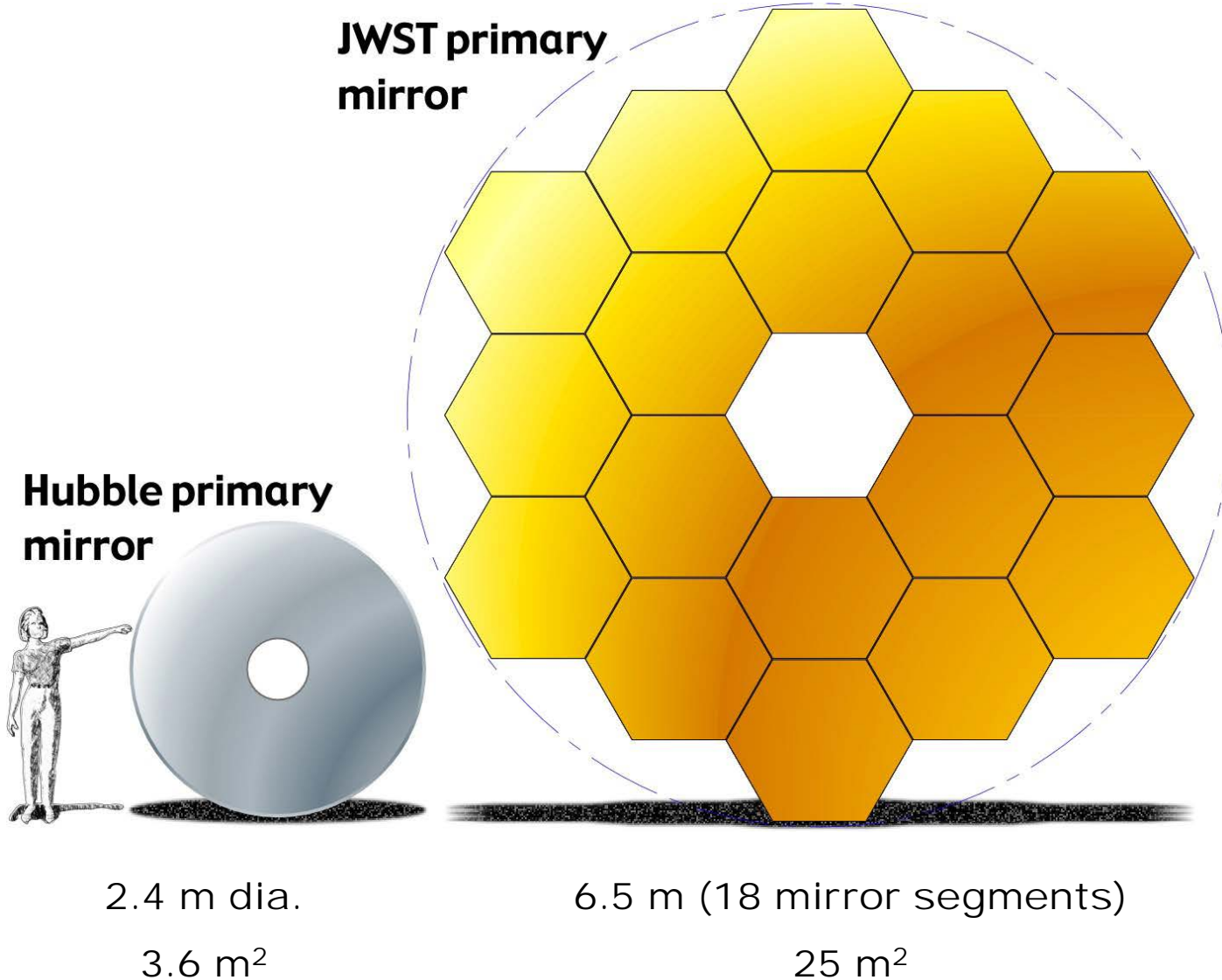



6 of 18 mirror segments cryo test at MSFC

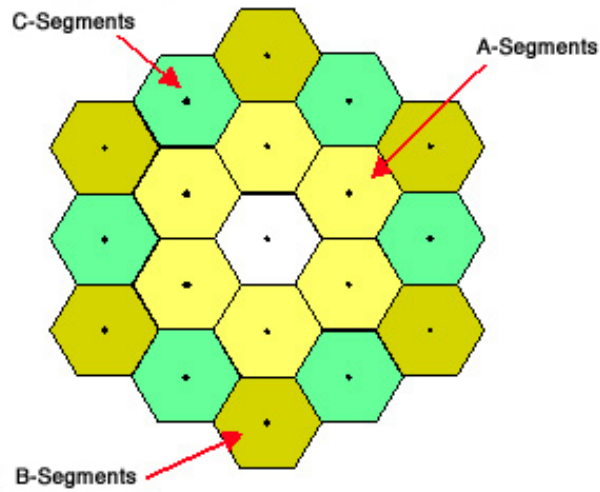

OTE deployment test at GSFC





OTE cryo test at JSC



Oct 24-26, 2018

KSSS 2018 fall conference

19



JWST mirror optical test instrument

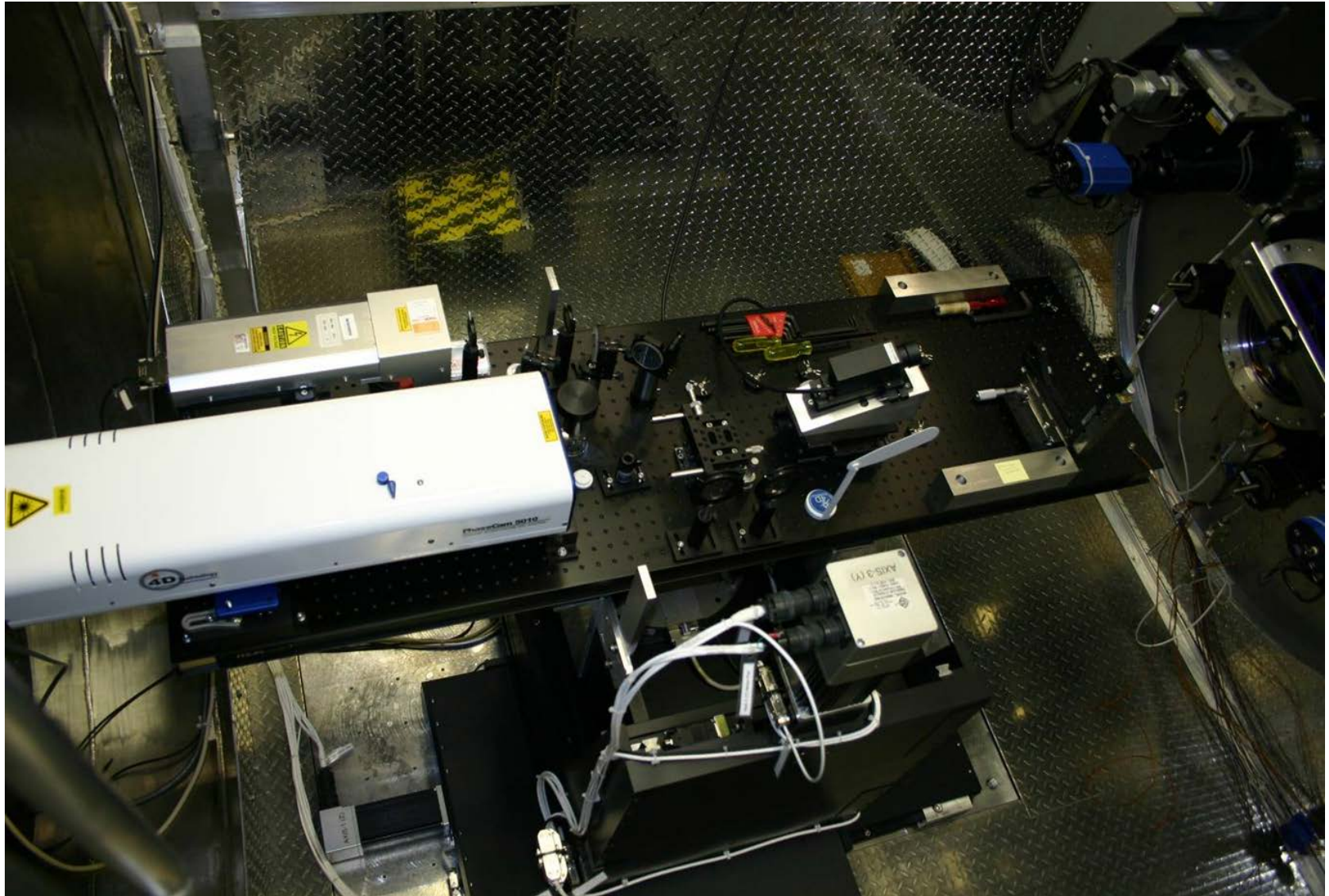

Simultaneous phase shifting interferometer

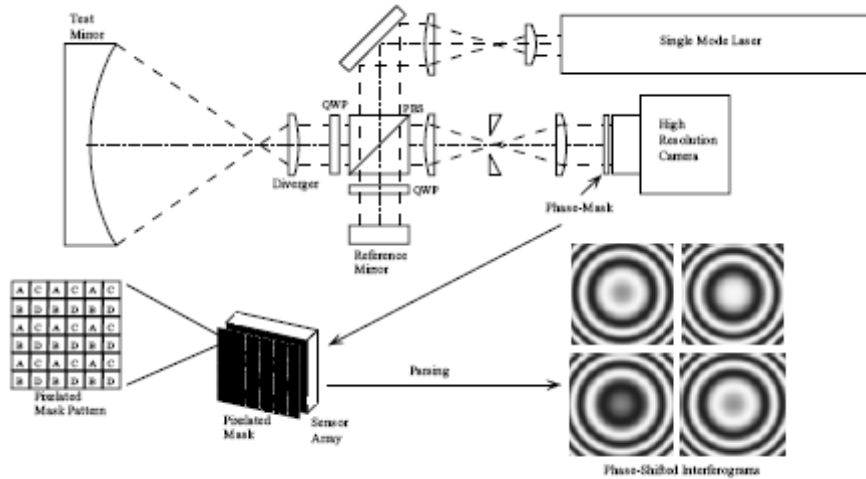

Micro-polarizer array camera sensor

Spatial phase shifting overcomes previous single frame or temporal phase shifting interferometer technique

Overcomes vibration and air turbulence in long optical path test setup found in astronomical telescope metrology in vacuum test chamber

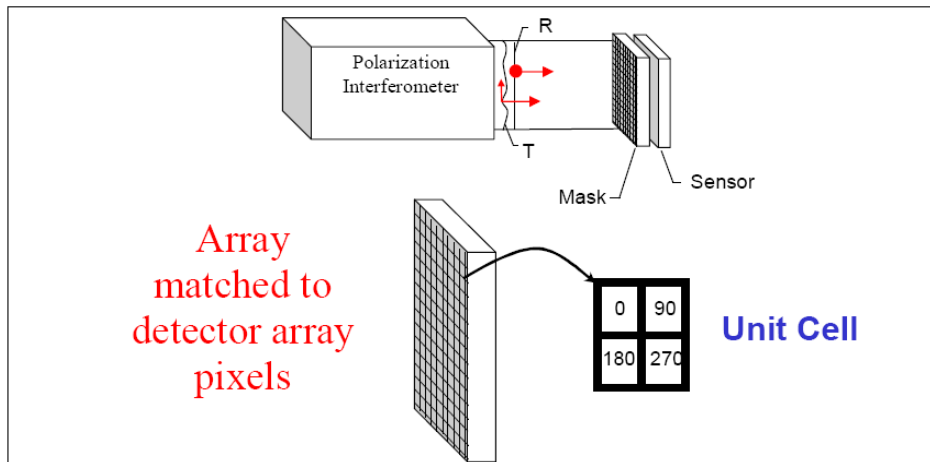

1 x 2 m cryo test chamber for mirror characterization

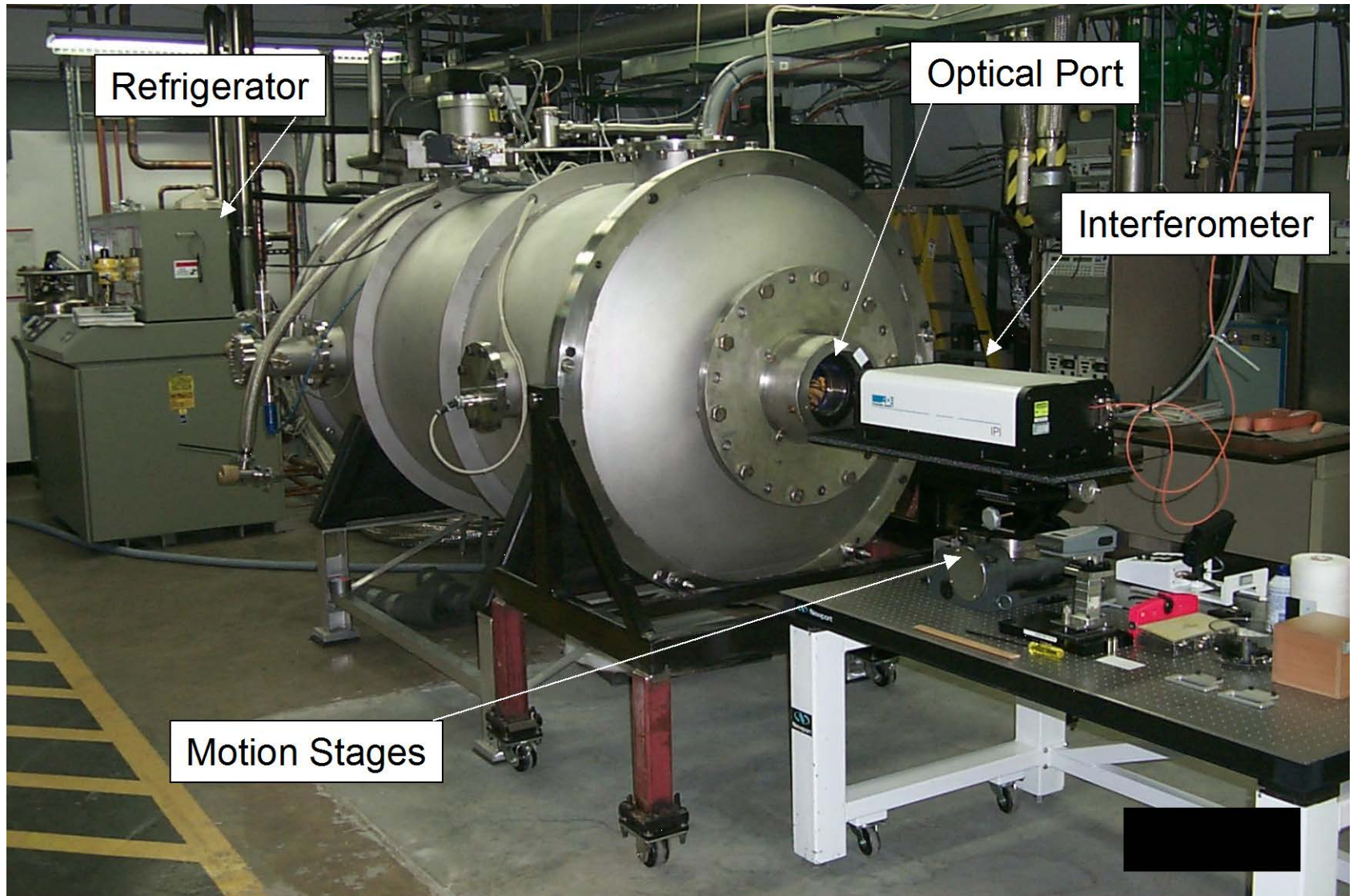

Test configuration for < 0.8 m dia. mirror

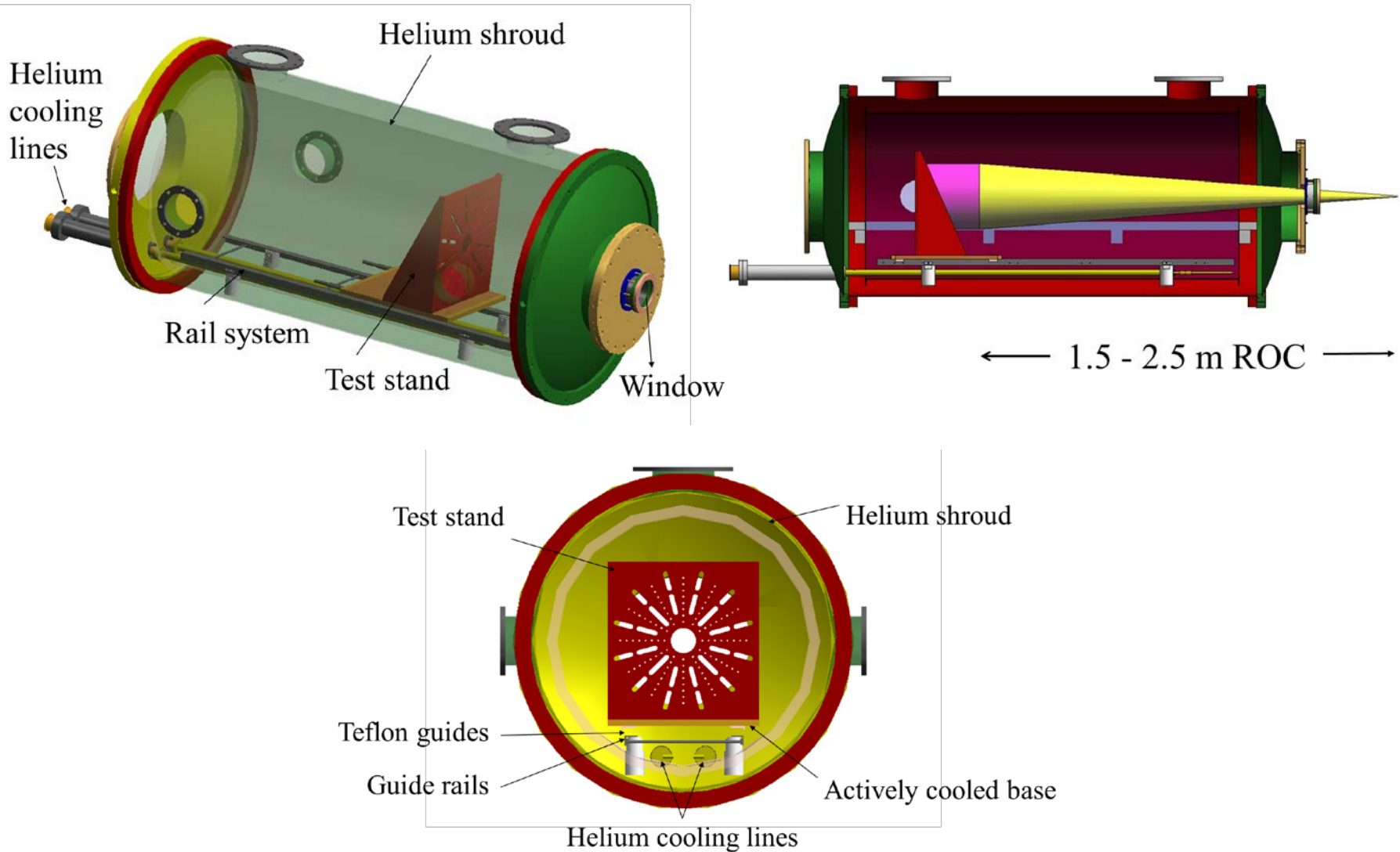



Advanced Mirror Technology Development (AMTD)



- Develop enabling technology for 4 meters or larger monolithic or segmented, UV, optical, and IR space telescope primary mirror assemblies for general astrophysics, and ultra-high-contrast observations of exoplanet missions
- Large UV optical IR (LUVOIR) surveyor mission concept
- HabEx mission concept
- Mission concepts for the 2020 Decadal Survey



Six enabling technologies



1. Large-aperture, low-areal density, high-stiffness mirror
2. Mirror support system
3. Integrated model validation
4. Mid & high spatial frequency figure error
5. Segment edges
6. Segment to segment gap phasing



Approach



- Develop structural, thermal and optical performance (STOP) models of candidate mirror assembly
- Models are validated by testing of **subscale** mirror assembly in relevant thermo-vacuum environments
- Develop & improve test methods to characterize mirror performance
- Using same test setup, facility to characterize competing mirror architecture
- Utilize and add capabilities to existing test facilities
- Gain valuable testing experience for personnel

Pressure tight enclosure in large chamber

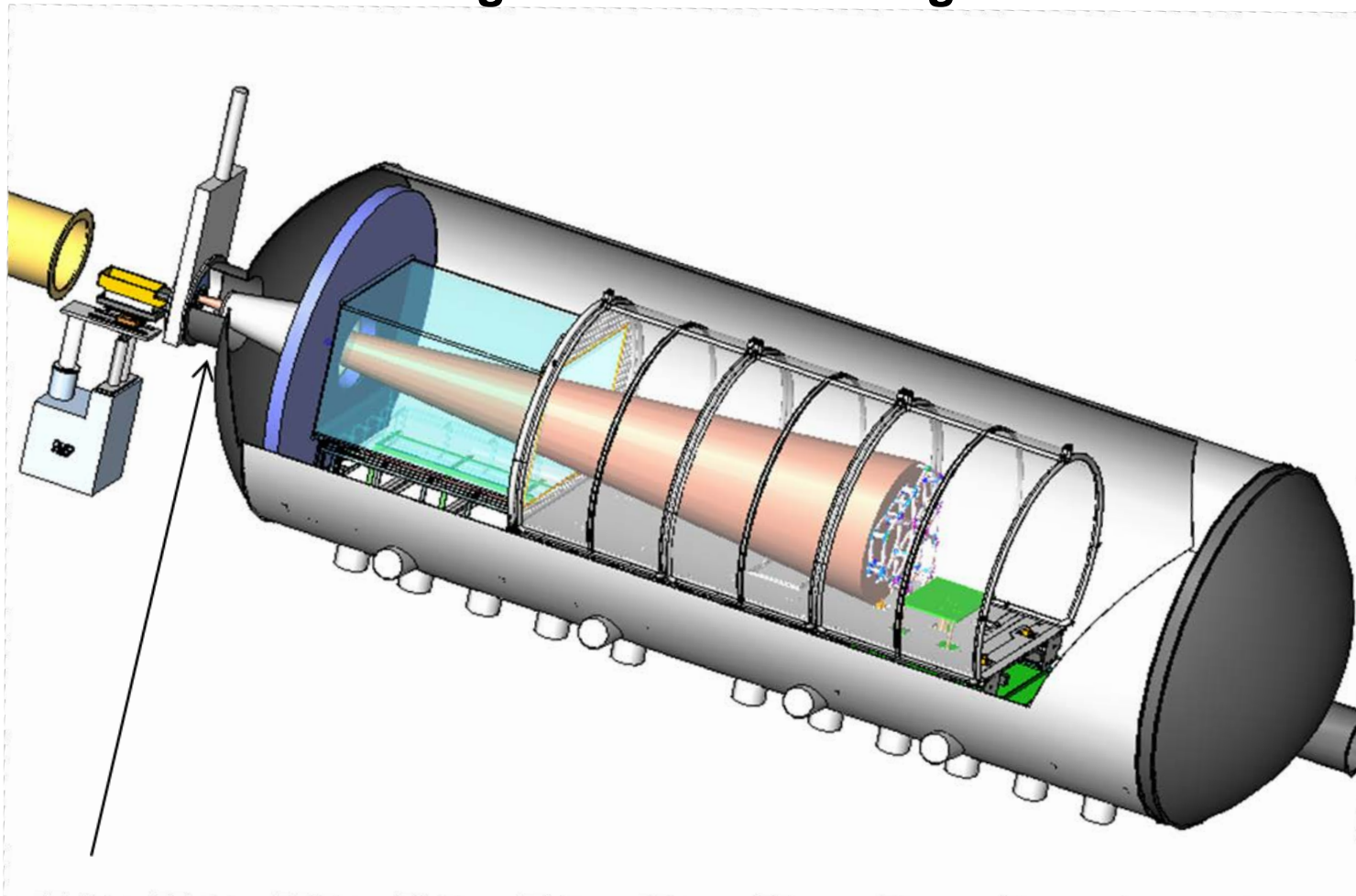

Existing structure prevents testing mirrors in this configuration with ROC < 3.5 meters

A pressure tight enclosure (PTE) configuration to test mirror with ROC < 3.5 meter

Test configuration for < 3.5 m radius of curvature mirror

Interferometer and test support equipment in pressure tight enclosure (PTE)

Mirror on test stand

Thermal shroud

Alignment stage

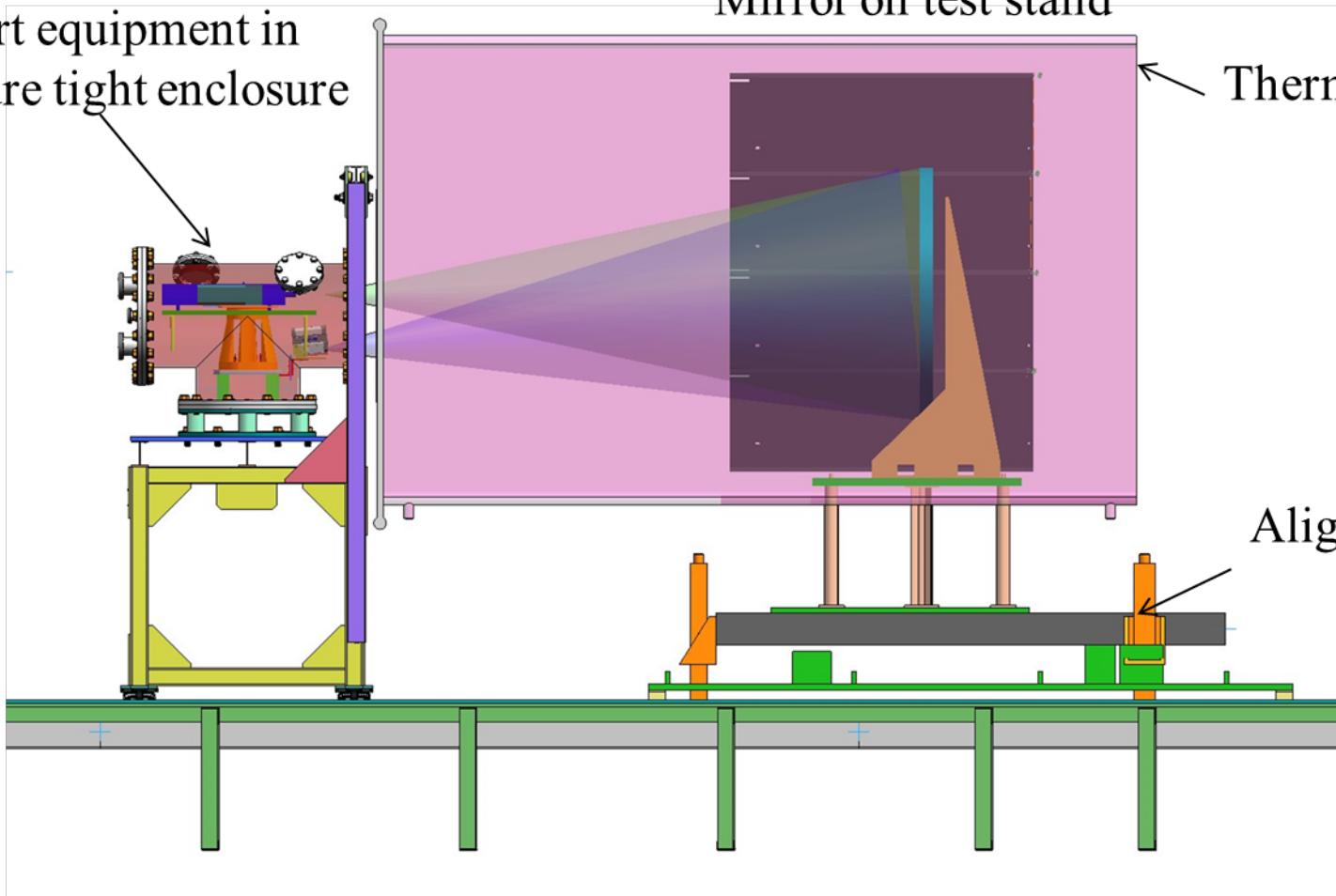



Test configuration for < 3.5 m radius of curvature mirror

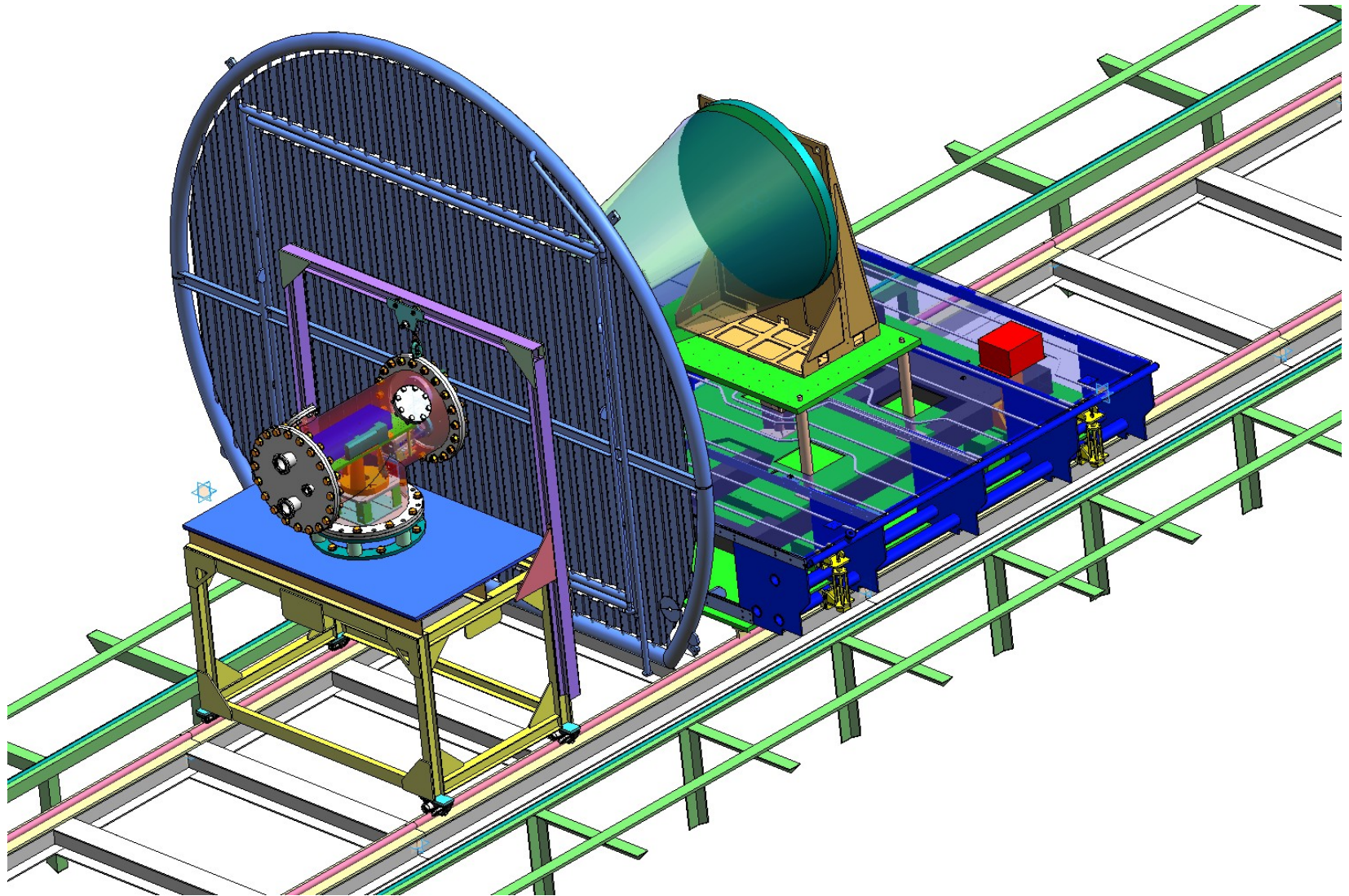



Test envelop for large and small chambers

<u>Chamber</u>	<u>Max Diameter</u>	<u>Max radius of curvature</u>
Large	4.25 m	22.5 m
Small	0.8 m	2.5 m

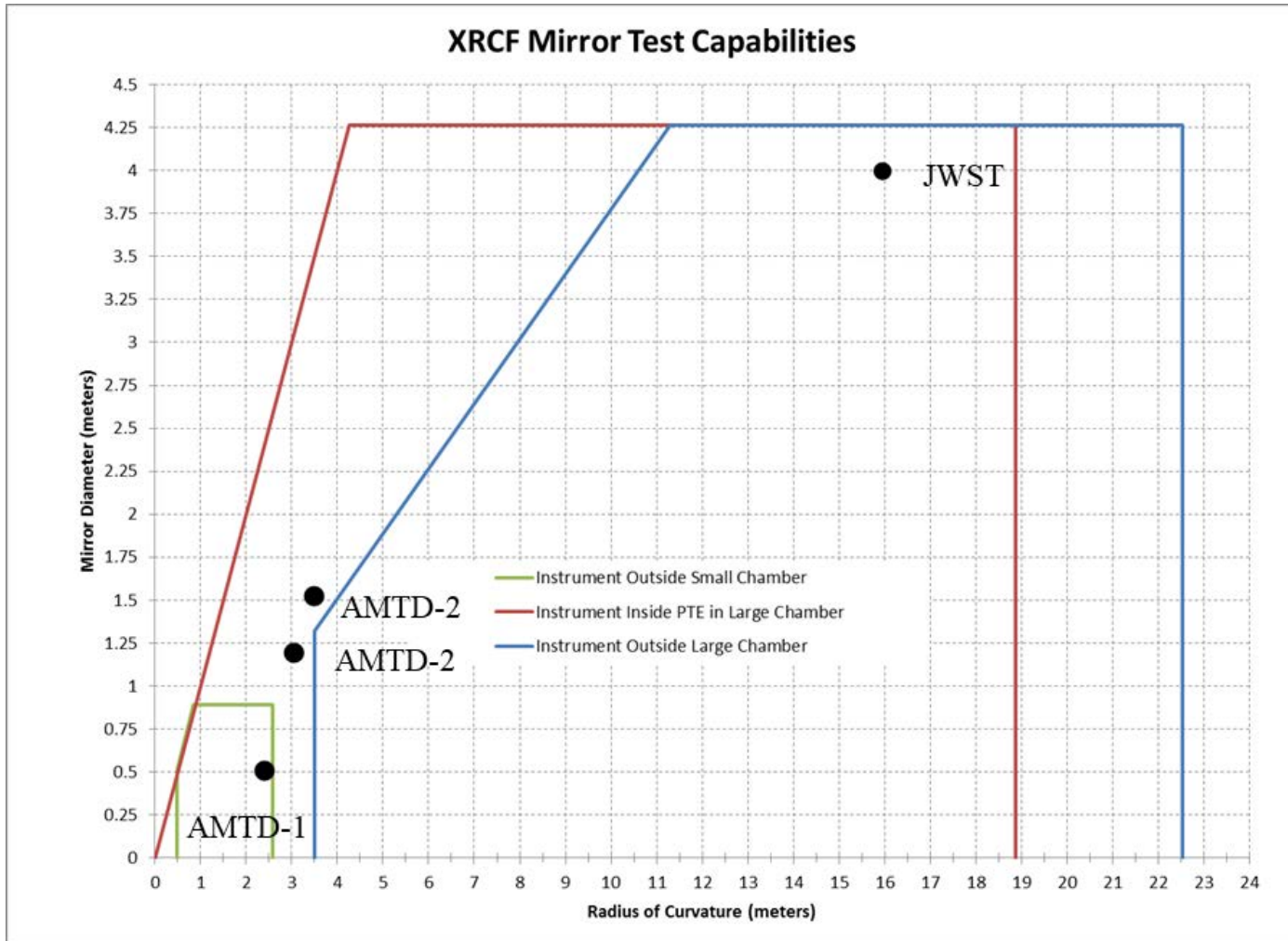

Optical test equipment inside pressure tight enclosure (PTE)

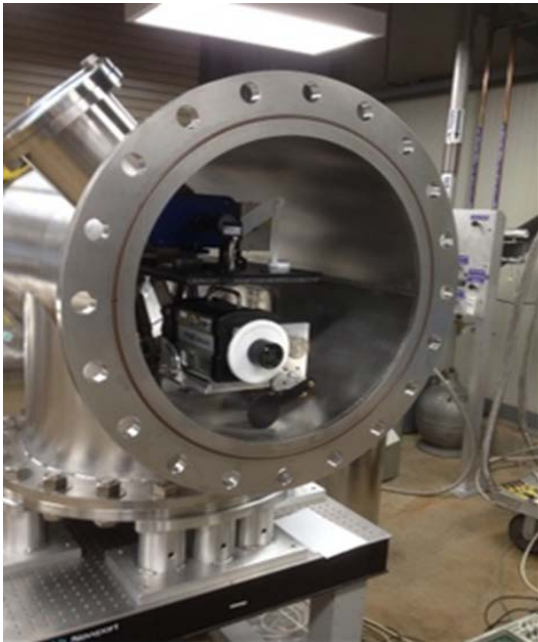
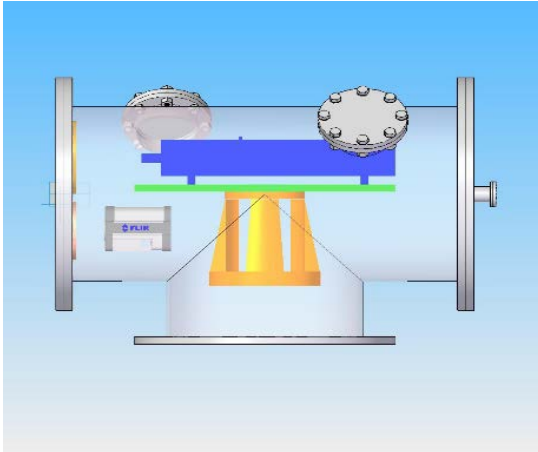

1. alignment CCD
2. alignment pinhole
3. interferometer
4. ADM
5. IR camera stage
6. hexapod



Cryo optical test with PTE

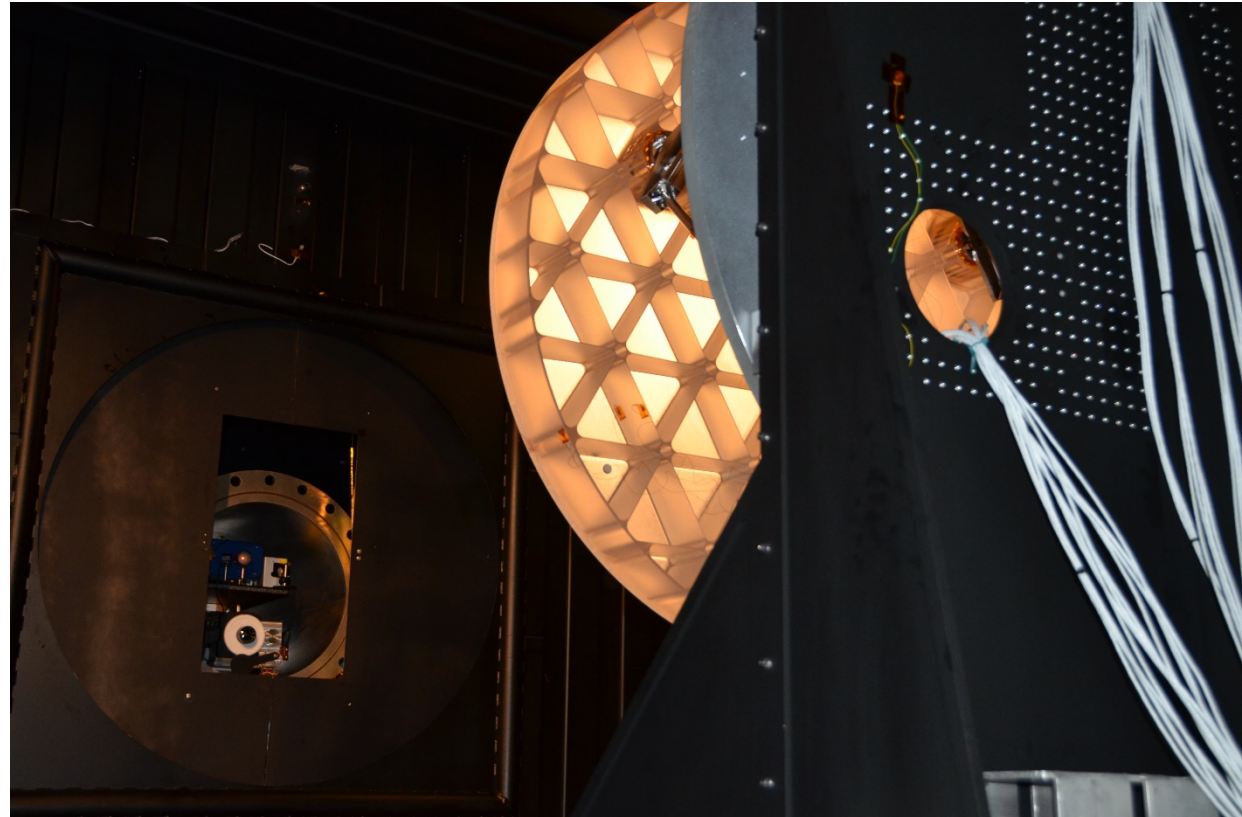

Measured Surface; RMS SFE = 28.8nm

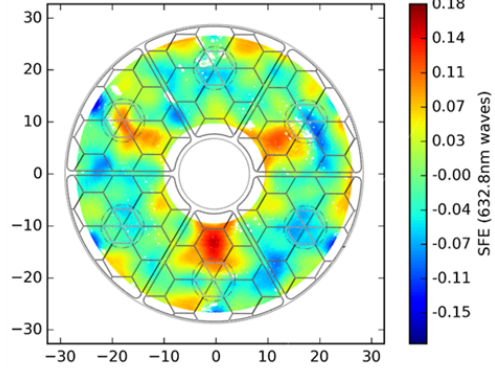

Predicted Surface; RMS SFE = 23.6nm

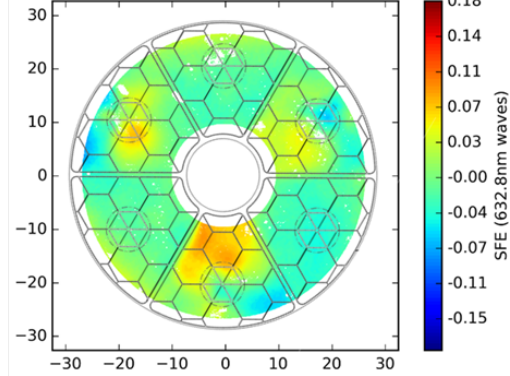

Residual Surface; RMS SFE = 22.0nm

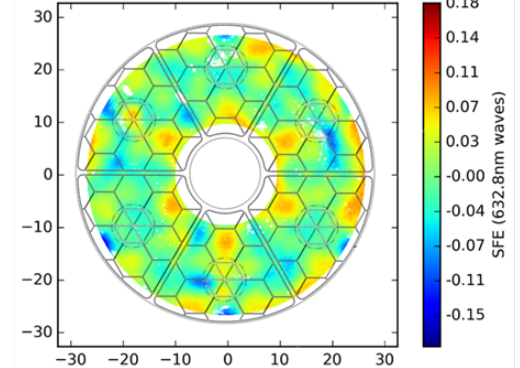

Predicted SFE uses:

- as-built CTE distribution
- as-built shape from X-ray CT
- includes prying (due to aluminum frame) and all possible forces reacting between mount and bond pad

Residual SFE could be CTE inhomogeneity



Gravity sag (predicted vs measured)

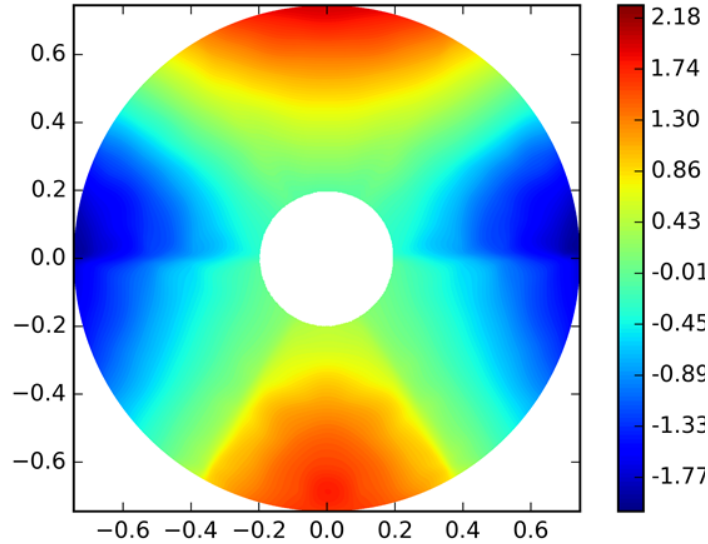

Predicted
580 nm rms

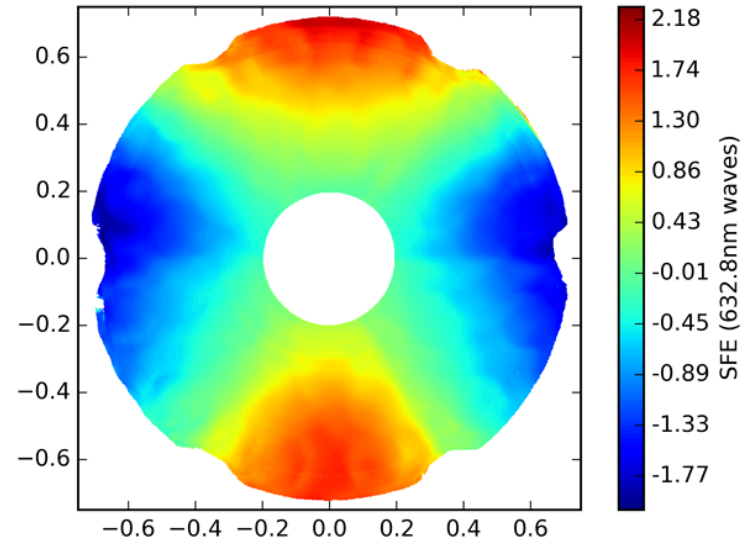

Measured
582.5 nm rms

Vertical optical test configuration

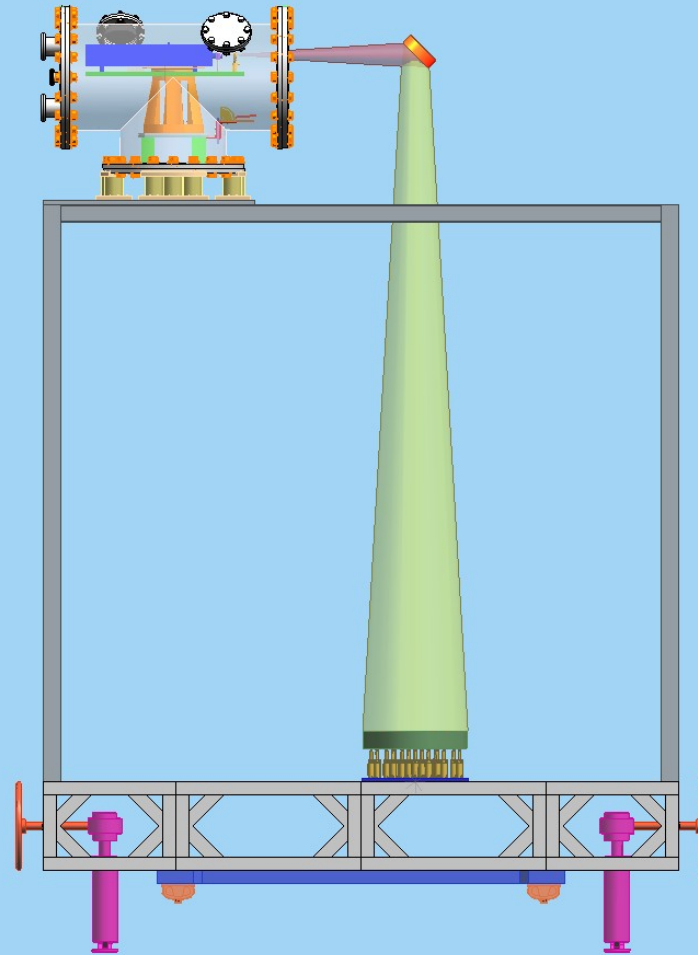



Thermal gradient test

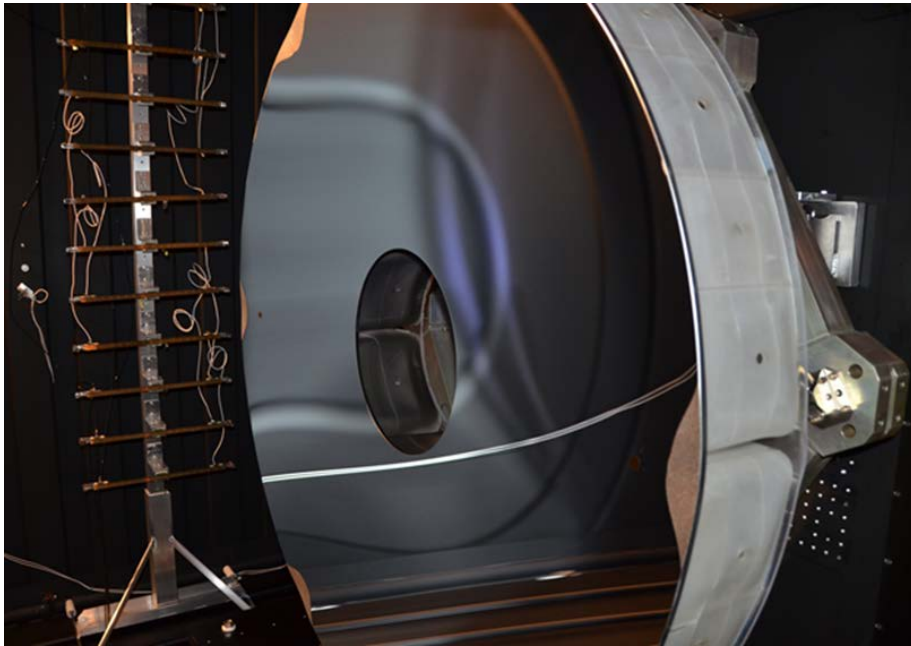

RMS: 78.69 nm
Astig: 158.3 nm, -9.969 deg
Coma: 77.43 nm, -14.48 deg

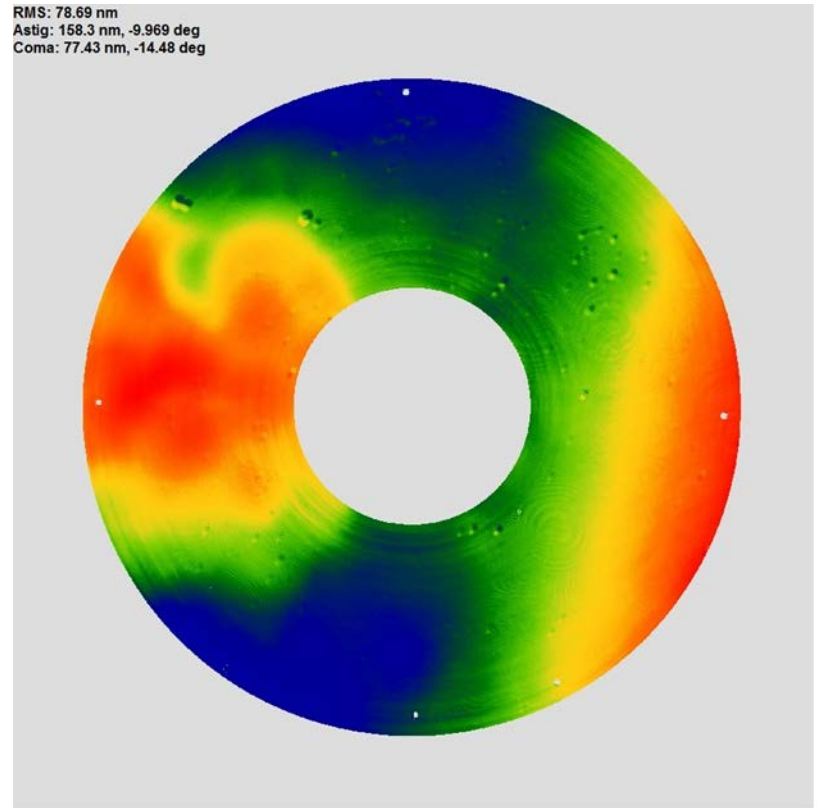



- Tapped at 42 locations with an instrumented modal test hammer
- Each location was tapped 5x and averaged

Mirror assembly suspended with bungees to simulate free-free condition



X-Ray computed tomography

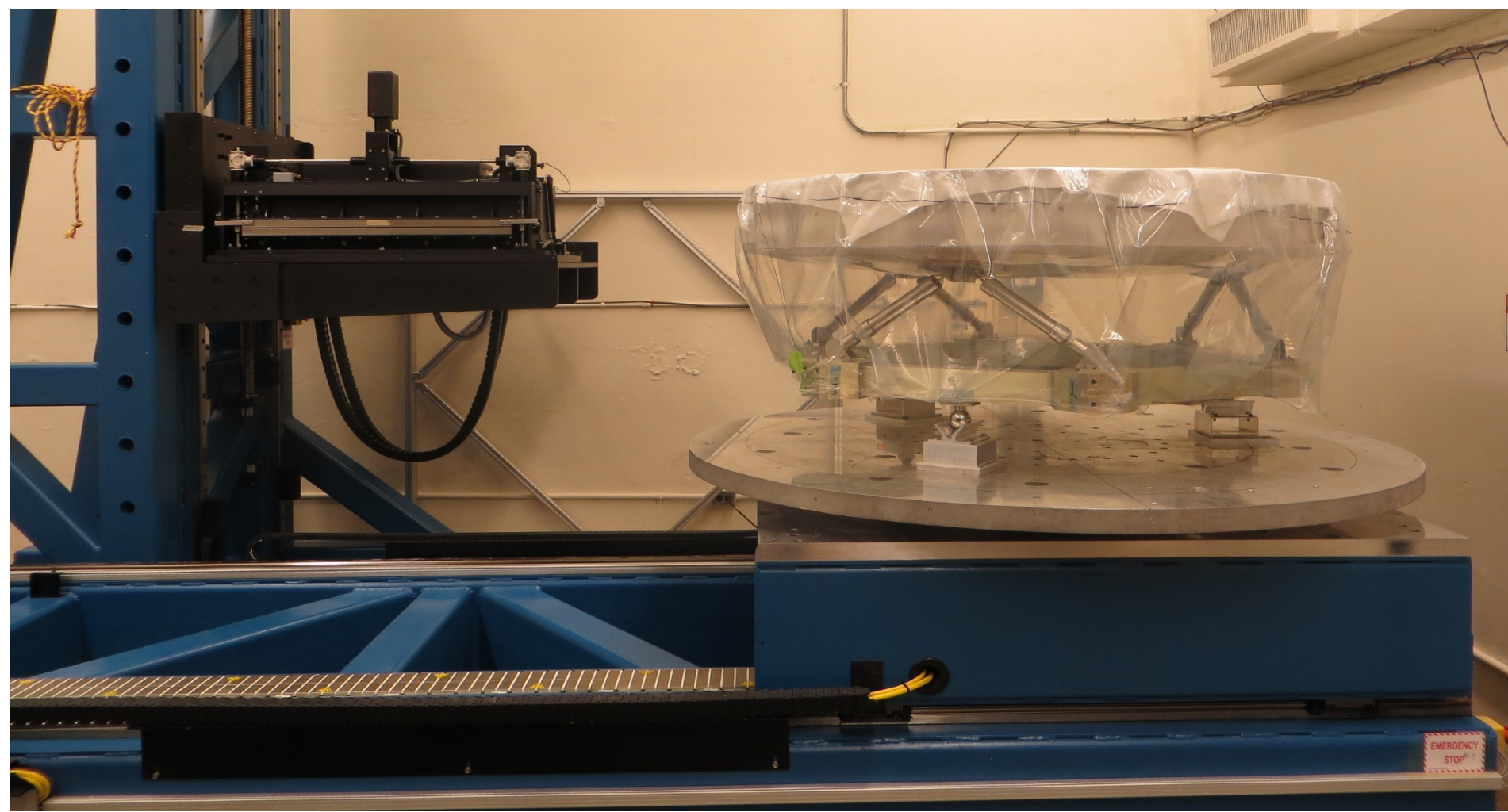



Future test plans

Current test facility modifications

- Predictive thermal control
 - Passive thermal
 - Active thermal control
-
- Low CTE glass-ceramic mirrors
 - Low CTE ceramic mirrors
 - Low CTE metal mirrors
 - Additive manufactured mirrors



Acknowledgments



Phil Stahl: PI

Michael Effinger: program manager

Mark Baker, Bill Hogue, Jeffrey Kegley, Richard Siler, John Tucker, Ernest Wright: XRCF thermal-vac test support team

Thomas Brooks: thermal-mechanical analysis

Brent Knight, Frank Tsai: modal analysis

Alex McCool, Russel Parks: modal test

Ron Beshears, Dave Myers: X-ray computed tomography

Darrell Gaddy: thermal IR video

Brian Odom: MSFC historical photos



Thank you

Dr. Jeong-Yeol Han



Ron Eng

ron.eng@nasa.gov

<https://optics.nasa.gov>

National Aeronautics and
Space Administration

