

GOES-16 Magnetometers Anomaly Solar-Angle Based Characterization & Correction

Delano Carter[†], Derrick Early[†], Jeff Kronenwetter[†],
Michael Grotenhuis^{*}, Richard Schnurr[‡], Monica Todirita[□]

January 10, 2019

[†] Thearality, Inc.

[†] Chesapeake Aerospace LLC

^{*} ASRC Federal

[‡] Goddard Spaceflight Center, NASA

[□] GOES-R Series Flight Project, NOAA

Introduction

- GOES-16 Observatory Magnetometer System Overview
- Magnetometer System Anomaly Solar-Angle Based Characterization
- Performance Recovery Method and Results
- Solar-Angle Based Correction Algorithm and Performance Results
- Algorithm Operational Ground System Implementation Considerations
- Conclusions

GOES-16 Observatory Overview

- GOES-R launched aboard an Atlas V 541 rocket from Space Launch Complex-41 at Cape Canaveral Air Force Station, Florida, on November 19, 2016
- The first satellite in the series, GOES-R, was renamed GOES-16 upon reaching geostationary orbit
- GOES-16 at GOES-Checkout location (89.5° W) during PLT
- The GOES-16 magnetometer boom was deployed on December 7, 2016 and magnetometer checkout began
- GOES-16 replaced GOES-13 as NOAA's operational GOES-East satellite on December 18, 2017
- The GOES-16 satellite operational location (GOES-East) is at 75.2° W



GOES-16 Observatory Instruments and Magnetometer Locations

GOES-16 Observatory

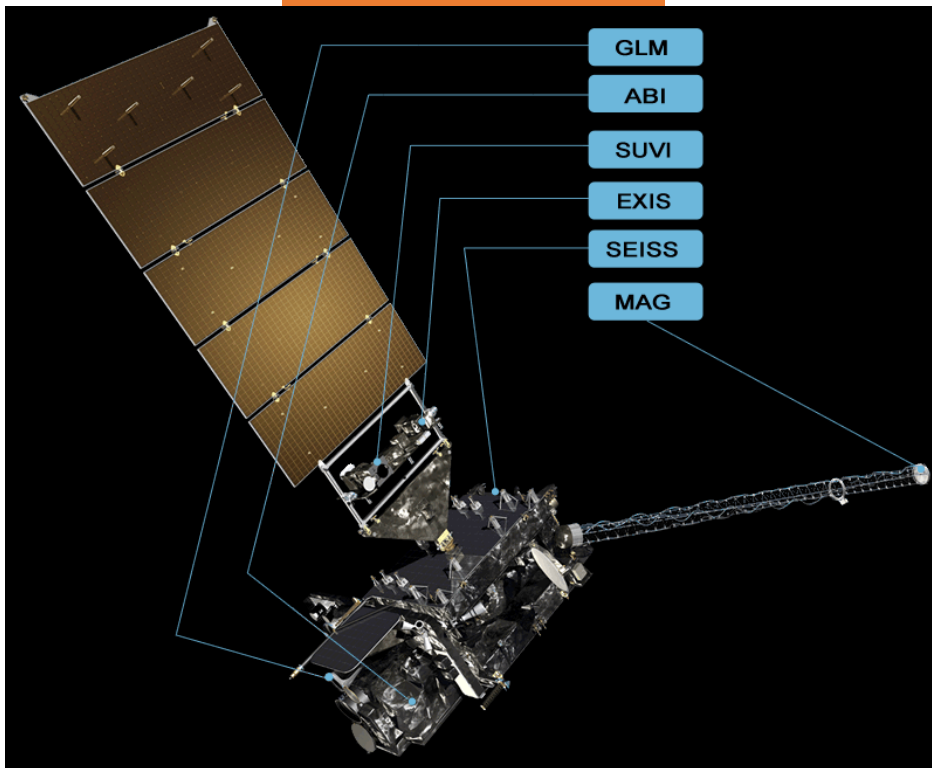

GOES-16 Magnetometers

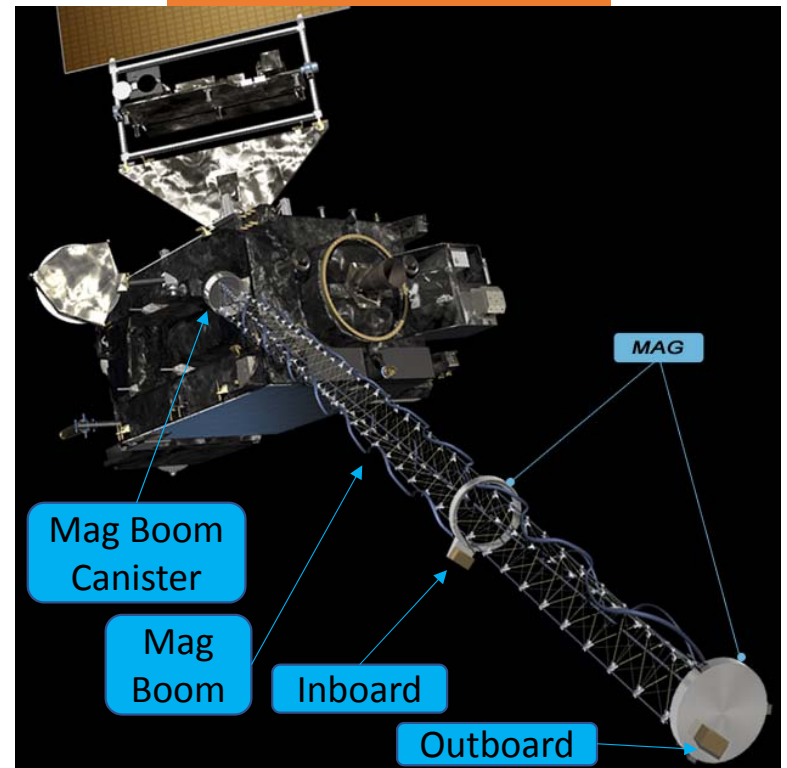

GOES-16 Anomaly Solar-Angle Based Characterization, before calibration

Mag Diurnal Difference Curves: Blue

X
Y
Z

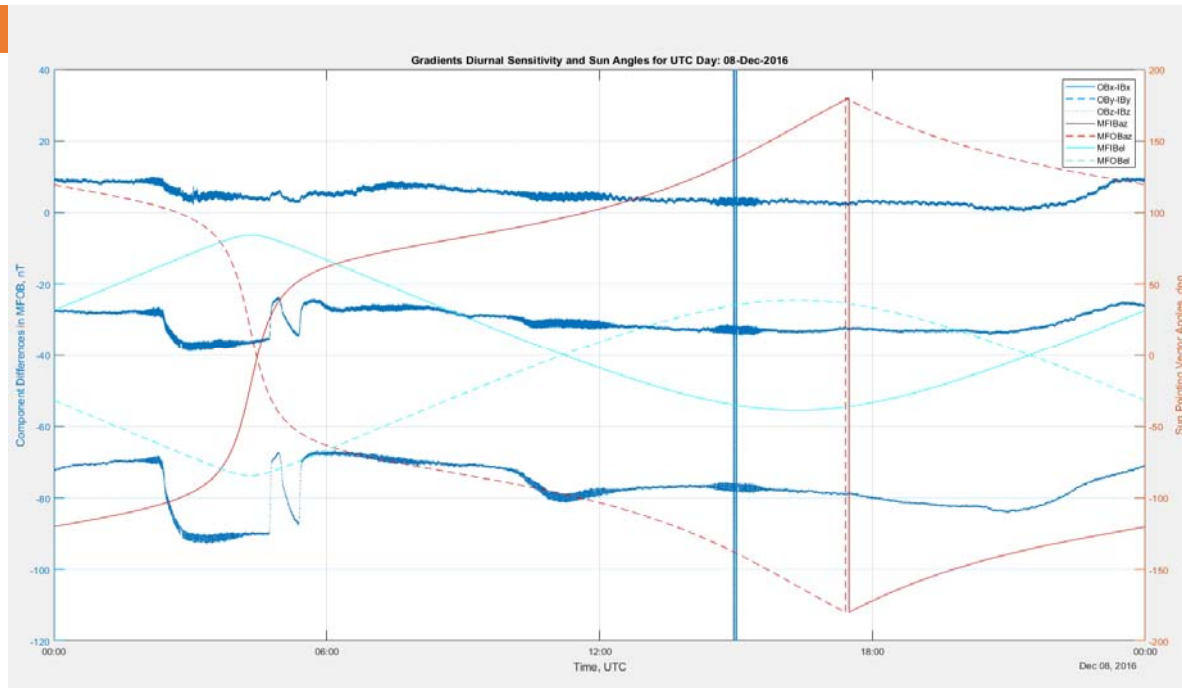

Solar Az (red)/El (blue) Angles wrt:
Inboard reference frame - solid
Outboard reference frame - dash

Ideally, the difference between the IB and OB magnetometers (dark blue) should be near zero throughout the day.

GOES-16 IB Mag Shadowing by Observatory Anomaly Solar-Angle Based Characterization, 1/6

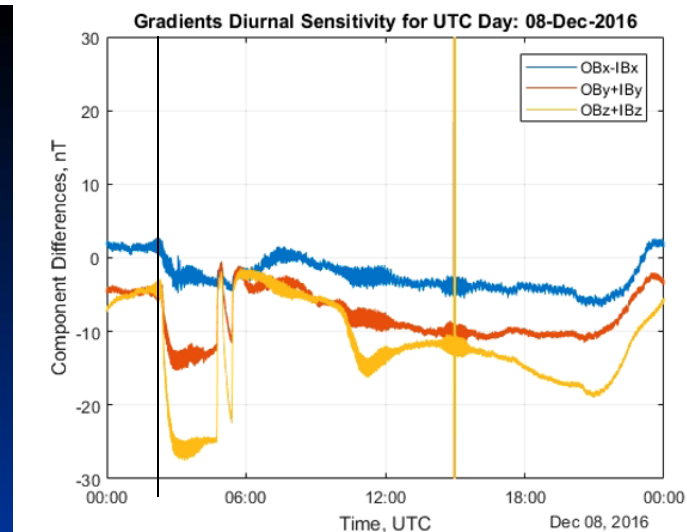
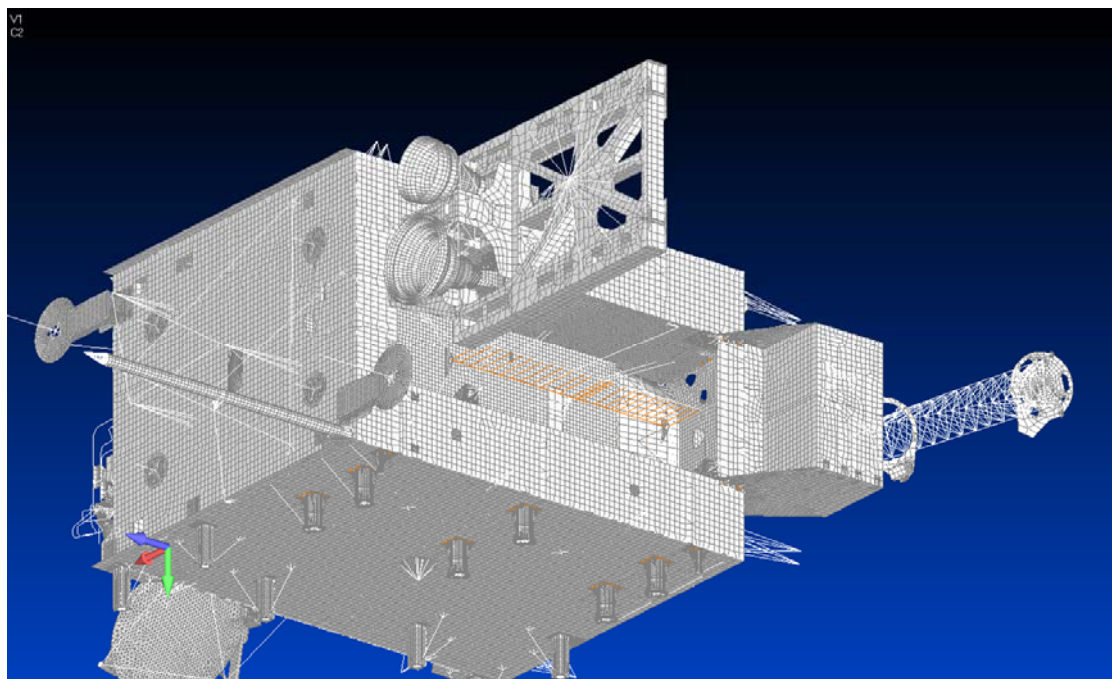

Sun View @ -23.4 deg
Shadowing Begins: 2036 LST, 0236 UTC

GOES-16 IB Mag Shadowing by Observatory Anomaly Solar-Angle Based Characterization, 2/6

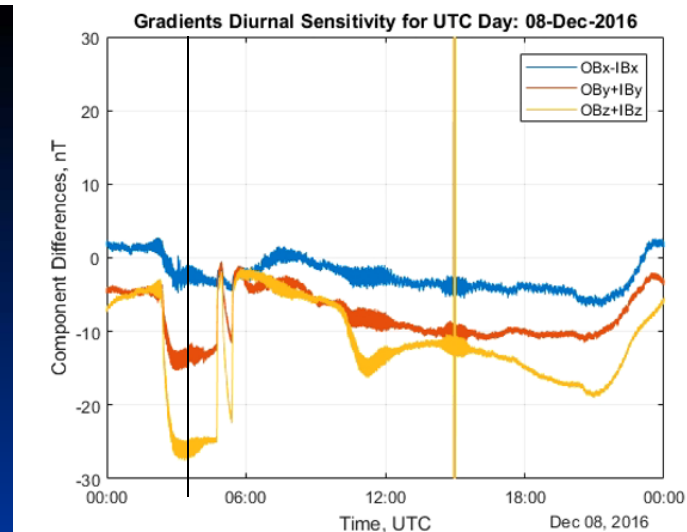
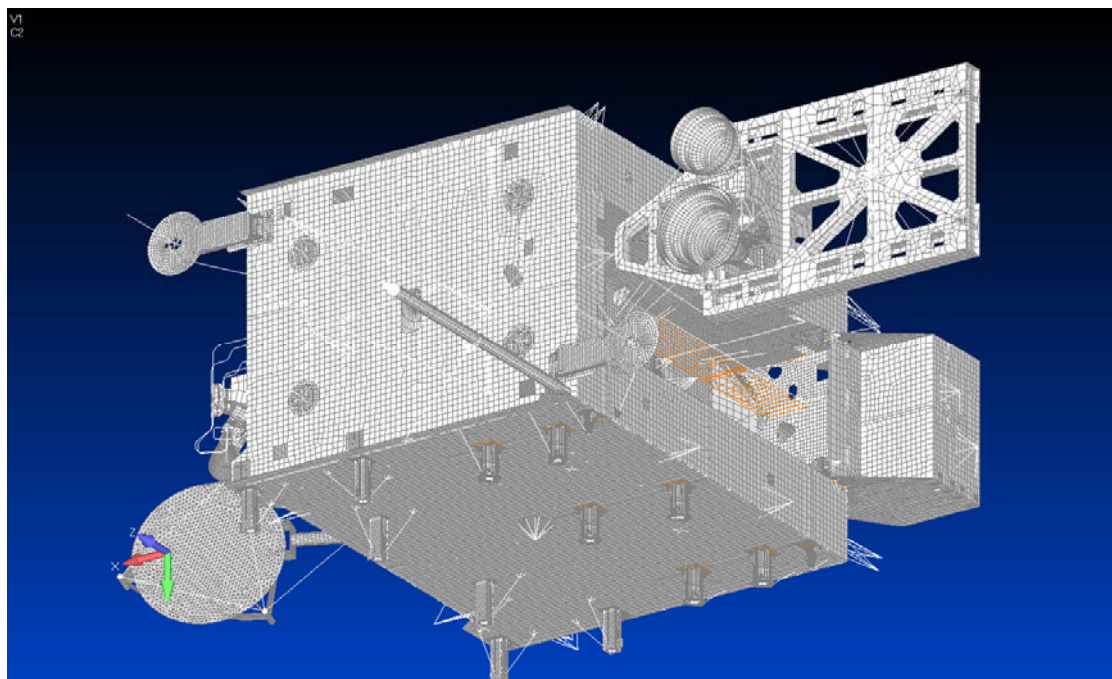

Sun View @ -23.4 deg
1st IB mag shadowing

GOES-16 IB Mag Shadowing by Observatory Anomaly Solar-Angle Based Characterization, 3/6

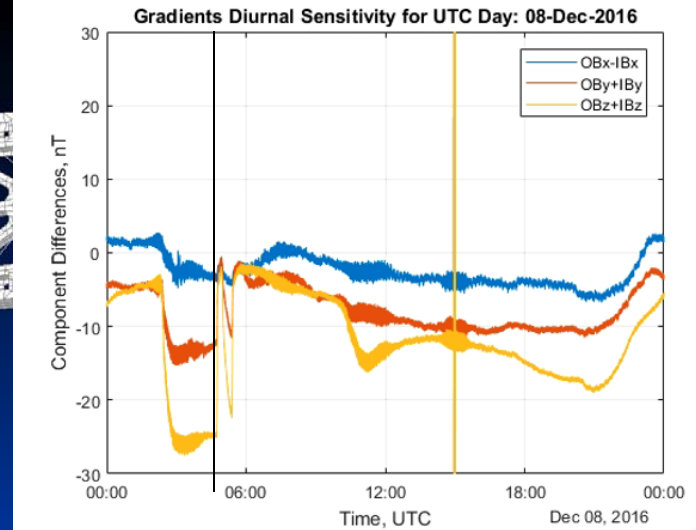
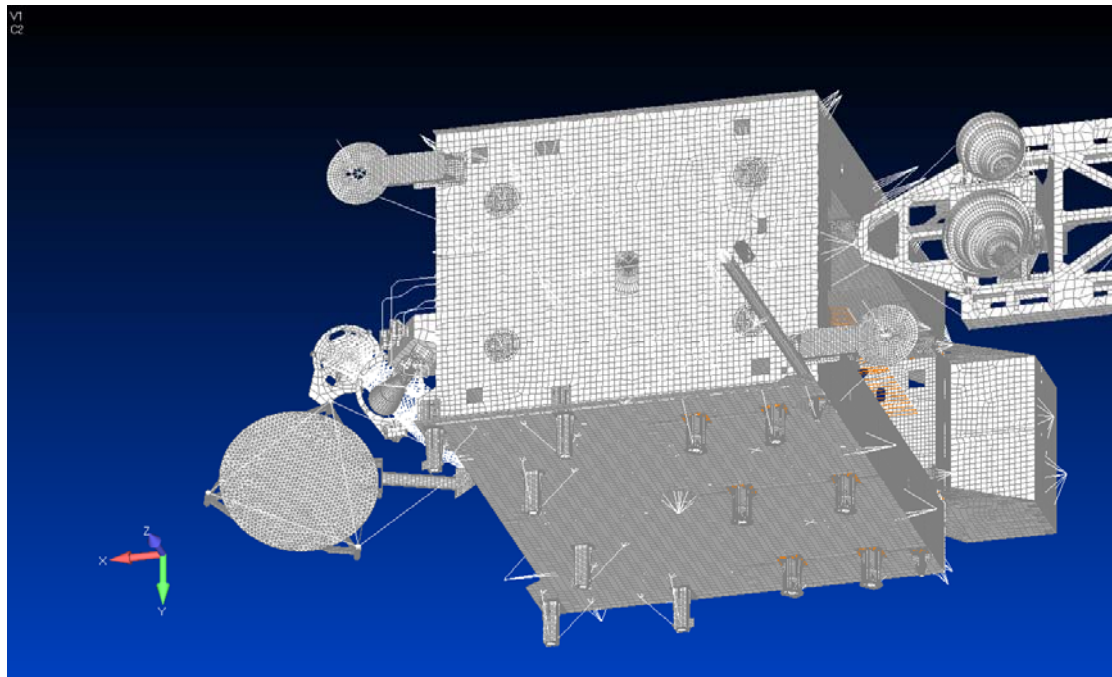

Sun View @ -23.4 deg
Shadowing Ends: 2256 LST, 0456 UTC

GOES-16 IB Mag Shadowing by Observatory Anomaly Solar-Angle Based Characterization, 4/6

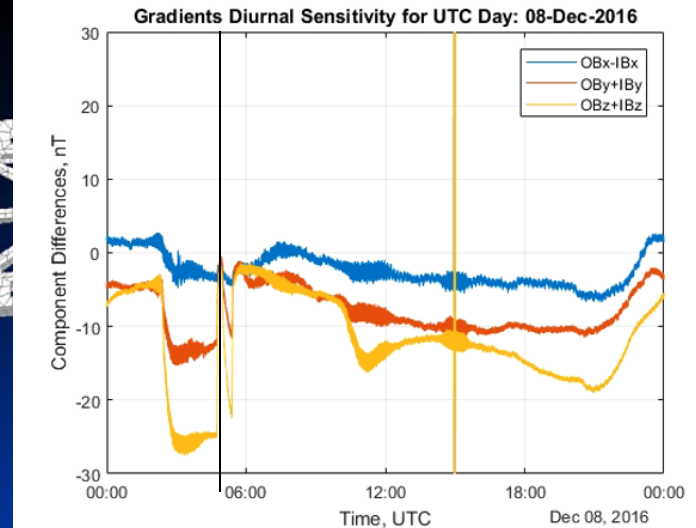
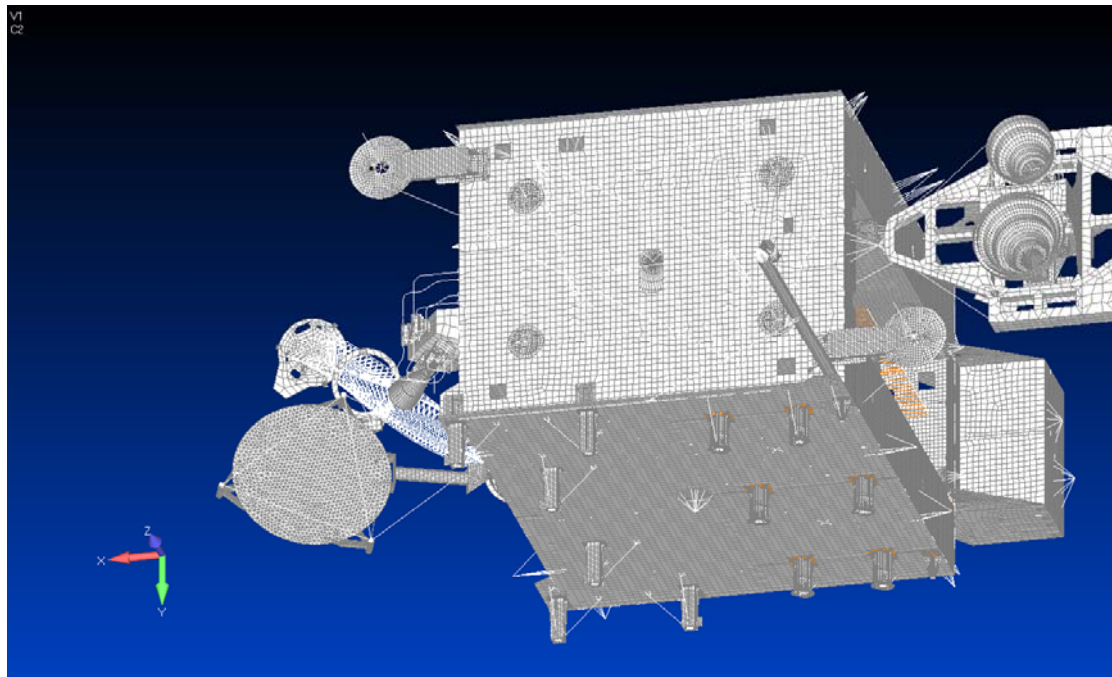

Sun View @ -23.4 deg
2nd Shadow Begins: 2312 LST, 0512 UTC

GOES-16 IB Mag Shadowing by Observatory Anomaly Solar-Angle Based Characterization, 5/6

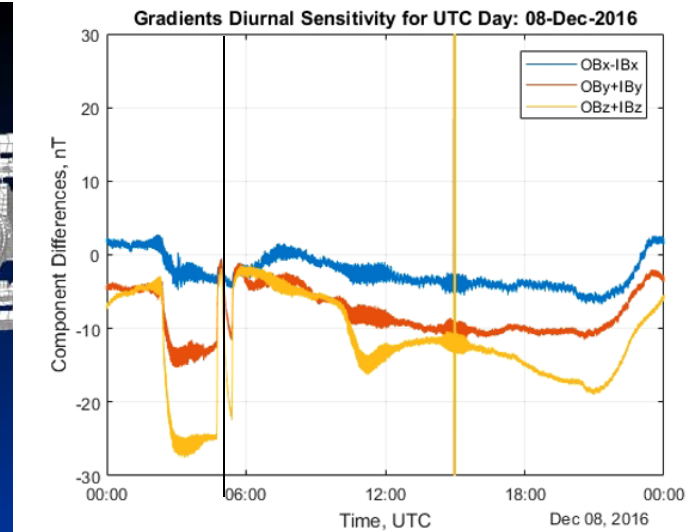
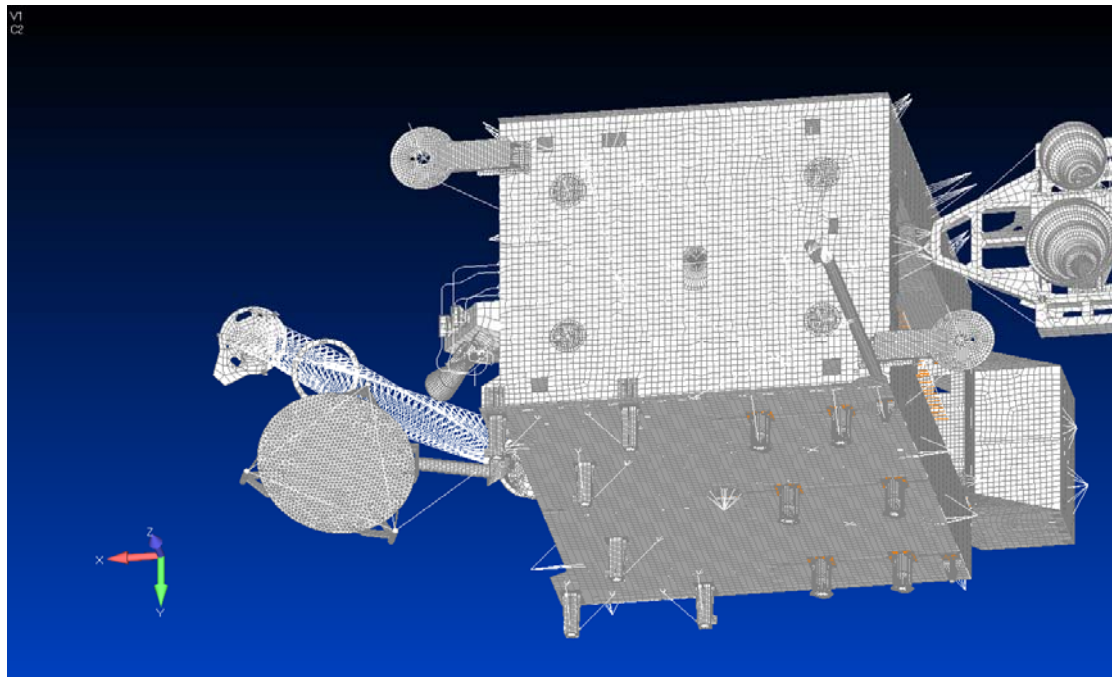

Sun View @ -23.4 deg
2nd IB mag shadowing

GOES-16 IB Mag Shadowing by Observatory Anomaly Solar-Angle Based Characterization, 6/6

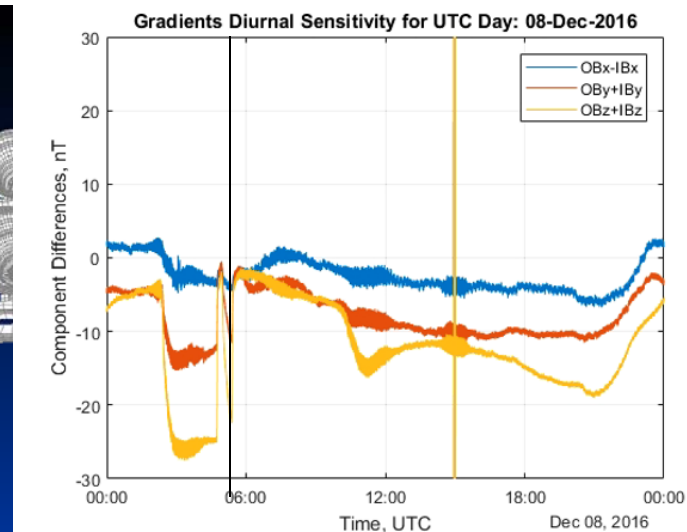
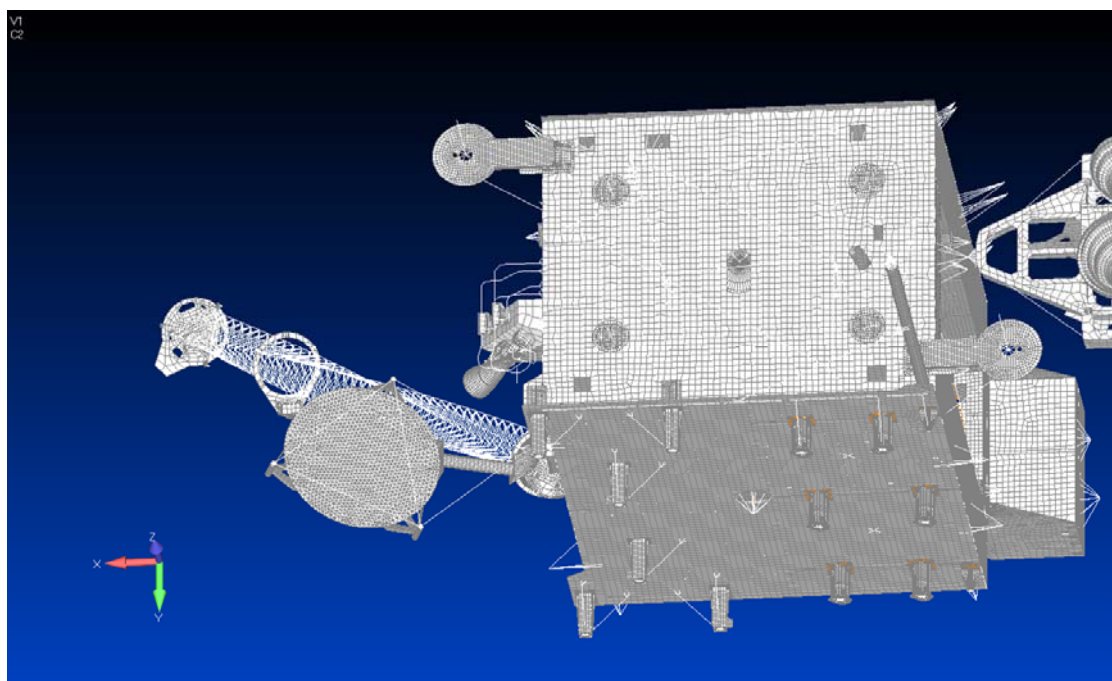

Local Midnight View @ -23.4 deg
2nd Shadow Ends: 2332 LST, 0532 UTC

GOES-16 Magnetometer System Anomaly Likely Root Cause

- Thermo-electric effects
 - Magnetic contamination due to the inadvertent application and subsequent removal of thermal blanket magnetically susceptible tape
 - Inadvertent thermally driven current paths
 - Magnetometer thermal control system heater operation
- Details will be documented in:

“LESSONS LEARNED FROM FLIGHT OBSERVATIONS OF THE GOES-R MAGNETOMETER” M. Todirita, R. Schnurr, J. Kronenwetter, D. Early, M. Grotenhuis, R. Studer, D. Carter, R. Dence, M. Wolf, J. Mandi, R. Bailey. ESA Workshop on Aerospace EMC, 20-22 May 2019, Budapest, Hungary

GOES-16 Magnetometer Measurement Anomaly Performance Recovery Method and Results

- Identify valid geomagnetic field reference source
 - GOES-13 at GOES-East location identified as valid truth source during GOES-16 collocation with GOES-13
 - Extended GOES-13 truth source usefulness from GOES-East location to GOES-Checkout (PLT) location based on GOES-NOP Series magnetometer historical data (GOES-15 at Checkout location and GOES-13 at East location)
 - Useful GOES-13 based truth source data to support GOES-16 performance recovery obtained from 08-Dec-2016 thru 02-Jan-2018
- Determine diurnal error curves of GOES-16 mag measurements with respect to GOES-13 mag measurements from 08-Dec-2016 thru 02-Jan-2018
- Derive diurnal correction curves using GOES-16 mag anomaly model to apply to GOES-16 mag measurements from 08-Dec-2016 thru 02-Jan-2018
- Capture diurnal correction curves into solar-angle synchronized look-up table
- Compare corrected GOES-16 magnetometer measurement performance results wrt the GOES-16 anomalous magnetometer measurement performance results

GOES-16 Magnetometer Anomaly Correction LUT Synthesis Data Processing Flow Diagram

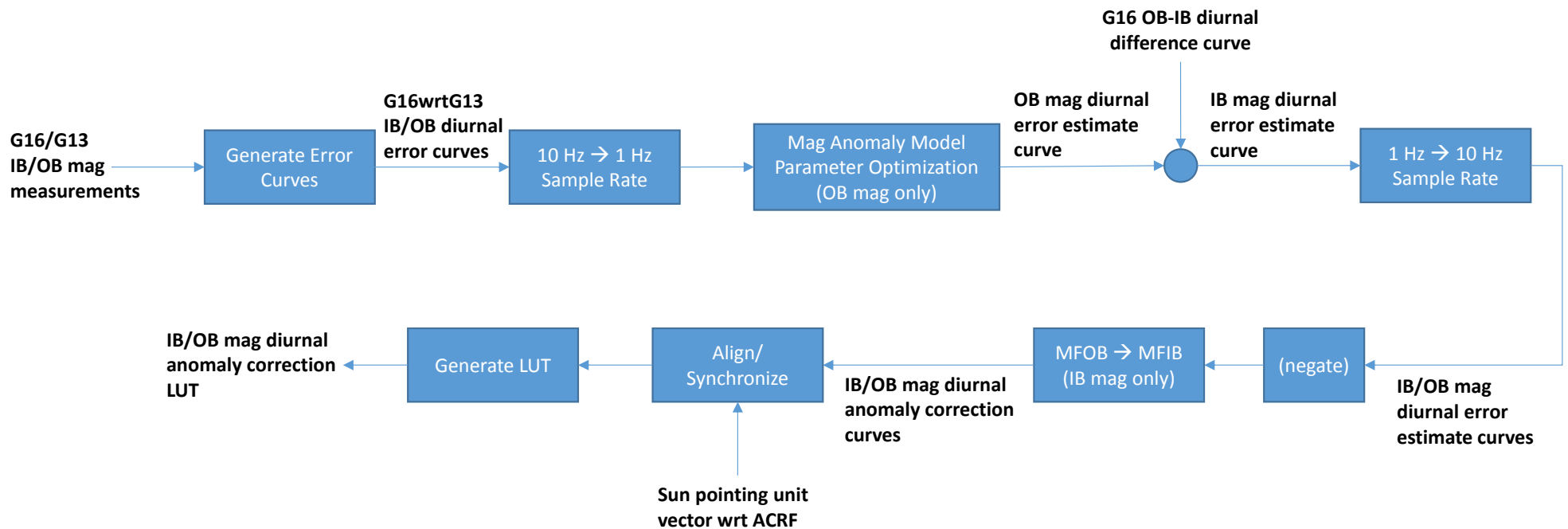

GOES-16 Magnetometer Anomaly Correction LUT Synthesis Data Processing Flow Diagram

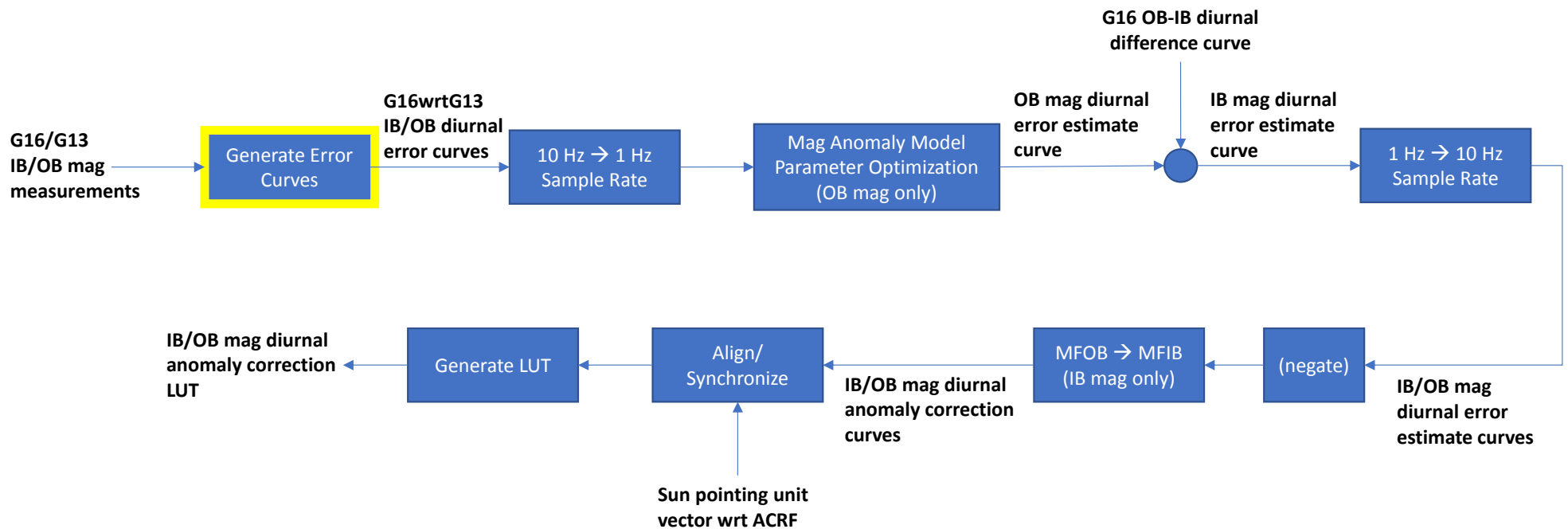

Determine the GOES-16 wrt GOES-13 Diurnal Error Curve for the IB & OB Mags from 08-Dec-2016 thru 02-Jan-2018 Flow Chart

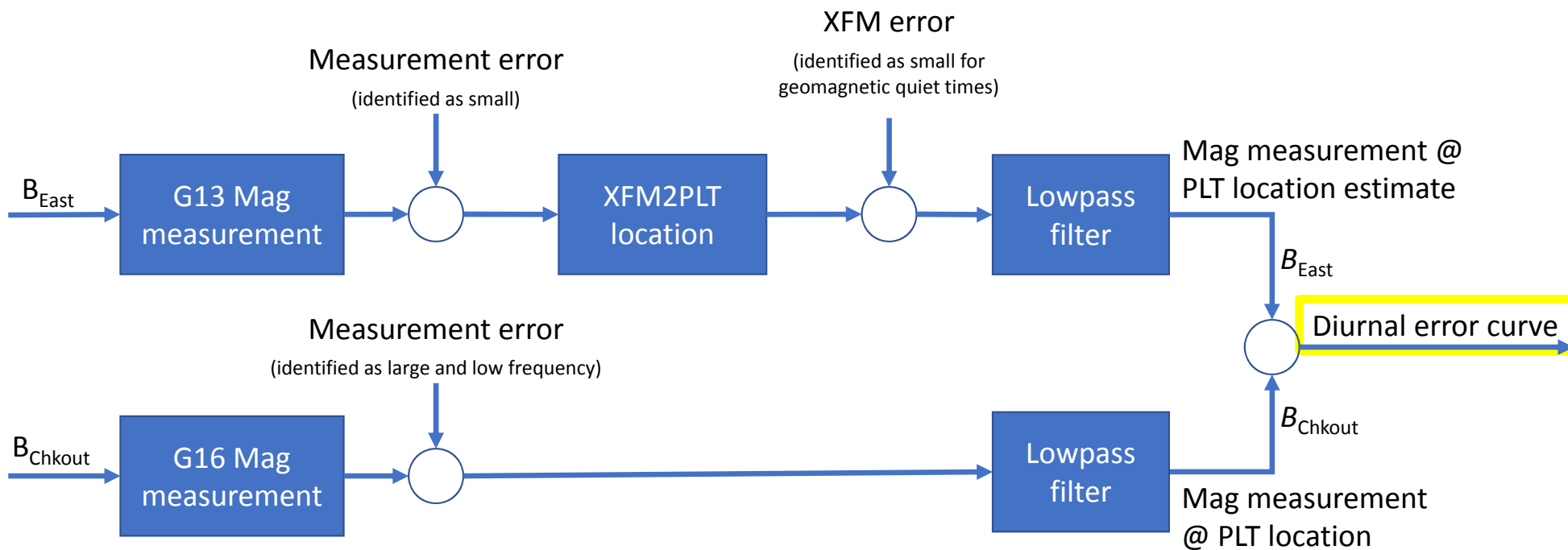

Determine the GOES-16 wrt GOES-13 Diurnal Error Curve for the IB & OB Mags from 08-Dec-2016 thru 02-Jan-2018 Flow Chart

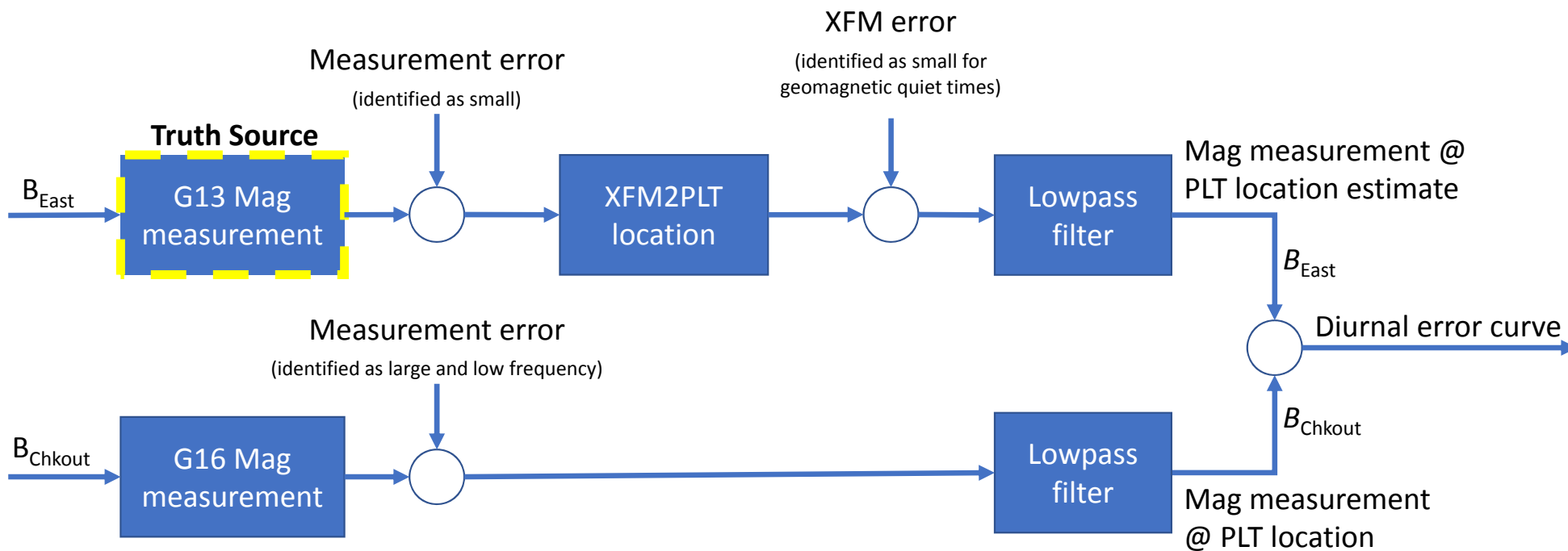

GOES-16 Magnetometer Measurement Anomaly Performance Recovery Method and Results

- Identify valid geomagnetic field reference source
 - GOES-13 at GOES-East location identified as valid truth source during GOES-16 collocation with GOES-13
 - Extended GOES-13 truth source usefulness from GOES-East location to GOES-Checkout (PLT) location based on GOES-NOP Series magnetometer historical data (GOES-15 at Checkout location and GOES-13 at East location)
 - Useful GOES-13 based truth source data to support GOES-16 performance recovery obtained from 08-Dec-2016 thru 02-Jan-2018
- Determine diurnal error curves of GOES-16 mag measurements with respect to GOES-13 mag measurements from 08-Dec-2016 thru 02-Jan-2018
- Derive diurnal correction curves using GOES-16 mag anomaly model to apply to GOES-16 mag measurements from 08-Dec-2016 thru 02-Jan-2018
- Capture diurnal correction curves into solar-angle synchronized look-up table
- Compare corrected GOES-16 magnetometer measurement performance results wrt the GOES-16 anomalous magnetometer measurement performance results

GOES-16 Collocation with GOES-13 at the GOES-East Location

- GOES-16 was at 75.2° W; GOES-13 was at 75° W
- The collocation time period was from 10-Dec-2017 thru 02-Jan-2018
- Comparison between the GOES-16 and GOES-13 magnetometer measurements were performed during collocation
- The measurement comparisons were performed wrt the GOES-16 OB magnetometer reference frame
 - Measurement errors were calculated wrt the local GOES-16 mag reference frames
- It was found that the GOES-16 IB mag x-axis measurement and the “virtual” GOES-13 IB mag x-axis measurement were nearly identical outside of the GOES-16 IB mag shadowing anomaly time period
 - The remaining GOES-16 IB & OB mag measurements showed much less agreement wrt the virtual GOES-13 mag measurements

Magnetometer Measurement Comparison Results during GOES-16 Collocation with GOES-13, 29-Dec-2017

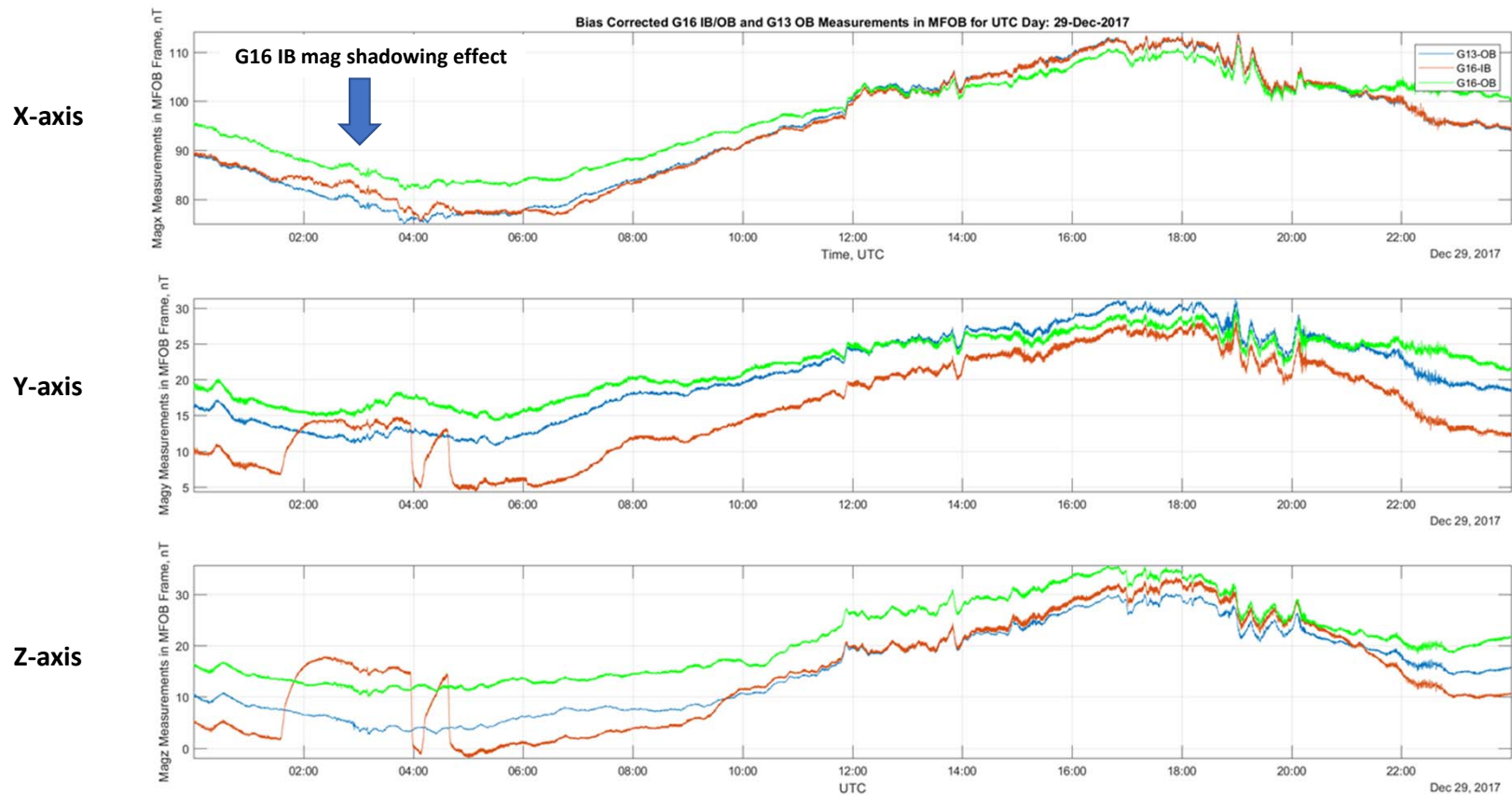

**GOES-13: Blue
GOES-16 IB: Red
GOES-16 OB: Green**

Verified that GOES-13 is a Useful Three-Axis Geomagnetic Field Measurement Truth Source

- The GOES-13 virtual x-axis mag measurement overlays the GOES-16 IB x-axis mag measurement in the OB mag reference frame
- Provides a strong indication that one GOES-16 and all three GOES-13 OB mag measurements are accurate geomagnetic field representations considering
 - That the two observatories were independently designed, developed, and calibrated and still show this agreement
 - The “nonsingular” form of the observatory’s baselined design documents derived G13-to-G16 mag sensor measurement transformation matrix elements
 - $MFOBG13_2_MFOBG16 = [-0.5665 \ -0.6987 \ 0.4460]$ (defines the “virtual” GOES-13 x-axis measurement from GOES-13 sensor measurements)
 - All three GOES-13 mag sensor measurements make significant contribution to the overlaid G16 mag sensor DOF measurement
 - This strongly indicates that all three GOES-13 mag sensor measurements are accurate geomagnetic field measurements
 - Mapping from the GOES-16 x-axis mag measurement to the three GOES-13 mag sensor measurements produce accurate results in a least squares sense
- The GOES-16/“virtual GOES-13” magnetometer x-axis measurement overlay result indicates that **GOES-13 is a Useful Three-Axis Geomagnetic Field Measurement Truth Source**

Determine the GOES-16 wrt GOES-13 Diurnal Error Curve for the IB & OB Mags from 08-Dec-2016 thru 02-Jan-2018 Flow Chart

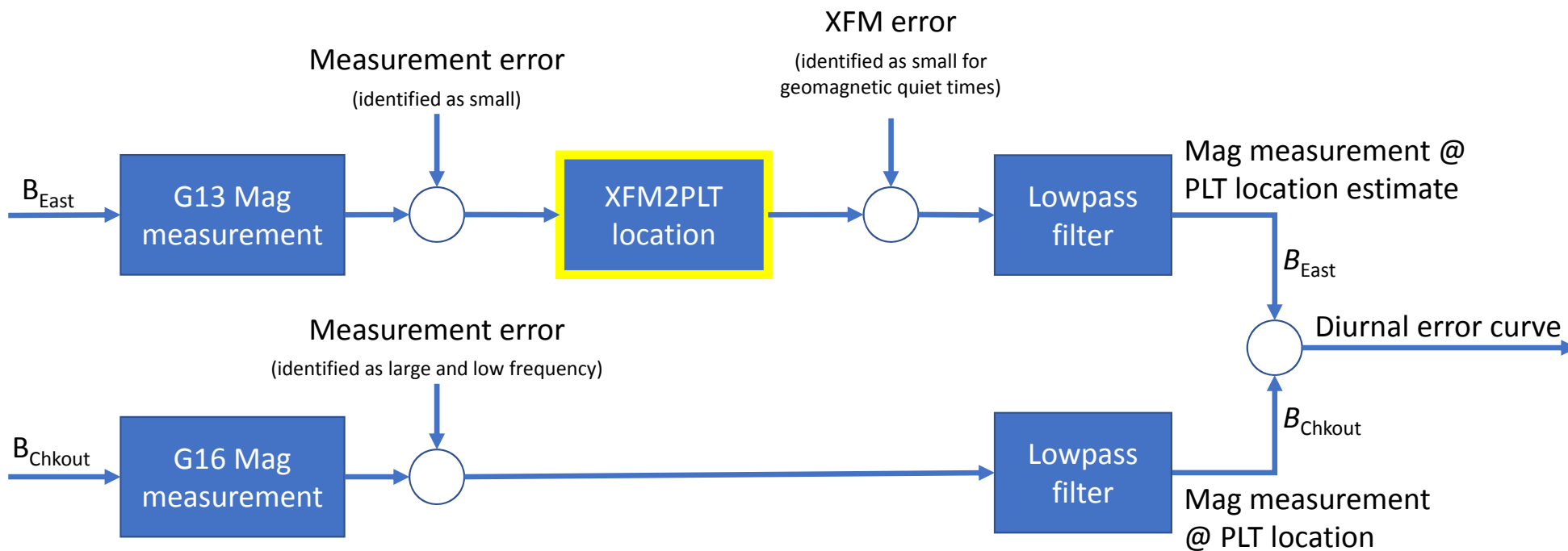

Use GOES-13 Geomagnetic Field Measurements as a Truth Source during G16/G13 Non-collocation

- GOES-16 and GOES-13 produced geomagnetic field measurements during the non-collocated time period from 08-Dec-2016 thru 29-Nov-2017
- During the non-collocated time period, GOES-16 was at 89.5° W (PLT Checkout location) and GOES-13 was at 75.0° W (Operational East location)
- To use GOES-13 mag measurements as a truth source for GOES-16 during the non-collocated time period, adjustments were made to the GOES-13 measurements to derive equivalent GOES-13 measurements at the Checkout location
- To compensate for the difference in orbit locations, the GOES-13 magnetometer measurements were
 - time shifted to the Checkout location
 - bias shifted to the Checkout location
- The GOES-13 magnetometer measurement bias shifts to the Checkout location were determined from the GOES-NOP constellation magnetometer flight data
 - GOES-15 was at the Checkout location from 01-Jan-2011 thru 20-Oct-2011 simultaneously with GOES-13 being at the East location
 - GOES-15 OB mag measurements were then bias shifted to align with the GOES-13 OB mag measurements (negate these values to bias shift from the East-to-Checkout locations)

GOES-Checkout Mag Measurements (GOES-15) Alignment with GOES-East Mag Measurements (GOES-13)

GOES-15: Blue
GOES-13: Red

E-axis

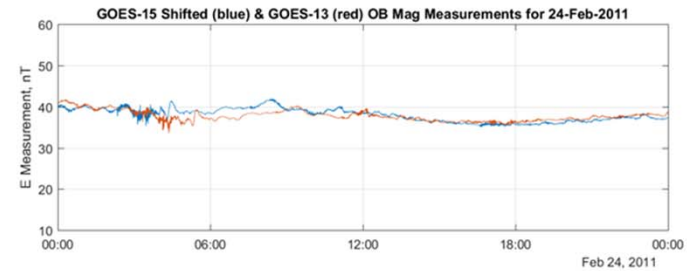
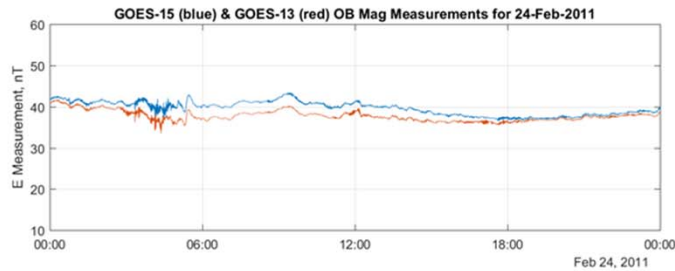

P-axis

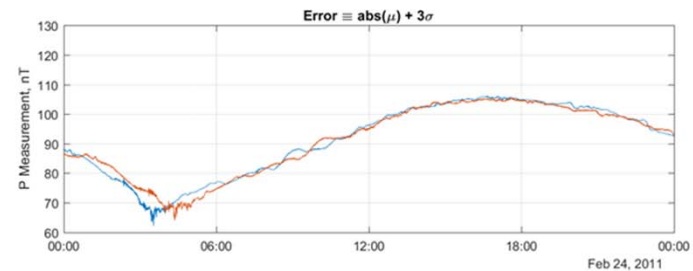
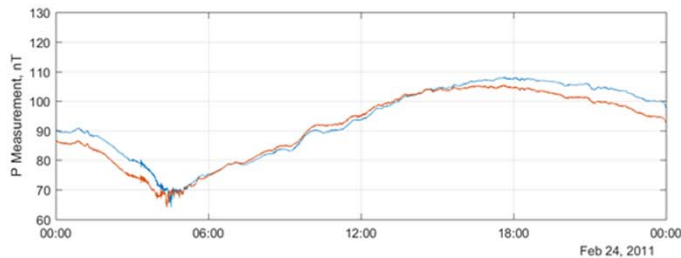

N-axis

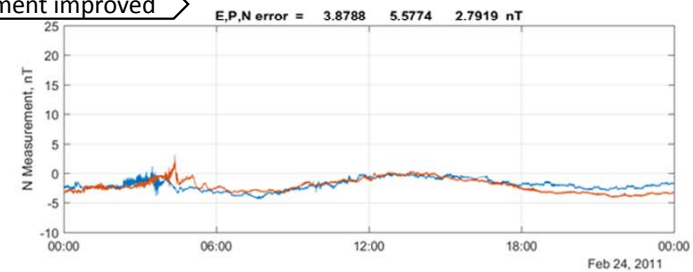

Measurement agreement improved

Unshifted Comparison

GOES-15 Time & Bias Shifted Comparison

GOES-Checkout Mag Measurements (G15) Alignment with GOES-East Mag Measurements (G13) LPF'd, 2/2

GOES-15: Blue
GOES-13: Red

E-axis

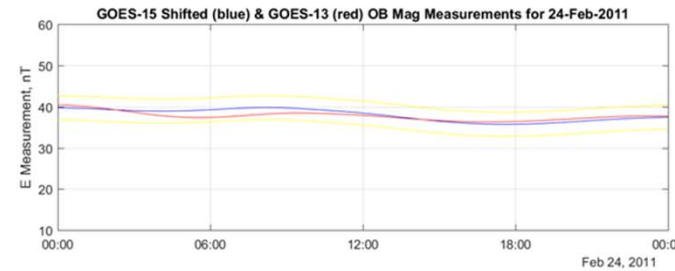
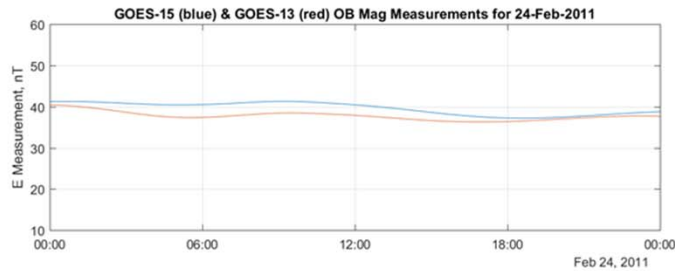

Measurements low-pass filtered to better approximate quiet day geomagnetic behavior

P-axis

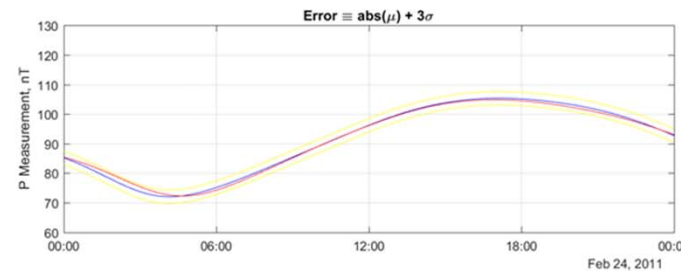
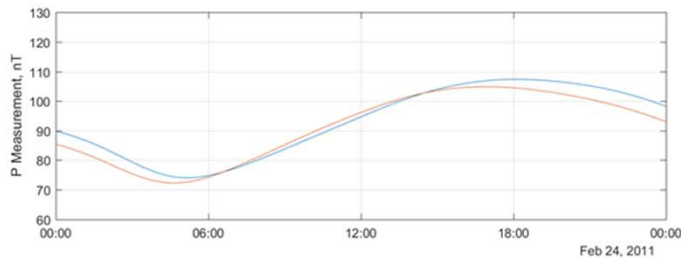

N-axis

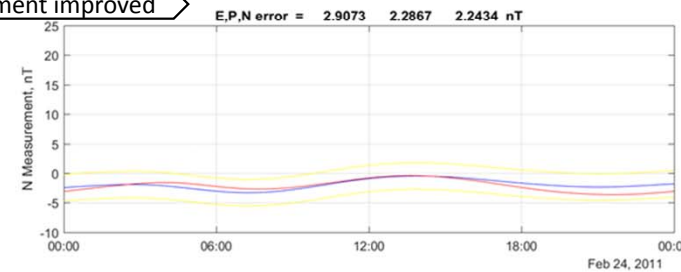
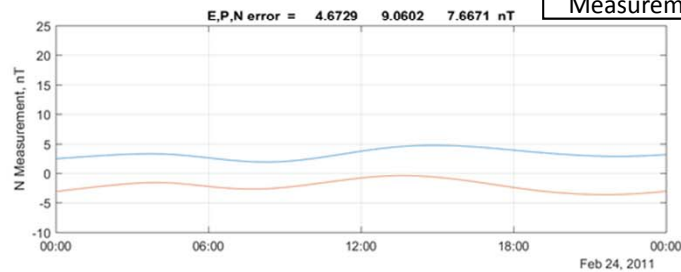

Measurement agreement improved

Unshifted Comparison

GOES-15 Time & Bias Shifted Comparison

GOES-East to GOES-PLT Geomagnetic Field Measurement Time and Bias Shift Estimates

- The GOES-NOP Constellation based time and bias shifts identified for relating GOES-East location magnetometer measurements to GOES-Checkout location magnetometer measurements were used in support of GOES-16 magnetometer measurement anomaly correction
- This permitted GOES-13 magnetometer measurements to be used as a reference source for GOES-16 mag anomalous measurement correction identification for both the non-collocated (08-Dec-2016 thru 29-Nov-2017) and collocated (10-Dec-2017 thru 02-Jan-2018) GOES-16/GOES-13 simultaneous operation time periods

GOES-16 Magnetometer Measurement Anomaly Performance Recovery Method and Results

- Identify valid geomagnetic field reference source
 - GOES-13 at GOES-East location identified as valid truth source during GOES-16 collocation with GOES-13
 - Extended GOES-13 truth source usefulness from GOES-East location to GOES-Checkout (PLT) location based on GOES-NOP Series magnetometer historical data (GOES-15 at Checkout location and GOES-13 at East location)
 - Useful GOES-13 based truth source data to support GOES-16 performance recovery obtained from 08-Dec-2016 thru 02-Jan-2018
- **Determine diurnal error curves of GOES-16 mag measurements with respect to GOES-13 mag measurements from 08-Dec-2016 thru 02-Jan-2018**
- Derive diurnal correction curves using GOES-16 mag anomaly model to apply to GOES-16 mag measurements from 08-Dec-2016 thru 02-Jan-2018
- Capture diurnal correction curves into solar-angle synchronized look-up table
- Compare corrected GOES-16 magnetometer measurement performance results wrt the GOES-16 anomalous magnetometer measurement performance results

Determine the GOES-16 wrt GOES-13 Diurnal Error Curve for the IB & OB Mags from 08-Dec-2016 thru 02-Jan-2018 Flow Chart

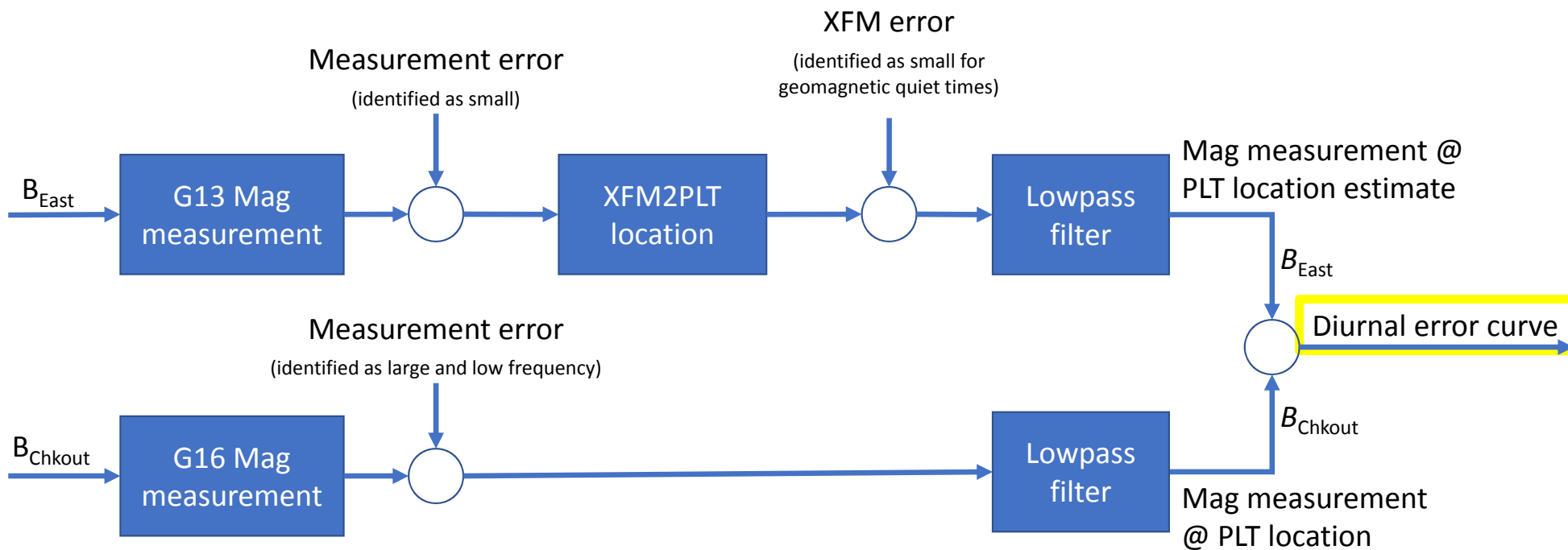

Estimated G16 IB & OB Diurnal Anomaly Error Curves wrt G13 for 26-Feb-2017

G16 wrt G13 IB Diurnal Error Curve: Green
G16 wrt G13 OB Diurnal Error Curve: Red
G16 OB wrt IB Diurnal Difference Curve: Blue

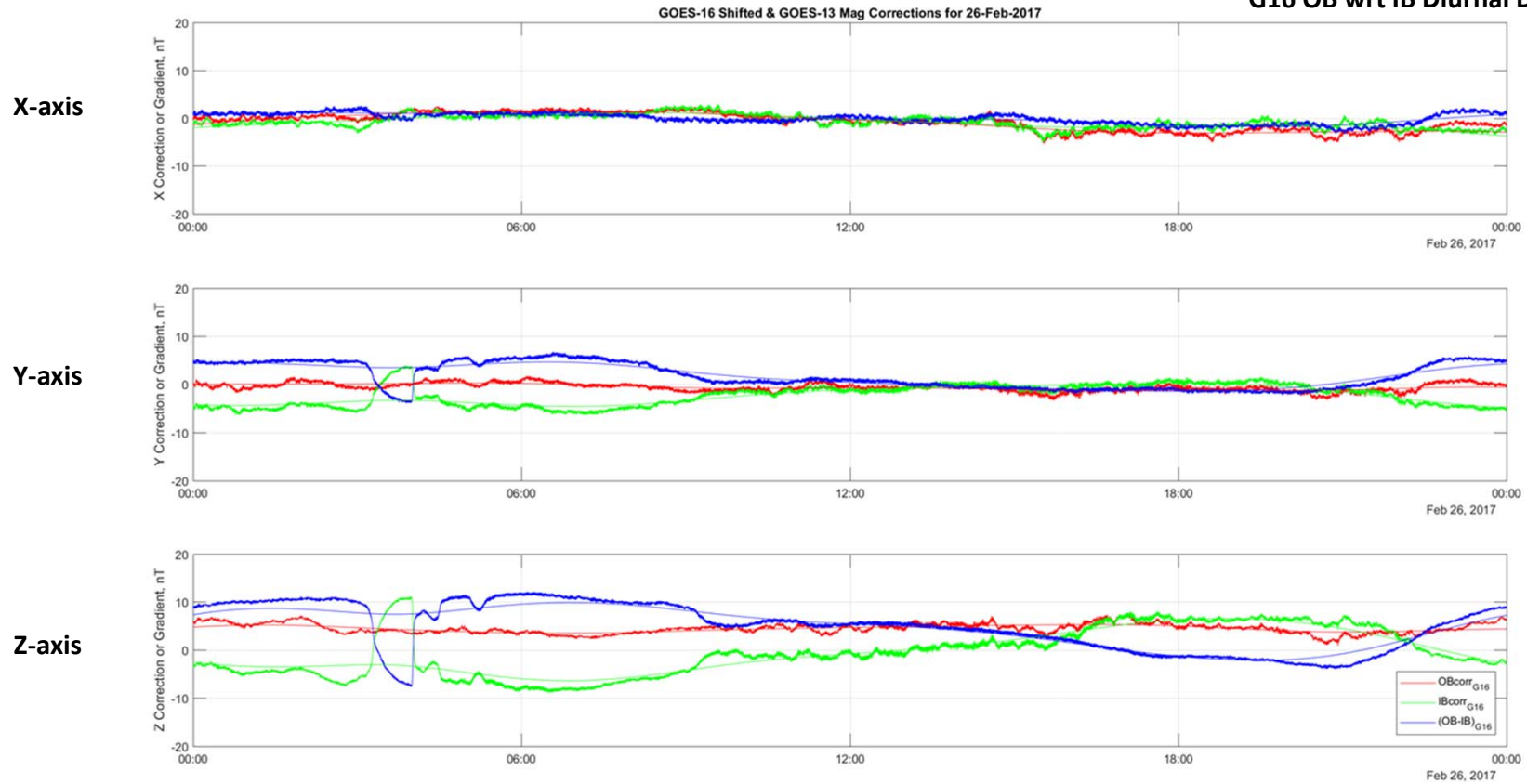

GOES-16 Magnetometer Measurement Anomaly Performance Recovery Method and Results

- Identify valid geomagnetic field reference source
 - GOES-13 at GOES-East location identified as valid truth source during GOES-16 collocation with GOES-13
 - Extended GOES-13 truth source usefulness from GOES-East location to GOES-Checkout (PLT) location based on GOES-NOP Series magnetometer historical data (GOES-15 at Checkout location and GOES-13 at East location)
 - Useful GOES-13 based truth source data to support GOES-16 performance recovery obtained from 08-Dec-2016 thru 02-Jan-2018
- Determine diurnal error curves of GOES-16 mag measurements with respect to GOES-13 mag measurements from 08-Dec-2016 thru 02-Jan-2018
- **Derive diurnal correction curves using GOES-16 mag anomaly model to apply to GOES-16 mag measurements from 08-Dec-2016 thru 02-Jan-2018**
- Capture diurnal correction curves into solar-angle synchronized look-up table
- Compare corrected GOES-16 magnetometer measurement performance results wrt the GOES-16 anomalous magnetometer measurement performance results

GOES-16 Mag Anomaly Correction LUT Synthesis Data Processing Flow Diagram

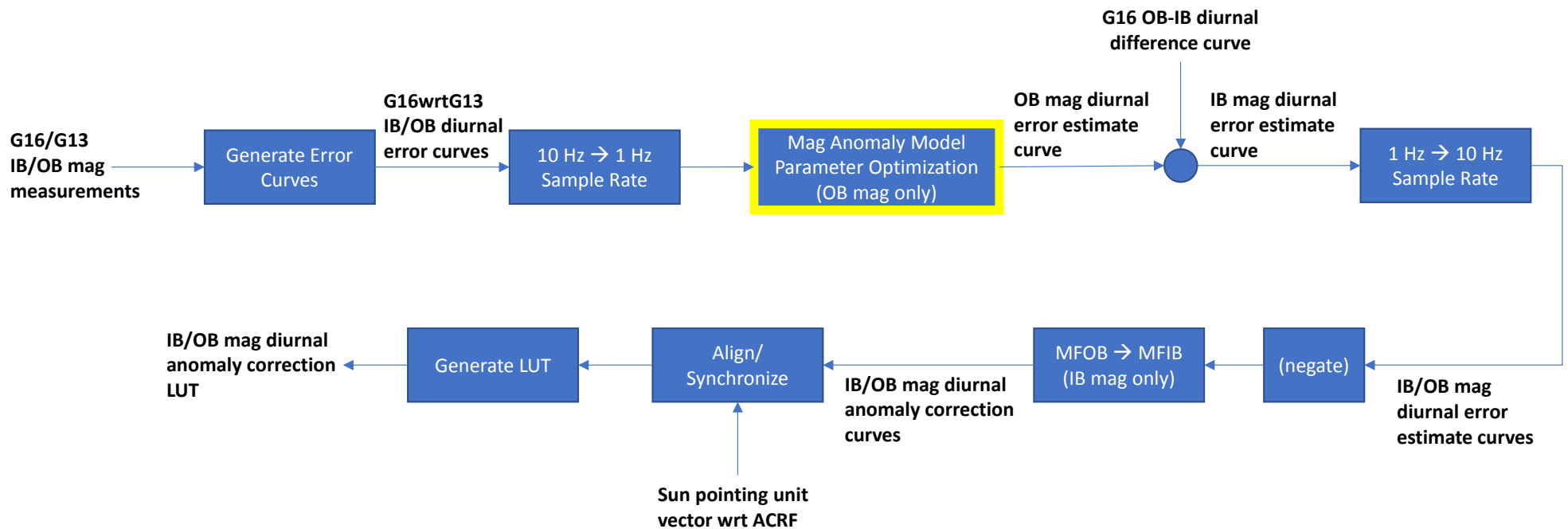

GOES-16 IB/OB Magnetometer Measurement Anomaly Model

- The model captures the essential characteristics of the GOES-16 IB & OB mag anomalies
 - Shadowing response
 - Diurnal Variation
- The model is used in identifying the anomalous signal profile from within the noisy diurnal error curve measurements
- The model is solar-angle driven
 - Geometry-based rather than a time-based event triggers
 - Permits independence from orbit location and time changes
- The model form consists of exp decay and growth functions with varying solar-angle driven time constants
- The model inputs are
 - Sun azimuth and elevation angles relative to the local magnetometer reference frame
 - Measured diurnal error curve
- The model output is an estimate of the magnetometer anomalous diurnal behavior
- The model estimate of the diurnal error curve is compared against the measured diurnal error curve and the resultant mismatch is reduced using a model parameter optimization technique

GOES-16 IB/OB Magnetometer Anomaly Model Functional Form for Shadowing and Diurnal Variation Effects

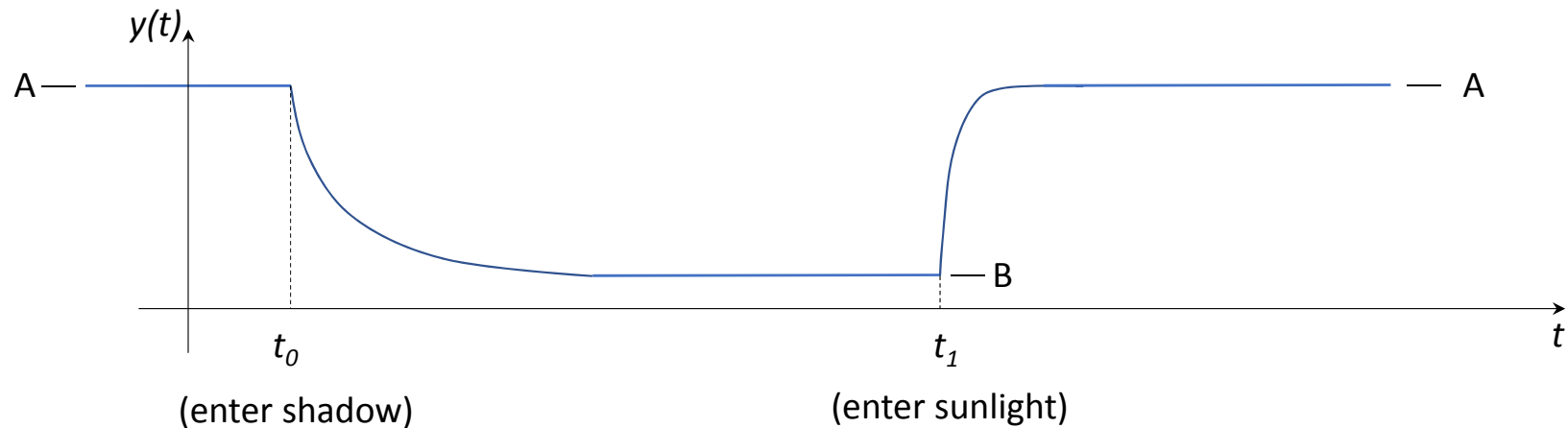

$$y(t) = \begin{cases} A, & t \leq t_0 \\ B + (A - B)e^{-\frac{t-t_0}{\tau_0}}, & t_0 \leq t \leq t_1 \\ A + (B - A)e^{-\frac{t-t_1}{\tau_1}}, & t_1 \leq t \end{cases}$$

A , B , time constants, and shadow entry/exit are variable

GOES-16 IB/OB Magnetometer Anomaly Model Block Diagram, 1/3

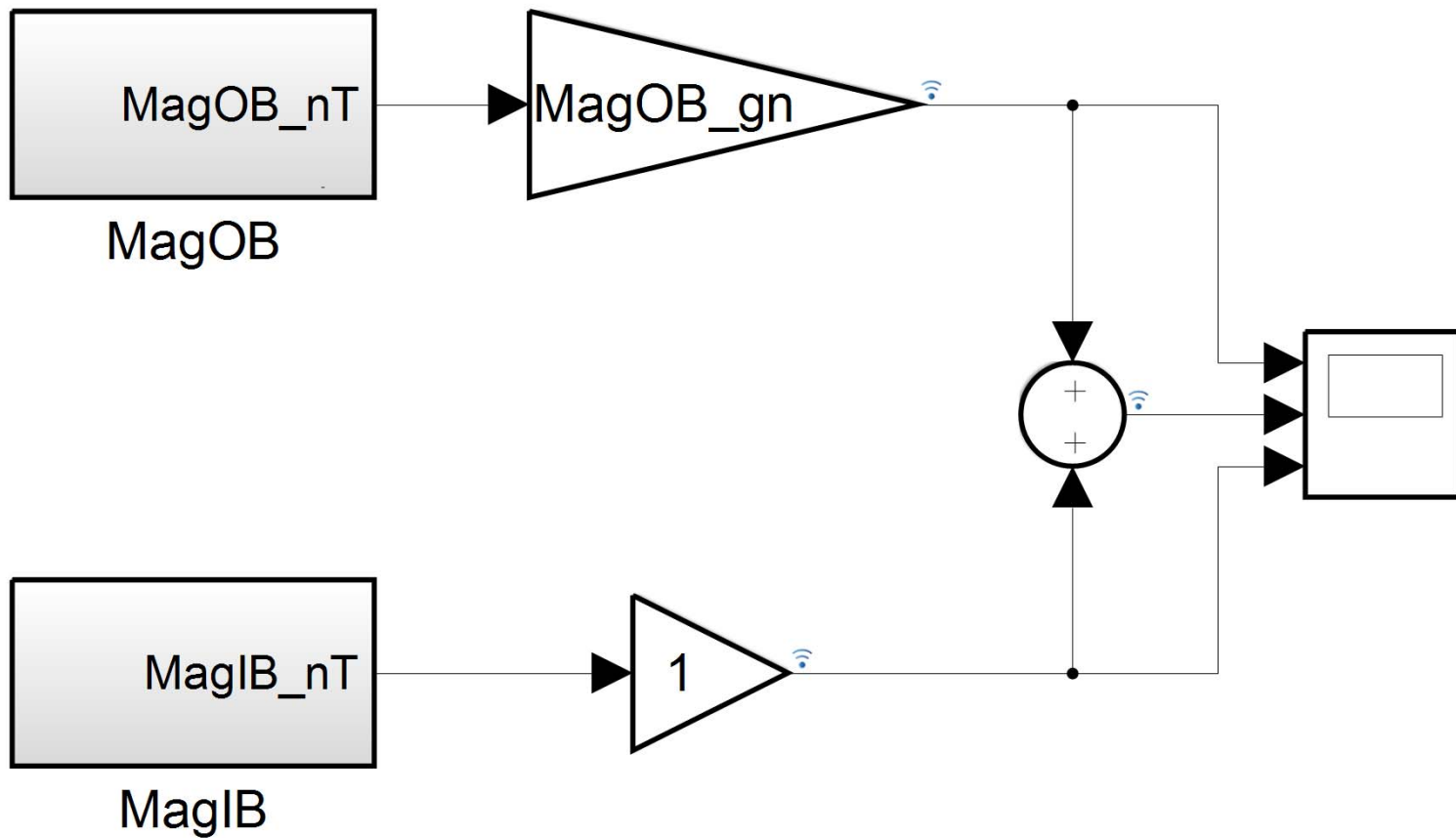

GOES-16 IB/OB Magnetometer Anomaly Model Block Diagram, 2/3

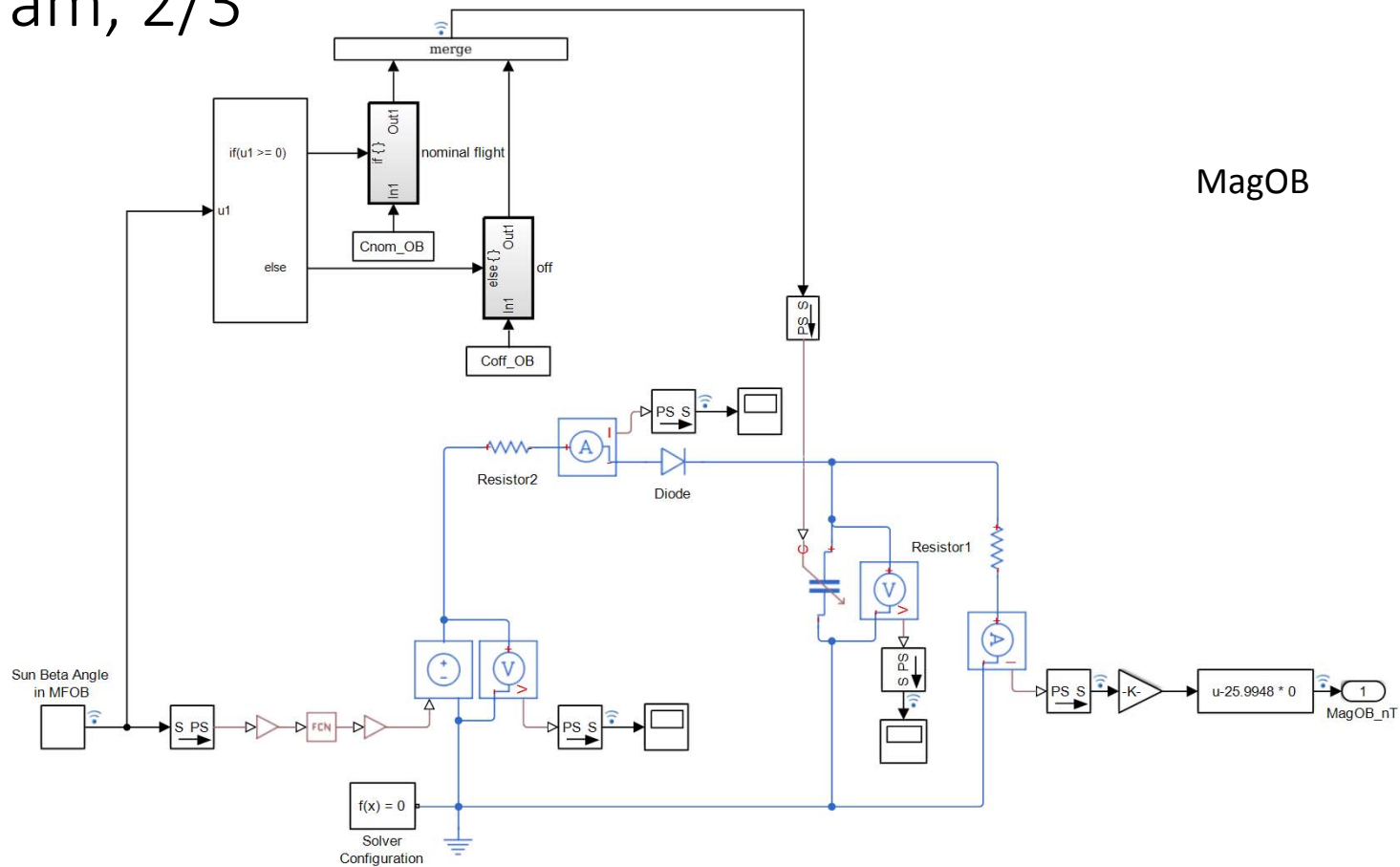

MagOB

GOES-16 IB/OB Magnetometer Anomaly Model Block Diagram, 3/3

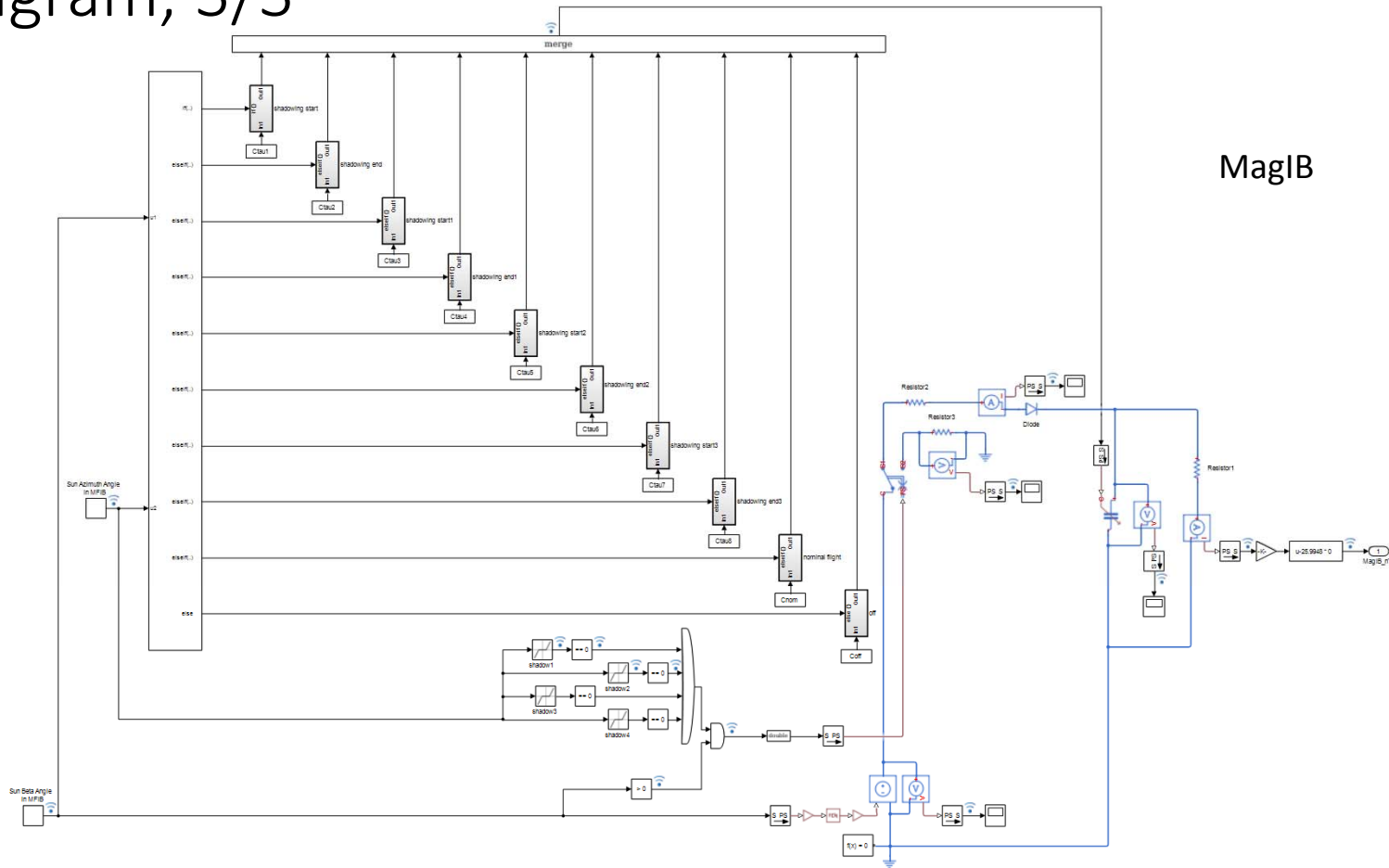

GOES-16 OB Magnetometer Anomaly Model Result Comparisons: 26-Feb-2017 (Non-Collocation)

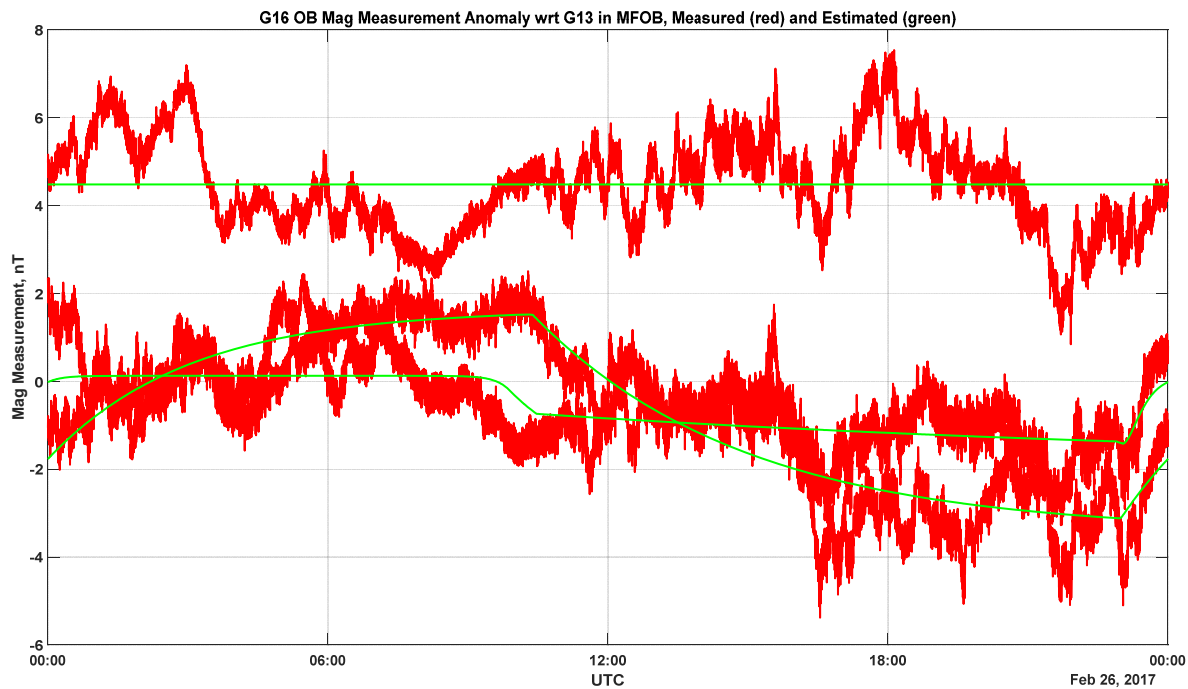

Measured OB mag diurnal error curve: red
Estimated OB mag diurnal error curve: green

GOES-16 Mag Anomaly Correction LUT Synthesis Data Processing Flow Diagram

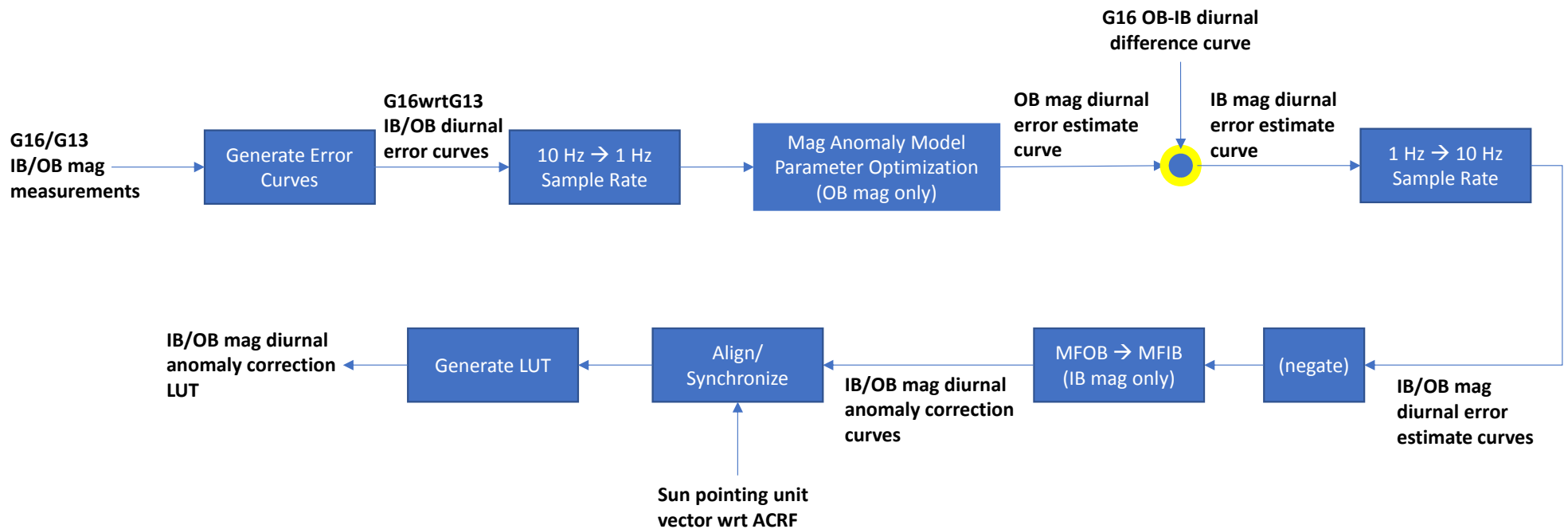

GOES-16 Measured OB-IB Diurnal Difference Curves: 26-Feb-2017 (Non-Collocation)

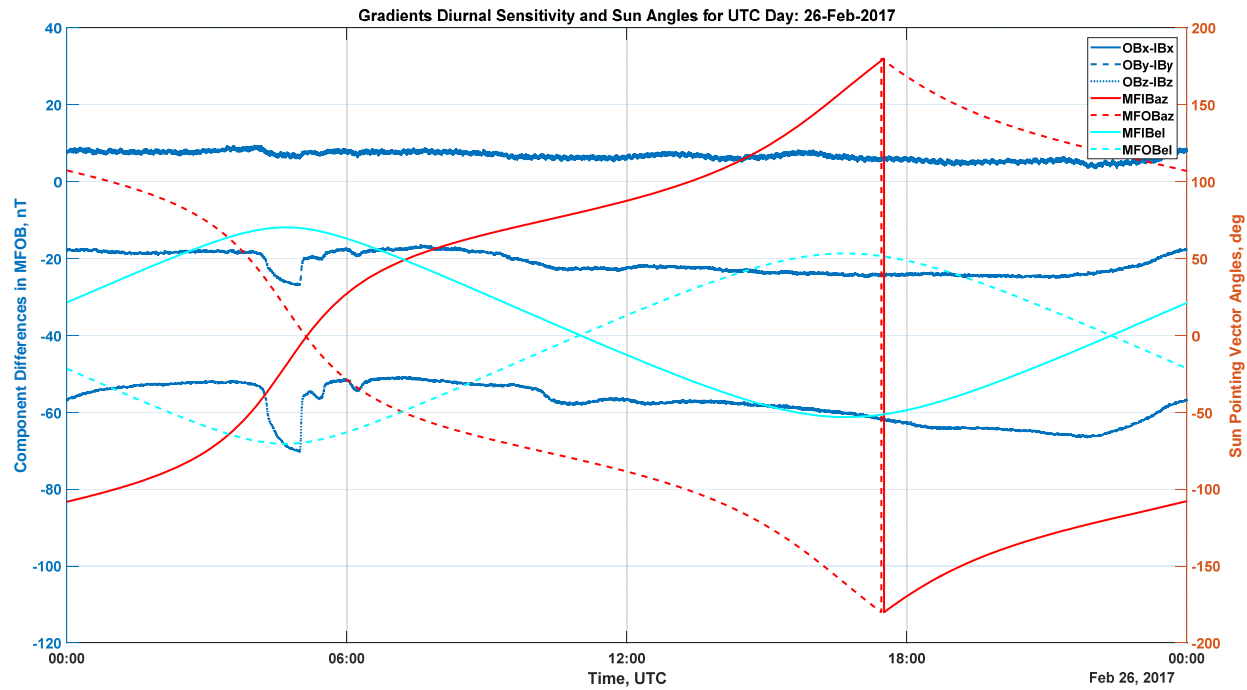

Measured OB-IB diurnal difference curve: dark blue
Solar Az/EI angles wrt local mag reference frame: light blue/red

GOES-16 IB Magnetometer Anomaly Model Result Comparisons: 26-Feb-2017 (Non-Collocation)

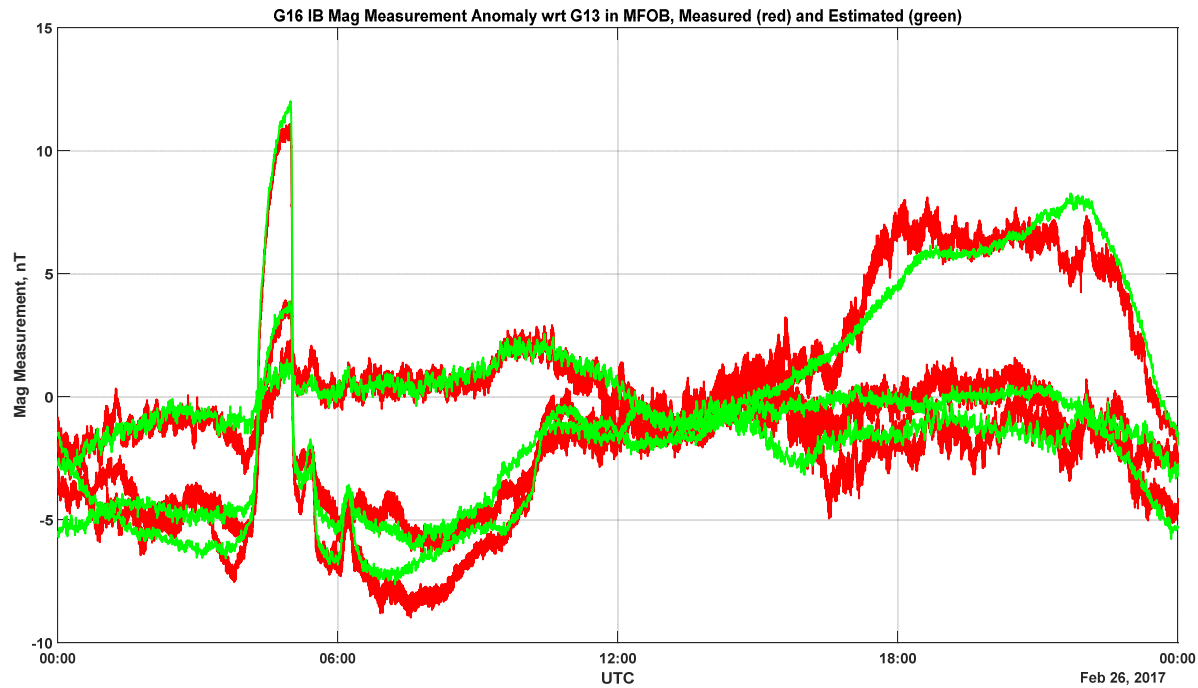

Measured IB mag diurnal error curve: red
Estimated IB mag diurnal error curve: green

GOES-16 Mag Anomaly Correction LUT Synthesis Data Processing Flow Diagram

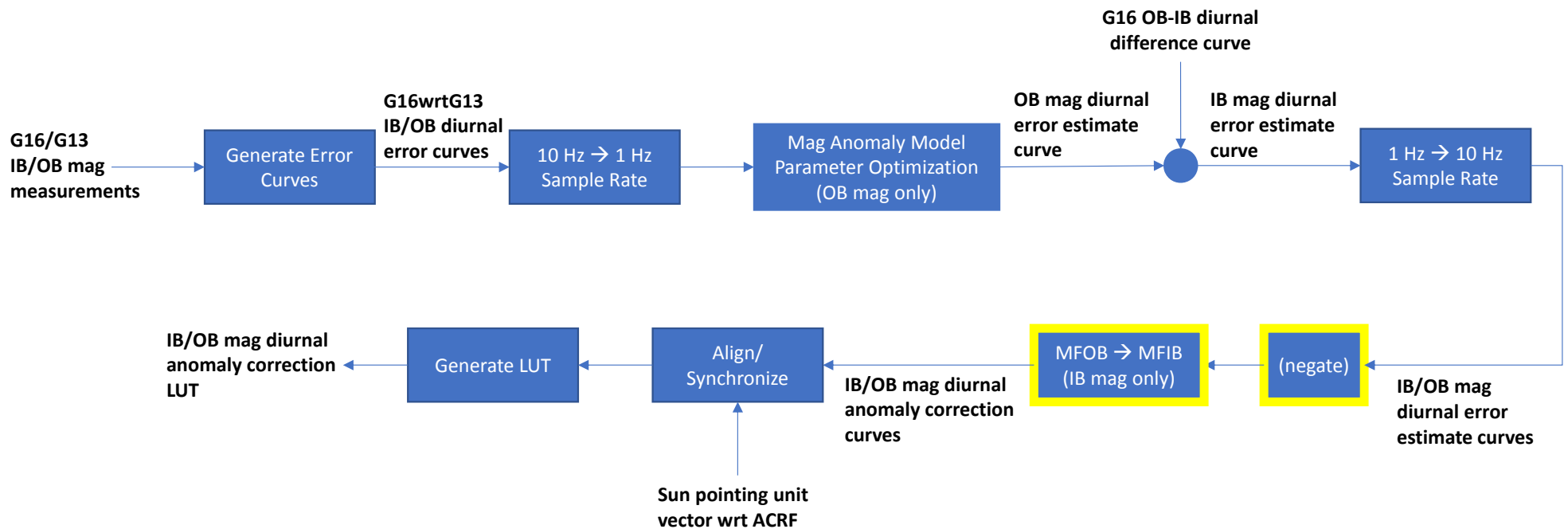

Correcting for GOES-16 PLT Time Frame Induced Mag Measurement Perturbation Events, 1/2

- During GOES-16 PLT the magnetometer system was exposed to various performance recovery trials that perturbed the mag measurement accuracy and that were not subsequently maintained for baseline operation
- The set of diurnal error curves, which form the basis of the diurnal calibration curves, contains the effects of the magnetometer measurement perturbation events
- These magnetometer measurement perturbation events effects were “normalized” out of the diurnal calibration curves (diurnal means) prior to use in the correction algorithm LUT and thereby before being applied to the anomalous mag measurements for operational use
- Note that when the correction algorithm is applied to mag measurement data
 - from the operational baseline configuration, the diurnal difference curves are near zero as expected
 - that includes the mag measurement perturbation events, the diurnal difference curves are offset away from zero as expected

Correcting for GOES-16 PLT Time Frame Induced Mag Measurement Perturbation Events, 2/2

GOES-16 Magnetometer Measurement Error Contributors

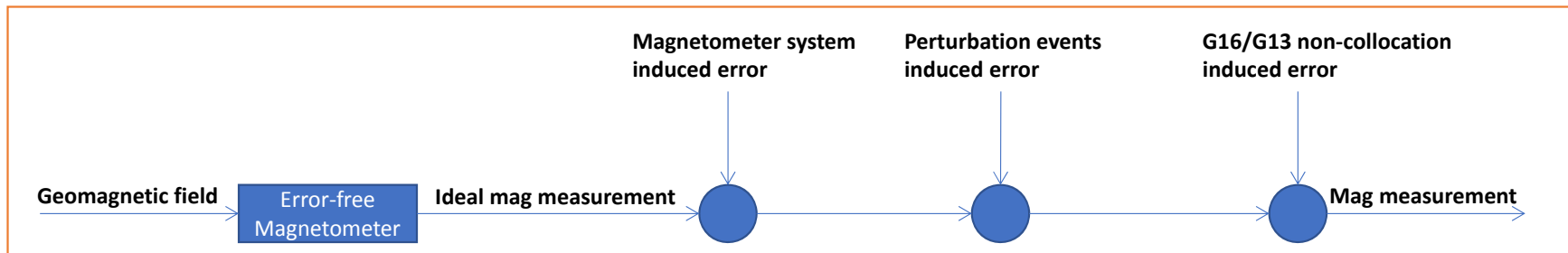

GOES-16 Magnetometer Measurement Applied Corrections

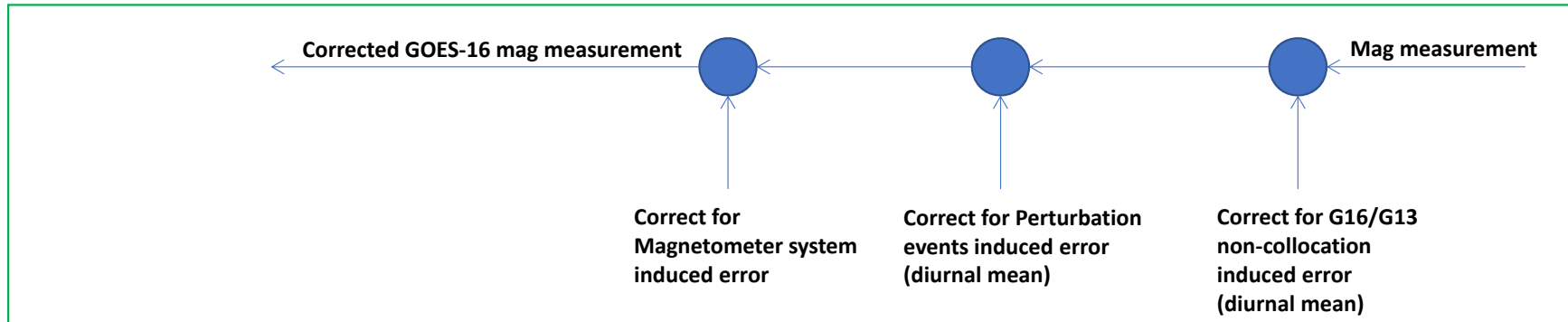

GOES-16 wrt GOES-13 Z-Axis Mag Anomalous Statistics and Performance Metric Results

Mean, nT

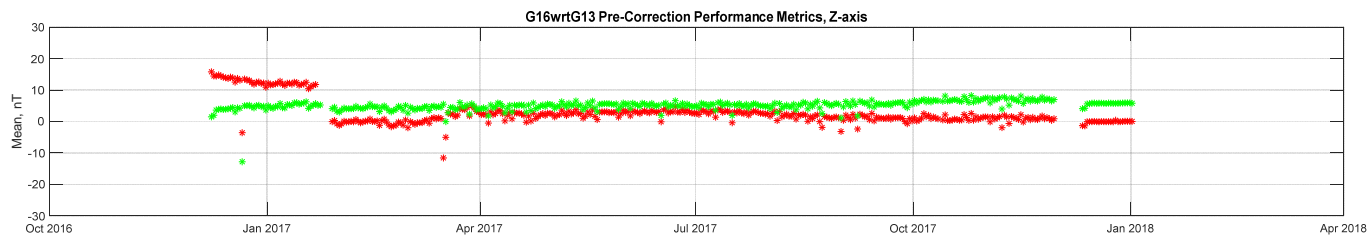

3 Std, nT

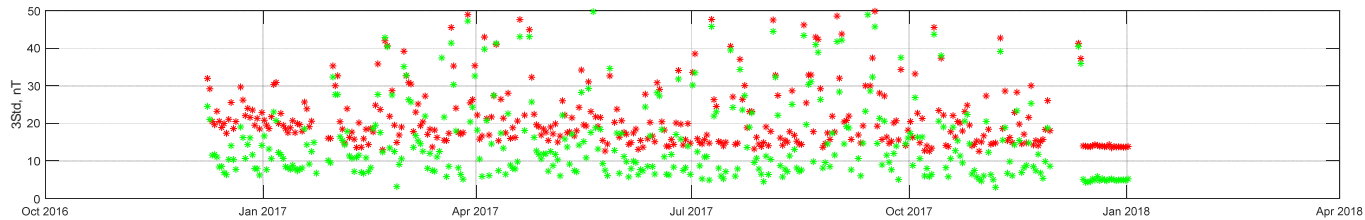

RED: IB mag

GREEN: OB mag

$|\text{Mean}| + 3 \text{ Std, nT}$

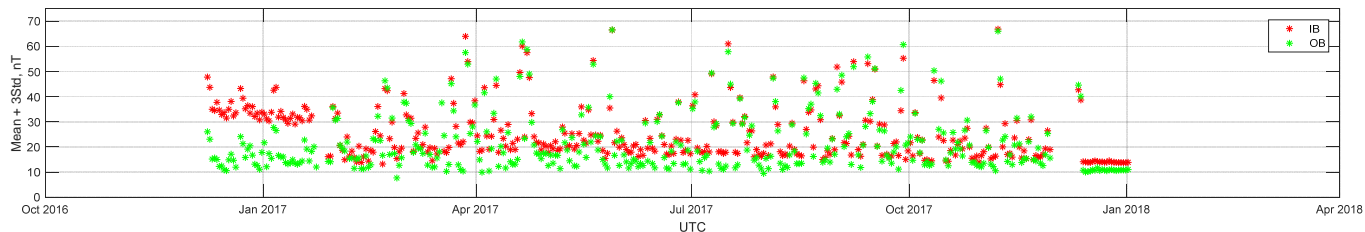

G16 wrt G13 Z-Axis Mag Anomalous Statistics/Perf Metric w/G16 Mag Meas Perturbation Events

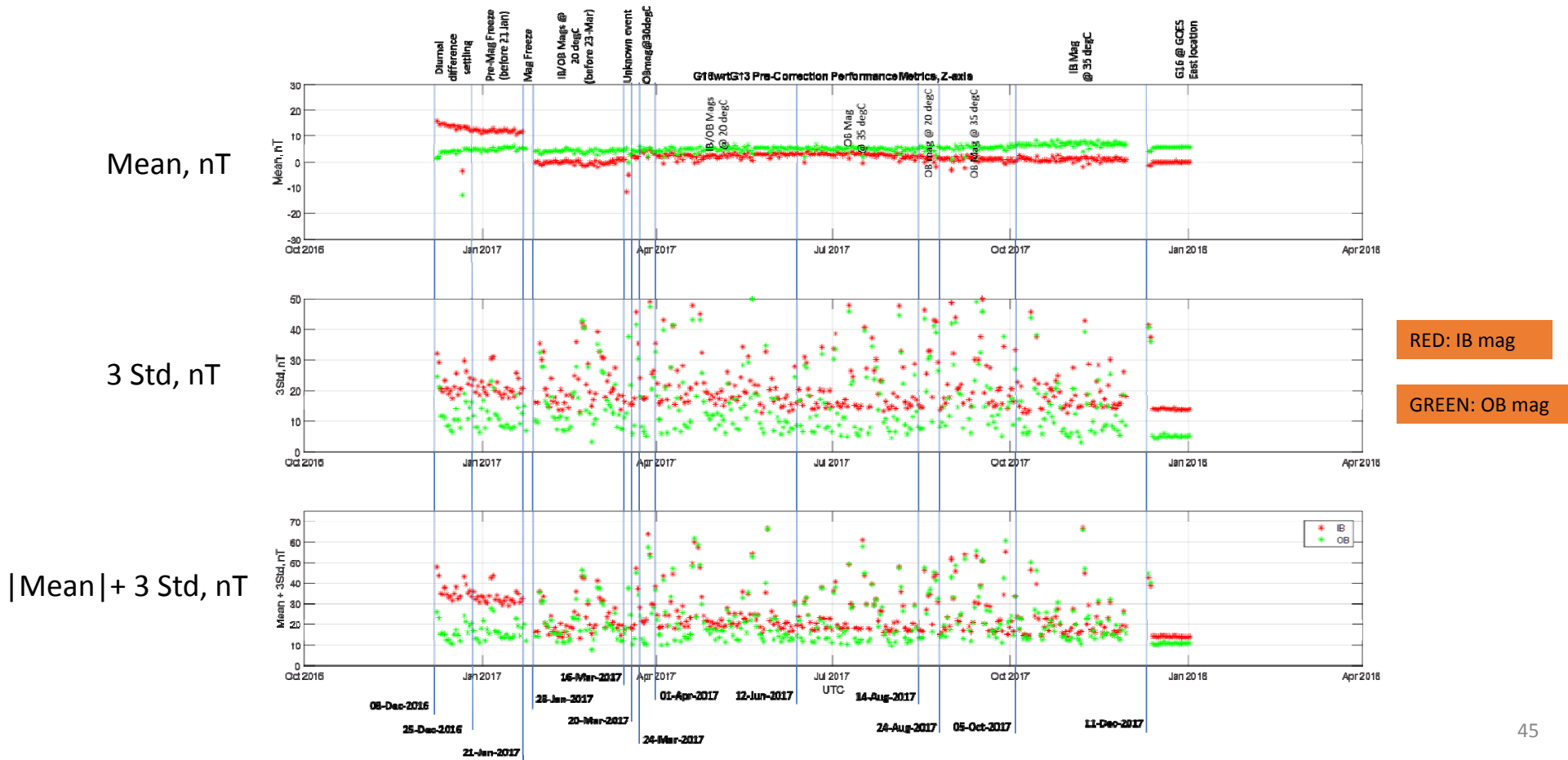

G16 wrt G13 Z-Axis Mag Anomalous Statistics/Perf Metric w/G16 Mag Meas Perturbation Events

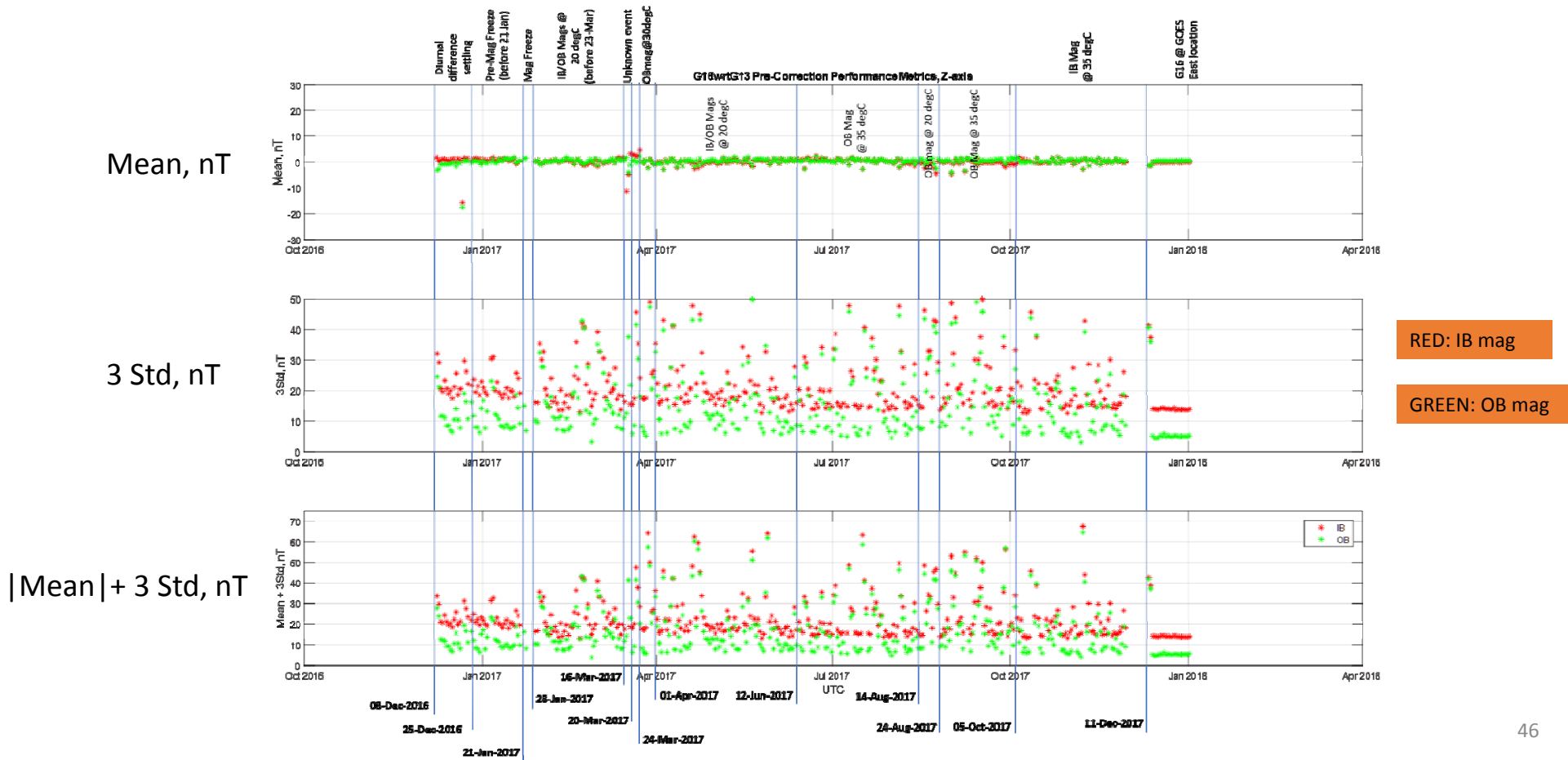

GOES-16 Magnetometer Measurement Anomaly Performance Recovery Method and Results

- Identify valid geomagnetic field reference source
 - GOES-13 at GOES-East location identified as valid truth source during GOES-16 collocation with GOES-13
 - Extended GOES-13 truth source usefulness from GOES-East location to GOES-Checkout (PLT) location based on GOES-NOP Series magnetometer historical data (GOES-15 at Checkout location and GOES-13 at East location)
 - Useful GOES-13 based truth source data to support GOES-16 performance recovery obtained from 08-Dec-2016 thru 02-Jan-2018
- Determine diurnal error curves of GOES-16 mag measurements with respect to GOES-13 mag measurements from 08-Dec-2016 thru 02-Jan-2018
- Derive diurnal correction curves using GOES-16 mag anomaly model to apply to GOES-16 mag measurements from 08-Dec-2016 thru 02-Jan-2018
- Capture diurnal correction curves into solar-angle synchronized look-up table
- Compare corrected GOES-16 magnetometer measurement performance results wrt the GOES-16 anomalous magnetometer measurement performance results

GOES-16 Mag Anomaly Correction LUT Synthesis Data Processing Flow Diagram

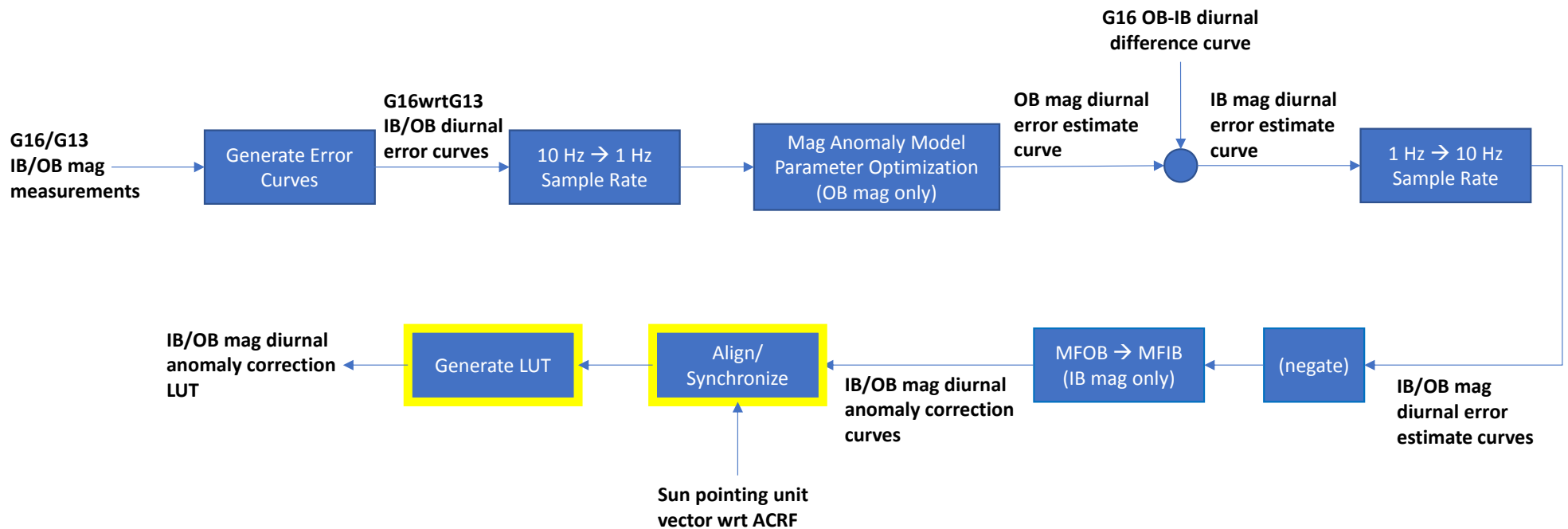

GOES-16 OB Mag Solar-Angle Based Anomaly Correction Performance Results

- The estimated diurnal error curves produced by the mag anomaly model are converted into diurnal correction curves and applied to the magnetometer measurements
- The expected behavior for the corrected magnetometer measurement results is that the GOES-16 measurements approach the behavior of the truth source measurements (GOES-13 at GOES-East)
- The goal is to reduce the measurement uncertainty between the truth source and GOES-16 magnetometers to less than approximately 2.5 nT
- The proposed operational GOES-16 Solar-Angle Based Anomaly Correction Algorithm design is based on a half-year's dataset with Sun angles ranging from summer solstice (21-Jun-2017) to winter solstice (21-Dec-2017)
 - G16/G13 collocated at GOES-East from 10-Dec-2017 thru 02-Jan-2018
- It was assumed that the GOES-16 magnetometer anomalous behavior would behave symmetrically about winter solstice (i.e. from winter solstice to summer solstice) and repeat on an annual basis

Solar-Angle Based Mag Measurement Correction Algorithm Block Diagram

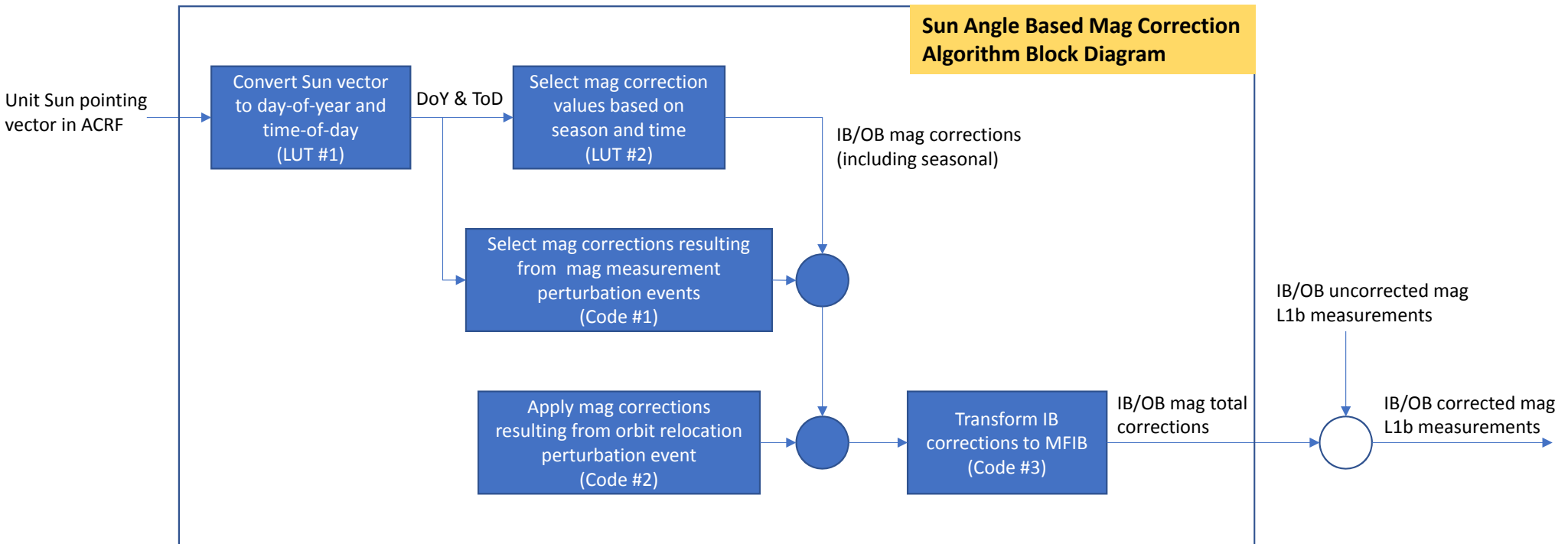

Solar-Angle Based Mag Measurement Correction Algorithm Components

- **Input:** Sun vector wrt ACRF
- **Output:** L1b mag measurement corrections
- **LUT #1:** Half-year transformation from rectilinear Sun pointing vector wrt ACRF to DoY (solar beta angle) and ToD (solar azimuth angle) parameters
 - Defined over time period from summer solstice (June 21st, 2017) to winter solstice (December 21st, 2017)
 - Provides one-to-one mapping from UTC to solar beta angle (Sun pointing vector)
 - DoY & ToD used for identifying mag correction values
 - PLT mag testing, and resultant mag measurement perturbations, essentially complete by this time frame
 - OB mag TCS setpoint changed from 35 degC to 20 degC on 15-Aug-2017 and back again on 26-Aug-2017
- **LUT #2:** Operations time frame (post-Jun 21st, 2017) correction LUT that maps DoY/ToD to IB/OB mag L1b measurement corrections in 3-DoF wrt MFOB
 - OB mag TCS operational setpoint established on 13-Jun-2017
- **Code #1:** Apply corrections due to PLT mag measurement perturbation events
 - IB mag TCS operational setpoint established on 05-Oct-2017
 - GOES-16 mag corrections defined wrt GOES-13 mag measurements
 - Corrections are defined using the GOES-16/GOES-13 collocation time period as reference
- **Code #2:** Apply corrections resulting from GOES-East to GOES-PLT geomagnetic field bias estimate error
 - Corrections are defined using the GOES-16/GOES-13 collocation time period as reference
- **Code #3:** Transform IB mag corrections to MFIB
- Apply corrections to GOES-16 L1b mag measurements
- Make corrected mag measurements available to user

Correction Algorithm LUT#1 Summer Solstice (21-Jun-2017) to Winter Solstice (21-Dec-2017) Defined Solar Beta Angles

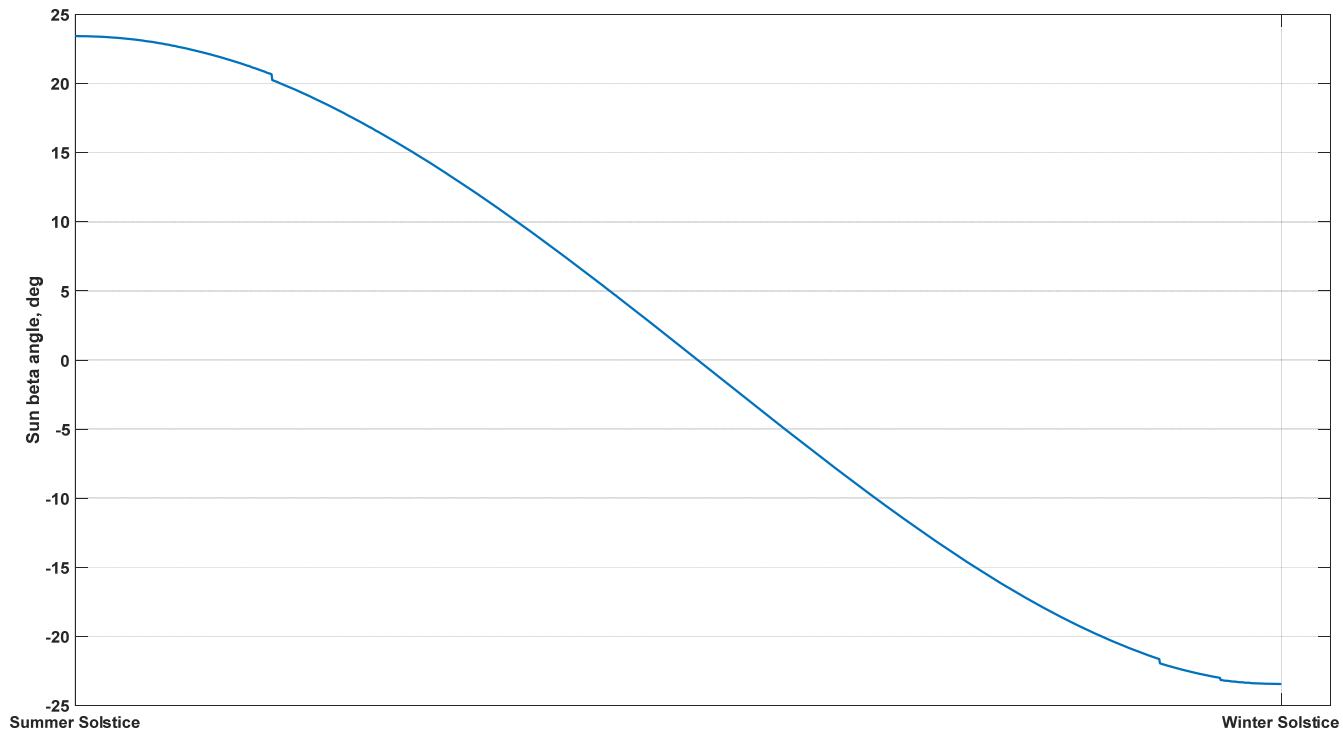

GOES-16 OB Mag Solar-Angle Based Anomaly Correction Alg: Operational & Collocated Performance

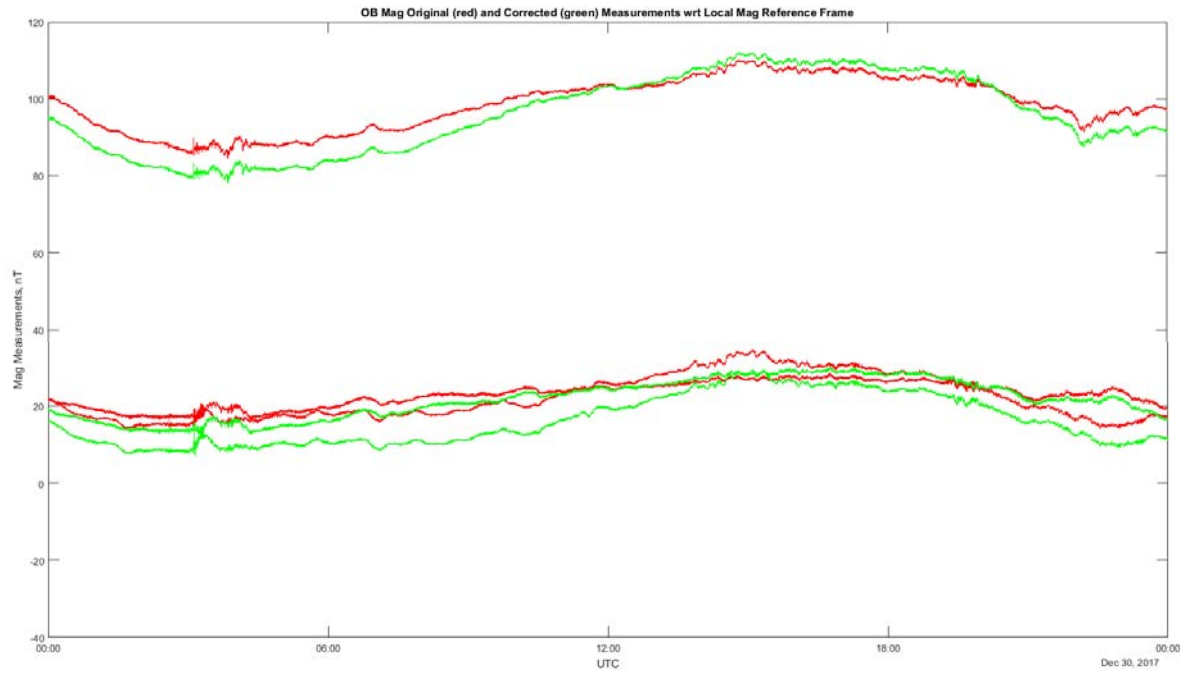

30-Dec-2017

RED: G16 OB mag

GREEN: Corrected G16 OB mag

22-Dec-2017 thru 02-Jan-2018

Not normalized for mag measurement perturbation events & G16/G13 non-collocation

GOES-16 OB Mag Solar-Angle Based Anomaly Correction Alg: Operational & Collocated Performance

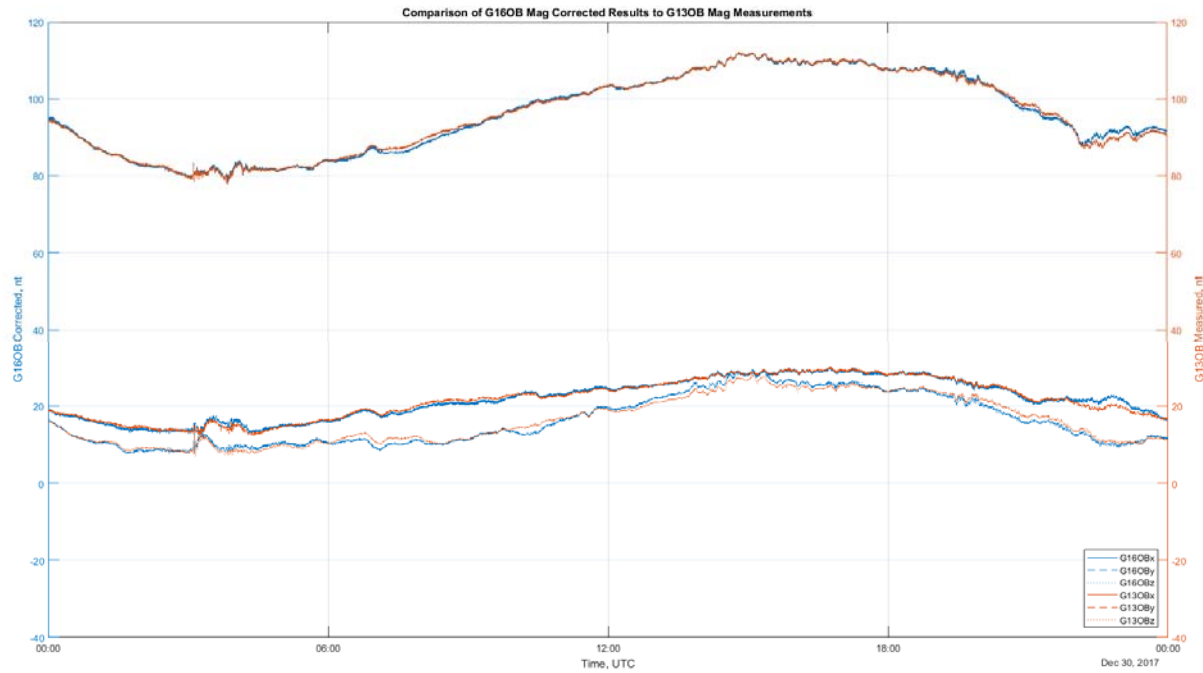

RED: GOES-13

BLUE: Corrected G16 OB mag

30-Dec-2017

22-Dec-2017 thru 02-Jan-2018

GOES-16 OB Mag Solar-Angle Based Anomaly Correction Alg: Operational & Collocated Performance

X

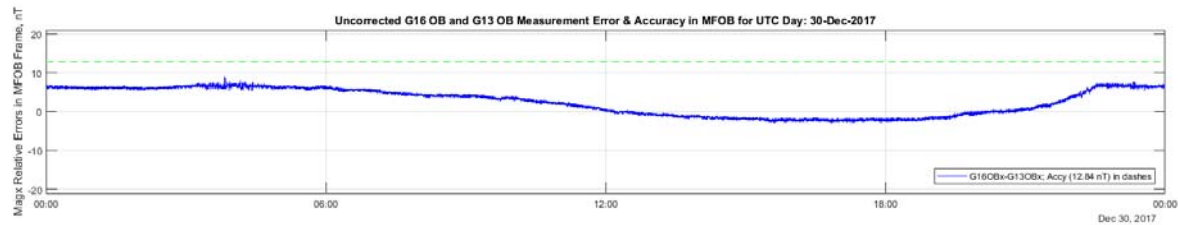

BLUE: err_x, err_y, err_z

Y

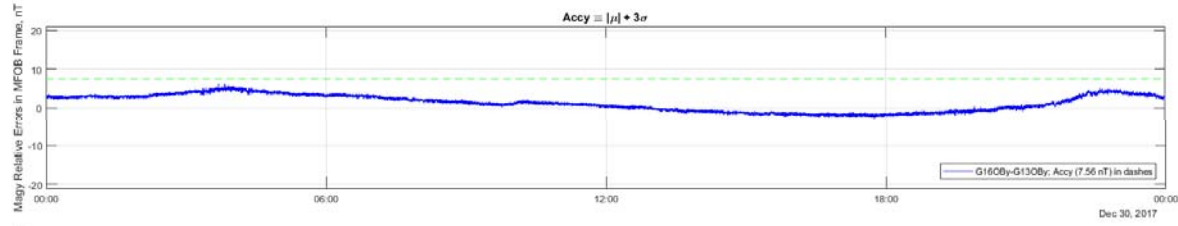

GREEN: x_accy, y_accy, z_accy

Z

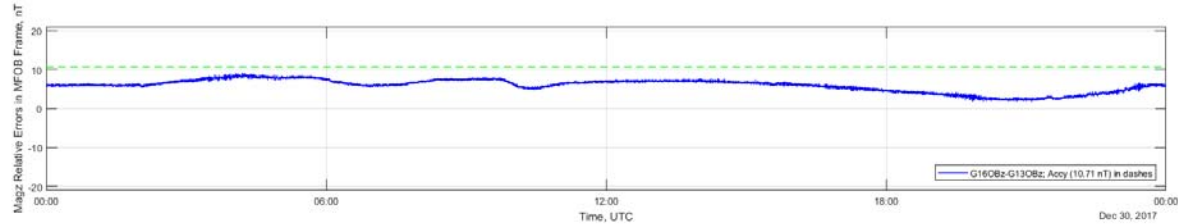

30-Dec-2017

Uncorrected G16 wrt G13 Diurnal Error Curve

22-Dec-2017 thru 02-Jan-2018

GOES-16 OB Mag Solar-Angle Based Anomaly Correction Alg: Operational & Collocated Performance

X

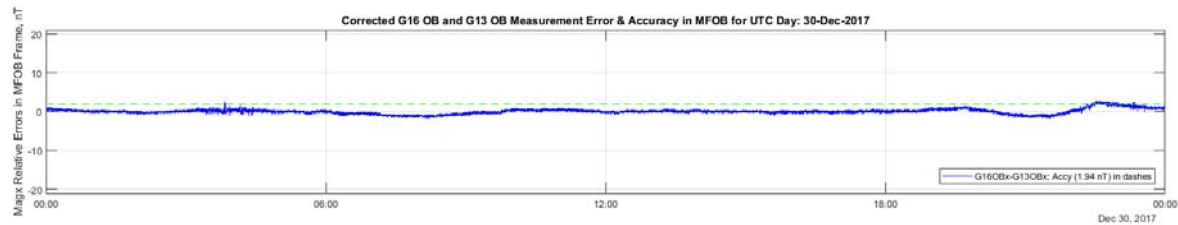

BLUE: err_x, err_y, err_z

Y

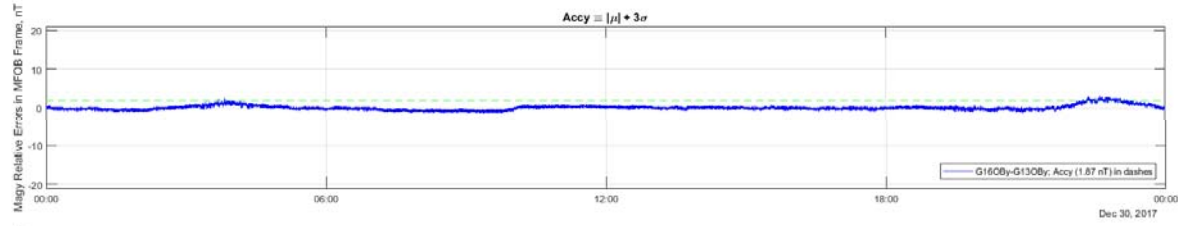

GREEN: x_accy, y_accy, z_accy

Z

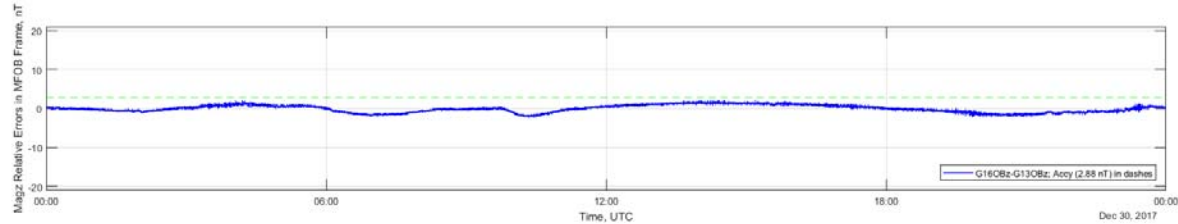

30-Dec-2017

Corrected G16 wrt G13 Diurnal Error Curve

22-Dec-2017 thru 02-Jan-2018

GOES-16 OB Mag Solar-Angle Based Anomaly Correction Alg: Operational & Collocated Performance

X

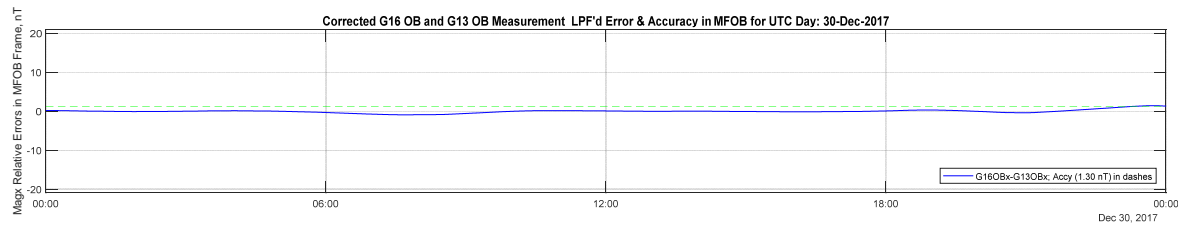

Y

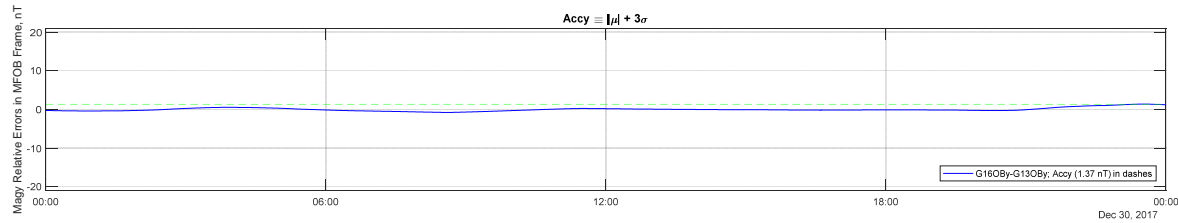

Z

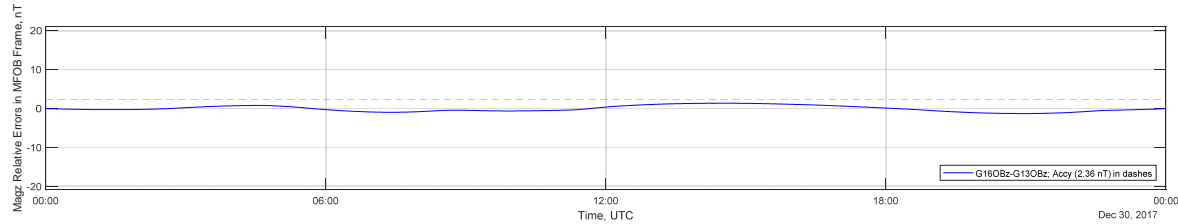

30-Dec-2017

Corrected G16 wrt G13 Diurnal Error Curve

BLUE: err_x, err_y, err_z

GREEN: x_accy, y_accy, z_accy

22-Dec-2017 thru 02-Jan-2018

Not normalized for mag measurement perturbation events & G16/G13 non-collocation

GOES-16 IB Mag Solar-Angle Based Anomaly Correction Alg: Operational & Collocation Performance

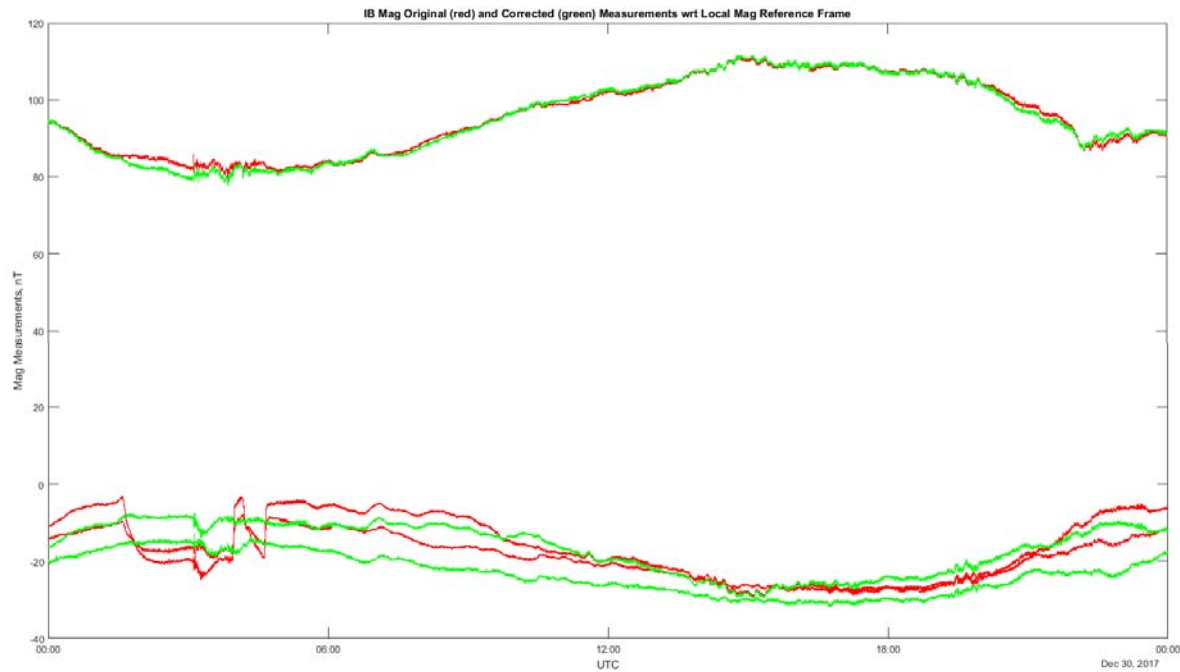

30-Dec-2017

RED: G16 IB mag

GREEN: Corrected G16 IB mag

22-Dec-2017 thru 02-Jan-2018

Not normalized for mag measurement perturbation events & G16/G13 non-collocation

GOES-16 IB Mag Solar-Angle Based Anomaly Correction Alg: Operational & Collocation Performance

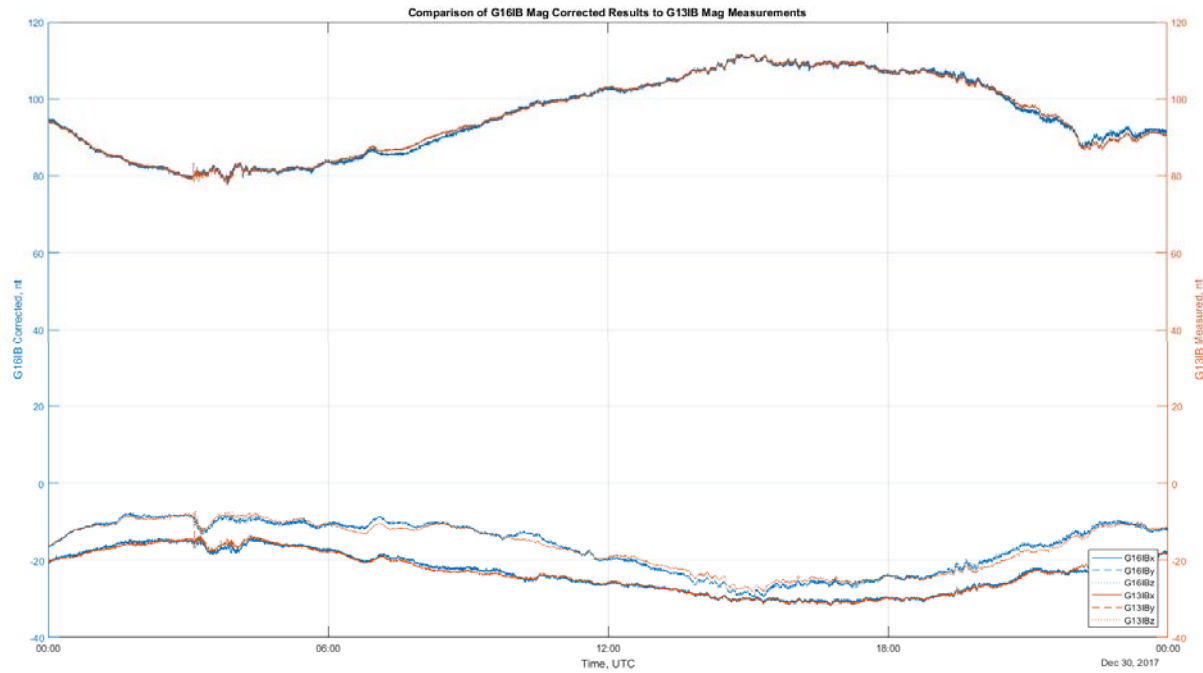

RED: GOES-13

BLUE: Corrected G16 IB mag

30-Dec-2017

22-Dec-2017 thru 02-Jan-2018

GOES-16 IB Mag Solar-Angle Based Anomaly Correction Alg: Operational & Collocation Performance

x

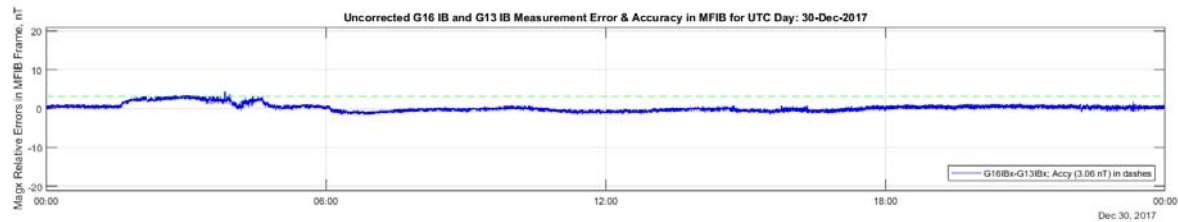

BLUE: err_x, err_y, err_z

y

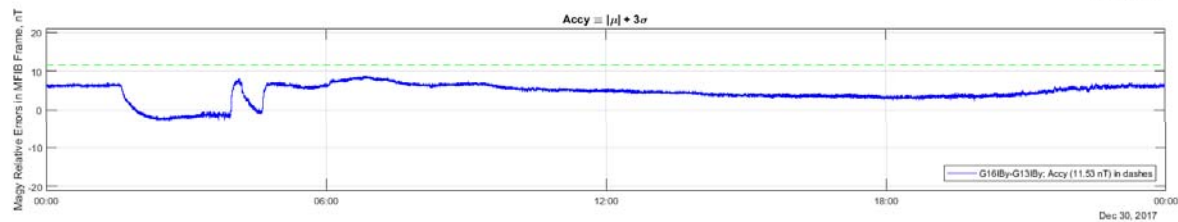

GREEN: x_accy, y_accy, z_accy

z

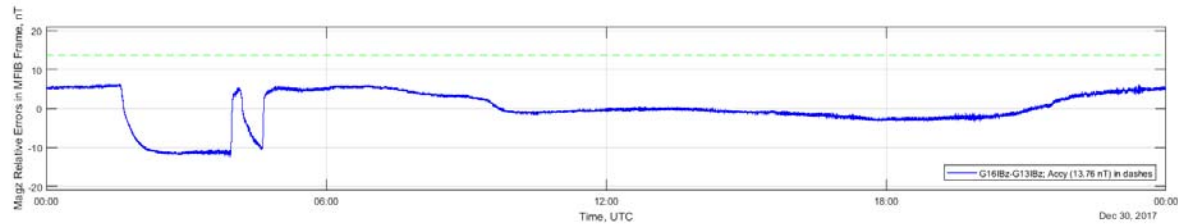

30-Dec-2017

Uncorrected G16 wrt G13 Diurnal Error Curve

22-Dec-2017 thru 02-Jan-2018

GOES-16 IB Mag Solar-Angle Based Anomaly Correction Alg: Operational & Collocation Performance

X

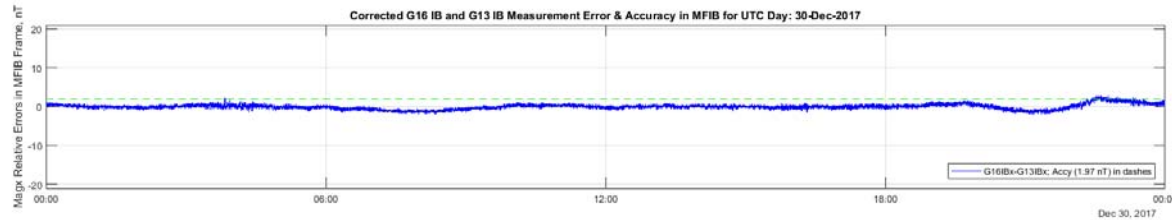

Y

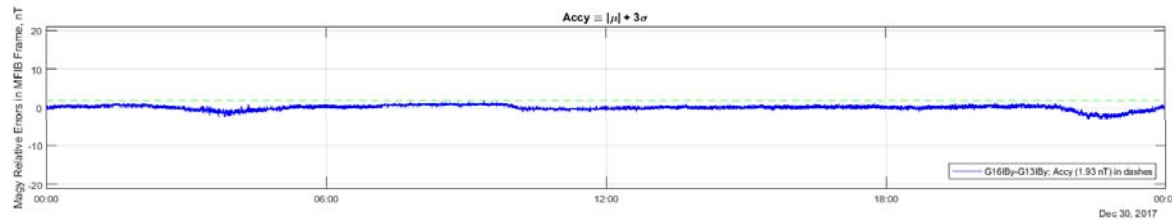

Z

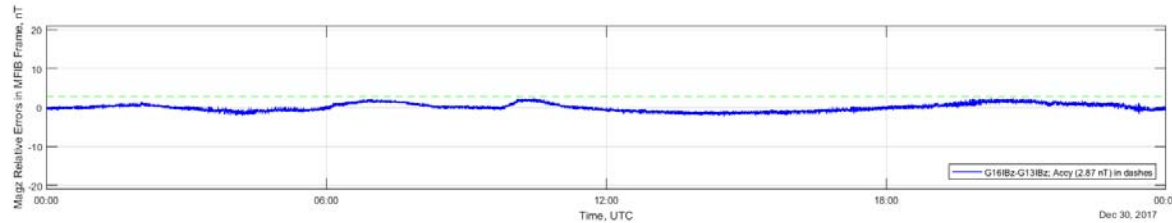

BLUE: err_x, err_y, err_z

GREEN: x_accy, y_accy, z_accy

30-Dec-2017

Corrected G16 wrt G13 Diurnal Error Curve

22-Dec-2017 thru 02-Jan-2018

GOES-16 IB Mag Solar-Angle Based Anomaly Correction Alg: Operational & Collocation Performance

X

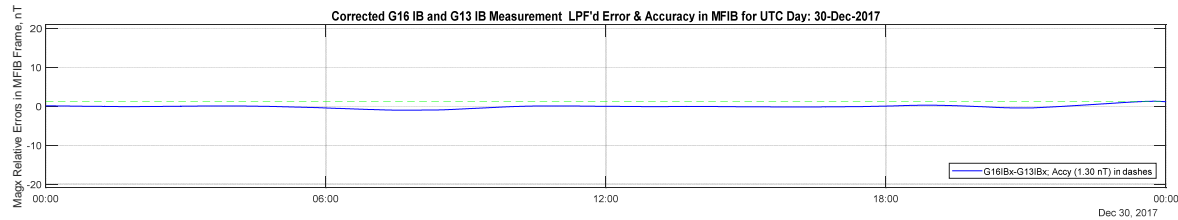

BLUE: err_x, err_y, err_z

Y

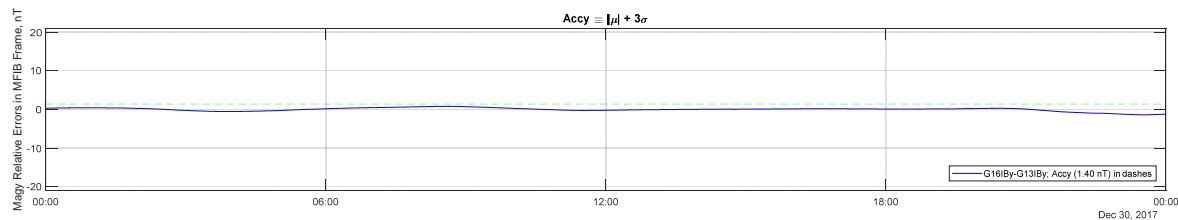

GREEN: x_accy, y_accy, z_accy

Z

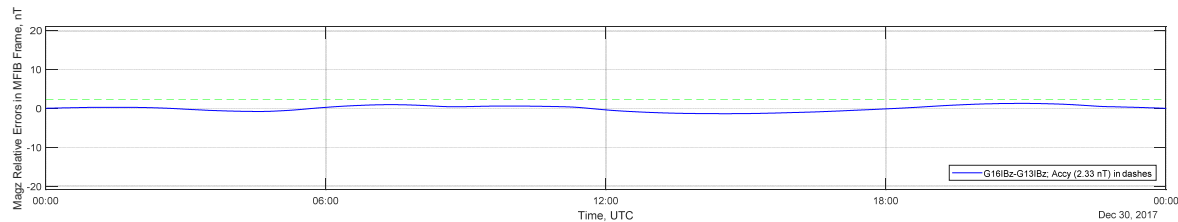

30-Dec-2017

Corrected G16 wrt G13 Diurnal Error Curve

22-Dec-2017 thru 02-Jan-2018

Solar-Angle Based Mag Measurement Correction Algorithm Performance Summary

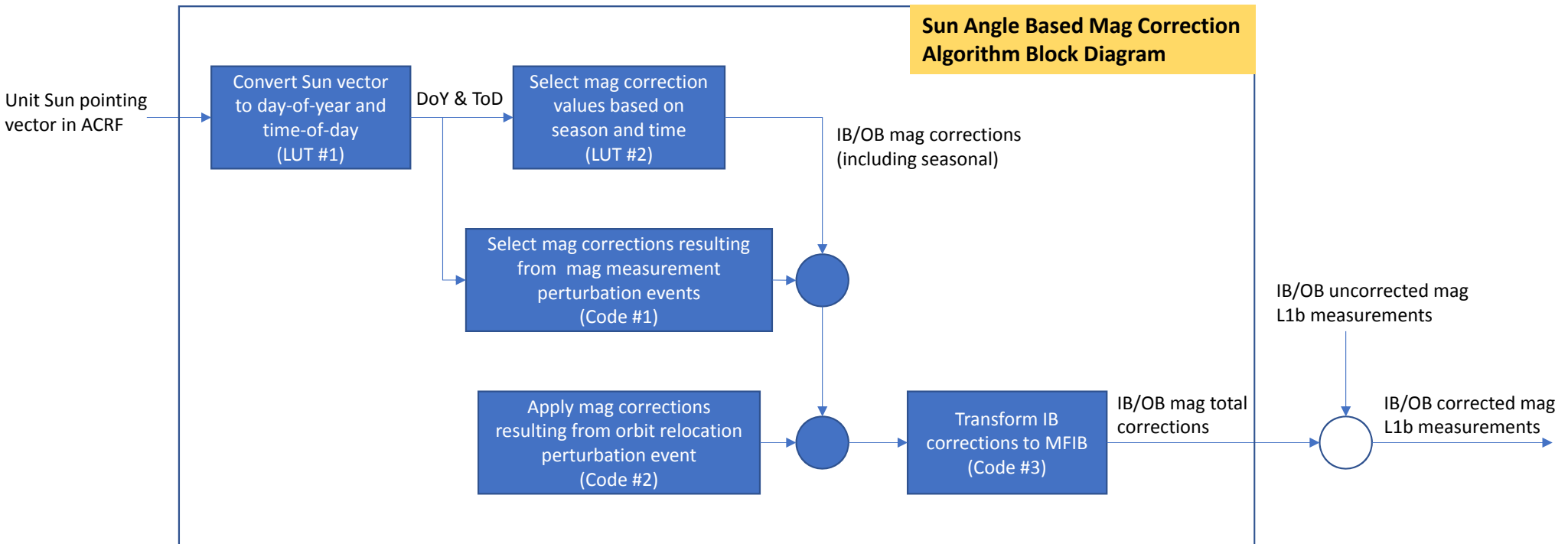

GOES-16 Magnetometer Anomaly Solar-Angle Based Correction Algorithm Performance Summary

- Each magnetometer flight day from 08-Dec-2016 thru 02-Jan-2017 was applied to the magnetometer anomaly correction algorithm
- The anomalous and corrected mag measurement diurnal mean and standard deviation were computed for each flight day
- The anomalous and corrected mag measurement diurnal performance metric ($|\text{mean}| + 3 \text{ std}$) were computed for each flight day
- Graphical results of these computations for the GOES-16 inboard and outboard magnetometers in 3 DoF are displayed

GOES-16 Anomalous and Corrected OB X-Axis Magnetometer Measurements Performance wrt GOES-13 Magnetometer Measurements

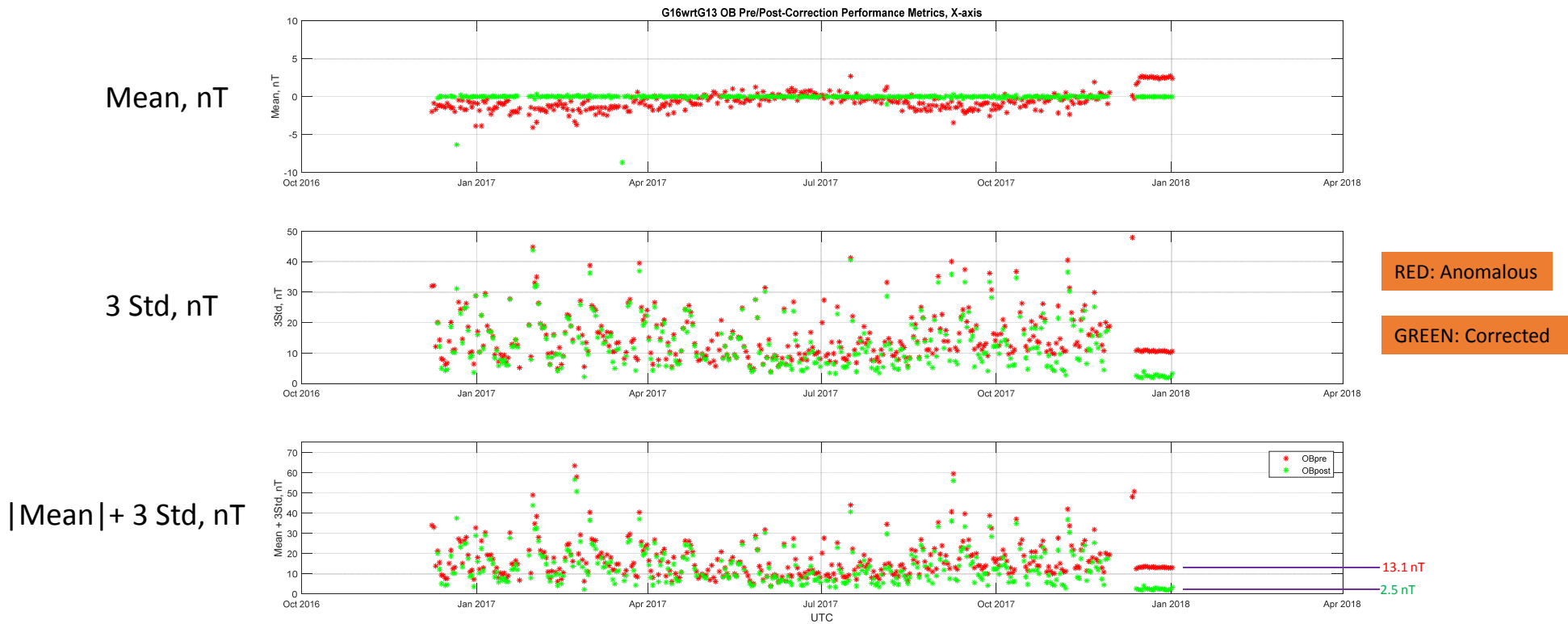

GOES-16 Anomalous and Corrected OB Y-Axis Magnetometer Measurements Performance wrt GOES-13 Magnetometer Measurements

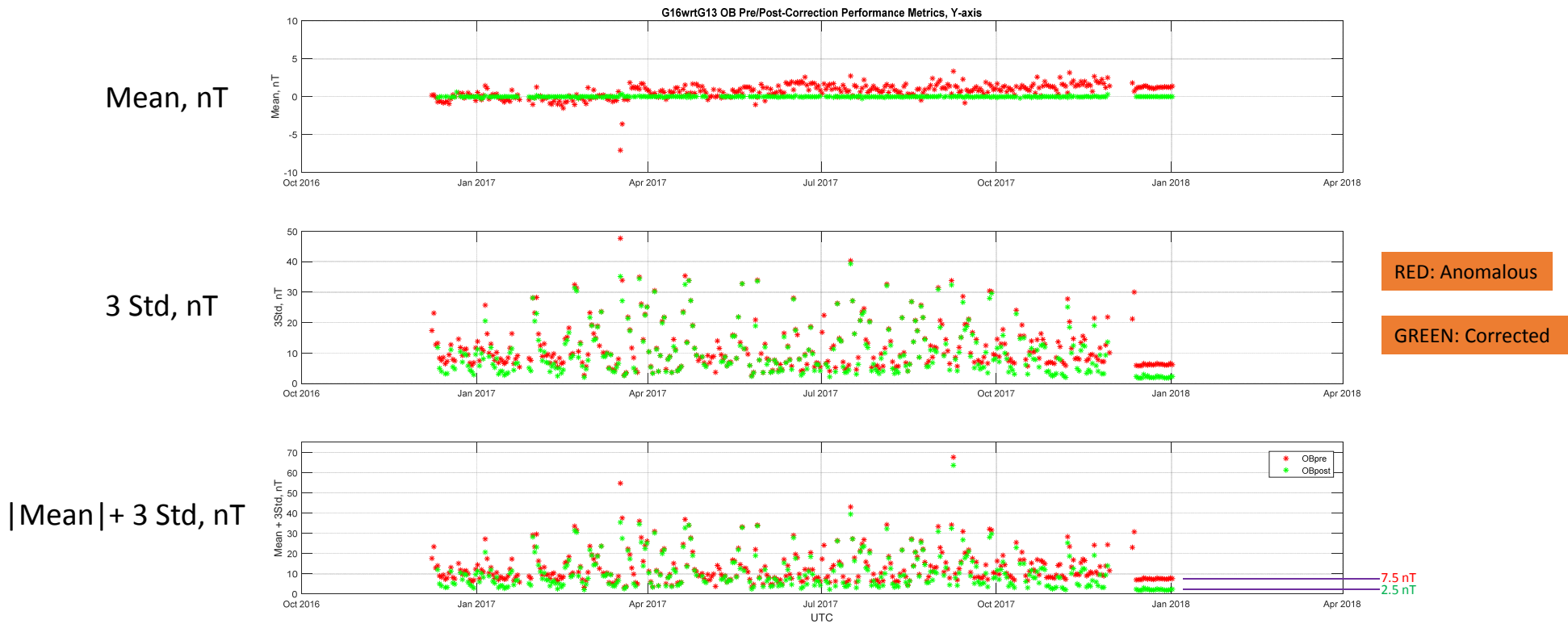

GOES-16 Anomalous and Corrected OB Z-Axis Magnetometer Measurements Performance wrt GOES-13 Magnetometer Measurements

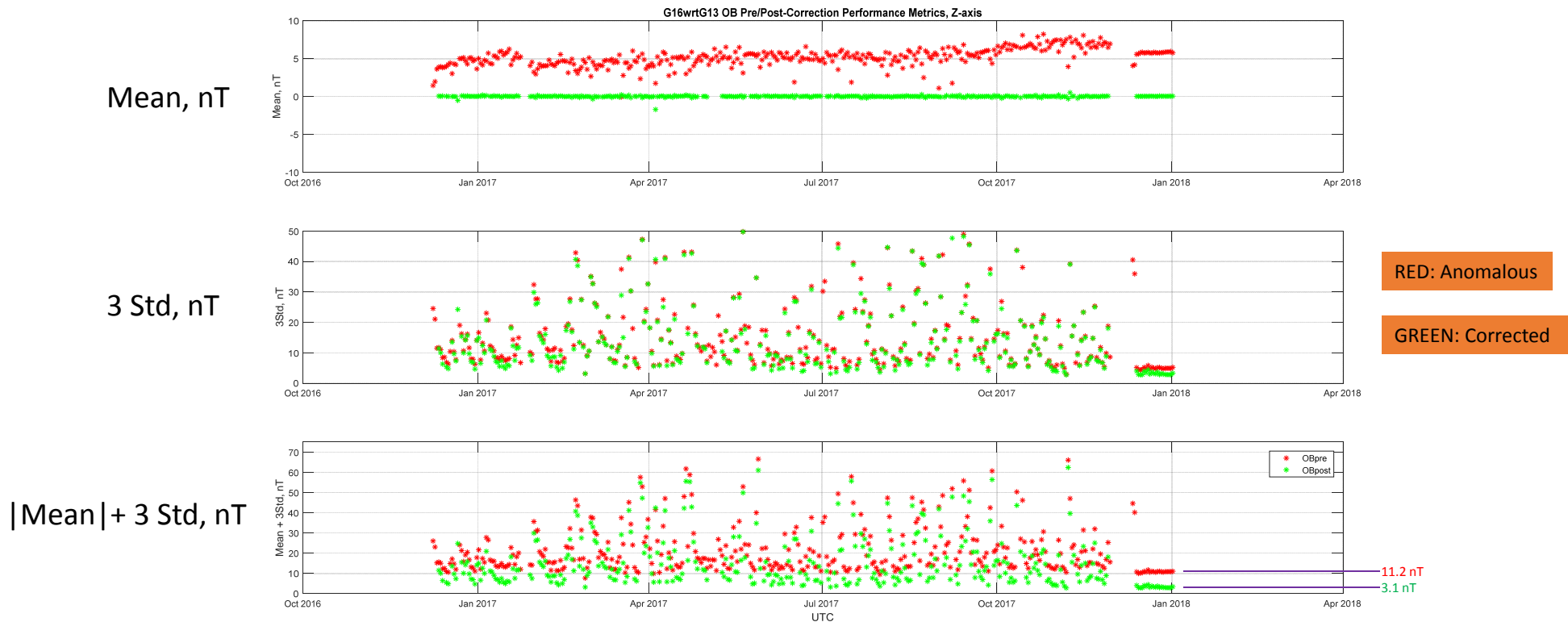

GOES-16 Anomalous and Corrected IB X-Axis Magnetometer Measurements Performance wrt GOES-13 Magnetometer Measurements

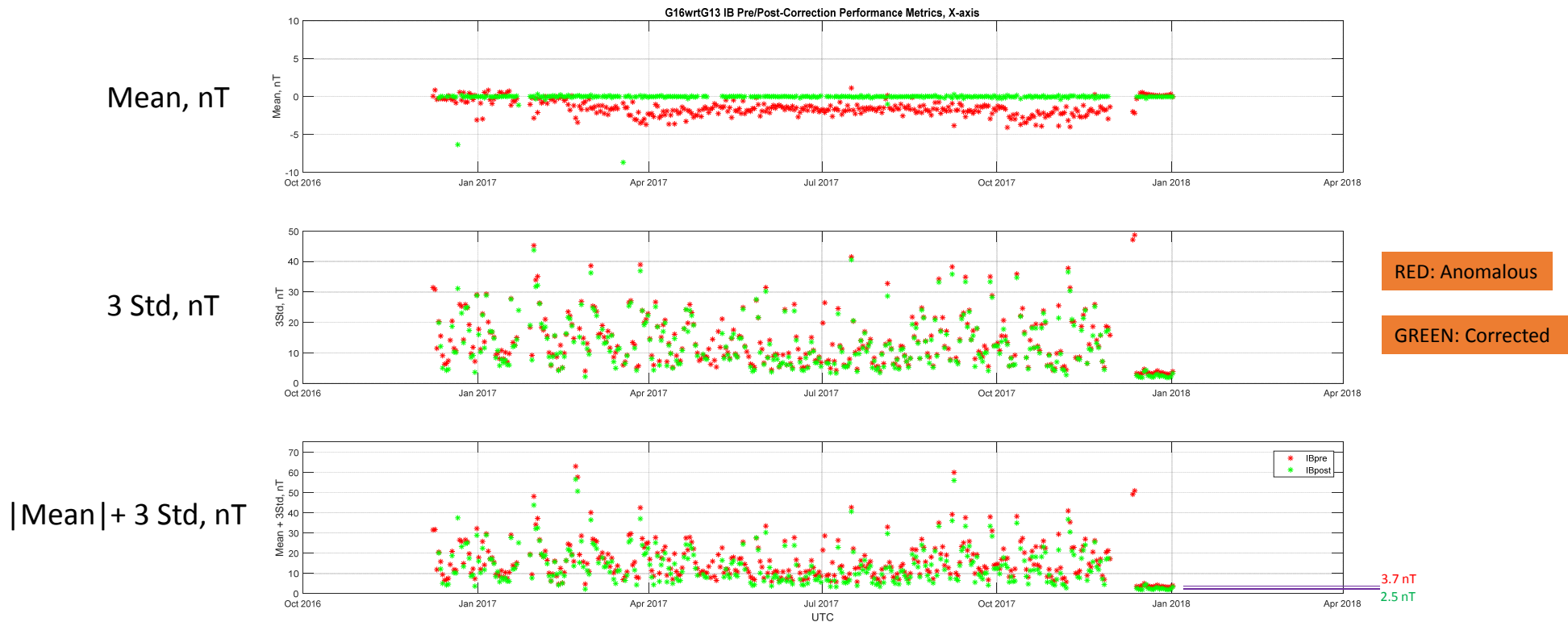

GOES-16 Anomalous and Corrected IB Y-Axis Magnetometer Measurements Performance wrt GOES-13 Magnetometer Measurements

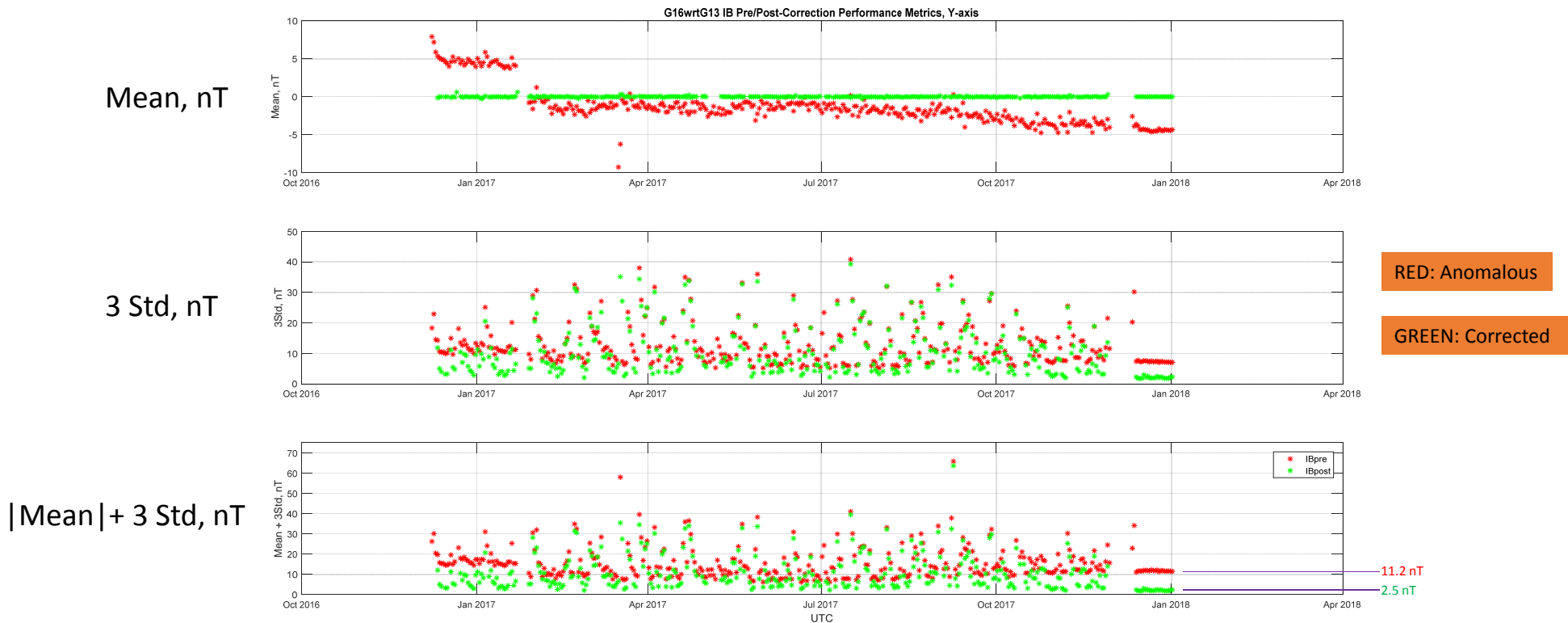

GOES-16 Anomalous and Corrected IB Z-Axis Magnetometer Measurements Performance wrt GOES-13 Magnetometer Measurements

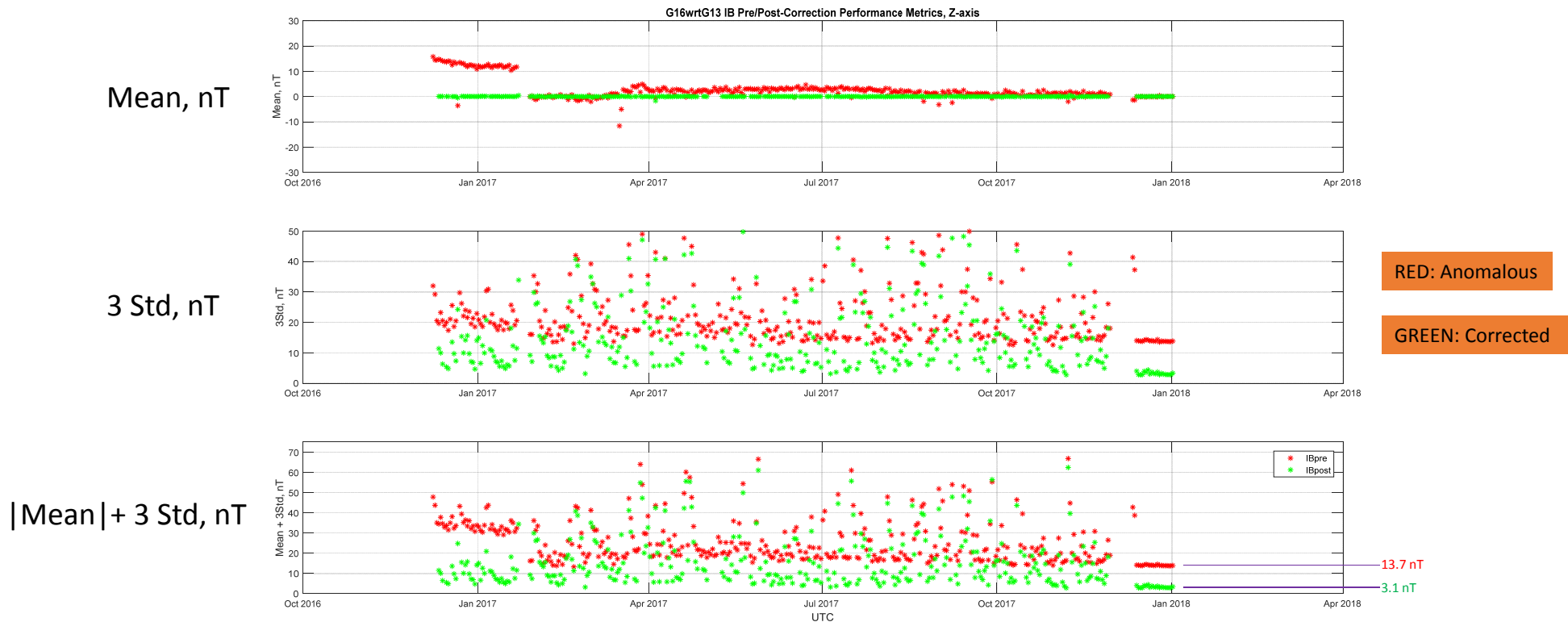

GOES-16 Mag Anomaly Solar-Angle Based Correction Algorithm Performance Summary, cont.

- The graphical results of the per flight day diurnal standard deviations and performance metrics show strong interday variances during the G16/G15 non-collocation time period
- The intraday mag measurement high frequency components that remain after correction are due primarily to the non-quiet day geomagnetic field activity that contributes significantly to the interday variances
- To attain better estimates of the correction algorithm performance, the corrected magnetometer results were low-pass filtered to better approximate quiet day geomagnetic field characteristics
- Low-pass filtering the corrected mag measurement results does not overestimate the correction algorithm performance since the high frequency components associated with the anomalous mag behavior have been significantly reduced after correction
- Graphical results of the low-pass filtered corrected mag measurement diurnal means, standard deviations, and performance metrics are displayed

GOES-16 Corrected OB X-Axis Magnetometer Unfiltered & Filtered Measurement Performance wrt GOES-13 Mag Measurements

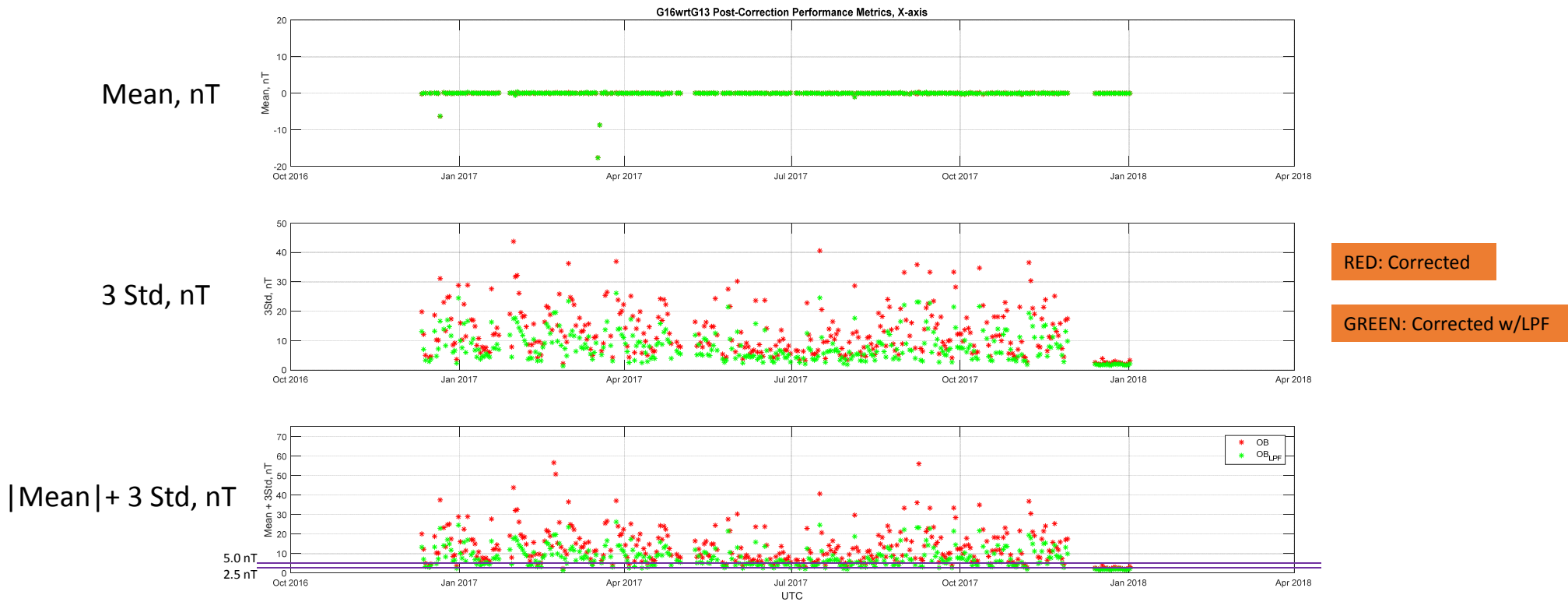

GOES-16 Corrected OB Y-Axis Magnetometer Unfiltered & Filtered Measurement Performance wrt GOES-13 Mag Measurements

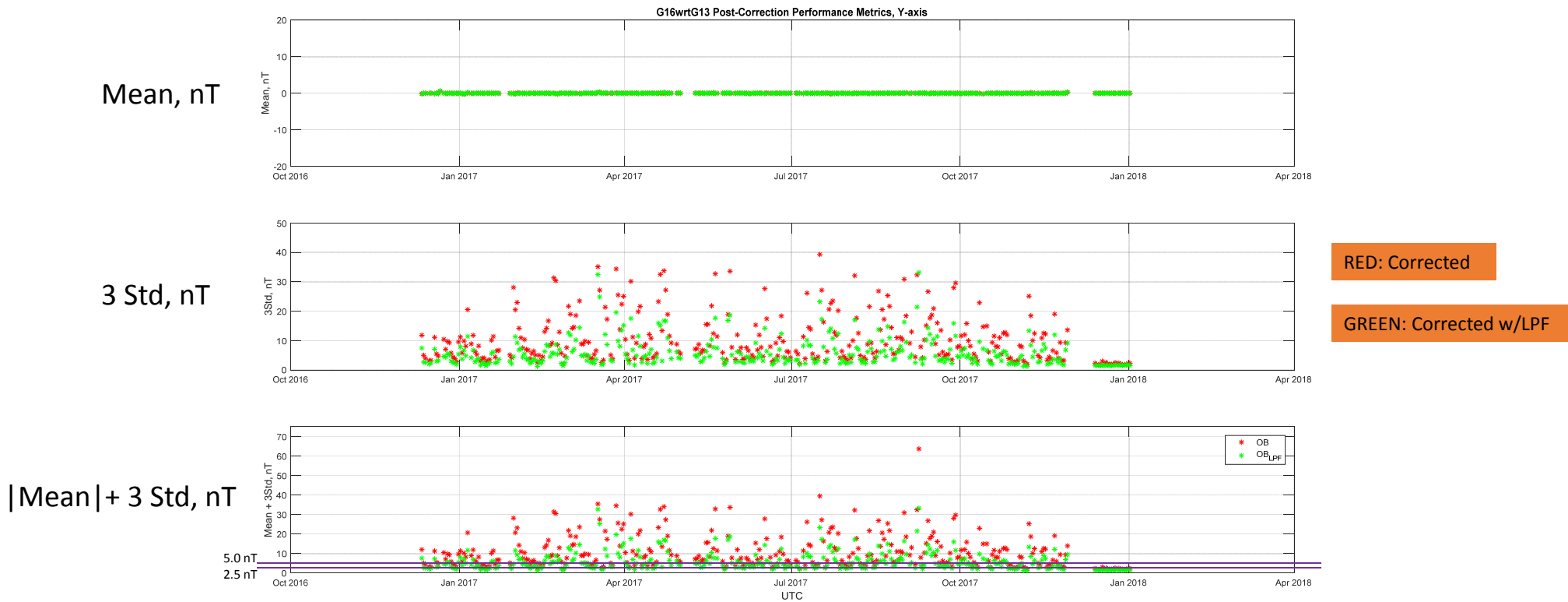

LPF break frequency @ 9 cyc/day

GOES-16 Corrected OB Z-Axis Magnetometer Unfiltered & Filtered Measurement Performance wrt GOES-13 Mag Measurements

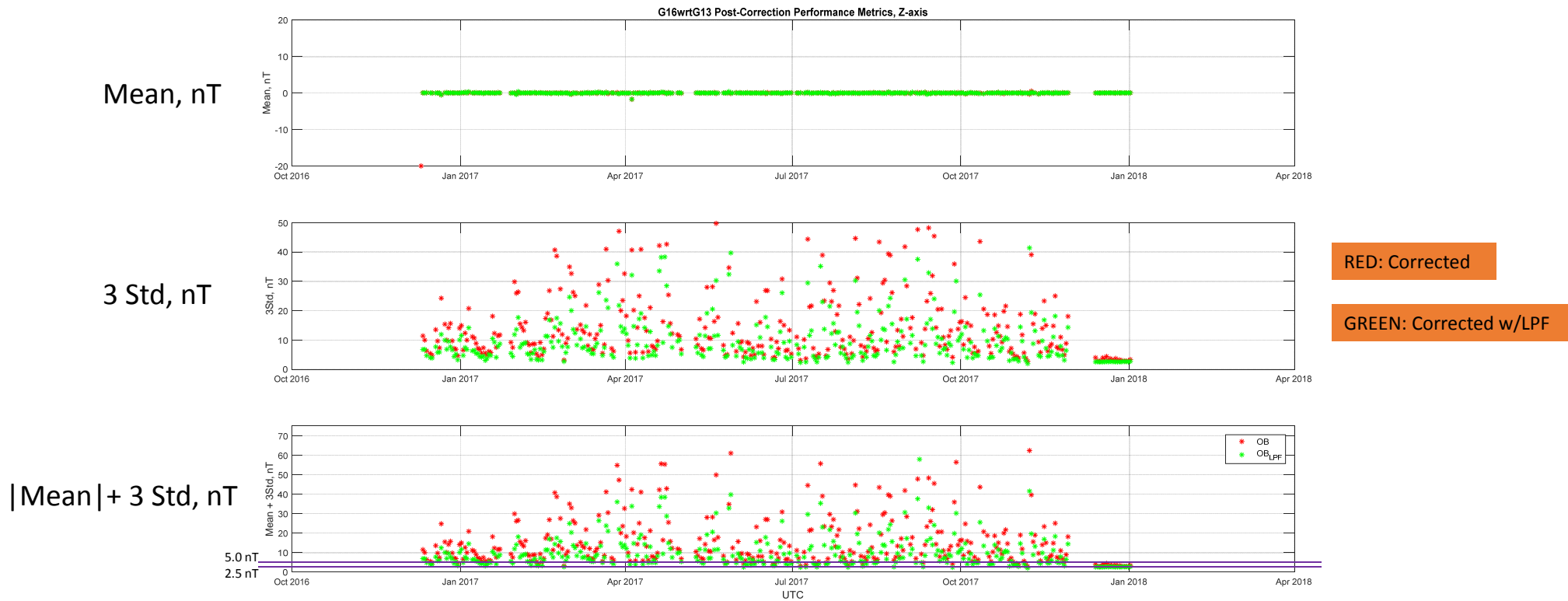

LPF break frequency @ 9 cyc/day

GOES-16 Corrected IB X-Axis Magnetometer Unfiltered & Filtered Measurement Performance wrt GOES-13 Mag Measurements

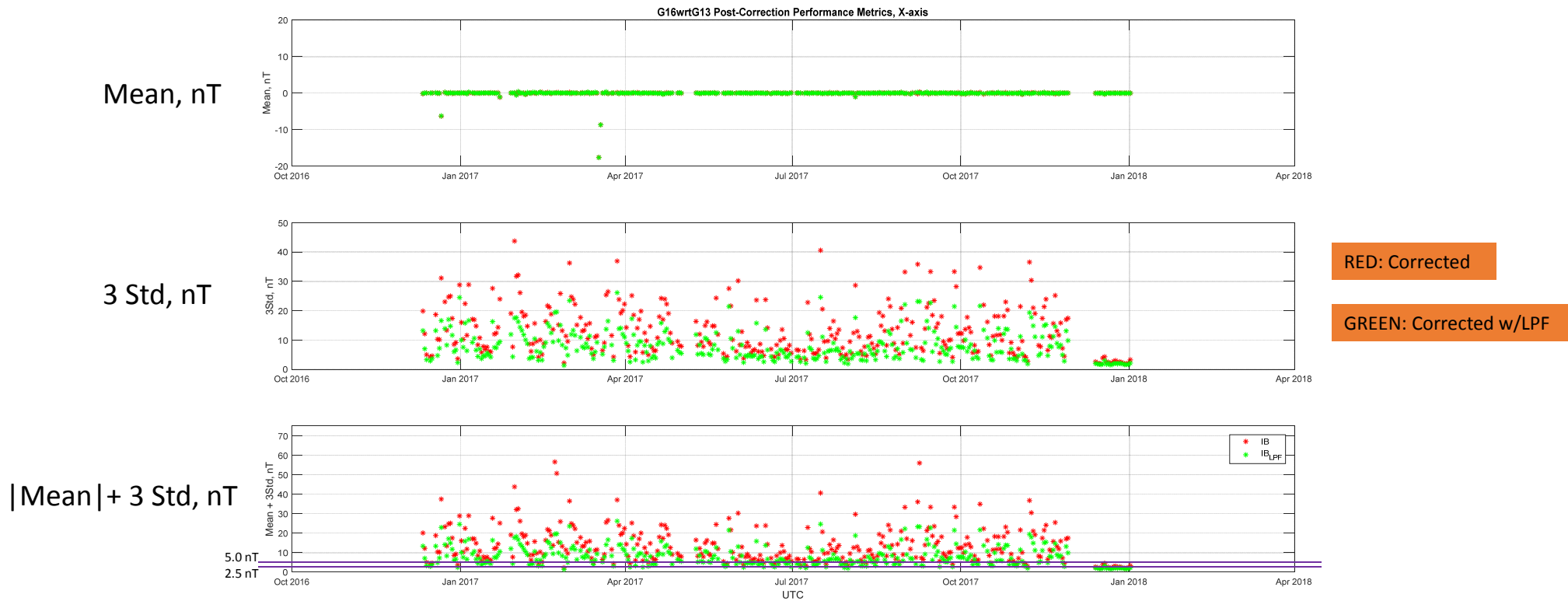

LPF break frequency @ 9 cyc/day

GOES-16 Corrected IB Y-Axis Magnetometer Unfiltered & Filtered Measurement Performance wrt GOES-13 Mag Measurements

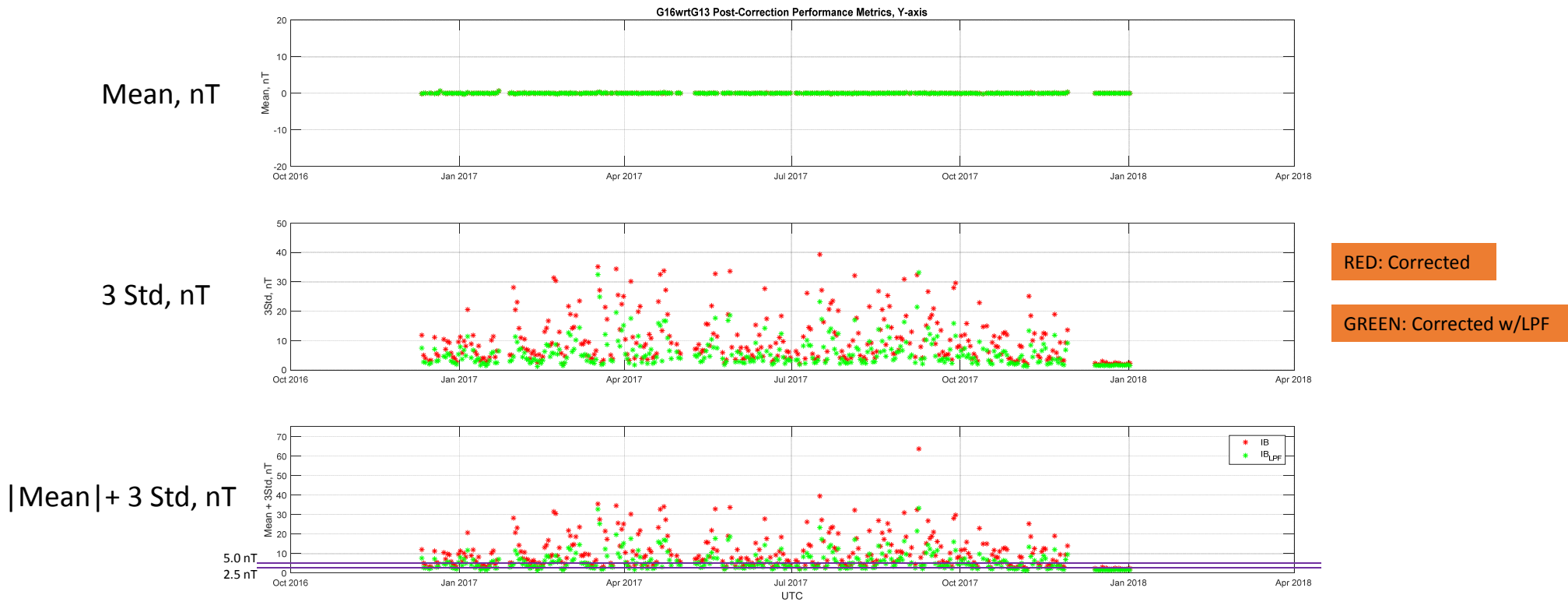

LPF break frequency @ 9 cyc/day

GOES-16 Corrected IB Z-Axis Magnetometer Unfiltered & Filtered Measurement Performance wrt GOES-13 Mag Measurements

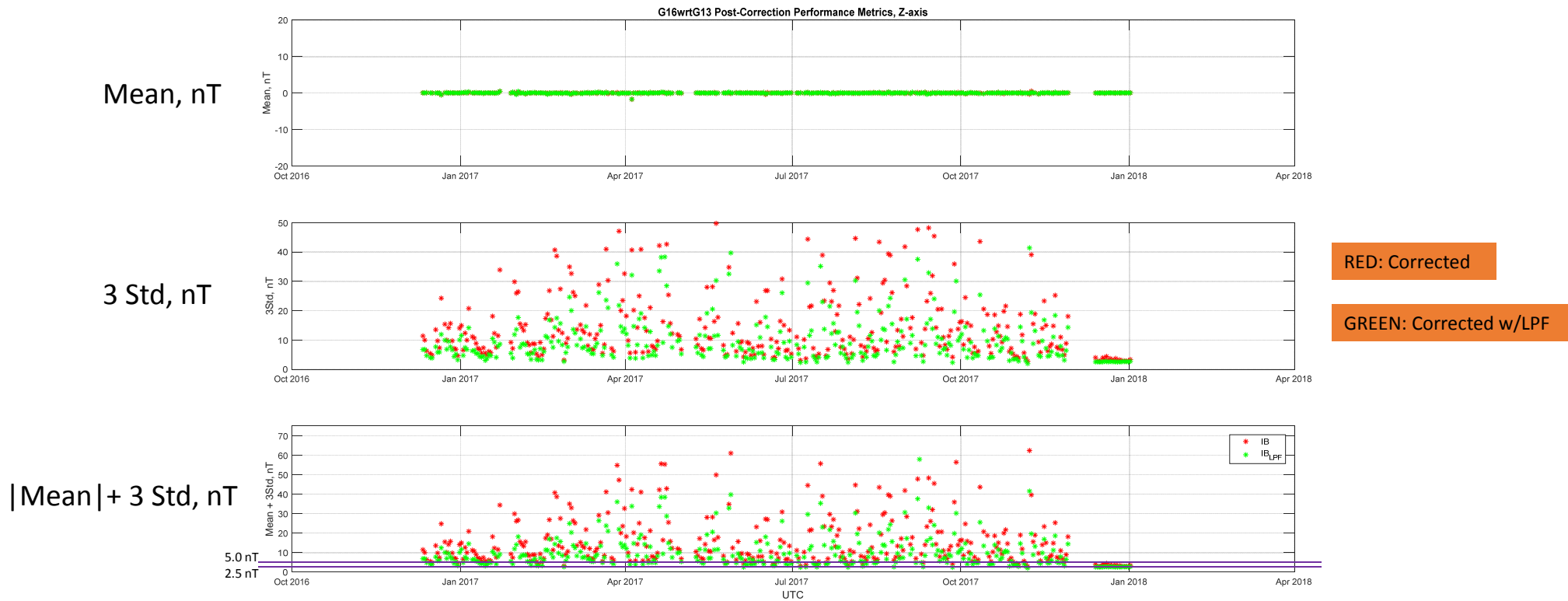

LPF break frequency @ 9 cyc/day

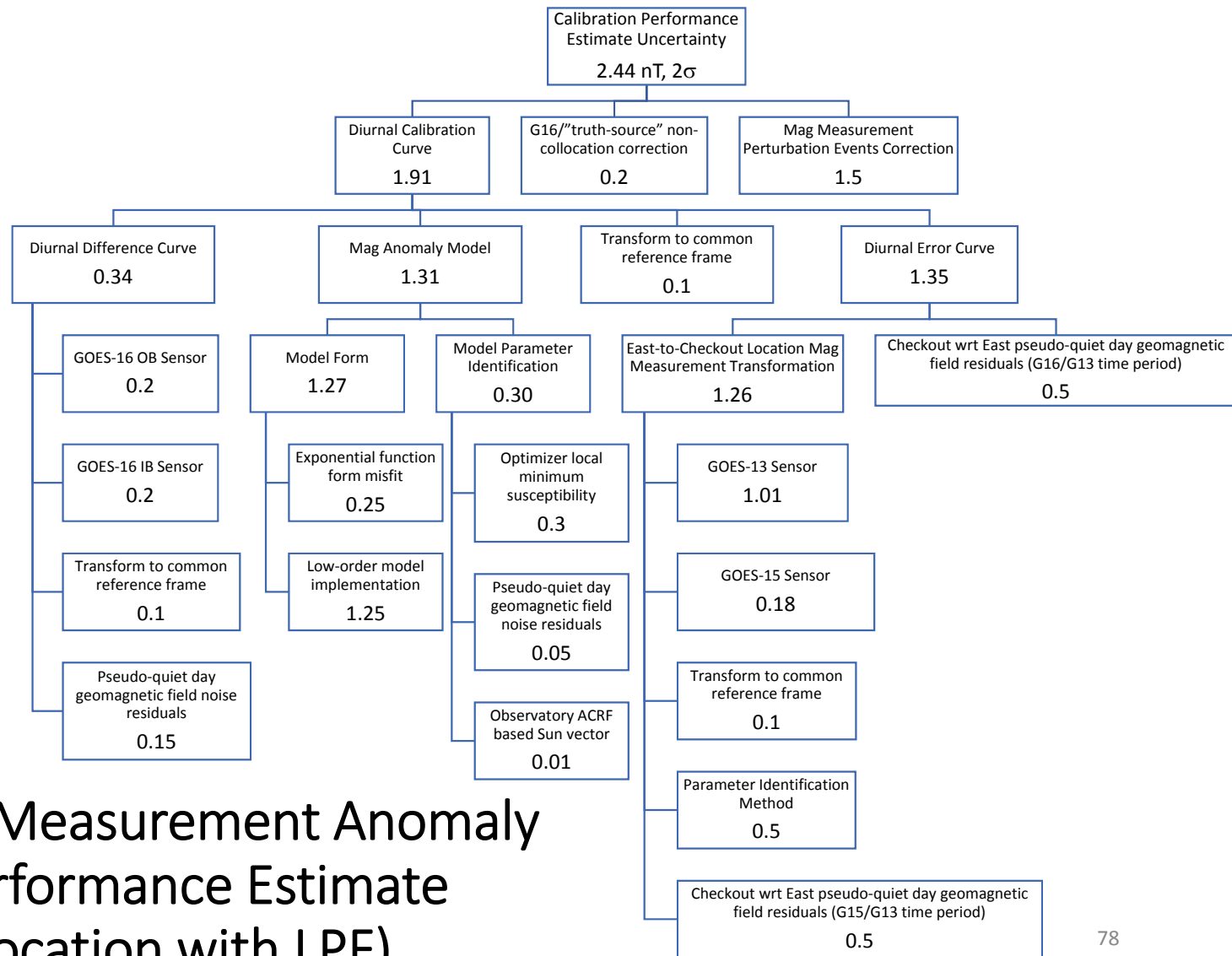

(Draft) GOES-16 Mag Measurement Anomaly Correction Diurnal Performance Estimate Uncertainty (Non-collocation with LPF)

GOES-16 Magnetometer Measurement Anomaly Correction Algorithm GS Operations Implementation Description Document Proposed Contents

- **Description of algorithm, algorithm steps, inputs, outputs, and configuration parameters**
 - Identify limitations and constraints for ensuring algorithm runs successfully
 - Define algorithm startup and shutdown procedures
 - Identify what is modifiable at run time
- **Algorithm flow diagrams to be based on current Mag GPA CDRLs & PUG**
 - Establishes common architecture & interface starting points and terminology
 - Used as a reference for identifying inputs from the current GS GPA code into the algorithm
 - Used as a reference for identifying points where the algorithm outputs are inserted into the current GS GPA code
 - Correction to be applied in MFOB and reported in EPN
 - Corrected and uncorrected OB Mag results are to be reported outputs
- **Implementation validation recommended test steps & input/output test data sets**
- **Algorithm sizing aspects**
 - Expected OB mag correction LUT size
 - Sample rate and floating point recommendations
 - Recommended data structures
 - Data path size, word size, resolution recommendations
- **Off-nominal Operation Considerations**
 - Algorithm Yaw flip flag accommodation
 - Option to disable algorithm on a Mag GPA operation non-interference basis
 - Non-nominal observatory operation identification and algorithm suspend operation procedure
 - Nominal observatory operation identification and algorithm resume operation procedure
 - Algorithm performance self-check and problem identification and reporting
- **Algorithm performance maintenance**
 - Description of what activities are necessary to maintain algorithm performance
 - Frequency of periodic performance checks
 - Recommended algorithm tuning frequency

Conclusions

- GOES-16 magnetometer measurement anomaly solar-angle based characterization and resulting correction algorithm demonstrates successful magnetometer performance recovery

GOES-16 Magnetometer Measurement Anomaly Solar-Angle Based Correction Algorithm Performance Results ($ \mu + 3\sigma$)						
	Inboard Magnetometer			Outboard Magnetometer		
	X (nT)	Y (nT)	Z (nT)	X (nT)	Y (nT)	Z (nT)
Anomalous	~3.7	~11.2	~13.7	~13.1	~7.5	~11.2
Corrected	~2.5	~2.5	~3.1	~2.5	~2.5	~3.1

- Correction algorithm performance uncertainty is calculated to be 2.44 nT (2σ)
- Presented and reviewed performance results over various time periods and conditions for the proposed correction algorithm
- Provided block diagram overview for the correction algorithm operational ground system implementation
- Provided list of algorithm ground system implementation considerations
- Correction algorithm is designed to be real-time implementable with low latency⁸⁰