

LYNX: OPTICS DEFINED

J. Gaskin. NASA MSFC

Presented on behalf of the Lvx
Optics Team

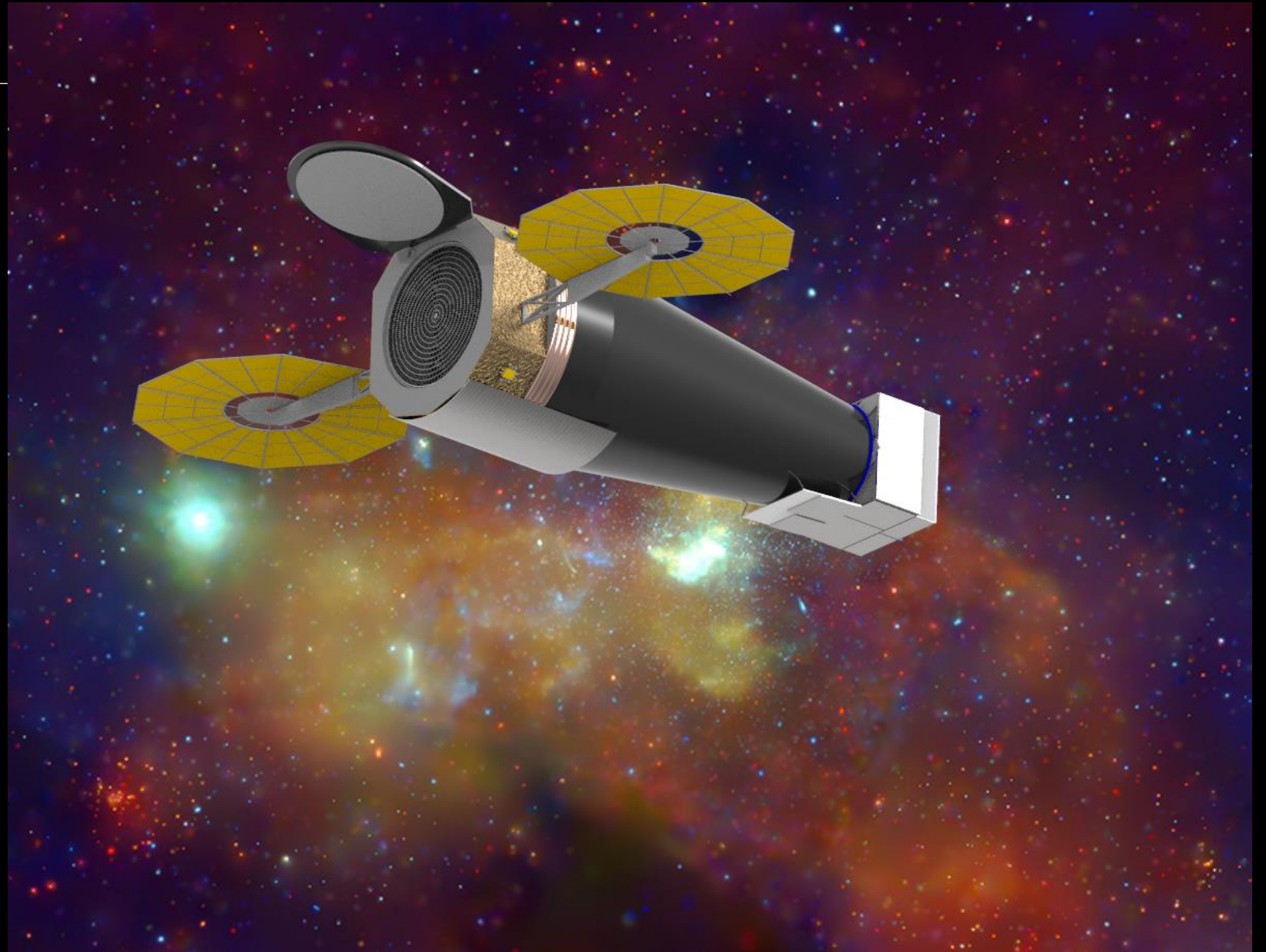



MEET LYNX!

Of the 4 large missions under study for the 2020 Astrophysics Decadal. Lynx is the only observatory that will be capable of directly observing the high-energy events that drive the formation and evolution of our Universe.

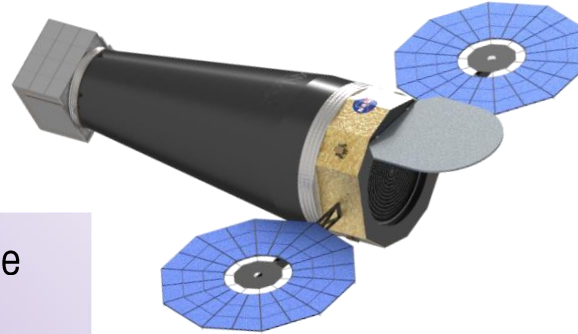

Lynx will provide unprecedented vision into the X-Ray Universe with leaps in capability over Chandra and ATHENA:

- **Orders of magnitude gain in sensitivity** over Chandra and Athena. via high throughput with high angular resolution
- **Increased field of view** for arcsecond or better imaging
- **Significantly higher spectral resolution** for point-like and extended sources

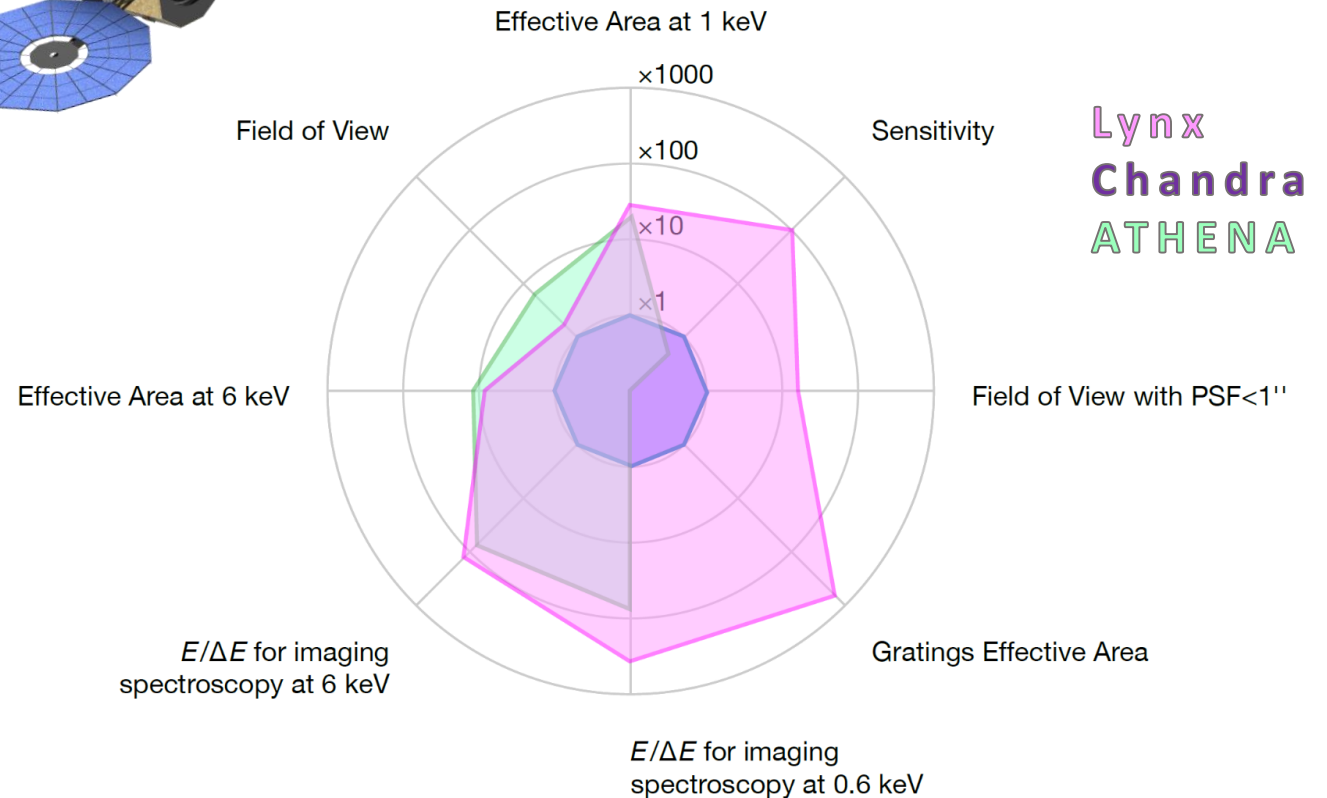



SCIENCE DRIVEN TELESCOPE CONFIGURATION

- 2 m² of effective area at E = 1 keV is required to execute the three science pillars in ~50% of the 5-yr mission baseline lifetime. **A goal of LvnX is to maximize discovery!**
- This is achieved with an outer diameter of 3-m with a focal length of 10-m.

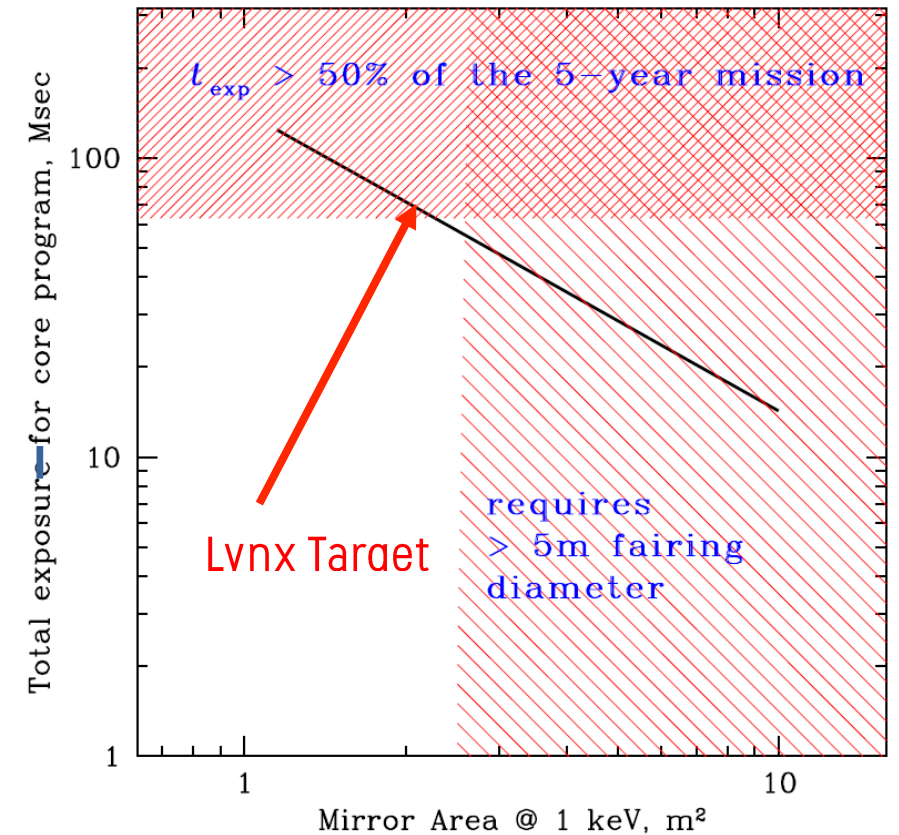
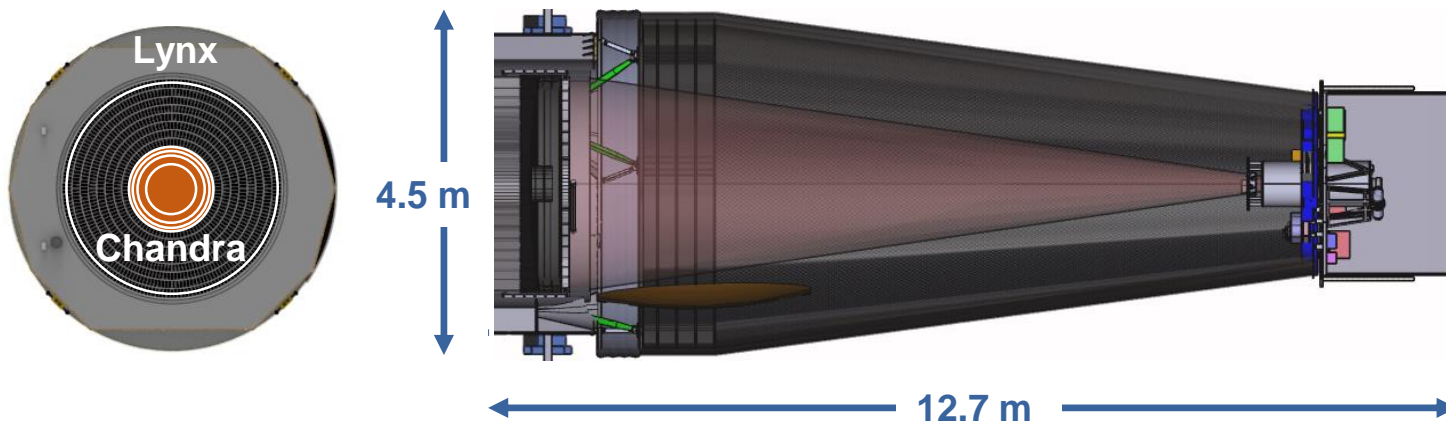



LYNX MIRROR ASSEMBLY IN CONTEXT

1.2m Diameter



**Chandra
(1999)**

0.4m Diameter



**NuSTAR
(2012)**

3.0m Diameter



**Lynx
(2036?)**



MIRROR REQUIREMENTS

- **Large effective area** is achieved by nesting a few hundred to many thousands of co-aligned, co-axial mirror pairs.
- Must fabricate **thinner mirrors** to allow for greater nesting of mirror pairs and larger effective area while reducing mass.
- These thin mirrors must be better than **0.5" HPD** requirement.
- Must **mount and coat** these thin optics **without deforming the optic**, or must be able to correct deformations.

Science Driven Requirements

Lynx Optical Assembly

Angular resolution (on-axis)	0.5 arcsec HPD (or better)
Effective area @ 1 keV	2 m ² (met with 3-m OD)
Off-axis PSF (grasp), A*(FOV for HPD < 1 arcsec)	600 m ² arcmin ²

Chandra did it! And so can Lynx!

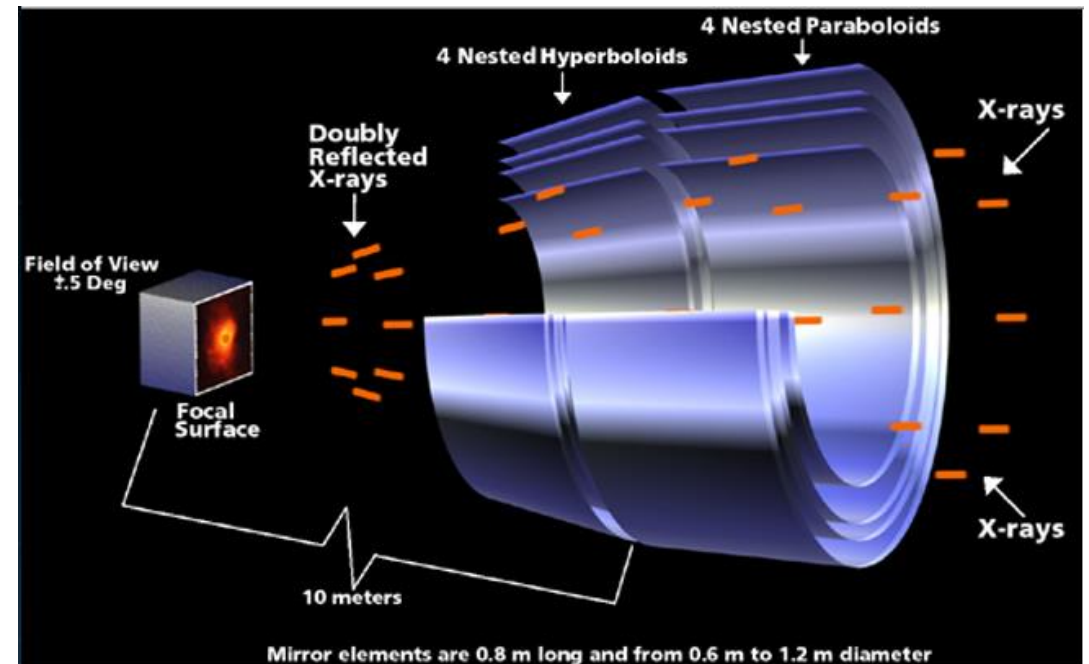



LYNX OBSERVATORY CONFIGURATION

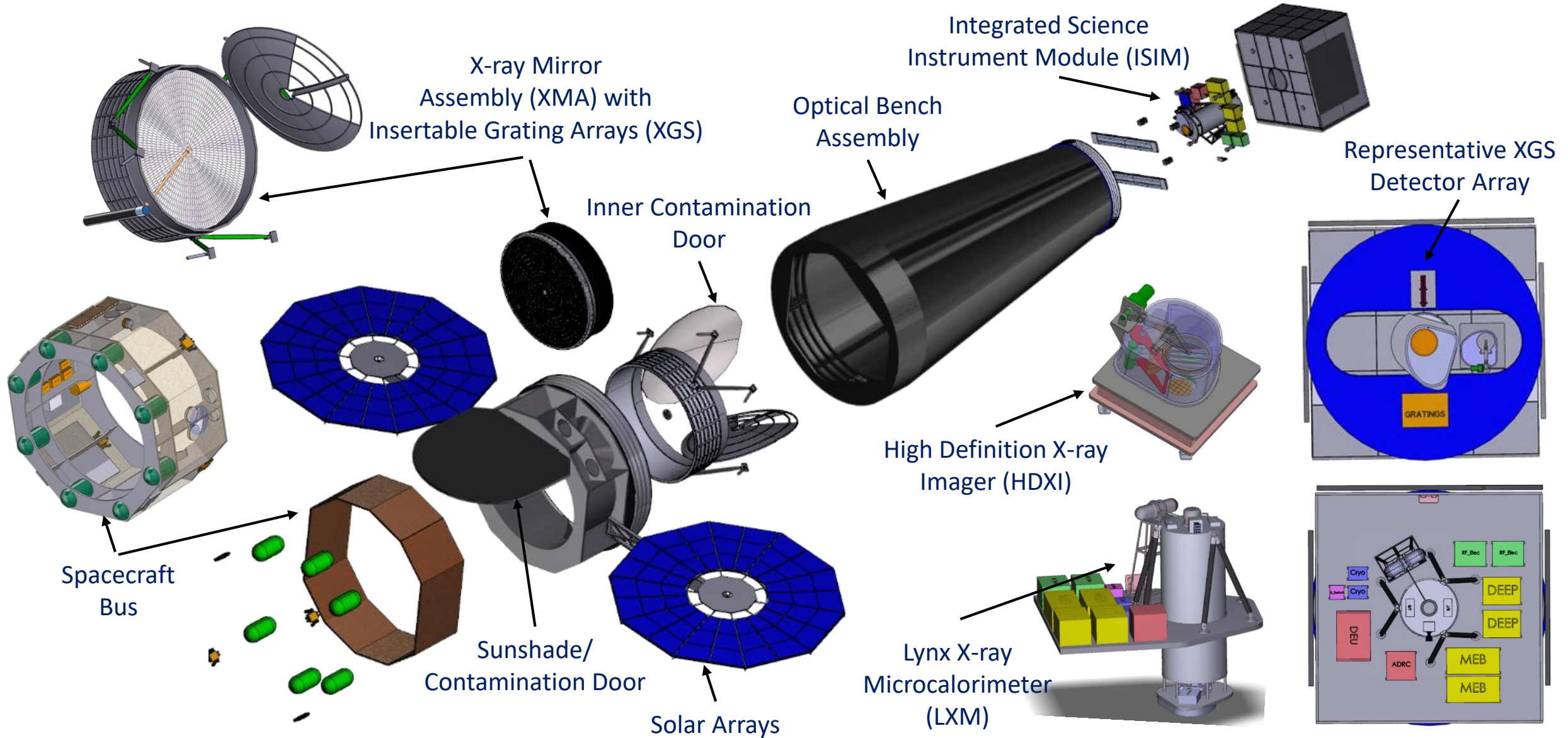



OPTICS ASSEMBLY OVERVIEW

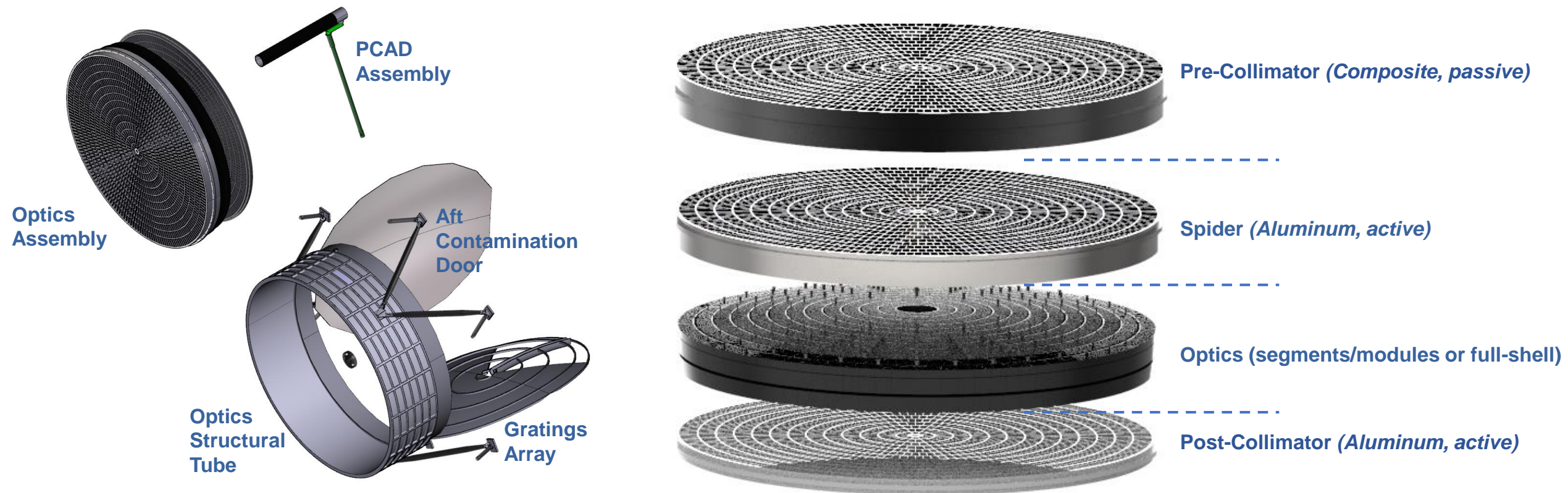



LYNX MIRROR ASSEMBLY

FABRICATION

Thermal Forming
(GSFC, SAO)



Full Shell
(INAF-Brera, MSFC, SAO)



Si Optics (GSFC)

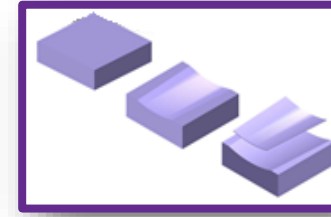

Air Bearing Slumping (MIT)

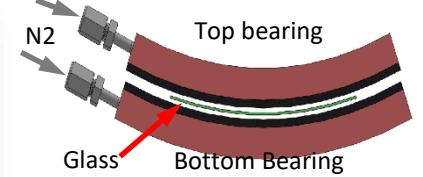

Testing/Simulation/Modeling

CORRECTION

Piezo stress
(SAO/PSU)

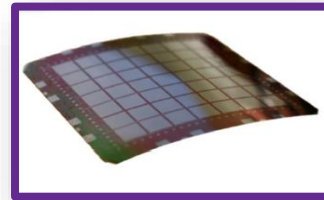

Deposition (MSFC, XRO)

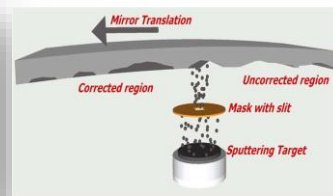

Magnetic & deposition
stress (NU)

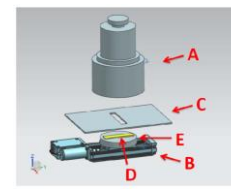
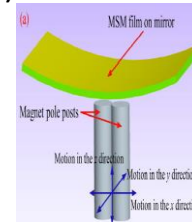

Ion implant stress (MIT)

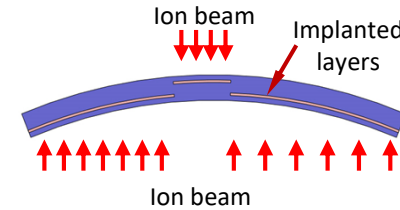

Ion beam
figuring (OAB)

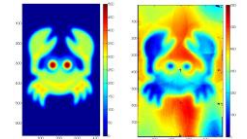

Testing/Simulation/Modeling

INTEGRATION

Full shells Assembly

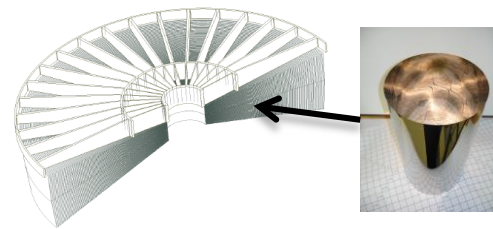

Segmented Wedge Assembly

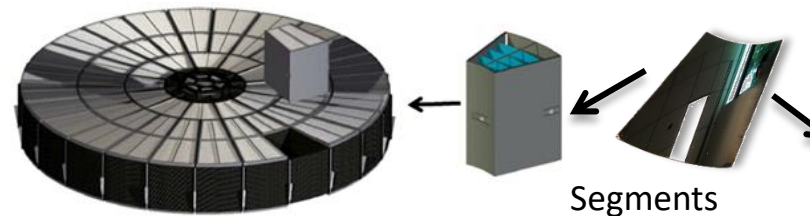

Meta-Shell Assembly

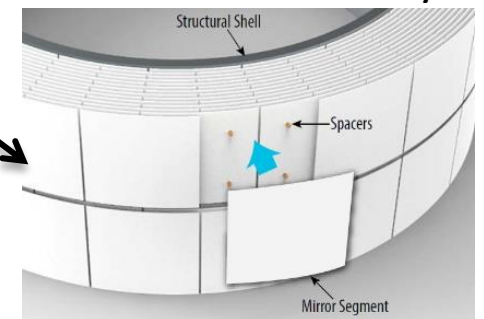

Testing/Simulation/Modeling



LYNX OPTICS TRADE STUDY – DRM SELECTION

- 3 actively funded Optics Technologies
- Kepner-Tregoe Trade Study chartered by Lynx STDT
- Facilitated by G. Blackwood (NASA JPL)
- Recommendation was made to STDT on 8/8/18

Executive Summary: Community working group conducted an open, science, technical, and programmatic evaluation using public evaluation criteria in a series of telecons and F2F meetings that took place over 6 months (2018).

A broad consensus was reached on the recommendation and on the basis for the recommendation

- **Large and diverse team from industry, universities, and multiple NASA Centers**
- **~ 5,000 person-hours over 6 months**
- **~100 documents produced (~650 pages of material)**

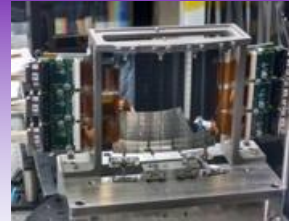

Adjustable
Segmented (SAO)

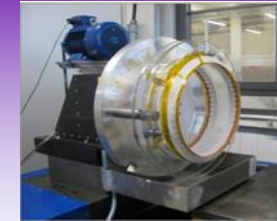

Full Shell
(INAF-
Brera/MSFC)

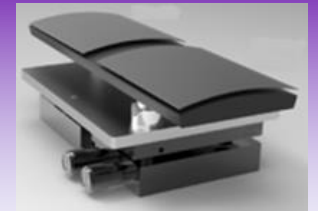

Silicon Meta-Shell
(GSFC)

All 3 Optics Technologies are currently being funded by NASA, Institutional, Other funding!

Recommendation

The LMAT recommends the Silicon Meta-Shell as the DRM concept Mirror Optical Assembly Architecture to focus the design for the Final Report. Full-Shell and Adjustable Optics are determined to be feasible alternates.



SILICON META-SHELL OPTICS

- W. Zhang & NGXO Team (NASA GSFC)

Direct polished mono-crystalline silicon

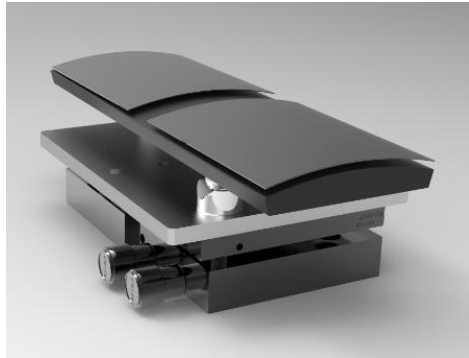

Parameters	Values
Total Number of Segments	37,492
Total Number of Meta-Shells	12
Radius (mm)	120 (Inner) – 1500 (Outer)
Segment Size (L x H) (mm)	100 x 100
Thickness Inner/Outer (mm)	0.5
Total mirror assembly mass (kg)	1,185 (including straylight & thermal baffles + structures)

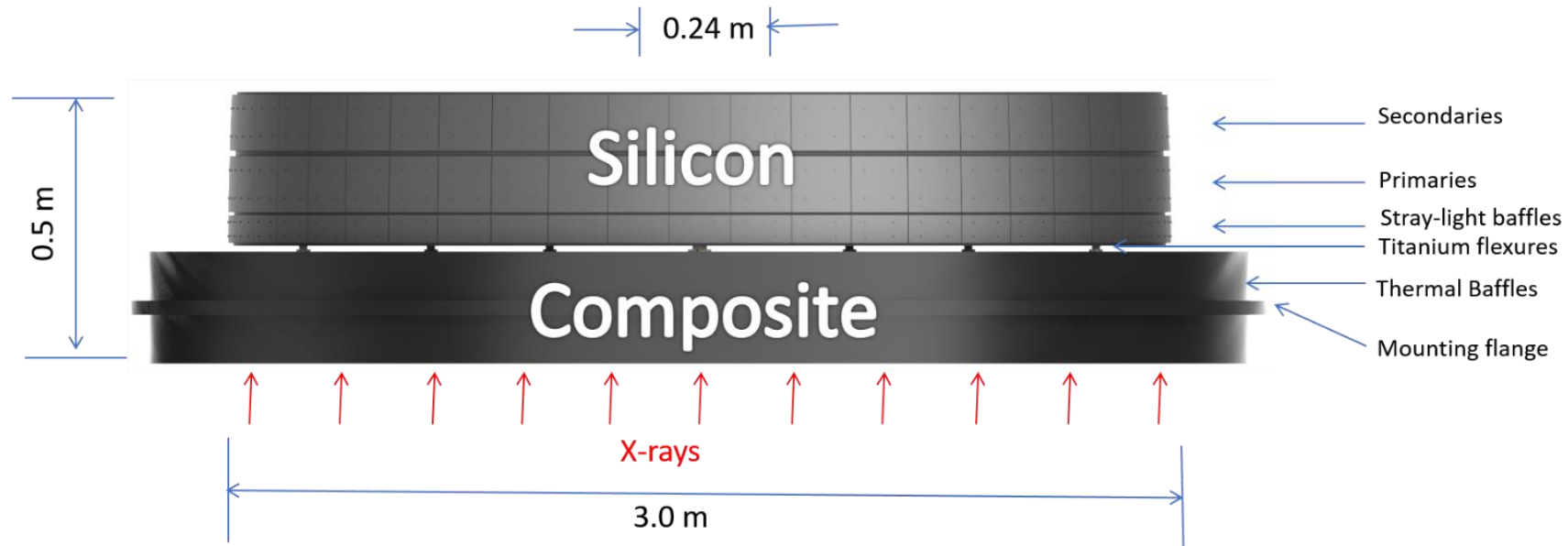



MAJOR STEPS OF SUBSTRATE FABRICATION

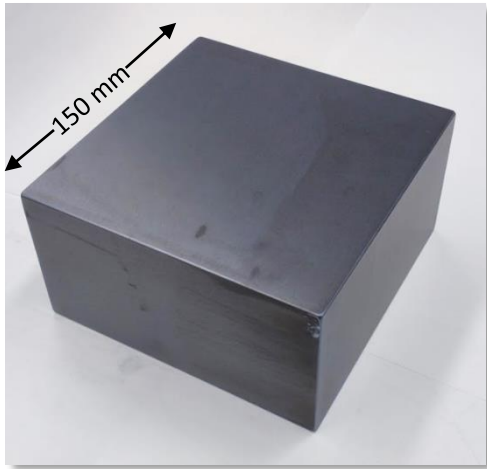

1. Mono-crystalline silicon block

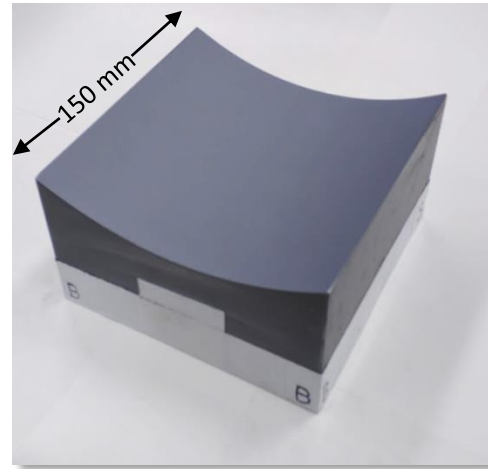

2. Conical form generated

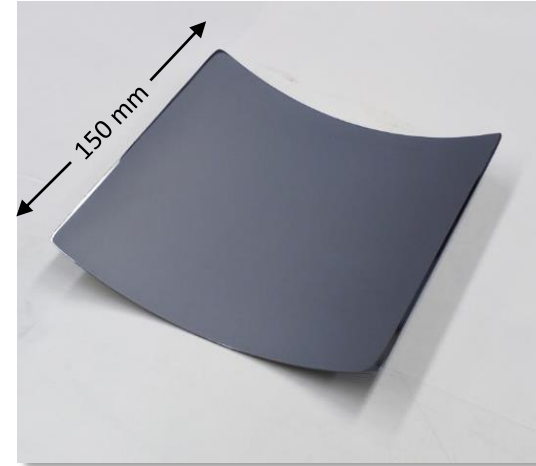

3. Light-weighted substrate

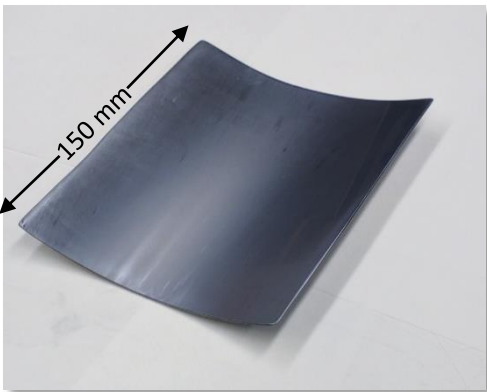

4. Etched substrate

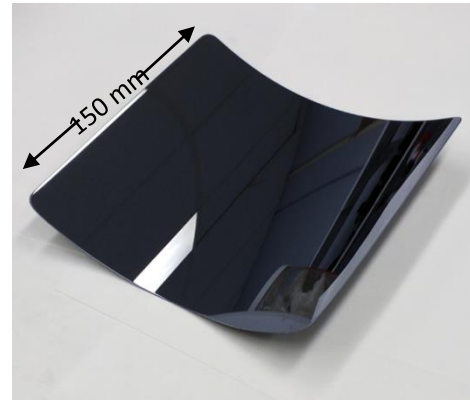

5. Polished mirror substrate



6. Trimmed mirror substrate

Key Features:

1. Use only commercially available equipment & materials.
2. Highly amenable to automation and parallel production.
3. Calendar Time: 5 days.
4. Labor Time: ~15 hours.



MANY MIRRORS MADE IN 2018 – METROLOGY LIMITED!

Measured Performance

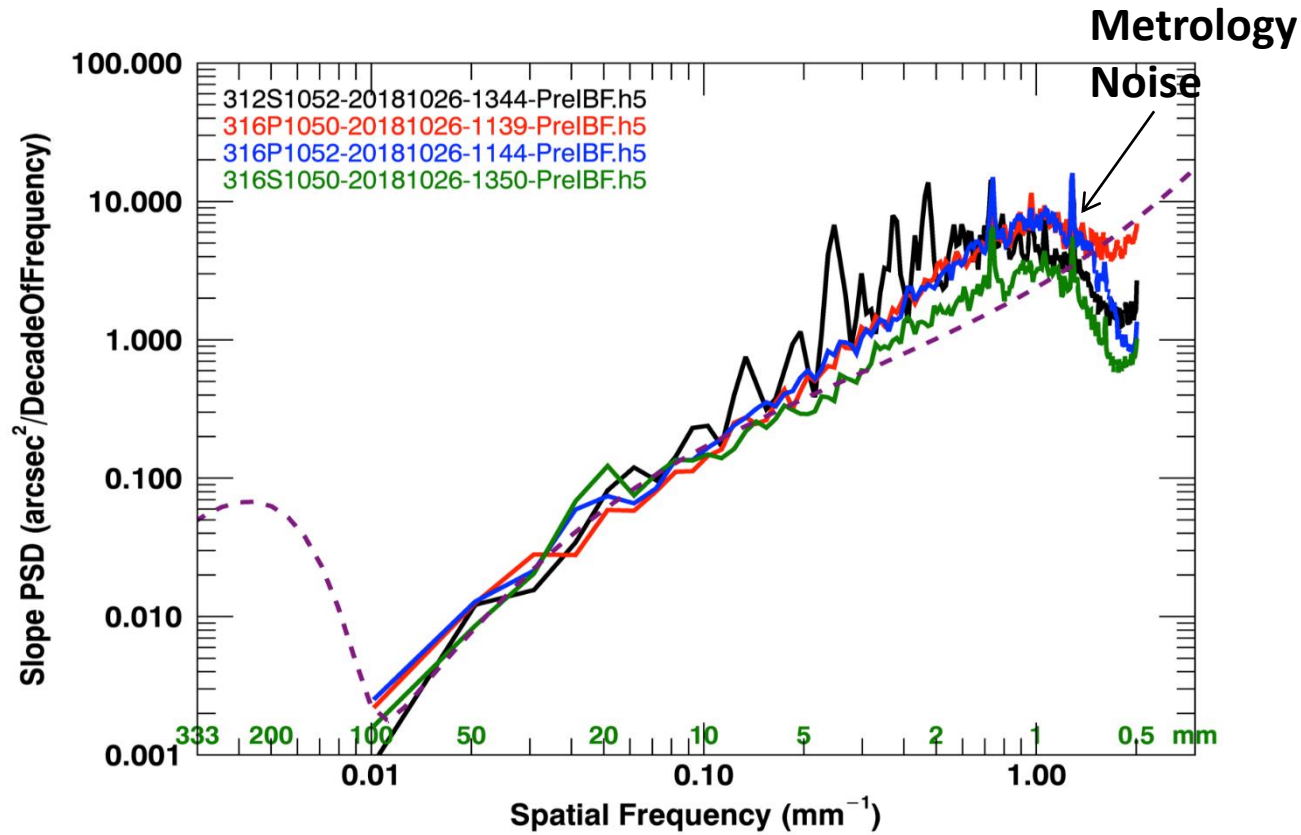

Quality comparable to or slightly better than Chandra's mirror.

Predicted Performance

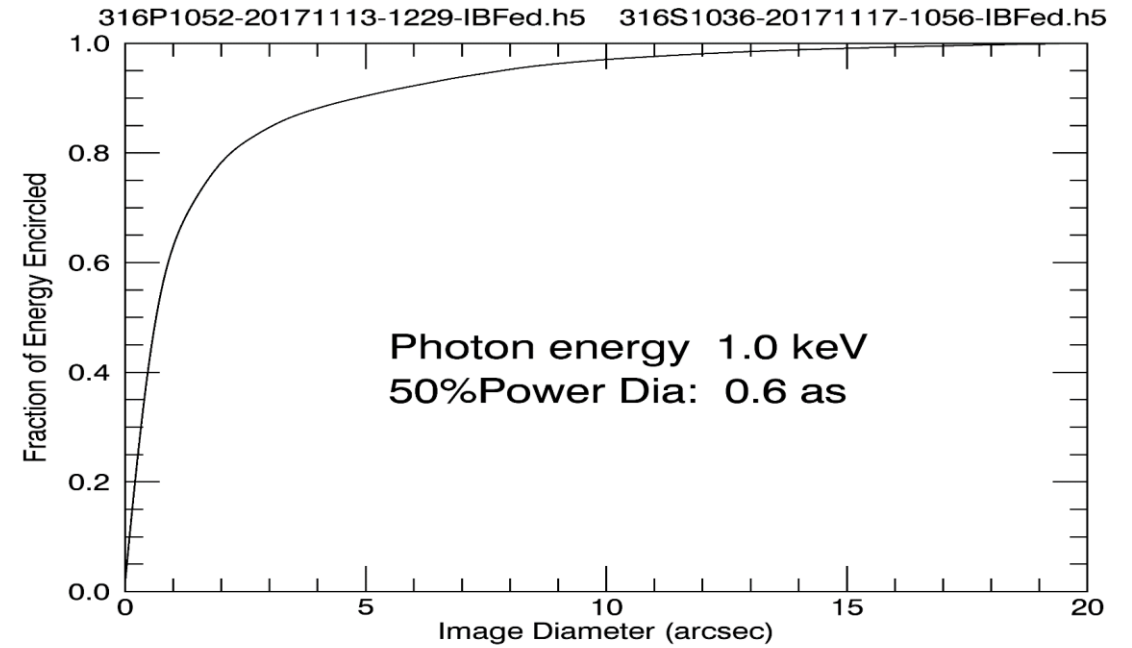

A good indication that mirrors can be made to meet Lynx (0.5" HPD) requirements.



X-RAY TESTING OF A PAIR OF MIRRORS

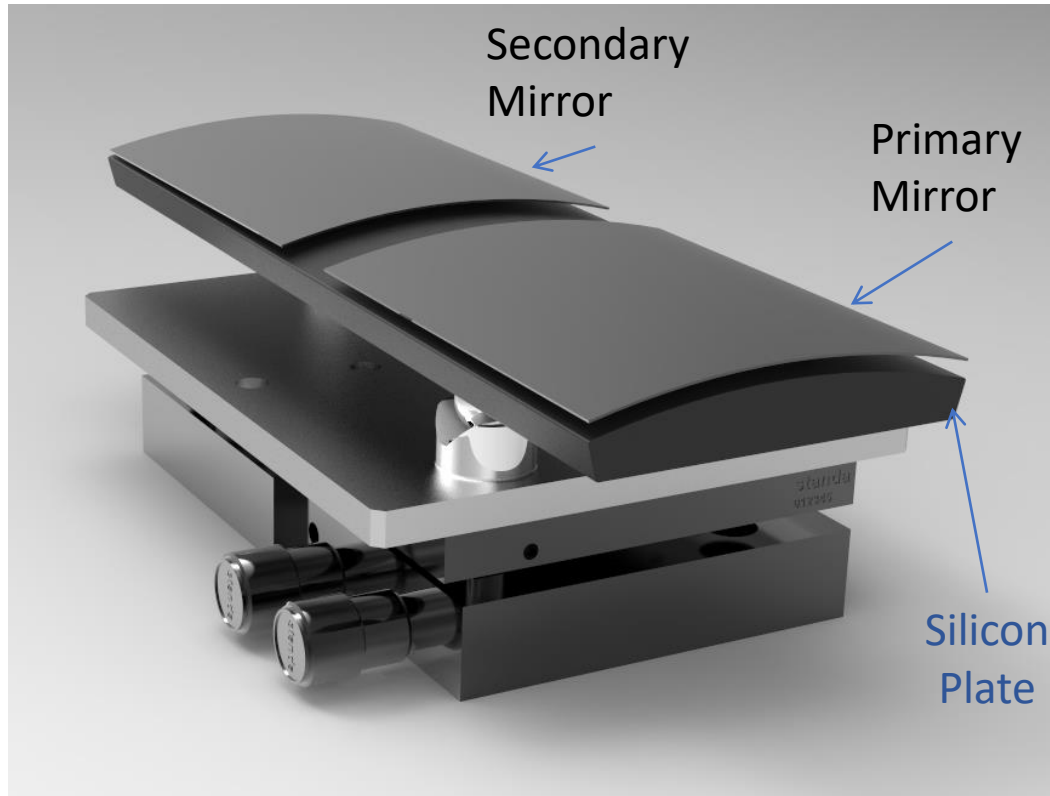

Two uncoated mono-crystalline silicon mirrors aligned and bonded on a silicon platform

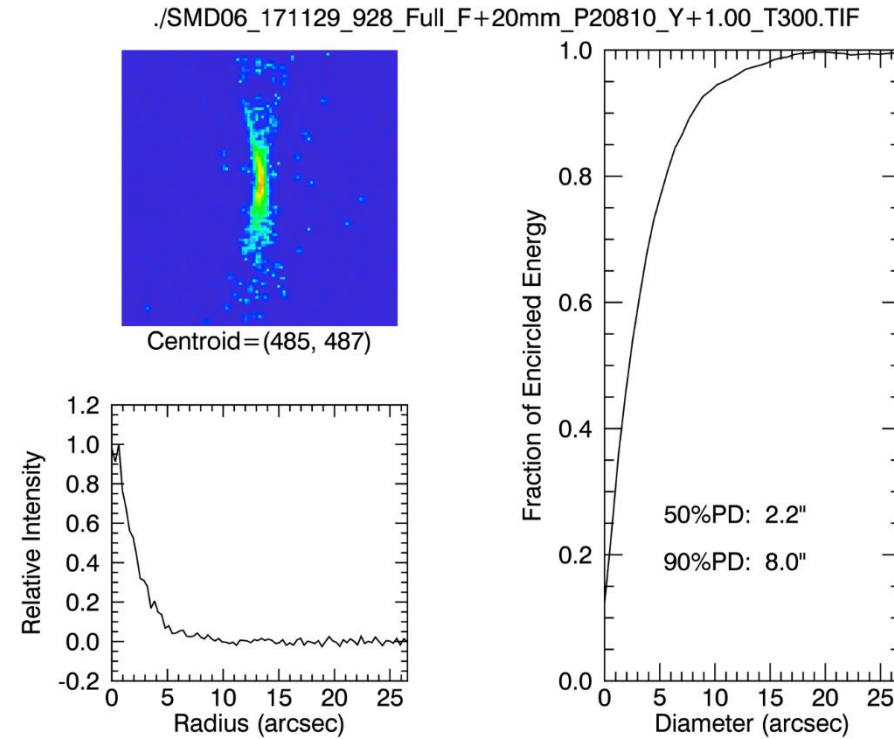

Full illumination with Ti-K X-rays (4.5 keV)



SUMMARY AND GOALS

- 2012-2016: from a blue-sky idea to a practical process
 - Proof of principle, validating the approach based on precision-polishing of mono-crystalline silicon.
- 2017: Made **sub-arcsec mirrors** with thickness about *~1mm*.
- 2018: Made **sub-arcsec mirror** with thickness *~0.5mm*.
- 2019-2023(?): from **sub-arc-second** to **diffraction-limited** mirrors (~0.1 arc-seconds)
 - Continue to refine *fabrication* process and to understand and improve *measurement* process to make ever better mirrors: **0.3"** (2019), **0.2"** (2021), and **0.1"** (2023).

MULTIPLE FUNDED ON-GOING EFFORTS- FULL SHELL & ADJUSTABLE OPTICS

- G.Pareschi, M.Civitani, S.Basso & INAF Team (INAF-OAB)
- K. Kiranmayee, J. Davis, R. Elsner D. Swartz & MSFC Team (MSFC/USRA)

Direct Polished Fused Silica or Similar

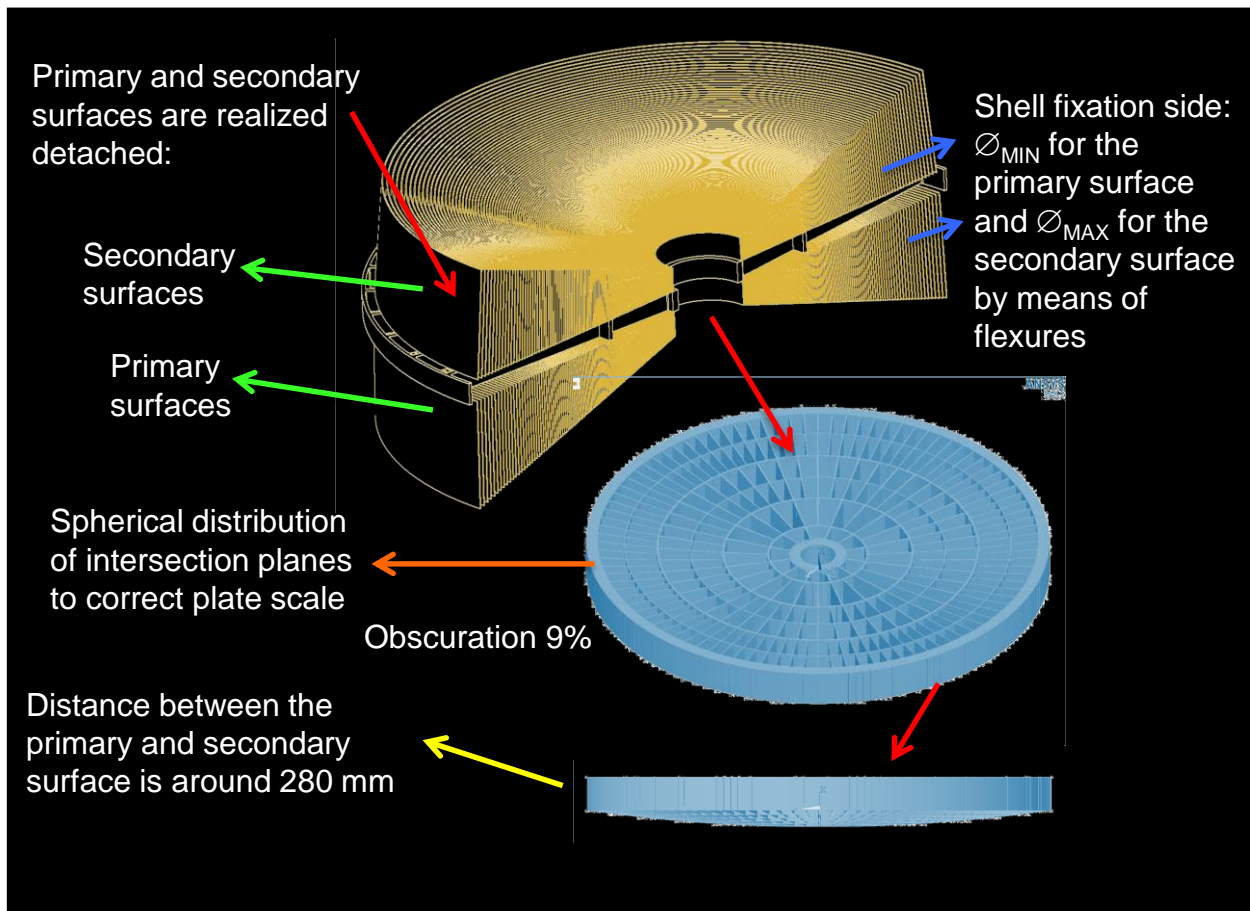
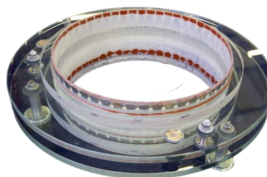

- P. Reid
- SAO Adjustable Optics Team
- PSU Adjustable Optics Team

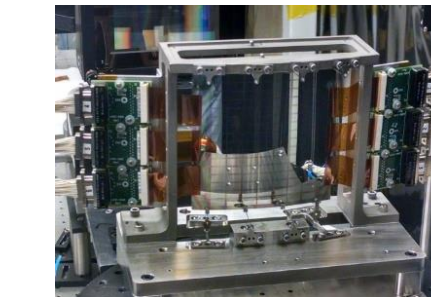
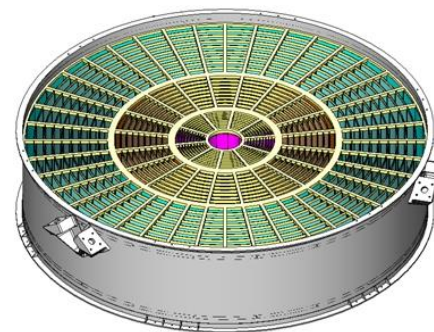

Slumped glass with sputter deposited piezoelectric material

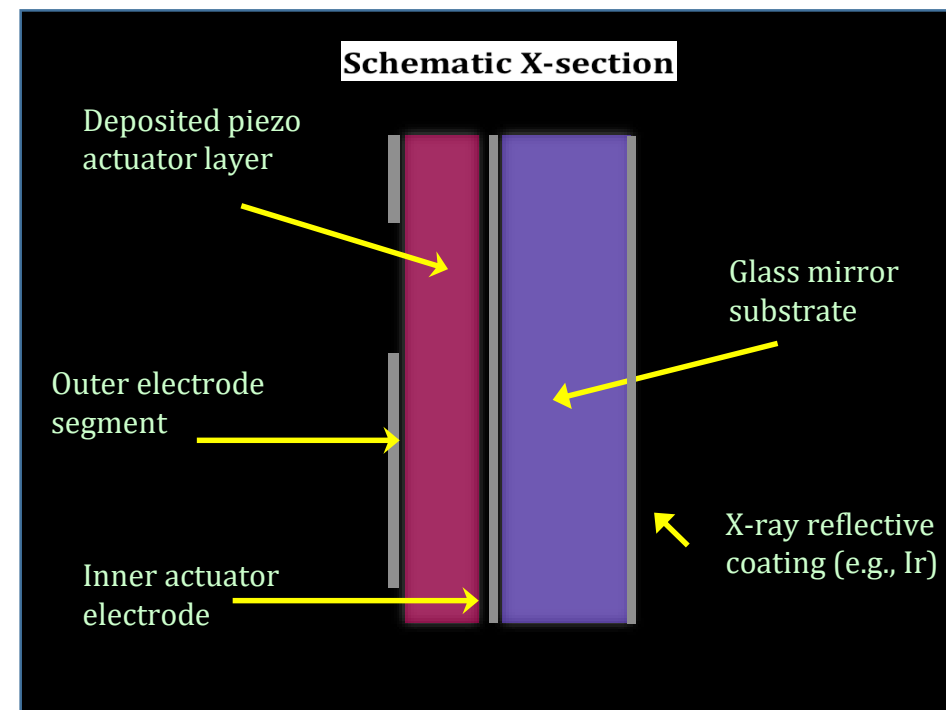



FULL SHELL OPTICS

- M.Civitani, G. Vecchi, J. Holysko, S.Basso, M.Ghigo, G.Pareschi, (INAF-OAB)
- G.Parodi (BCV progetti), G.Toso (INAF-IASF)
- K. Kiranmayee , J. Davis, R. Elsner D. Swartz (MSFC/USRA)

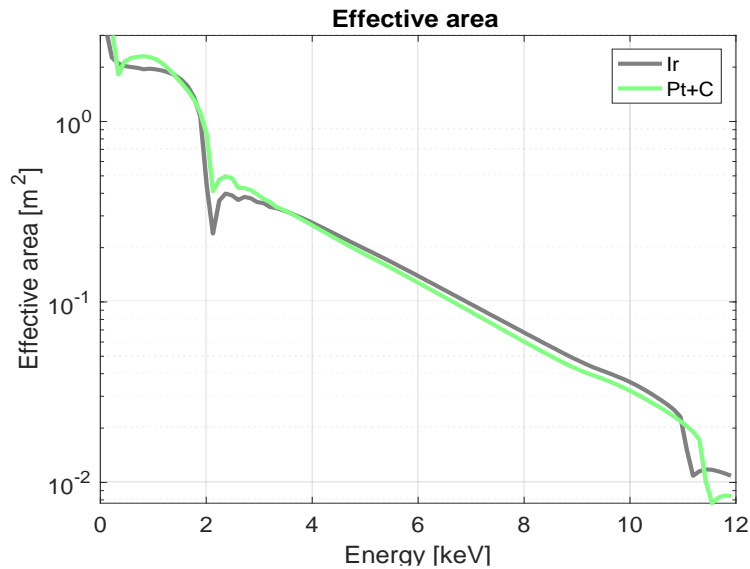

164 Shells!

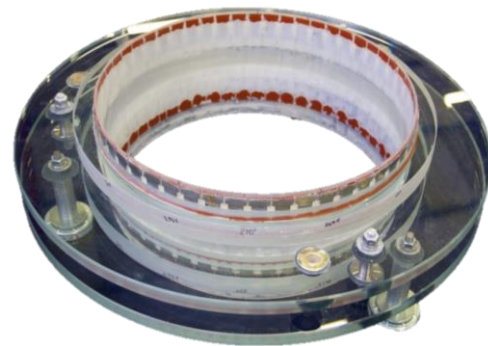

Parameters	Values
Gap @ IP (mm)	280
Shift IP (*) (mm)	2.3 (Inner) – 124.7 (Outer)
Total Number of Shells	164 (x2 Primary + Secondary)
Radius (mm)	203.2 (Inner) – 1483.8 (Outer)
Semi-Shell height IP (mm)	157.9 (Inner) - 348.2 (Outer)
Thickness IP Inner/Outer (mm)	1.6 – 3.4
Total mirror assembly mass (kg)	1,890.7 986.3 Primary 904.4 Secondary
Mirror support structures & thermal control (*estimate*) (kg)	300 (TBC)



INAF-BRERA PROCESS OVERVIEW

Step	Status	< 2020
Procurement of the fused silica shell	Tested	X
Annealing		X
Chemical etching		X
Mounting the shell in a Shell Supporting System	Tested	
Fine grinding	Tested	
Bonnet polishing	Tested	
Pitch polishing	Tested	
Ion beam figuring		
Coating		
X-ray calibration	Tested	X

Raw shell production

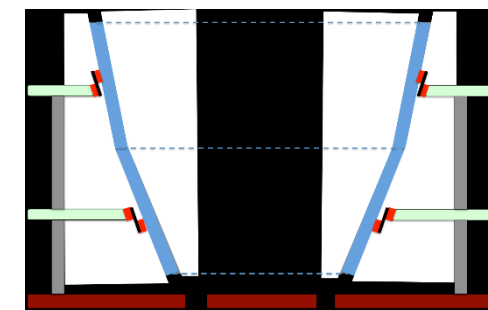
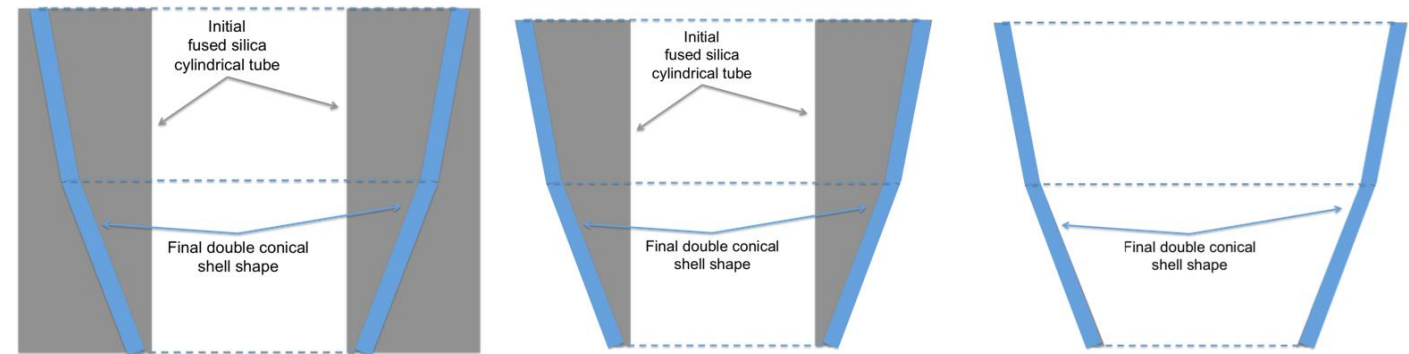

Fixation in a supporting system

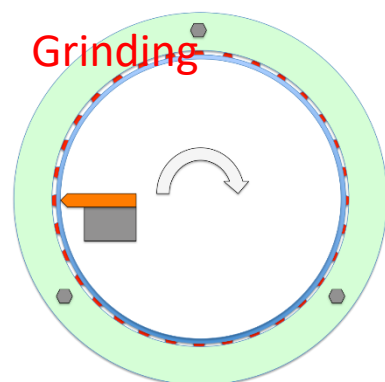

Grinding

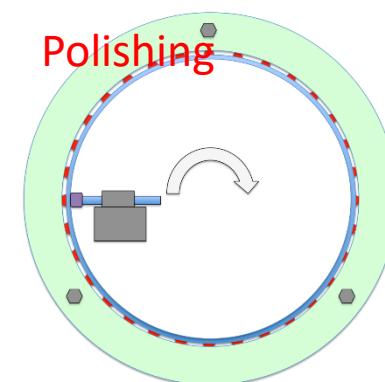

Polishing

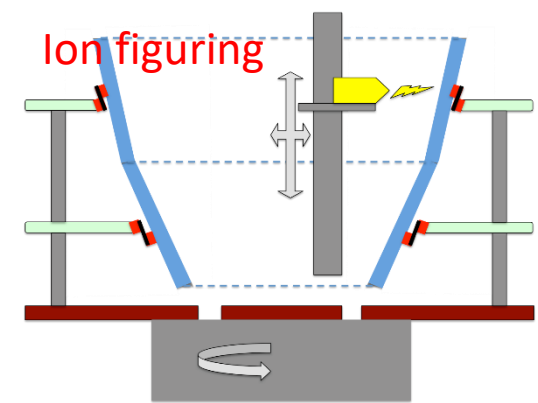

Ion figuring



MSFC FULL SHELL OPTICS FABRICATION PROCESS



Machined mirror blanks

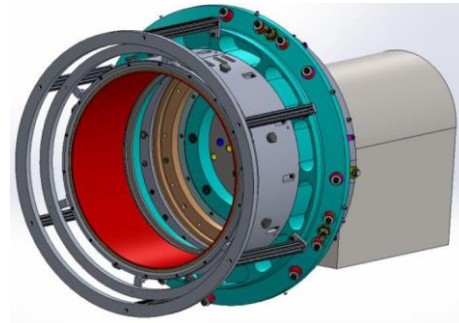

Diamond turning
TRL~2



Computer controlled polishing
TRL~3

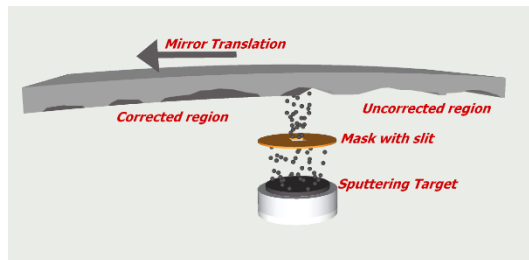

Differential deposition
TRL~3

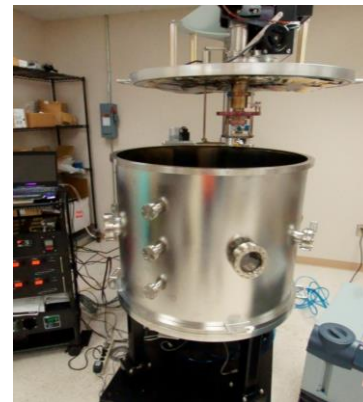

Low-stress reflective
coatings
TRL~3



Alignment and module integration
TRL~3



ADJUSTABLE OPTICS

- P. Reid
- SAO Adjustable Optics Team
- PSU Adjustable Optics Team

Parameters	Values
Total Number of Segments	12,720
Total Number of Shells	265
Number of Piezoelectric adjuster cells per mirror segment	~1500
Number of strain gauges per segment	~10
Radius (mm)	200 (Inner) – 1500 (Outer)
Segment Size (L x H) (mm)	200 x 220 – 200 x 120
Thickness Inner/Outer (mm)	0.4
Total mirror assembly mass (kg)	1,580 (includes pre- and post-thermal collimators)

Slumped glass with sputter deposited piezoelectric material

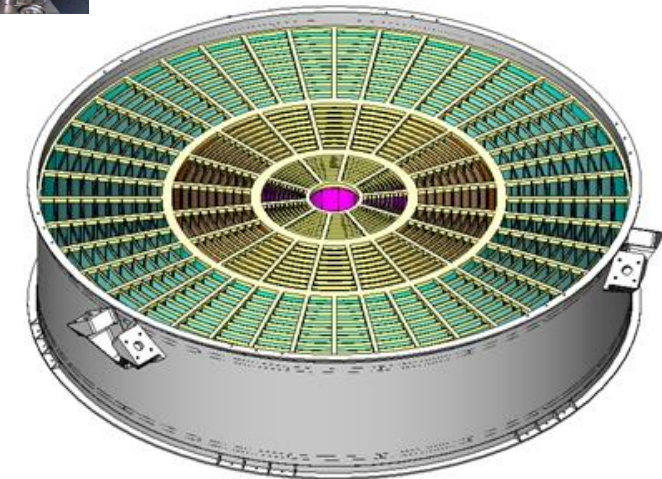
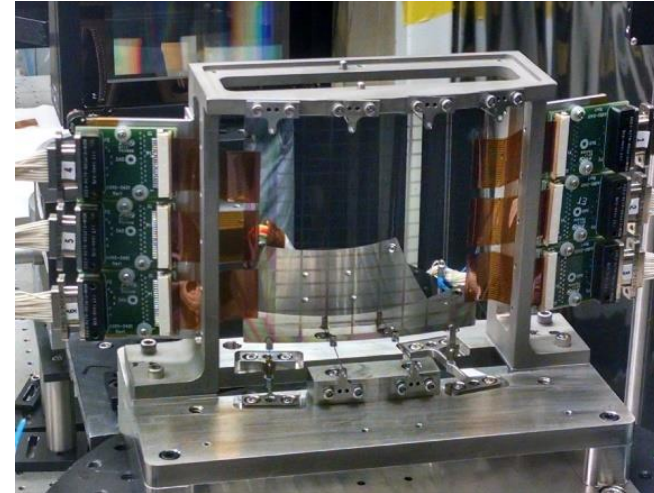



ADJUSTABLE OPTICS PROCESS

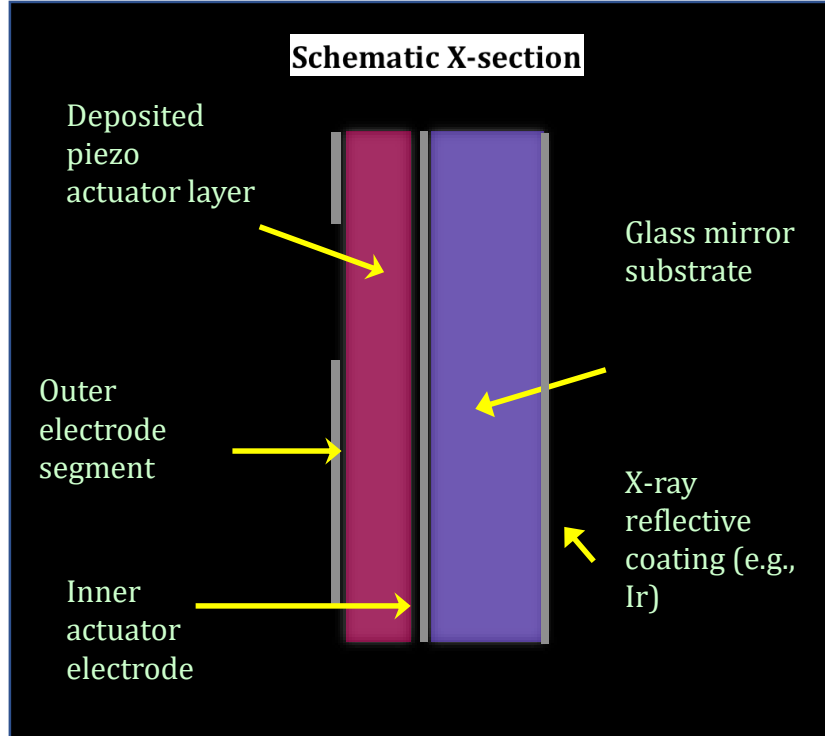

a) Multilayer mirror

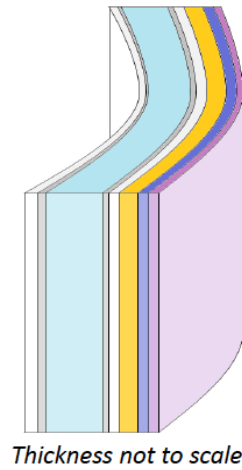

b) Layers of the mirror

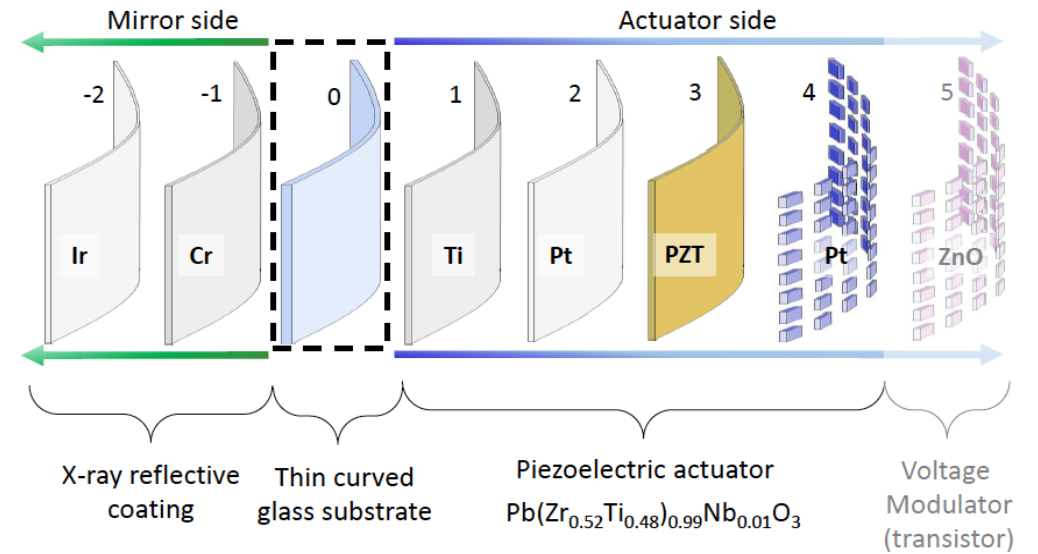



THE TIME FOR LYNX IS NOW!

Enabling Technologies TRL Assessment Summary

At Decadal Studies Management Team request, the ExEP, PCOS, and COR Program Offices and the Aerospace Corp assessed the TRL of tech gaps submitted by the teams as of Dec. 2016. Assessment was presented June 2017.

ID	Technology Gap	TRL
1	High-Resolution 'Lightweight' Optics	2 3
2	Non-deforming X-ray Reflecting Coatings	3
3	Megapixel X-ray Imaging Detectors (HDXI)	3
4	X-ray Grating Arrays (XGS)	4
5	Large-Format, High Spectral Resolution X-ray Detectors (LXM)	3

**Multiple Technologies
3-4+ by mid-2020**

**Multiple Technologies
Multiple Technologies**

Subsystem Heritage

THANK YOU!

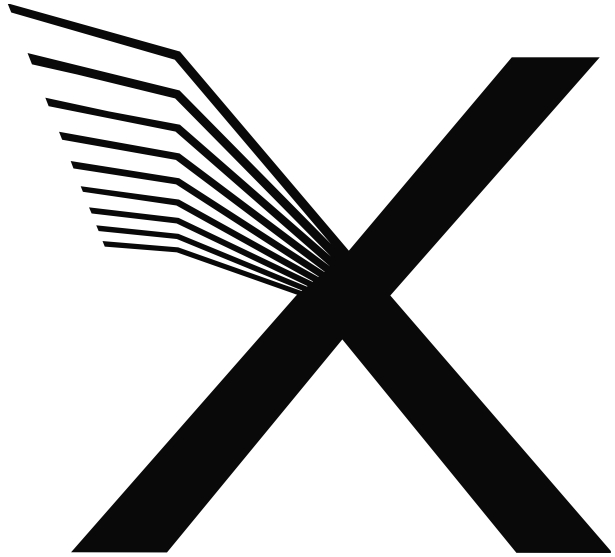

Jessica.Gaskin@nasa.gov

Lynx Websites:

<https://wwwastro.msfc.nasa.gov/lynx/>

<https://www.lynxobservatory.com/>

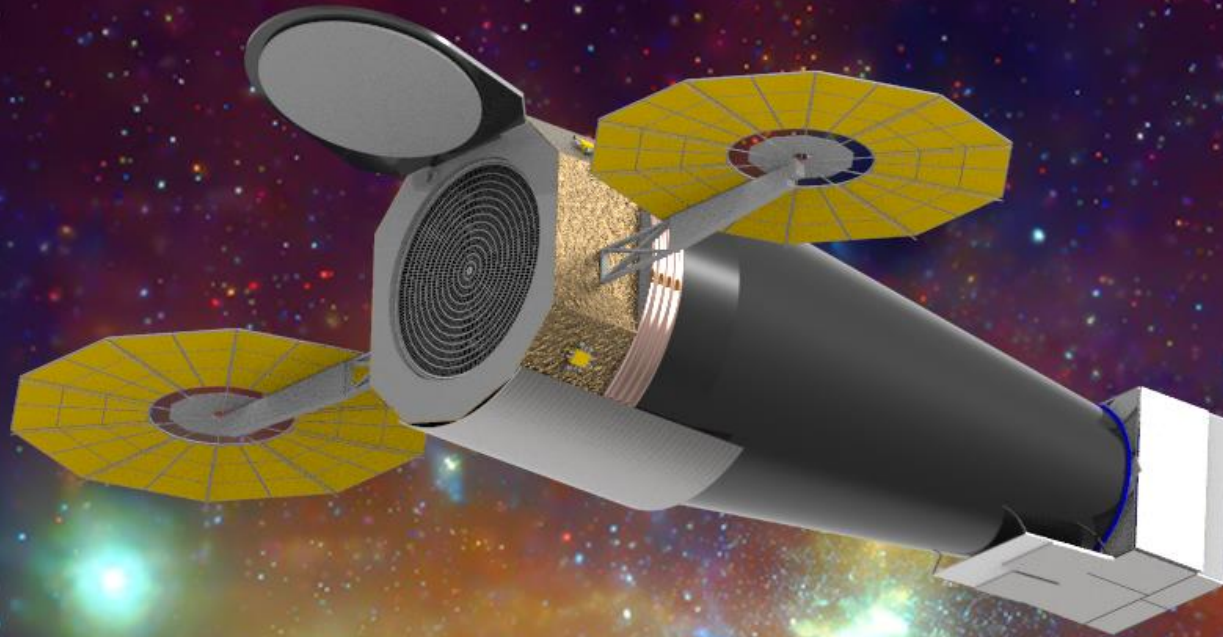

- Large effective area is achieved by nesting a few hundred to many thousands of co-aligned, co-axial mirror pairs.
- Must fabricate thinner mirrors to allow for greater nesting of mirror pairs and larger effective area while reducing mass
- These thin mirrors must be better than 0.5" HPD requirement.
- Must mount and coat these thin optics without deforming the optic, or must be able to correct deformations.