



5 . . . 4 . . . 3 . . . 2 . . . 1 . . .

SPACE LAUNCH SYSTEM

Modeling and Simulation Techniques for the NASA SLS Service Module Panel Separation Event; From Loosely-Coupled Euler to Fully-Coupled 6-DOF, Time-Accurate, Navier-Stokes Methodologies

Les H. Hall
Mclaurin Aerospace
Jacobs ESSCA Group

INTRODUCTION

- **Goal: Create an aerodynamic database which can be coupled with a 6-DOF model to accurately predict Service Model (SM) panel separation from SLS in a time efficient manner.**
- **Requires spatial prediction of SM panel flight space in proper environment, generated with CFD analysis. The resultant database is divided into three zones:**
 - Panels rotating about an aft hinge during initial separation in which not only body, but panel to panel effects are important.
 - Panels in near proximity to the body.
 - Panels alone in freestream environment.
- **Data placed into Matlab, which builds response surfaces based on the input independent and dependent variables. This response surface can be queried at desired independent variable values to determine the corresponding dependent variable of interest.**

INTRODUCTION

- Panel 2, the windward panel, poses greatest risk of recontact and will be the focus of this presentation.
- Database uncertainty estimated.
- Inviscid SM database compared to viscous time-accurate fully coupled 6-DOF simulations.

SERVICE MODULE AND SLS OML

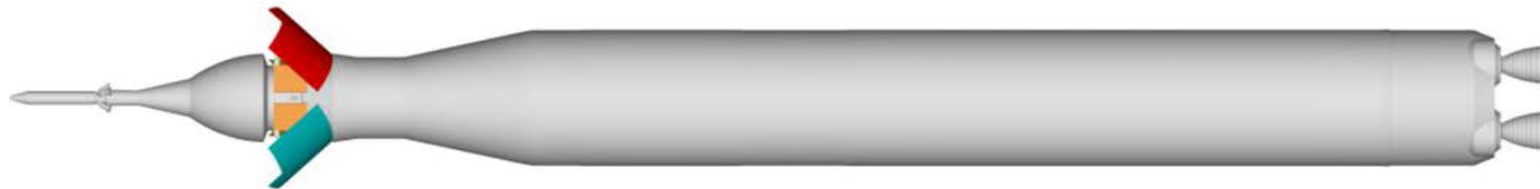

Panel 1 Panel 2 Panel 3 Solar Panel

Side view of SLS Center Body geometry with panels open at 45° on hinge.

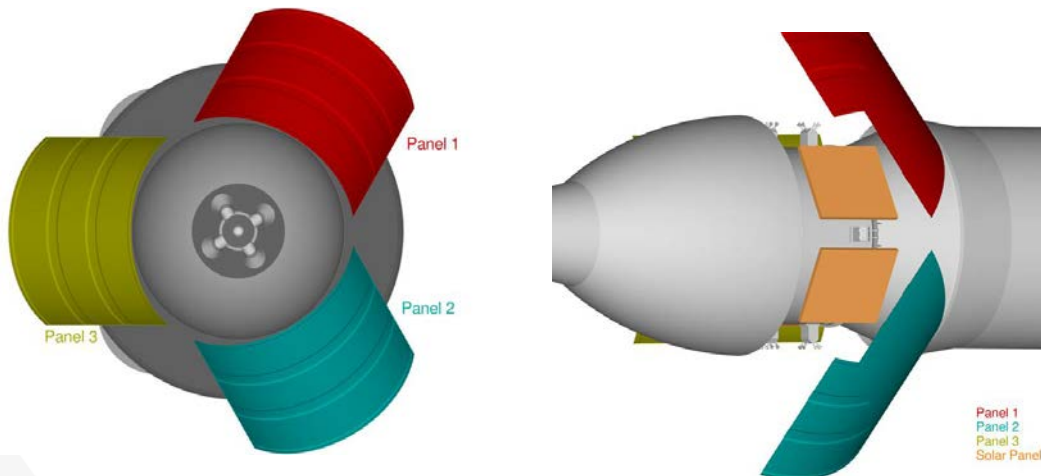

Front view of SLS Center Body geometry (left) and close up of internal cavity geometry (right) with panels open at 45° on hinge

SM PANEL DETAILS

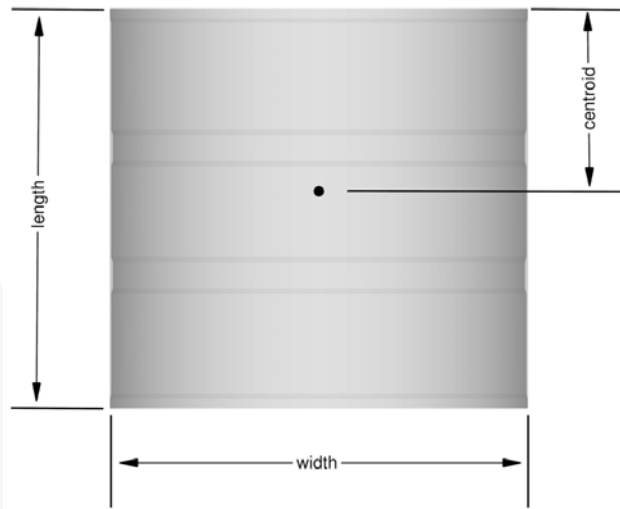

Top View

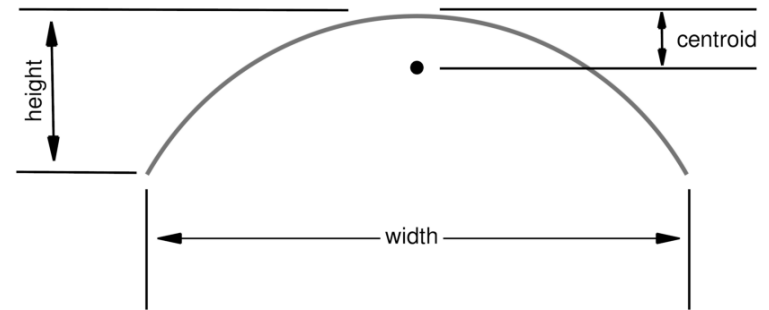

Front View

Panel Geometry

DATABASE IS DIVIDED INTO THREE ZONES

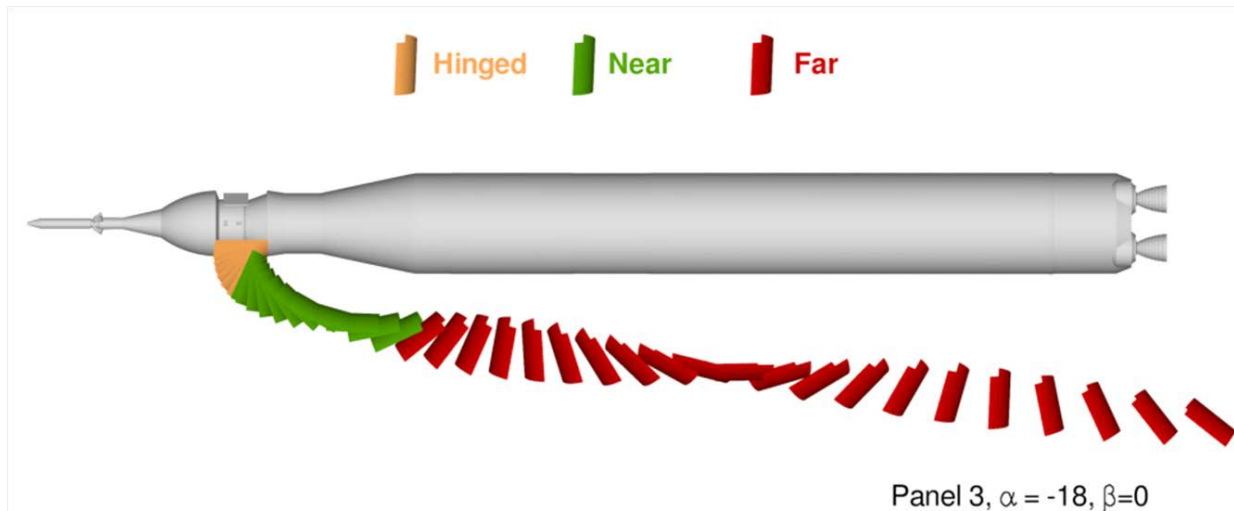

Displays the three database zones, hinge (orange), near proximity (green), and far (red)

PANEL ORIENTATION AND DATABASE BOUNDS

Bounds of the SM Panel Database

Mach number	7.0	
Angle-of-attack, deg	-25.0	-15.0
Sideslip angle, deg	-5.0	5.0

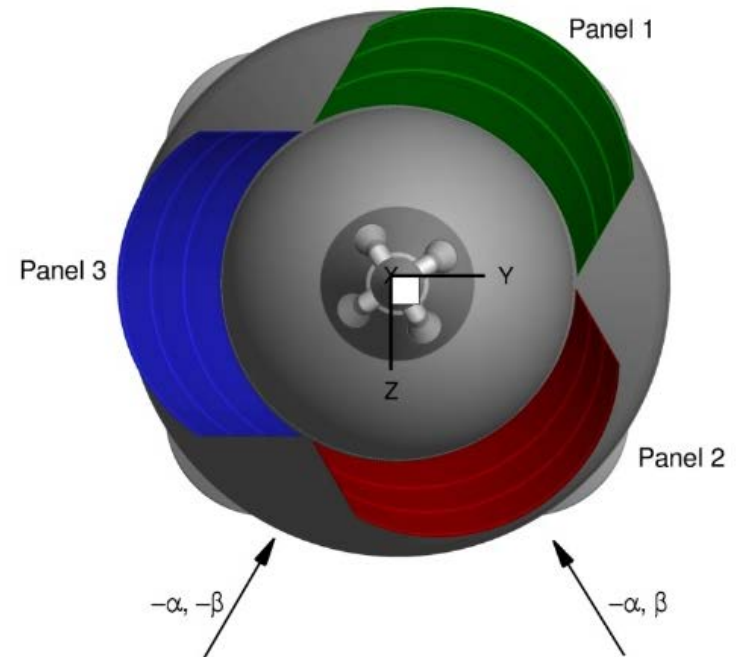

Panel orientation with respect to angle of attack (α) and sideslip (β)

EFFECTS ON PANEL TRAJECTORY WITH/WITHOUT SLS CENTERBODY

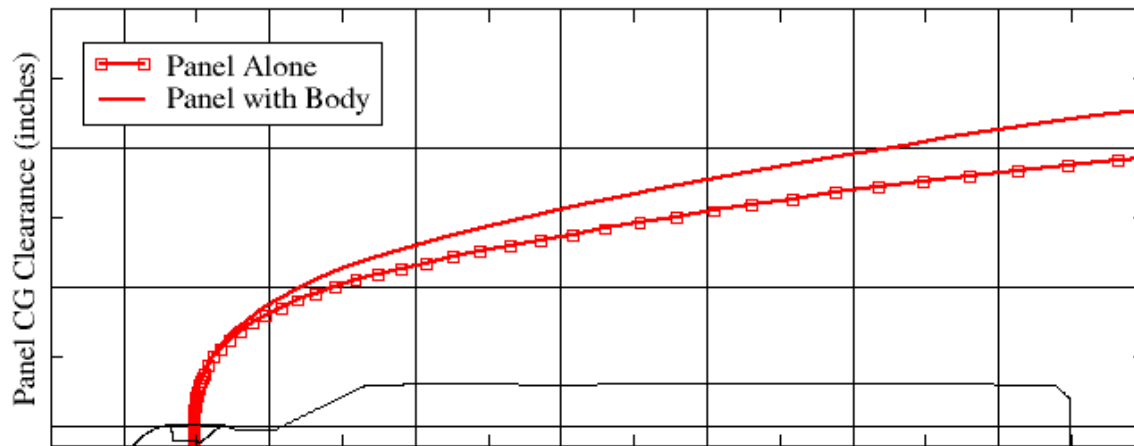

Panel trajectory predictions: Panel alone vs panel with SLS body included

EFFECTS ON PANEL TRAJECTORY WITH/WITHOUT SLS CENTERBODY

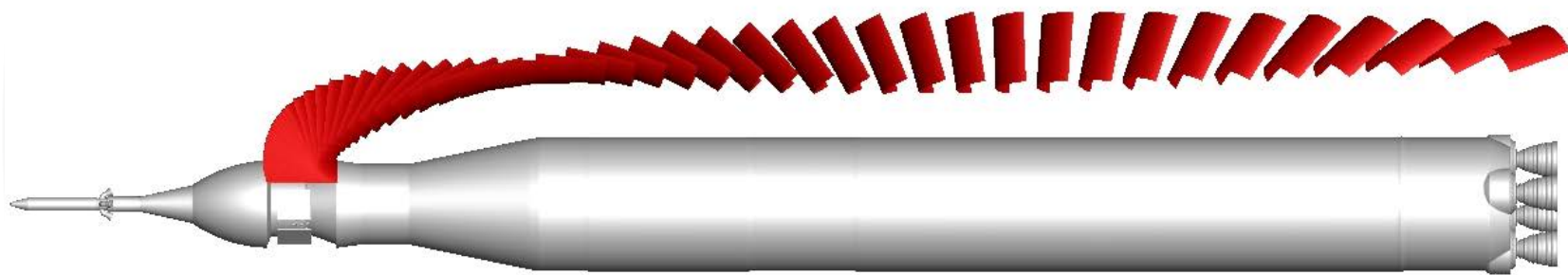

Panel 2 with body aerodynamic effects

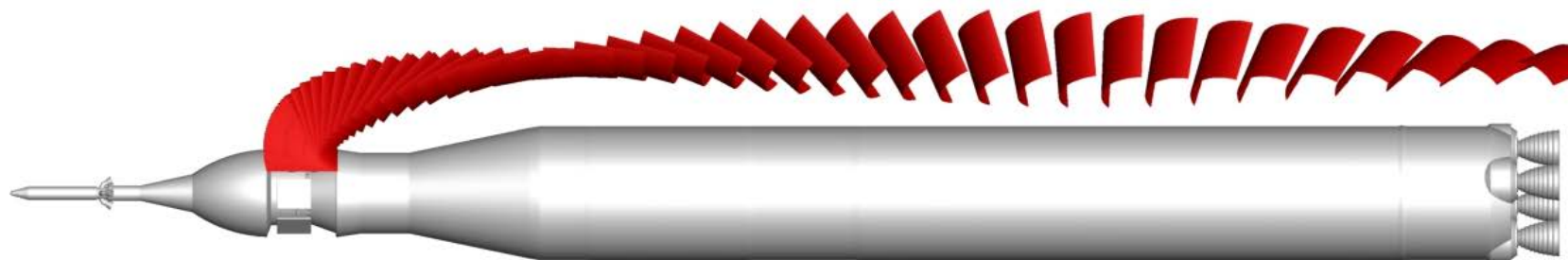

Panel 2 alone – No body aerodynamic effects

Panel trajectory predictions: Panel alone vs panel with SLS body included

REPRESENTATIVE PANEL CLOSEST POINT TRAJECTORIES

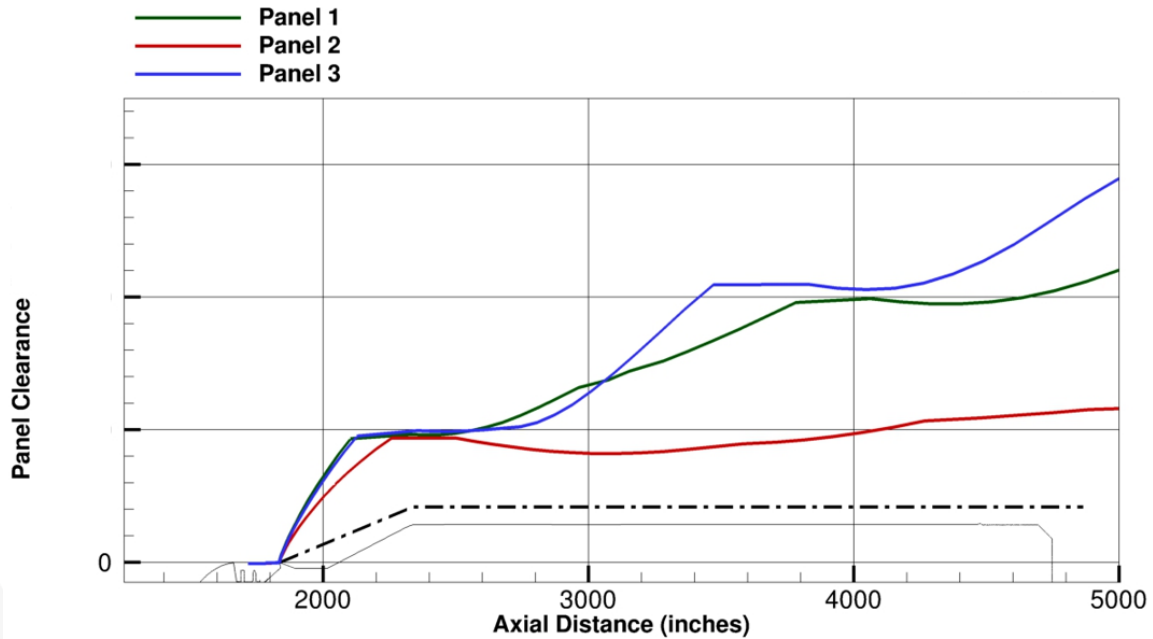

Panel closest point trajectories at high angle of attack

Database Aerodynamic Coefficients

- Cart3D CFD Solver
- Developed at NASA Ames
- Inviscid Adaptive Cartesian
- Adjoint adaptation capabilities used for each of the three zones (*i.e.*, hinged, near proximity, and far field)
- Adaptation functional was a composite of the force components on each of the three panels, equally weighted
- meshes ranged from 3 million to 6 million cells

Viscous Check-Cases

- Loci/CHEM Solver
- Primary Developer Mississippi State University with partial funding from NASA, DoD
- Unstructured Navier-Stokes
- Hybrid Roe/HLLE scheme
- Wilcox 2008 two-equation K-omega turbulence model

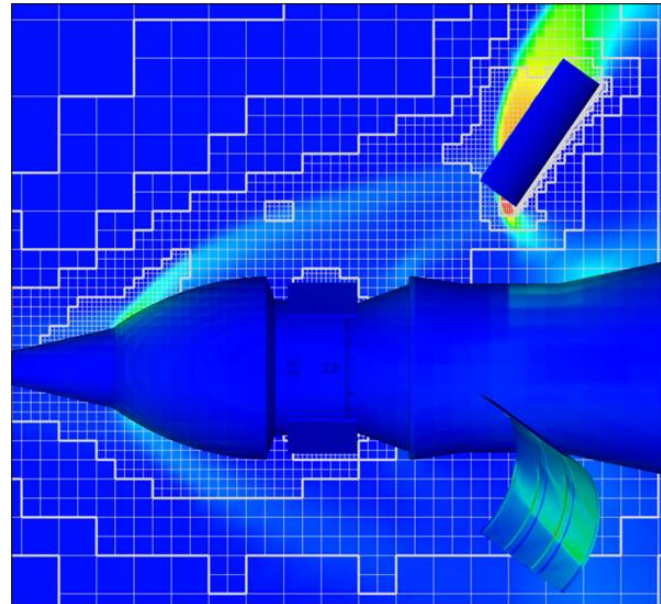

Pressure contours for a near proximity case with panels pitched 30° from baseline orientation.

HINGED PANEL PORTION OF DATABASE

- **Hinged panel geometric matrix**

- Panels rotated about the hinge axis from 0° to 65° by 5° increments.
- A maximum of 15° difference in rotation angle is allowed between any two panels
- For rotation angles of 0° , 5° , and 10° the panels are not allowed to vary from each other. During this time the panel motion is dominated by the spring forces
- 2,172 simulations for the hinged panel dataset

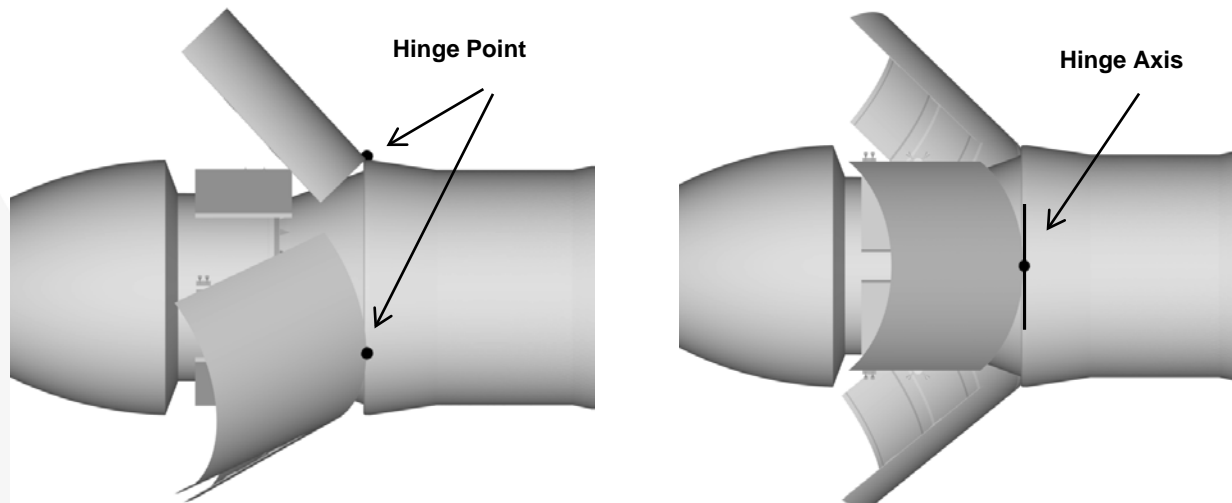

Panel hinge point and hinge axis

VISCOUS VS INVISCID FORCES WHILE HINGED

Panel 2 hinge moment coefficient comparison
 $\alpha = -21$, $\beta = 5$

Panel Rotation in Degrees (P1-P2-P3)	% Difference between inviscid and viscous
10-10-10	25.9%
15-15-15	19.5%
20-20-20	5.7%
25-25-25	4.3%
30-30-30	2.8%
35-35-35	3.3%
45-45-45	4.0%
50-50-50	0.5%
55-55-55	3.3%
60-60-60	4.6%

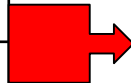

Spring force ~5x larger than aerodynamic forces acting on the panel for this region

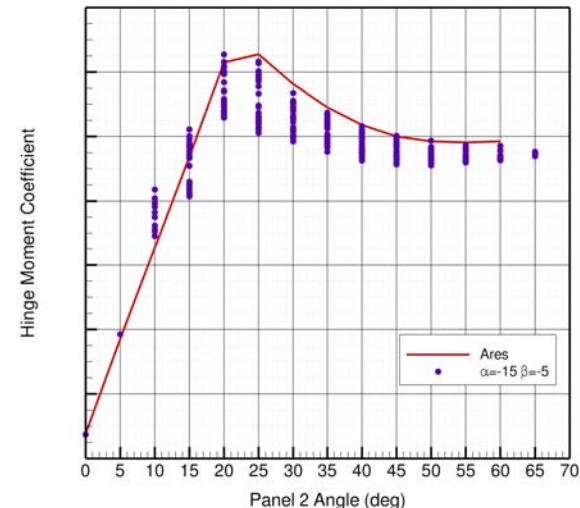

Effect of Panel-to-Panel Aerodynamic Influence
 Diminishes as Panels Rotate

PANEL NEAR BODY PROXIMITY REGION

- **Near proximity panel geometric matrix**
 - Nine panel stations: 3 axial stations x 3 radial stations
 - There are 7 pitch orientations at each station: with θ_z ranging from $\pm 45^\circ$ from the baseline in 15° increments
 - There are 3 roll orientations with θ_x at 0° (baseline) and $\pm 10^\circ$ from the baseline
 - There are 3 yaw orientations with θ_y at 0° (baseline) and $\pm 10^\circ$ from the baseline

PANEL NEAR BODY PROXIMITY REGION

- Near body proximity panel geometric matrix

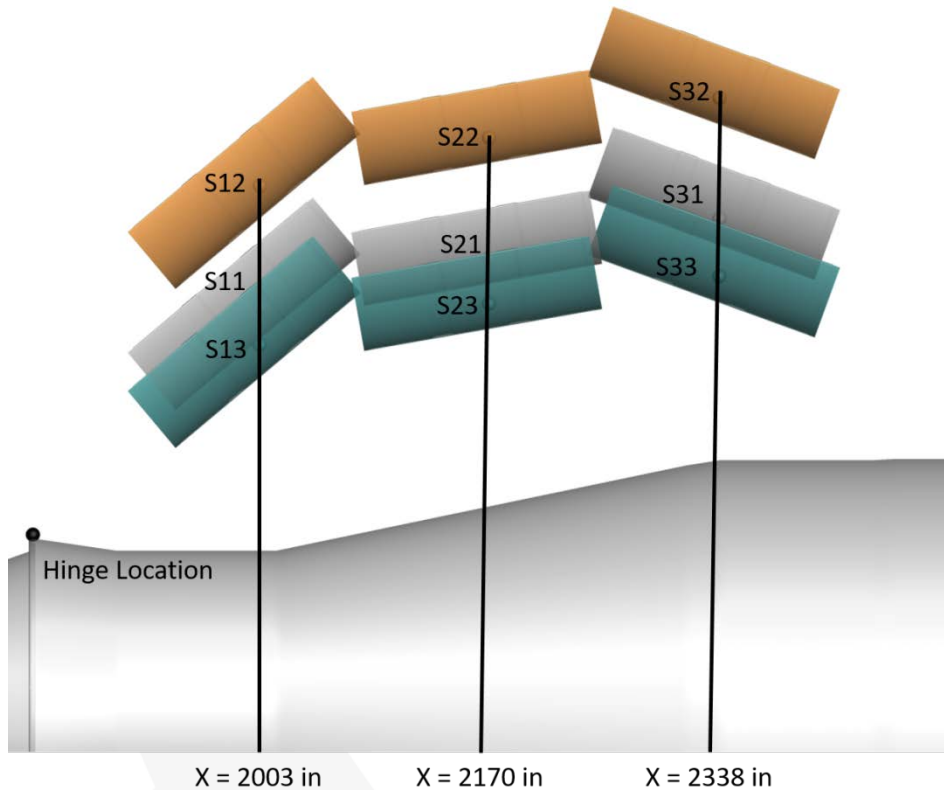

Additional near body proximity radial stations (shown as blue) for revision 1 of the database.

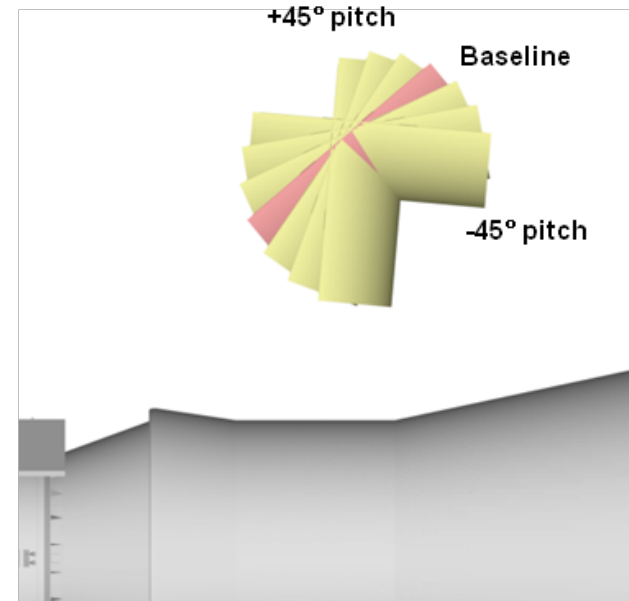

Euler angle pitch deflections from baseline for near body proximity cases

PANEL NEAR BODY PROXIMITY REGION

- Near body proximity geometric matrix

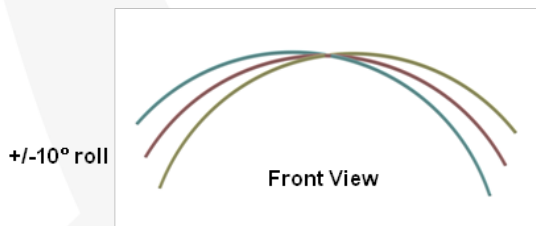
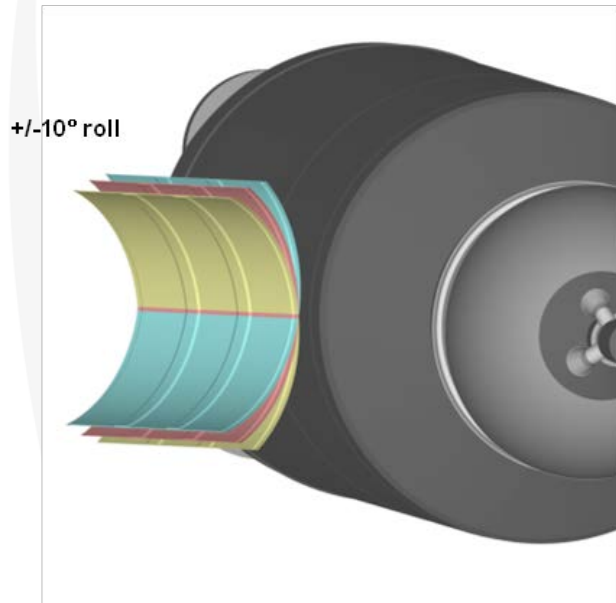

Euler angle roll deflections from baseline for the near body proximity cases

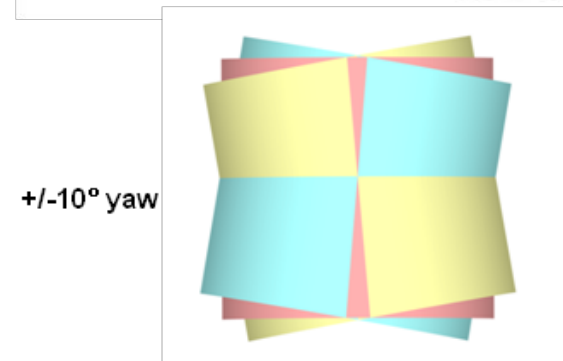
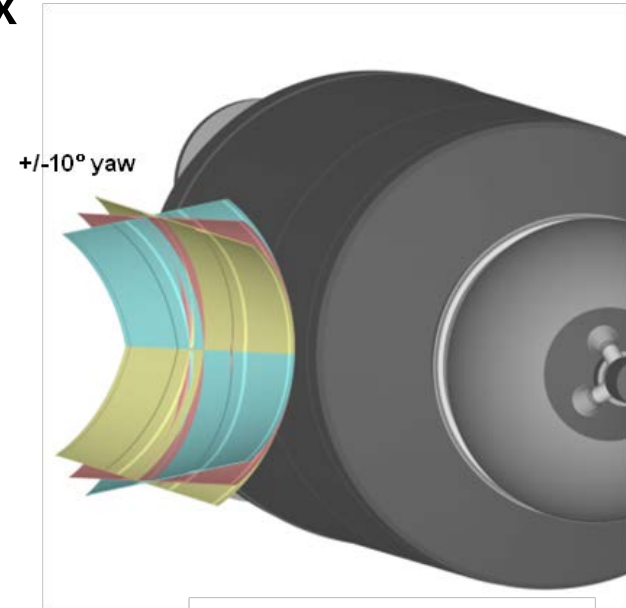

Euler angle yaw deflections from baseline for near body proximity cases

PANEL NEAR BODY PROXIMITY REGION

- Near proximity panel geometric matrix

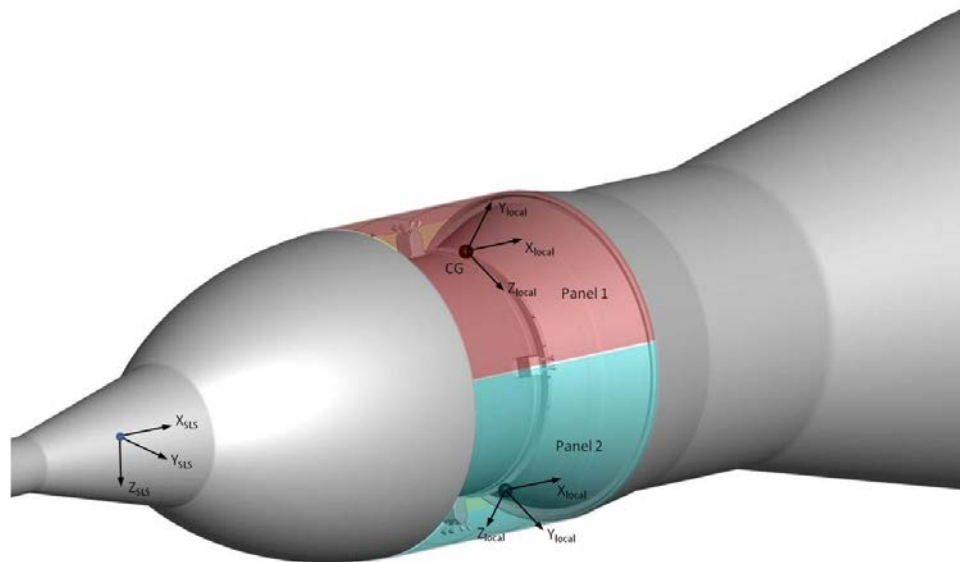

Local-panel coordinate system for each panel on the SLS Center Body

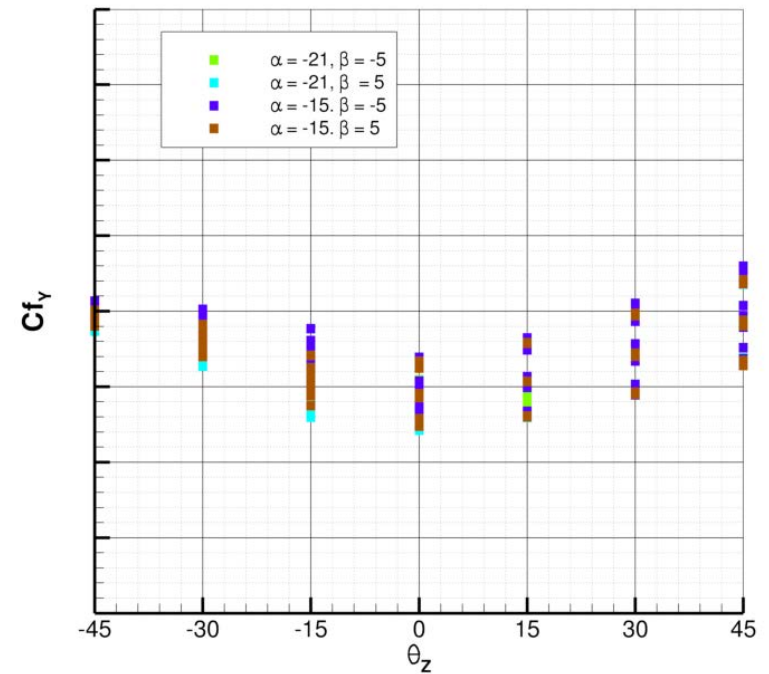

Panel 2 C_{fy} versus pitch angle for station S11

FAR PANEL; FREESTREAM CONDITIONS

- **Far panel geometric matrix**

- The center of gravity of the panel is located at coordinate (0,0,0)
- All rotations occur about the center of gravity of the panel
- The Z-rotations (pitch, θ_z) are from 0° to 360° in 15° increments.
- The X-rotations (roll, θ_x) are from 0° to 360° in 15° increments.
- The Y-rotations (yaw, θ_y) are from 0° to 360° in 15° increments.
- Uses panel symmetry to reduce the number of required CFD simulations from 15,000 to 2,184.
 - Pitch from 0 to 345 degrees
 - Yaw from 0 to 180 degrees
 - Roll from 0 to 90 degrees

FAR PANEL; FREESTREAM CONDITIONS

- Far panel geometric matrix
 - Coarse full geometric matrix simulated to validate the mirroring

- Red = Simulated Condition (2,148 data points)
- Black = Mirrored Condition (15,000 data points)

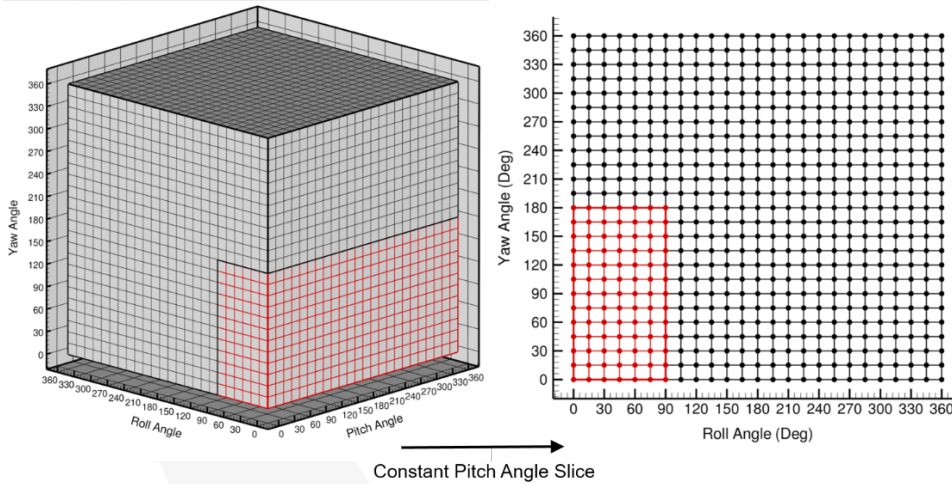

Computational CFD matrix and aerodynamic coefficient matrix for free panel.

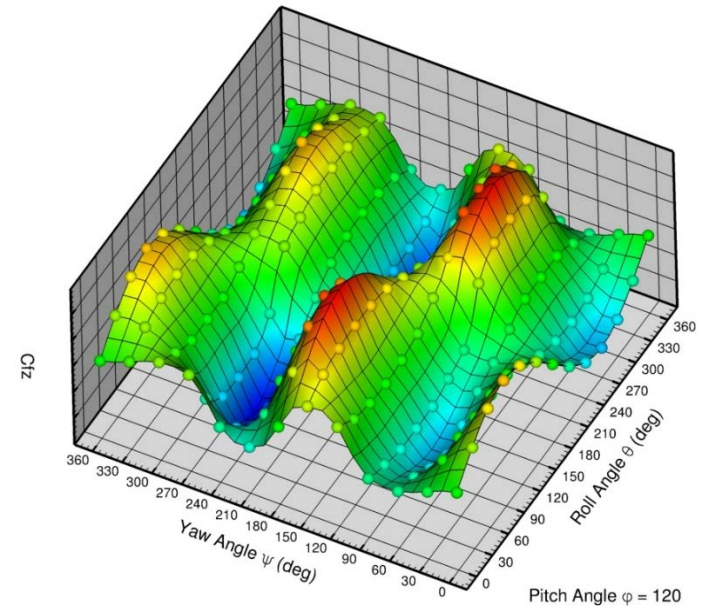

Example of data mirroring for far panel dataset. The case shown displays all C_{fx} for a pitch angle of $\theta_z = 120^\circ$

DATABASE COMPARISON TO VISCOUS TIME-ACCURATE FULLY COUPLED 6-DOF

- Viscous mesh

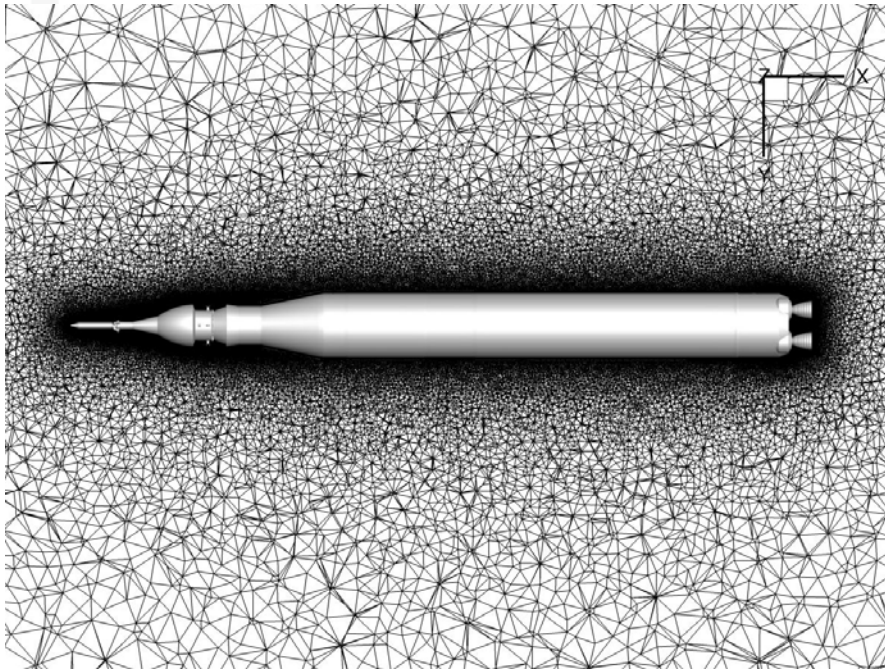

Chimera background mesh

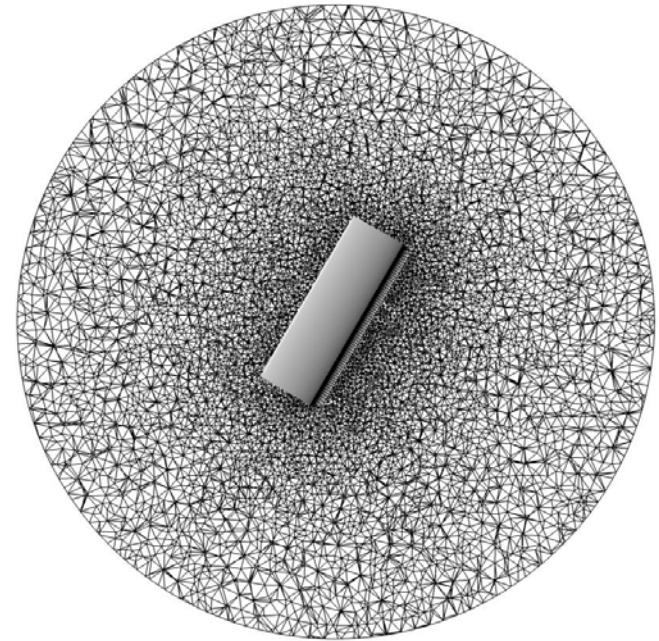

Chimera panel mesh

DATABASE COMPARISON TO VISCOUS TIME-ACCURATE FULLY COUPLED 6-DOF

- Viscous mesh

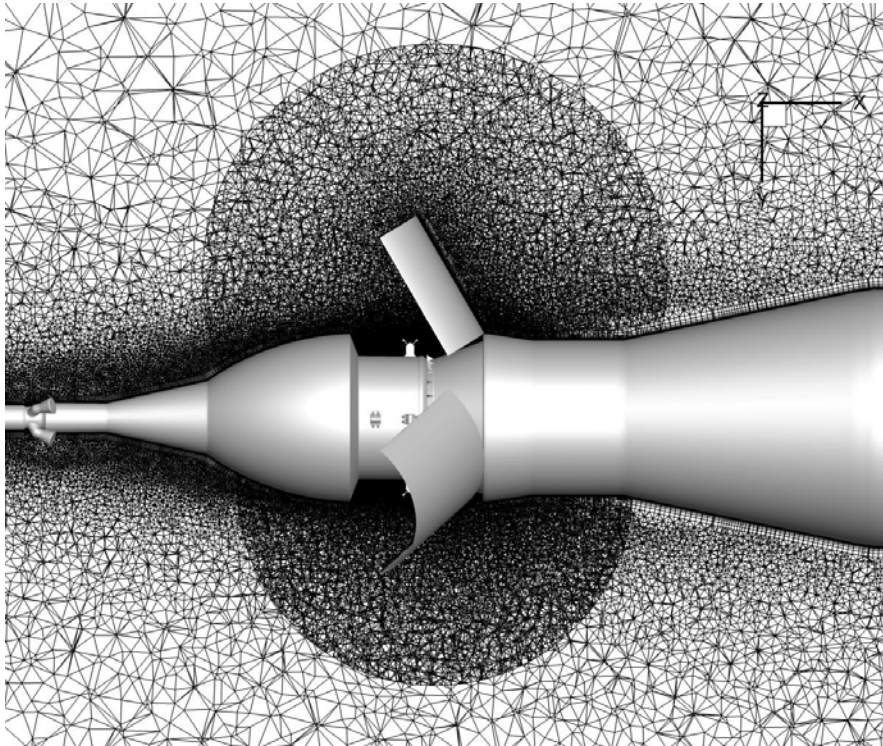

Slice through chimera and background meshes.

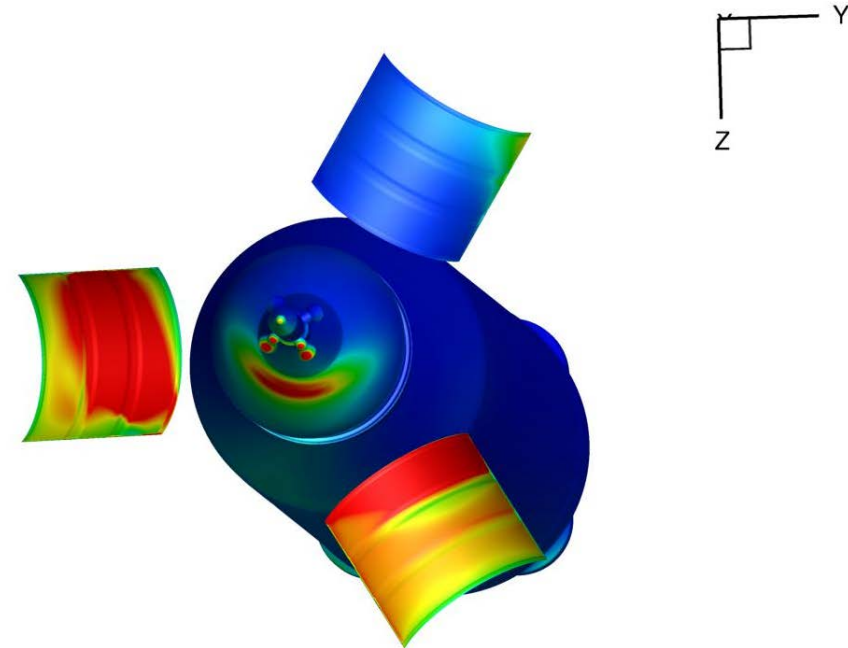

Pressure contours at 0.5 seconds after release from the hinges.

DATABASE COMPARISON TO VISCOUS TIME-ACCURATE FULLY COUPLED 6-DOF

- Viscous mesh

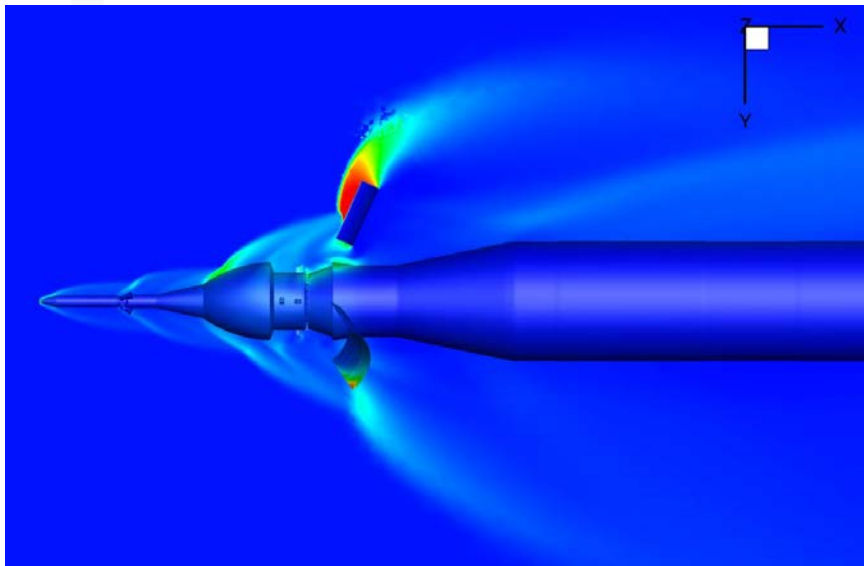

Pressure contours on a cutting plane through the chimera and background mesh.

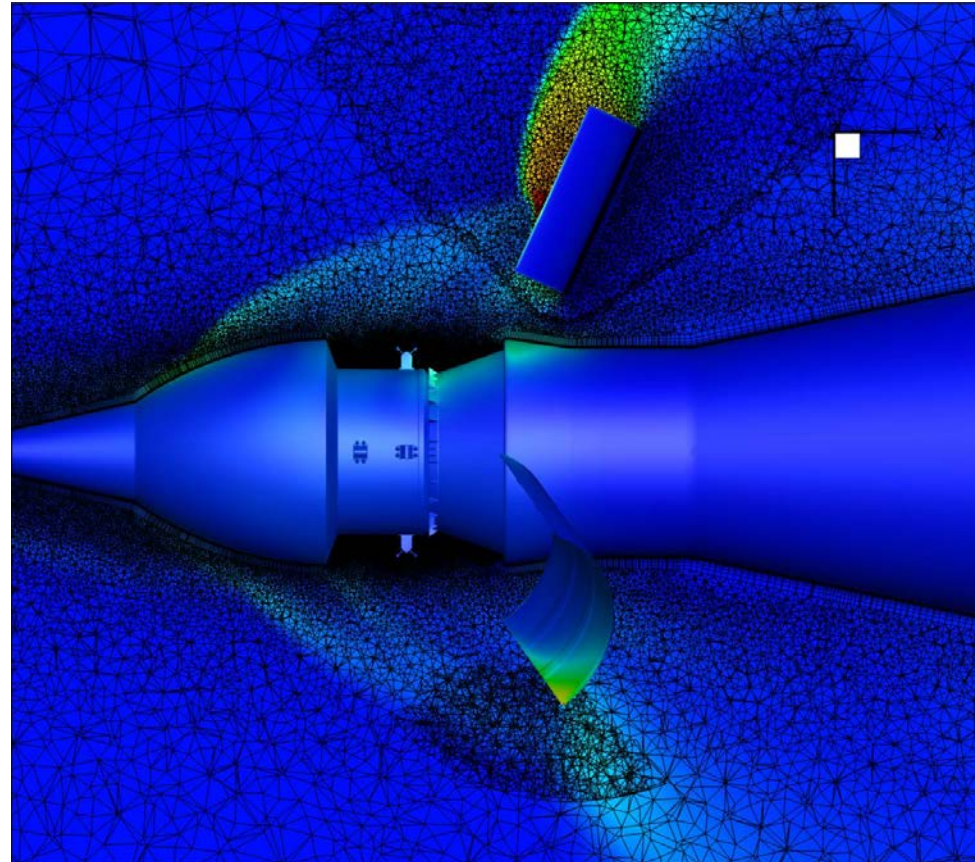

Close-up view of Chimera grid peeling.

DATABASE COMPARISON TO VISCOUS TIME-ACCURATE FULLY COUPLED 6-DOF

- Comparisons

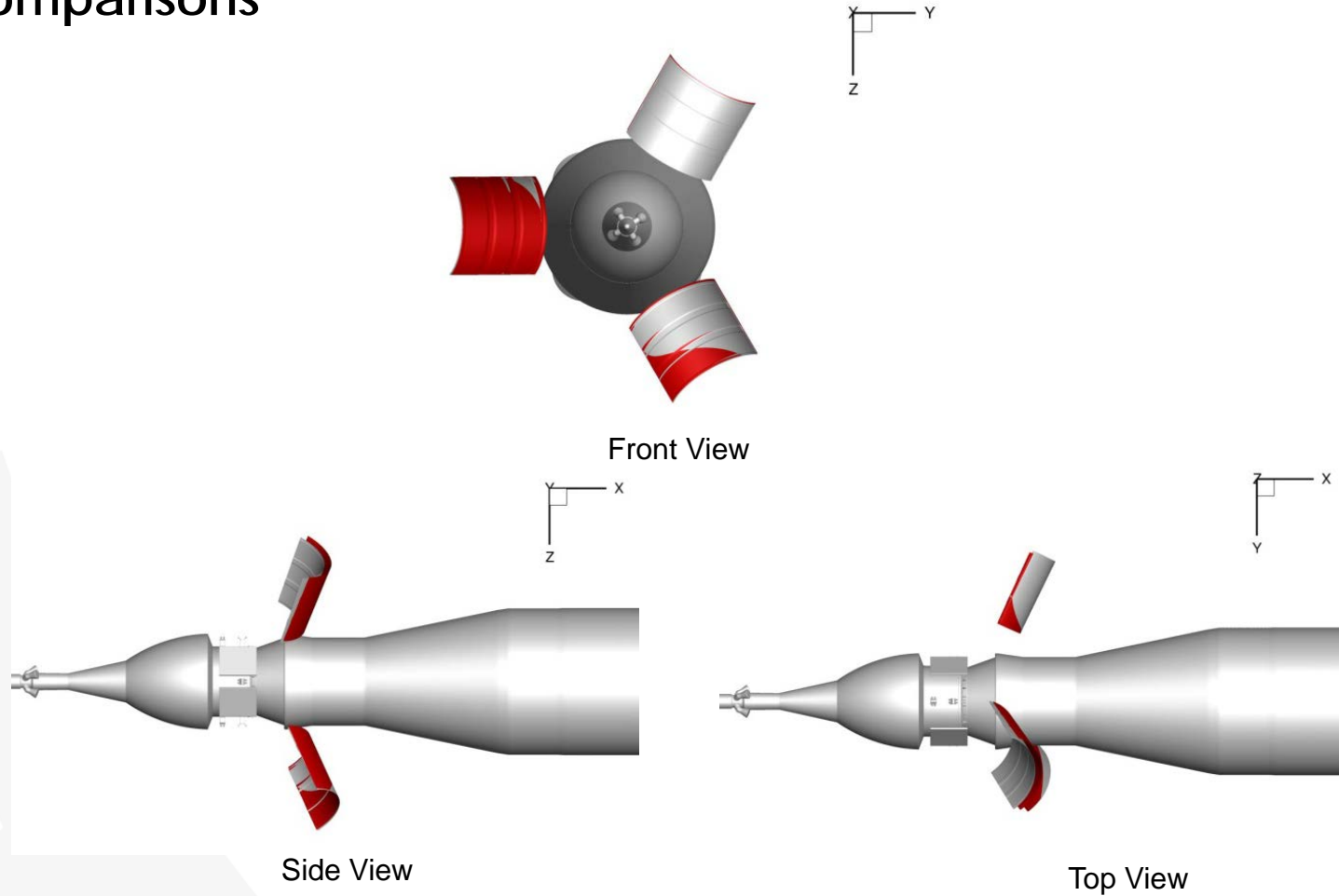

Panel orientation comparisons between Loci/Chem time dependent and database/6-DOF approaches. Red panels are Loci/Chem. Time level $t=0.5$ seconds after panels leave the hinge.

DATABASE COMPARISON TO VISCOUS TIME-ACCURATE FULLY COUPLED 6-DOF

- Comparisons

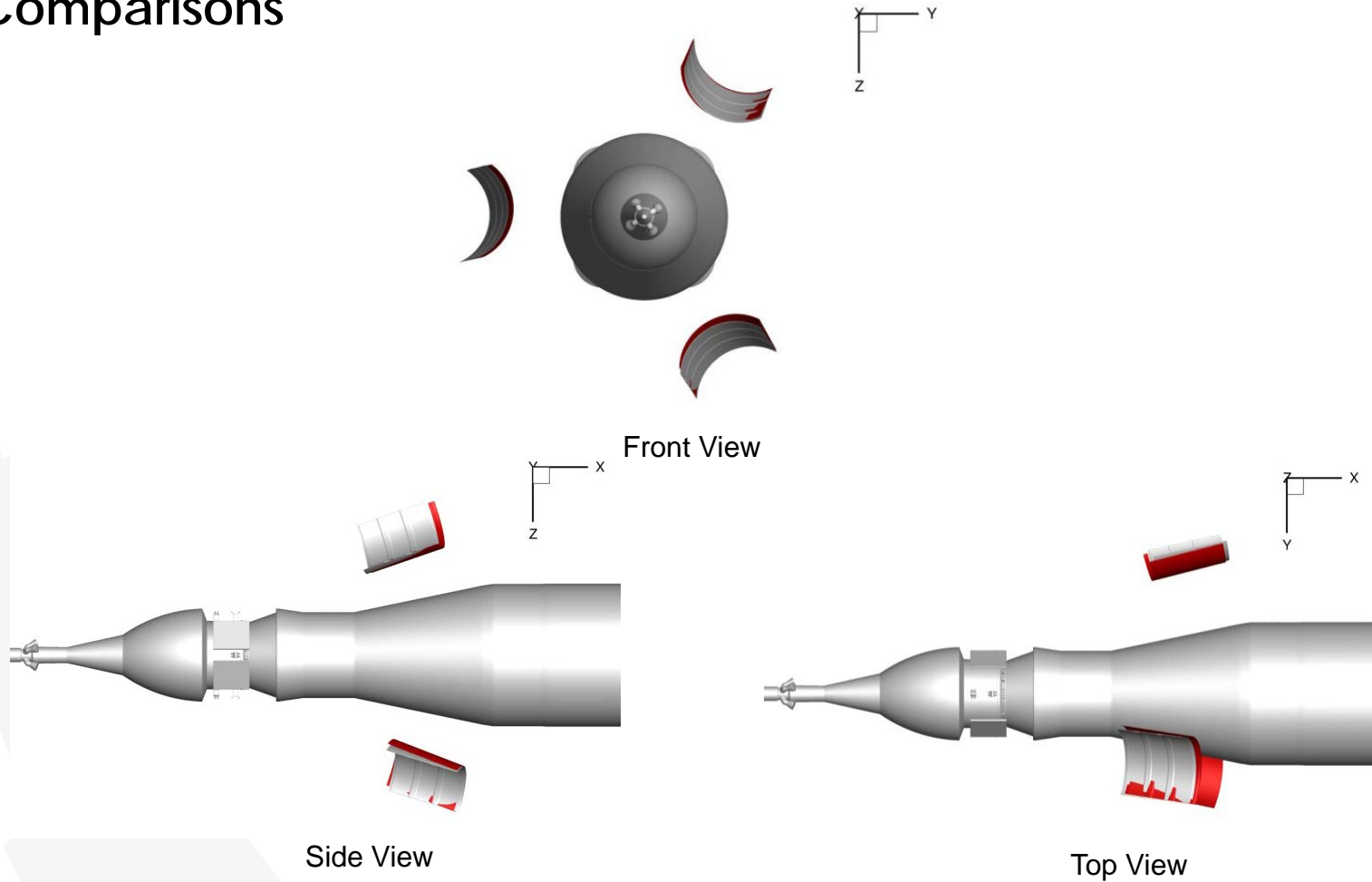

Panel orientation comparisons between Loci/Chem time dependent and database/6-DOF approaches. Red panels are Loci/Chem. Time level $t=1.0$ seconds after panels leave the hinge.

DATABASE COMPARISON TO VISCOUS TIME-ACCURATE FULLY COUPLED 6-DOF

- Comparisons

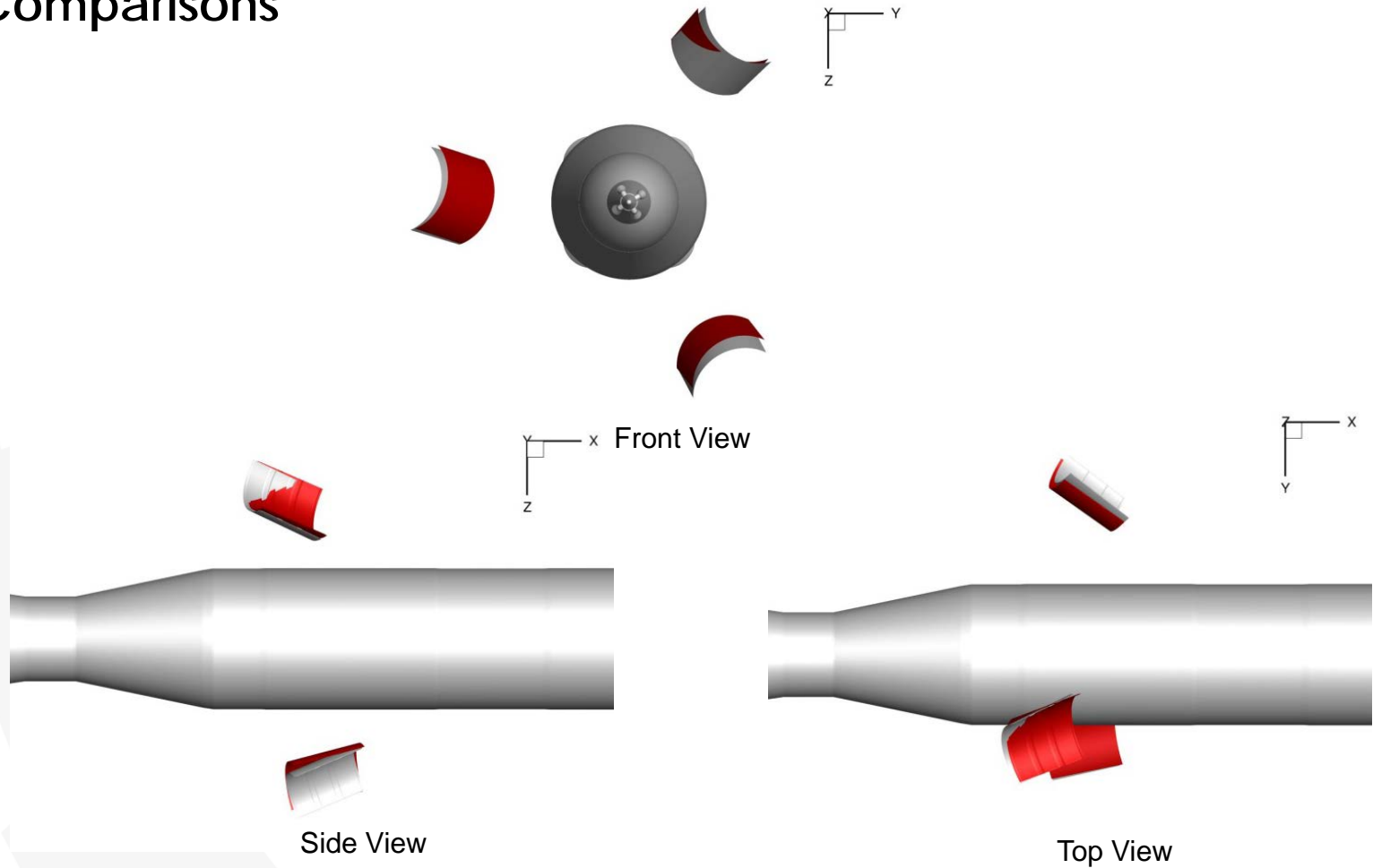

Panel orientation comparisons between Loci/Chem time dependent and database/6-DOF approaches. Red panels are Loci/Chem. Time level $t=1.5$ seconds after panels leave the hinge.

DATABASE COMPARISON TO VISCOUS TIME-ACCURATE FULLY COUPLED 6-DOF

- Comparisons

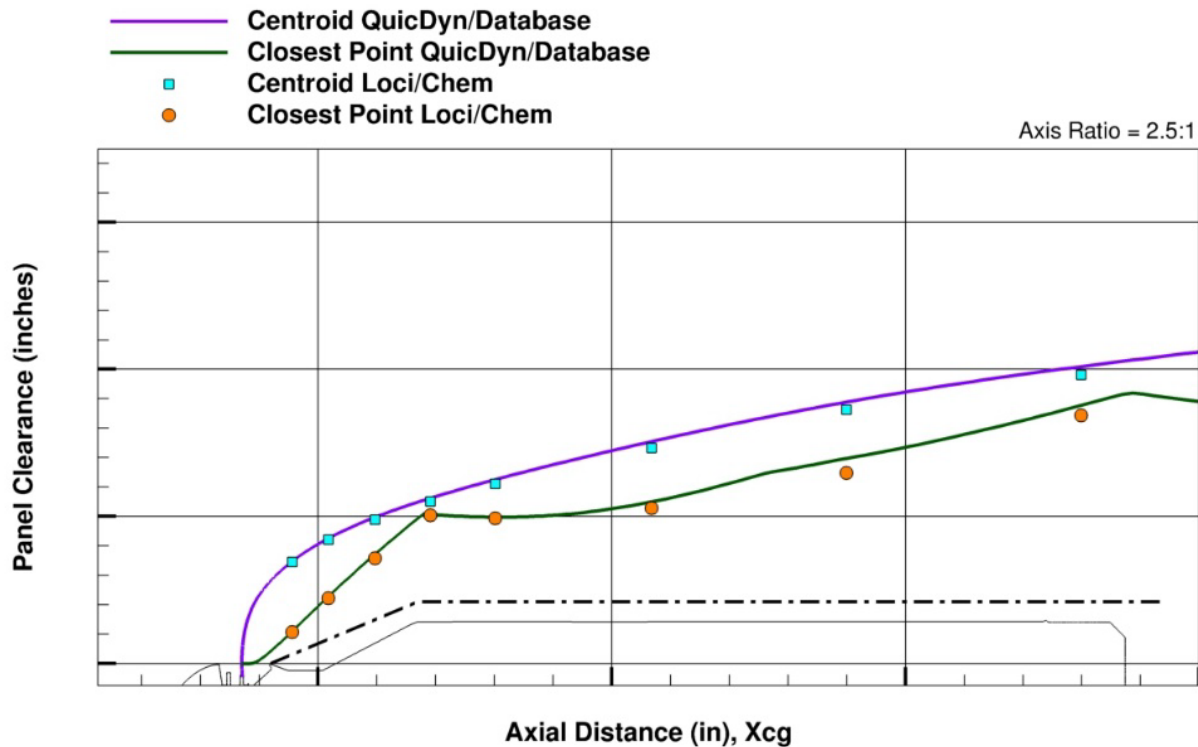

Comparison of panel clearance between Loci/Chem time dependent and database/6-DOF simulations

DATABASE COMPARISON TO VISCOUS TIME-ACCURATE FULLY COUPLED 6-DOF

- Comparisons

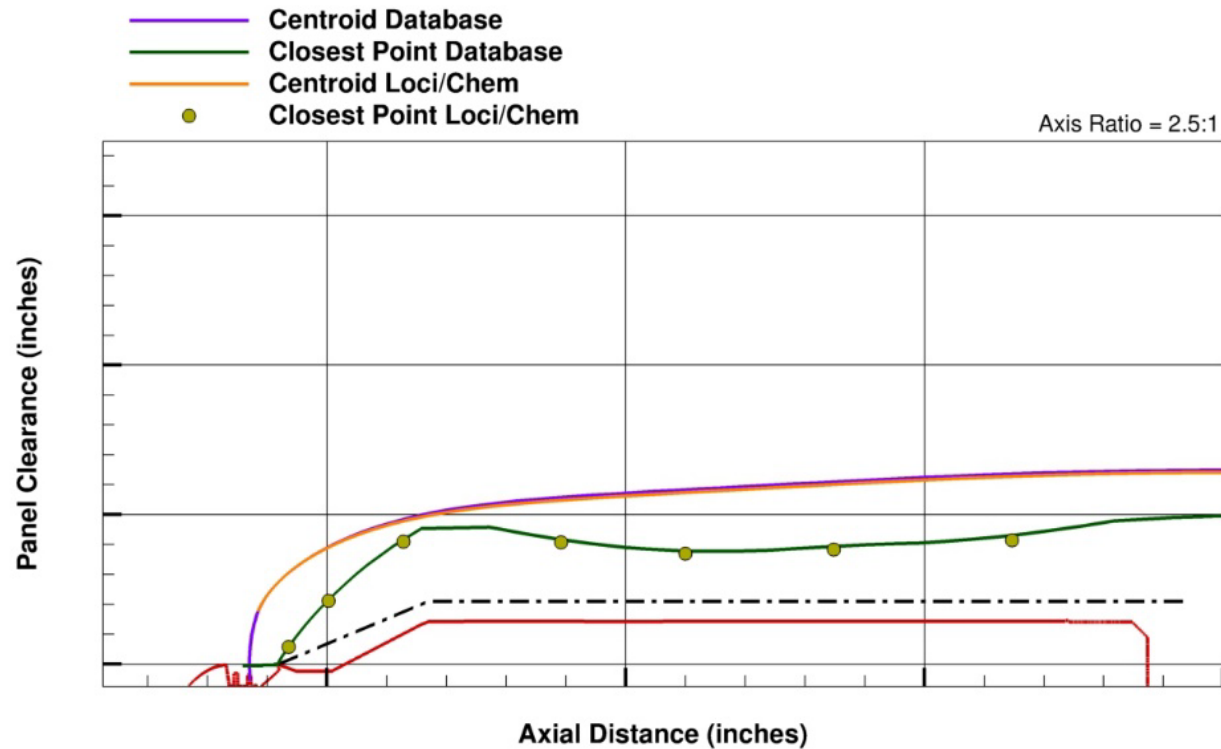

High angle of attack comparison of panel clearance between Loci/Chem time dependent and database/6-DOF simulations

DATABASE COMPARISON TO VISCOUS TIME-ACCURATE FULLY COUPLED 6-DOF

- Comparisons

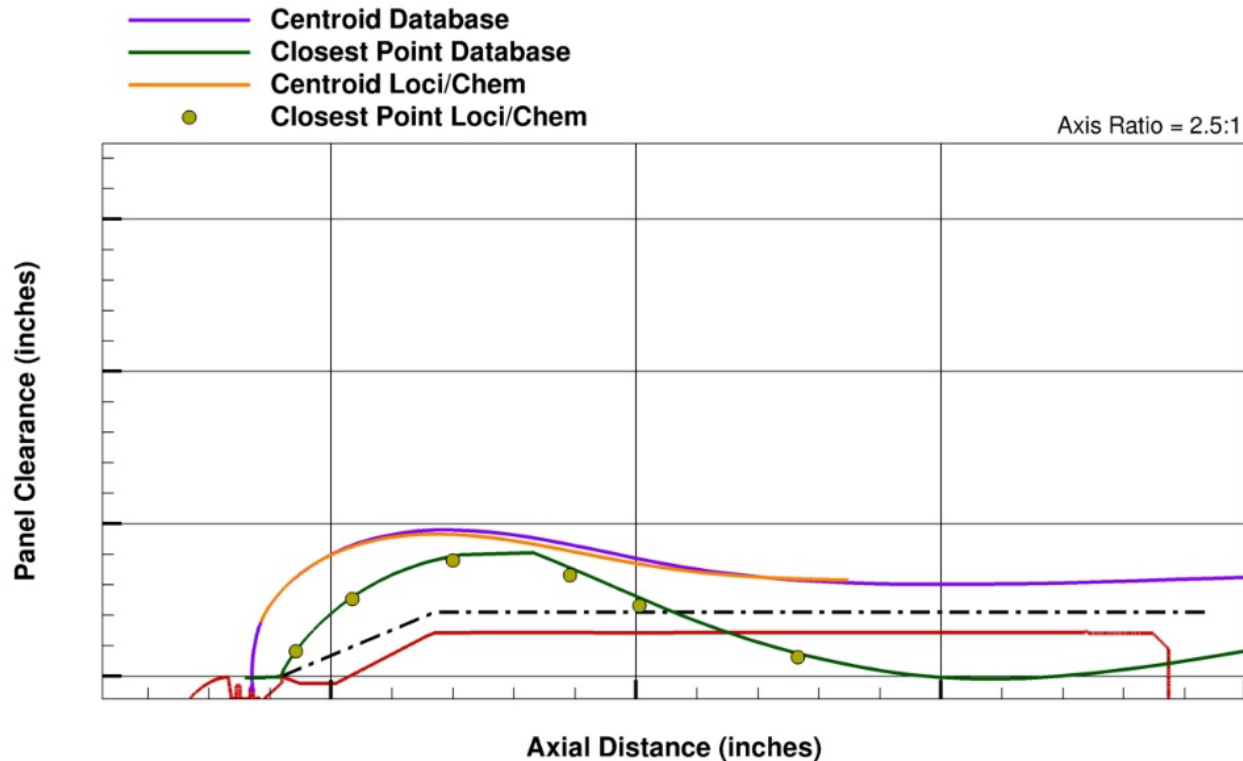

High angle of attack with 3x dynamic pressure comparison of panel clearance between Loci/Chem time dependent and database/6-DOF simulations

STATIC VISCOUS COMPARISONS AND UNCERTAINTY

- Hinged panel comparisons

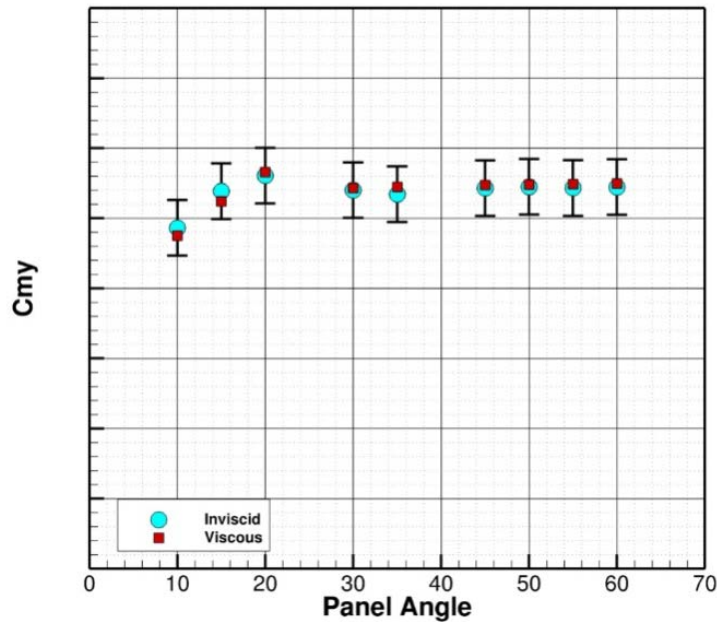

Positive Sideslip (+β)

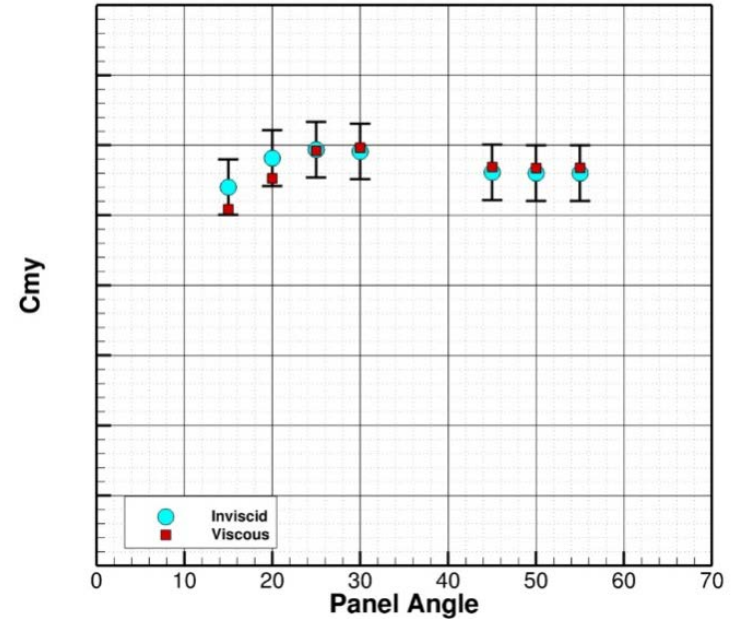

Negative Sideslip (-β)

Hinged regime viscous comparisons and uncertainties for windward panel

STATIC VISCOUS COMPARISONS AND UNCERTAINTY

- Near proximity panel comparisons

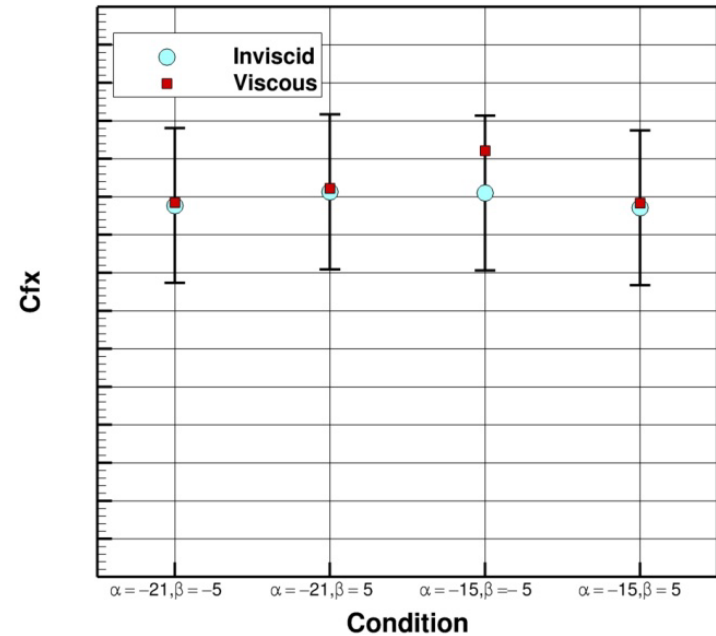
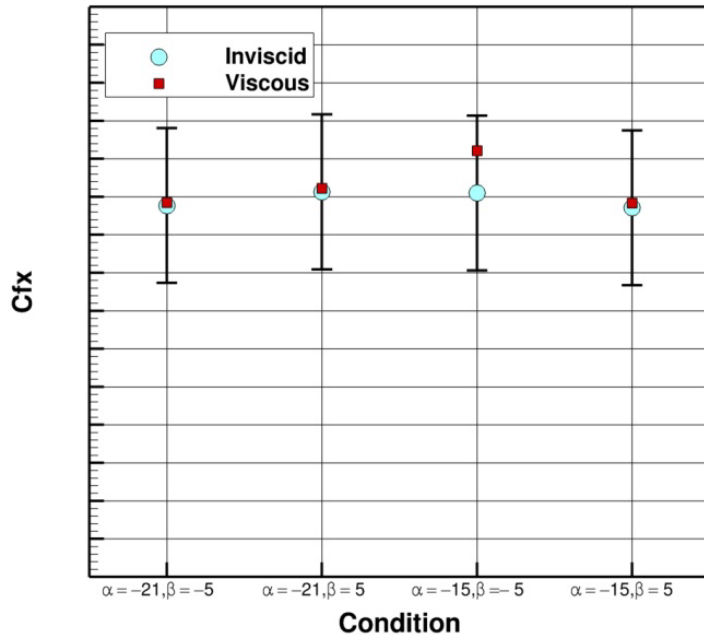

Near regime viscous comparisons and uncertainties for the windward panel at stations S11 with baseline orientation.

STATIC VISCOUS COMPARISONS AND UNCERTAINTY

- Far panel comparisons

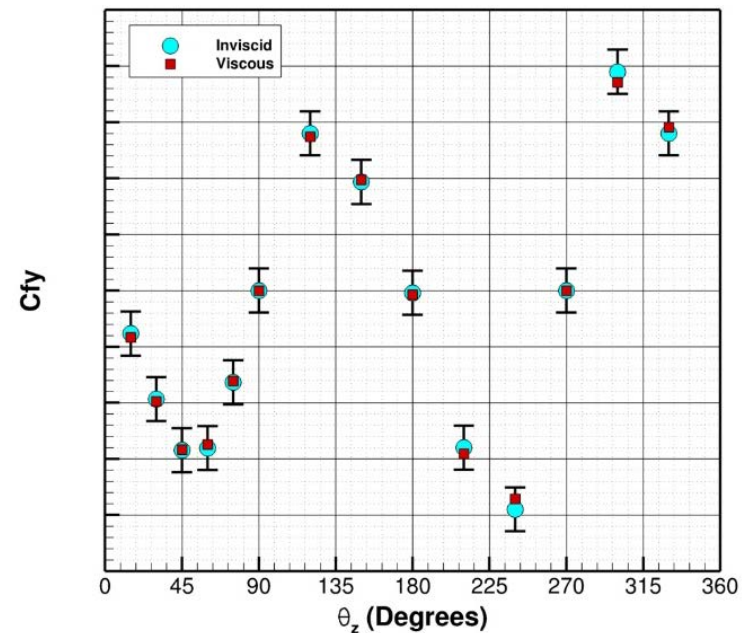
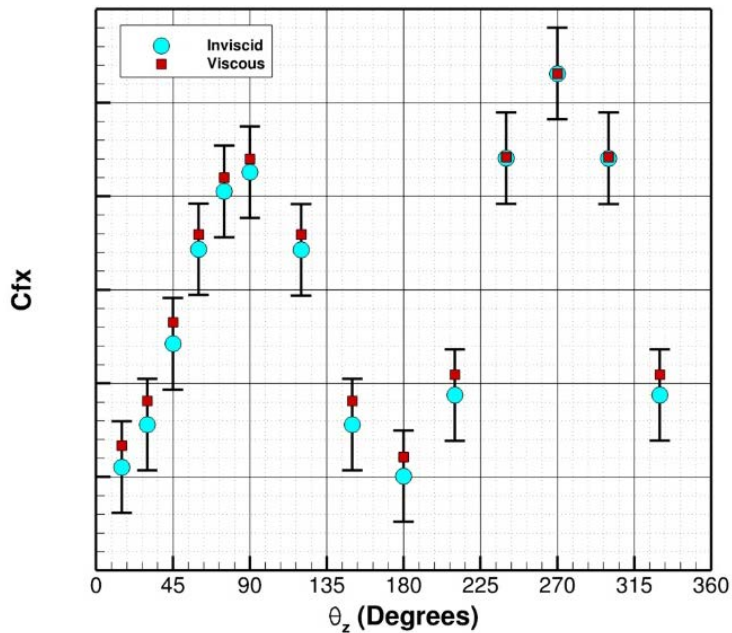

Far regime viscous comparisons and uncertainties versus panel pitch angle.

CONCLUSIONS

- A database for SM panel jettison has been completed, with a total of 7,758 CFD simulations (2,172 hinged, 3,402 near body, 2,184 panel alone). Database due to mirroring of solutions contains 20,574 CFD simulations
- Studies show the effect of the SLS Center Body cannot be neglected in panel trajectory determination
- Upon initiation of the jettison event, the panel rotates about an aft hinge. During this period, the cavity beneath the panel rapidly pressurizes and imparts significant angular momentum to the panel. This effect assists in panel clearance of the Center Body
- There exists a range of altitude (dynamic pressure) for which the cavity pressurization can benefit panel separation and overcome the negative effect of the freestream flow pushing the windward panel back towards the Center Body
- Detailed comparisons between inviscid (Cart3D) and viscous (Loci/CHEM) simulations for all three database zones were performed
- For the hinged portion of the database, results show that inviscid and viscous results compare well after the panel motion is no longer dominated by the force of the spring during initial rotation. All other portions of the database show good agreement between viscous and inviscid solutions

CONCLUSIONS

- The panels have large inertial properties and begin motion from rest relative to the Center Body. As a result, unsteady effects of panel motion are negligible
 - To verify this assumption, a series of time-accurate viscous 6-DOF solutions were obtained with the Loci/Chem solver to assess importance of unsteady effects
 - Results from the time-dependent Loci/Chem simulation agree well with the database/6-DOF approach for all cases examined. These simulations confirm that unsteady effects are negligible and that the sequential-static approach used to create the database coefficients is a valid approach
- High angle of attack cases demonstrate there is ample margin for nominal panel separation event