

**Near-Term Artificial Gravity  
Concepts for Deep Space Missions  
AIAA – SCITECH 2019  
January 8, 2019**

# Allowable Human Tolerance to Rotation

- Previous studies of artificial gravity implementation on human spacecraft have produced large, heavy vehicle concepts.
- These previous concepts were driven primarily by a low rotation rate ( $\sim 4$  rpm) that was considered the human tolerance limit and the need for continuous exposure of the crewmember to artificial gravity.

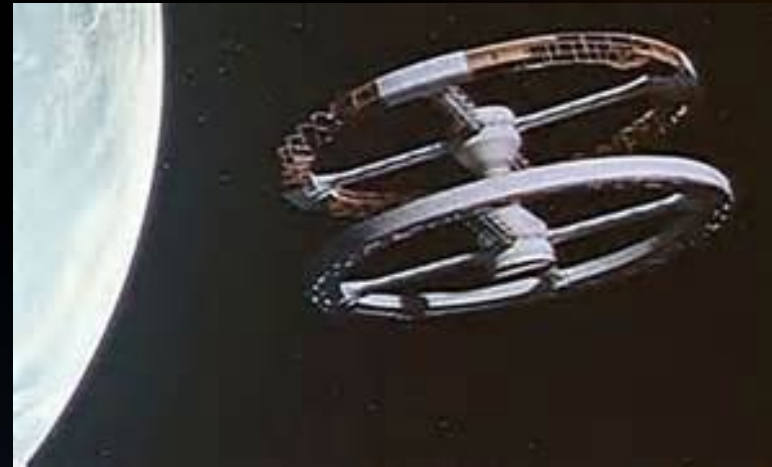
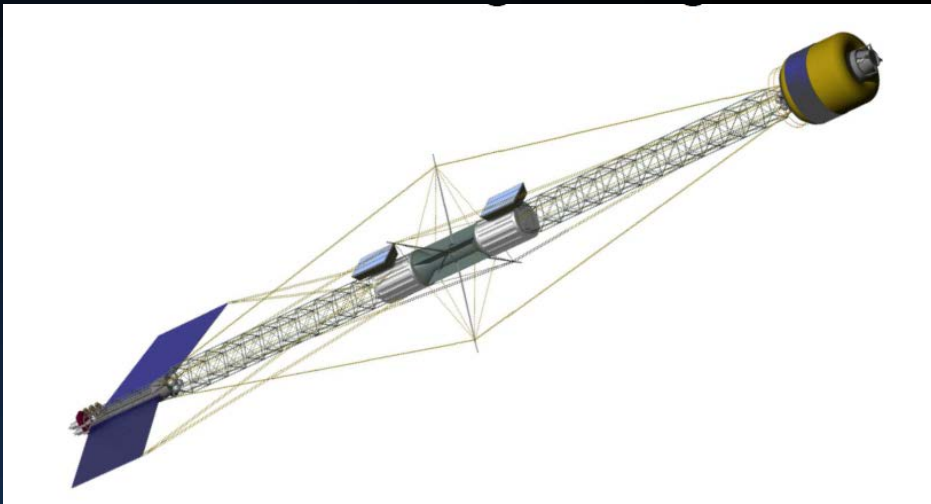

- The NASA Human Research Program (HRP) is formulating a series of experiments to gather more data on the effectiveness of centripetal artificial gravity as an adaptive countermeasure (“Artificial Gravity” in this presentation refers to centripetal force applied to a crewmember) for rotation rates up to 15 rpm.
- If these experiments provide data that support relaxation of the rotational rate constraint as well as other parameters such as the duration a crewmember needs to be exposed to artificial gravity and the allowable acceleration gradient across the body, the vehicle design trade space to implement artificial gravity widens dramatically.



# Allowable Human Tolerance to Rotation

Rotation Rate in rpm vs. Radius at Body CG for 1g at Body c.g.

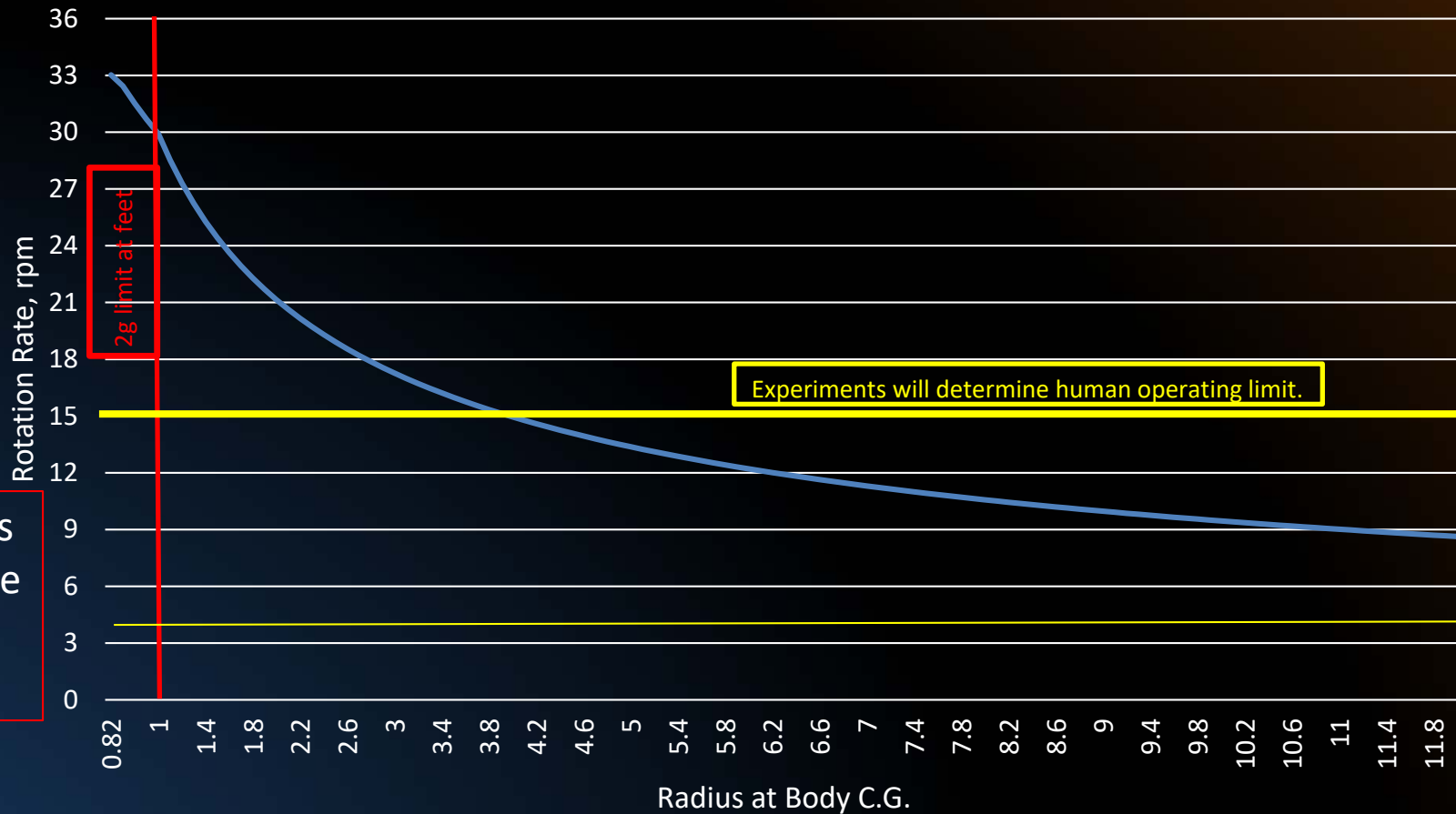

Below 9 rpm it takes a significant increase in radius to reduce the rotation rate.

Increasing the allowable rotation rate significantly reduces the required radius of rotation which makes spacecraft configurations incorporating artificial gravity more feasible.

# Artificial Gravity Concept Feasibility Study

**GOAL:** Based on a set of proposed artificial gravity needs for deep space exploration, develop concepts that show how artificial gravity might be incorporated into a spacecraft in the near term (i.e. ten years)

**DRIVERS:** To be effective, accelerations produced by an artificial gravity system must be directed through the feet.

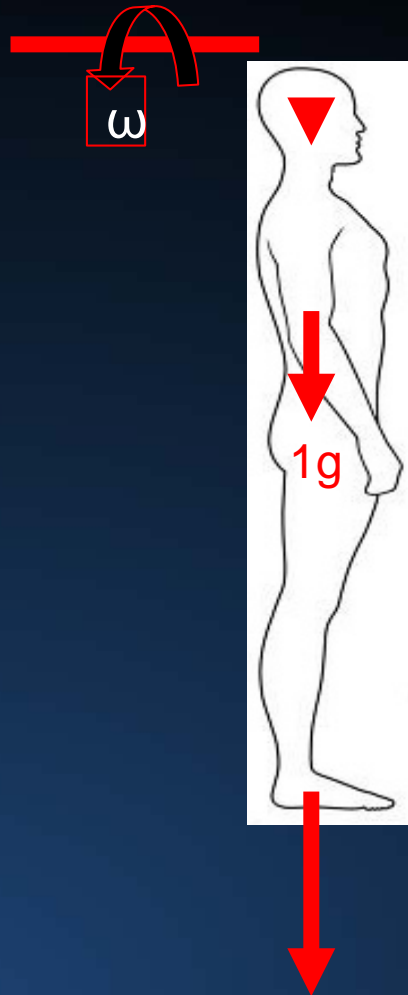

The artificial gravity system must produce 1g acceleration at the body c.g.

The gradient of the induced acceleration from head-to-toe should be minimized.

The duration of artificial gravity exposure is assumed to be no greater than 1.5 hours/day per crewmember. This includes activation and deactivation of hardware.

Angular motion of the head that is not parallel to the spin axis will cause cross-coupled angular accelerations which can result in disorientation.

Adaptation to artificial gravity could be accomplished by slowly increasing the levels that the subject is exposed to over time.

The acceleration at the feet must be less than 2 g's.

Exercise or other crew activities are not required to be performed during the Artificial Gravity exposure period.

# Artificial Gravity Concept Feasibility Study

Gradient across body vs Radius to body c.g. for 1g at body c.g.

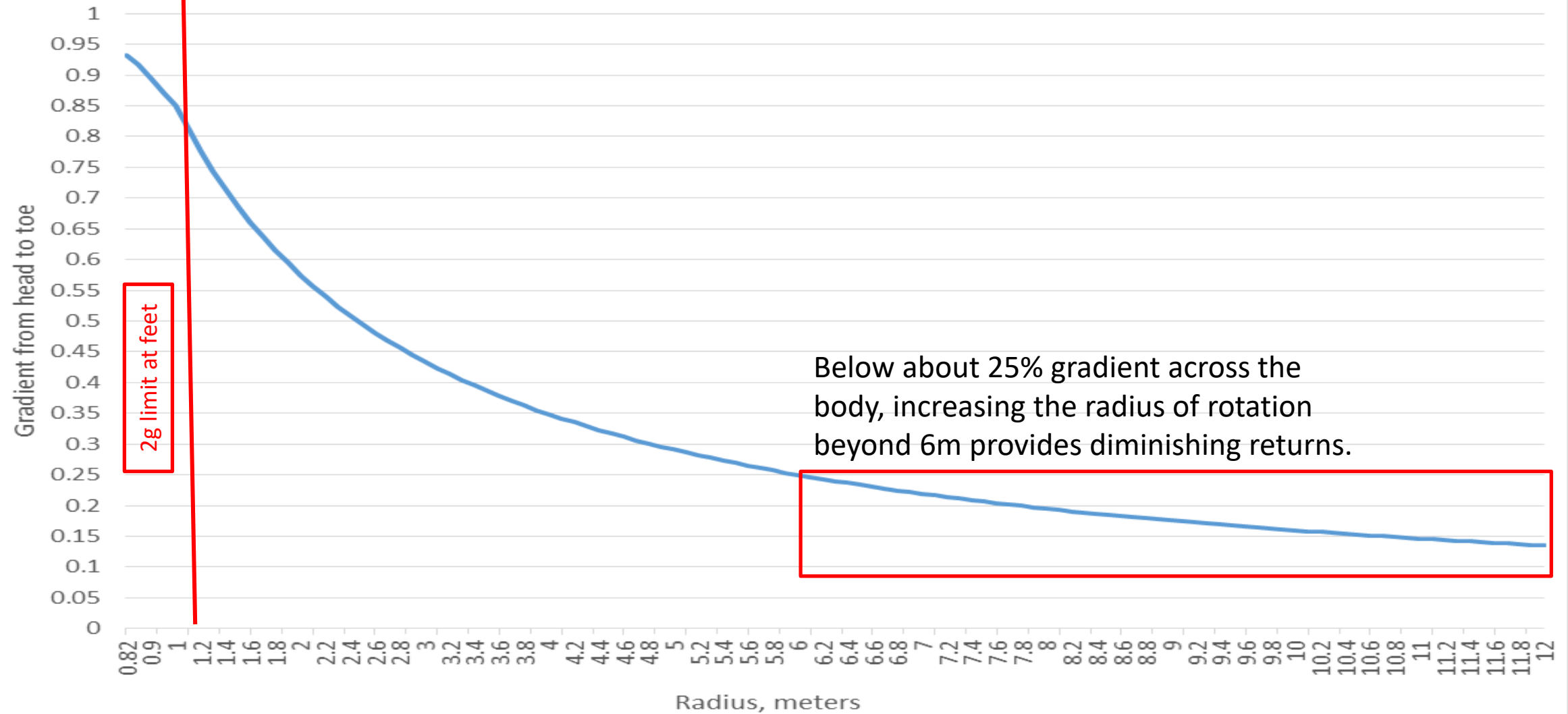

# Artificial Gravity Concept Feasibility Study

g's at the head and feet vs radius to the body c.g. for 1g at the body c.g.

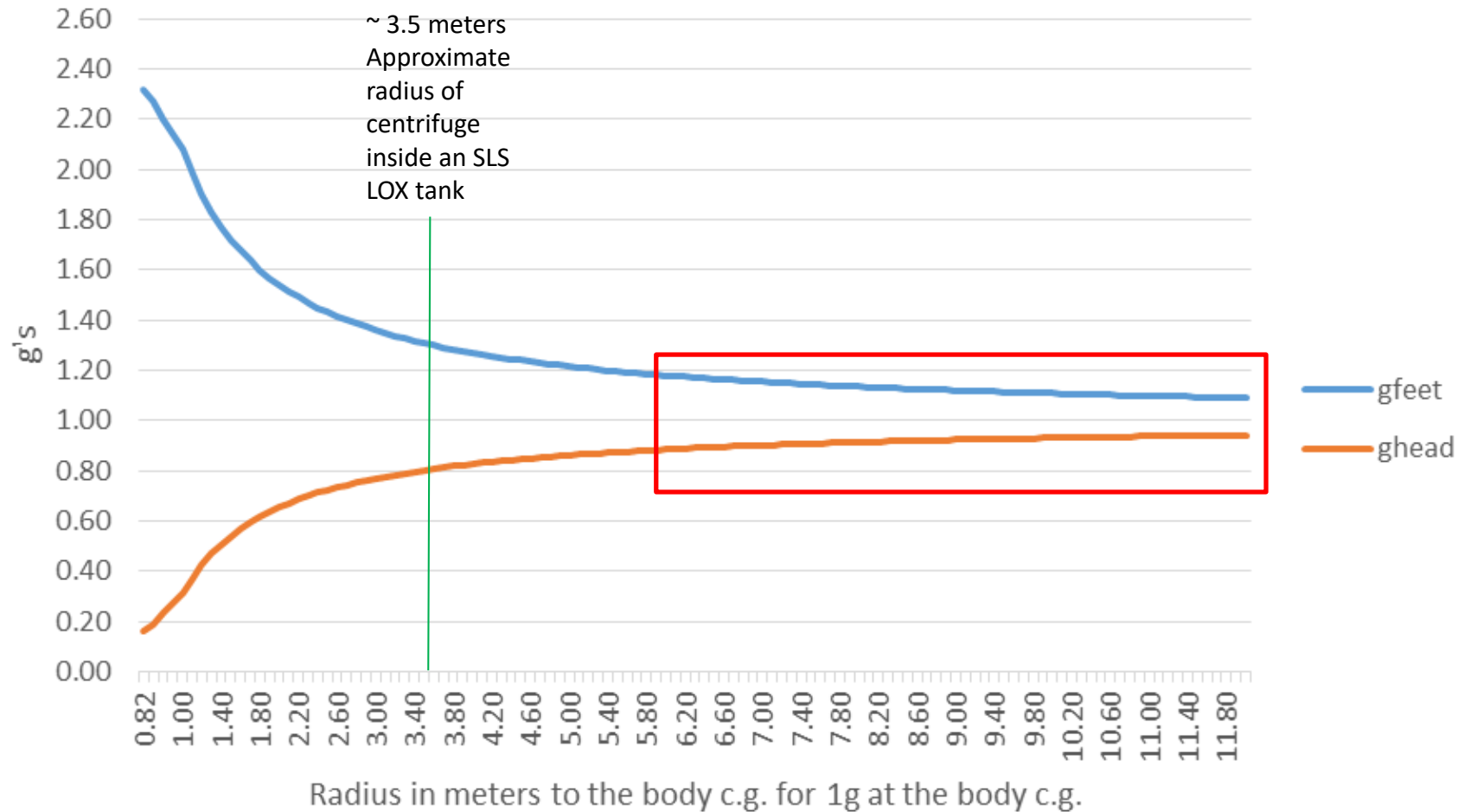

- If it is possible to reduce the rotation radius to the minimum required to satisfy both human health and human performance requirements, artificial gravity implementation in a spacecraft becomes less costly and complex.
- These graphs indicate that a very large centrifuge (greater than 6.0 meters radius) is not required to provide 25% gradient across the body.
- At 6.0 meter radius the g-levels are approximately 1.18 g's at the feet and 0.89 g's at the head for 1g at the body center-of-gravity.



# Artificial Gravity Concept Feasibility Study

## Other Concepts Considered:

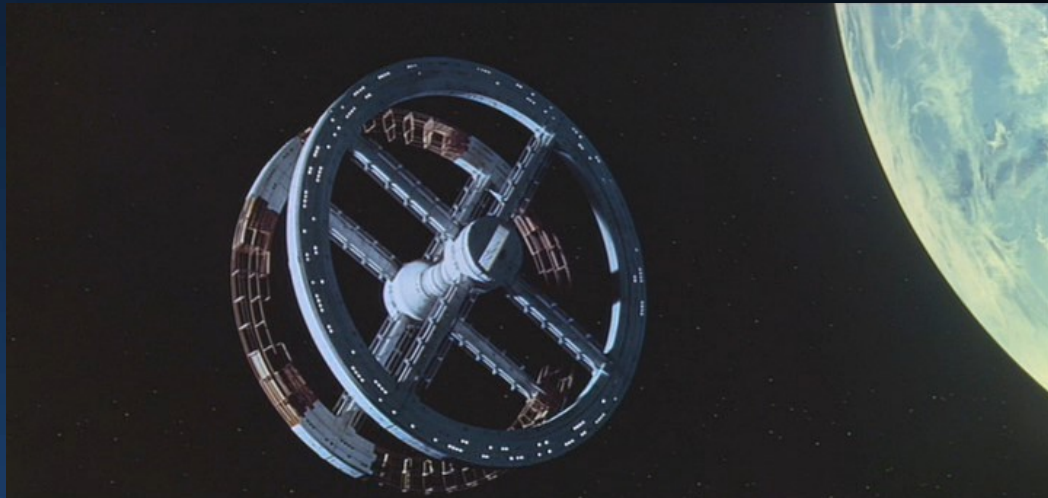
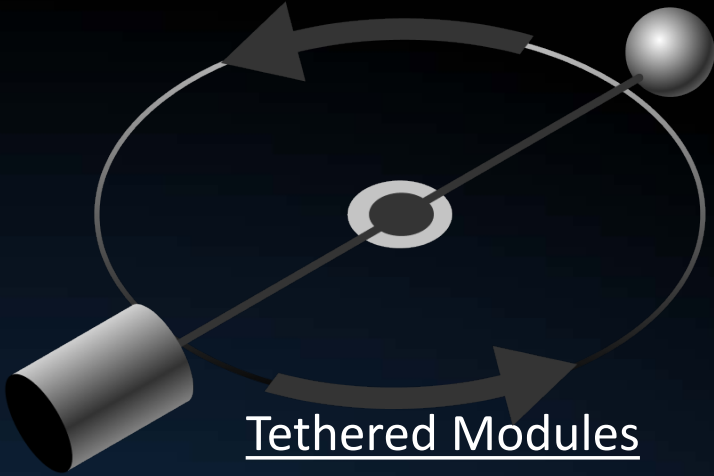



# Artificial Gravity Concept Feasibility Study

The team initially looked at the design drivers when considering both rigid and inflatable pressurized structures to incorporate an artificial gravity system. These design drivers include:

- The internal diameter of the pressure shell.
- The volume limitations inside the shroud of the launch vehicle.
- The lift capability of the launch vehicle.
- The need to isolate the artificial gravity system from other parts of the vehicle to avoid excessive vibration.
- The potential for a testbed to be incorporated into ISS.
- The extensibility of this concept across multiple human spacecraft.
- The angular velocity required to achieve the required acceleration at the body c.g.

This feasibility study assessed artificial gravity implementations for both rotating a human inside a pressurized element or rotating an entire transiting spacecraft.

The concepts are also intended to demonstrate that an artificial gravity implementation as part of a spacecraft appears feasible in the near-term (i.e. within ten years).



# Artificial Gravity Concept Feasibility Study

- Launch Vehicle Payload Envelope and Mass Constraints:

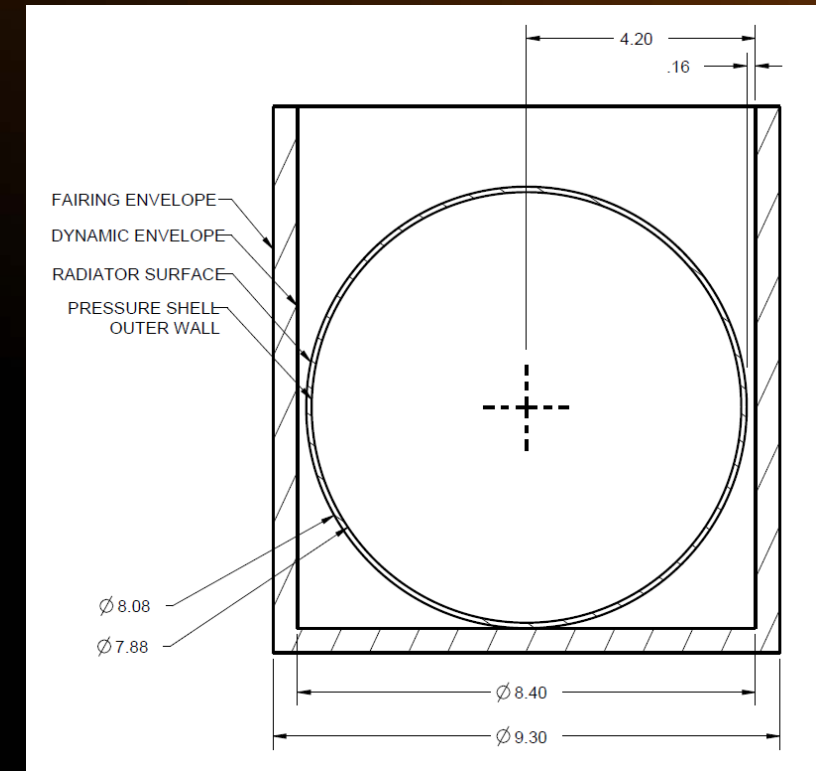
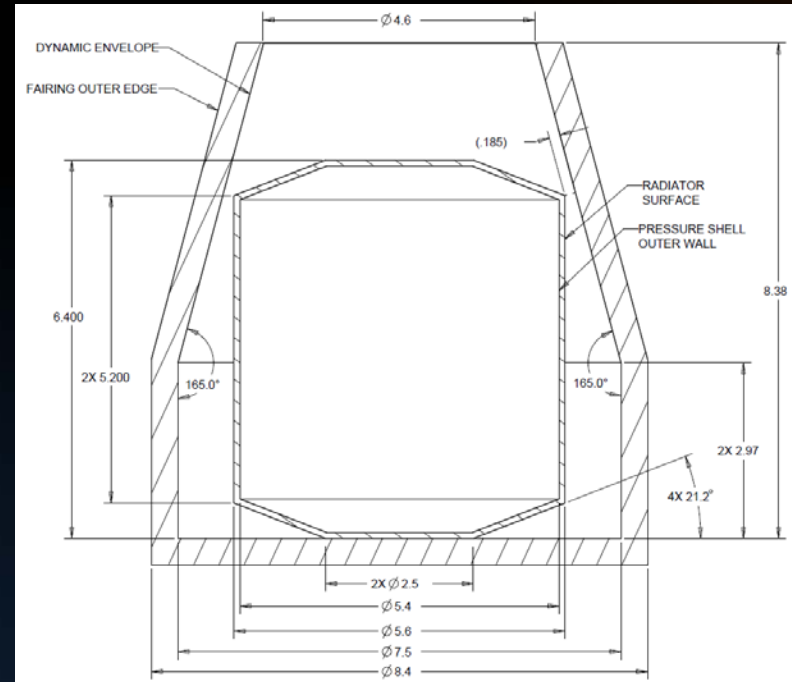
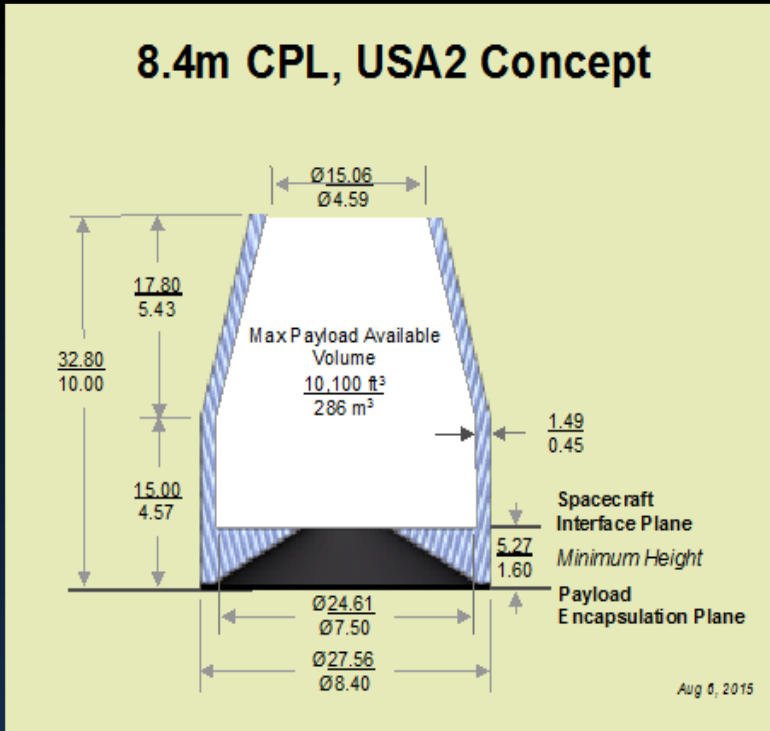

- Available Payload Dynamic Envelope
  - Fairing Envelope (ultrasonic attenuation)
  - Minimum Payload Attach Filing Envelope
- All dimensions in Feet  
m
  - Height of the spacecraft separation interface plane depends on spacecraft/RFI attach diameter and RFI cone angle
  - Spacecraft appendages projecting below spacecraft interface plane may be permitted; coordinate with SLS/SPE

- The currently proposed payload envelopes for the Space Launch System impose constraints on the diameter of a rigid module.
- The payload mass is also limited to about 20t to Cis-Lunar space for a dedicated SLS cargo flight.
  - An SLS cargo flight to Low-Earth Orbit would allow for greater mass, but the payload envelope constraint would remain.

# Artificial Gravity Concept Feasibility Study

Notional view of SLS LOX tank-derived module integrated to a launch vehicle.



# Artificial Gravity concepts assessed for SLS LOX Tank

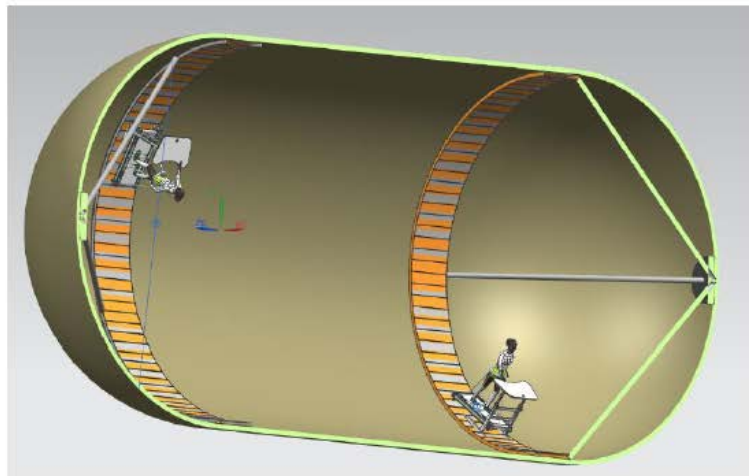

(a) Counter-rotating treadmills and subjects

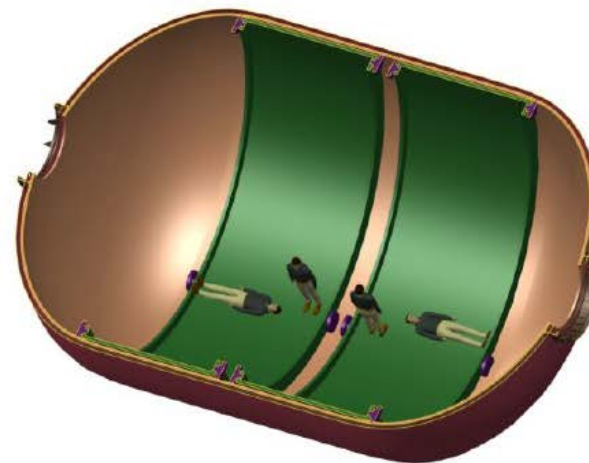

(b) Counter-rotating tracks or sections

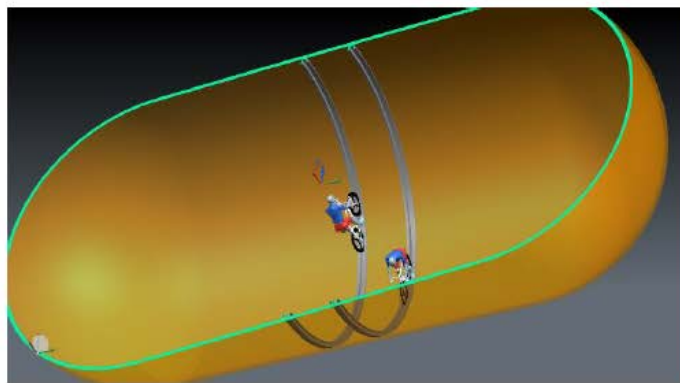

(c) Cycle ergometer with counter-rotation

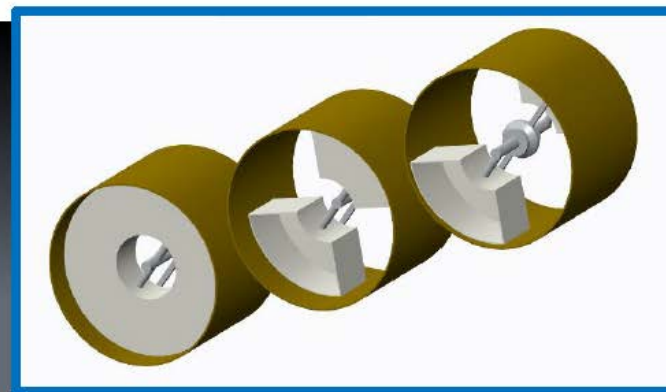

(d) Enclosed track or gondolas

Figure 3 – Three 8-m diameter artificial gravity centrifuge concepts inside an SLS LOX-tank



# Artificial Gravity Research Module, 2 Barrel Sections

SLS-launched and attached to an orbiting vehicle

Structure  
Derived From  
SLS Core Stage  
Standard LOX  
Tank;  
Two Barrel  
Sections,  
24,150 lbs.  
(12.1 t)

Mating  
System

Exercise Research  
Area

Sleep Research  
Area

CCW Hamster  
Wheel,  
Shown At  
120" Wide, Each

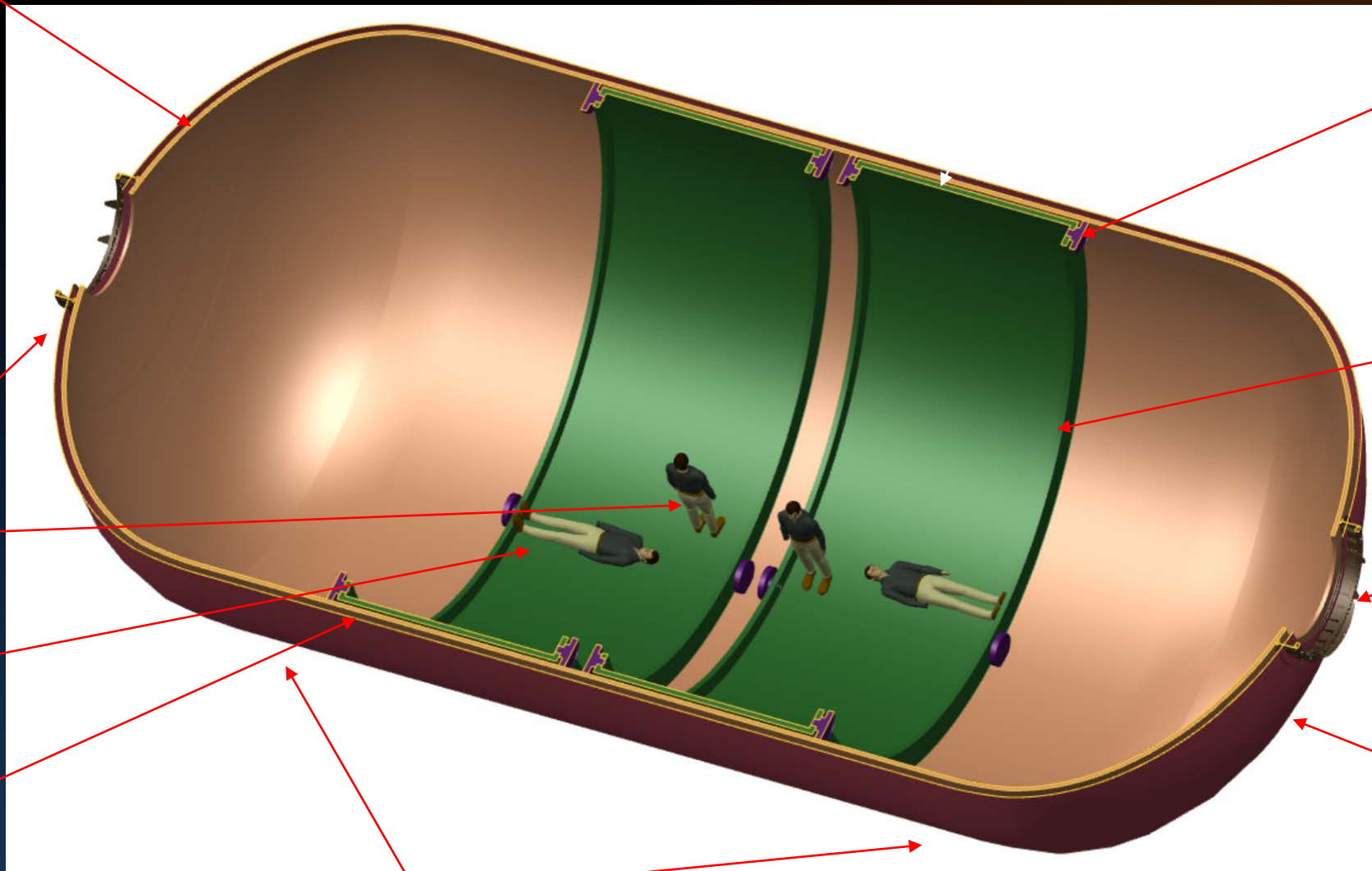

Peripherally-  
Supported  
Hamster Wheel  
Bearings

8m  $\varnothing$   
Track ID  
Surface

Mating System

ISS-Derived  
MM/OD Shield  
341" (8.66m)  $\varnothing$  OD

Cylindrical Length = 406"

# Artificial Gravity Research Module, 1 Barrel Section

SLS-launched and attached to an orbiting vehicle

Structure Derived From  
SLS Core Stage LOX Tank;  
Single Barrel Section,  
16,550 lbs. (8.3 t)

Mating  
System

Exercise Research Area

Sleep Research Area

CCW Hamster Wheel,  
Shown At 120" Wide, Each

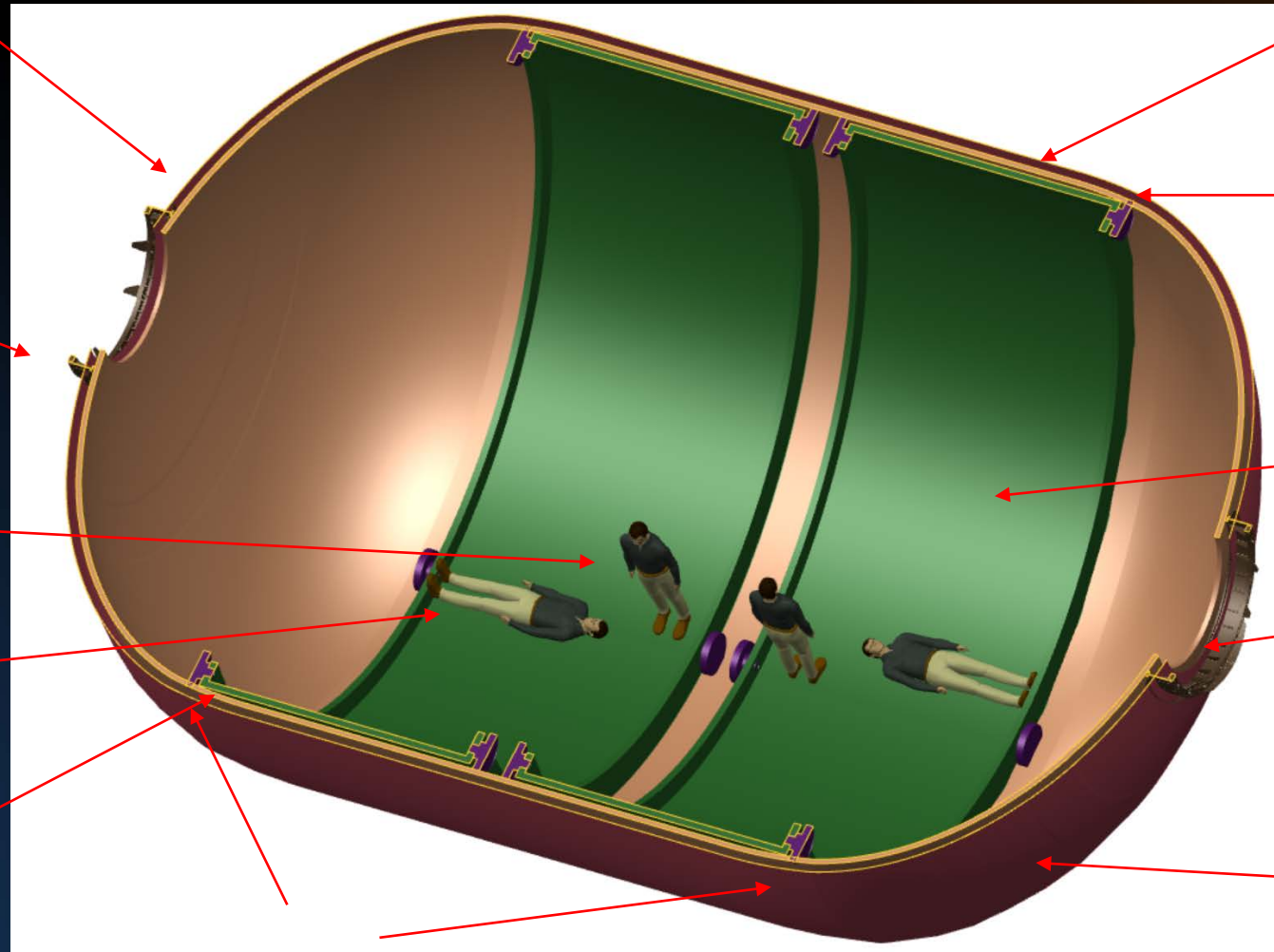

CW Hamster Wheel

Peripherally-Supported  
Hamster Wheel Bearings

8m  $\varnothing$  Track ID Surface

Mating System

ISS-Derived MMOD Shield,  
341" (8.66m)  $\varnothing$  OD

Cylindrical Length = 215"

# Artificial Gravity Research Module, 0 Barrel Sections

SLS-launched and attached to an orbiting vehicle

Structure Derived From  
SLS Core Stage LOX Tank;  
No Barrel Sections,  
8,950 lbs. (4.5 t)

Mating System

Exercise Research  
Area Only

Single Hamster Wheel,  
Shown At 40" Wide

End Domes Only,  
No Cylindrical Section

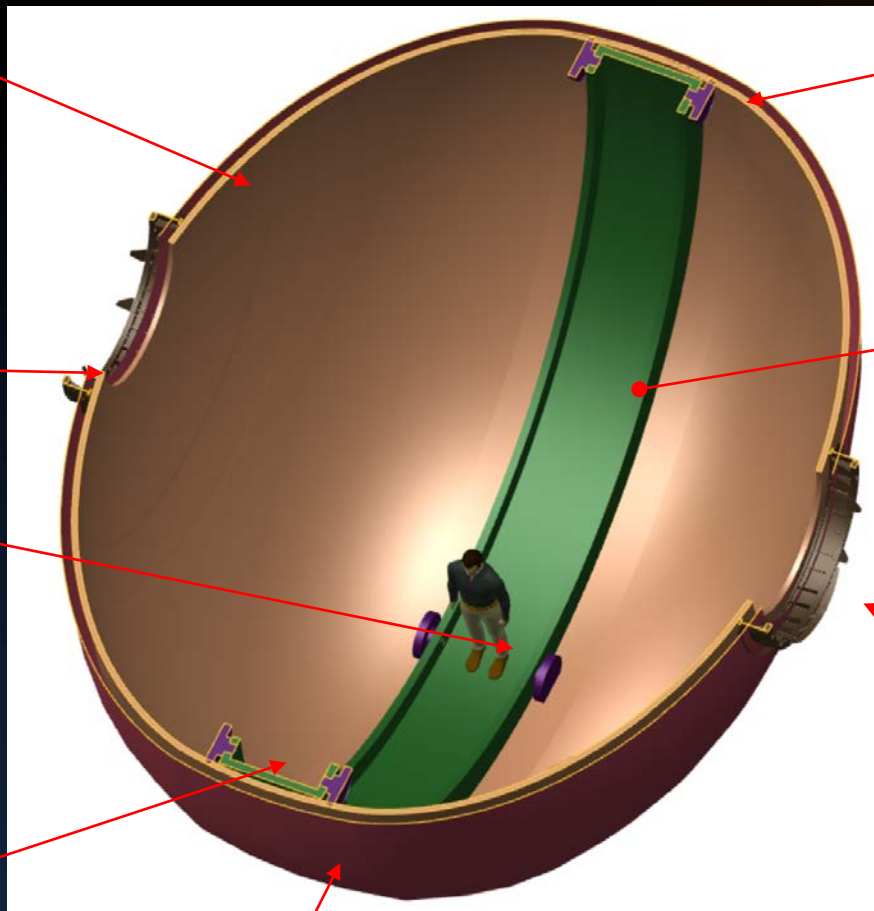

Peripherally Supported  
Hamster Wheel Bearings

8m  $\varnothing$  Track ID  
Surface

Mating System

ISS-Derived MMOD Shield,  
341" (8.66m)  $\varnothing$  OD



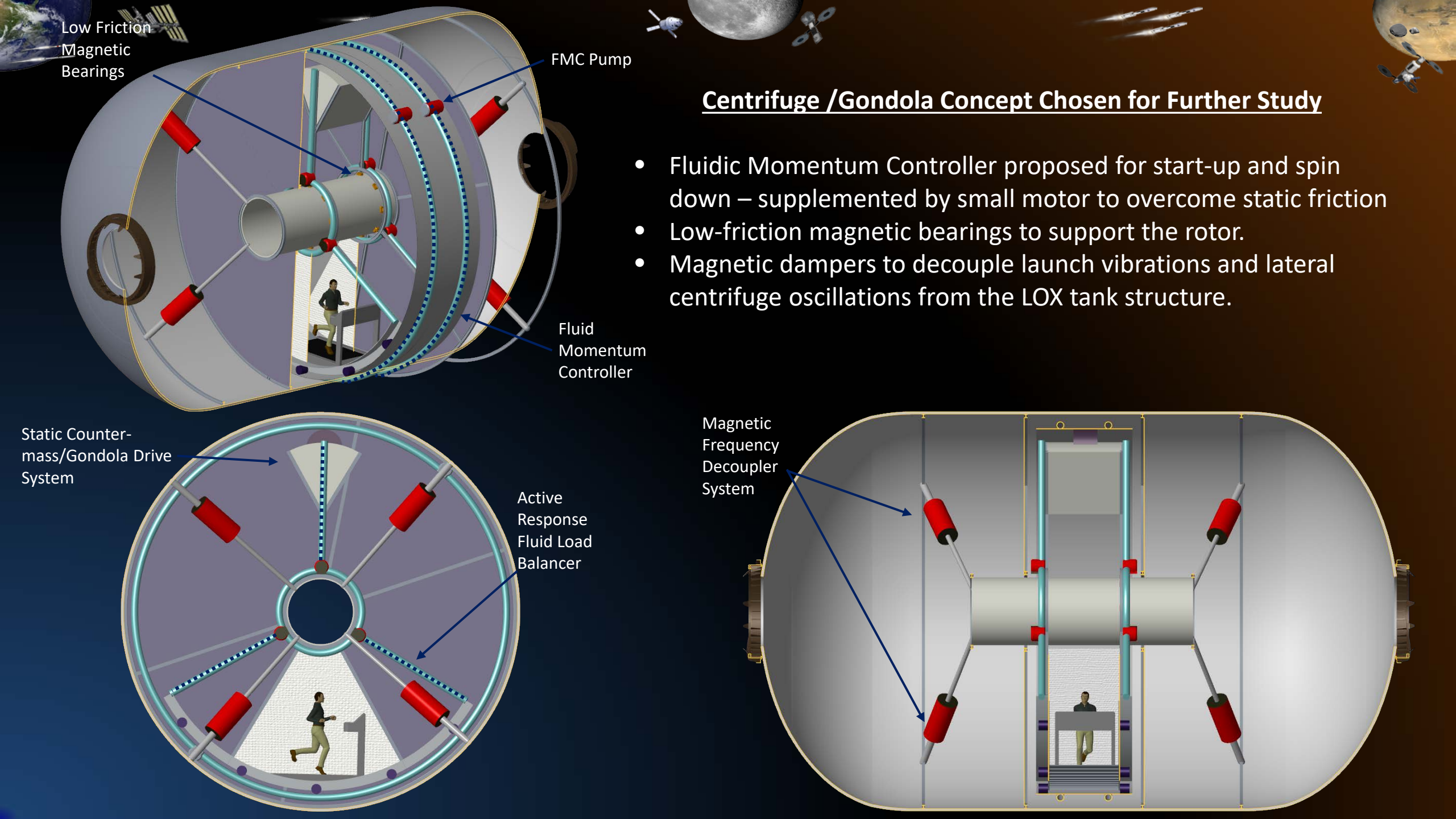

## Centrifuge /Gondola Concept Chosen for Further Study

- Fluidic Momentum Controller proposed for start-up and spin down – supplemented by small motor to overcome static friction
- Low-friction magnetic bearings to support the rotor.
- Magnetic dampers to decouple launch vibrations and lateral centrifuge oscillations from the LOX tank structure.

# Animations of Treadmill integrated with a Gondola

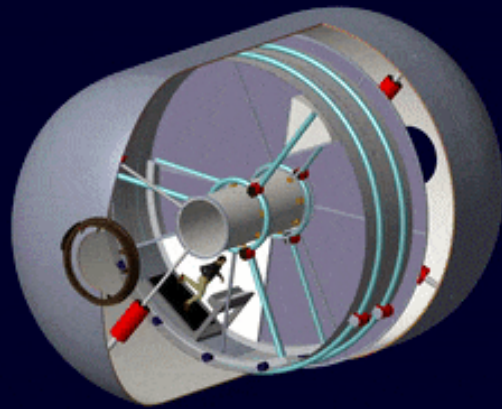

Simulates the Fluid Momentum Controller spinning up separately from the gondola and then acting as a drive reaction to the gondola drive system.

This concept has been submitted to the NASA Innovative Advanced Concept (NIAC) Program for 2019.

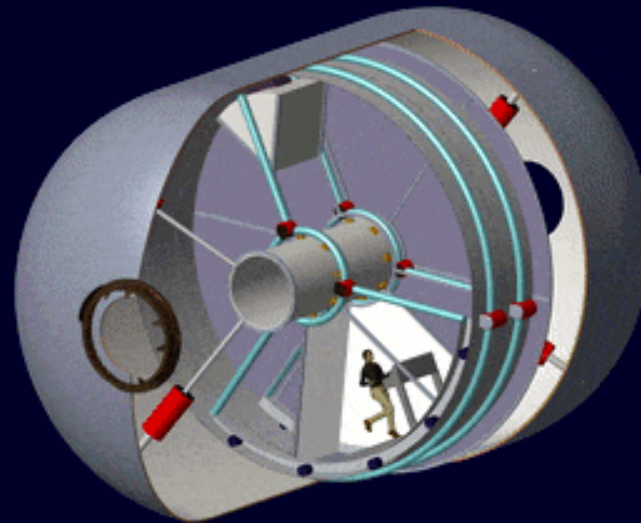

Simulates the Fluid Momentum Controller spinning up attached to the gondola and then decoupling in the event of an emergency stop.

# Artificial Gravity Concept Feasibility Study

Notional view of an SLS LOX tank attached to Node 1 Nadir

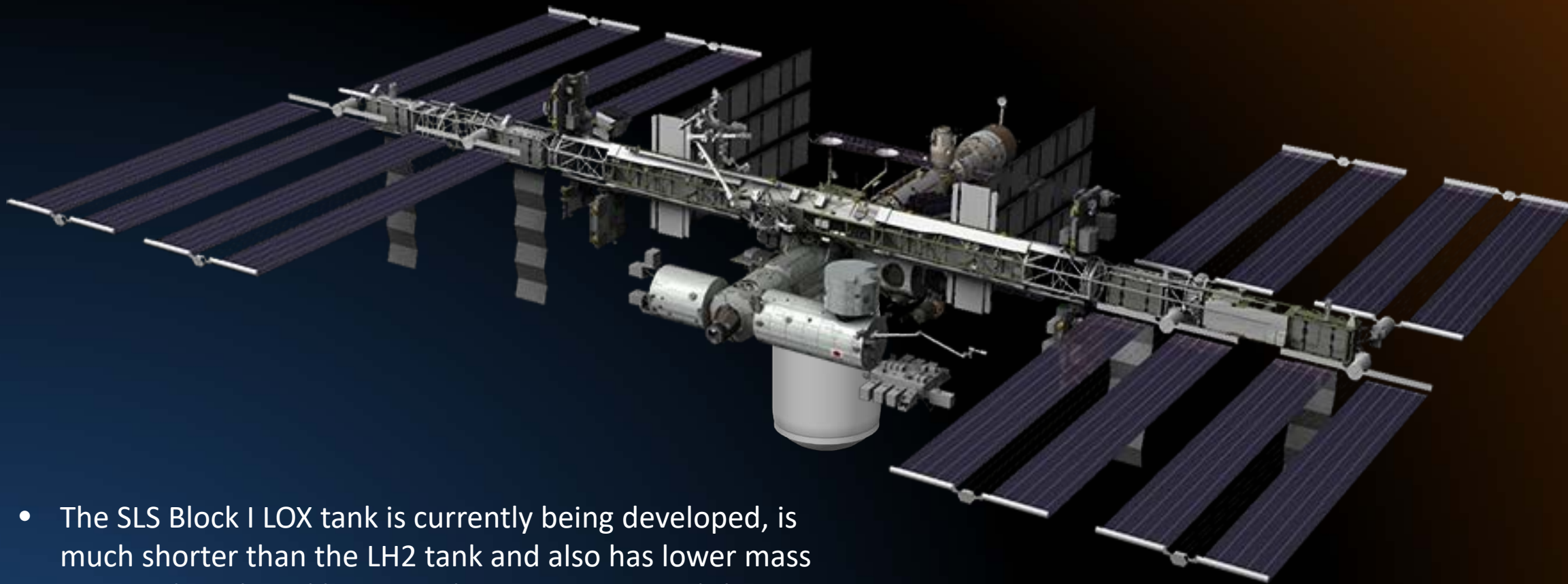

- The SLS Block I LOX tank is currently being developed, is much shorter than the LH2 tank and also has lower mass per unit length and less complexity, so it seemed the most applicable starting point.



# Artificial Gravity Concept Feasibility Study

- Notional view of SLS LOX tank attached to Orion.
- If an artificial gravity exposure period of approximately 21 days can provide meaningful data, perhaps an SLS LOX tank/Orion spacecraft combination could be used as a prototype demonstrator.



## Other studies:

- AIAA 2013-5433 “Internal Layout for a Cis-Lunar Habitat” studied the use of an SLS upper stage hydrogen tank as a habitat.

# Artificial Gravity Concept Feasibility Study

## Example ISS Frequency Interactions:

### Frequency Ranges of Interest

4rpm = .07 Hz

12rpm = .20 Hz

15rpm = .25 Hz

Stride Frequency (lower) = 3.90 Hz

Stride Frequency (upper) = 5.30 Hz

**Interpretation:**  
Highly likely that an AG system can find an operating frequency to reduce structural interaction although isolation would likely still be required.

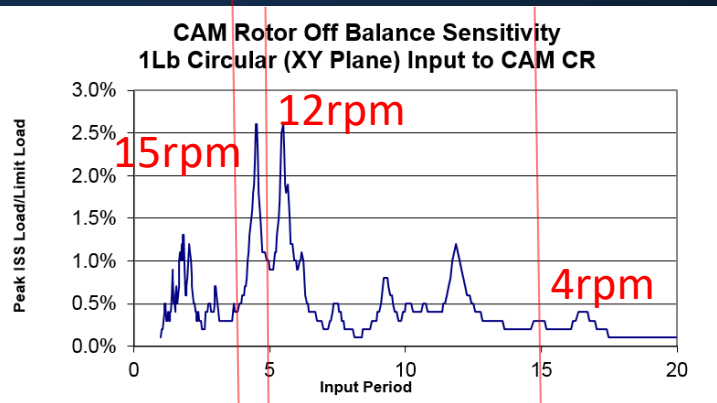
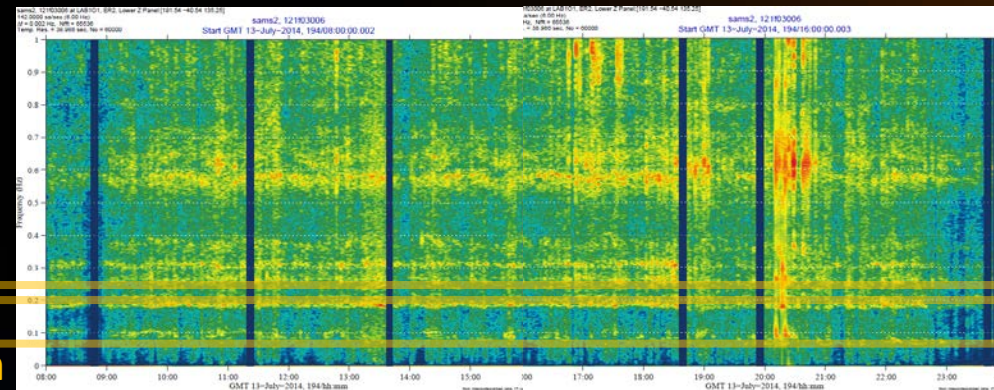
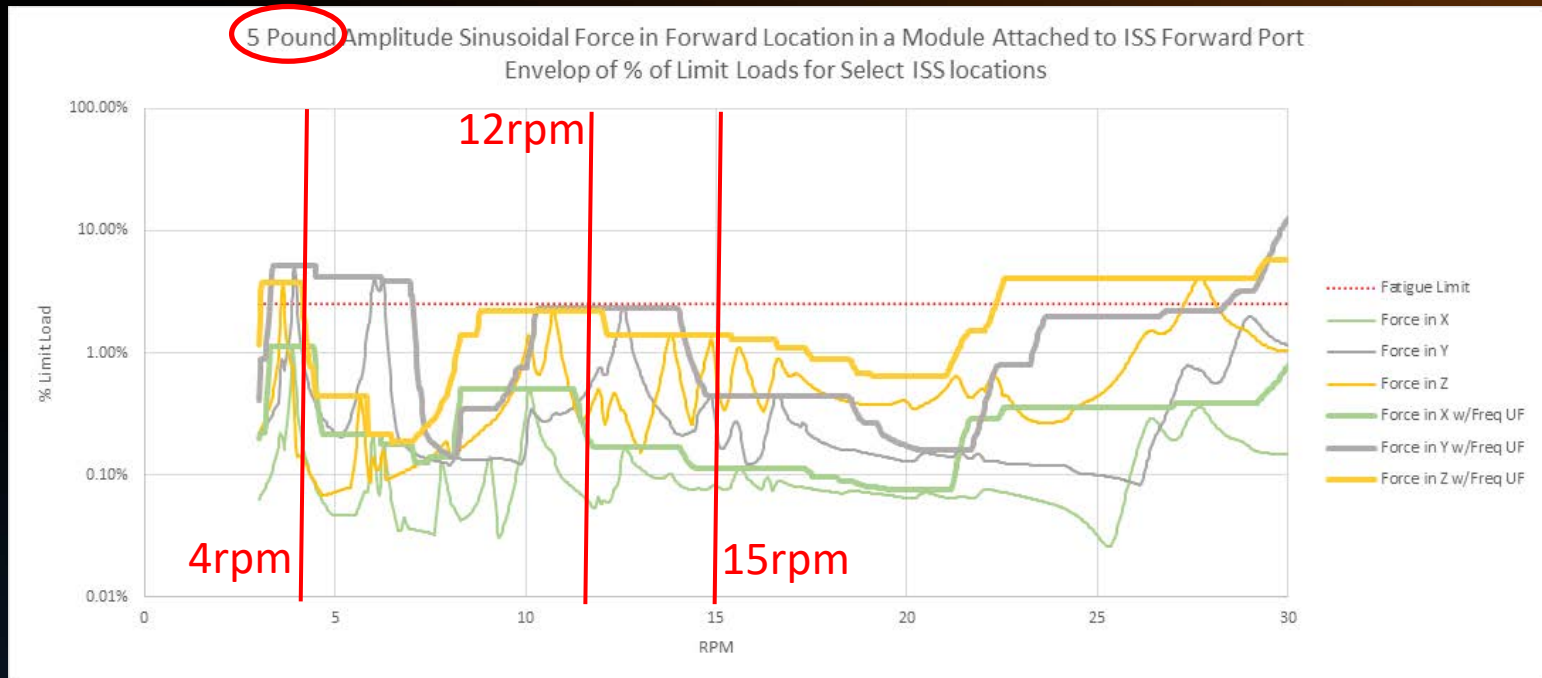

**Note:**  
Actual ISS frequencies and sensitivities are dependent on configuration and disturbance location.

# Artificial Gravity Concept Feasibility Study

## Example: ISS Sudden Stop Sensitivity:

### Frequency Ranges of Interest

4rpm = .07 Hz

12rpm = .20 Hz

15rpm = .25 Hz

Stride Frequency (lower) = 3.90 Hz

Stride Frequency (upper) = 5.30 Hz

### Note:

Actual ISS frequencies and sensitivities are dependent on configuration and disturbance location.

### Interpretation:

It is highly likely that an AG system undergoing a sudden stop could adversely affect ISS without mitigation.

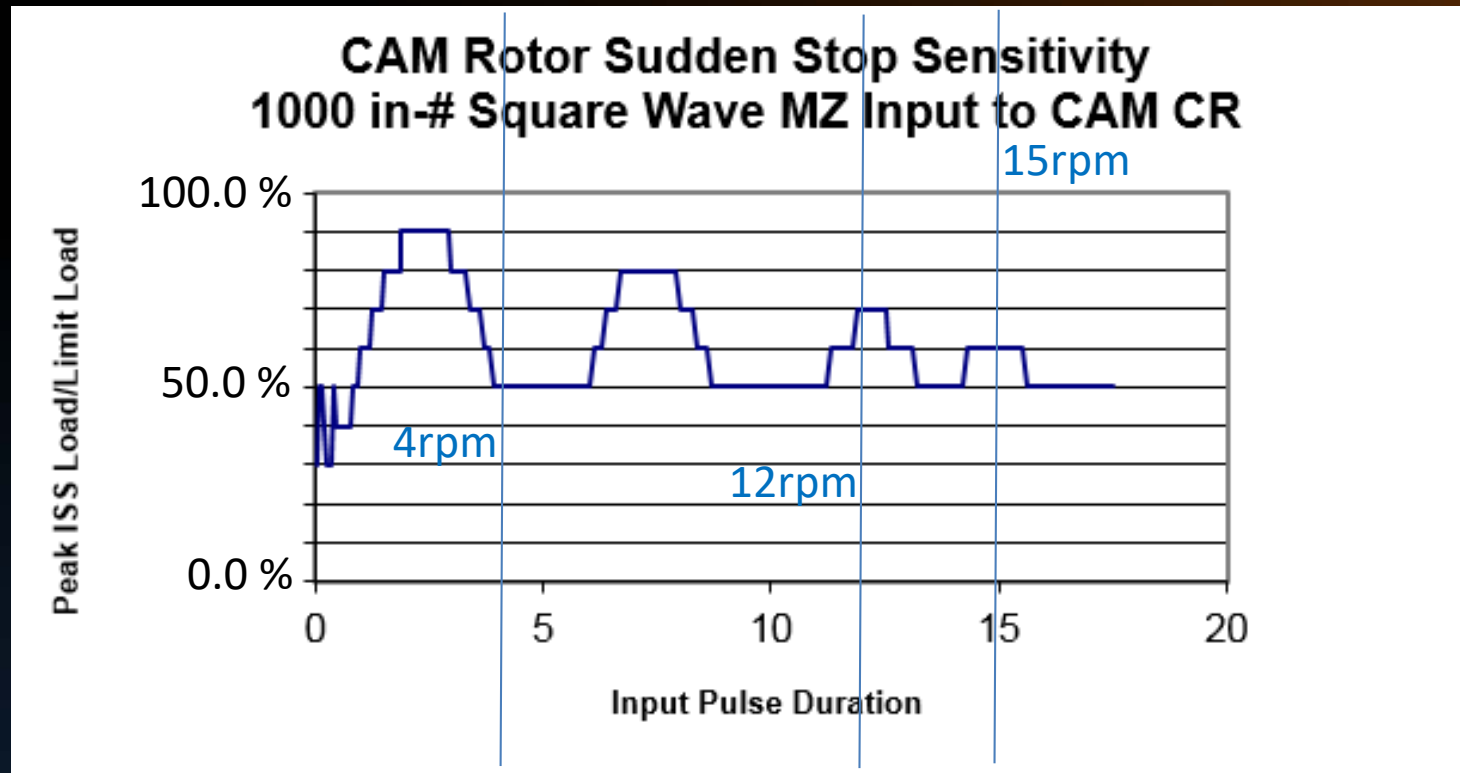

1000 in-lb torque for 150lb person at 4m radius rotating at  $\omega$ Hz and stopping in  $t$  seconds:

$$1000 \text{ (in-lb)} = (150\text{lb}/386 \text{ in/s}^2) * (4\text{m} * 39.37\text{in/m})^2 * (2 * \pi * \Delta\omega / \Delta t)$$



# Artificial Gravity Concept Feasibility Study

- Inflatable structures can provide greater volume than can be packaged in a launch shroud.
- The density of these structures is the limiting factor in what can be launched.
- Transhab was a Mars-class inflatable intended as a deep-space habitat. Its density was 39 kg/m<sup>3</sup>.
- BEAM is a prototype ISS module launched to Low Earth Orbit. Its density is 88 kg/m<sup>3</sup>.
- The radius calculations are based on a 20t limit payload to cis-lunar space.

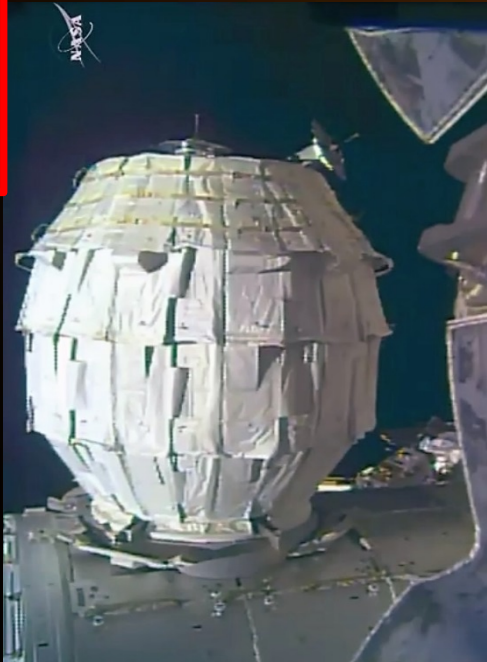
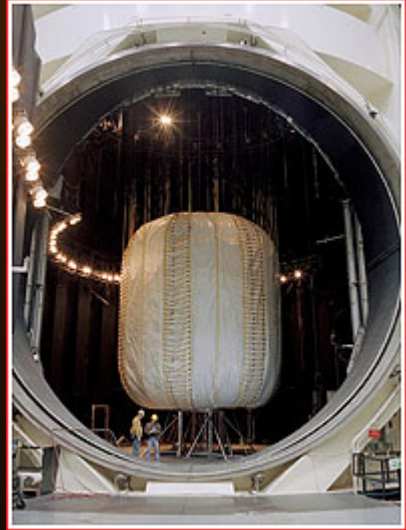

Cylinder Radius vs. Density for 5m height

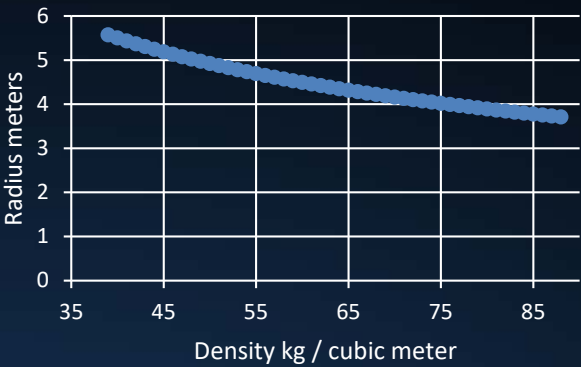

Radius vs. Density for a 4m Tall Cylindrical Habitat

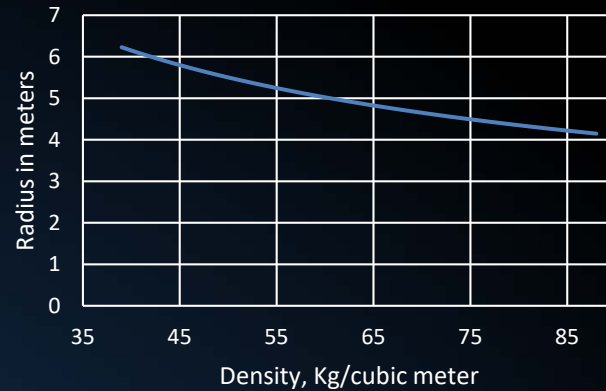

Module radius vs. density for 3m tall cylinder

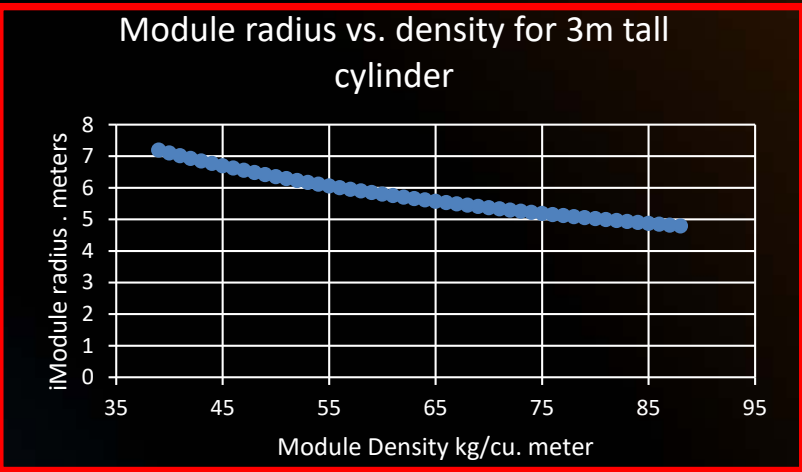

Sphere Density vs. Radius

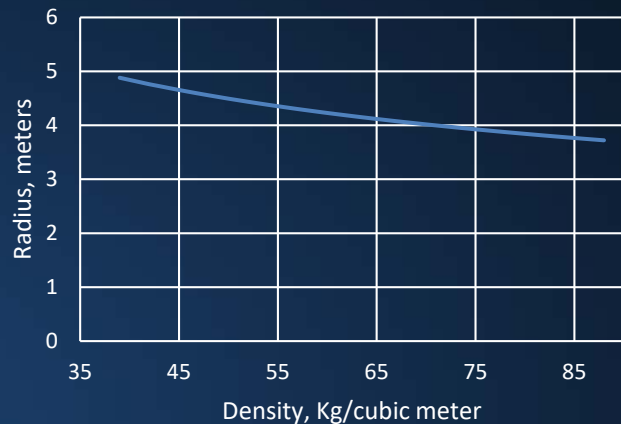

Toroid floor to floor diameter vs Volume - 2m radius

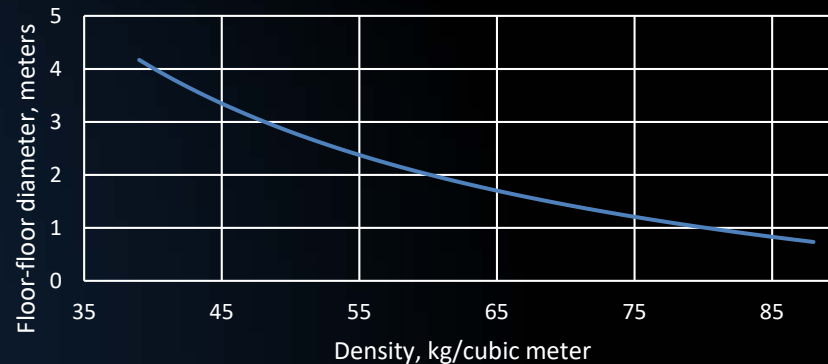

# Artificial Gravity Concept Feasibility Study

Beyond ~3.5 m radius of rotation, an inflatable structure will be required for a standalone module.

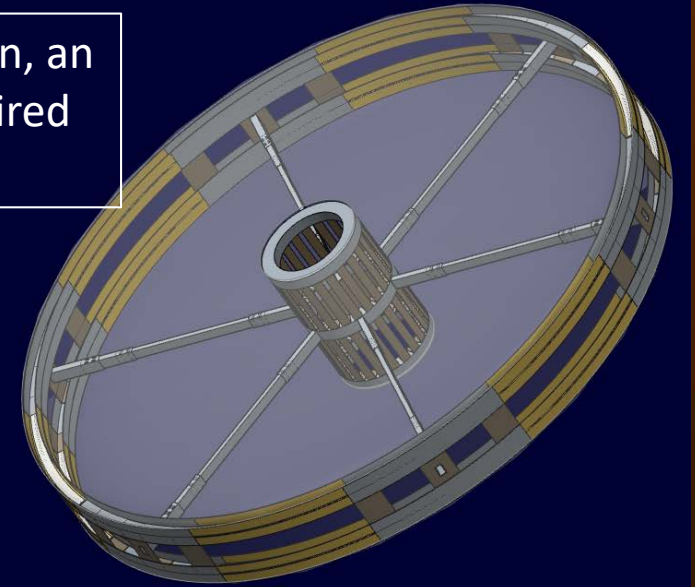
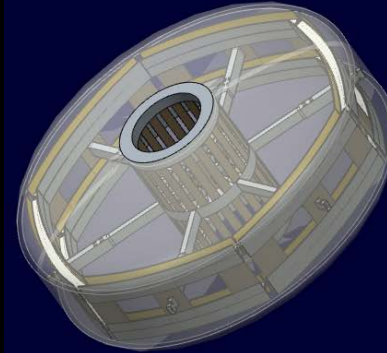
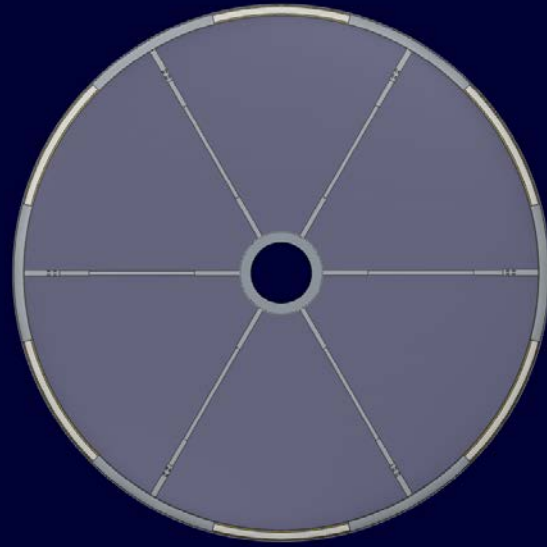
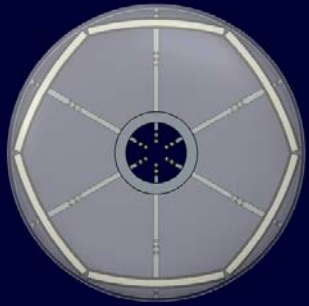

Stowed configuration

Deployed Configuration

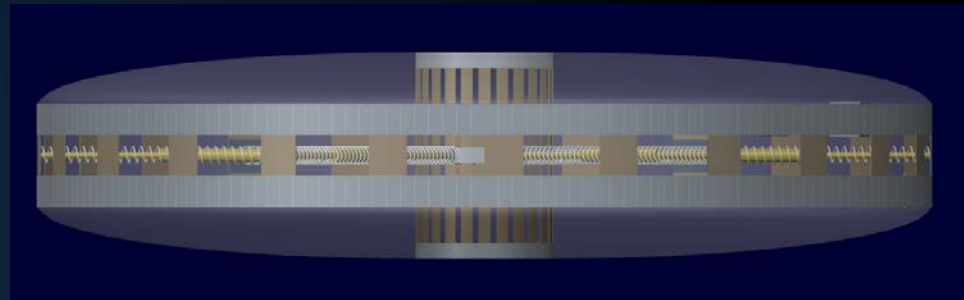
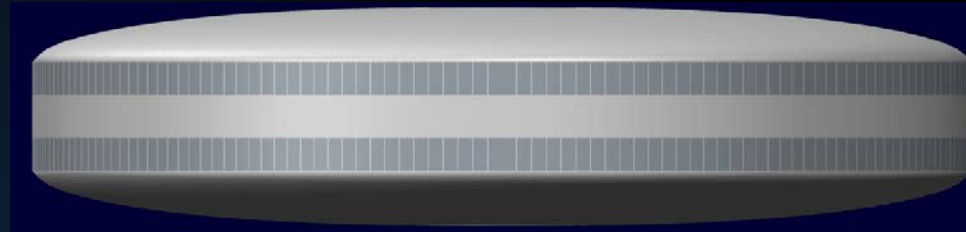
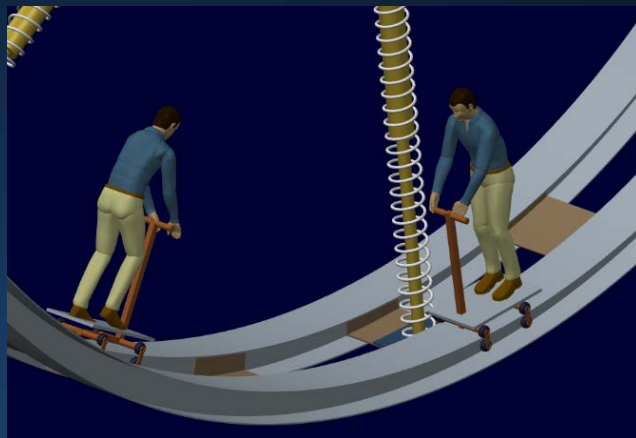

- This concept is a 3-meter tall, 13-meter diameter inflatable structure with a central hub and counter-rotating carts on a vibration-isolated track.
- Currently proposed B330 from Bigelow Aerospace is 6.7 meters diameter.

# Artificial Gravity Concept Feasibility Study

## Rotating Transit Vehicle Concept

- Vehicle consists of a large central hub with crew modules rigidly connected in a radially-symmetrical arrangement.
- The central hub spins along with crew modules as one body. There is no stationary section (avoids a joint between stationary and spinning modules).
- A flywheel in the central hub is used to start, stop and control the spin rate of the vehicle. The flywheel size and spin speed is in the same order of magnitude of the currently flying CMGs on the International Space Station.
- With the vehicle spinning, the crew can live for periods of time in a 1-g environment in the peripheral modules and return to the low-gravity environment of the hub. When not spinning, it can receive visiting vehicles, launch landers, undertake maneuvers or take advantage of 0g in the hub.
- Crew can shelter from radiation in the central module protected by water and fuel tanks.
- Modules and tunnels may be inflatables taking advantage of BEAM and TRANSHAB experience.

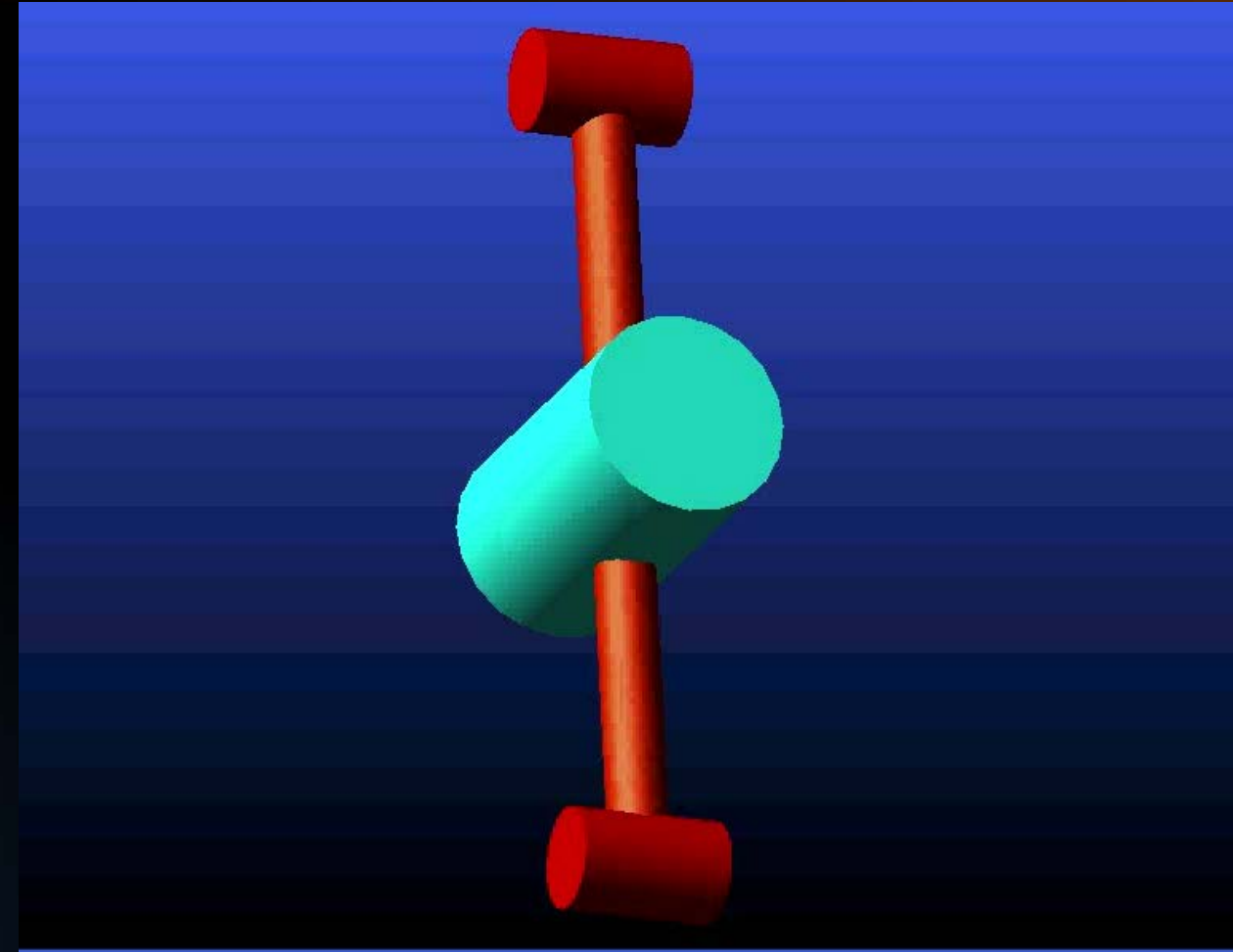

Crew modules, each:	$M_c = 4,500 \text{ kg}$ ,	$R_c = 12.2\text{m}$
Central hub:	$M_h = 68,000 \text{ kg}$	$R_h = 3.05\text{m}$





# Artificial Gravity Concept Feasibility Study

## Conclusions

- With the relaxation of certain constraints, the implementation of artificial gravity in a prototype spacecraft demonstrator appears feasible in the near-term (i.e., within the next decade).
- Rotation rates from 9 - 15 rpm open up the design trade space to a wide variety of artificial gravity implementations.
- Below about 25% gradient across the body, increasing the radius of rotation beyond 6m provides diminishing returns.
- An SLS LOX tank is a structure currently being developed that could be studied for integration of an artificial gravity system if the rotation radius (~3.5m) is acceptable for a prototype demonstrator.
- Inflatable/deployable structures appear to be the best option for larger radii of rotation, due to launch vehicle payload envelope constraints. However, these large inflatable/deployable structures would require a dedicated development effort.
- Current launch vehicle lift capability limits an inflatable structure to about 7m radius in a single launch.
- Sudden stopping of a rotating artificial gravity system can induce significant loads into the spacecraft.
- An artificial gravity system operating nominally in the range of 4 – 15 rpm does not induce drastic loading into the structure but it will have to be isolated to avoid any concerns with appendage vibrations and expenditure of structural life.



## Team Members

- Aaron Allcorn
- Damien Calderon
- Dr. Gilles Clement
- Mike Grygier
- Jeff Hagen
- James Hampton
- Mykale-jamal C. Holland
- George James
- Steve Koontz
- Greg Lange
- Doug Litteken
- Kevin Macneil
- Canaan Martin
- Brett D. Montoya
- Kornel Nagy
- Joshua Peterson
- Taylor Phillips-Hungerford
- Jasen Raboin
- Satish Reddy
- Khadijah Shariff
- Bob Wilkes
- Ken Wong
- Riley Flanagan

Thank you for your attention!

Questions?

