

The Large UV/Optical/Infrared Surveyor (LUVOIR)

Decadal Mission Concept Study Update
for the 2019 IEEE Aerospace Conference

Jason Hylan on behalf of the LUVOIR Mission Concept Study Team

NASA Goddard Space Flight Center <http://www.nasa.gov/goddard> • Electromechanical Systems Branch (544) • (301) 286-9496 • jason.e.hylan@nasa.gov

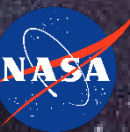

Are we alone in the universe?

Are we unique?

How did we come to be?

*LUVOIR is designed to answer
those questions and
accomplish amazing science
for a broad range of the
astronomical community...*

*...and answer questions we
can't conceive of today....*

What is LUVOIR?

What is LUVOIR

- Large Ultraviolet Optical Infrared Surveyor
 - <https://asd.gsfc.nasa.gov/luvoir/>
- LUVOIR is a large space telescope in the tradition of the Hubble Space Telescope with design aspects from the James Webb Space Telescope
 - Broad science capabilities
 - Far-UV to Near-IR bandpass
 - Suite of imagers and spectrographs
 - Serviceable and upgradable
 - Hubble-like guest observer program
- At this time, LUVOIR is not a single design, rather it is two distinct concepts that bookend a breadth of design options for the astronomical community.

- The Astrophysics Division of NASA's Science Mission Directorate commissioned the study of four large mission concepts for consideration by the 2020 Decadal Study.
- LUVOIR is one of those mission concepts
- The Habitable Exoplanet Observatory (HabEx), the Origins Space Telescope (OST), and the Lynx X-ray Observatory represent the other 3 mission concepts.

Never before has NASA studied mission concepts in so much detail PRIOR to a decadal survey!

Where are we in the process?

LUVOIR Mission Concept Study Timeline

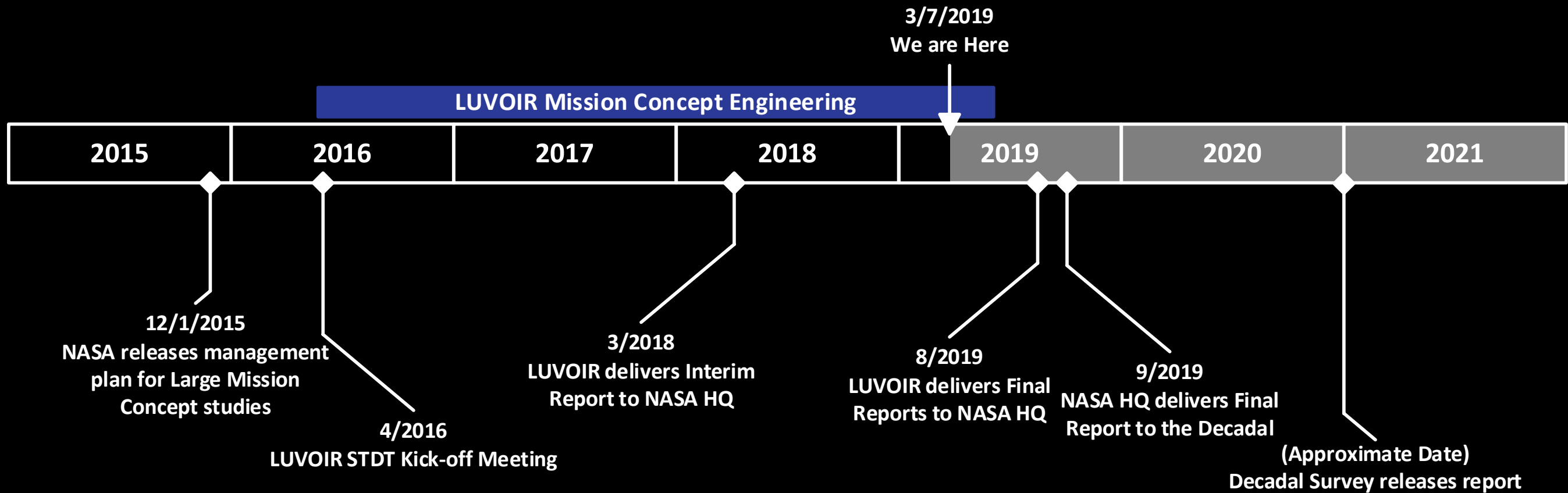

The Mission Concept Studies are nearing the delivery of their final reports.



The Mission Architecture

Mission

Segments

Elements

Sub-Systems

Assemblies

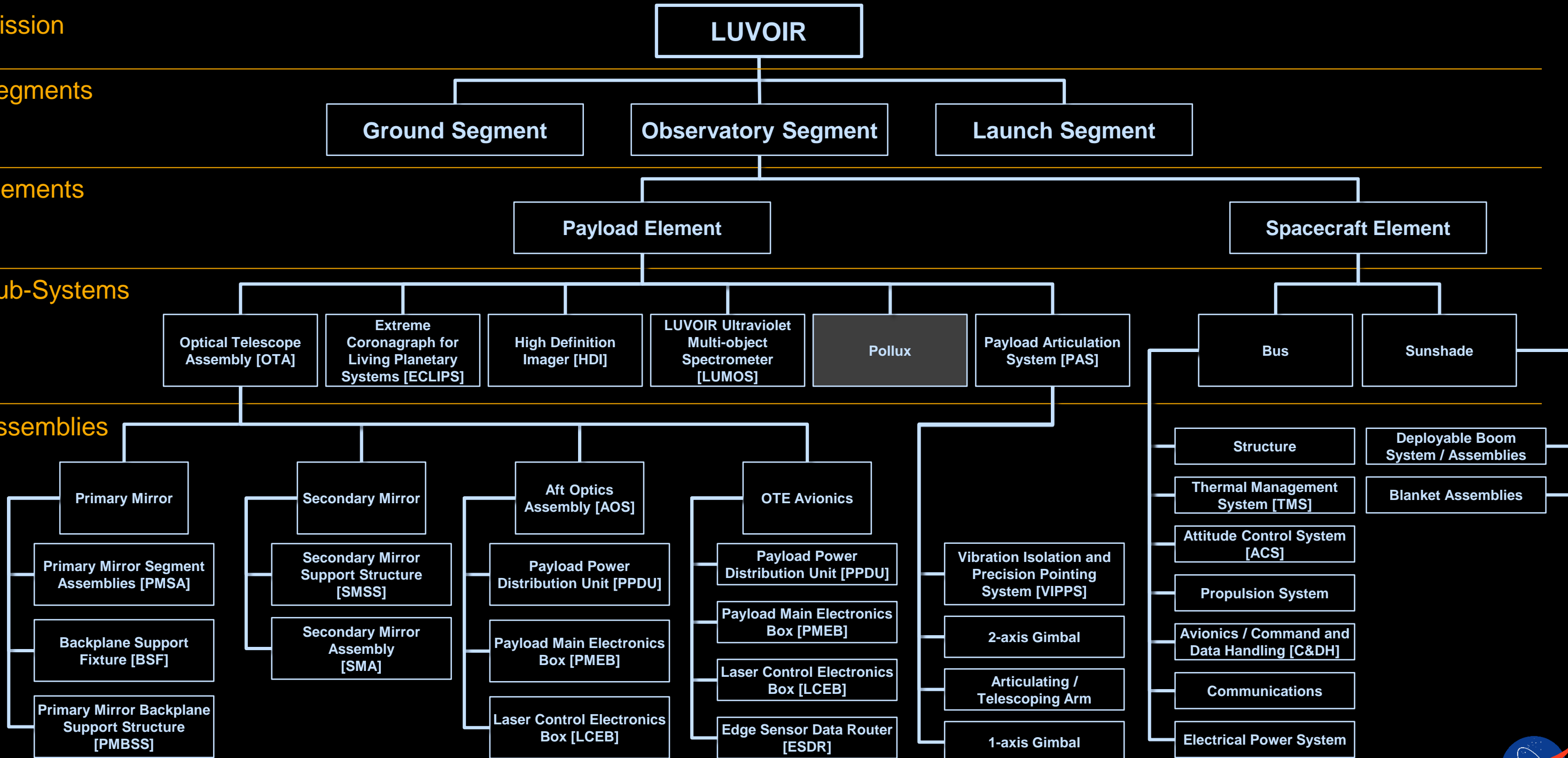

LUVOIR-A

LUVOIR-B

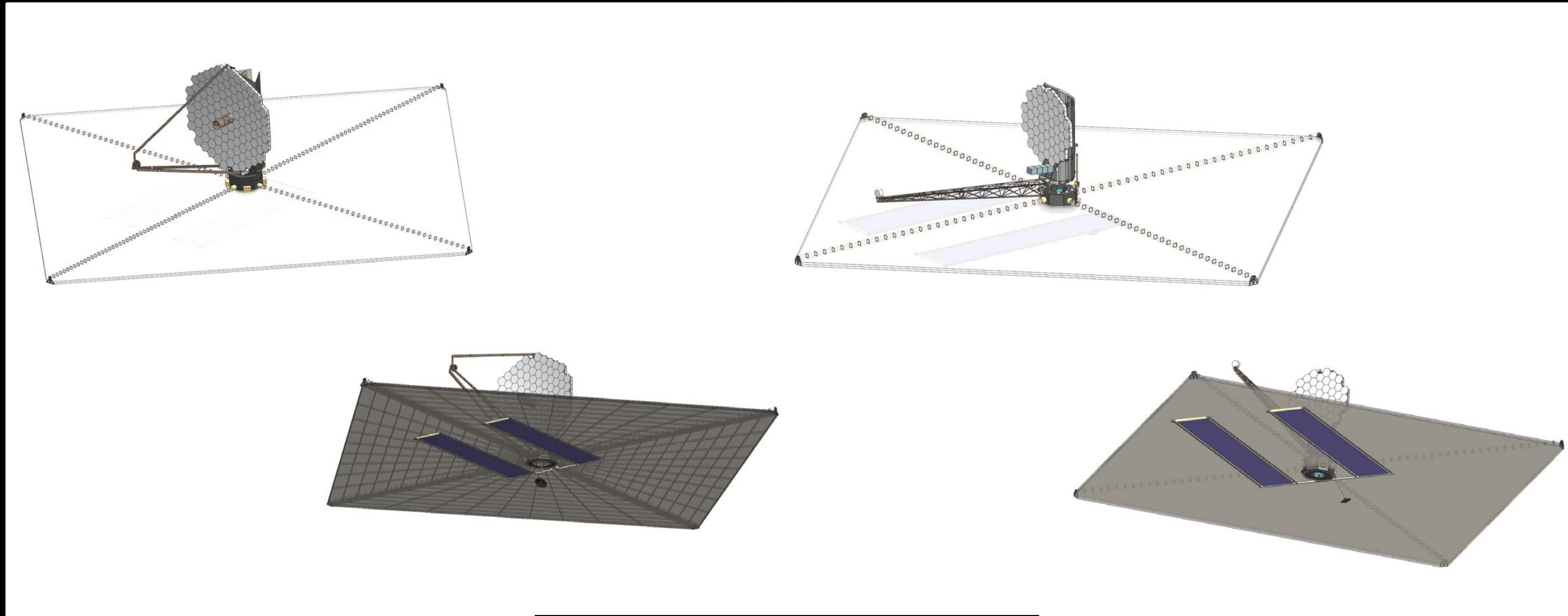

Renderings courtesy of Andrew Jones (GSFC)

The Observatory – Scope and Size

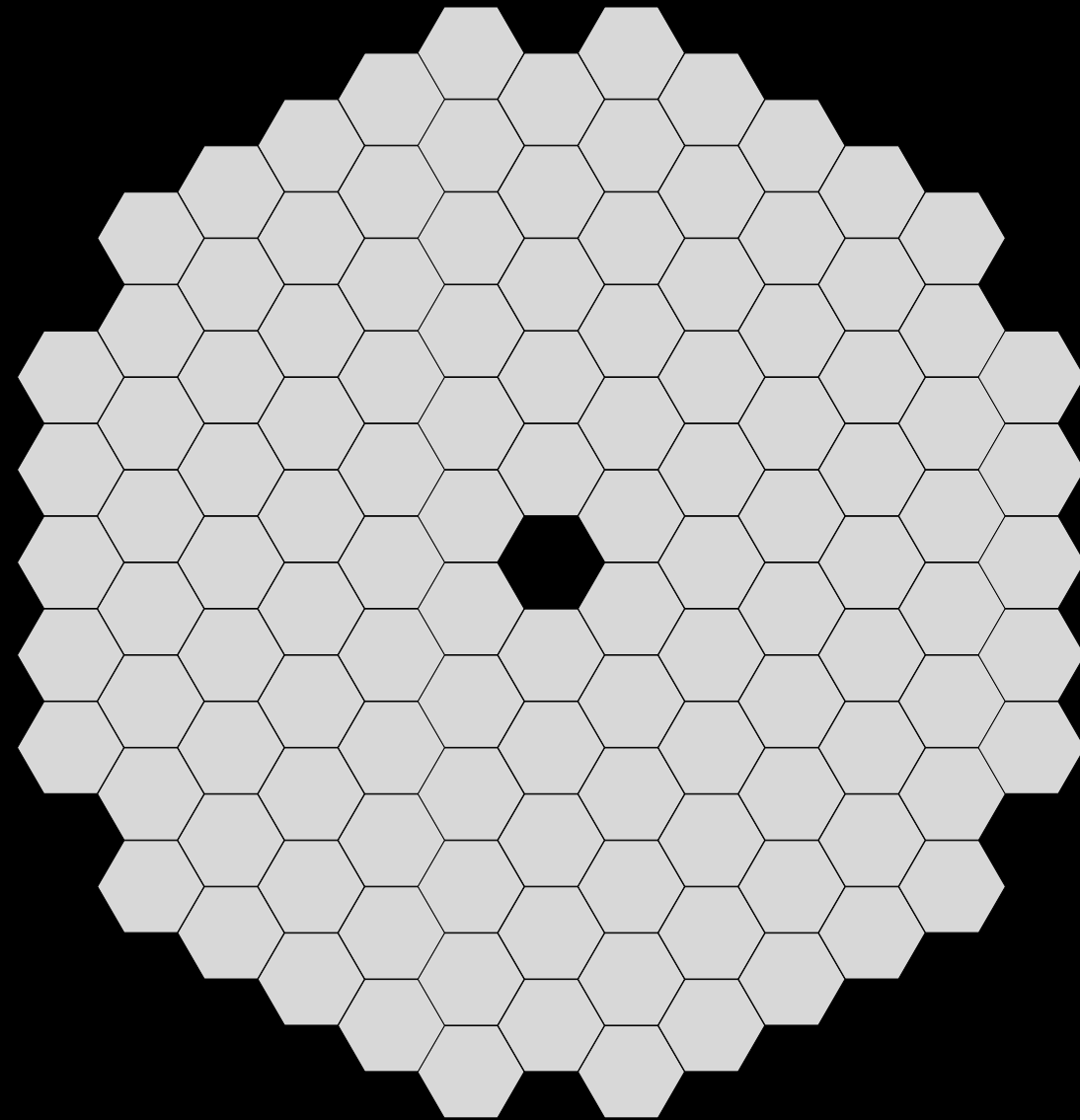
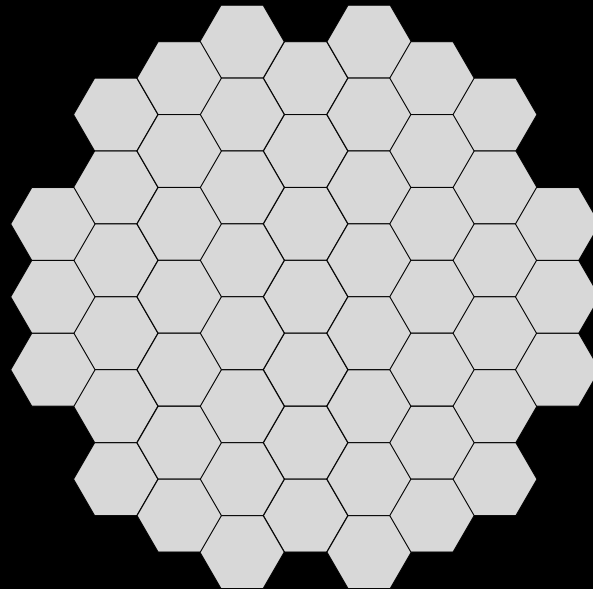
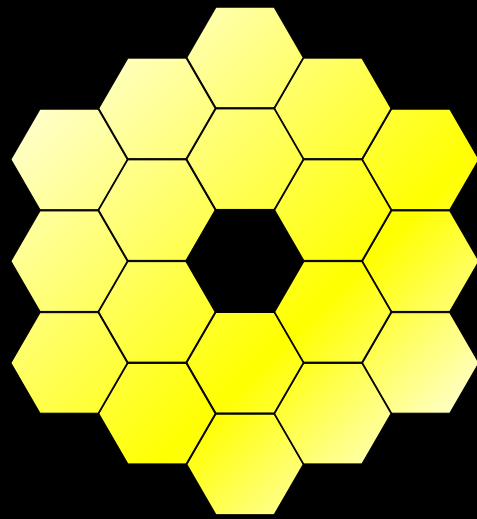
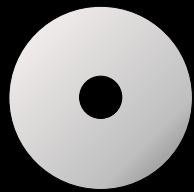

HST / WFIRST
2.4m Primary Mirror
On-Axis Design

JWST
6.5m Primary Mirror
On-Axis Design

LUVOIR-B
8m Primary Mirror
Off-Axis Design

LUVOIR-A
15m Primary Mirror
On-Axis Design



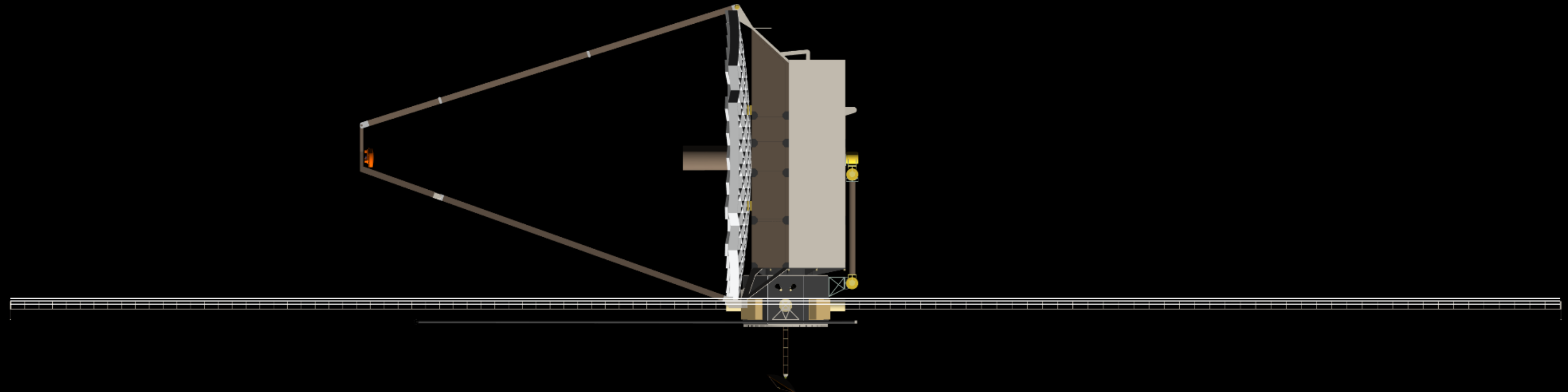

Observatory Segment

The Observatory Segment

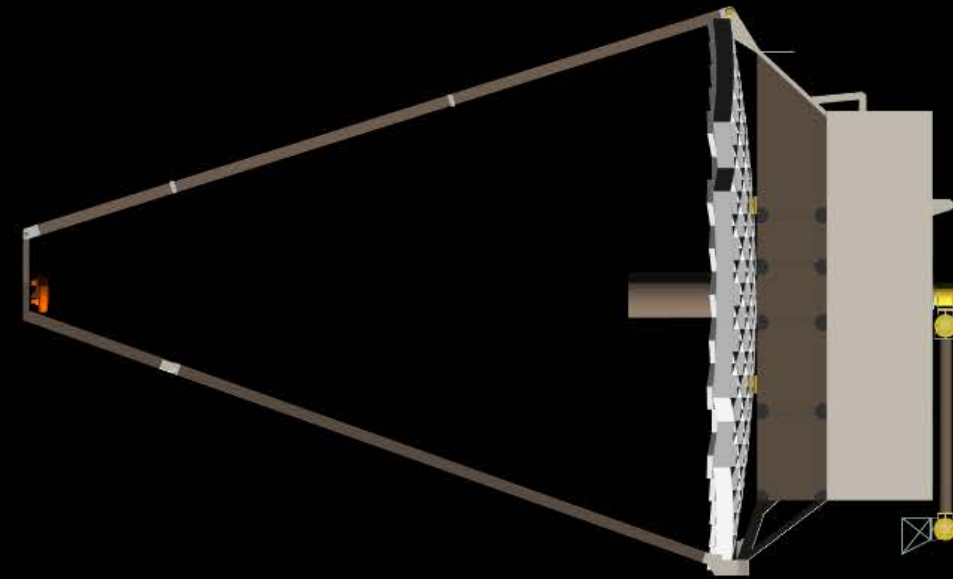

Payload Element

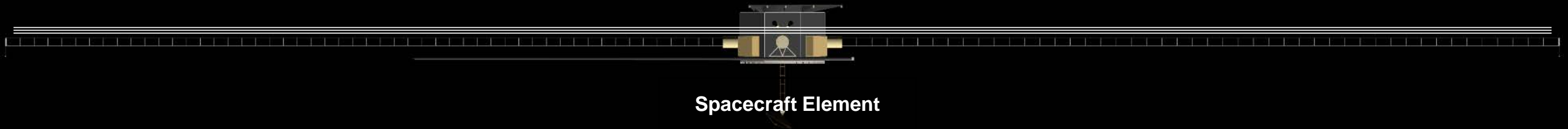

Spacecraft Element

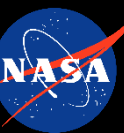

The Payload Element

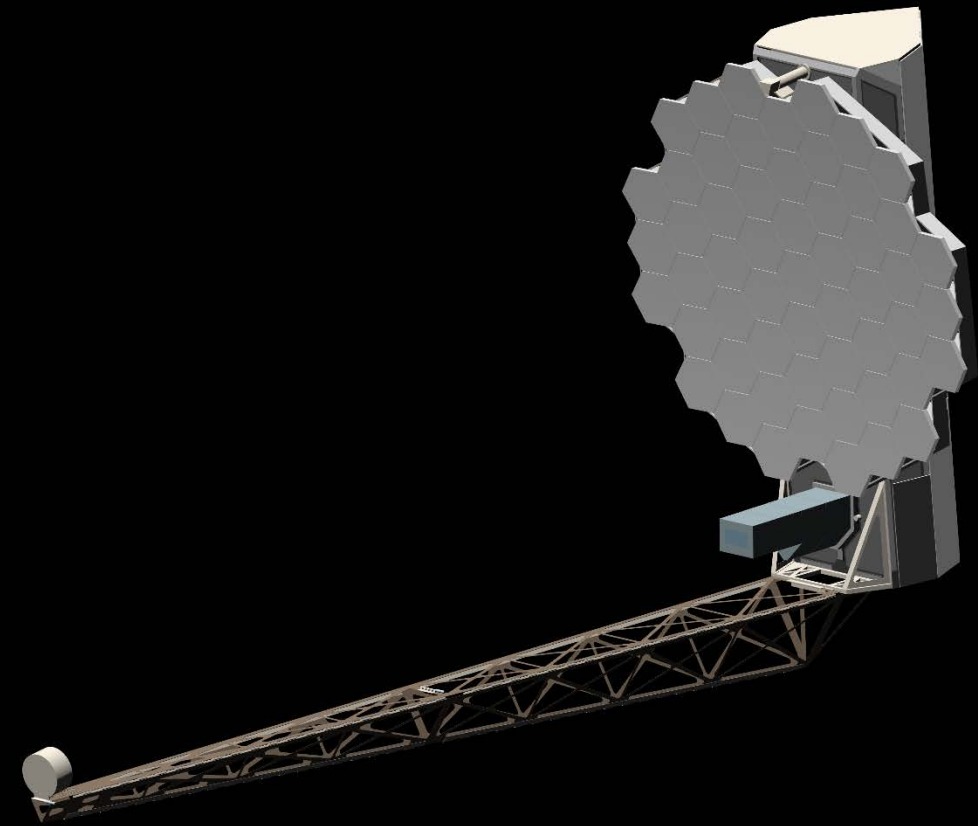
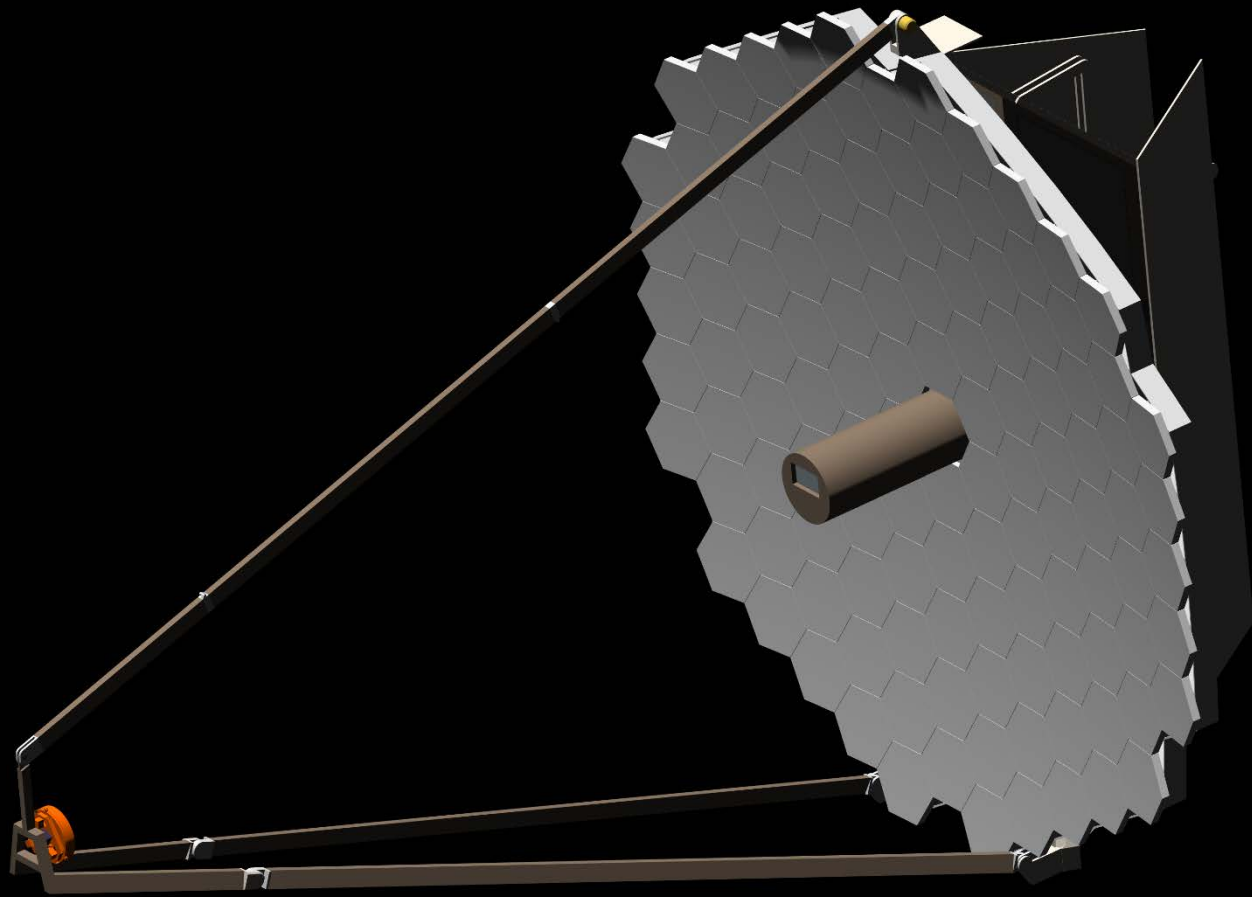

Payload : Optical Telescope Assembly

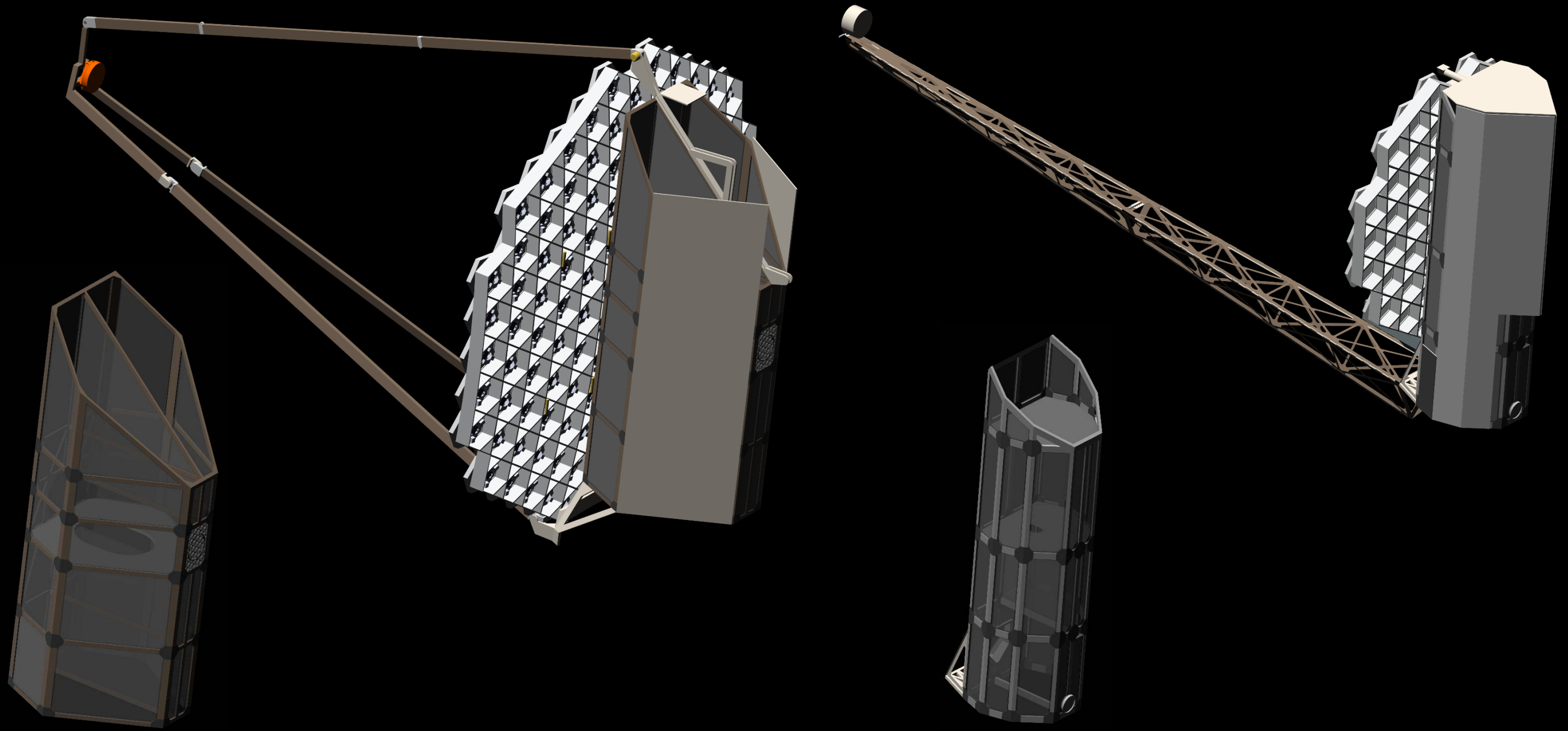

Payload : Optical Telescope Assembly

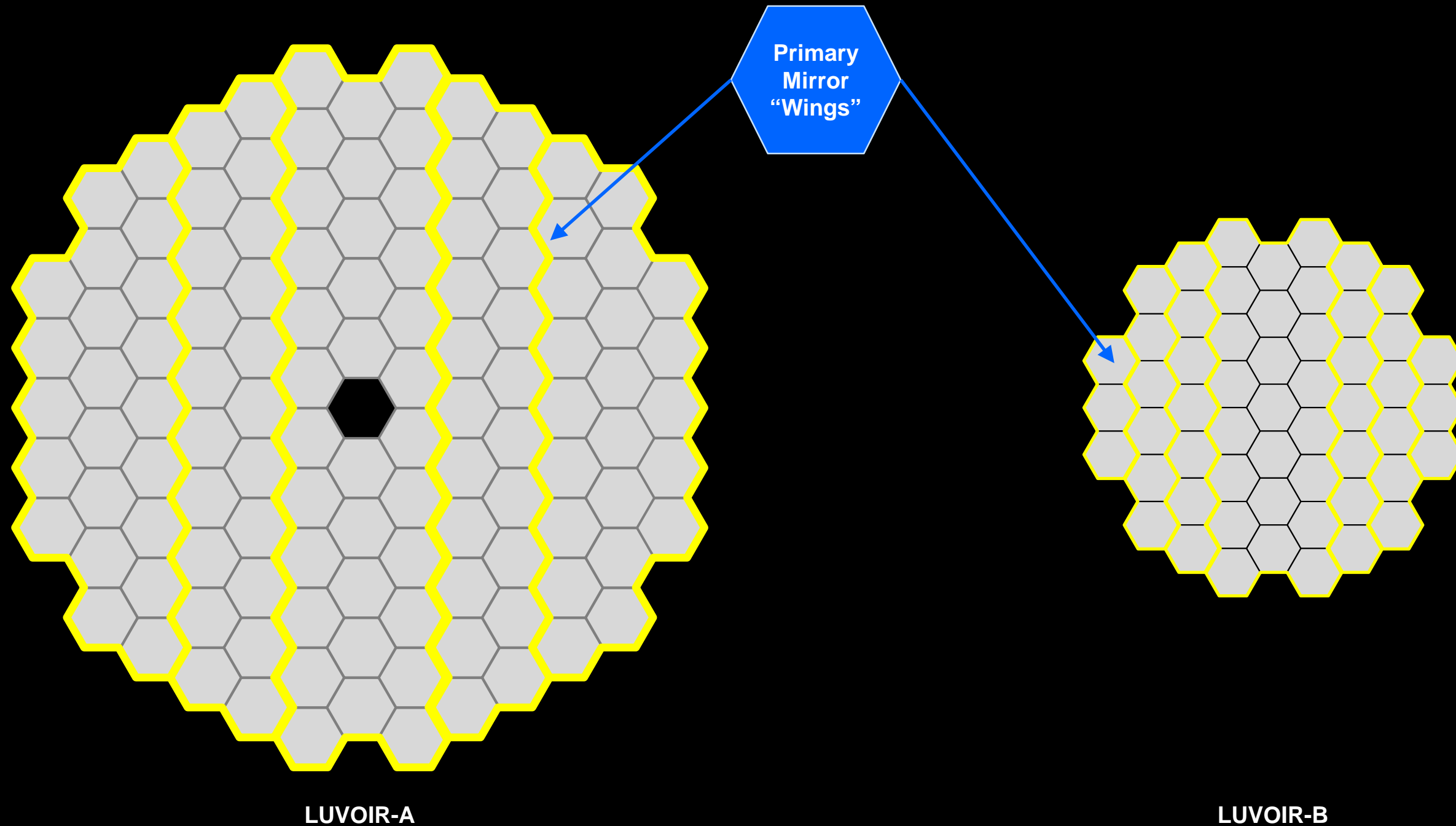

Payload : Extreme Coronagraph for Living Planetary Systems

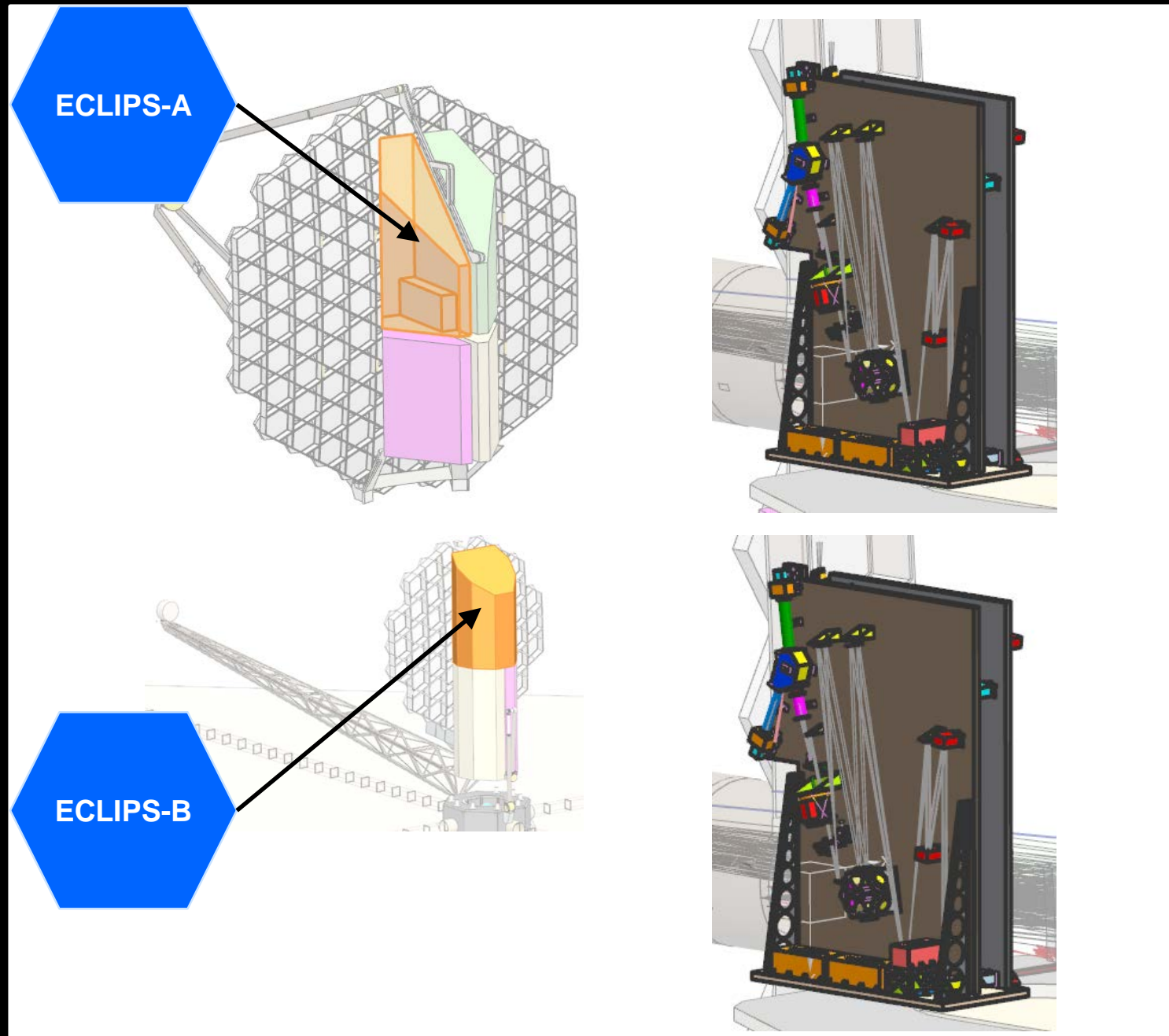

Renderings courtesy of Andrew Jones (GSFC)

ECLIPS					
Science Objective	<ul style="list-style-type: none"> ▶ Survey sun-like (F,G,K) stars in the local neighborhood and search for exoplanets within an annular region around the star defined by the inner-working angle (IWA) and outer-working angle (OWA) ▶ Directly image exoplanets via high-contrast imaging and spectrally characterize the atmospheres of those planets via medium and high resolution spectroscopy ▶ Emphasis is on the search for biosignatures on earth-like planets within the habitable zone, though all planets will receive some degree of characterization 				
Channels	UV	Optical		NIR	
Bandwidth	200 - 525 nm	515 nm - 1.03 micron		1 - 2 microns	
Modes	Imager	Imager	Integral Field Spectrograph	High Resolution Spectrograph	Integral Field Spectrograph
Heritage	CGI on WFIRST (high contrast coronagraph)				

Payload : LUV O I R Ultraviolet Multi-object Spectrometer

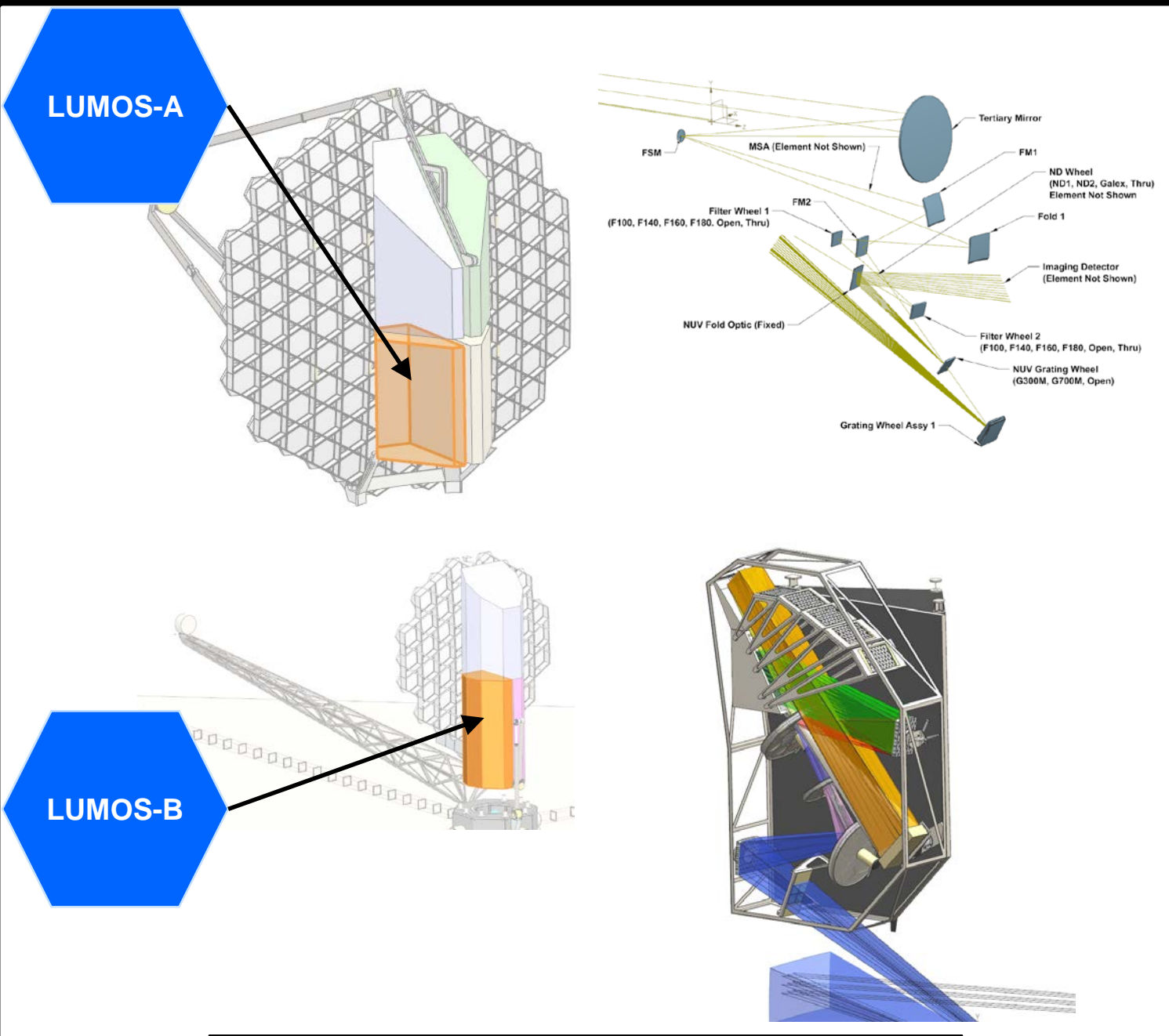

Renderings courtesy of Andrew Jones (GSFC)

LUMOS			
Science Objective	LUMOS is the primary ultraviolet instrument on LUV O I R, incorporating multiple observations <ul style="list-style-type: none"> ▶ Multi-object, multi-resolution spectroscopy in the FUV and NUV for highly multiplexed spatially-resolved spectroscopy ▶ Wide field-of-view imaging in the FUV ▶ Point-source high-resolution spectroscopy 		
Channels [A]	FUV/NUV/VIS	FUV	FUV
Bandwidth [A]	100 nm - ~1 micron	100 - 200 nm	100 - 200 nm
Modes [A]	FUV Multi-object, multi-resolution Spectrograph	NUV/VIS Multi-object, multi-resolution Spectrograph	Imager
Field of View [A]	2 x 2 arc•min	2 x 2 arc•min	~1 arcsec
Channels [B]	FUV/NUV/VIS		FUV
Bandwidth [B]	100 nm - ~1 micron		100 - 200 nm
Modes [B]	FUV/NUV/VIS Multi-object, multi-resolution Spectrograph	FUV Multi-object, multi-resolution Imager	FUV Point Source (via MS) / Fixed High-Resolution Spectrograph
Field of View [B]	2 x 2 arc•min		~1 arcsec
Heritage	STIS & COS on the Hubble Space Telescope (detectors, optics, designs); NIRSpec on JWST (spectrograph with microshutters for multi-object capability); Sounding rocket instruments CHESS, SISTINE, and FORTIS (microshutters)		

Payload : High Definition Imager

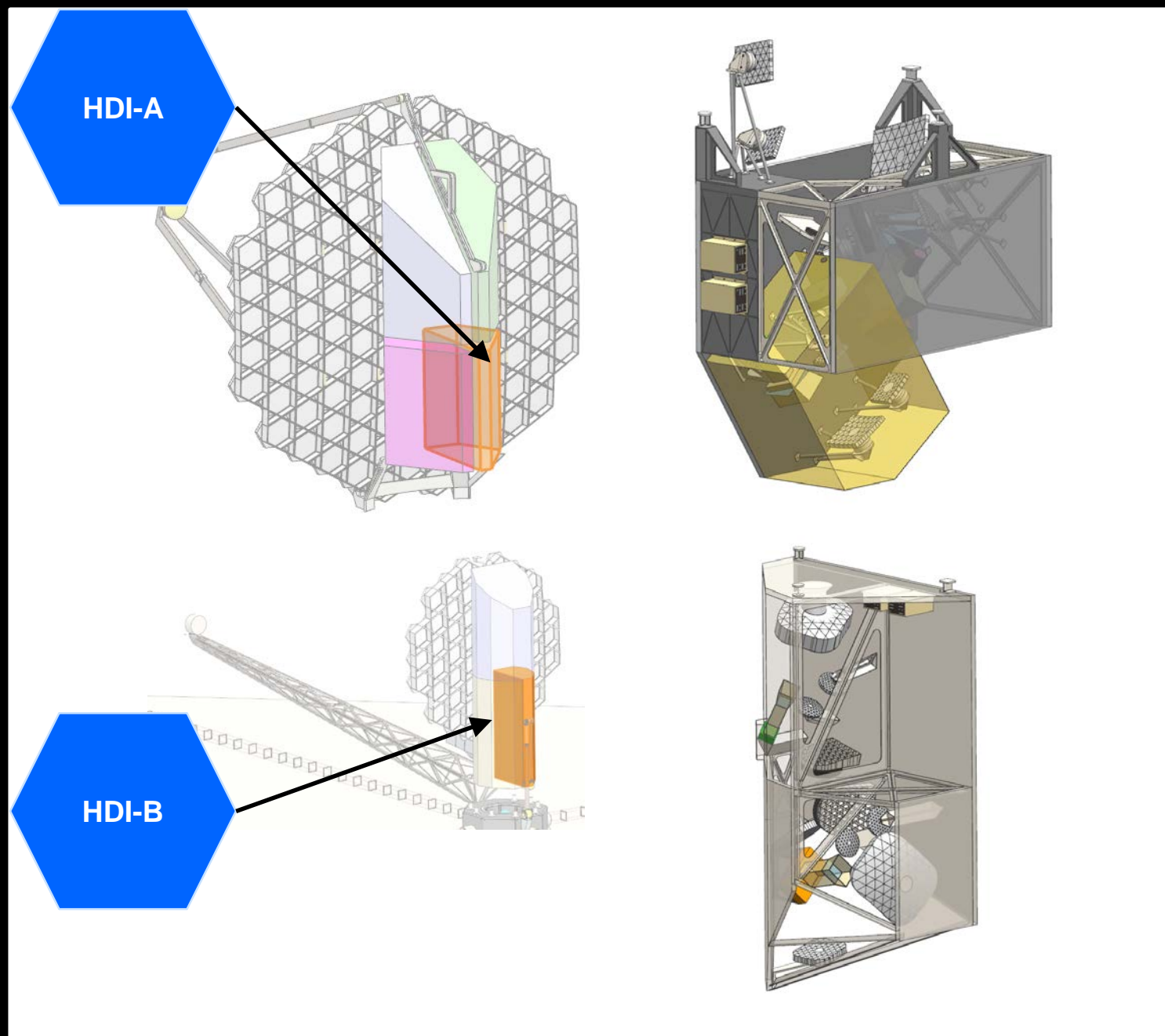

Renderings courtesy of Andrew Jones (GSFC)

HDI		
Science Objective	▶ Detect Lyman continuum flux for $z > 7$ galaxies to probe re-ionization structure and test models for reionization	
	▶ Measure Galaxy Luminosity Function down to 34 absolute magnitude to test basic models of galaxy formation	
	▶ Detect stars below the main sequence turn-off in galaxies out to a distance of 10 Mpc and measure their colors and luminosities to reconstruct star formation histories and ages	
	▶ Study small-scale structure within $z > 2$ galaxies, down to 100 pc, in UV and visible to study growth of substructure and morphology	
	▶ Constrain dark matter distribution and properties by measuring proper motions of stars in Local Group galaxies, and proper motions of galaxies within 15 Mpc of the Milky Way	
	▶ Potentially detect exoplanets via their induced astrometric wobble signature on their host stars; identify Earth-mass planets within the habitable zone regions	
	▶ Map the distribution of small bodies in the outer solar system, including the identification of dwarf to full-size planetary objects in the outer Kuiper belt	
	▶ Measure the 3-D structure in the atmospheres of the gas giants and Venus	
	▶ Survey the presence of orbital debris around small bodies (asteroids, centaurs, KBOs) in the solar system	
Channels	UVIS	NIR
Bandwidth	200 nm - ~1 micron	~1 - 2.1 micron
Modes	Imager	Imager
Field of View [A]	2.91 x 2.11 arc•min	2.94 x 2.17 arc•min
Field of View [B]	2.69 x 1.78 arc•min	2.71 x 1.79 arc•min
Heritage	Wide Field Camera 3 on Hubble (imager), WFI on WFIRST (imager), NIRCam on JWST (Wavefront sensing), FGS on JWST (fine guidance)	

Payload : Pollux

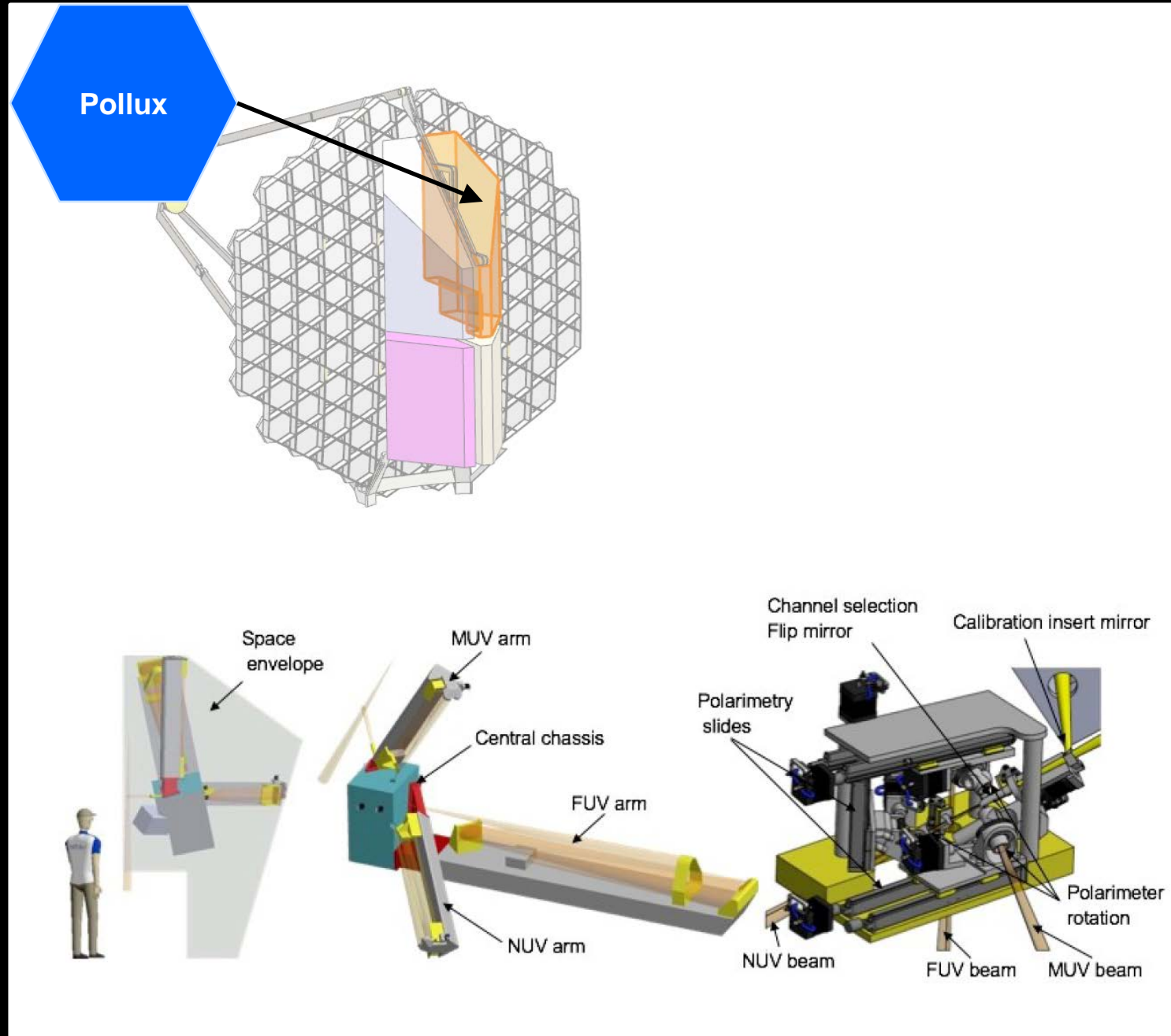

LUV O I R rendering courtesy of Andrew Jones (GSFC) / Pollux rendering courtesy of CNES

Pollux	
Science Objective	<p>The Pollux instrument is currently being studied by a consortium of European partners, led by the Centre national d'études spatiales (CNES).</p> <p>Although the Pollux instrument is a proof-of-concept demonstration of an instrument that would work with either LUV O I R architecture, the specific implementation being studied as the fourth instrument on the LUV O I R-A architecture.</p> <p>Pollux is a UV spectropolarimeter that complements the LUMOS instrument in both capability and scientific objectives. It combines high-resolution ($R > 120,000$) spectroscopy in the far- and near-UV (~100 – 400 nm) with polarimetry.</p> <p>The Pollux instrument study is still ongoing.</p>
Channels	FUV / NUV
Bandwidth	100 - 400 nm
Modes	Spectropolarimeter

Payload : Payload Articulation System

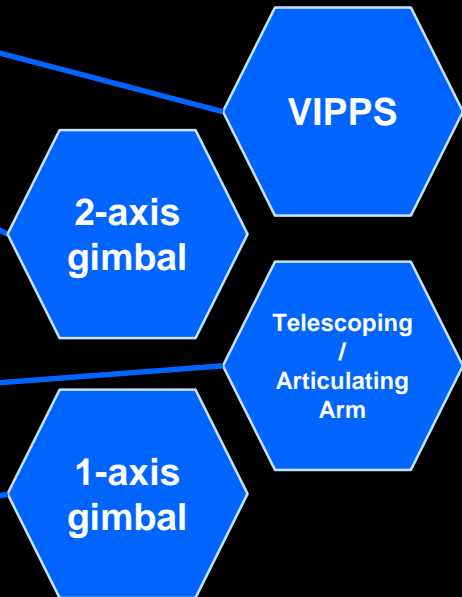
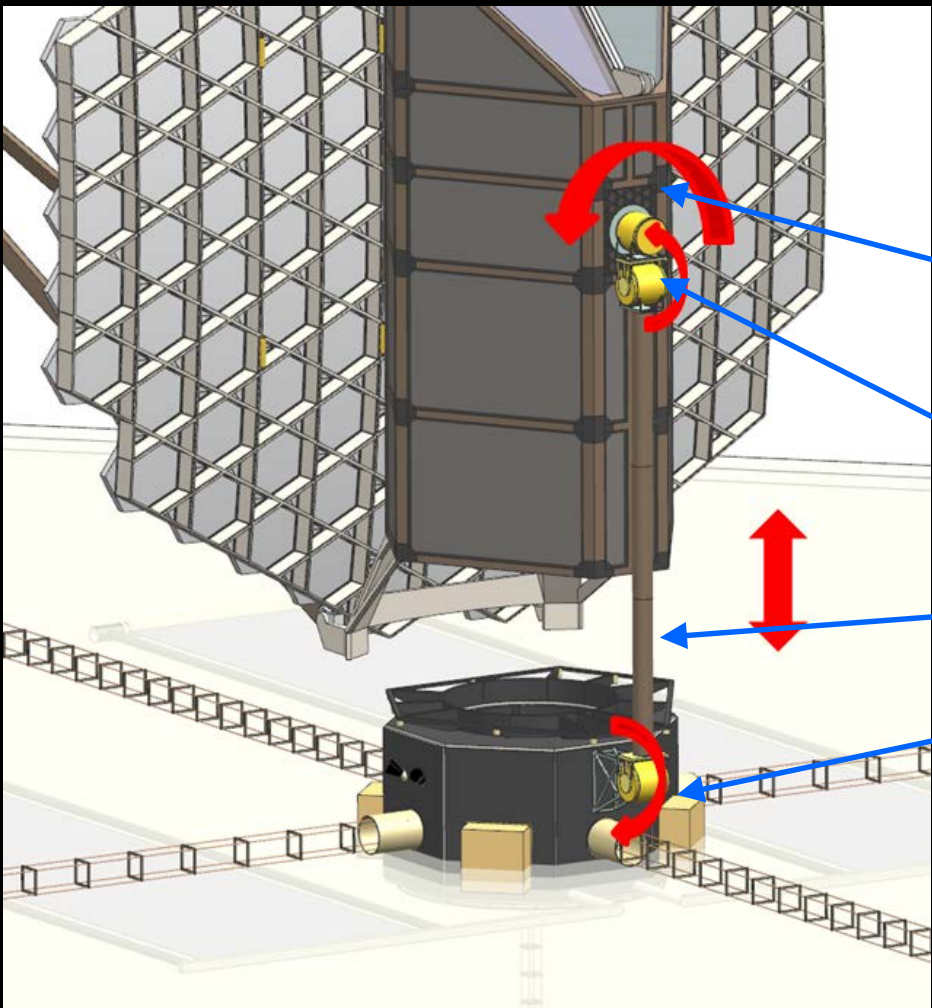

Rendering courtesy of Andrew Jones (GSFC)

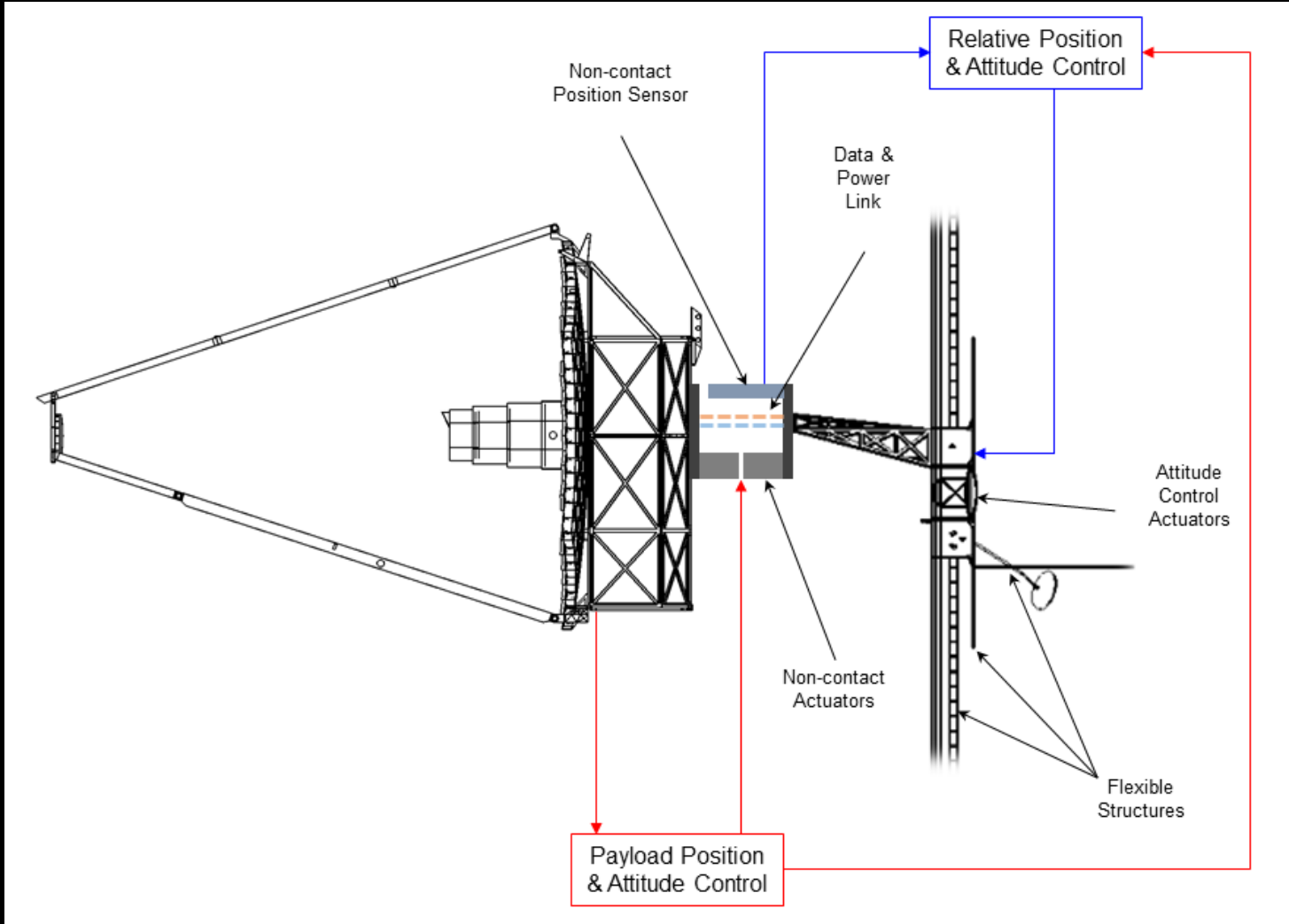

Rendering courtesy of Matt Bolcar (GSFC)

The Spacecraft Element

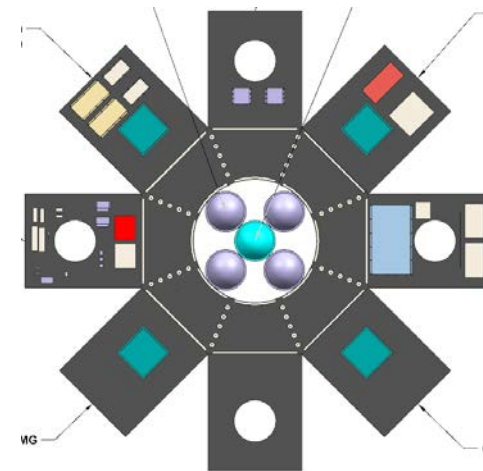
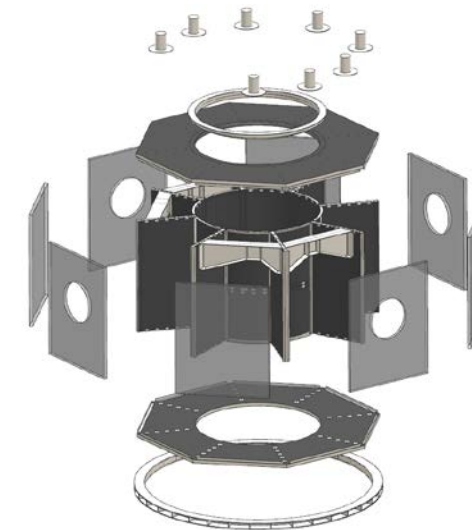
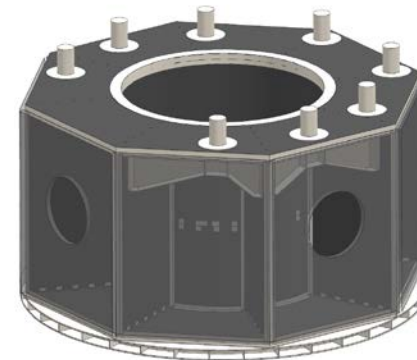
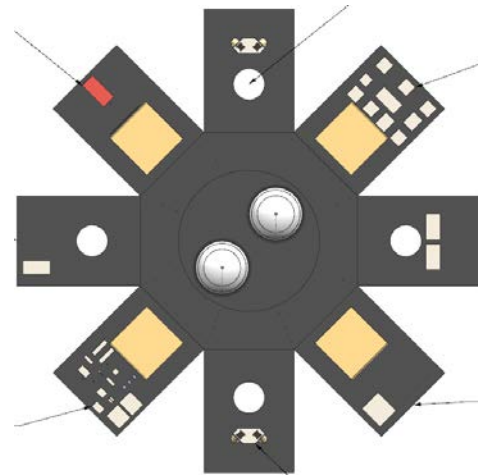
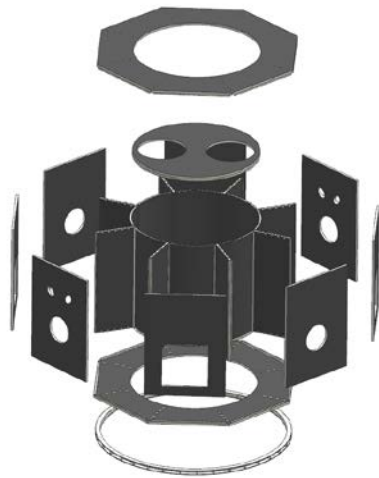
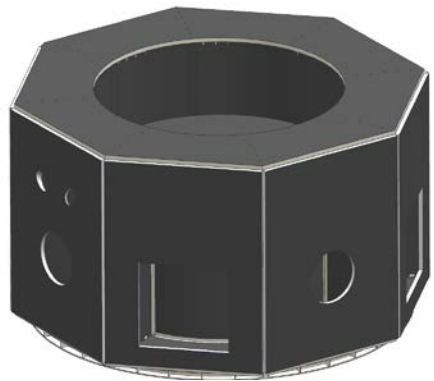
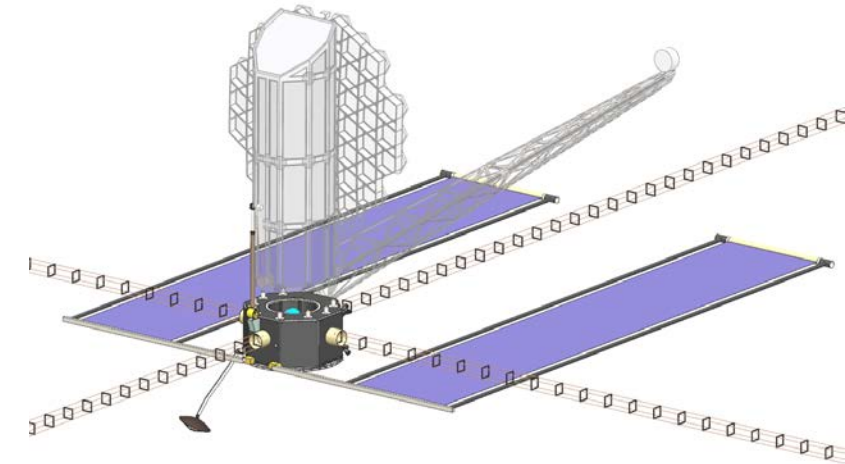
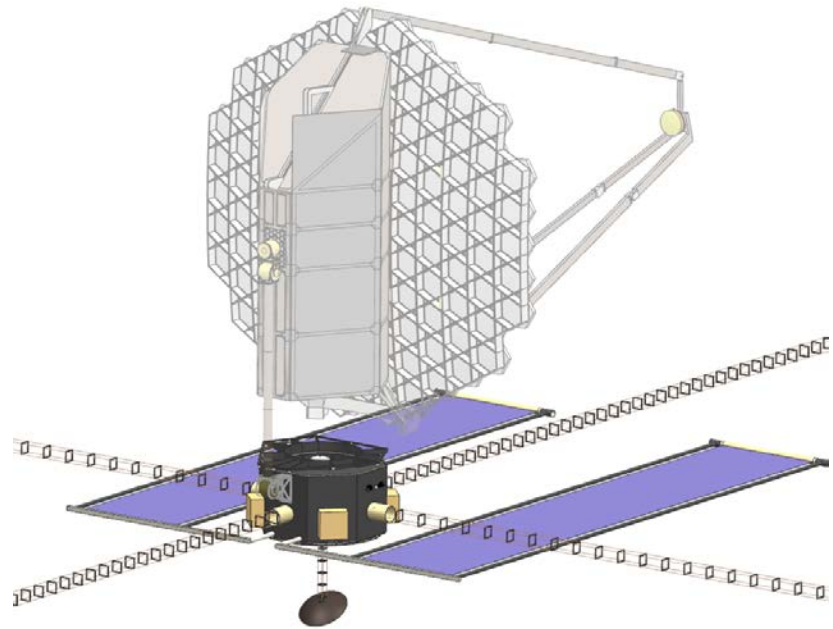

Renderings courtesy of Andrew Jones (GSFC)

Spacecraft : The Sunshade

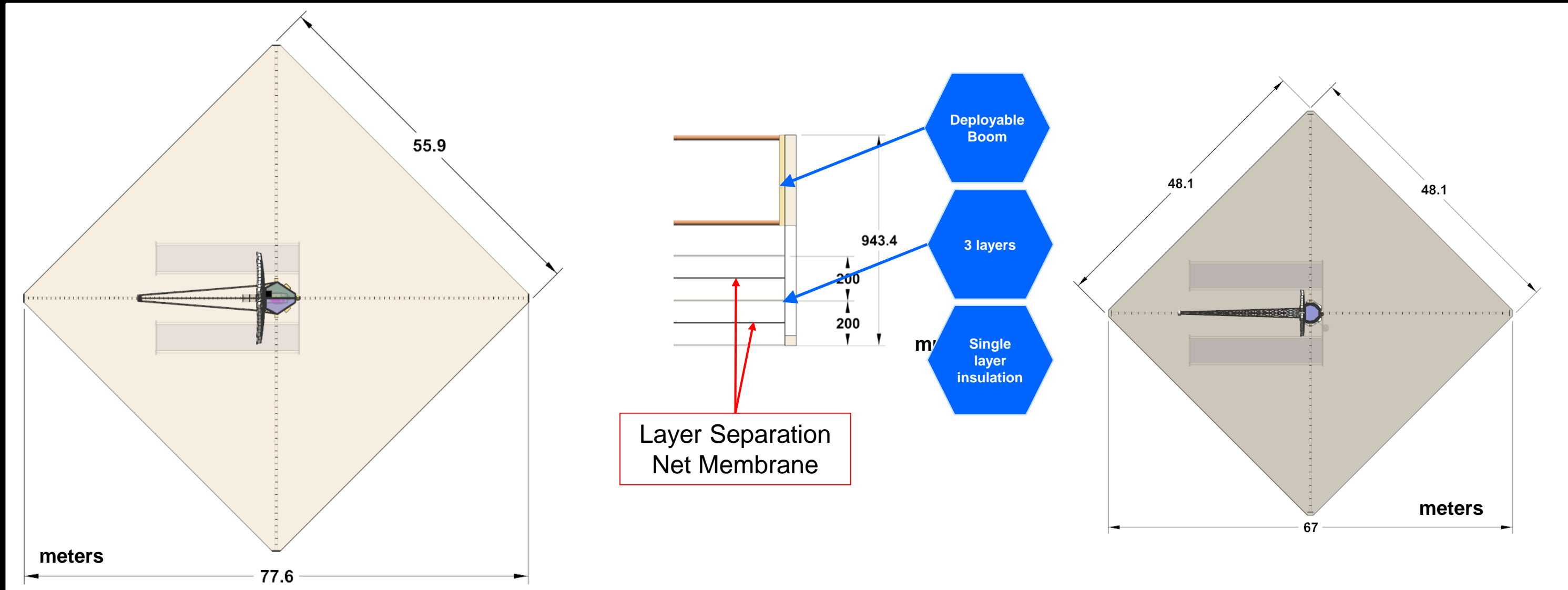

Renderings courtesy of Andrew Jones (GSFC)

The Launch Segment

- LUV O I R A requires both the volume and the launch capacity of an SLS Block 2 Cargo Launch Vehicle.
- LUV O I R B will *fit* into a “conventional” 5m fairing but requires a launch *lift capacity* of nearly 20,000kg. This dictates a need for the SLS Block 1B Cargo Launch Vehicle
- Commercial launch vehicles such as the SpaceX BFR could launch LUV O I R-B.
- Further refinement of the design could enable even more launch vehicle options such as the Blue Origins New Glenn.

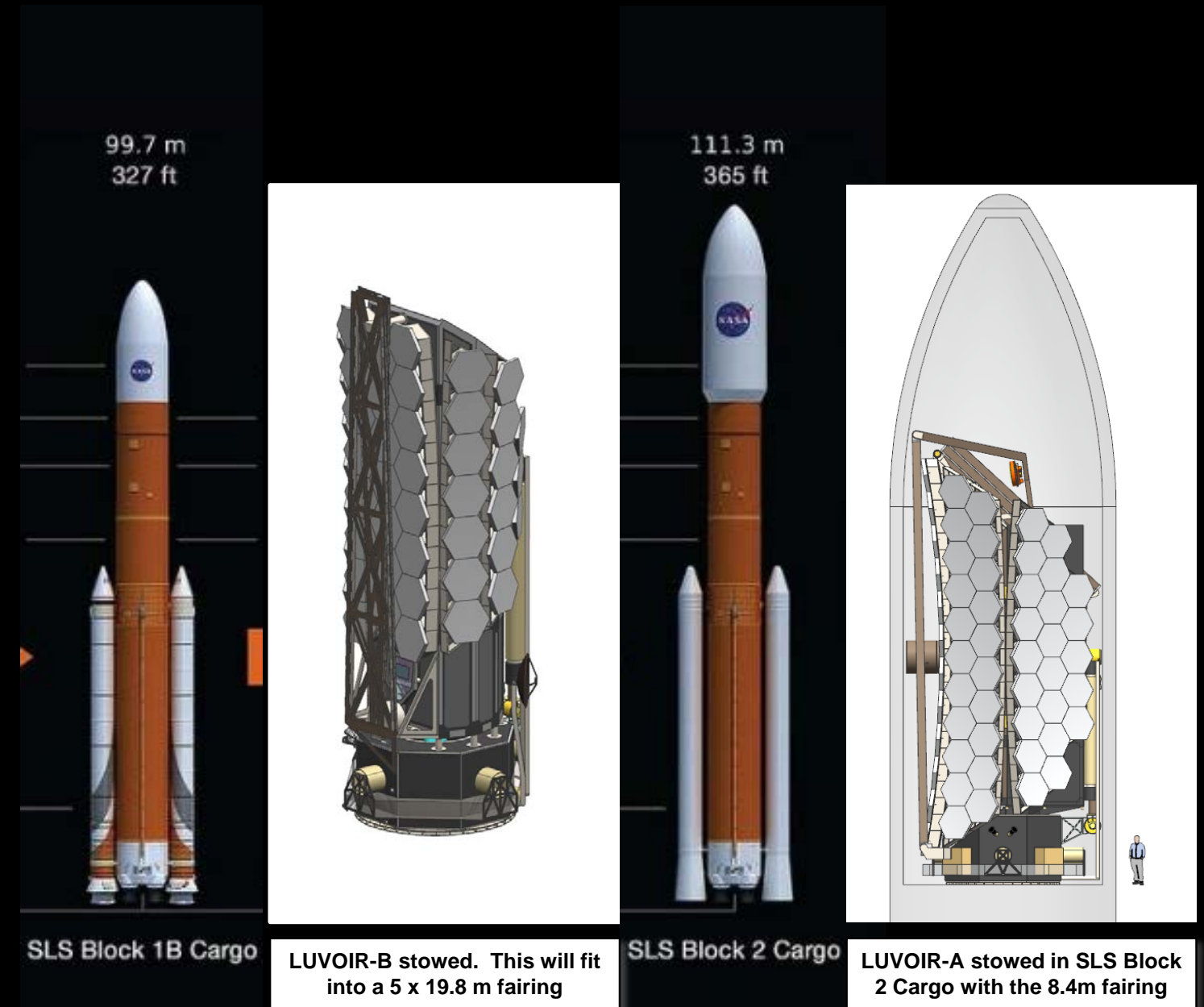

SLS renderings courtesy of NASA / LUV O I R renderings courtesy of Andrew Jones (GSFC)

The Ground Segment

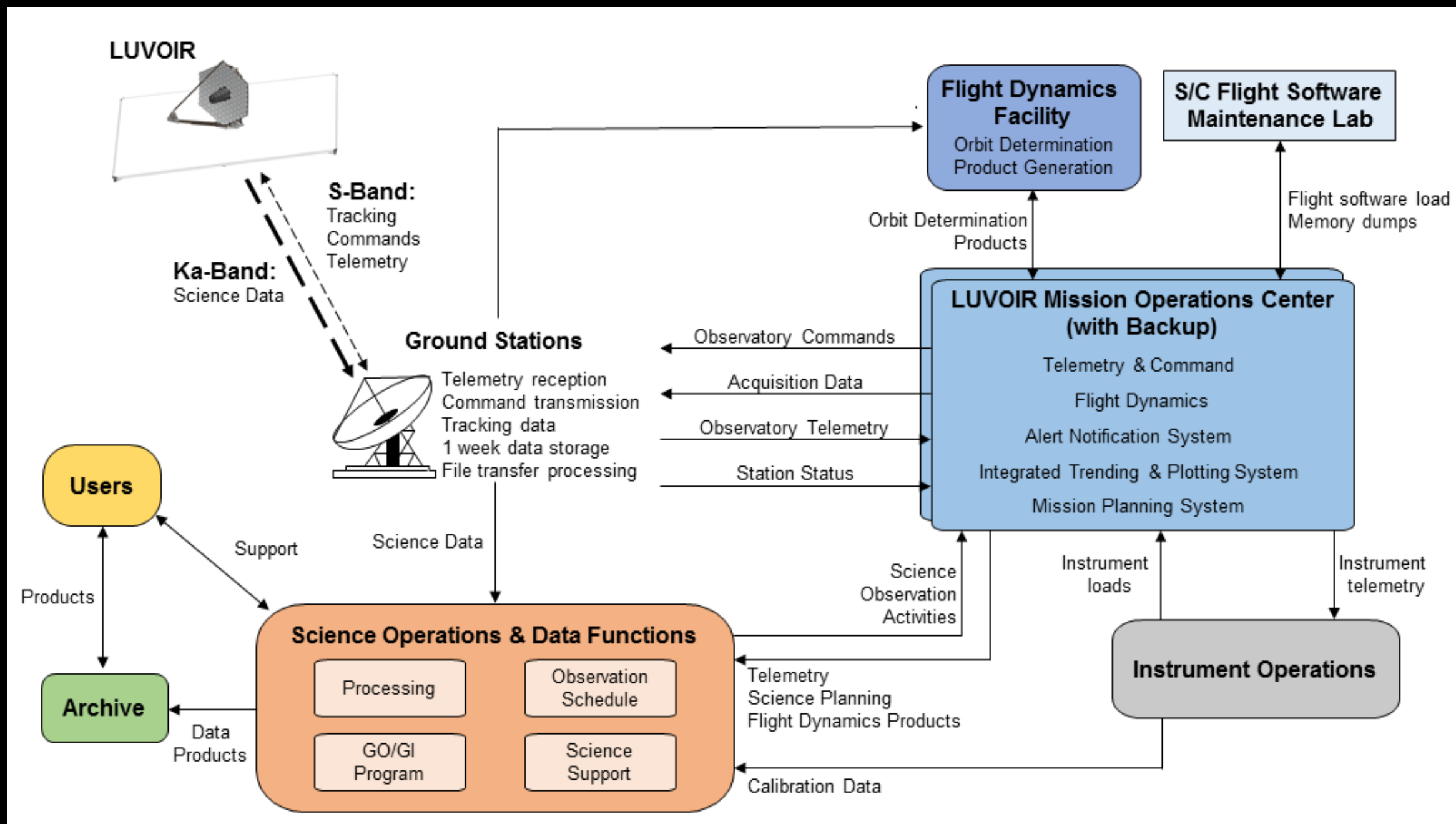

Implementation Schedule – LUVOIR A



- Mission
- Segment
- Element
- Sub-System
- Sub-System
- Sub-System
- Sub-System
- Sub-System
- Sub-System
- Sub-System
- Element
- Sub-System
- Sub-System

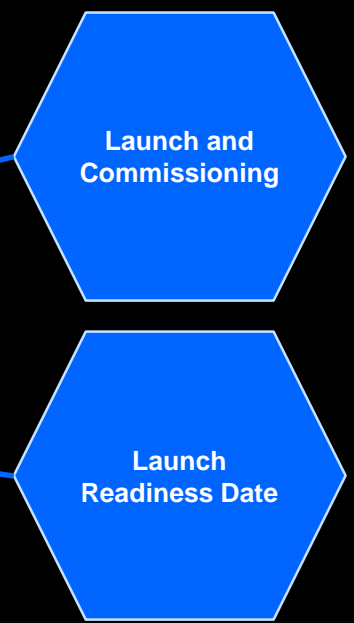
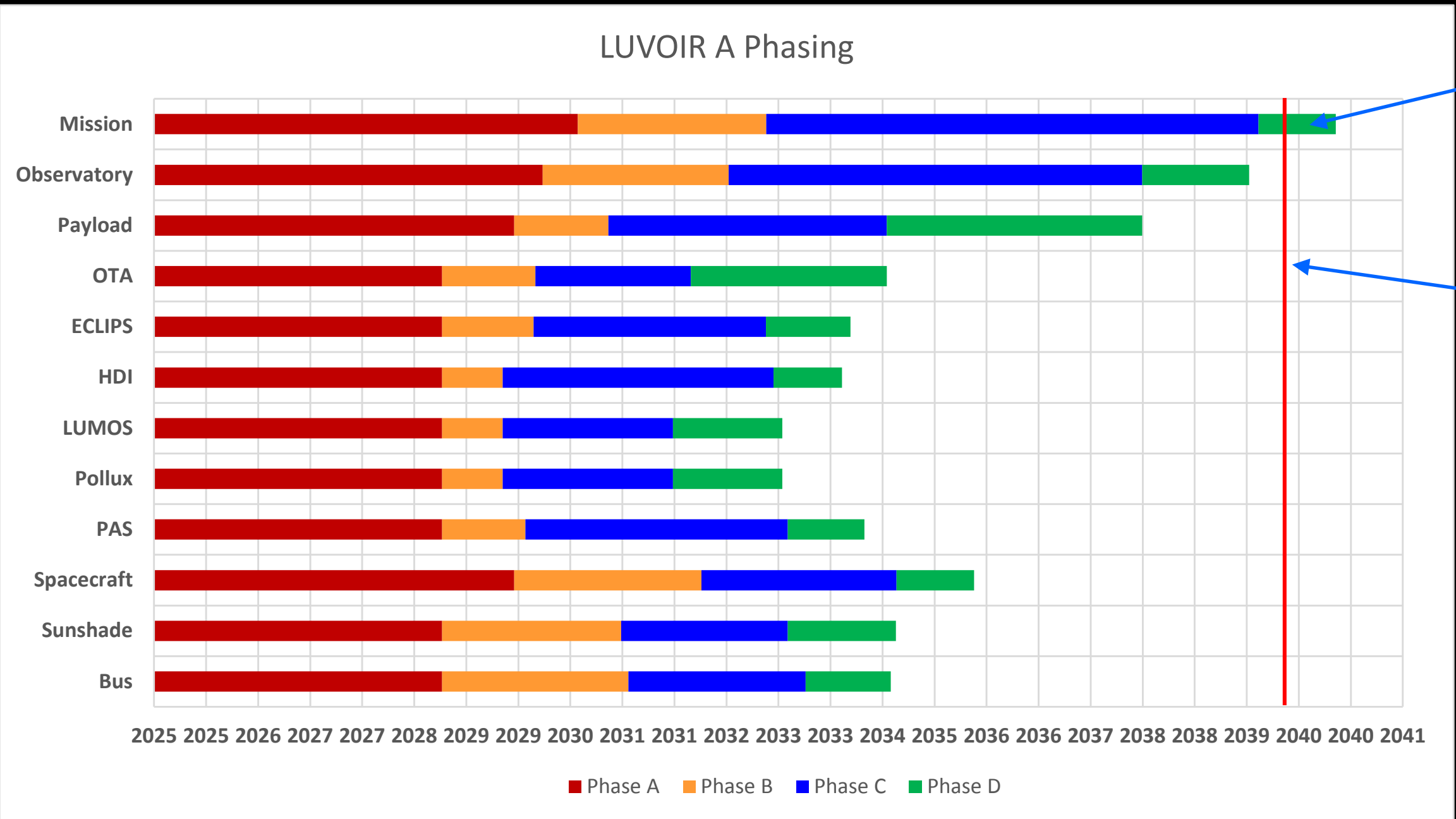

Implementation Schedule – LUVOIR B



- Mission
- Segment
- Element
- Sub-System
- Sub-System
- Sub-System
- Sub-System
- Sub-System
- Element
- Sub-System
- Sub-System

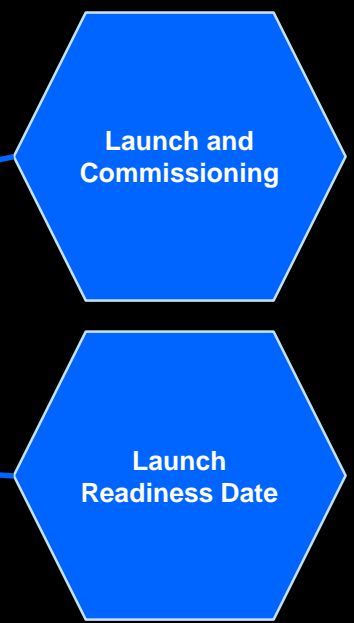
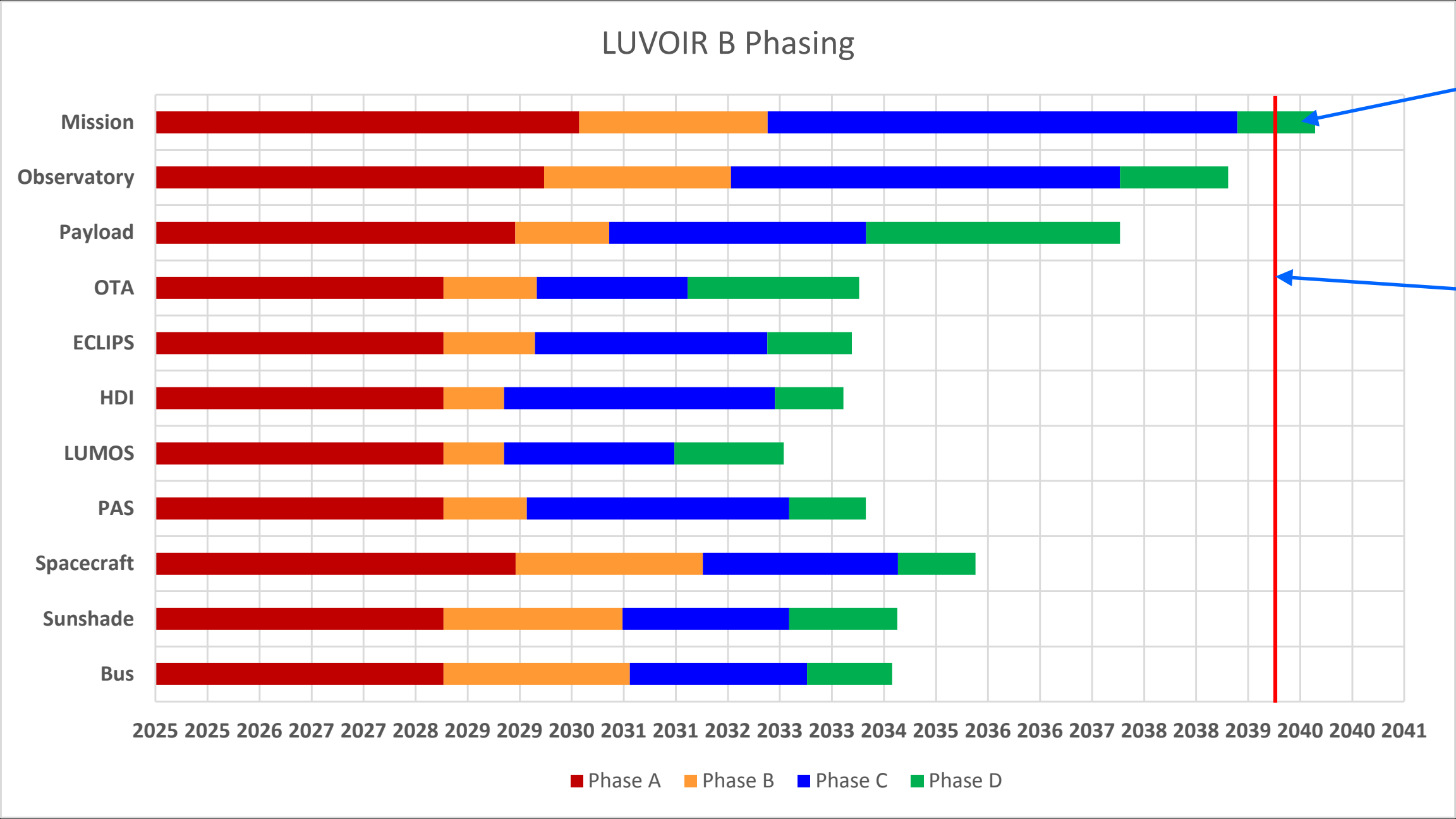

Technology Development

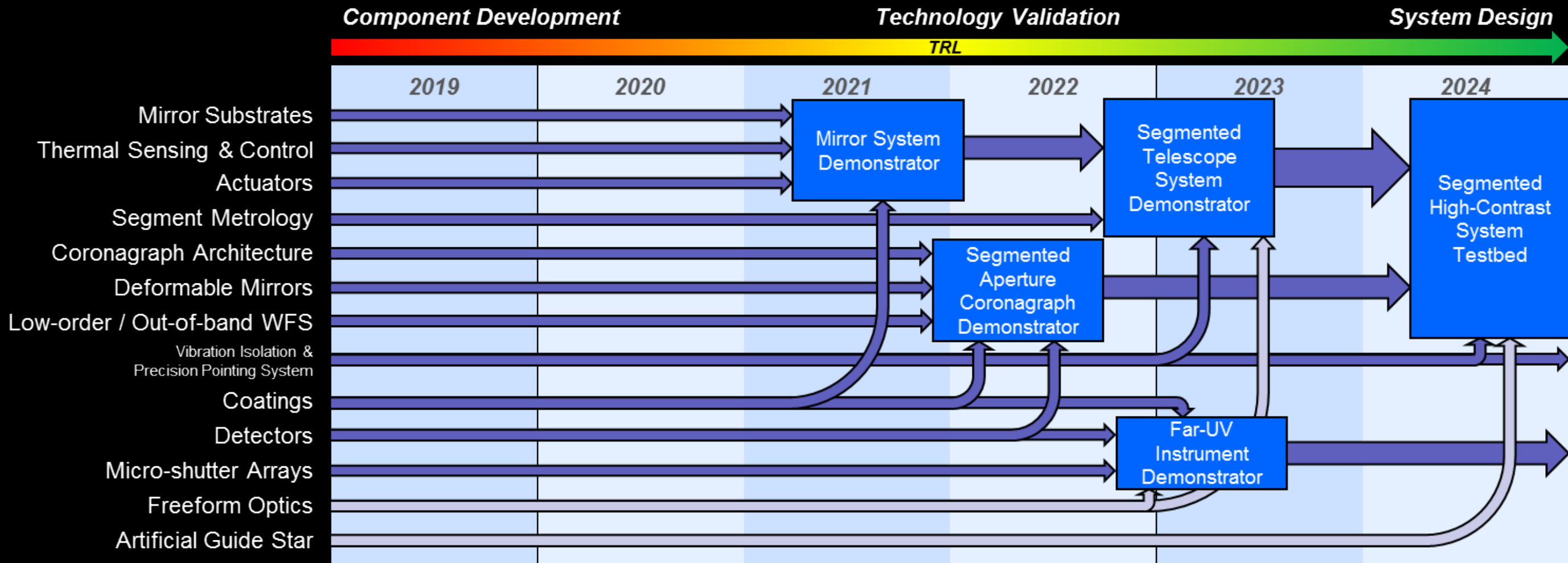
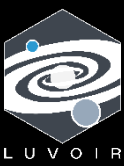

Decadal Decision
(expected)

Courtesy of Matt Bolcar (GSFC)

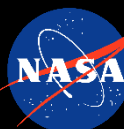

Future Work for the Study Team



- Complete any remaining engineering work
 - Continue to refine LUMOS A
 - Frequency analysis optimization
 - Jitter analysis
- Complete writing the final report for NASA HQ and the decadal survey team.
- Outside of the Study Team, technology development is continuing both at NASA and with our industry partners.

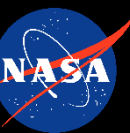

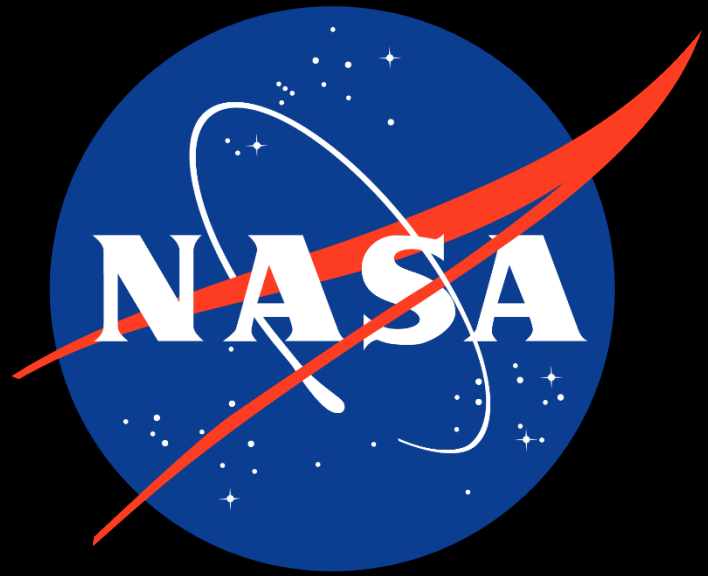

Goddard
SPACE FLIGHT CENTER

