



NASA – GRC Materials Research Activities in High Voltage High Frequency Power Transmission Systems for Electrified Aircraft

Maricela Lizcano¹, Eugene Shin², Andy Woodworth¹

¹NASA-GRC, ²Ohio Aerospace Institute

IAPG Electrical Systems Working Group Meeting

March 27-29, 2019

U.S. Army Research Laboratory South/University of Texas at Austin Commons
Conference Center Austin, TX



Unique High Voltage Power Transmission Application Light Weight High Voltage

Aeronautics Research Mission Directorate (ARMD)
 Transformative Aeronautics Concepts Program
 Convergent Aeronautic Solutions (CAS) Project
 Transformational Tools and Technology Project

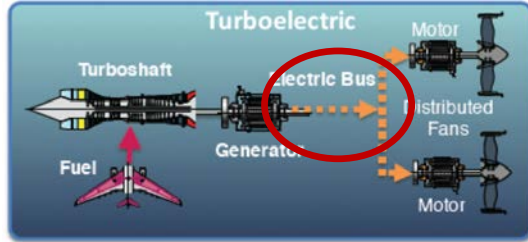

Notional Current Technology Description

Combination of power and frequency make this a unique application space. Current high voltage cable technology is not suitable for high altitude operation.

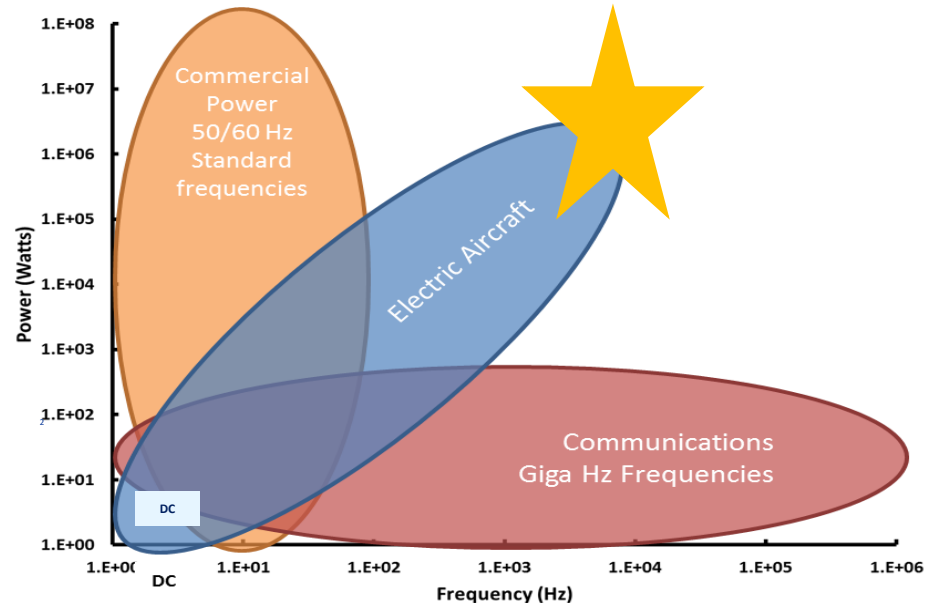

HV Hybrid Electric Propulsion (HVHEP) Architecture

Future Aircraft will require ~10-20 MW power distribution

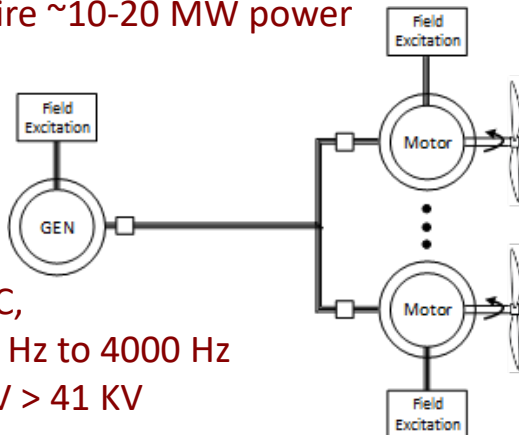

High Voltage, 3-Phase AC,
 Variable Frequency 400 Hz to 4000 Hz
 $V_{max} = 20 \text{ KV}$ Design for $V > 41 \text{ KV}$



Key Findings: HVHEP Convergent Aeronautics Solutions Task

- Need New Test Methods and Component Level Test Capabilities
 - Current Test Methods are insufficient
 - Altitude/ Environment replication critical
- Materials Development + Modeling Tools
 - Best Design
- Material Technology Development
 - Corona resistant materials
 - 2-D EMI Shielding
 - Composite conductors
 - Dielectric insulation
- Decrease materials stresses (Thermal, Electrical, Mechanical)
 - increase performance life
- Foster collaborations with industry and universities
 - Industry Provides Integration Paths
 - University Led Materials Research
 - Develop Testing Standards

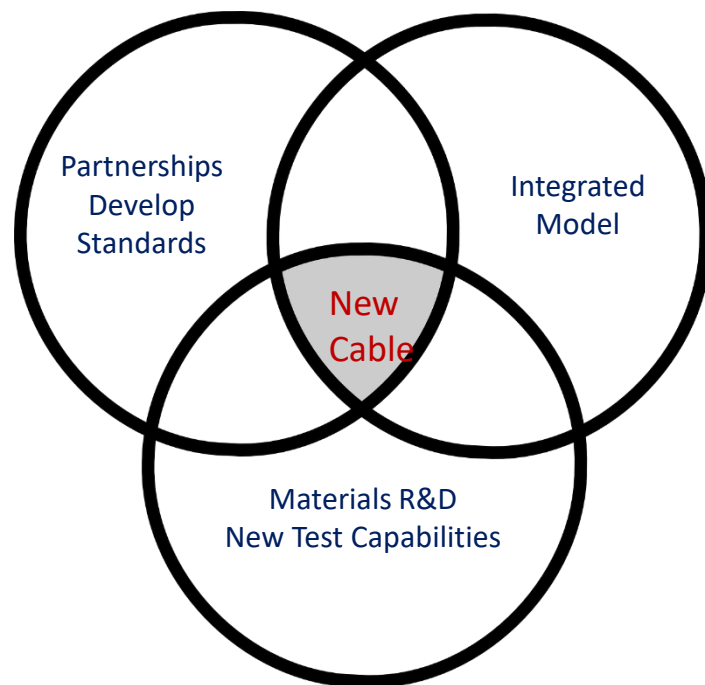



NASA Glenn Research Center Materials and Structures Division Test Capabilities Build Up

High Voltage Test Capabilities Build-Up

New FY18 TACP/ Transformative Tools and Technology Project Research Area Funded:

- Build HV Multi-stress Environmental Test Chamber Capability (2-3 Years)
- Demonstrate a 1-5 kV Power Transmission Cable (3-5 Years)
- Draft Standard Test Method of High Altitude High Voltage Power Transmission Insulation Materials/Cables (5 years)

Eaton High Voltage Test Setup

- Small sample to component testing
- ASTM testing at RT in oil or air
- 50 Hz and 60 Hz
- AC= 60 KV_{max} DC 84 KV_{max}

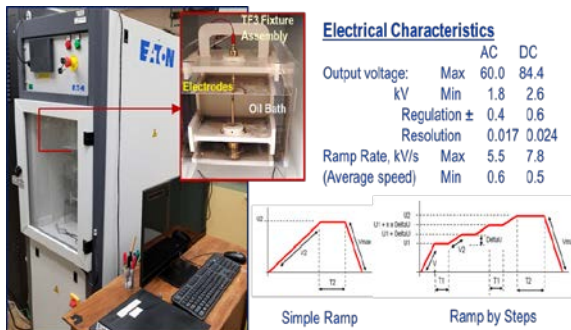

GRC Corona Material Evaluation Testbed (CoMET)

- Components up to 40 kV, 2 MHz
- Replicate flight conditions (P, T, RH, vibration etc.) during testing
- Vibration Chamber in Coordination with NASA GRC Structure Dynamics Branch

Acrylic Chamber

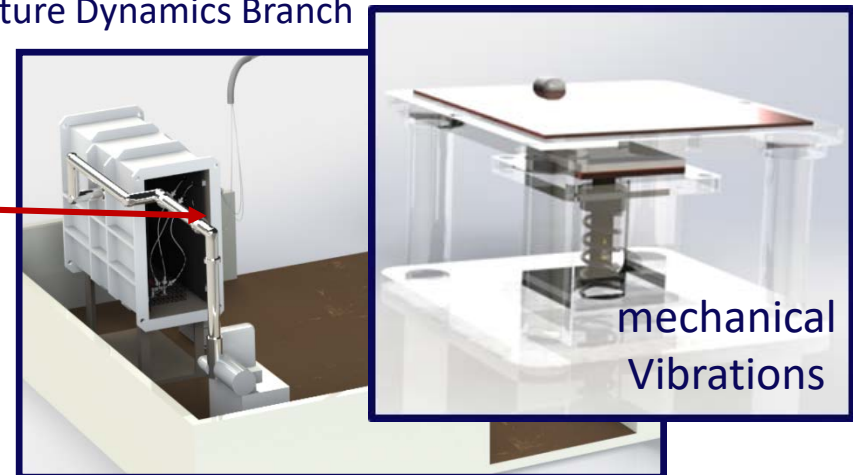

Chamber Build up Status:

- Site Preparation complete
- All components received except acrylic Chamber and Oscilloscope
- Collaborating with Ohio State University, Dr. Wang (HV power electronics) and Dr. Zhang (AC Electric Machines) to help with design and test validation with their High Voltage Lab



Pulsed Electro Acoustic Analysis



LeCroy Oscilloscope

HP Keyboard and Monitor

Barth 50W Impedance Matching Network

Pulse Generator

HVDC Power Supply

Electrostatic Voltmeter

AC Power Conditioners (2)

Designed and built by
Lee Pearson

lee.pearson@boxelderinnovations.com

Tony Pearson

tony.pearson@boxelderinnovations.com

Box Elder Innovations, LLC

Corinne, UT 84307

435-744-1014

www.boxelderinnovations.com

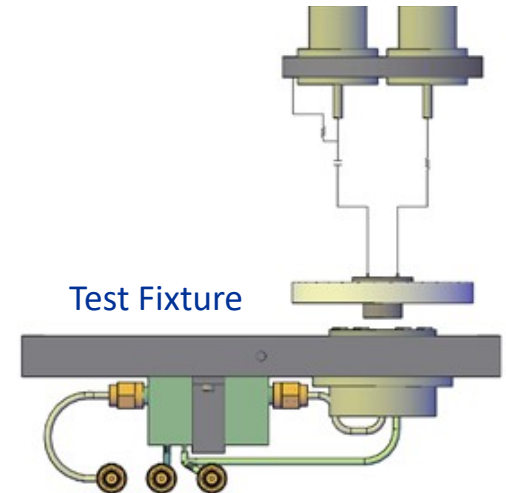

PEA Basic Method Description

- DC and pulsed electric fields applied across dielectric film
- Charge is induced on each electrode
- Waves are generated by each charge layer, induced and embedded, from electric field impulse and contribute to the full waveform
- Piezoelectric sensor is used to detect the wave generated by the electric field pulse
 - Polyvinylidene Fluoride (PVDF) is a plastic piezoelectric material

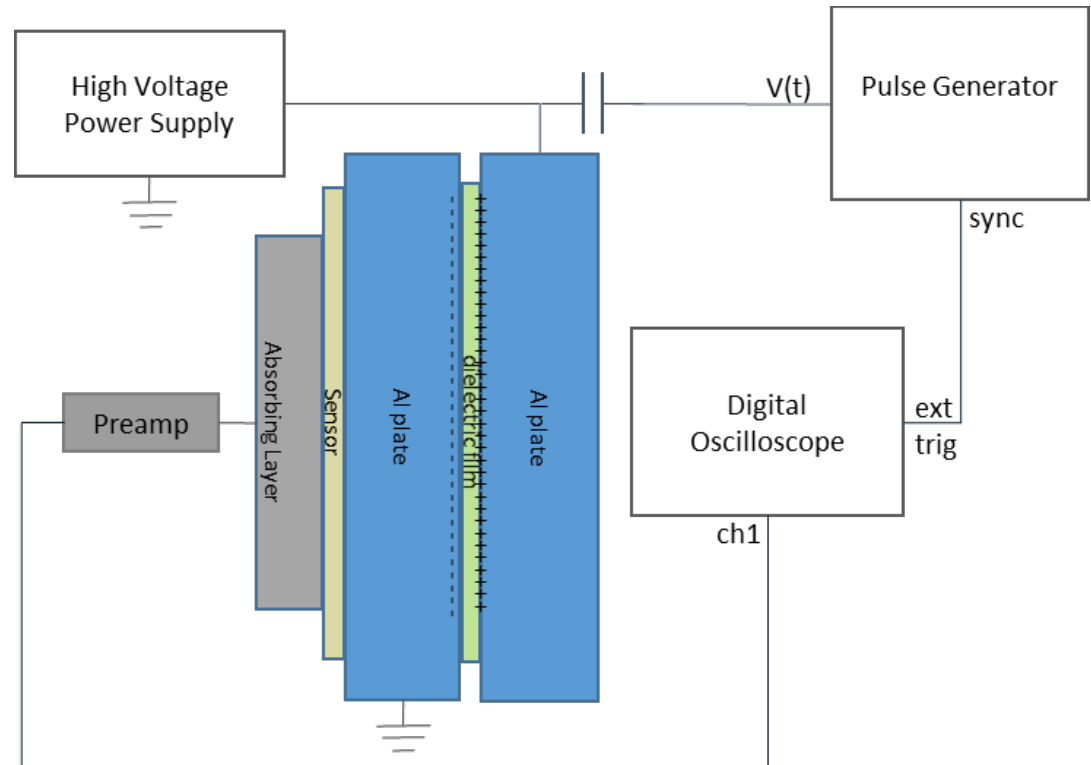

Power Transmission Cable Development Approach

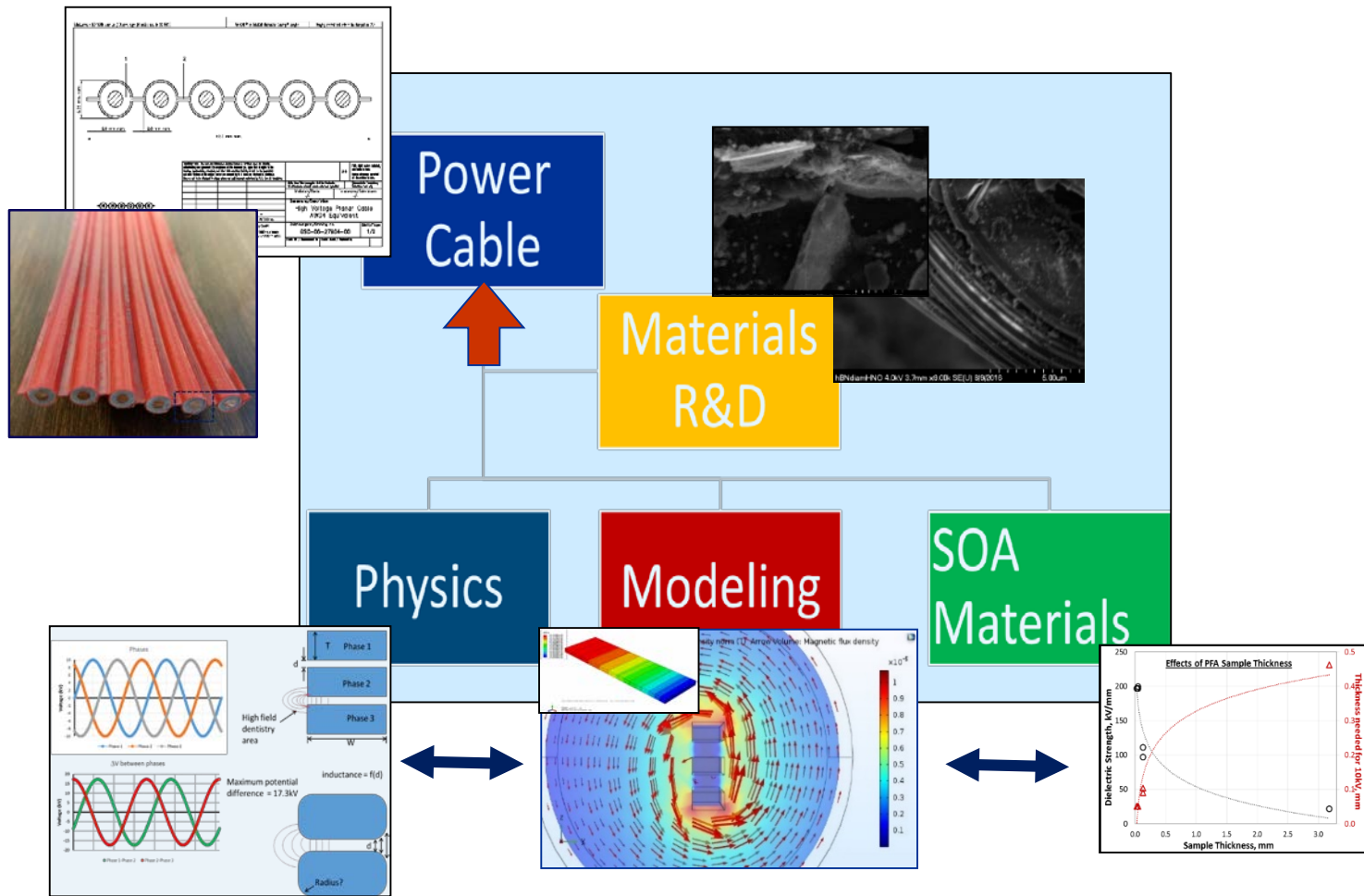

SOA Materials Research

Micro-Multilayer Multifunctional Electrical Insulation (MMEI) System

Multilayered structures of well-known polymer insulation films, e.g., Kapton PI and PFA as bond layer, significantly improved dielectric breakdown voltage (V_B), if well-bonded;

MMEI structures can incorporate multifunctionalities by the nature of their design capabilities, such as Corona PD resistance, moisture barrier, EMI shielding, thermal management, and mechanical durability, etc.

- Polyimide Sample BS12
- 3-layers
- 0.38 mm thick
- $V_B=38$ kV
- Polyimide Sample BS22
- 19-layers
- 0.38 mm thick
- $V_B=46$ kV

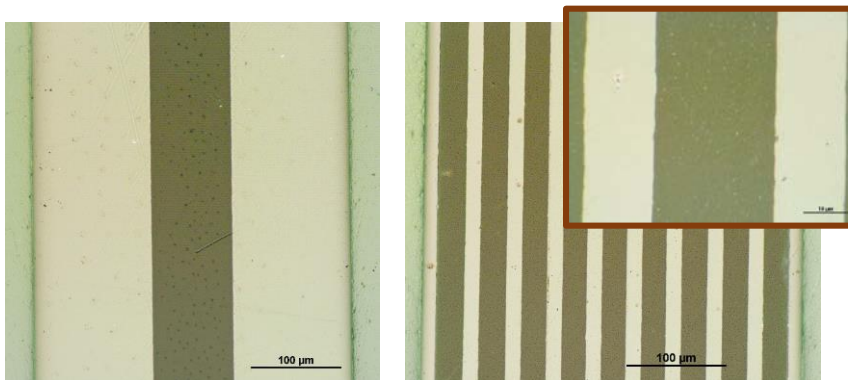

Heat Fuse-Bonding with excellent bonding integrity

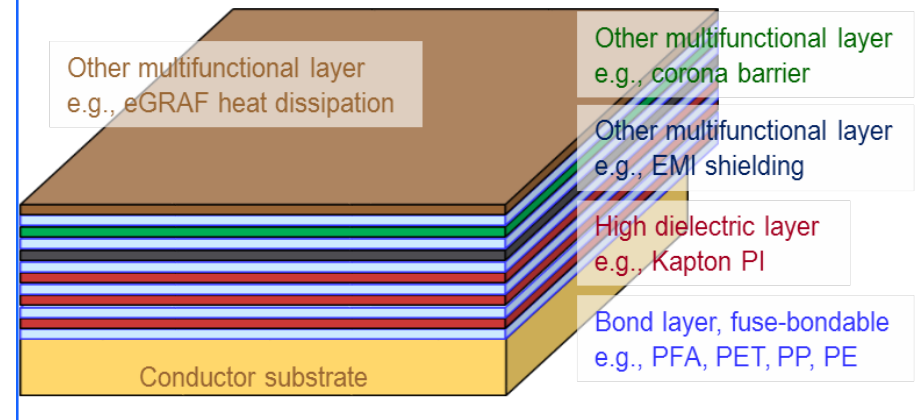

- Kapton PI film alone, 0.38 mm thick, $V_B=29$ kV
- PFA film alone, 0.38 mm thick, $V_B = \sim 27$ kV

PEA Results on 5 Layered Insulation 14 hr Test at 9 KV

3 Layered Sample
Cross section

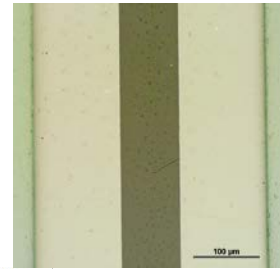

current density
mapping over time

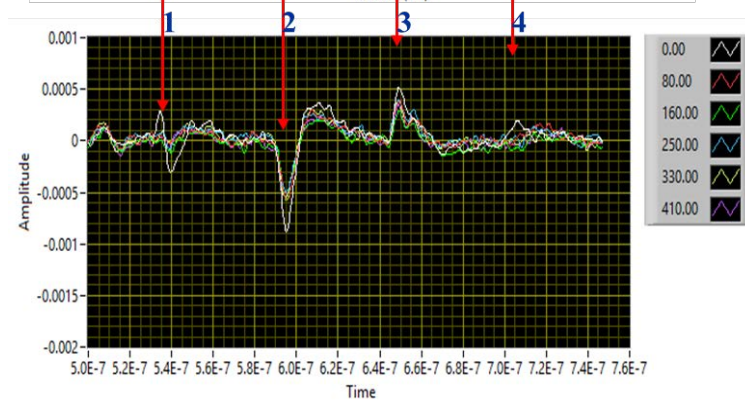
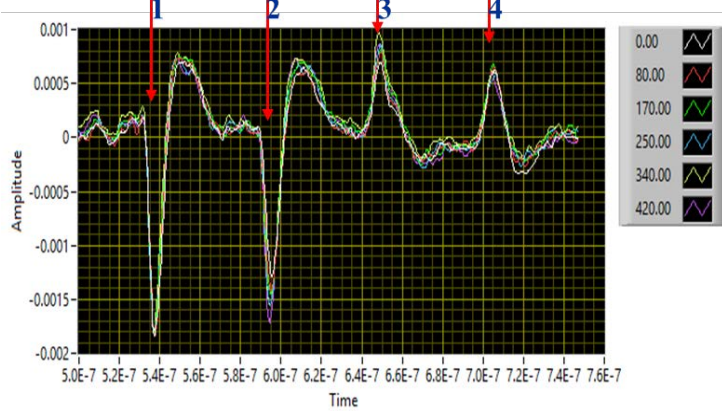
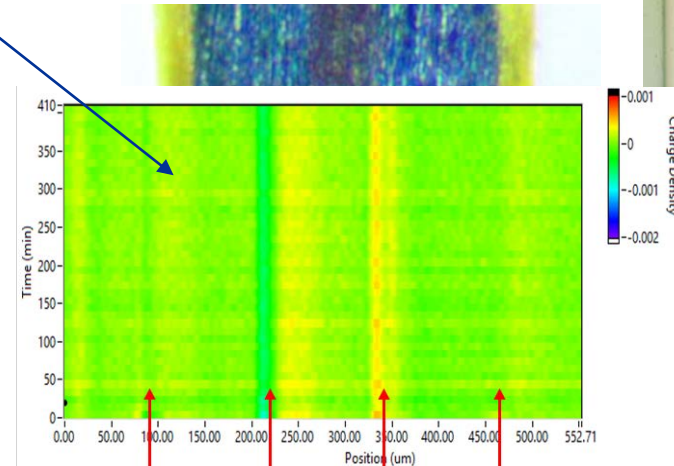
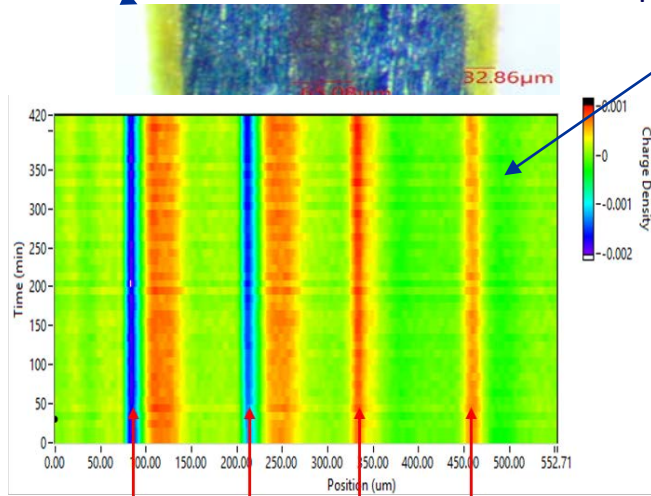

First Half (7 hr, 9 kV)

Second Half (7 hr, 0 kV)

PEA Results on 19 Layered Insulation

2 hr Test at 9 KV



PEA Peak Amplitude vs Time



No change in peak amplitude was seen over time under DC voltage, indicating that no sample charging occurred.

Peaks are multiple reflected waves or waves from polarization charge built up between layers, some of which are overlapping waves.

19 Layered Sample
has $V_b=46$ KV

Charge Density Mapping over time

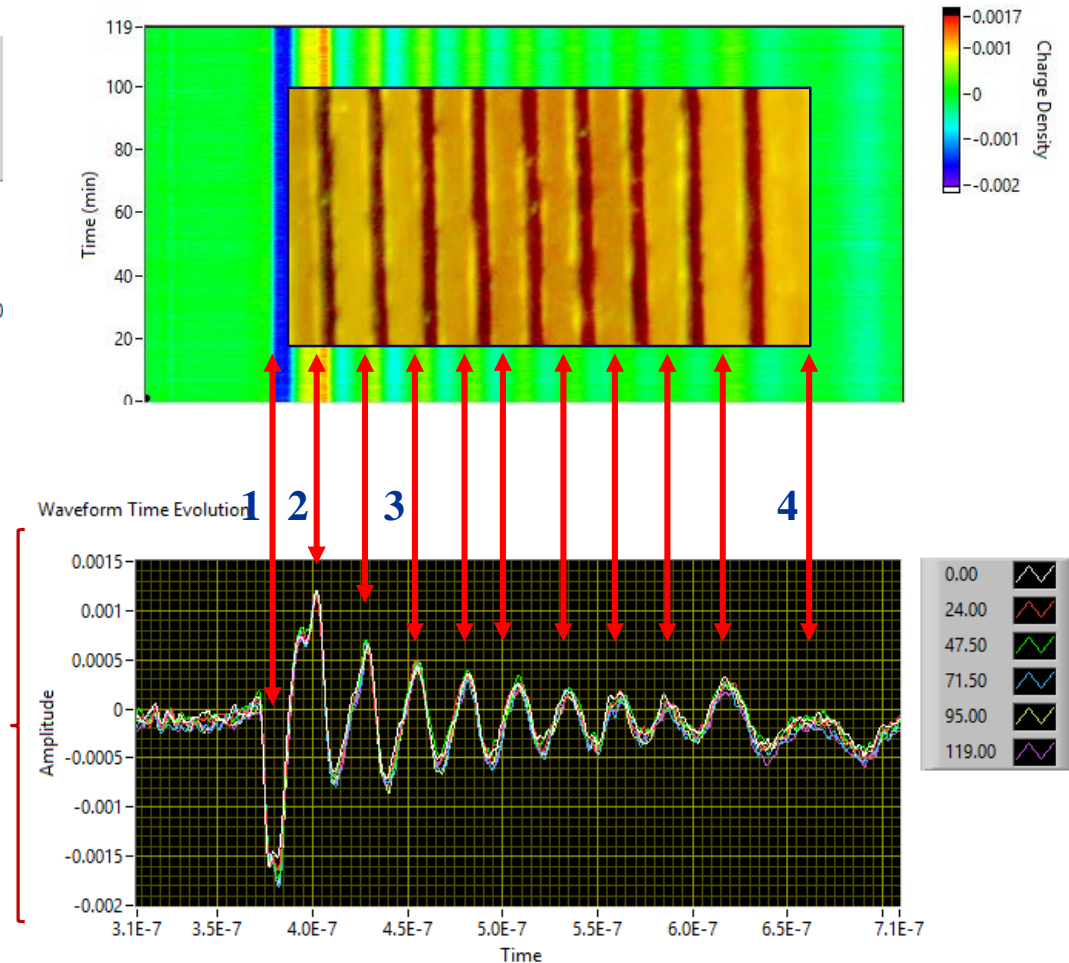

PEA Results for MMEI 19 Layered Sample

7 Hours at 8.5 kV

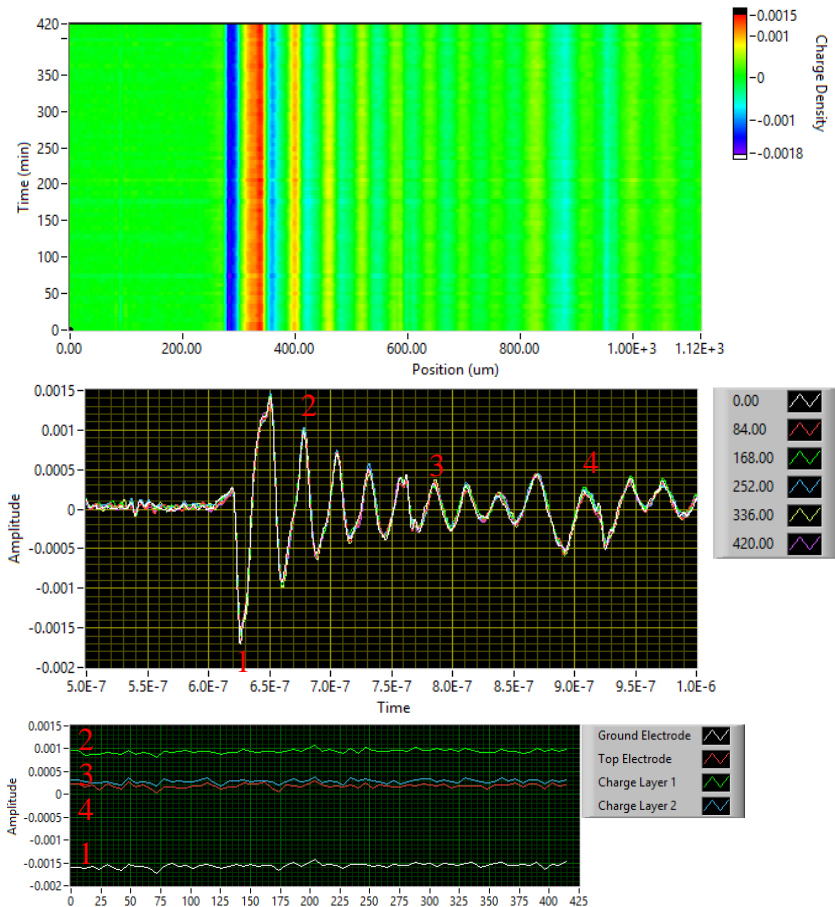

Peak amplitude does not change during test.
Standing waves superposition between layers each charge layer generates two layers

7 Hours at 0 kV

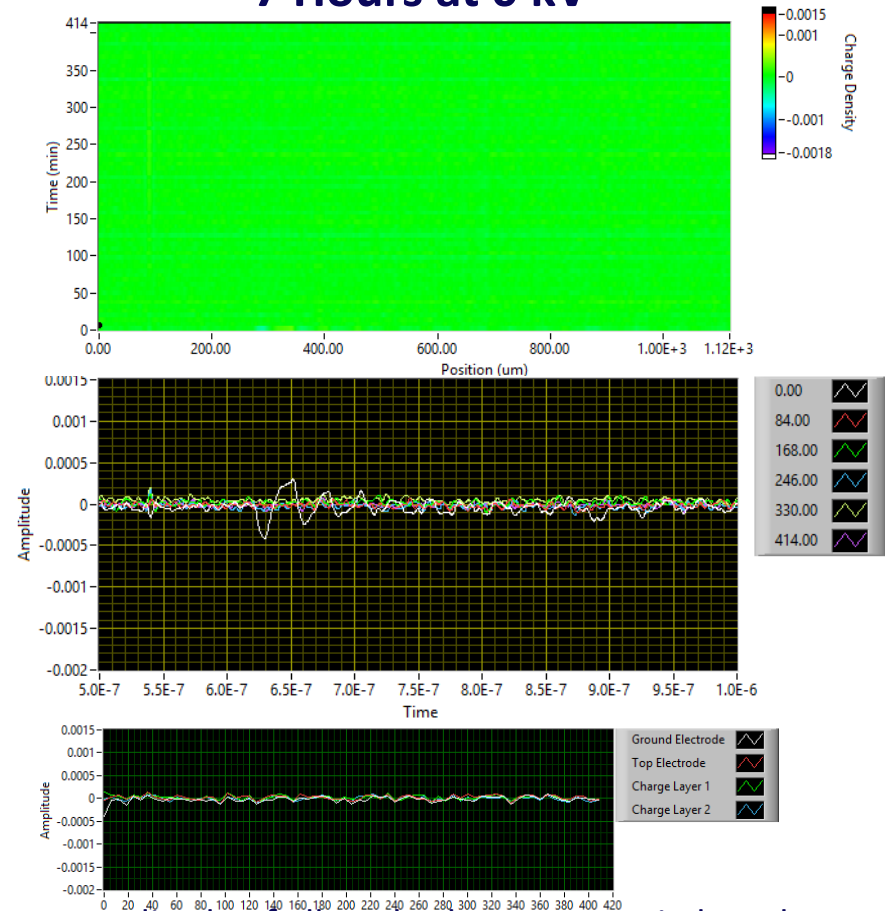

Amplitude of all peaks drops to zero in less than 10 min after voltage shut off. The relaxation time of the sample is less than 6 minutes.

Modeling Tool Development

Electromagnetic Model Coupled to Electro-Thermal Model

- Consol based model accurately reproduces frequency skin depth effects
 - Current densities
 - Frequency dependent resistance
 - Decrease in current (constant voltage) with increasing frequency
 - Validates the handling of electromagnetic fields in the conductors
- Paves the path for
 - Cable loss determination (efficiency of the cabling system)
 - Hotspot determination (maximum operating temperature)
 - Aging effects
 - Spatial electric field density necessary for determining
 - Potential for partial discharge
 - Electrical Insulation requirement
- Next step is to couple EM model with TE model. Expected completion end of Dec 2019.

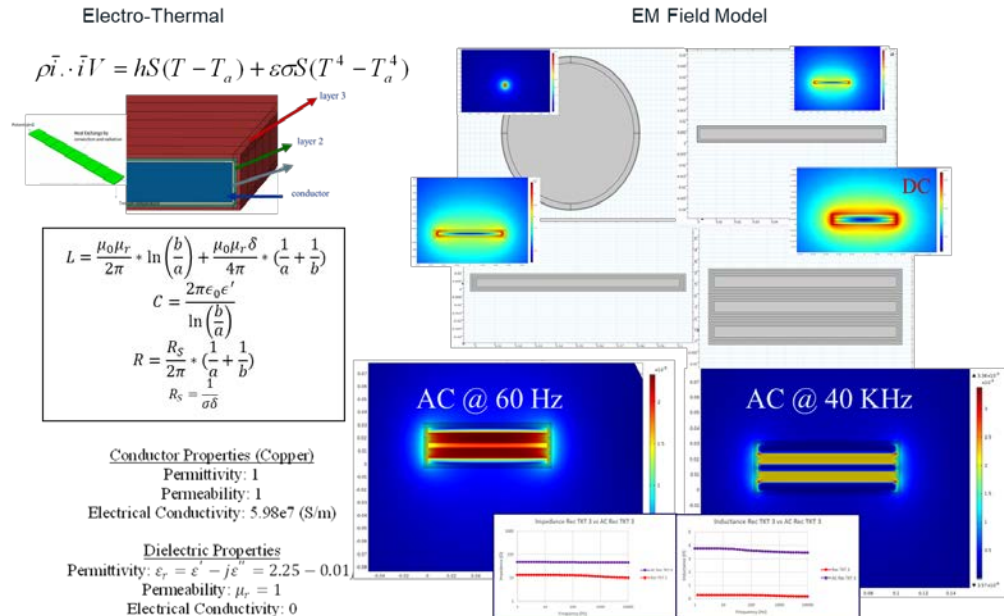

Direct current to 5kHz constant current

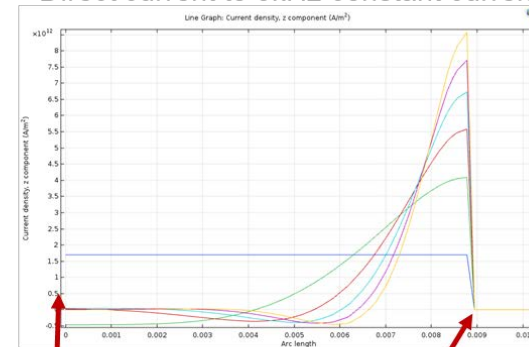

Conductor center

Conductor edge

Commercial Benefit/Applicability of MMEI Structures

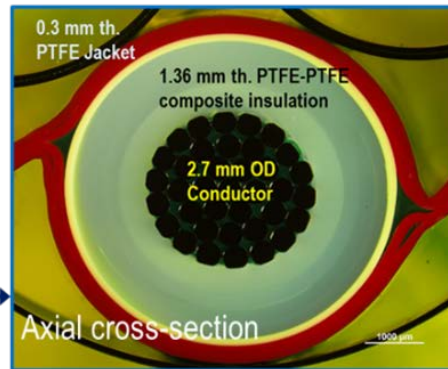

Gore Flat Cable Pod

Cross-section

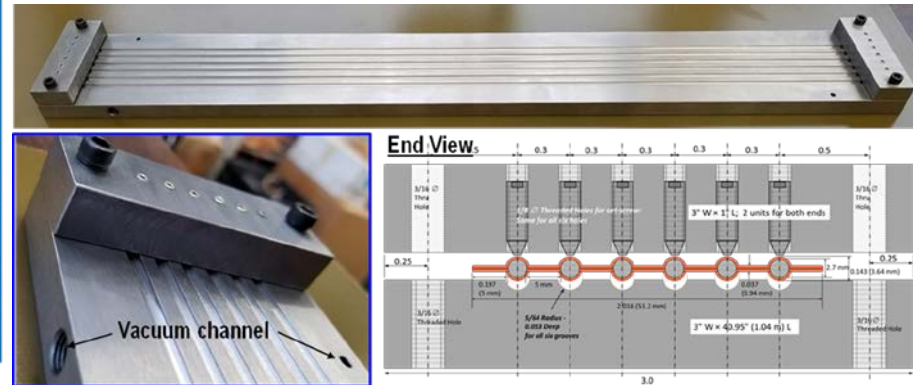

GRC In-house cable fixture

HV HP Flat Pod Cable with GORE

- Unique design to carry 0.25 MW at 15 kV (but rated to 40 kV), for -80 °C to >260 °C use temperature
- Consisted of six identical conductor pods insulated by the GORE's proprietary PTFE-PTFE composite and arranged horizontally by a corona resistant PTFE jacket
- Efforts to apply MMEI system on the Pod cable using in-house fixture.

Applicability of MMEI Structures to Bus Bar

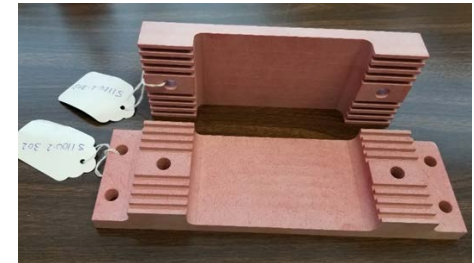
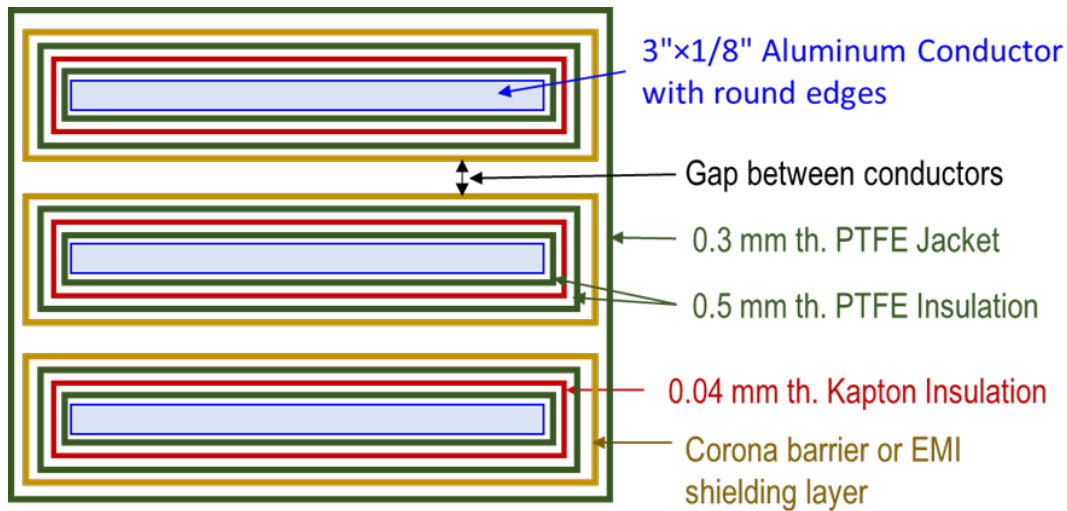

HV high frequency **bus bar** with MERSEN

- A three-phase system for 1 MW up to 10 MW operating power with operating voltage of 20 kV (designed for 40 kV), high frequency (400 Hz up to 4000 Hz), and temperature up to 180 °C
- MMEI system to be applied to blank conductors for direct performance comparison



Power Transmission Take Away

- High Voltage is the biggest challenge
 - Can't take advantage of large distances and heavy systems (over design) other HV systems can use (terrestrial, ships and trains)
 - Thermal is a life time limiting issue and will have be dealt with eventually
- Testing Important:
 - Multi scale testing is necessary
 - coupon
 - component/subsystem
 - system
 - Must test like you fly
 - multi-stress environment
- Potential disruptive technology of MMEI system
 - Thin, lightweight, and durable structures
 - Multifunctional structures including corona resistance, moisture barrier, EMI shielding, and thermal management
 - Applicable to various full-scale power transmission, e.g., power cable, bus bar, inter-connect, etc.

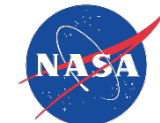

Where Do we Go From Here?

Utilizing Machine Learning Concepts

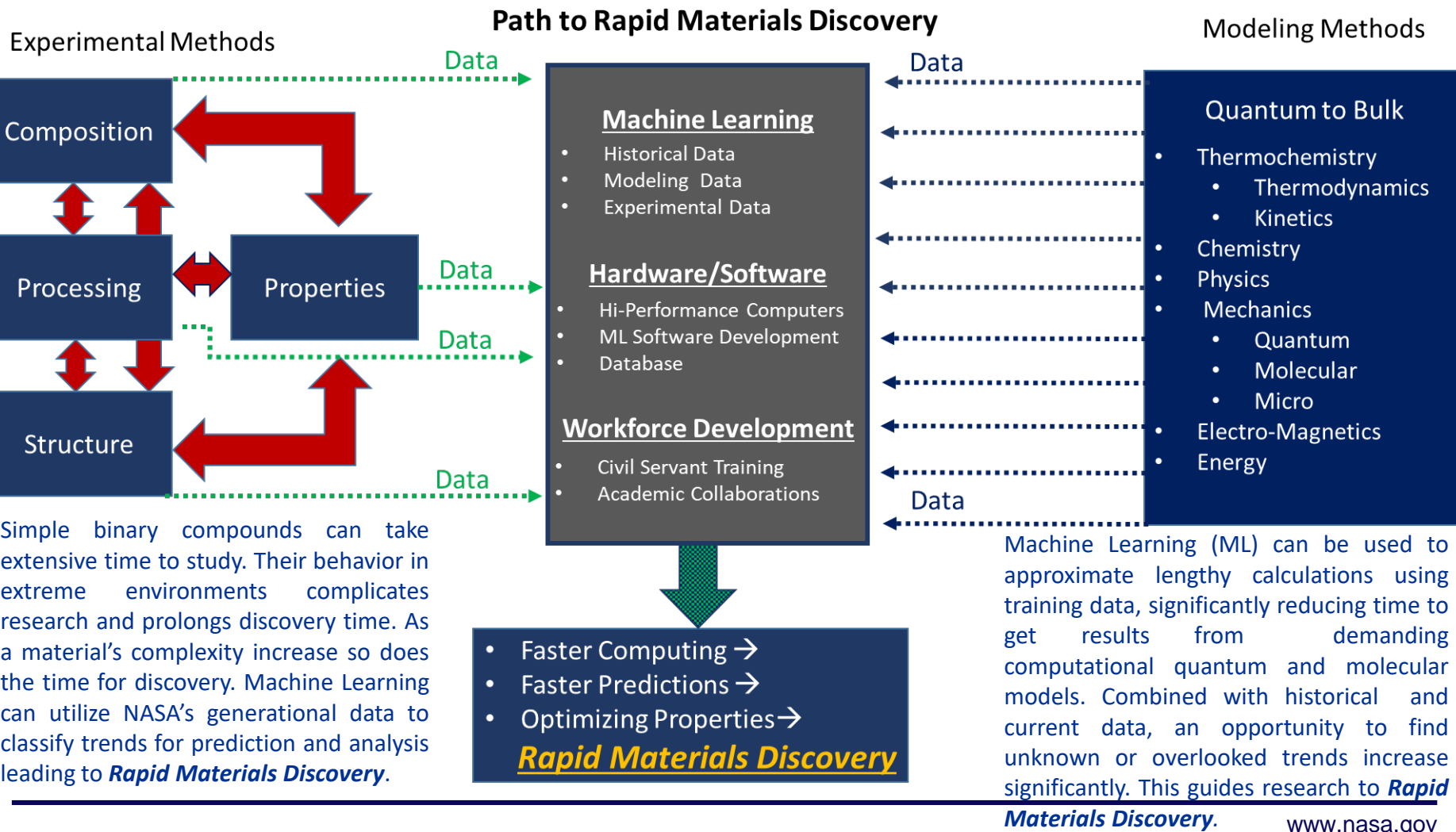



Thank You!

maricela.lizcano@nasa.gov