

# Predicting Aircraft and Spacecraft Acoustics<sup>\*</sup>

\* partially funded by NASA's  
HEOMD and ARMD projects

Cetin Kiris, Mike Barad, Jeffrey Housman  
Francois Cadieux, Gerrit Stich, Joseph Kocheemoolayil

Computational Aerosciences Branch  
NASA Ames Research Center

Supercomputing 2018 (SC18) Conference,  
November 12-16, 2018, Dallas, TX

# Outline



- **Motivation**
- **LAVA Framework**
- **Launch: Kennedy Space Center Infrastructure Redesign**
  - Ignition over-pressure waves
- **Ascent: Orion Multi-Purpose Crew Vehicle Launch Abort System**
  - Transient pressure loads
- **Vehicle Aerodynamics: Low-Boom Flight Demonstrator**
  - Jet noise
- **Propeller Noise: Small UAS Acoustics**
  - Validation for moving geometry and tonal noise computation – Lattice Boltzmann
- **Fan Noise**
  - R4 Source Diagnostic Test - Toward Fan Broadband Noise Prediction

# Motivation



- ✓ **Increase predictive use of computational aerosciences capabilities for next generation aviation and space vehicle concepts.**
  - The next frontier is to use wall-modeled and/or wall-resolved large-eddy simulation (LES) to predict:

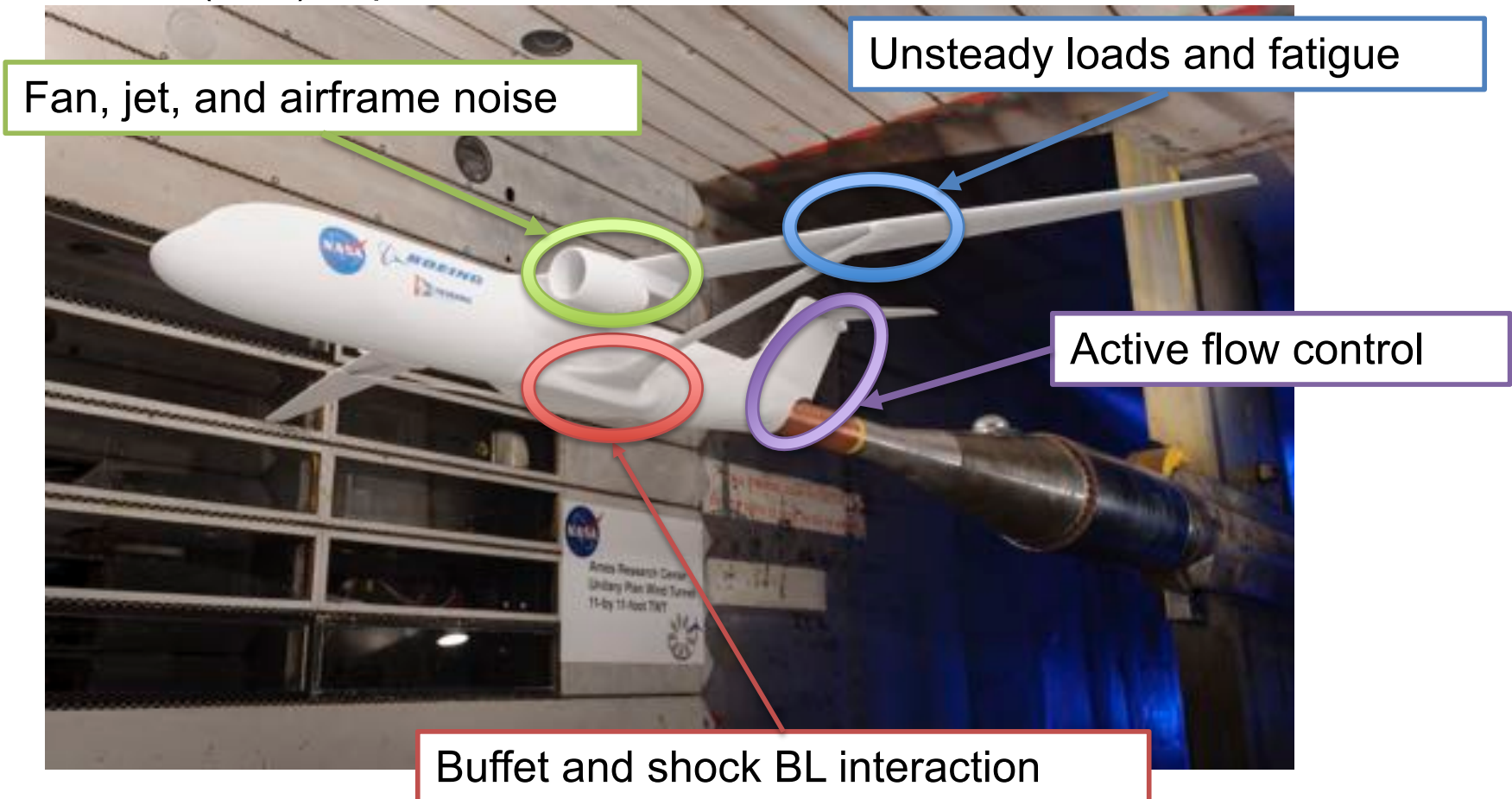

# Challenges in Computational Aero-Acoustics



## ✓ Grid Generation

- Structured Cartesian, Unstructured Polyhedrals, Structured Curvilinear; each paradigm has its own pros and cons → flexibility to pick best suited approach
- Remains a bottleneck → automation and solution-adaption

## ✓ Resolving/Modeling Turbulent Scales

- Resolving thin wall-bounded turbulence is too computationally costly for most aerospace applications → hybrid methods & wall-models
- Resolving all relevant scales of turbulent motion away from walls is also prohibitive → Higher order less dissipative numerics & subgrid-scale modeling

## ✓ Computational Requirements

- Space and time resolution requirements for acoustics problems are demanding.
- Explore revolutionary approaches to reduce computational time to reach converged statistics and spectra like Lattice-Boltzmann

# Computational Grid Paradigms



*Structured Cartesian AMR*

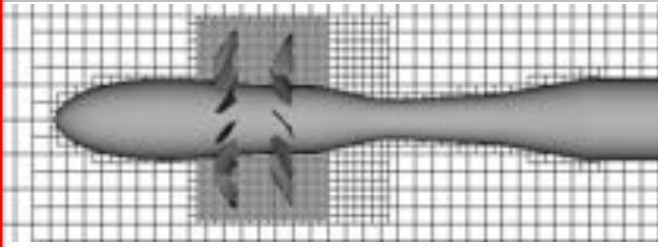

- Essentially no manual grid generation
- Highly efficient Structured Adaptive Mesh Refinement (AMR)
- Low computational cost
- Reliable higher order methods
- **Non-body fitted -> Resolution of boundary layers inefficient**

*Unstructured Arbitrary Polyhedral*

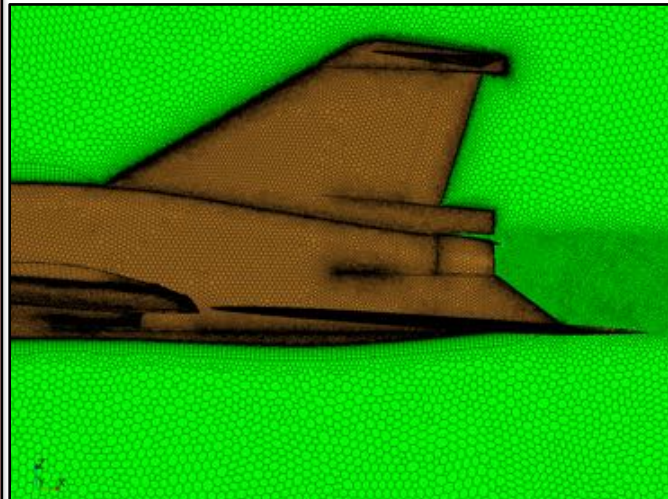
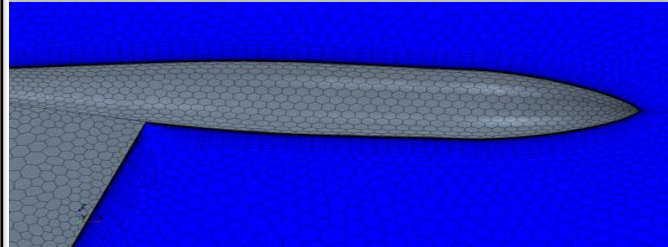

- Partially automated grid generation
- Body fitted grids
- **Grid quality can be challenging**
- **High computational cost**
- **Higher order methods yet to fully mature**

*Structured Curvilinear*

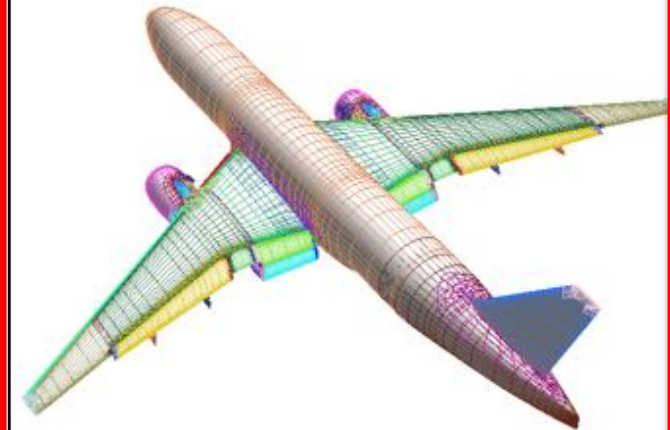
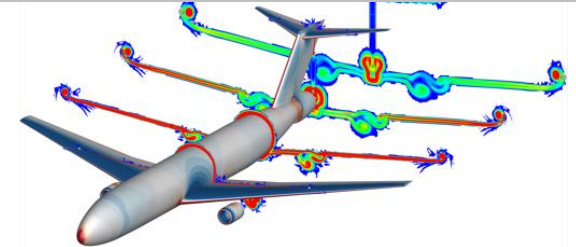

- High quality body fitted grids
- Low computational cost
- Reliable higher order methods
- **Grid generation largely manual and time consuming**



## LAVA Framework

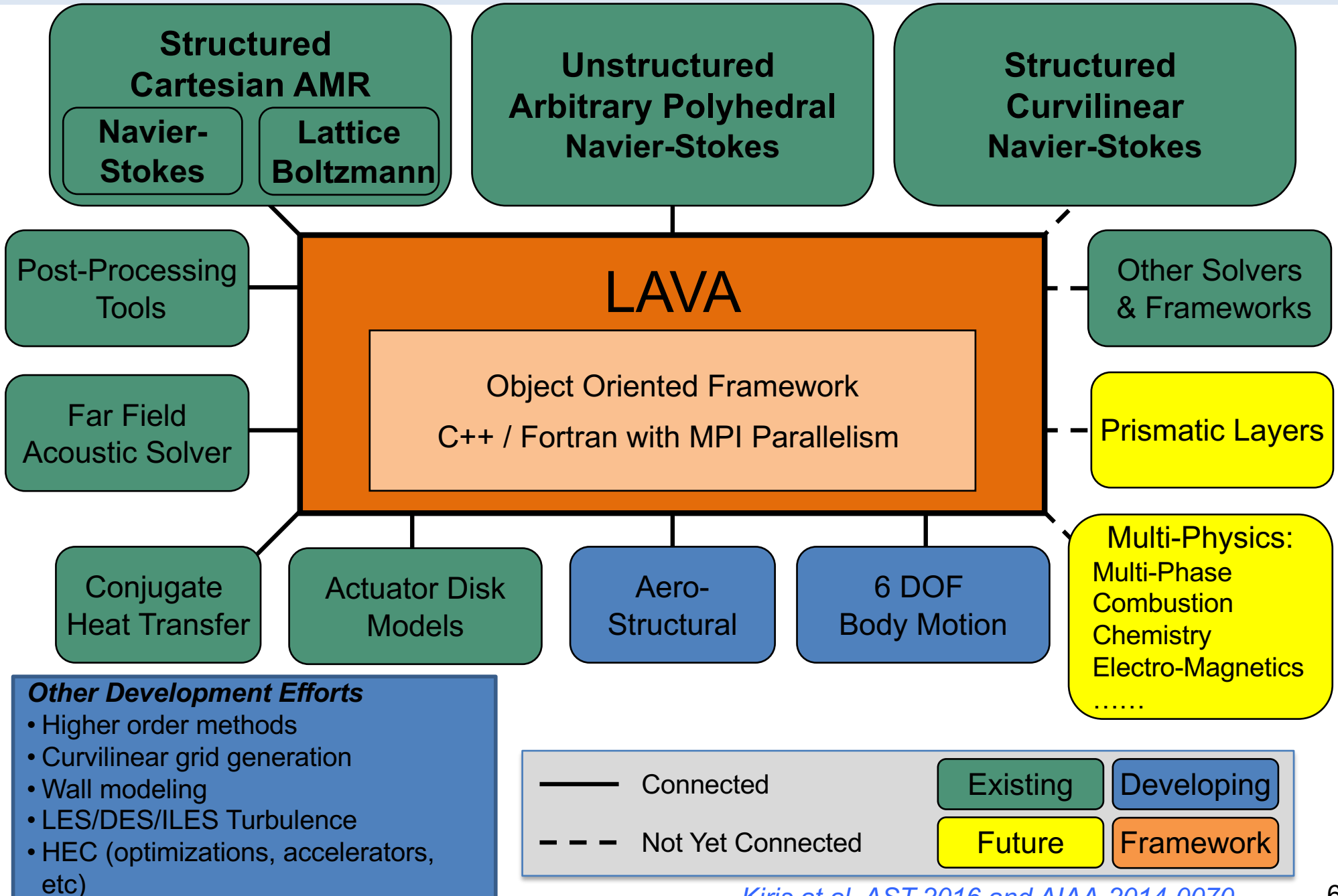

# Outline



- **Motivation**
- **LAVA Framework**
- **Launch: Kennedy Space Center Infrastructure Redesign**
  - Ignition over-pressure waves
- **Ascent: Orion Multi-Purpose Crew Vehicle Launch Abort System**
  - Transient pressure loads
- **Vehicle Aerodynamics: Low-Boom Flight Demonstrator**
  - Jet noise
- **Propeller Noise: Small UAS Acoustics**
  - Validation for moving geometry and tonal noise computation – Lattice Boltzmann
- **Fan Noise**
  - R4 Source Diagnostic Test - Toward Fan Broadband Noise Prediction

# Launch Environment Simulations



## SLS Exploration Mission 1

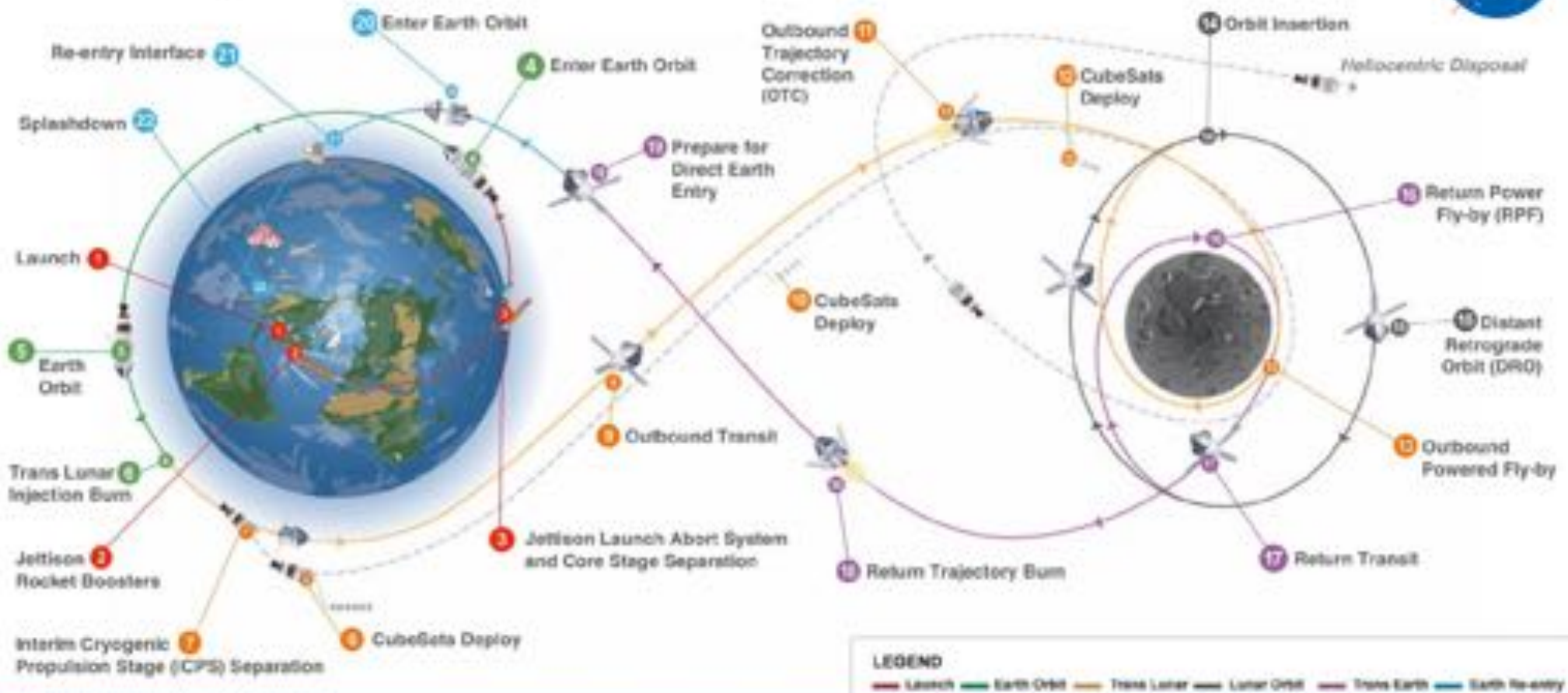

Total distance traveled: 1.3 million miles – Mission duration: 25.5 days – Re-entry speed: 24,500 mph (Mach 32) – 13 CubeSats deployed



# Kennedy Space Center's Pad 39B



<https://www.youtube.com/watch?v=9matDigB2w4>

After many years of harsh rocket launches, the Main Flame Deflector (MFD) at Kennedy Space Center has been upgraded in anticipation of flights of NASA's next generation Space Launch System. The new MFD has a much easier to maintain shingled steel surface.

# Flame Trench Redesign



Gaps between the MFD and the trench wall, and the gaps between the steel plates of the MFD itself could allow hot plume gases and strong acoustic waves to affect structures under the MFD.

High-resolution computational fluid dynamics (CFD) simulations have been carried out to help identify thermal, pressure, and flow environments on and around the geometrically complex MFD.



# Lessons Learned: Launch Environment



- Robustness is critical
- Compare early and often to any relevant experimental data
- Use the best tool for the deliverable

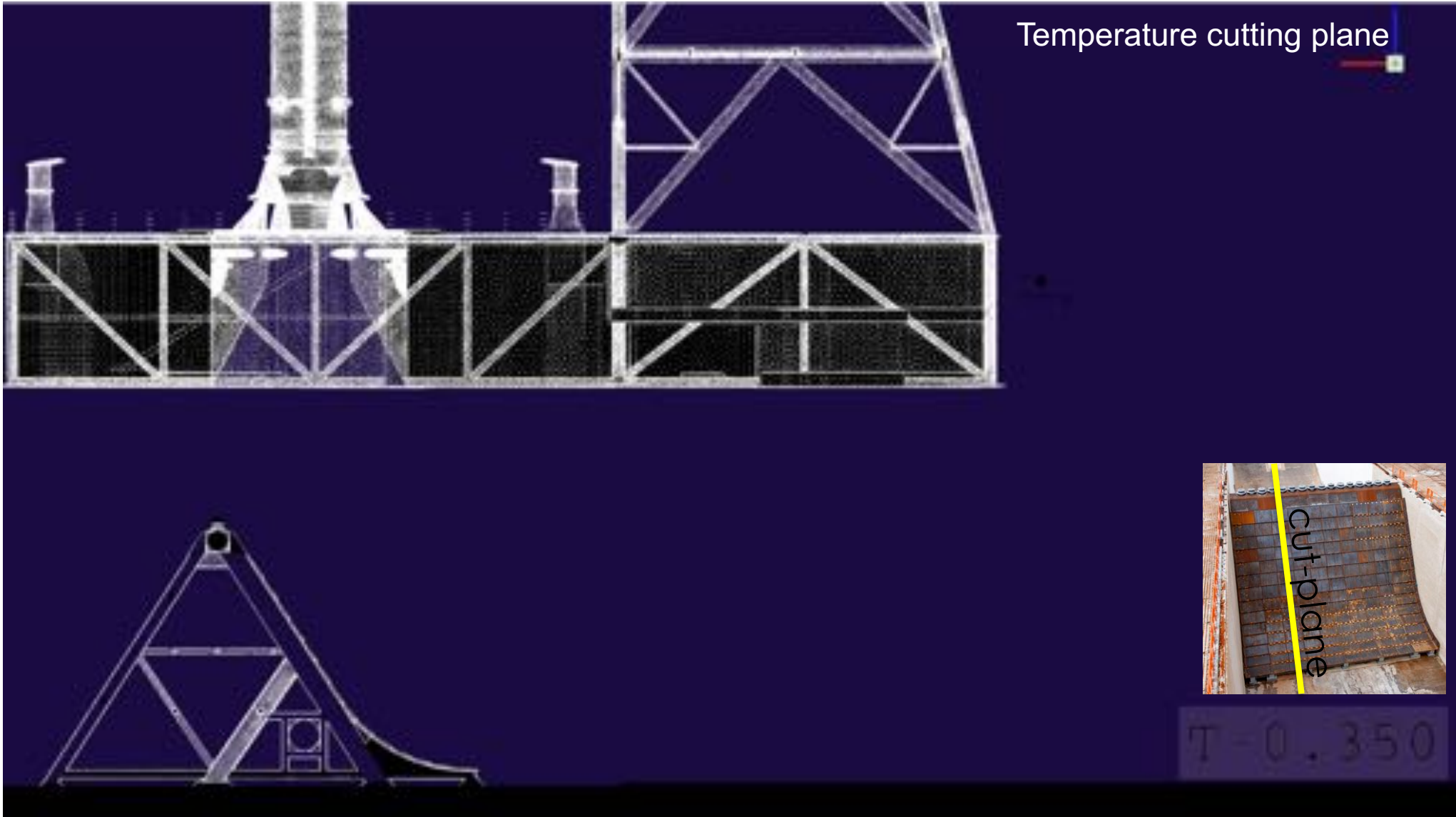

Temperature cutting plane

cut-plane

T-0.350

# Outline



- **Motivation**
- **LAVA Framework**
- **Launch: Kennedy Space Center Infrastructure Redesign**
  - Ignition over-pressure waves
- **Ascent: Orion Multi-Purpose Crew Vehicle Launch Abort System**
  - Transient pressure loads
- **Vehicle Aerodynamics: Low-Boom Flight Demonstrator**
  - Jet noise
- **Propeller Noise: Small UAS Acoustics**
  - Validation for moving geometry and tonal noise computation – Lattice Boltzmann
- **Fan Noise**
  - R4 Source Diagnostic Test - Toward Fan Broadband Noise Prediction



# ORION

## Launch Abort System (LAS)



# NASAfacts

### Ensuring Astronaut Safety

NASA is developing technologies that will enable humans to explore new destinations in the solar system. America will use the Orion spacecraft, launched atop the Space Launch System rocket, to send a new generation of astronauts beyond low-Earth orbit to places like an asteroid and eventually Mars. In order to keep astronauts safe in such difficult, yet exciting missions, NASA and Lockheed Martin collaborated to design and build the Launch Abort System.

# ST1 Launch Abort Motor Test



Picture of ST1 test at Orbital ATK facility in Utah for comparison



# Post Abort Motor Test Validation



Ignition Overpressure (IOP) versus Time

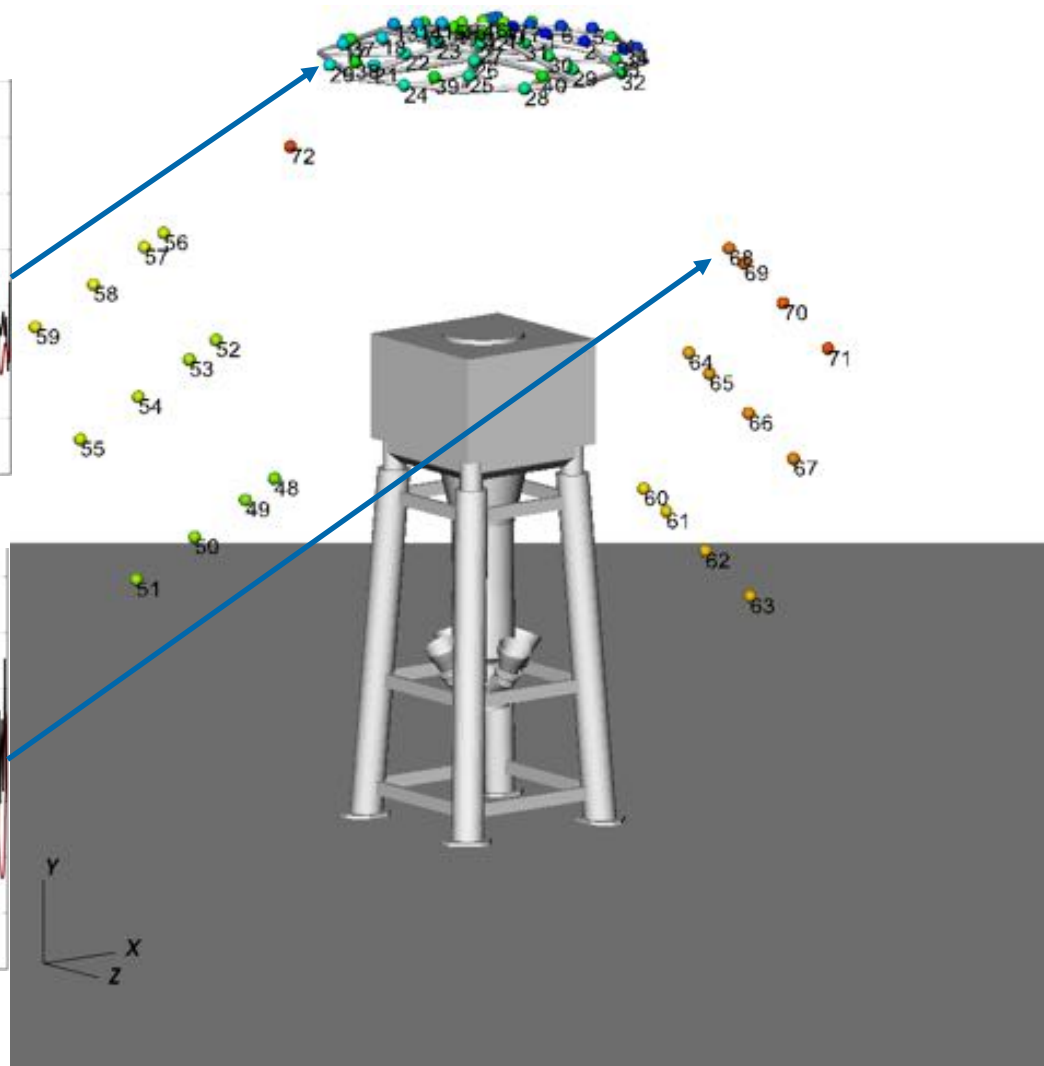
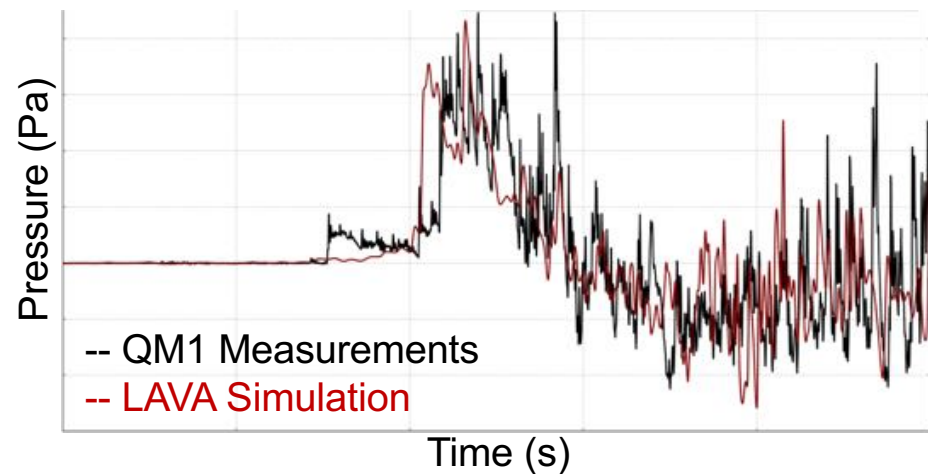
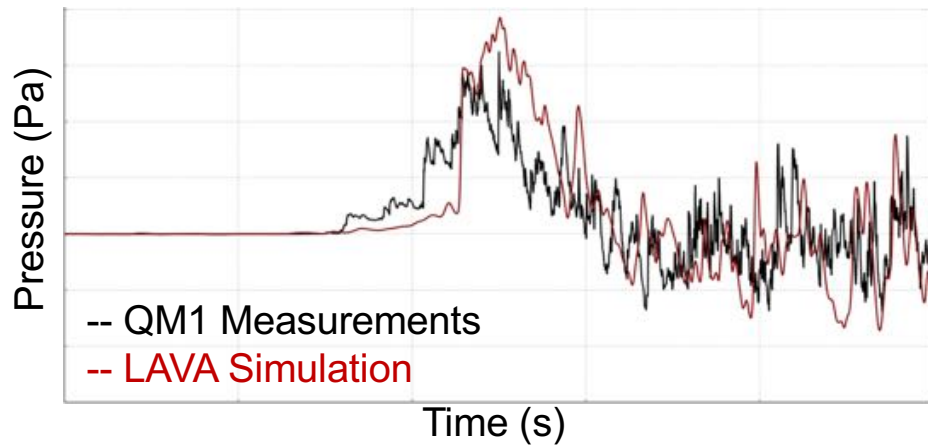

# Wind Tunnel Validation



-- Wind Tunnel Measurements  
-- LAVA Predictions

Third-Octave Spectra for Sensor K059, df=3.6Hz

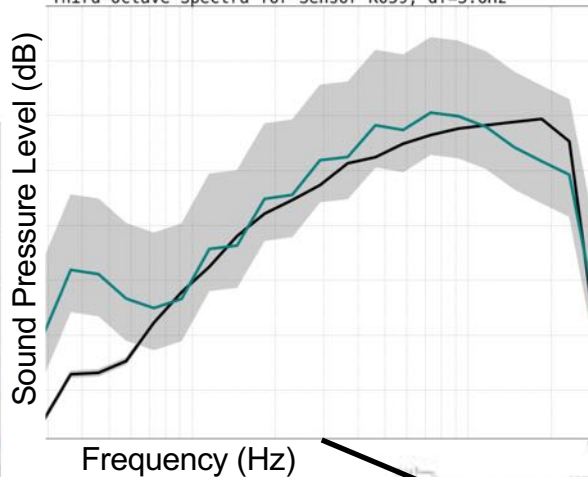

Third-Octave Spectra for Sensor K117, df=3.6Hz

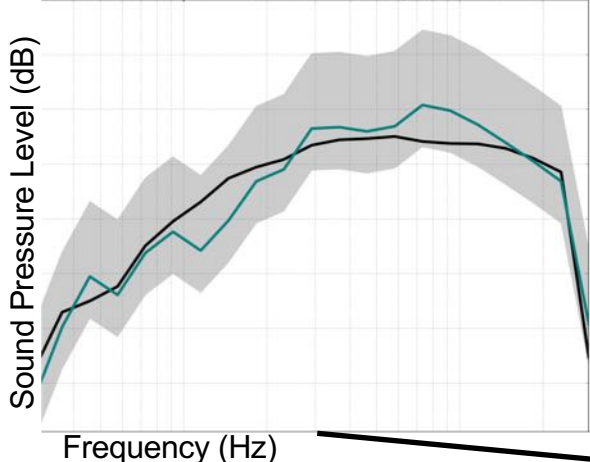

Third-Octave Spectra for Sensor K173, df=3.6Hz

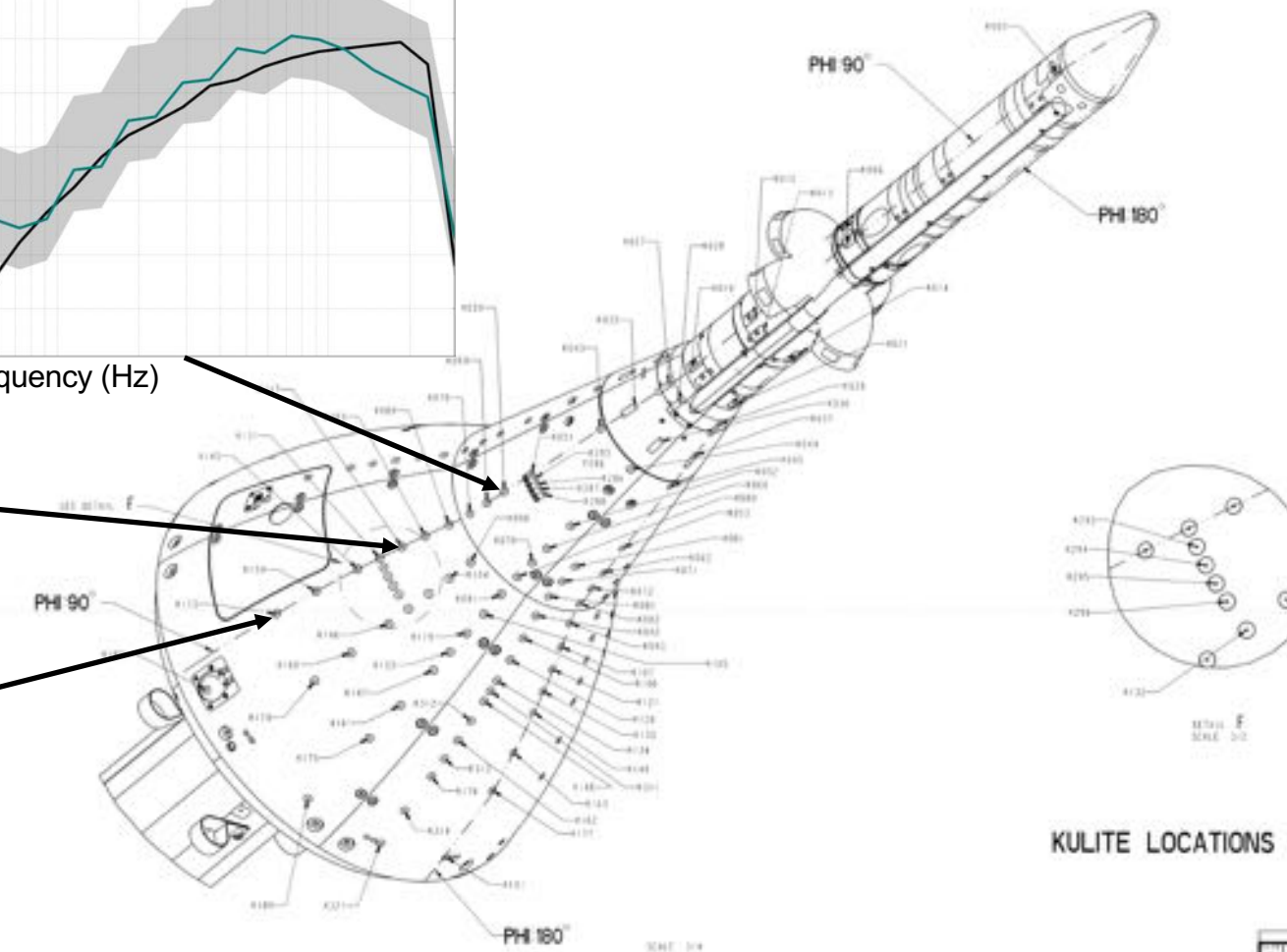
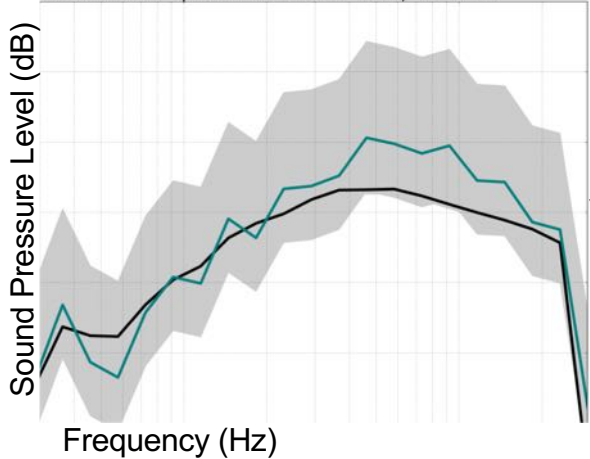



# Outline



- **Motivation**
- **LAVA Framework**
- **Launch: Kennedy Space Center Infrastructure Redesign**
  - Ignition over-pressure waves
- **Ascent: Orion Multi-Purpose Crew Vehicle Launch Abort System**
  - Transient pressure loads
- **Vehicle Aerodynamics: Low-Boom Flight Demonstrator**
  - Jet noise
- **Propeller Noise: Small UAS Acoustics**
  - Validation for moving geometry and tonal noise computation – Lattice Boltzmann
- **Fan Noise**
  - R4 Source Diagnostic Test - Toward Fan Broadband Noise Prediction

# High Fidelity Jet Noise Simulation Methodology for Airport Noise Prediction of Emerging Commercial Supersonic Technologies

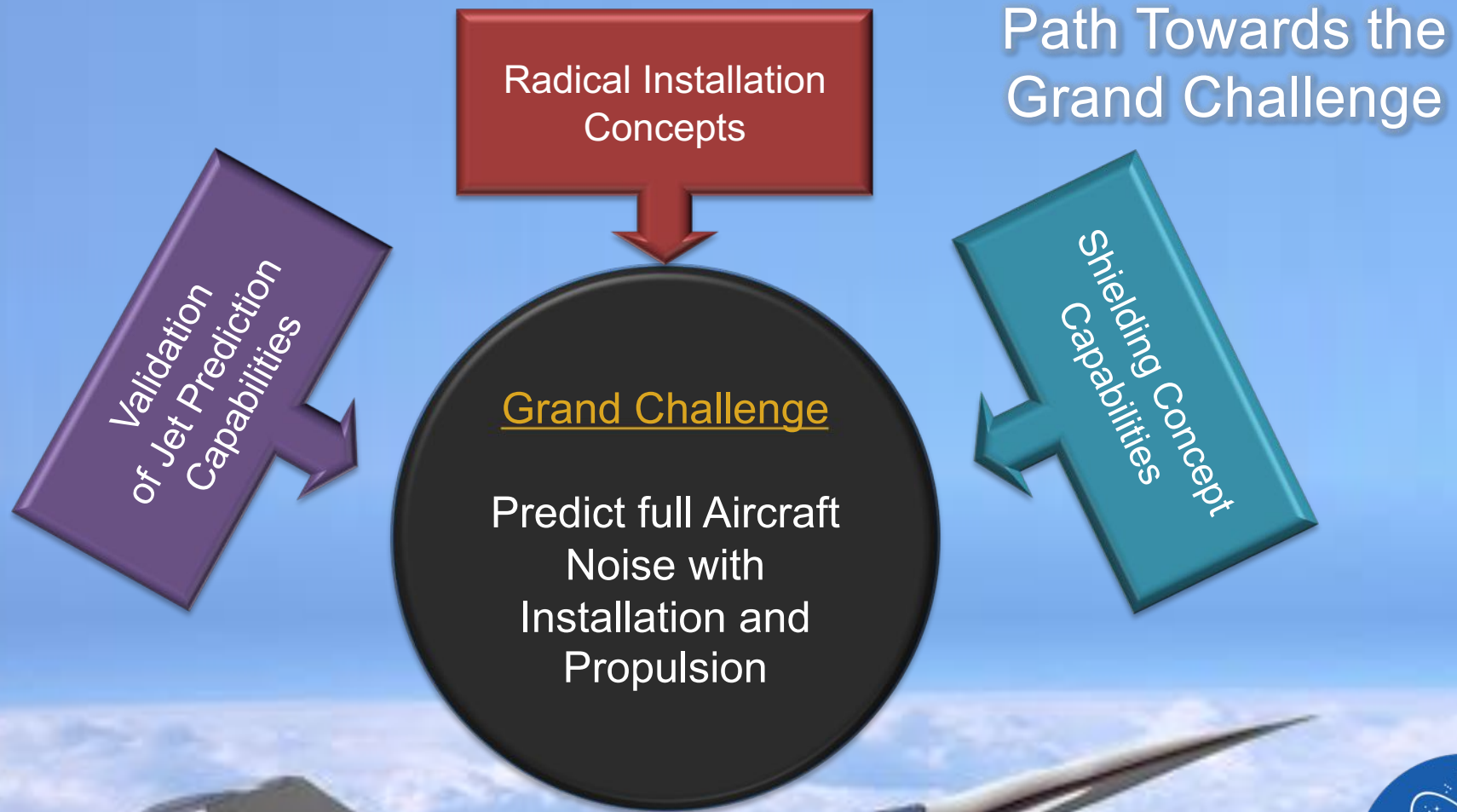

Commercial Supersonic Technologies (CST)  
Advanced Air Vehicle Program (AAVP)

# SP 7 Round Jet – Farfield Results



RMS center-line velocity

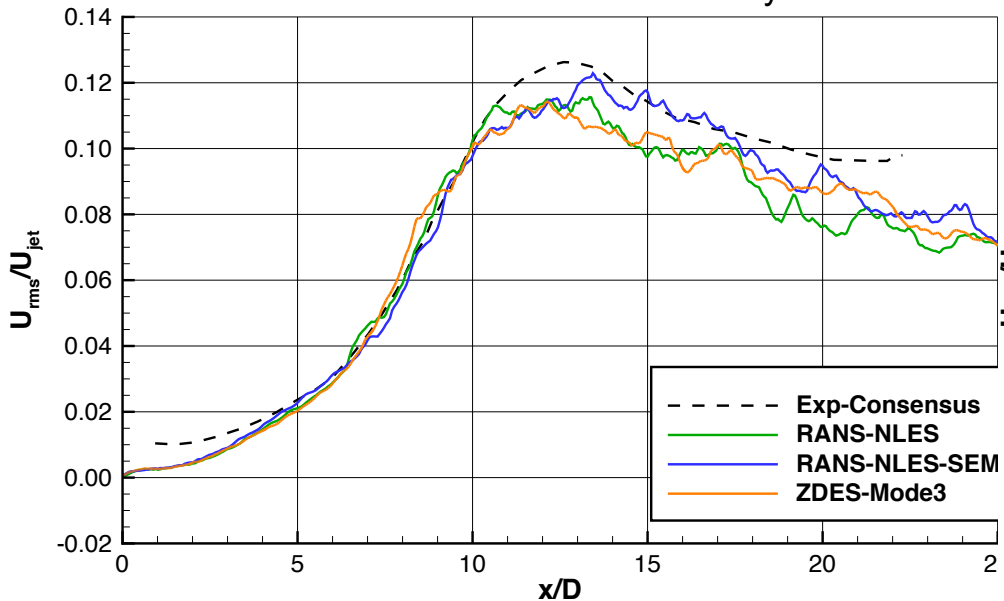

RMS lip-line velocity

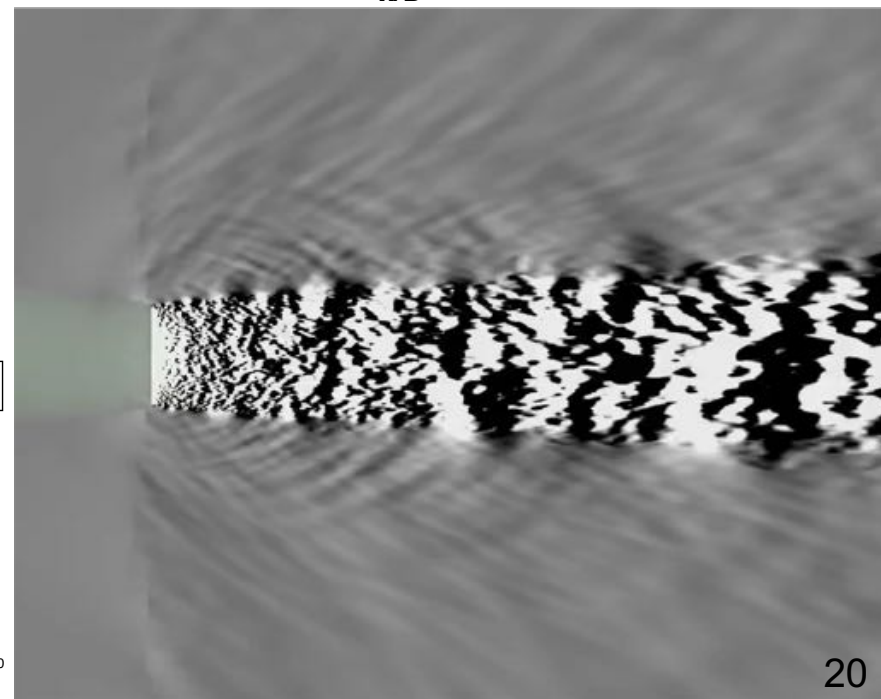
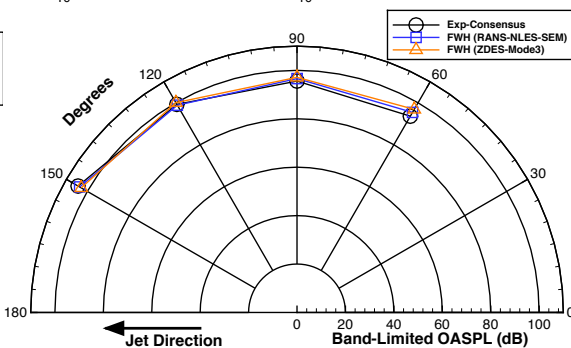
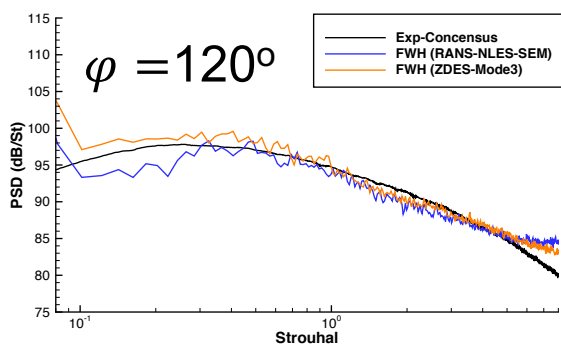
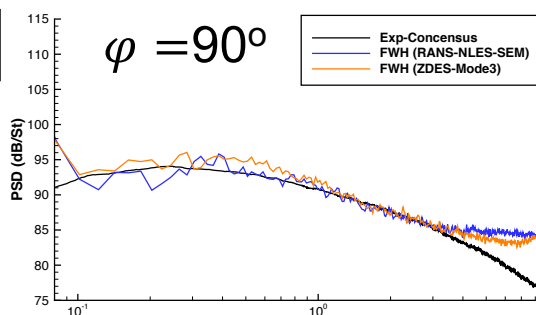
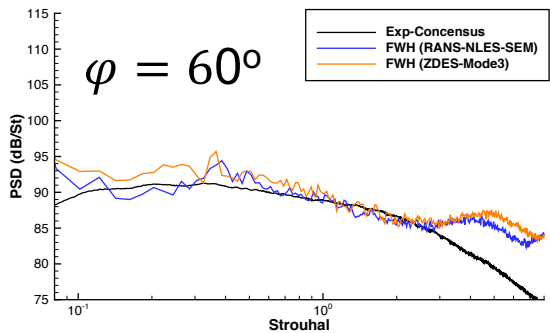
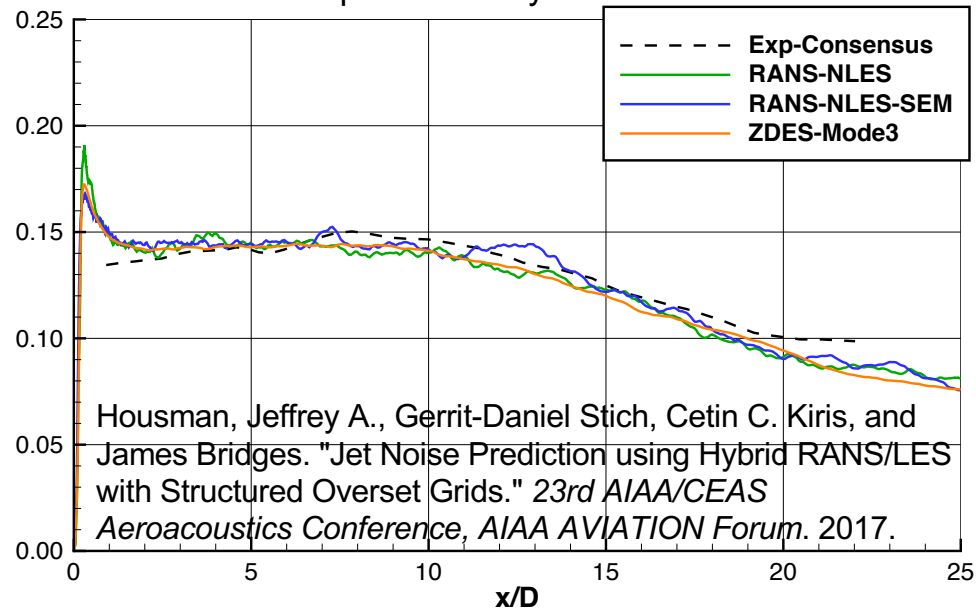

# First Step Towards Radical Installation Concepts



Initial Validation

Shielding Concept

SP7 SMC0000

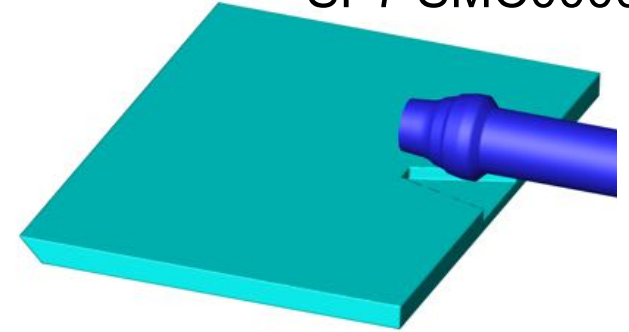

## Objective:

- ✓ Moving towards radical installation concepts.
- ✓ Jet-surface interaction noise is difficult to predict.

## Approach:

- ✓ Assess Jet Surface Interaction Noise with ZDES (Mode 3).
- ✓ Improve Post-Processing tools to gain better understanding of the sound generation and shielding physics (permeable and impermeable FWH, beamforming)

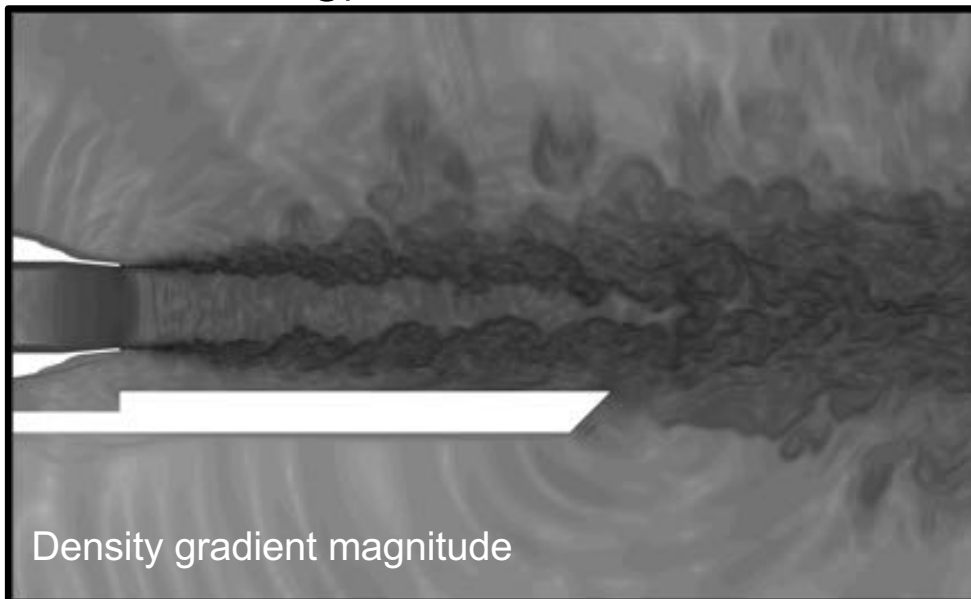

# Establishing Best Practices for FWH Surface



Initial Validation

Shielding Concept

FWH1: Big Box  
(grey)

FWH2: Small Cone  
(blue)

FWH2: Small Box  
(cyan)

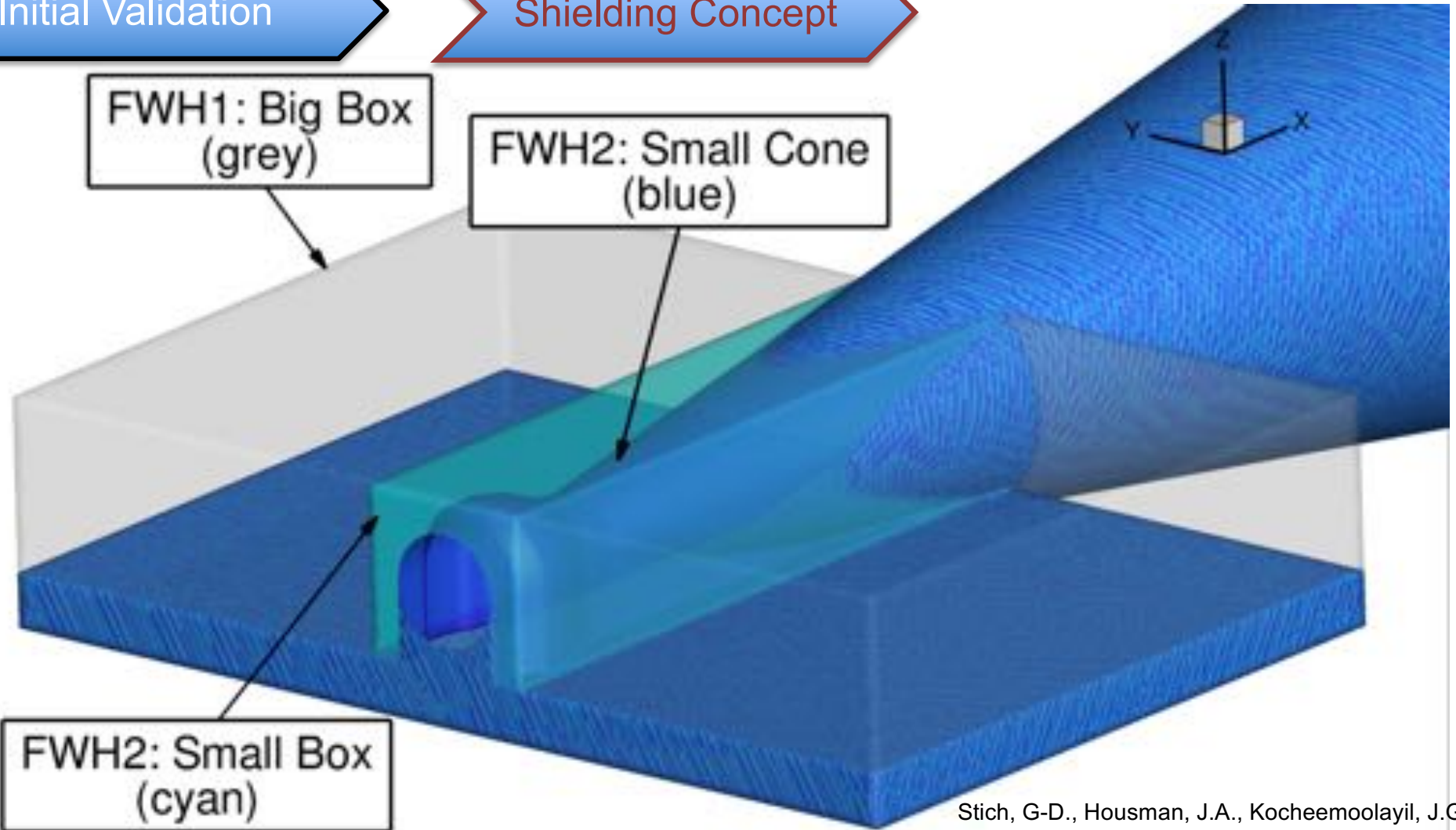

Stich, G-D., Housman, J.A., Kocheemoolayil, J.G. and Kiris, C.C. .Hybrid RANS/LES Simulation of Jet Surface Interaction Noise. AIAA-CEAS 2019. Delft. Netherlands.

- ✓ Choice of FWH surface not trivial.
- ✓ Conflicting requirements on resolution and inclusion of all relevant sound generation and shielding physics.

# Capturing Shielding Effects



Initial Validation

Shielding Concept

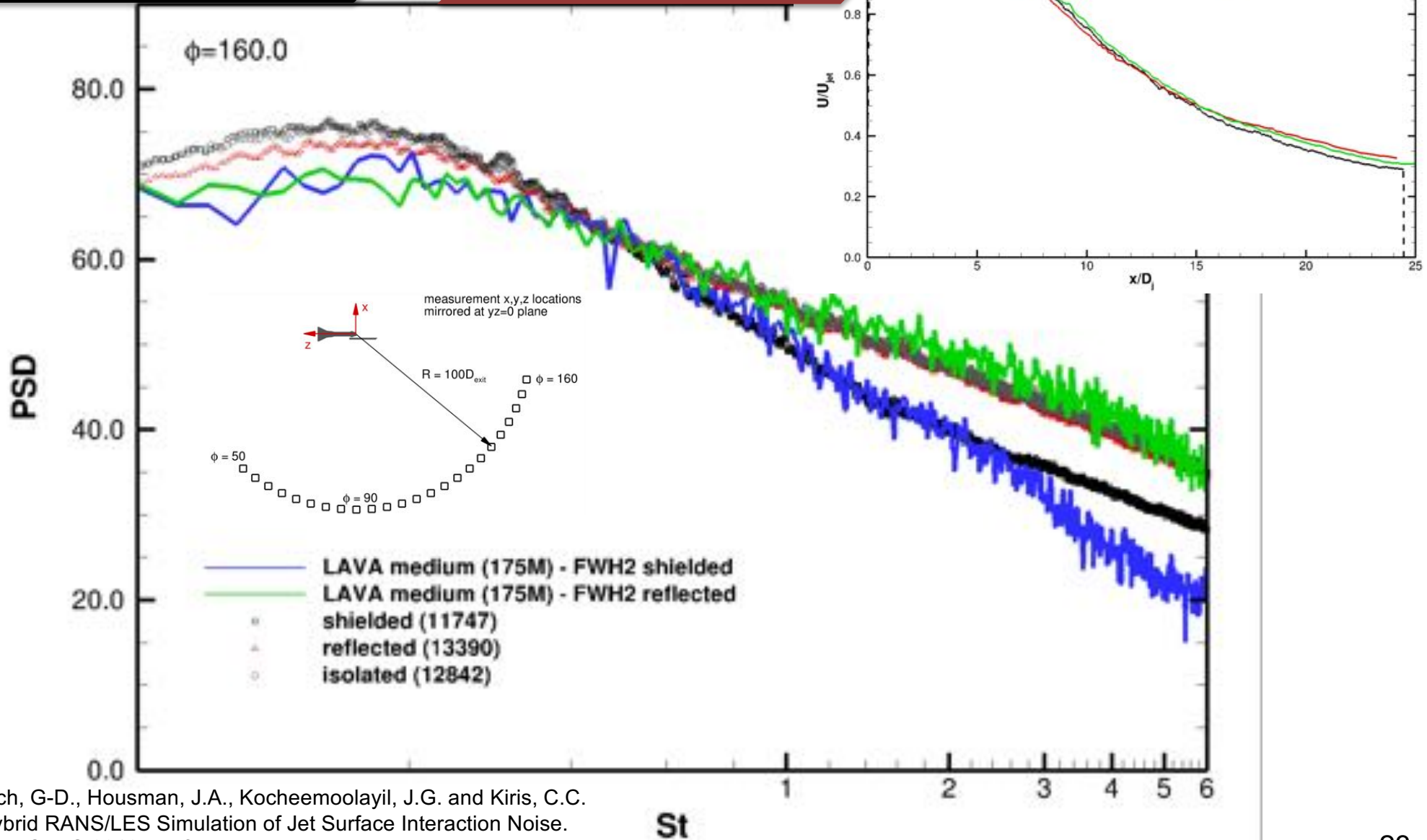

Stich, G-D., Housman, J.A., Kocheemoolayil, J.G. and Kiris, C.C.  
 .Hybrid RANS/LES Simulation of Jet Surface Interaction Noise.  
 AIAA-CEAS 2019. Delft. Netherlands.

# Next Step Towards Radical Installation Concepts



Initial Validation

Shielding Concept

Radical Installation Concepts

## Objective:

- ✓ Significantly increase complexity (last step before “grand challenge”).
- ✓ Multi-stream nozzle with shielding and installation effects.
- ✓ Comparison with comprehensive experimental database.



Picture taken from:  
NASA Test Report: Top-Mounted Propulsion Test  
2017 (TMP17)

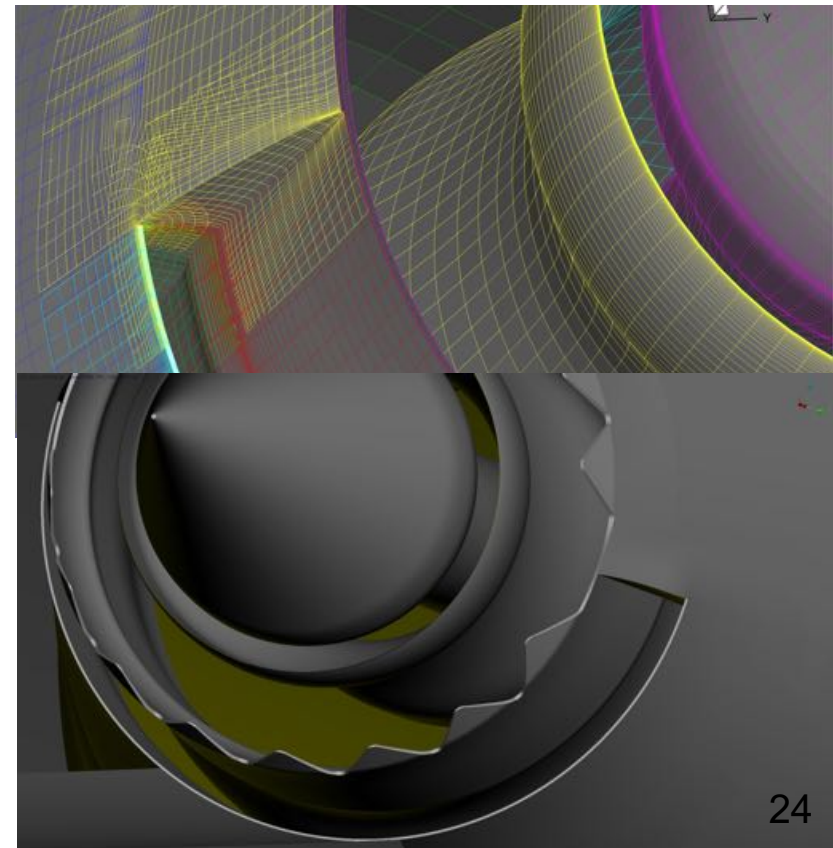
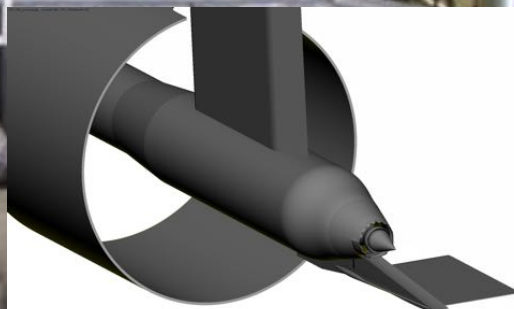

# Lessons Learned: Jet Noise



- **Mesh quality makes a big difference**
- **Use lowest dissipation convective flux that is stable**
- **Resolve turbulent boundary layer structures inside the nozzle**
- **Understand effect of FWH surface shape and triangle size**



# Aero-Acoustics With Cartesian Navier-Stokes

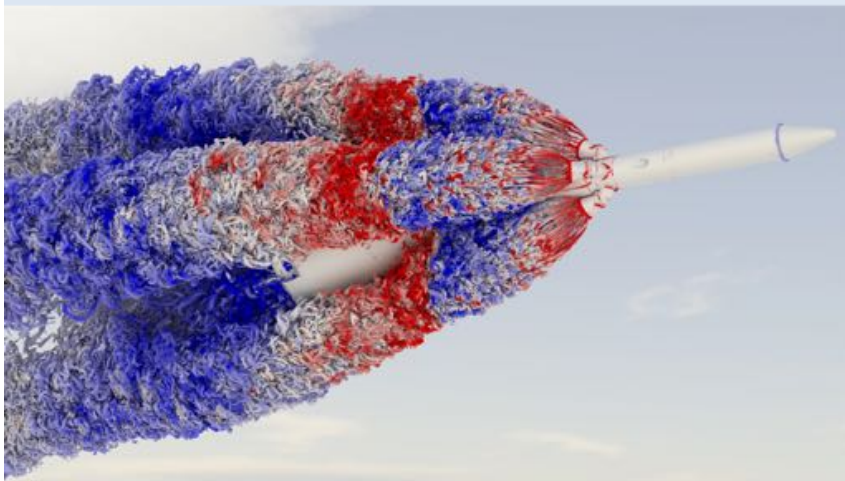

**Launch Abort System Analysis for Orion**  
350 million cells, 28 days of wall time (2000 cores)

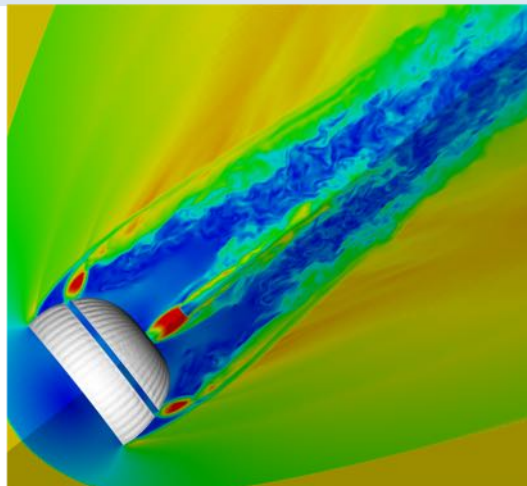

**Low Density Supersonic Decelerator**  
200 million cells, 3 days of wall time (2000 cores)

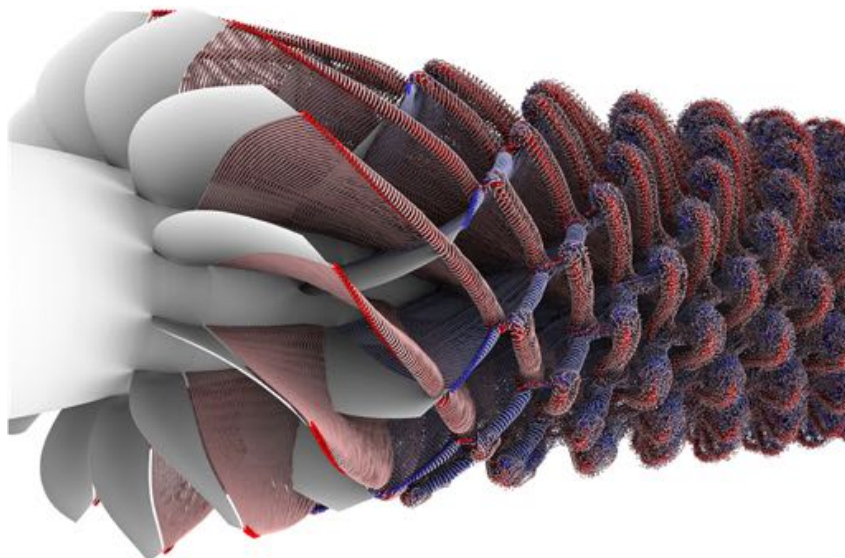

**Contra-Rotating Open Rotor Propulsion**  
360 million cells, 14 days (1400 cores)

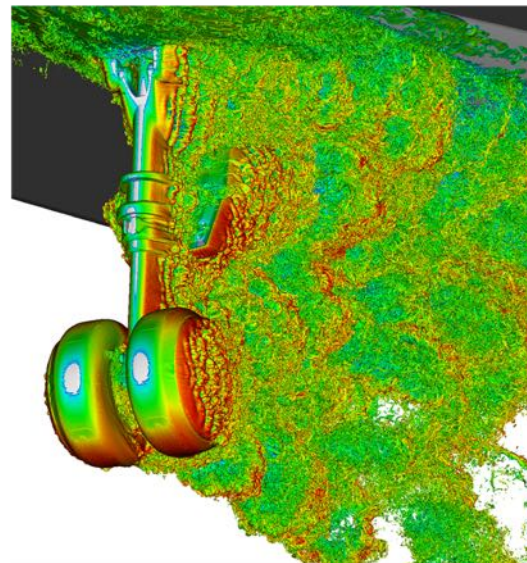

**Landing Gear**  
298 million cells, 20 days of wall time (3000 cores)

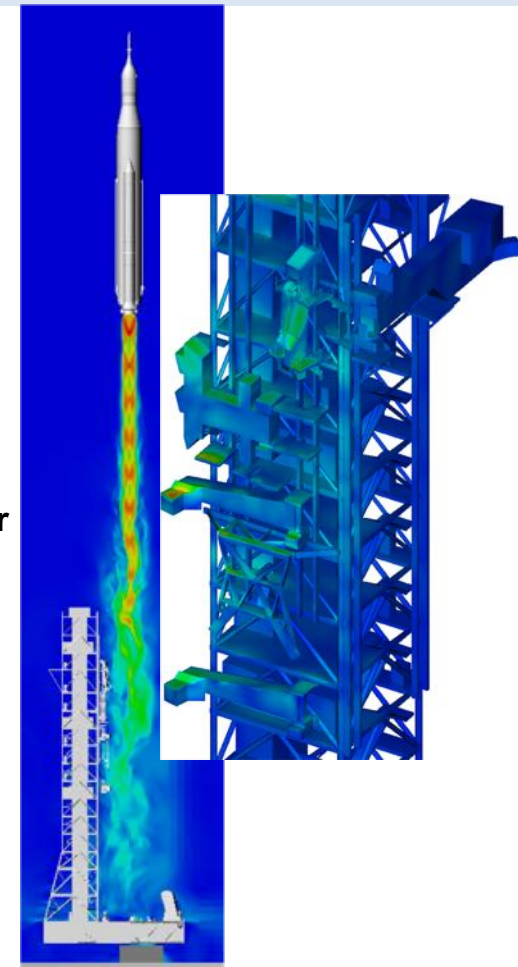

**Launch Environment**  
200 million cells, 7 days of wall time (1000 cores)

# Challenges in Computational Aero-Acoustics



## ✓ Computational Requirements

- Space-time resolution requirements for acoustics problems are demanding
- LAVA Cartesian infrastructure has been re-factored into Navier-Stokes (NS) and Lattice Boltzmann Method (LBM)
  - **10-50 times speed-up** can be achieved with LBM vs NS-WENO without any compromise in accuracy or robustness



# Outline



- **Motivation**
- **LAVA Framework**
- **Launch: Kennedy Space Center Infrastructure Redesign**
  - Ignition over-pressure waves
- **Ascent: Orion Multi-Purpose Crew Vehicle Launch Abort System**
  - Transient pressure loads
- **Vehicle Aerodynamics: Low-Boom Flight Demonstrator**
  - Jet noise
- **Propeller Noise: Small UAS Acoustics**
  - Validation for moving geometry and tonal noise computation – Lattice Boltzmann
- **Fan Noise**
  - R4 Source Diagnostic Test - Toward Fan Broadband Noise Prediction



## **Towards Urban Air Mobility (UAM)**

**High-Fidelity Modeling and Optimization Method Development  
NASA Revolutionary Vertical Lift Technology Rotary Project (RVLT)**

# Isolated UAS Rotor in Hover Validation

**Zawodny and Haskin**  
(AIAA-2017-3709)

Rotor Span R 0.1905 [m]

Microphones (M1-M5) 10R

Considered RPM 5400

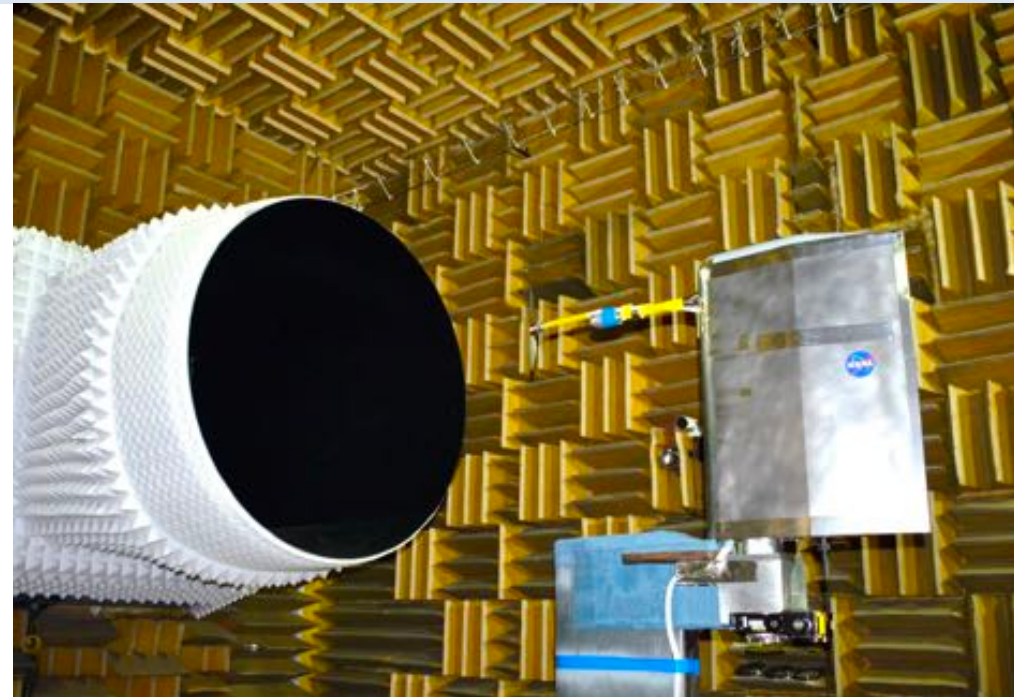
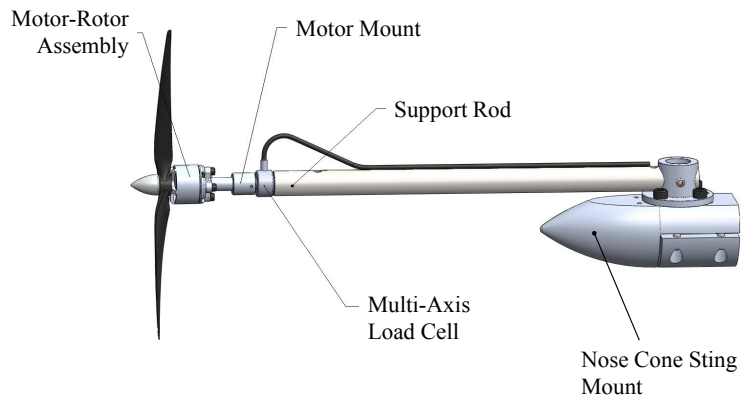

- ✓ Experiments conducted at NASA Langley LSAWT as well as in the Structural Acoustics Loads and Transmission (SALT) anechoic chamber.
- ✓ Motor-Rotor Assembly as well as Mount and Support structure not considered in simulations.

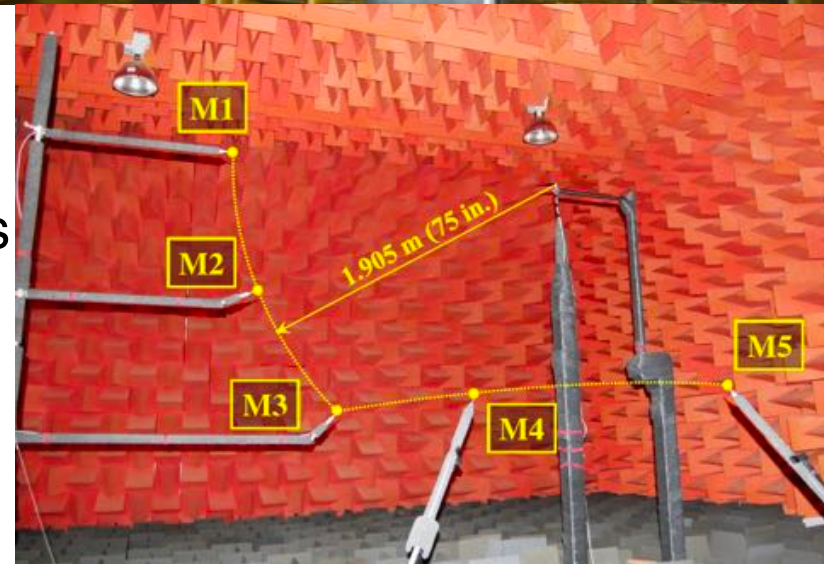

Experimental Data from Zawodny and Haskin AIAA-2017-3709

# LAVA Cartesian Methods

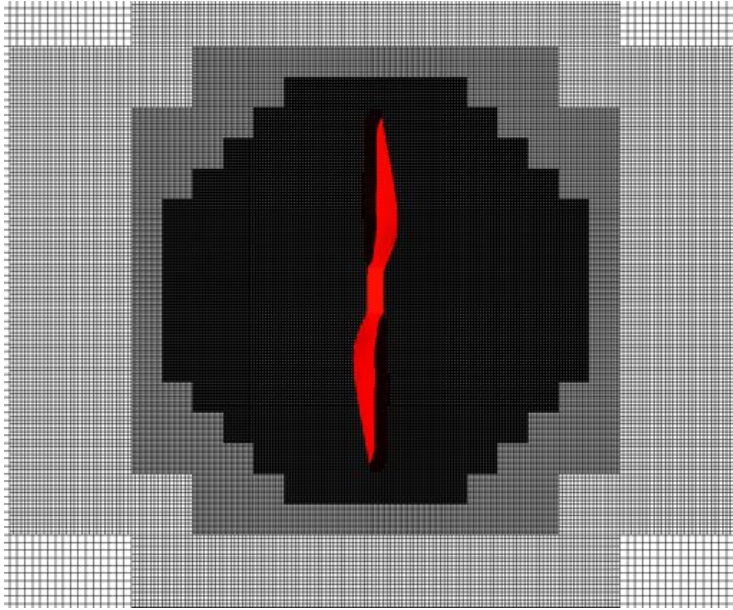

Lattice Boltzmann  
(LBM – EMRT)

Navier-Stokes  
(NS – WENO6)

- ✓ Refinement ratio of 2:1
- ✓ Very Coarse : 40% tip chord ( 8lev)
- ✓ Coarse : 20% tip chord ( 9lev)
- ✓ Medium : 10% tip chord (10lev)
- ✓ Fine : 5% tip chord (11lev)

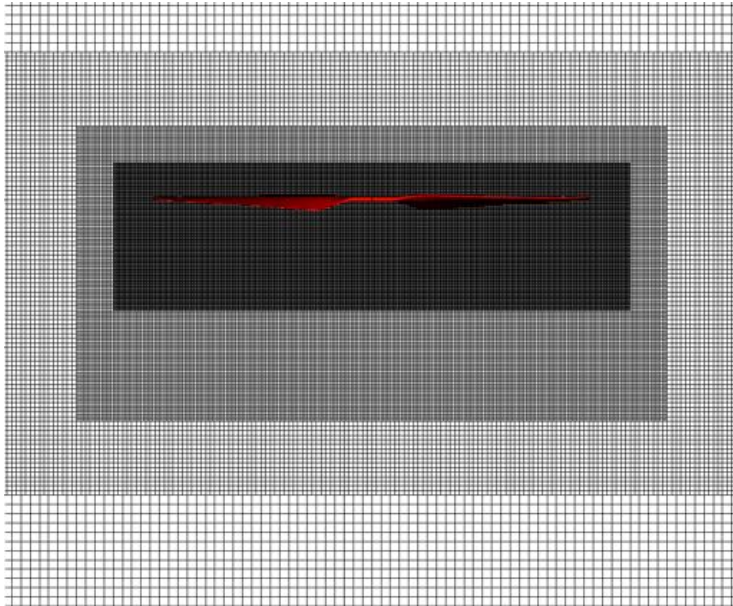

Isocontour of Q-criterion colored by Pressure.  
Navier-Stokes Simulation on medium Cartesian mesh.

# Lattice Boltzmann Method Farfield Noise – SPL Spectrum for Observer M1 & M3

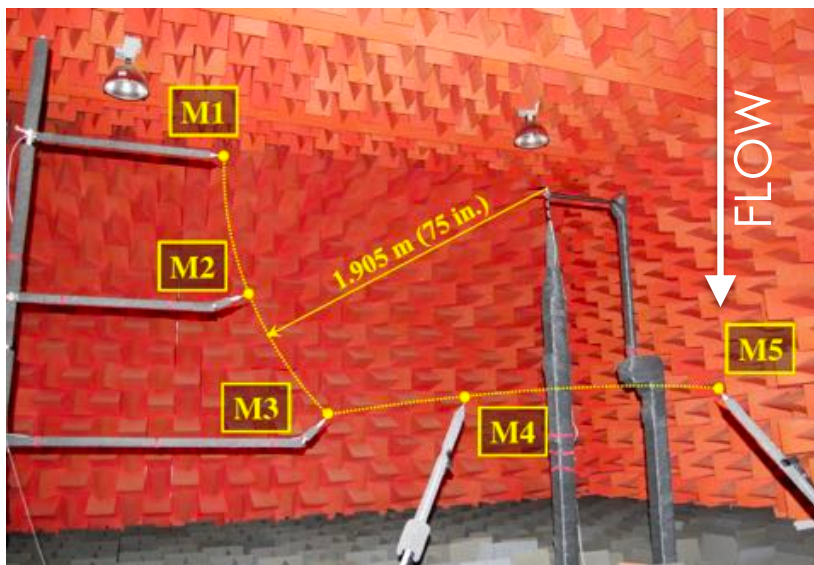
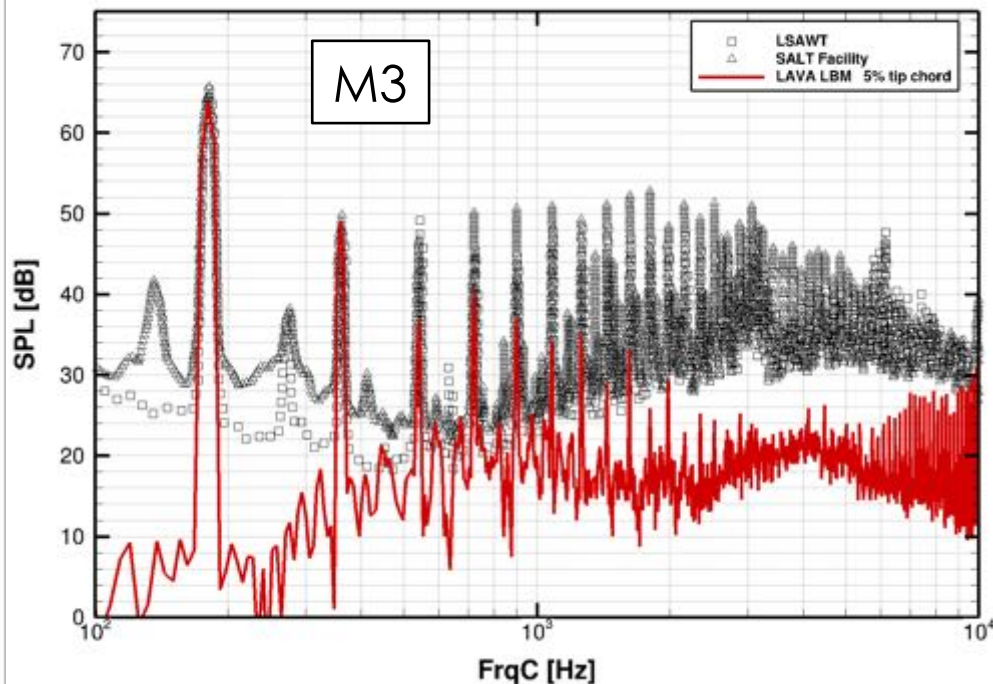
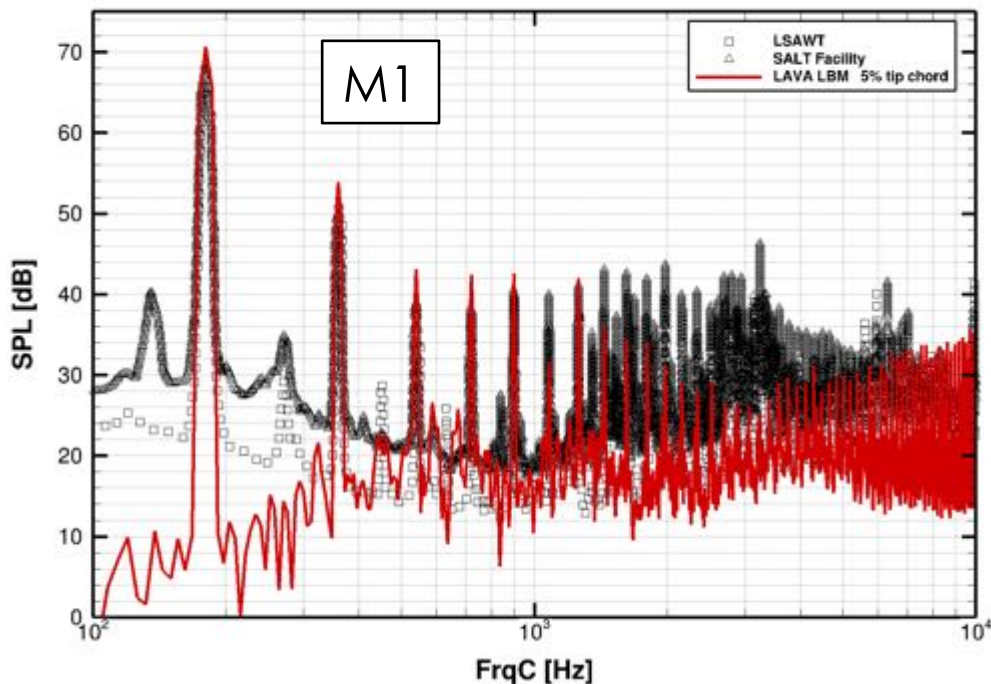

- ✓ Excellent agreement with BPF1-BPF5 for M1 ( $0.0^\circ$ ) microphone location
- ✓ Excellent agreement with BPF1 & BPF2 for M3 ( $45.0^\circ$ )
- ✓ Different FWH formulations (permeable and impermeable) currently under investigation

# Comparison between the Approaches

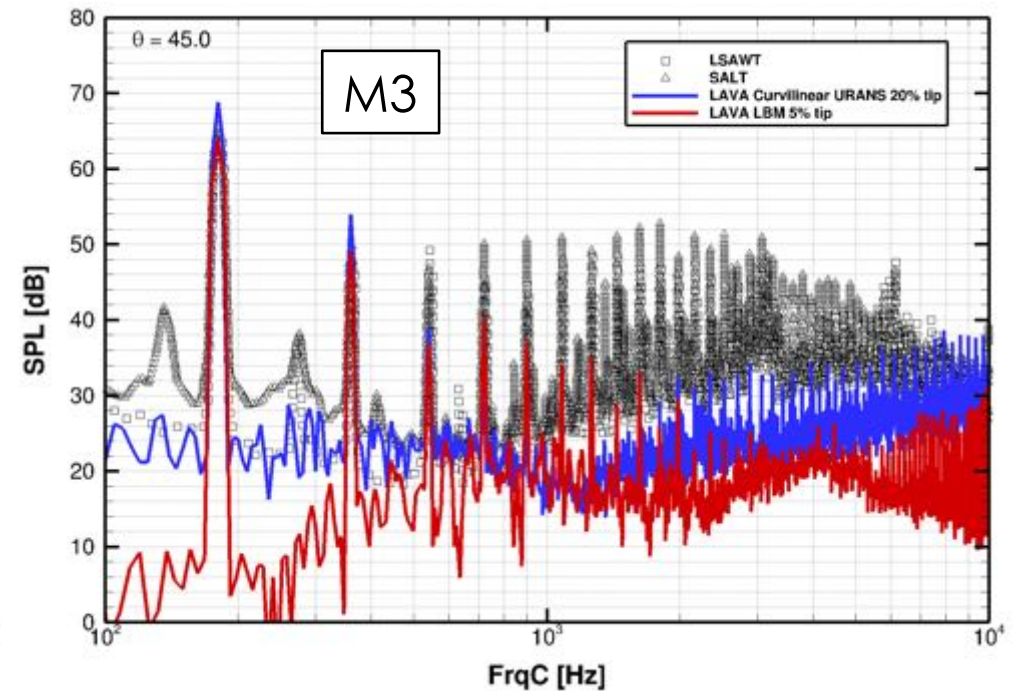
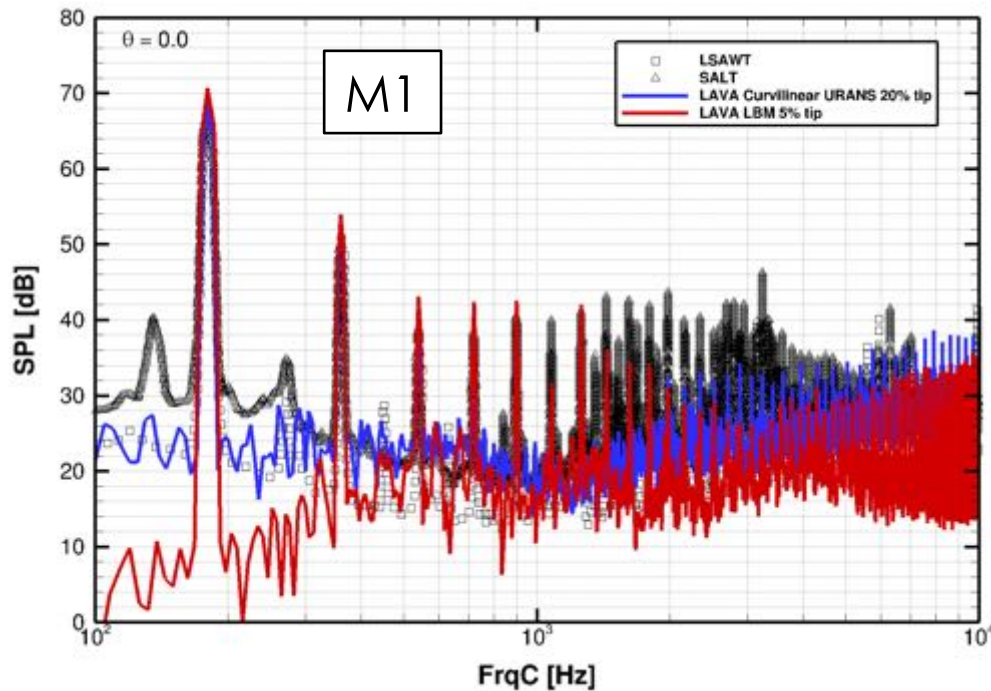

- ✓ Consistent prediction using all three approaches
- ✓ Computational efficiency and complete absence of manual volume mesh generation key advantage of LBM
- ✓ Manual meshing efforts increase significantly upon considering installation effects (e.g. full Quadcopter or tiltwing urban air taxis)



# Outline



- **Motivation**
- **LAVA Framework**
- **Launch: Kennedy Space Center Infrastructure Redesign**
  - Ignition over-pressure waves
- **Ascent: Orion Multi-Purpose Crew Vehicle Launch Abort System**
  - Transient pressure loads
- **Vehicle Aerodynamics: Low-Boom Flight Demonstrator**
  - Jet noise
- **Propeller Noise: Small UAS Acoustics**
  - Validation for moving geometry and tonal noise computation – Lattice Boltzmann
- **Fan Noise**
  - R4 Source Diagnostic Test - Toward Fan Broadband Noise Prediction



## **Aircraft Noise Reduction (ANR)**

**High Fidelity Acoustic and Performance Simulation of NASA R4 Noise Source Diagnostics Test (SDT)**

# R4 Source Diagnostic Test

## Toward Fan Broadband Noise Prediction



- ✓ Fan Noise Workshop Realistic Case 2 (RC2v2) at approach speed (7808 RPM) with baseline OGV design with goal to compare to hot-wire, LDV, and microphone test data
- ✓ LAVA Cartesian with fixed isotropic refinement zones from fan to exhaust
- ✓ Running two cases:
  - 6th order adaptive WENO [1]
  - 2<sup>nd</sup> order Kinetic-Energy Preserving (KEP) flux [2] with JST Artificial Dissipation [3]
- ✓ Moving geometry with immersed boundary representation
  - Impose slip boundary condition with 2<sup>nd</sup> order ghost cell method with ghost-in-fluid for thin geometry
- ✓ Coarse grid:
  - Min cell size = 2 mm
  - Number of degrees of freedom = 84M
- ✓ Medium grid:
  - Min cell size = 1 mm
  - Number of degrees of freedom = 387M

[1] Hu, X. Y., Q. Wang, and Nikolaus Andreas Adams. "An adaptive central-upwind weighted essentially non-oscillatory scheme." *Journal of Computational Physics* 229.23 (2010): 8952-8965.

[2] Yuichi Kuya, Kosuke Totani, Soshi Kawai. "Kinetic energy and entropy preserving schemes for compressible flows by split convective forms." *Journal of Computational Physics* 375 (2018): 823-853

[3] Jameson, Antony. "Origins and further development of the Jameson-Schmidt-Turkel scheme." *AIAA Journal* (2017): 1487-1510.

# Summary



LAVA scale-resolving simulations impact NASA applications by providing:

- Flexibility with respect to mesh paradigms
- Cutting-edge hybrid RANS LES and WM-LES capabilities
- Fast-enough turnaround time to be included in design cycle

