



NASA Thermal Recovery Energy Efficient System (TREES) for Aircraft Exergy Optimization

Rodger Dyson

NASA Glenn Research Center

Exergy Analysis and Design Workshop

Wright Patterson Air Force Base

April 17-18, 2019

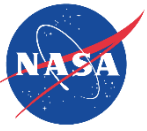

Motivation

Low Grade Waste Heat Produced Throughout Insulated Aircraft

- Prefer technology that:
 - improves fuel efficiency,
 - reduces emissions,
 - removes heat from:
 - small core engines, more electric composite aircraft, and high power electric propulsion systems
 - reduces vehicle mass
 - reduces thermal signature for military

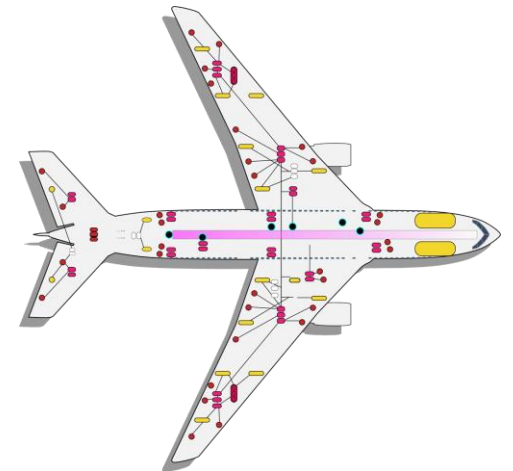
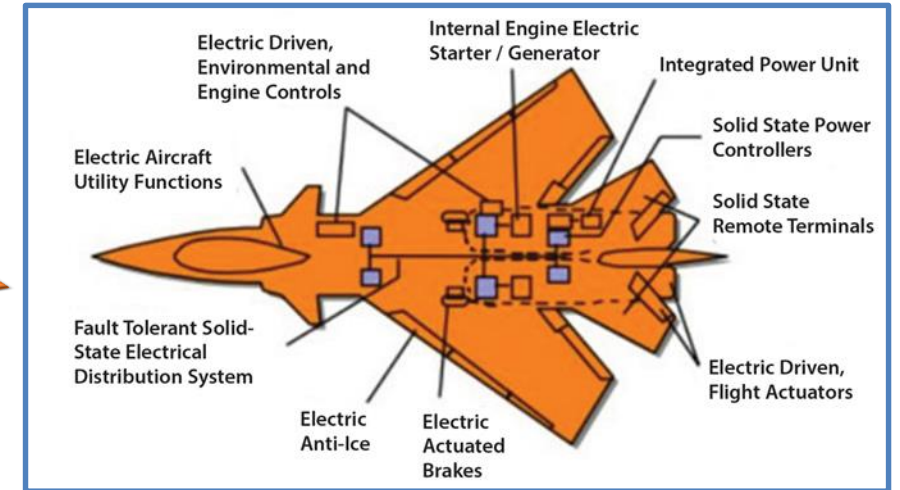
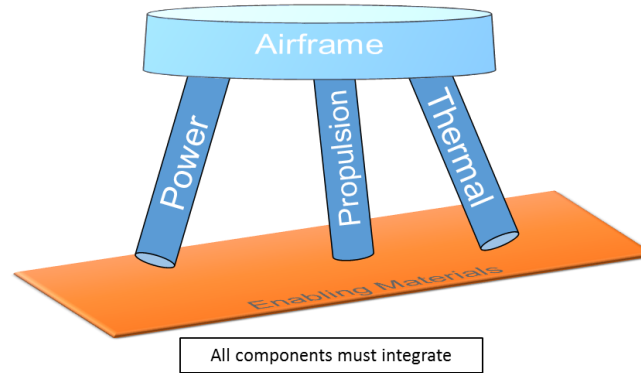

Commercially attractive solution would achieve >15% fuel savings

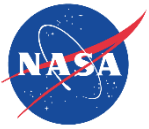

Thermal Challenge

50kW to >800kW of low grade thermal heat trapped within composite aircraft body

Current proposed solutions include:

- Ram air HX
 - adds weight and aircraft drag
- Convective skin cooling HX
 - adds weight, drag, and inefficient
- Dumping heat into fuel
 - limited thermal capacity
- Dumping heat into lubricating oil
 - limited thermal capacity
- Active cooling
 - adds weight and consumes engine power
- Phase change cooling
 - adds weight and limited thermal capacity
- Heat pipe, pumped multiphase, vapor compression
 - adds weight and consumes engine power

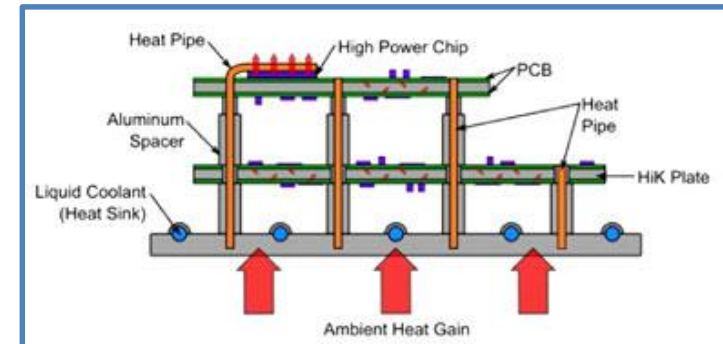
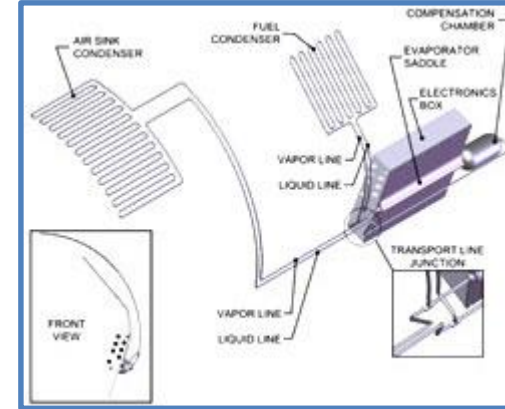

Thermal Limits

- Into Fuel
- Recirculate Fuel
- Ram Air
- Into Engine
- Vapor-Compression

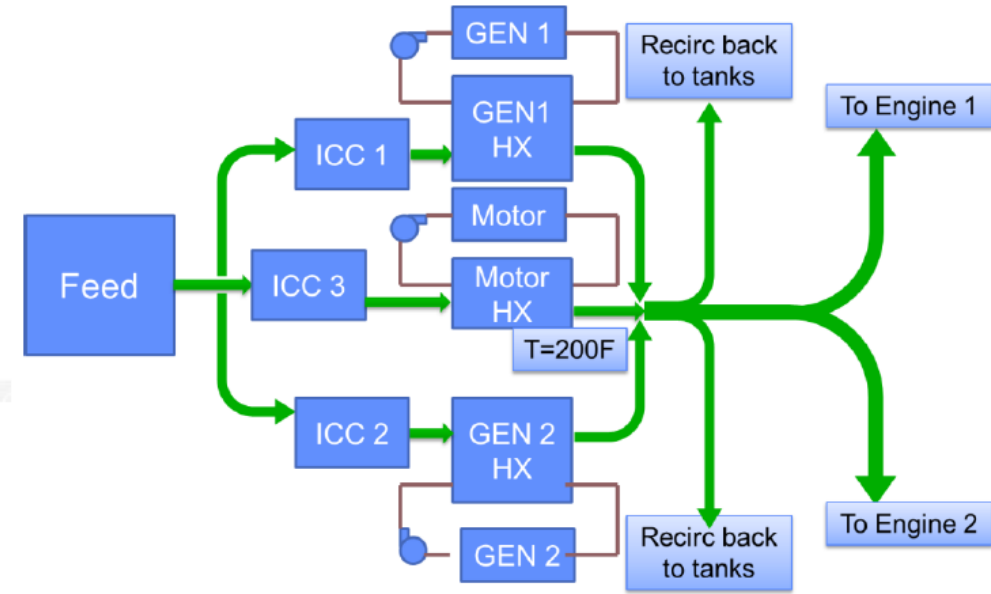
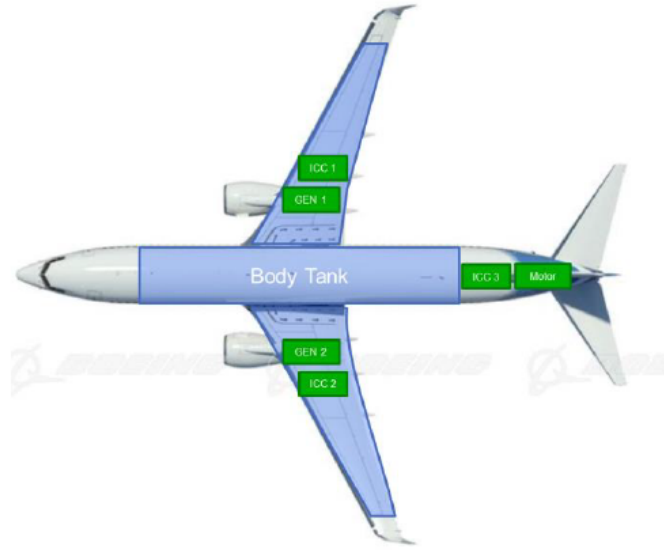

	1% Hot Day		Standard Day	
	Total Penalty (zero exit Velocity)	Total Penalty (non-zero exit velocity)	Total Penalty (zero exit Velocity)	Total Penalty (non-zero exit velocity)
900NM	4.98%	3.31%	2.76%	2.36%
3500NM	5.00%	3.62%	3.01%	2.57%

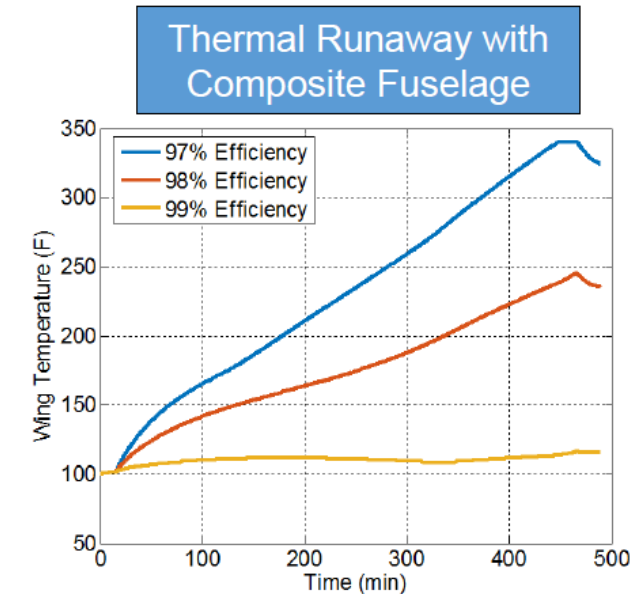

Electric Aircraft Propulsion Thermal management technology impacts performance and safety certification

Energy Quality = Exergy / Energy

- Heat Engine Exergy Exchanged:
 - $B = Q(1 - T_0/T_{\text{source}}) = Q * \eta$
- Heat extraction = Exergy Decrease
- Heat pumping = Exergy Increase

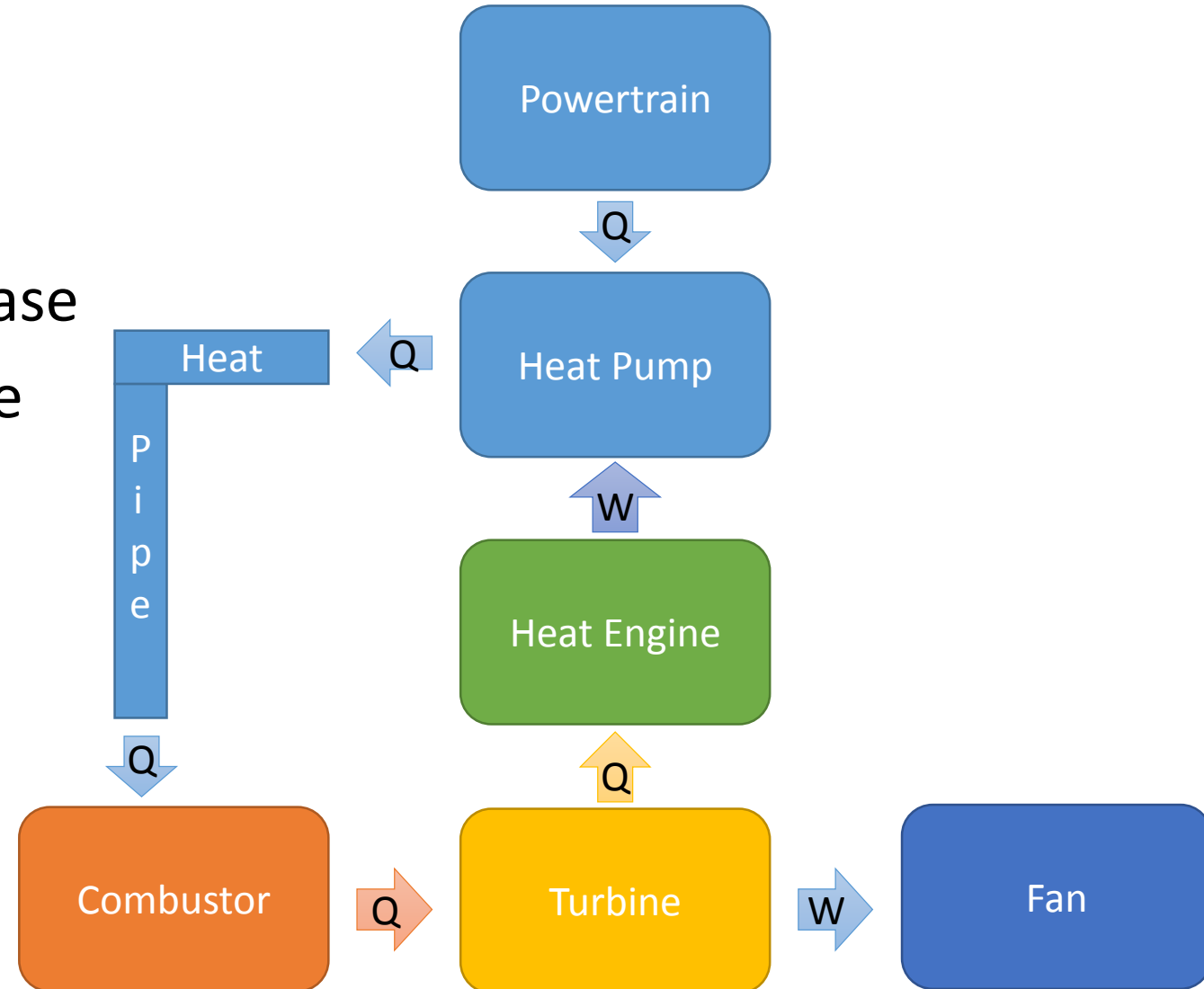

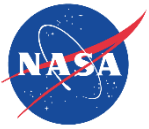

Aero-vascular Energy Management

Thermal management comparison of human and aircraft

<u>Human</u>	<u>Aircraft</u>
Heart	Turbofan
Artery	Acoustic Pipe
Vein	Heat Pipe
Skin	Skin
Blood	Helium/Gas

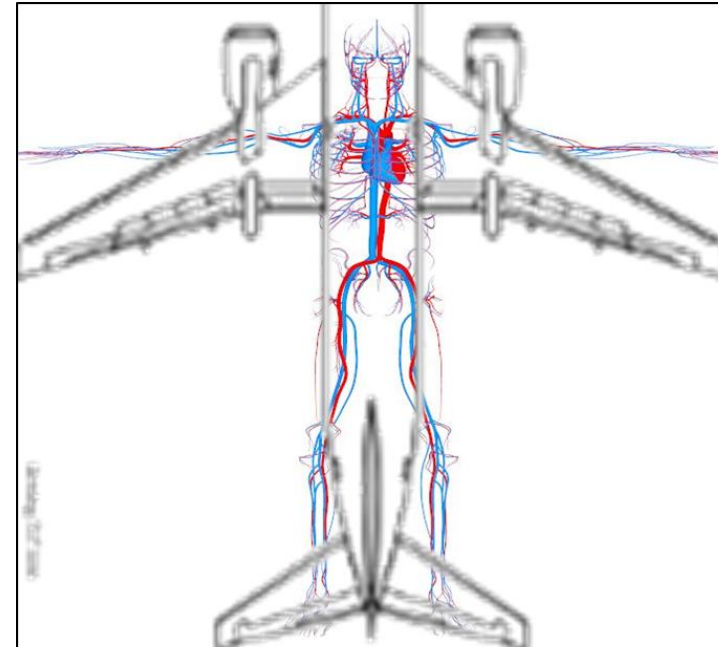

Human body circulatory system as model for aircraft

Three Key Points:

1. Recycle waste energy with heat pumping powered with core waste energy
2. Additive manufactured airframe enables sophisticated heat transport
3. Solid-state thermal control allows transporting energy with no moving parts

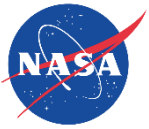

Basic Principles

- Extract waste energy from turbofan core exhaust and/or SOFC and convert to ducted acoustic wave
- Deliver no moving part mechanical acoustic energy throughout aircraft in embedded airframe tubes
- Cool and heat pump powertrain and/or more electric components using no moving part thermo-acoustic heat pump
- Recycle waste heat with variable conductance heat pipes or additional acoustic tubes.

Heat Energy Extraction

High bypass ratio turbofan (6-12)/turboprop (50-100)

Small core and distributed propulsion increases ratio, (e.g., PW1000G ideal)

787 with RR Trent 1000 - 10:1

Thrust produced mostly by cold bypass air

Extract waste energy from core

Minimal impact on overall thrust

Reduce jet noise V^8

~30 MW waste heat available

Extract only 10%, 3 MW -> 1MW acoustic energy available

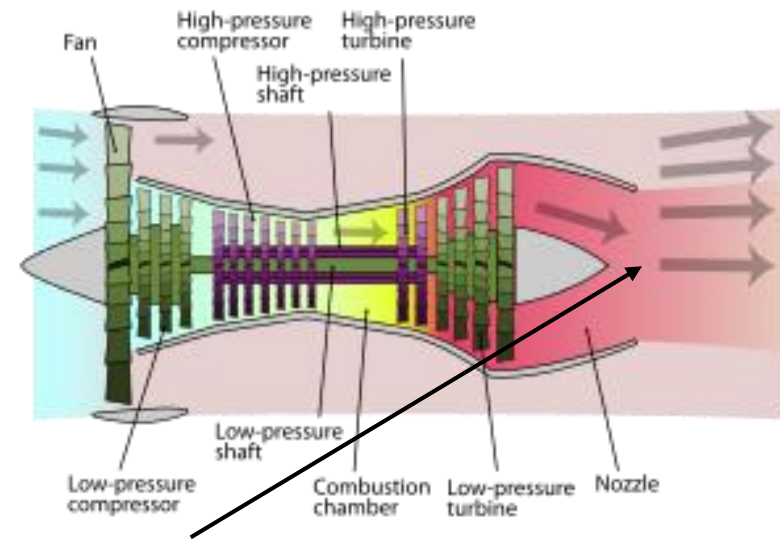

Turbo-Acoustic Fuel Cell

Also can extra waste energy from inside fuel cell

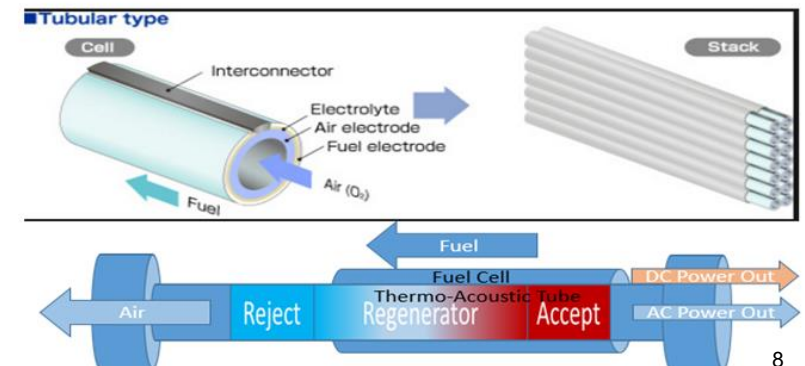

Thrust VS. Core Extraction

Wnet	excess turbine shaft power	2.837E+06	2.745E+06	2.651E+06	2.558E+06	2.465E+06
Wexpander + Wcompressor + Wfan						
Thrust	net thrust	4.937E+04	4.948E+04	4.957E+04	4.963E+04	4.966E+04
MdotFlow * (Uexhaust - Uintake)						
MdotCompr	compressor mass flow rate	1.600E+01	1.600E+01	1.600E+01	1.600E+01	1.600E+01
MdotFlow * (1-Rbypass)						
MdotFan	fan mass flow rate	8.400E+01	8.400E+01	8.400E+01	8.400E+01	8.400E+01
MdotFlow * Rbypass						
FuelBurn		1.120E+07	1.120E+07	1.120E+07	1.120E+07	1.120E+07
fuelin						
OverallMdot		1.000E+02	1.000E+02	1.000E+02	1.000E+02	1.000E+02
MdotFlow						
IntakeA		8.439E+00	8.439E+00	8.439E+00	8.439E+00	8.439E+00
A1						
CompressorA		6.751E-01	6.751E-01	6.751E-01	6.751E-01	6.751E-01
A2						
CompressorA		6.751E-01	6.751E-01	6.751E-01	6.751E-01	6.751E-01
A3						
TurbineA		6.751E-01	6.751E-01	6.751E-01	6.751E-01	6.751E-01
A4						
NozzleA		4.219E+00	4.219E+00	4.219E+00	4.219E+00	4.219E+00
A5						
AtmosA		5.965E+01	5.965E+01	5.965E+01	5.965E+01	5.965E+01
A6						
BypassA		3.544E+00	3.544E+00	3.544E+00	3.544E+00	3.544E+00
A7						
BypassAndCore		4.219E+00	4.219E+00	4.219E+00	4.219E+00	4.219E+00
BypassA+CompressorA						
CoreQExtract		-3.120E+06	-2.422E+06	-1.711E+06	-9.929E+05	-2.672E+05
QCore						
CoreWaste		1.769E+07	1.773E+07	1.777E+07	1.780E+07	1.784E+07
TotalQCore						
PartExtracted		-1.764E-01	-1.367E-01	-9.634E-02	-5.577E-02	-1.498E-02
CoreQExtract/CoreWaste						

In this example, extracting 17.6% of the core enthalpy (3MW) only reduced thrust 0.5%
And in fully turboelectric or SOFC applications no thrust is impacted.

Heat Pumping

Makes more electric parts and powertrain effectively 100% efficient

All airframe waste is now useful

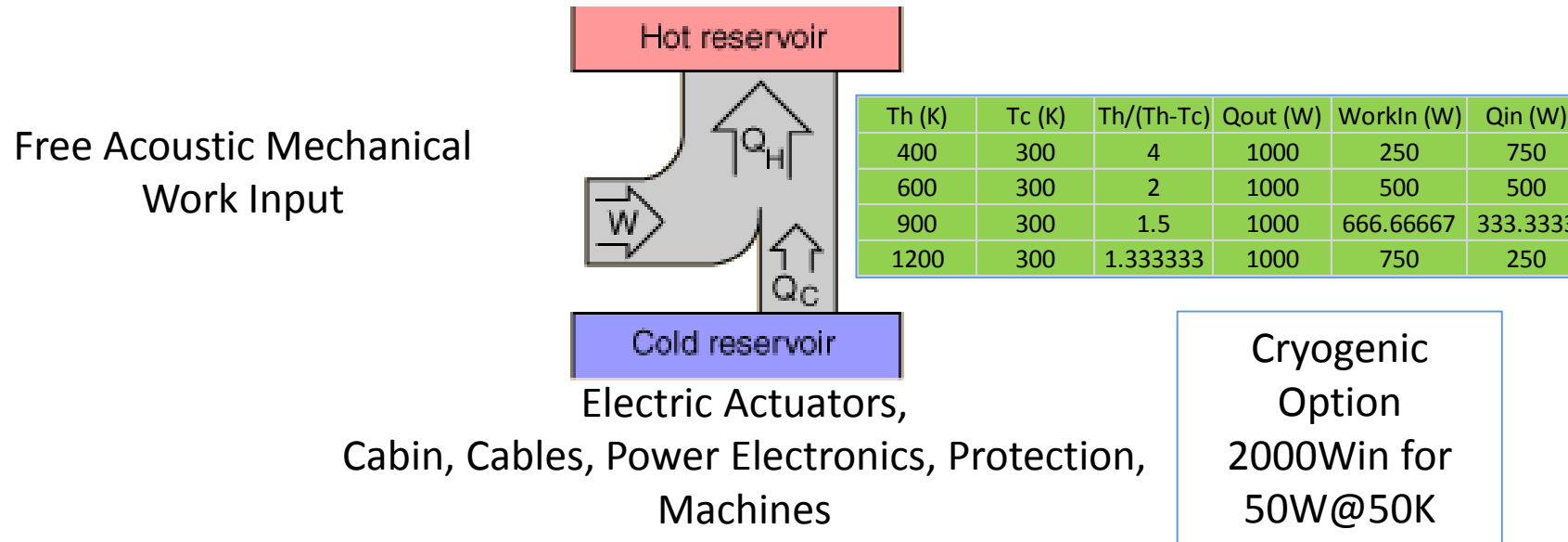

Acoustic Heat Pump

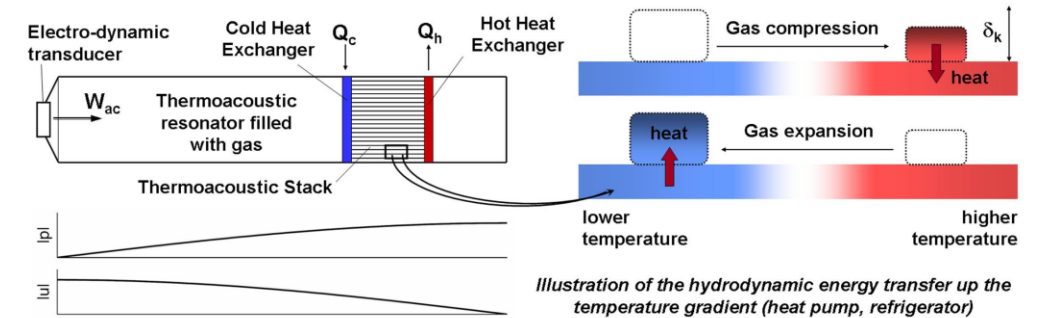
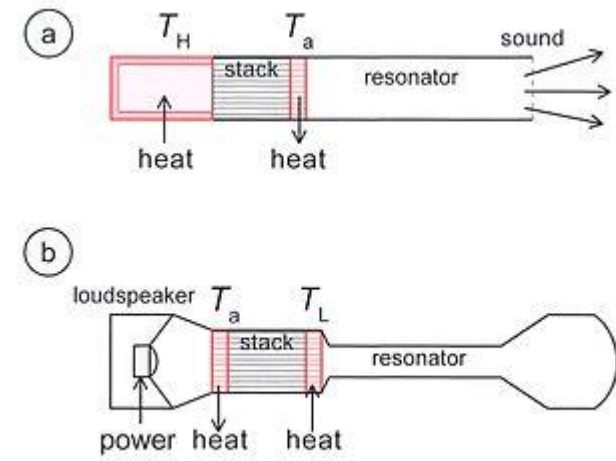
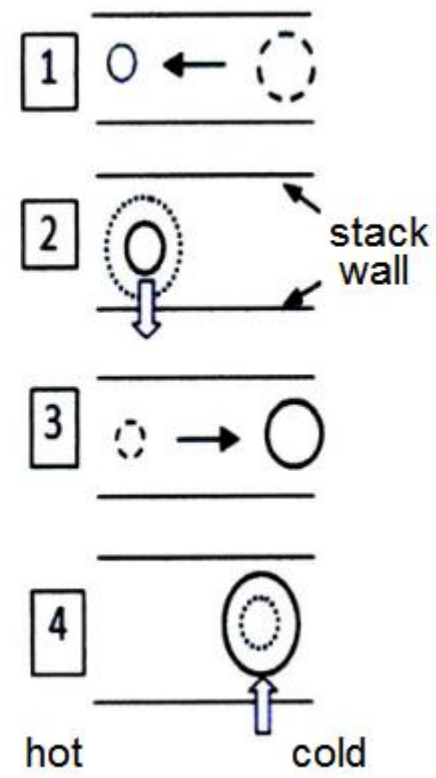
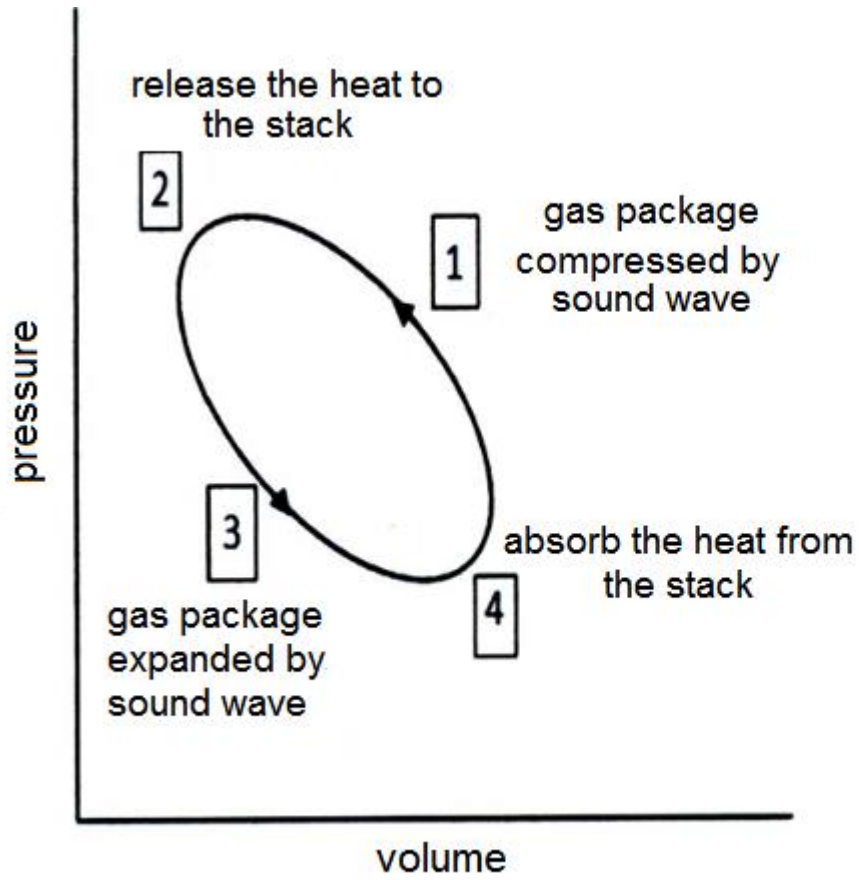

Traveling Energy Wave Basic Principles – Air Molecules Oscillate

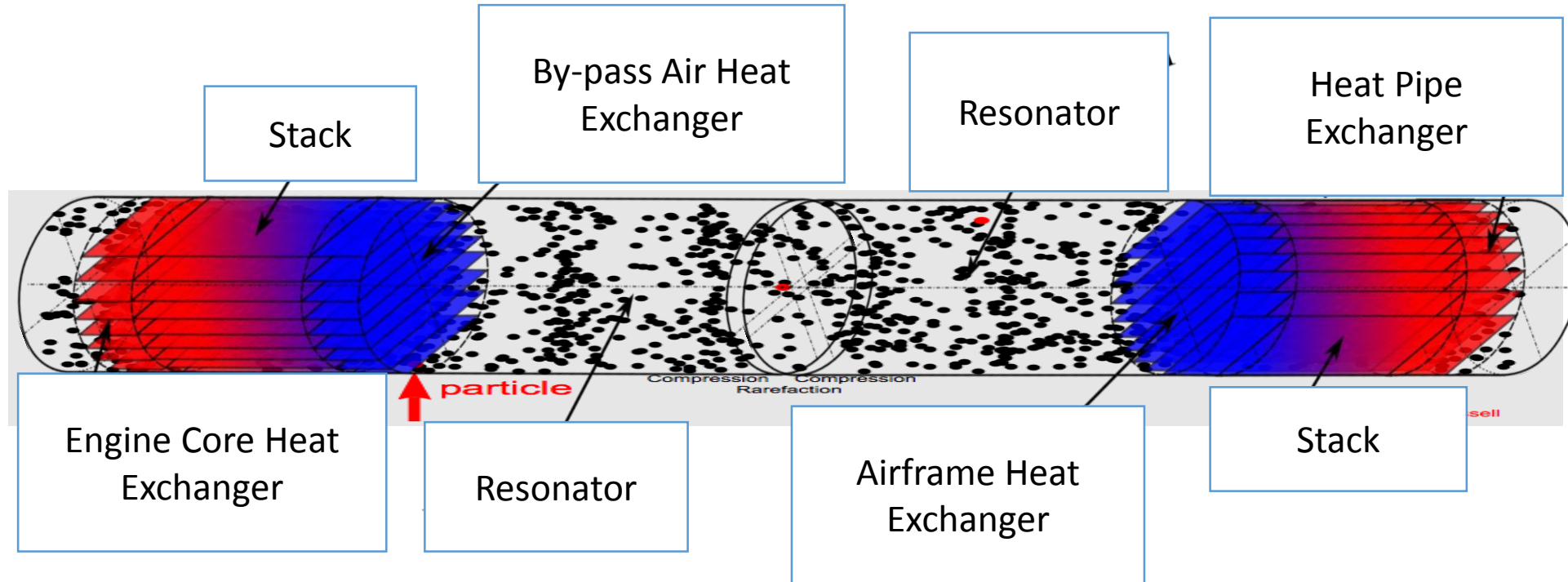

Basic principle is to use aircraft engine waste heat to produce a high intensity acoustic wave with no hot moving parts that can be used for power generation or component cooling. The temperature gradient between hot and cold HX efficiently creates the acoustic waves. **All energy is delivered through small hollow acoustic tubes.**

Are there any simple (or complex) equations for estimating the weight and volume requirements relative to the heat conversion to acoustic energy?

- Basic relationship is 30% of the heat input is converted to acoustic energy
- Primary heat transfer limit is surface area but roughly 12kW per 2 inch length of 2" diameter tube with appropriate fin structure
- Interior copper HX is drilled copper with 90% porosity so estimate per 12kW heat input is a copper mass of (400 g per 12 kW heat input (4 copper HX)) and this will provide 4kW acoustic energy to lift 1kW low grade heat (300K) to provide 5kW of high grade heat at (900K).



Acoustic Recycling Enables Effectively 100% Efficient Flight-Weight Powertrain Since Waste Energy is Reused

- Cold copper 10X more conductive at 50K,
- Enables lower voltage, increase specific power, effectively 100% efficient power electronics, cable, motor, protections, actuators, etc.
- Additively manufactured into airframe enables use of reliable less efficient, flight-weight components for more electric and future electric propulsion

Solid-state Heat Transfer Switching and Distribution

Acoustic Energy Control Method



Heat Energy Control Method

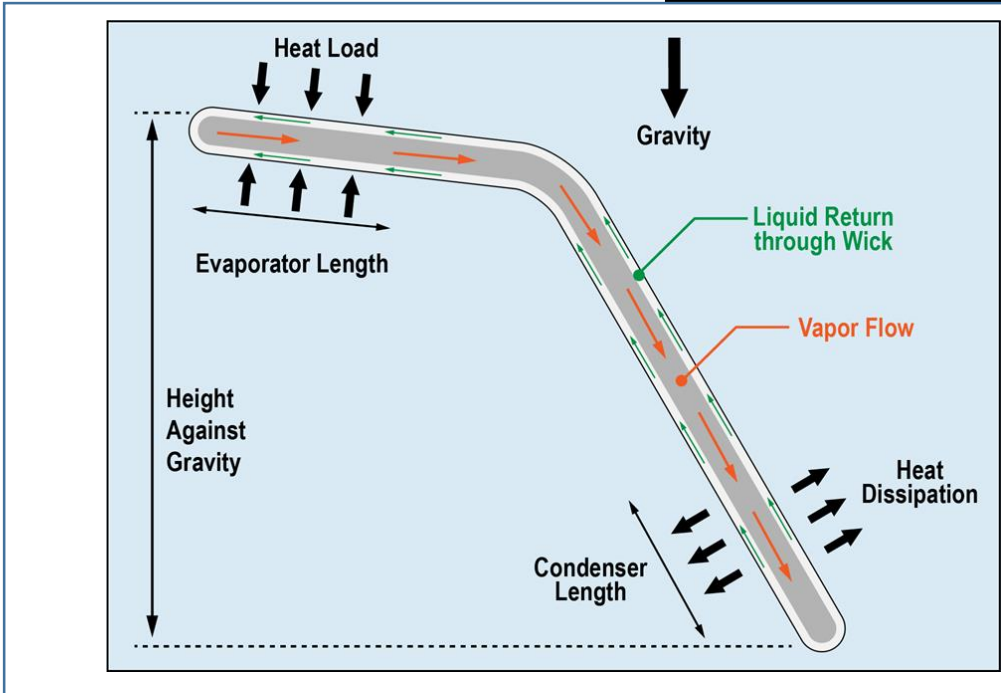

Solid-state Heat Transfer Distribution with Variable Conductance Heat Pipes

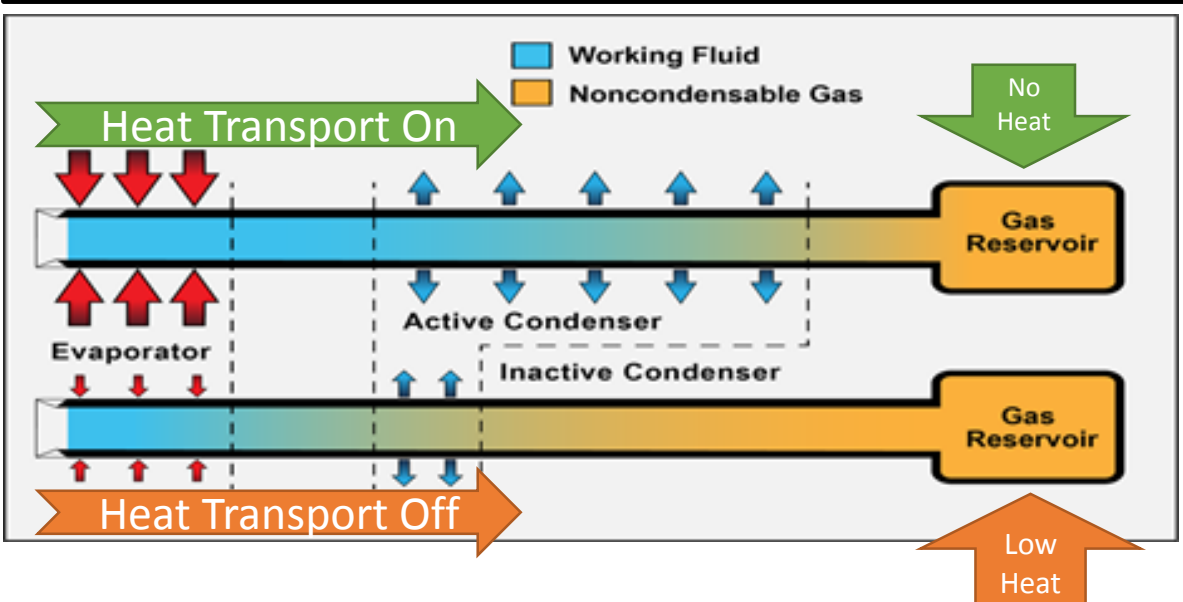

Can control where the heat goes with solid-state no moving parts via acoustic waves and/or variable conductance heat pipes

Benefits of recycled heat pumping

Solid-state (no moving part) energy recycle and distribution

- localized skin heating
 - for active lift/drag management,
- de-icing/anti-icing,
- powertrain cooling,
- cabin thermal management,
- engine recuperation,
- thrust enhancement in by-pass air
- military cloaking with thermal skin temperature shifting

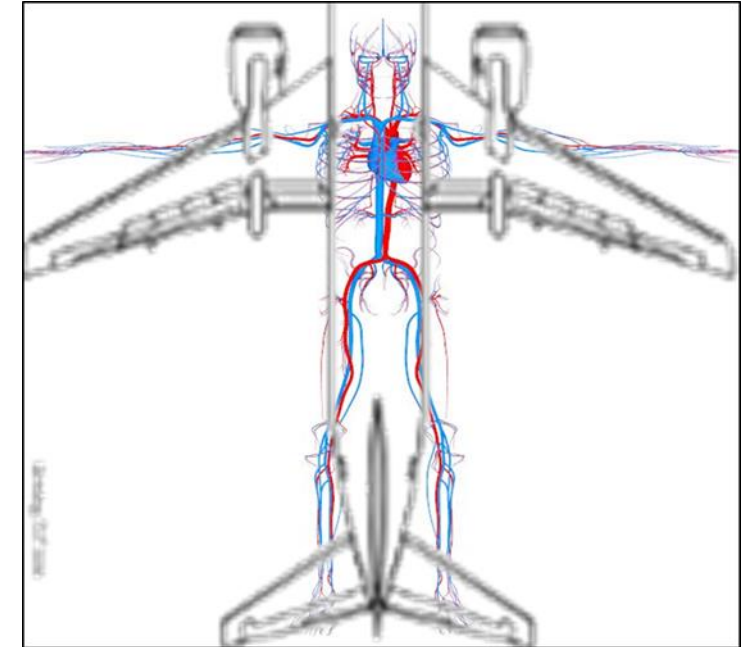

Human body circulatory system as model for aircraft

Simple solid-state control of heat flow distribution

Turbine Exit Waste Heat Extraction Installation

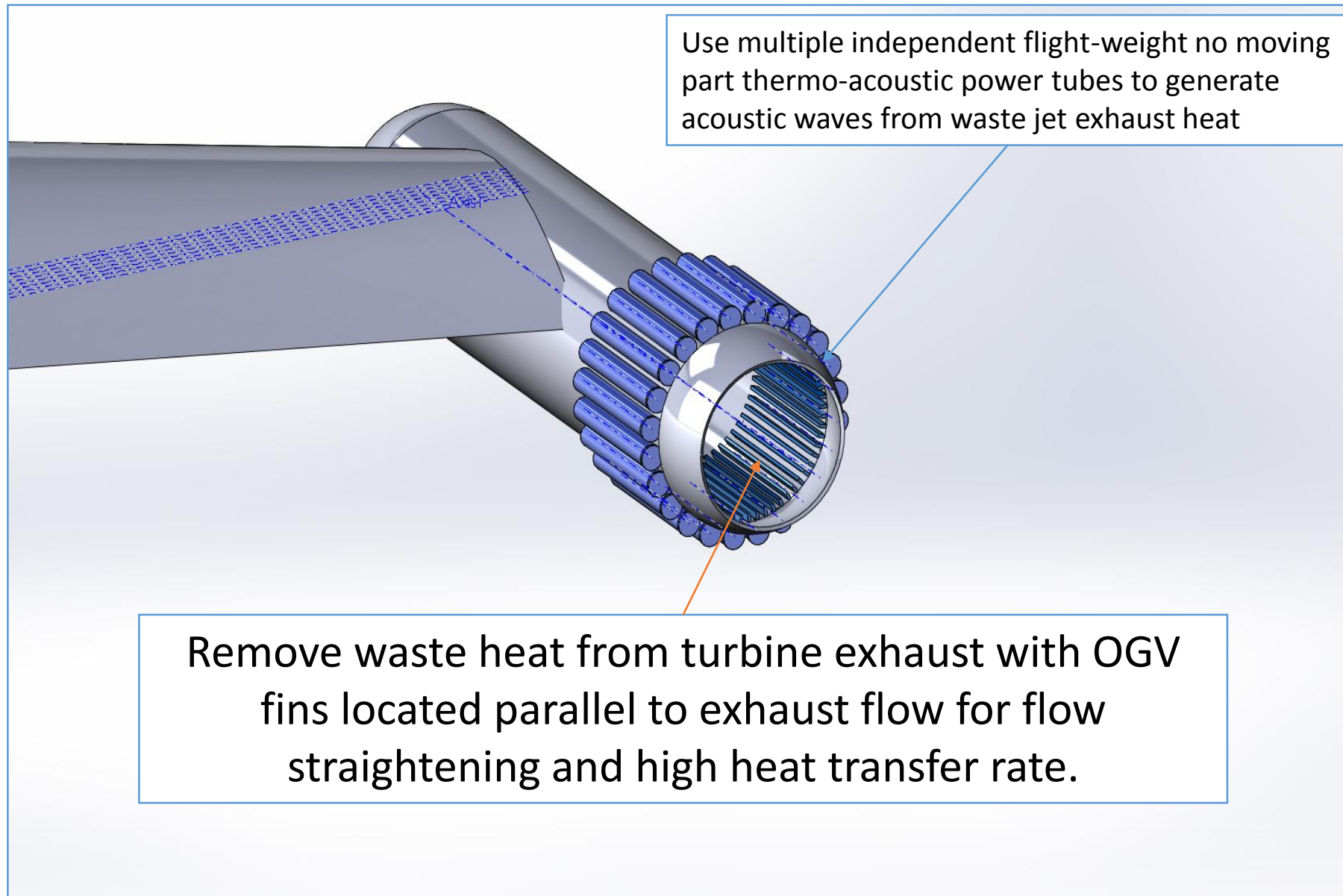

Example Wave Generation, Acoustic Tube, and Heat Pump as One Unit

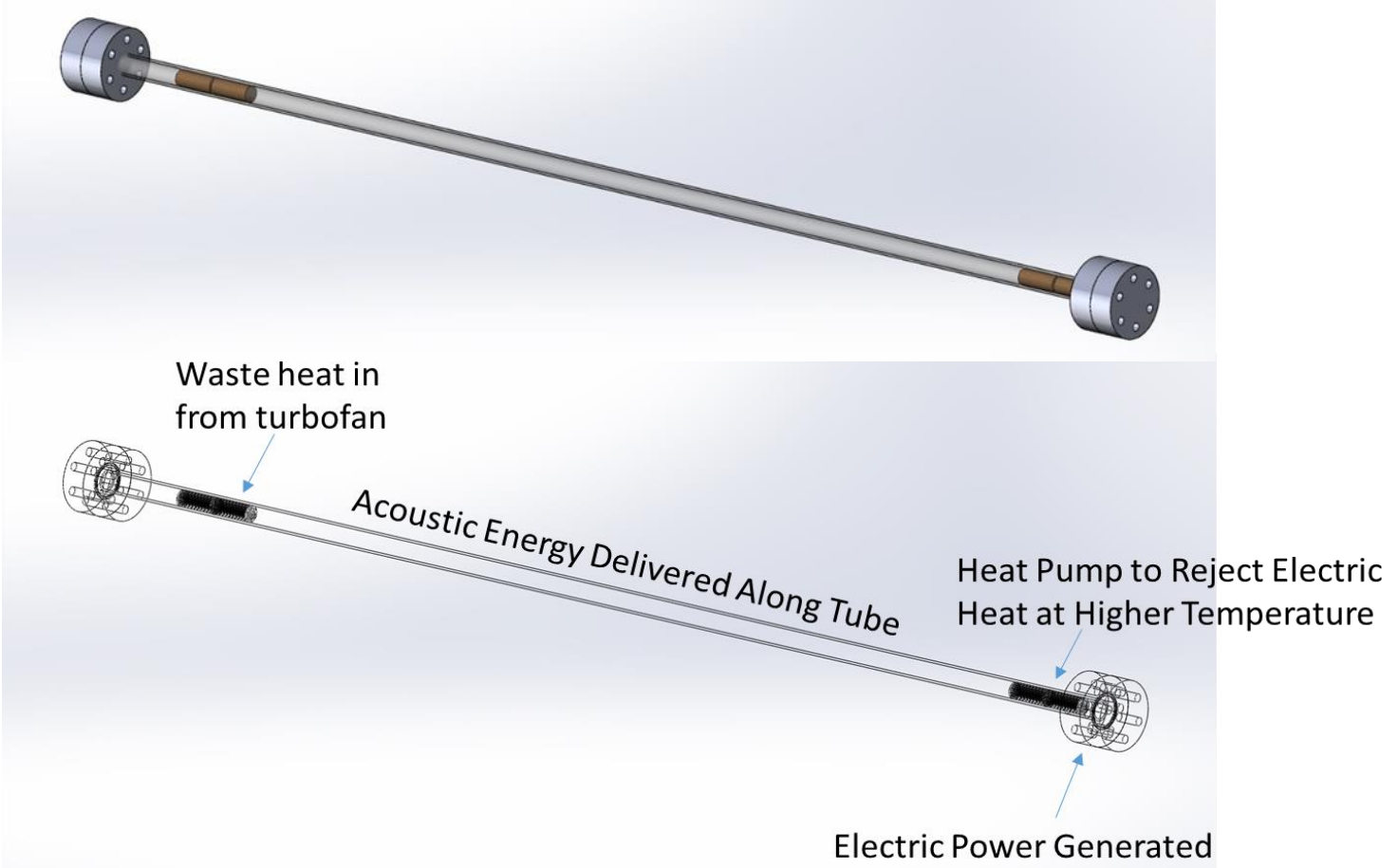

Note the power generation, distribution, and heat pump tube can be any length and curved to fit within aircraft. Electric power or cooling can be delivered anywhere in the aircraft without power conductors.

Energy transport with ducted acoustic wave

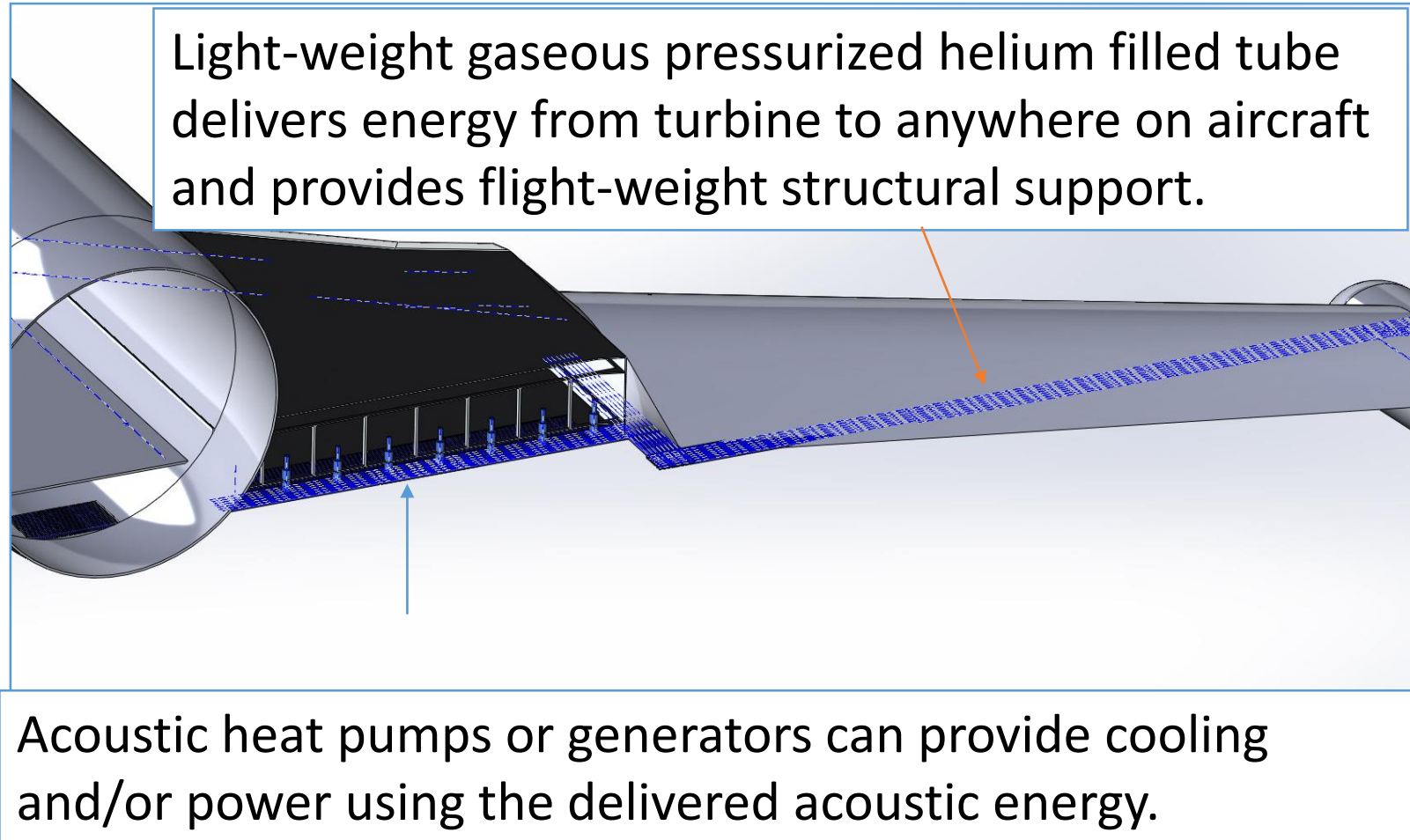

Component Cooling or Power Generation

Heat generated from electric motors is conductively removed and rejected to external fins or temperature boosted and the heat is returned to turbofan for cycle efficiency improvement.

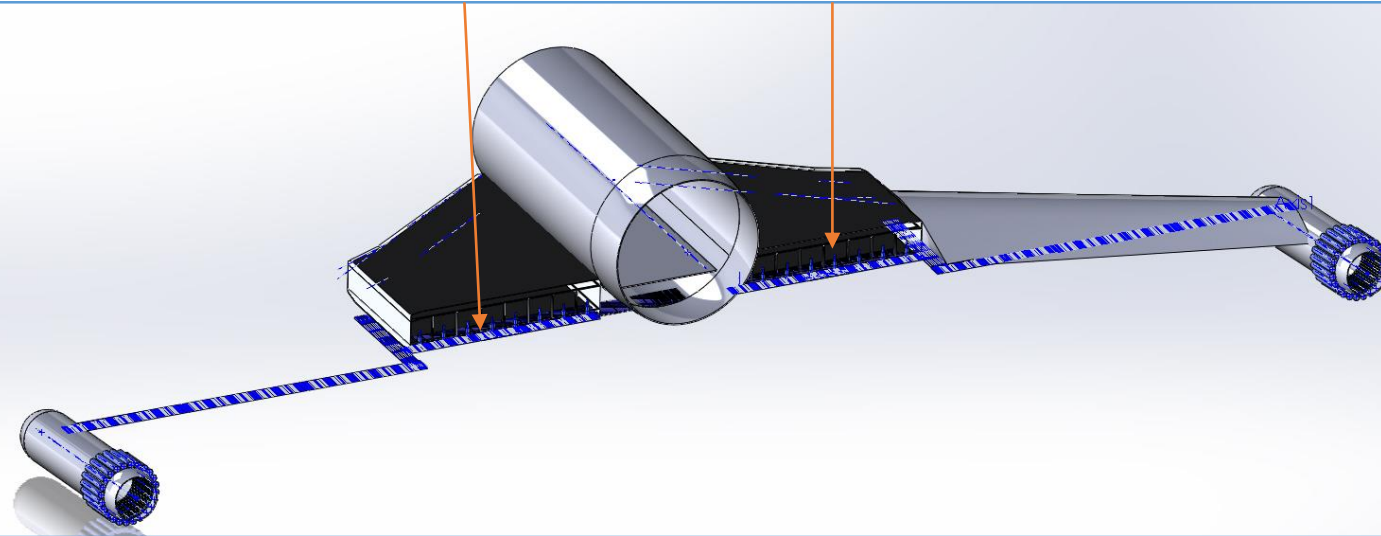

Overall system is flight-weight, efficient, structural, flexible, maintenance-free, and has no hot moving parts while enabling full vehicle heat rejection through nozzle.

Heat Recycling and Nozzle Rejection

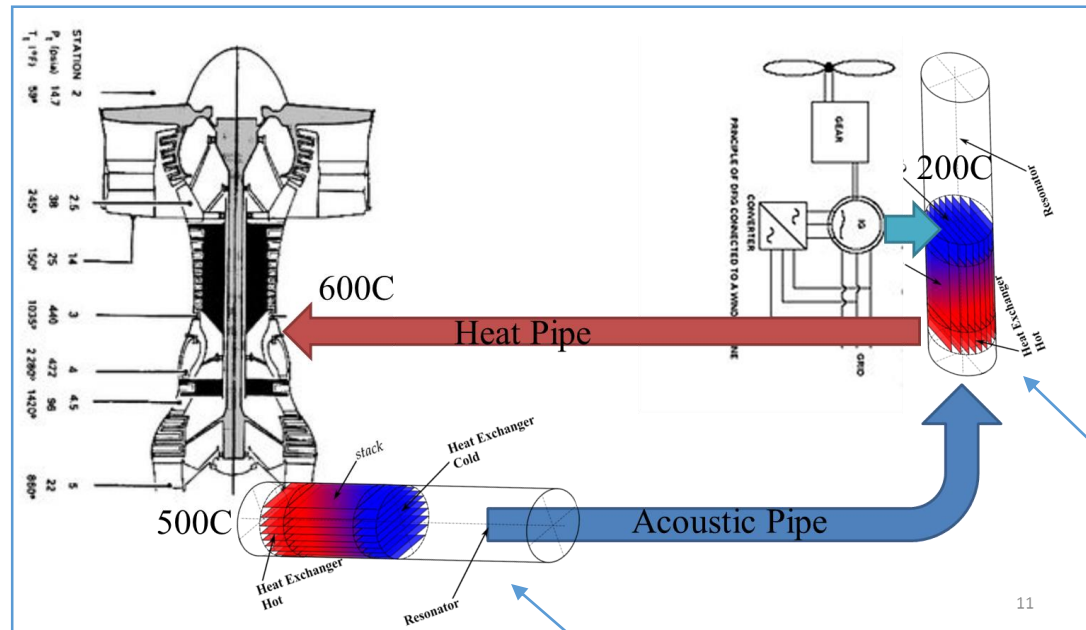

All waste heat recycled and rejected out nozzle.

Similar technology for spacecraft because of the reliability, specific power, efficiency, and no maintenance. Only technology option that has no hot moving parts, **52% Carnot WHR power efficiency** and **44% Carnot heat pump efficiency**, and is bi-directional in that it can both generate its own power and act as a heat pump all in a single contiguous hollow tube that can easily be distributed throughout the aircraft with minimal mass. The key is to optimize the system as a traveling wave device and the tools for doing that have only recently become available.

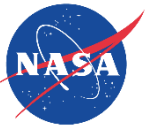

Net System Cycle Benefit (1.6% - 16%)

Example idealized net benefit calculation (16% fuel savings):

- 24MW thrust for Boeing 737 using a pair of CFM56 engines operating at 50% efficiency produce ~12MW of waste heat at 450C out the nozzle with 25C by-pass fan air surrounding it
 - 52% of Carnot Efficiency for WHR, approximately 4MW of mechanical acoustic energy available
- 1MW of low-grade 100C distributed heat sources throughout the insulated composite aircraft requires ~3MW of mechanical input to raise to 600C
 - 44% of Carnot Efficiency for heat pump, heat pipes return the 600C 4MW of energy to combustor

Best case idealized scenario achieves fuel savings of 16% while providing a flight-weight method for managing the aircraft's heat sources without adding aircraft drag and weight. All heat is used in the most optimal way and ultimately rejected out the nozzle instead of through the aircraft body.

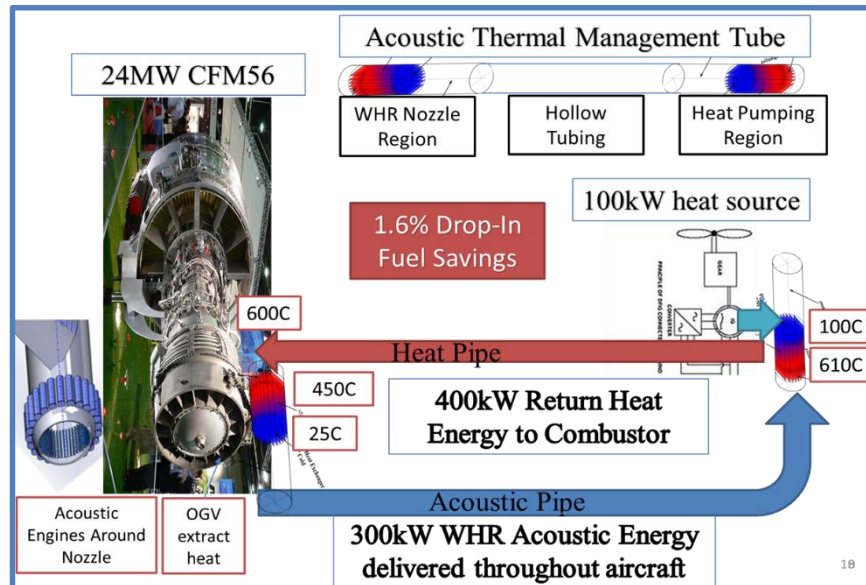

Drop-in Solution with Conservative Assumptions (1.6% fuel savings):

Note that the outlet guide vanes as currently installed in the CFM56 could act as WHR fins extracting about 10% of the nozzle waste heat so that 100kW of low-grade distributed 100C aircraft heat sources could be returned to the combustor as 400kW, 600C useful heat resulting in a potential fuel savings of 1.6%. **This changes aircraft thermal management from being a burden on aircraft performance to an asset.**

Conclusion

TREES changes aircraft thermal management from being a necessary burden on aircraft performance to a desirable asset. It improves the engine performance by recycling waste heat and ultimately rejecting all collected aircraft heat out through the engine nozzle.

- **Key Features Include:**

- **Turbofan and/or fuel cell waste heat is used to generate ducted acoustic waves that then drive distributed acoustic heat pumps and/or generate power throughout the aircraft.**
- **Low grade powertrain waste heat is converted into high grade recycled heat and returned to the engine combustor via heat pipes or additional acoustic tubes**
- **Pressurized acoustic and heat pipe tubes can be directly integrated into the airframe to provide structure support with mass reduction.**
- **Fuel savings of 16% are estimated with a purpose-built system**
- **All aircraft heat is rejected through engine nozzle, by-pass stream, outer mold line de-ice**
- **Non-provisional Patent Filed With Priority Date November 6, 2015.**

Appendix: Basic Theory

PV Power and Waves

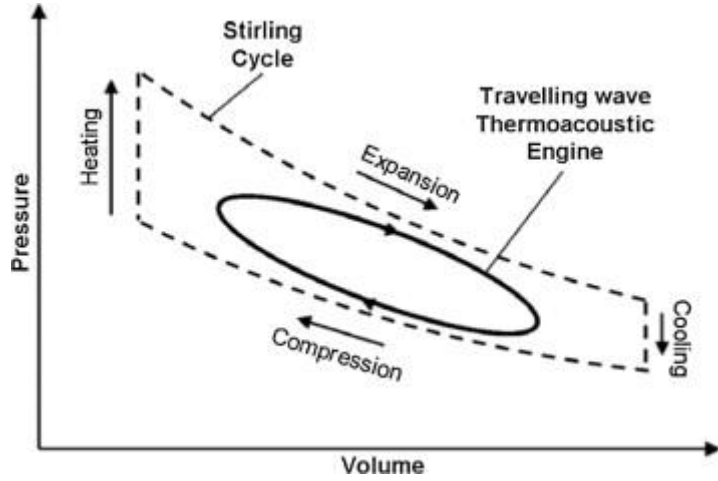
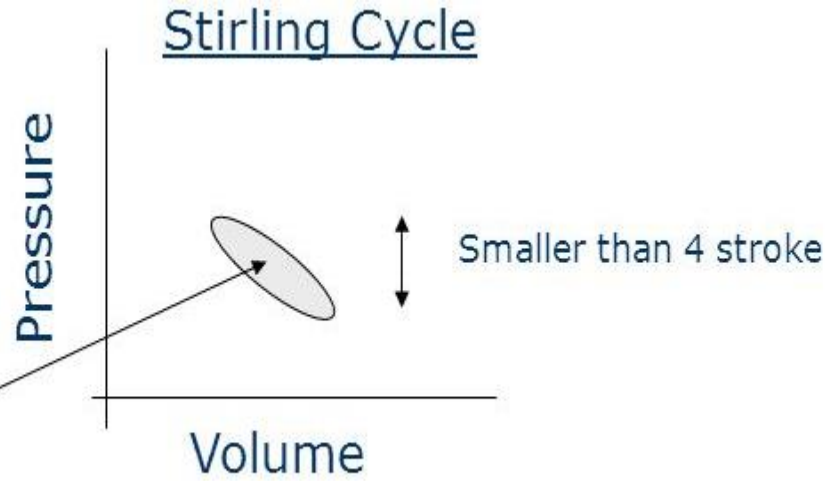
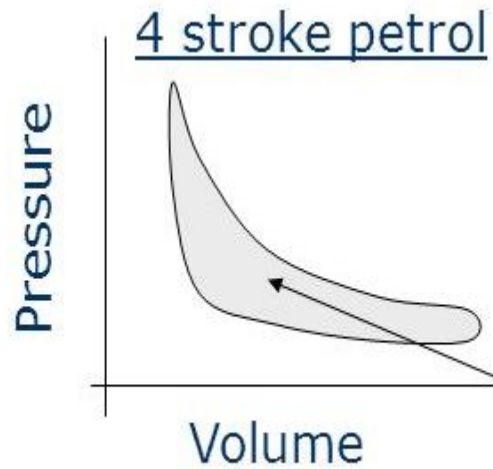

- Thermo-acoustic engines (TAE)
 - Heat in results in sound in pipes
- Thermo-acoustic coolers (TAC)
 - Sound in results in temperature difference
- Travelling wave (Both)
 - Pressure and velocity in phase
- Standing wave (Both)
 - Pressure and velocity nearly 90 degrees out of phase
- Only travelling waves carry power but
 - Standing wave engines do work well, they always have a small in phase component, i.e. always less than 90 degrees

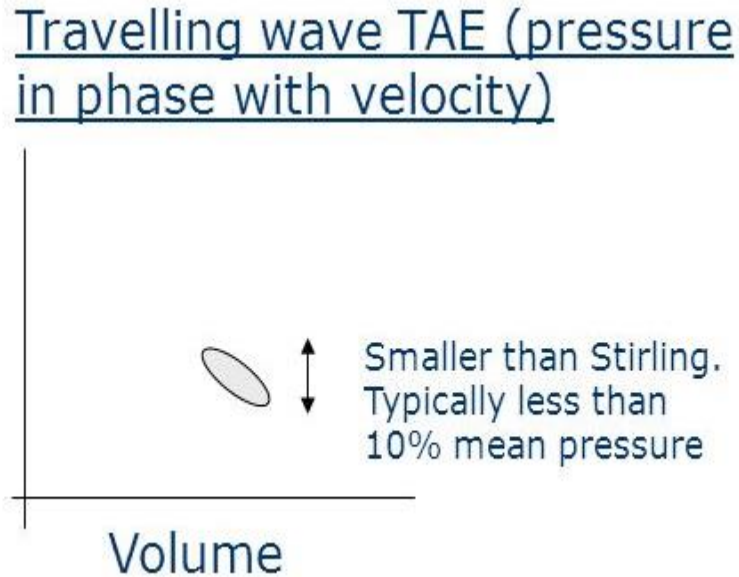
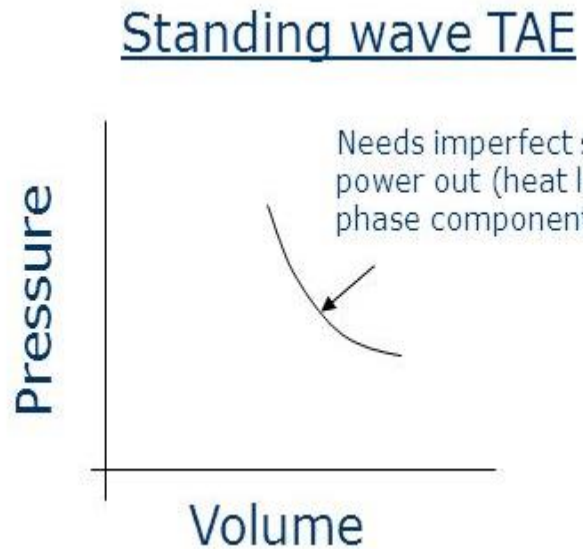

STANDING WAVES

- Are stationary (as opposed to travelling waves)

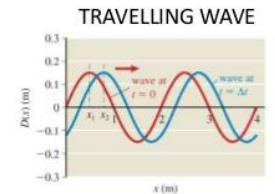
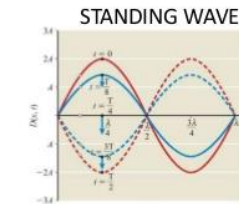

Vs

Figure 14-29 Displacement versus position for a standing wave on a string during the first half of a cycle. The position x is expressed in multiples of the wavelength λ .

Figure 14-30 The graphs of displacement versus position at time $t = 0$ and $t = \lambda/4$ for a sinusoidal wave travelling from left to right.

Alpha Stage Physics

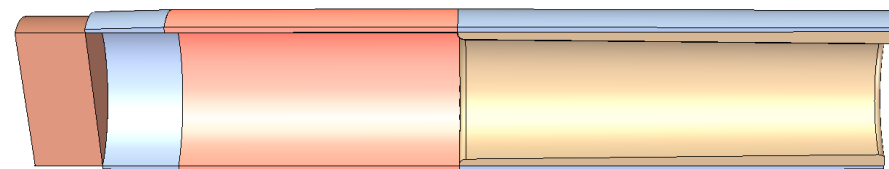
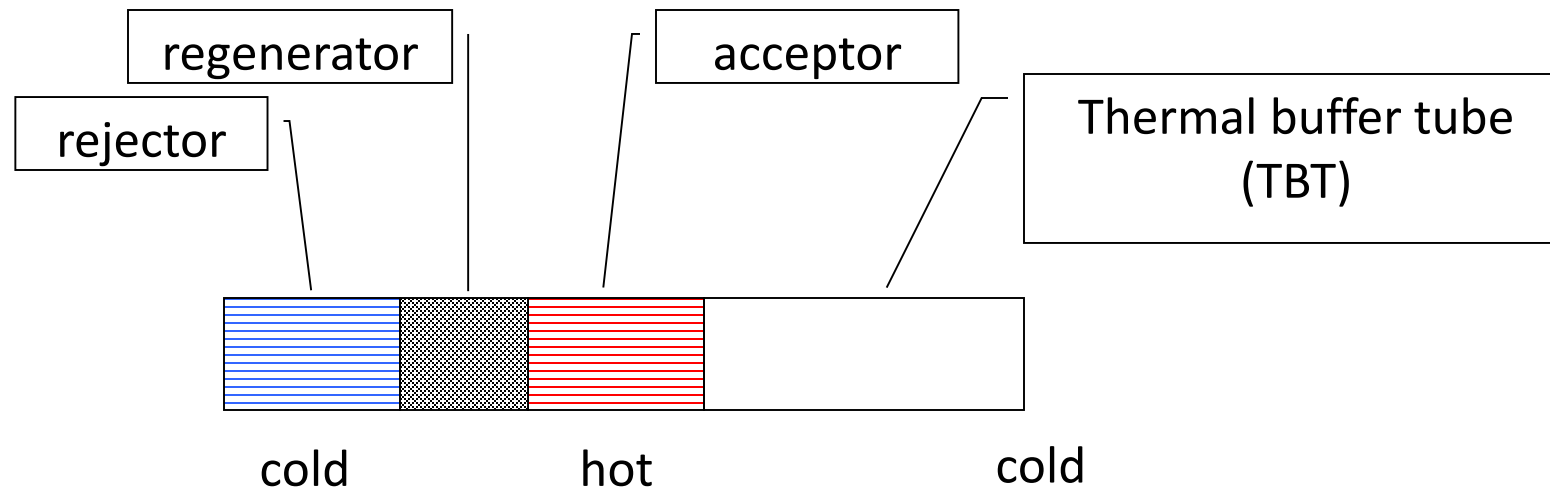

Simplified physical appearance

Thermodynamic Cycle

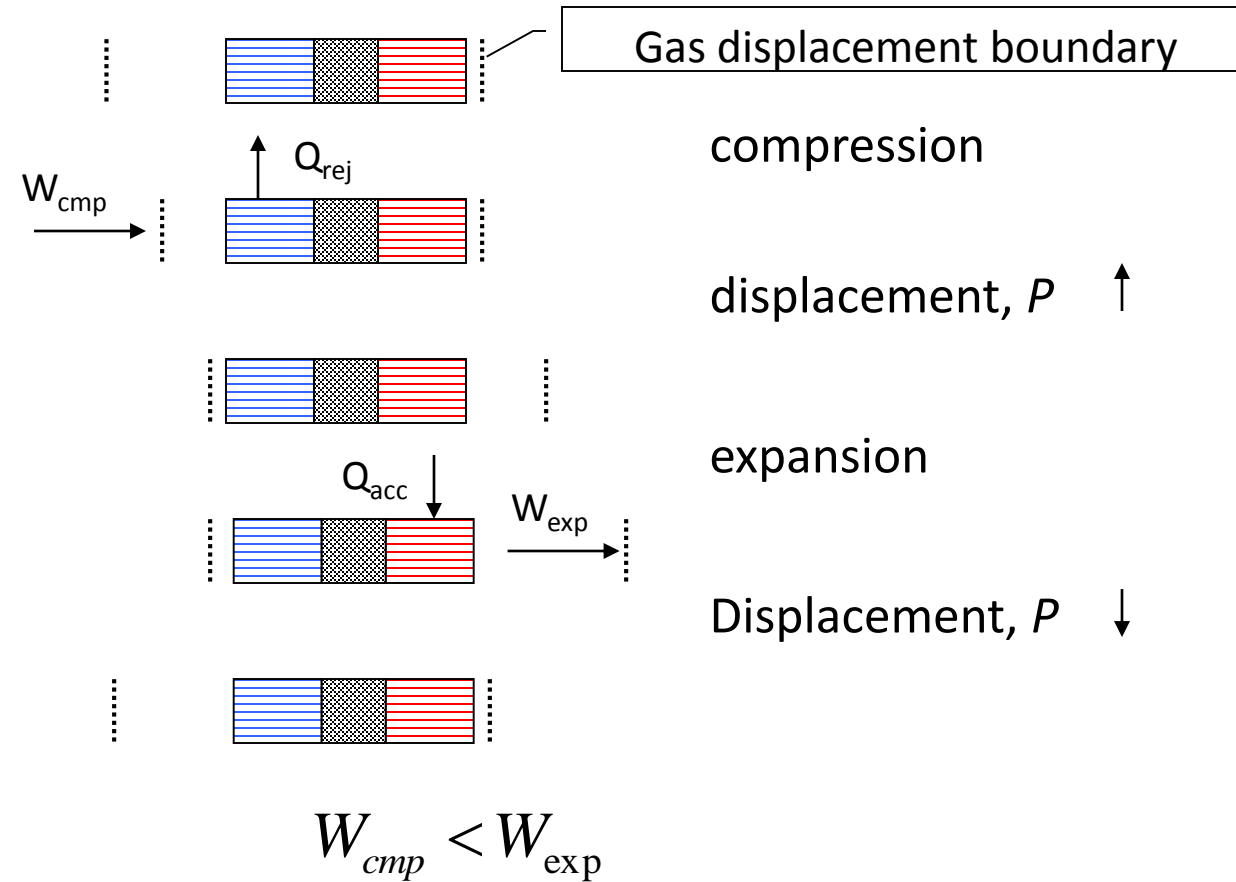

Thermal Buffer Tube/Pulse Tube

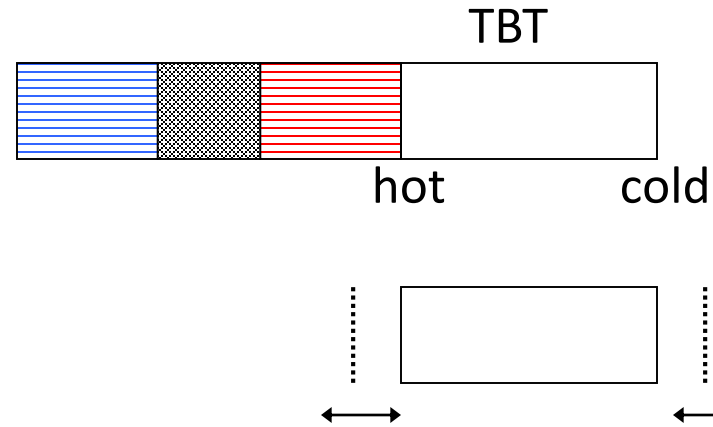

- Isolates hot from cold parts
- Transmits PV power, like a compliant displacer
- Adiabatic (ideally)
- Except for jets, streaming, turbulence, etc.

Two stage cascade

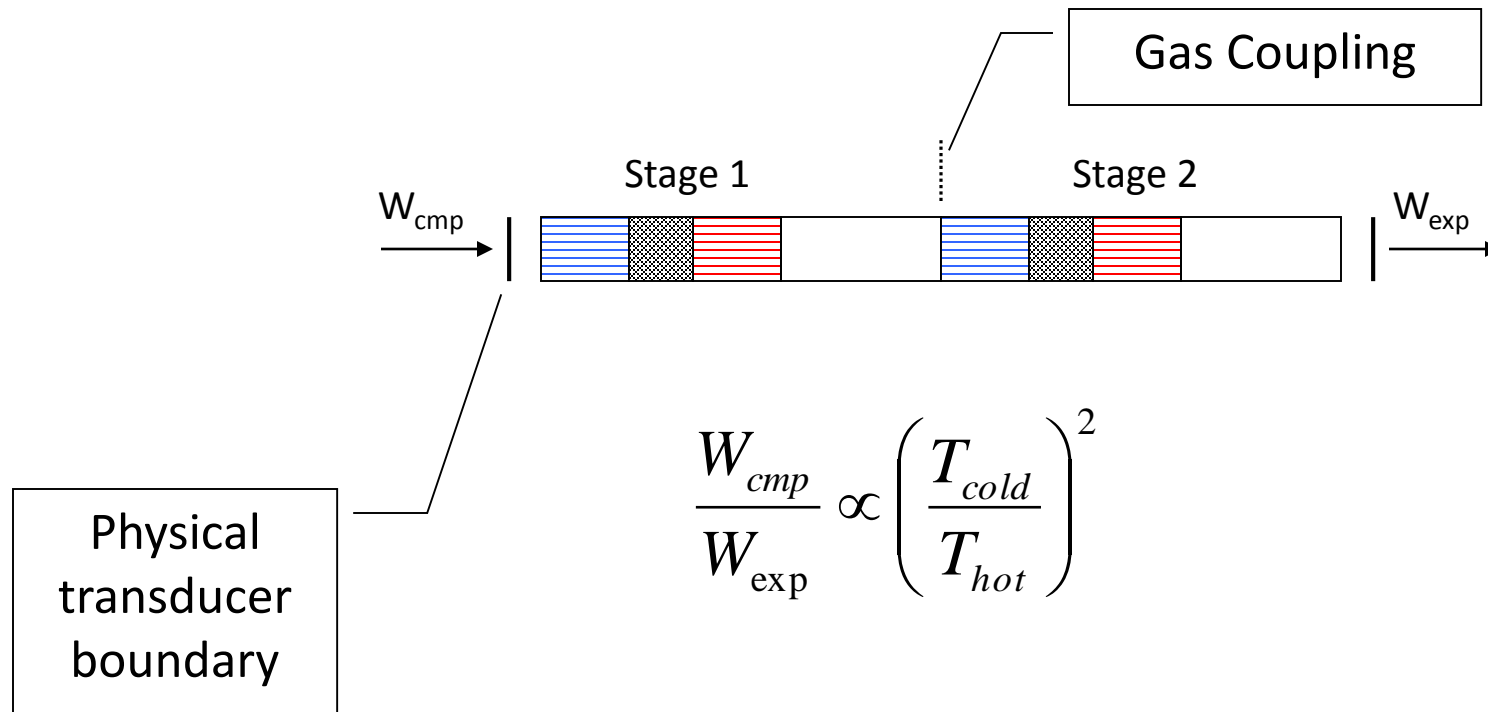

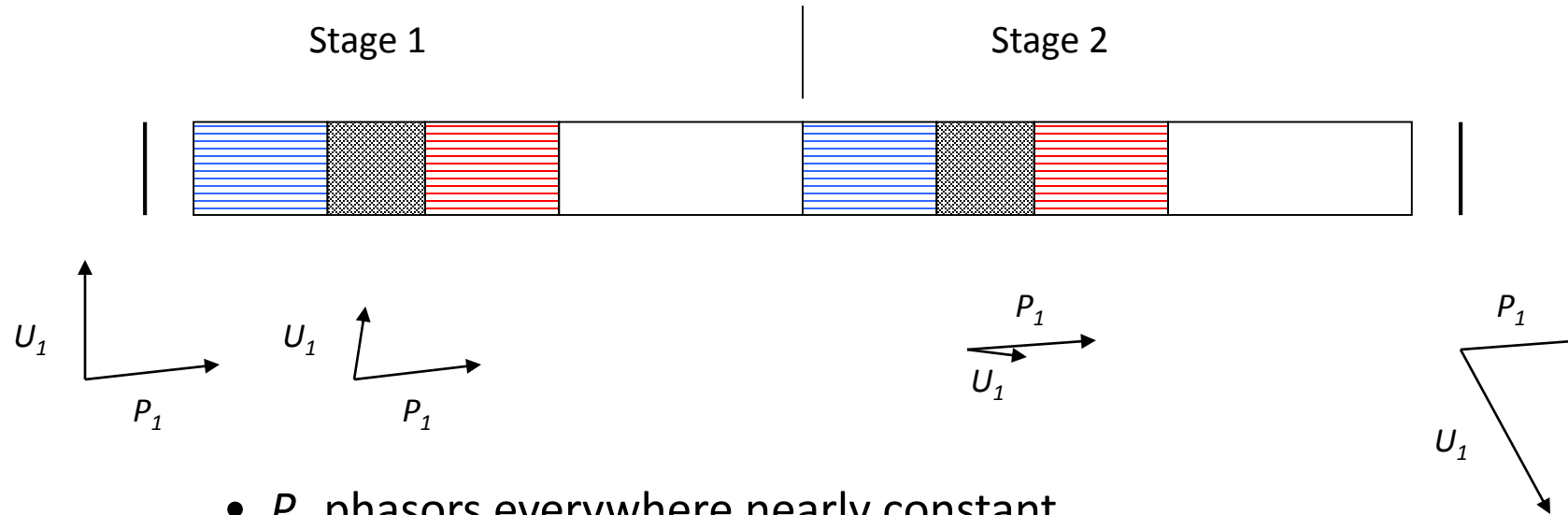

- P_1 phasors everywhere nearly constant
- U_1 phasors progressively lag due to volume (compliance)
- Ideally, P_1 and U_1 in phase in regenerators
- Gas inertia (inertance) can be used to counter U_1 lag
- E.g. Swift inter-stage inertance tube (see reference 4)

End Transducer Options

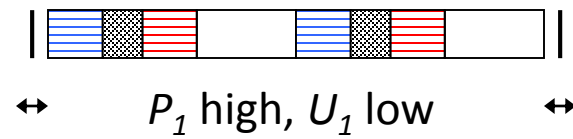

High Impedance
(Piezo or magnetostrictive)

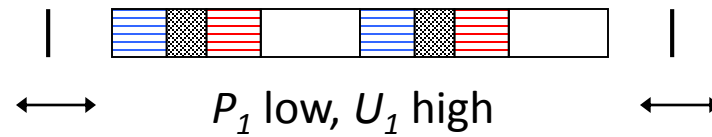

Low Impedance
(Moving Magnet actuator)

Impedance is P_1 / U_1

High Impedance Matching

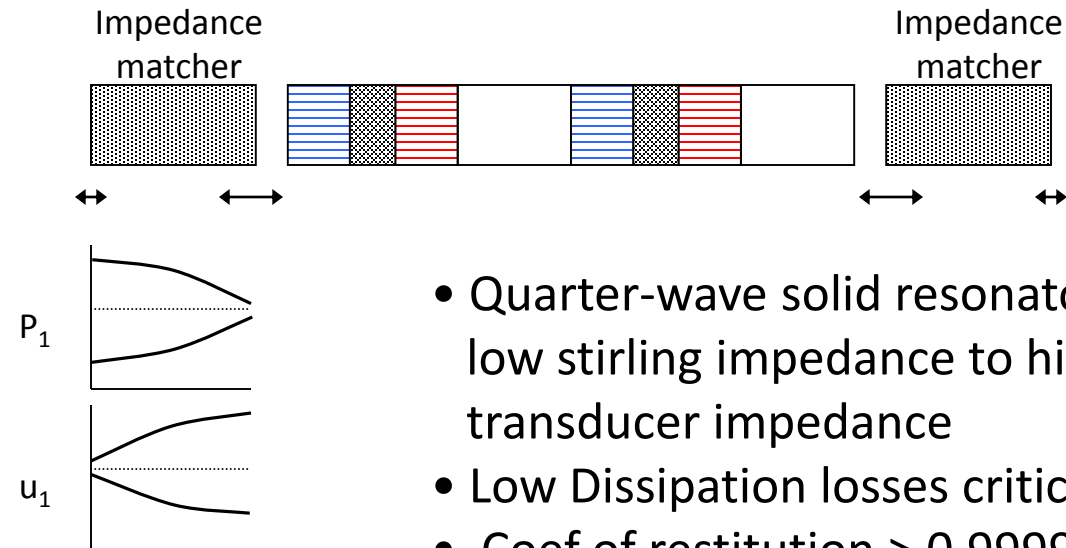

- Quarter-wave solid resonator converts low stirling impedance to high transducer impedance
- Low Dissipation losses critical
- Coef of restitution > 0.9999
- Three-dimensional effects?
- Piezo transducers prefer higher frequency than stirling thermodynamics allows

Electro-acoustic transducer (size & weight versus capacity)?

- Not required since can use standing wave driver (see Swift ref. 1)

Key Point is the type and size of driver can be very small because of thermo-acoustic amplification from multiple stages in series. Next series of slides explains this.

And note that TREES uses a traveling wave without the loop shown in F1. b) by using an RC Helmholtz terminator.

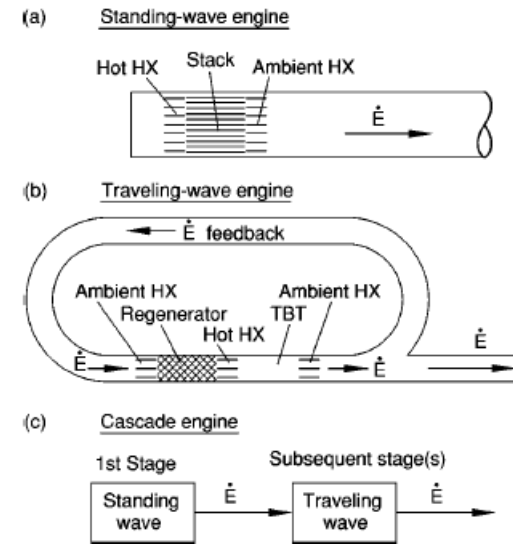
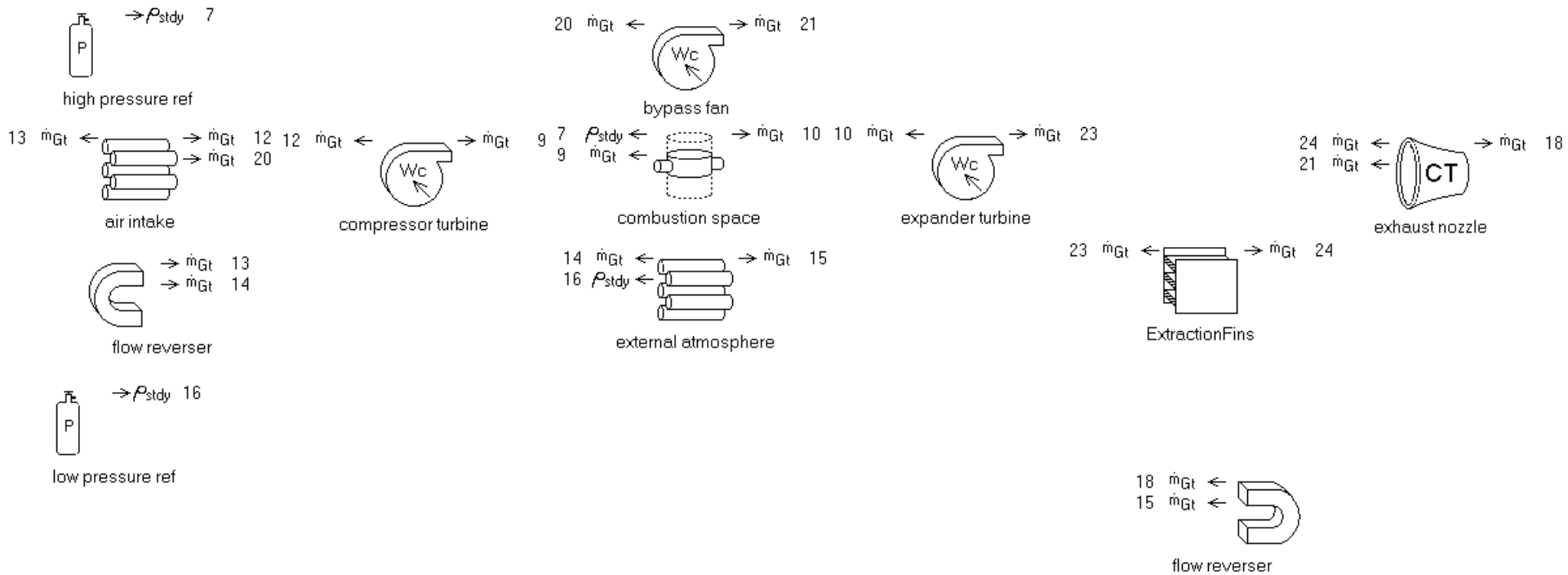

FIG. 1. Some thermoacoustic engine topologies. HX=heat exchanger, TBT=thermal buffer tube, \dot{E} =acoustic power. (a) In a standing-wave engine, the temperature difference between the hot heat exchanger and the ambient heat exchanger falls across the stack, whose pore dimensions are of the order of a few thermal penetration depths. Here, the standing-wave engine is in a simple cylindrical resonator, closed at its hot end and delivering acoustic power through its ambient end. (b) In a traveling-wave engine, the temperature difference between the hot heat exchanger and the ambient heat exchanger falls across the regenerator, whose pore dimensions are much smaller than a thermal penetration depth. Acoustic power can only be produced if some is fed into the ambient end of the regenerator, such as through the acoustic feedback path shown here. (c) The cascade engine combines one standing-wave engine with one or more traveling-wave engines. The standing-wave engine supplies the acoustic power needed at the ambient end of the adjacent traveling-wave engine.

Basic Turbofan Model with Core Extraction



What are the pressure and duct size relationship to acoustic/thermal energy transfer?

- Pressure = $P_m + A_{pc} * \text{Cos}(\omega * t) + A_{ps} * \text{Sin}(\omega * t)$ [Pa]
- Mass flow rate = $M_m + A_{mc} * \text{Cos}(\omega * t) + A_{ms} * \text{Sin}(\omega * t)$ [kg/s]
- Acoustic Power = $0.5 * (A_{pc} * A_{mc} + A_{ps} * A_{ms}) / \text{Rho}$
- Rho = Gas density
- Mass flow rate = $\text{Rho} * U * A$
- Volume Flow Rate = $U * A$

The two representations are completely equivalent, as can be seen by applying the cosine angle-addition formula to the cosine series

$$\begin{aligned} \sum_{n=1}^{\infty} c_n \cos(n\omega t + r_n) &= \sum_{n=1}^{\infty} (c_n \cos r_n) \cos n\omega t - \sum_{n=1}^{\infty} (c_n \sin r_n) \sin n\omega t \\ &= \sum_{n=1}^{\infty} a_n \cos n\omega t + \sum_{n=1}^{\infty} b_n \sin n\omega t \end{aligned}$$

Note pressure and volume flow rate are oscillating – maximizing pressure swing amplitude and frequency increases specific power

Does acoustic energy flow suffer frictional type pressure drop, similar to a fluid pressure drop?

- Very specific example for simple 7 m length tube:
 - 32kW Incoming acoustic wave in a 4.72 cm diameter tube will see a 26% power drop after 7 m of travel. Mean pressure is 3 Mpa and 84 Hz. This is not optimized. Can recover using narrowing tube approach described in page 9 and ref. 4. But gives an idea of potential losses with simple non-tapered very narrow tubes (about 1% per foot).
- And the main point is this acoustic energy is free from the jet core

What percentage of the Carnot cycle efficiency are you seeing in lab testing?

- 52% of Carnot cycle efficiency in converting 850C heat input to mechanical acoustic energy output
- And for converting mechanical acoustic energy to high grade heat flux it depends on heat load:

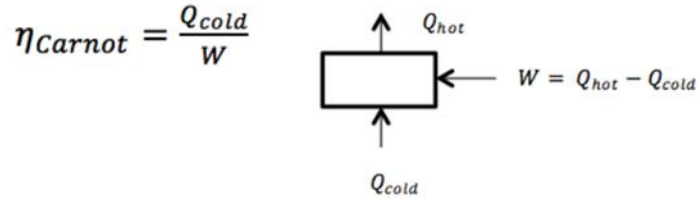

$$\% Carnot = \frac{\eta_{Cryocooler}}{\eta_{Carnot}}, \text{ Where:}$$

$$\eta_{Cryocooler} = \frac{\text{Lift}}{P_{input}} \text{ and}$$

P_{input} = power supplied to the system, in this case, electricity

Thus, the overall equation for % Carnot efficiency is:

$$\% \text{ Carnot efficiency} = \frac{\text{Lift} \cdot (T_{hot} - T_{cold})}{P_{input} \cdot T_{cold}}$$

To determine the % Carnot efficiency for a CryoTel CT all we need is: (35+273=308K), $T_{cold}=77K$, $P_{input}=160$ Watts for the CryoTel CT, and

$$\% \text{ Carnot efficiency} = \frac{10W \cdot (308K - 77K)}{160W \cdot 77K} = 18\%$$

$$\eta_{Carnot} = \frac{Q_{cold}}{Q_{hot} - Q_{cold}}$$

Where Q_{cold} is the energy of the cold reservoir, and Q_{hot} is the energy of the hot reservoir. Energy of a reservoir is proportional to the temperature, so we can convert Q to T but not

$$\eta_{Carnot} = \frac{T_{cold}}{T_{hot} - T_{cold}}$$

Because no cryocooler could be more efficient than a cryocooler using the Carnot cycle percentage of the Carnot efficiency. The equation to determine the % of Carnot efficiency

$$\% Carnot = \frac{\eta_{Cryocooler}}{\eta_{Carnot}}, \text{ Where:}$$

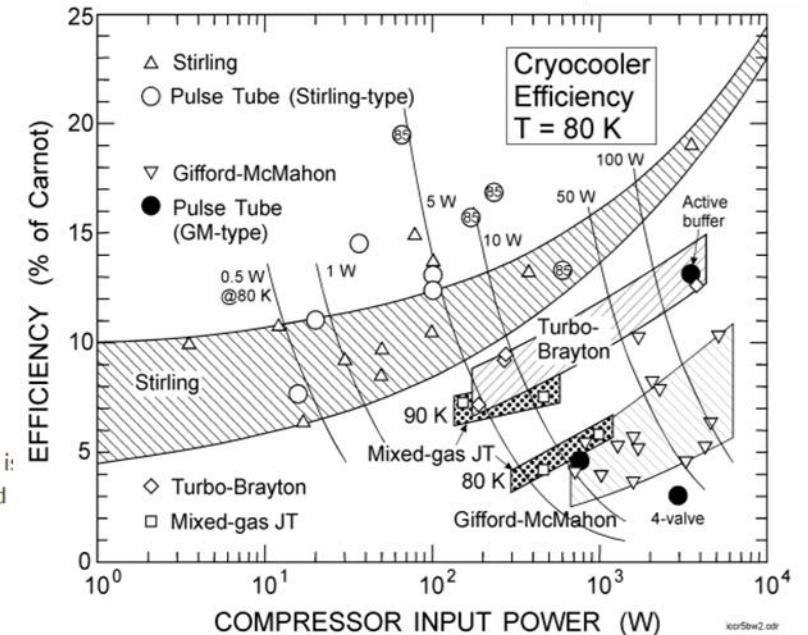

% Carnot Efficiency varies from 15% for small units to 44% for large units

Lip anti-icing

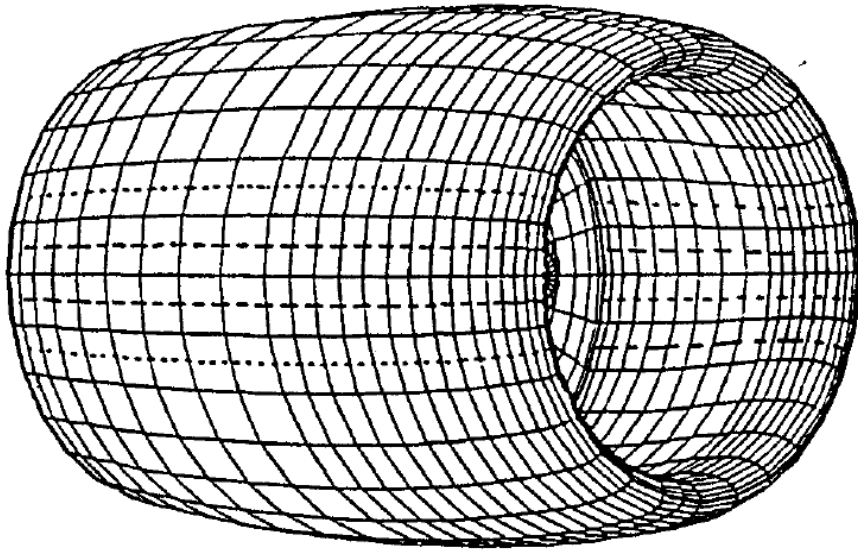

Fig. 1 Panel modeling of the nacelle surface geometry.

Table 1 Flow conditions for sample cases

	Case 1	Case 2	Case 3	Case 4
Condition	Hold ^a	Climb ^b	Cruise ^b	Descent ^a
Altitude, ft	15,000	5000	22,000	1500
M_∞	0.48	0.41	0.6	0.38
T_∞ , °C	-12.22	-12.22	-30.00	-10.00
P_∞ , KPa	58.1	86.9	44.7	97.0
T_{air} , °C	276	384	298	177
MED, μm	20	20	20	20
LWC, g/m^3	0.38	0.38	0.14	0.42

^aContinuous maximum icing conditions. ^bIntermittent maximum icing conditions.

1MW acoustic energy could be delivered to lip area to pump up free-stream air from -30C to 300C. Effectively can provide continuous 2MW of hot air at 300C.

This is sufficient for anti-ice of entire aircraft without using bleed air or electric power.

References

1. Swift. JASA, 114(4), 2003 – Fig. 1c
2. Kim, IECEC 2006-4199
3. Timmer, JASA, 143, 841, 2018
4. Swift, LA-UR 11, 2011
5. Al-Khalil, J. Propulsion, 89-0759
6. Gelder, NACA TN 2866, 1953