

# Exploration Toilet Integration Challenges on the International Space Station

Melissa Ann Borrego<sup>1</sup>  
*Aerodyne Industries, Houston, TX 77058*

Yadira Garcia Zaruba<sup>2</sup>  
*HX5, LLC, Houston, TX 77058*

*and*

James Lee Broyan, Jr.,<sup>3</sup> Melissa K. McKinley,<sup>4</sup> and Shelley Baccus<sup>5</sup>  
*NASA Johnson Space Center, Houston, TX 77058*

**On the International Space Station (ISS) there are currently two toilets. One is located in the Russian's Service Module and the other is located in the U.S. segment's Node 3. A new Exploration Toilet will be integrated next to the existing Node 3 Waste and Hygiene Compartment (WHC). The Toilet will be evaluated as a technology demonstration for a minimum of three years. In addition, it will support an increase in ISS crew size due to Commercial Crew flights to ISS. The Toilet is designed to minimize mass and volume for Orion, the first Exploration vehicle. Currently ISS does not have a designated volume for an additional Toilet. Furthermore, operating the Toilet on ISS presents a different set of challenges as it must integrate into existing vehicle systems for urine processing. To integrate the Toilet on ISS, a suite of hardware was developed to provide mechanical, electrical, data, and fluid interfaces. This paper will provide an overview of the Toilet Integration Hardware design as well as the engineering challenges, crew interface provisions and vehicle integration complexities encountered during the concept and design phases.**

## Nomenclature

<i>ACY</i>	=	Russian acronym for Toilet
<i>AES</i>	=	Advanced Explorations Systems
<i>ARED</i>	=	Advanced Resistive Exercise Device
<i>BPA</i>	=	Brine Processor Assembly
<i>cm</i>	=	centimeter
<i>CPU</i>	=	Central Processing Unit
<i>CTB</i>	=	Cargo Transfer Bag
<i>DAN</i>	=	Domain Adapter Node
<i>EDV-Y</i>	=	Russian acronym for Urine Tank
<i>EV</i>	=	Avionic Systems Division

---

<sup>1</sup> Habitation Project Engineer, JSC Engineering, Technology, and Sciences (JETS) Contract, Crew Systems (JE15), Aerodyne Industries, 2224 Bay Area Blvd, Houston TX 77058.

<sup>2</sup> Habitation Systems Engineer, JSC Engineering, Technology and Sciences (JETS) Contract, Crew Systems (JE15), HX5, LLC, 2224 Bay Area Blvd, Houston TX 77058.

<sup>3</sup> Advanced Exploration Systems Logistics Reduction Project Manager, Crew and Thermal Systems Division, NASA Johnson Space Center, 2101 NASA Parkway, Houston TX 77058/Mail Stop EC7.

<sup>4</sup> Habitation Project Manager, Crew and Thermal Systems Division, NASA Johnson Space Center, 2101 NASA Parkway, Houston TX 77058/Mail Stop EC7.

<sup>5</sup> Deputy Branch Chief, Tools, Equipment and Habitability Systems Branch, Crew and Thermal Systems Division, NASA Johnson Space Center, 2101 NASA Parkway, Houston TX 77058/Mail Stop EC7.

<i>FPGA</i>	=	Field-Programmable Gate Array
<i>ft</i>	=	feet
<i>HEPA</i>	=	High Efficiency Particulate Accumulator
<i>Hz</i>	=	Hertz
<i>in</i>	=	inches
<i>ISS</i>	=	International Space Station
<i>LED</i>	=	Light Emitting Diode
<i>m</i>	=	meter
<i>MCTB</i>	=	Multipurpose Cargo Transfer Bag
<i>MISL</i>	=	Modular Interchangeable Stackable Layers
<i>NASA</i>	=	National Aeronautics and Space Administration
<i>PTU</i>	=	Pretreated Urine
<i>QD</i>	=	Quick Disconnect
<i>RPC</i>	=	Remote Power Controller
<i>T2</i>	=	Treadmill 2
<i>UMS</i>	=	Urine Monitoring System
<i>UPA</i>	=	Urine Processor Assembly
<i>US</i>	=	United States
<i>UTS</i>	=	Urine Transfer System
<i>UWMS</i>	=	Universal Waste Management System
<i>VDC</i>	=	Volts Direct Current
<i>WHC</i>	=	Waste and Hygiene Compartment
<i>WRS1</i>	=	Water Recovery System 1
<i>WRS2</i>	=	Water Recovery System 2

## I. Introduction

SPACE exploration is moving beyond low earth orbit with evolving plans for space outposts in cis-lunar space (e.g. Gateway), Mars transit missions, and surface habitats. A reliable life support system is critical for human space exploration and the National Aeronautics and Space Administration (NASA) has been developing life support systems for long duration tests on the International Space Station (ISS) to support future Gateway and longer missions<sup>1</sup>. The goal is to utilize ISS to prove system performance, identify design deficiencies, and reduce uncertainty in component life expectancy. NASA is also developing and providing life support for shorter Orion missions that will initially travel to the Gateway<sup>2</sup>.

Although life support for ISS, Gateway and Orion are different for many systems, a common system design is being implemented for human metabolic waste collection, i.e. toilet. Since Orion externally appears similar to the Apollo capsule, one might assume its toilet design simply needs to be upgraded. However, Apollo did not have a dedicated toilet and used simple plastic bags with an adhesive flange for attachment to the astronaut for feces collection. The bag was detached, rolled up, and stored. For the all-male crew, urine was collected with a roll-on cuff connected to a collection bag or captured in a small hand held honeycomb lined cylinder before venting it overboard. Both were considered highly undesirable by the astronauts due to frequent escapes which created an unhygienic environment<sup>3</sup>. All United States (US) and Russian missions since Apollo have had a dedicated toilet system that utilized air flow and positive waste capture to improve astronaut and vehicle hygiene. The US Space Shuttle toilet was relatively large and had capacity for extended missions. An experimental US toilet was developed for long duration use, flew four times on the Space Shuttle, and had the capability to change out full fecal containers. Although the experimental US toilet was successful, it was not fully developed for ISS. The ISS currently has two Russian developed toilets; one in the Russian Service Module and one in the US Node 3. Both Russian toilets require a relatively large installed volume and common components that are regularly replaced to maintain long duration operation.

All current US exploration missions will use the relatively compact Orion capsule for launch, transit to cis-lunar space, and reentry. Round trip mission durations for Orion are up to 21 days. Gateway missions will initially be relatively short 30 day missions but will increase in duration and require more closed loop ISS-derived life support systems<sup>1,2</sup>. Volume and mass are both very scarce on Orion and planned Gateway vehicles compared to ISS, so a smaller, more compact, but fully functional toilet system is required for Exploration missions. Both the Space Shuttle and ISS Russian toilet systems have too large of an installed volume and component replacement mass.

NASA and Collins Aerospace began development of a new exploration toilet called the Universal Waste Management System (UWMS) in 2014 to meet the needs of both Orion and Gateway missions<sup>4</sup>. The official ISS operations nomenclature for the UWMS is Toilet. Toilet will be used throughout the paper when referencing the new exploration toilet. Orion will not recover water from the urine and will include a mild pretreat before venting. Gateway will eventually require a stronger urine pretreatment to enable water recovery. A common Toilet core is being developed for Orion compatibility with extensibility for Gateway water processing. The development of the two configurations with different urine pretreatment systems will be detailed in a future paper.

Development of the Integration Hardware to test the Toilet on ISS is nearing completion. This will allow for the Toilet to be quickly launched and tested in microgravity to prove its functionality before the first Orion crewed flight. It will then begin a multi-year test to determine its component reliability prior to incorporation into Gateway and future Exploration vehicles.

## **II. Integrating the New Exploration Toilet on ISS**

### **A. ISS Technology Demonstration**

Previous toilets faced many challenges - many that current toilets still experience. Previous systems were not designed to sit dormant, as future missions will necessitate. Some toilets had limitations on operating duration for fear that internal systems may overheat. Finally, many of the past toilet systems were not compatible with the anatomy of both genders.

The Toilet will undergo two technology demonstration periods. The first, will test the Toilet for a future deep space vehicle that may only be crewed intermittently. For this demonstration period, the Toilet will be operated for 30 days, then shut down for a minimum of 90 days, and finally operated again for another 30 days. This timeline will simulate a vehicle that is uncrewed. During the first technology demonstration, the system will be run for an hour to ensure that it can sustain operations for a substantial period of time. If a user were ill or performing a powered cleaning or maintenance task, the system should be able to operate without failure or damage to the system for 60 minutes without pause.

During the second technology demonstration, the Toilet will operate for a minimum of 3 years with nominal maintenance. This will investigate the operation of the Toilet for a longer duration space mission, like the Mars Design Reference Mission 5.0 profile which consists of a 200 day transit to Mars, 500 days at Mars, and a 200 day return transit<sup>5</sup>. While primarily for Exploration, the Toilet will also support increased ISS crew sizes when US commercial crew flights begin in the near future. It is desired that a combination of male and female crew use this Toilet during the technology demonstrations. Many of the past toilet systems have not been designed for female use. The primary issue has to do with the length between the anus and urethra, which is vastly different between males and females. Lining up a urine funnel while aligning to a commode receptacle for simultaneous urination and defecation can be difficult if not impossible with current and previous space toilet systems. This can result in unhygienic conditions. The new Toilet System has been designed to allow successful and hygienic collection for all crewmembers, regardless of gender. This has been accomplished through seat design, seat placement on the commode, and funnel design.

### **B. ISS Integration Hardware Overview**

The Toilet is designed for both Orion and ISS requirements, with Orion being the driver for the majority of the requirements including volume and mass. Orion has a dedicated small hygiene compartment used for body waste management, hygiene activities, and private communications. The Toilet has been designed to accommodate the size and shape of this compartment and interface to Orion electrical and fluid interfaces.

On ISS, interfacing the Toilet has posed a challenge since the ISS interfaces are different than Orion. Additionally, ISS was not originally designed for a second toilet in the US segment. Therefore, this required the development of a separate suite of Toilet integration hardware for the mechanical, electrical, data, and fluid interfaces. Table 1 provides a brief description of the integration hardware needed for integrating the Toilet on ISS.

**Table 1. Toilet Integration Hardware needed for ISS integration.**

Interface Type	Operations Nomenclature	Hardware Description
<b>Mechanical</b>	Toilet Stall Mesh Frame, Port Mesh Frame, Stbd	Provides private enclosure for Toilet and current Waste and Hygiene Compartment (WHC)
	Toilet Mounting Adapter Toilet Pretreat Tank Enclosure	Provides mounting interface for Toilet and Pretreat Tank
<b>Electrical/Data</b>	Toilet Power Box	Interface to provide 120 Vdc ISS power to Toilet
	Toilet Data Recorder	Collects operational Toilet data and transfers it to the ground
<b>Fluid Transfer</b>	Toilet Water Hose	Interface from ISS Potable Water to Dose Pump
	Toilet Pretreat Hose	Interface from Pretreat Tank to Dose Pump
	Toilet Pretreated Urine Hose	Interface from Toilet to Urine Transfer System
	Toilet EDV Adapter	Interface from Pretreated Urine Hose to EDV (urine tank)
	Urine Funnels	Interface to Toilet for urine collection

Figure 1 is a simplified interface diagram that shows the interfaces for Toilet on ISS.

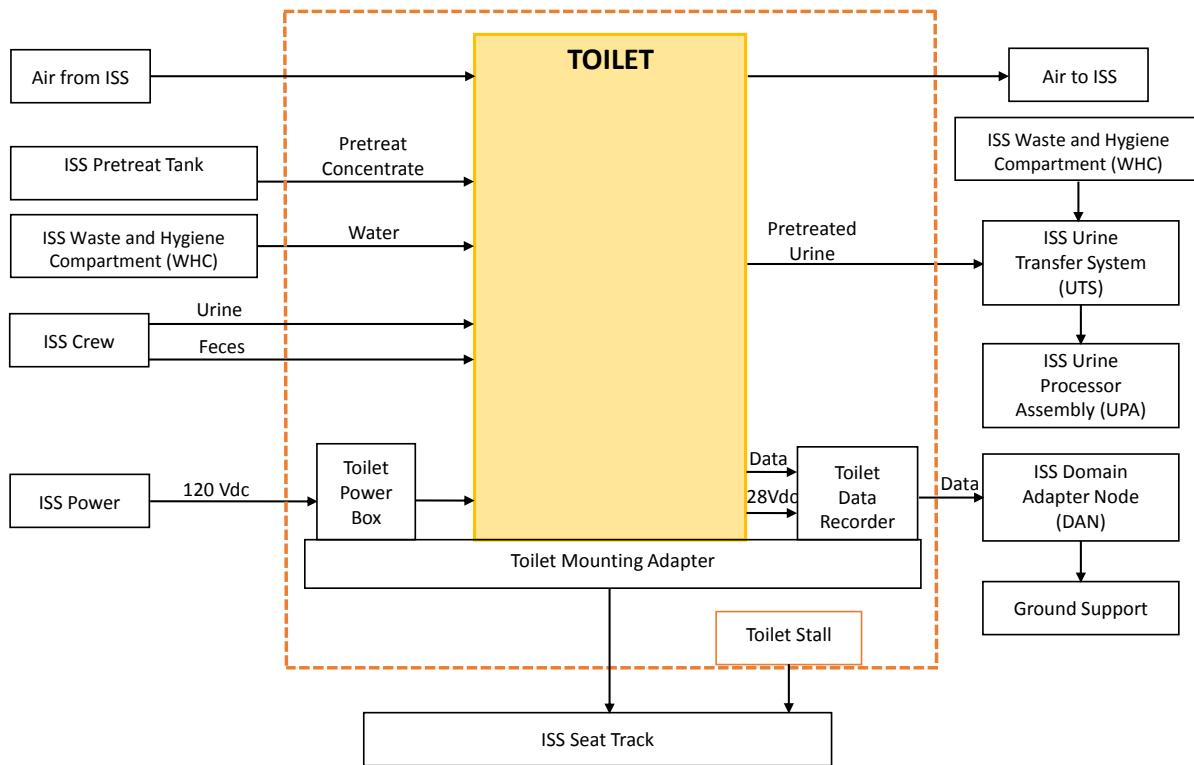
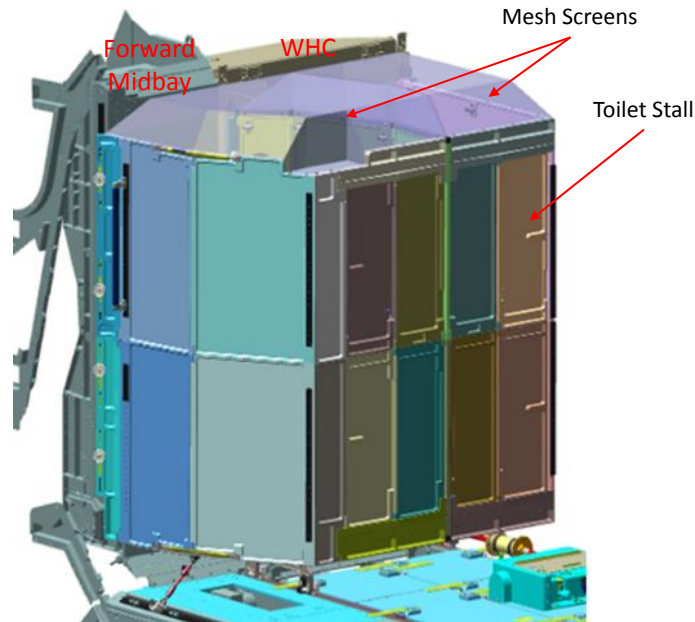

**Figure 1. ISS Interface Diagram for the Exploration Toilet.**

### C. Toilet Stall

The WHC Kabin is a privacy enclosure currently installed in front of the WHC rack to provide the crew additional volume for waste collection activities<sup>6</sup>. To provide a private volume for the Toilet, the WHC Kabin is replaced with the Toilet Stall. The Toilet Stall provides two private and separate compartments for waste collection

activities for the Toilet and the WHC. It encompasses the WHC Kabin volume and the Node 3 Forward Midbay volume which is divided into two volumes (Figure 2).



**Figure 2. The Toilet Stall attached to seat track on the WHC and Forward Midbay in Node 3.**

The Stall consists of three main walls that create two separate compartments. The Port side compartment is located in the Midbay Forward volume and will house the new toilet. The Starboard side compartment is located in front of the WHC rack and provides additional volume for the crew while using WHC. Each Stall wall is made up of two separate panels that are pinned together. The walls stand approximately 1.67 m (5.48 ft) high and are located approximately 20.3 cm (8 in) above the Node 3 Deck to provide clearance for the High Efficiency Particulate Accumulator (HEPA) filter intakes. The Stall panels attach to ISS seat track on the WHC rack face and the Node 3 Midbay. Each Stall panel has two seat track attachment knobs for a total of twelve knobs. The Stall is designed to allow each compartment (WHC or Toilet) to remain in place if the other compartment is removed (Figure 3). Removal of a portion of the Stall may be required for maintenance activities either on the Toilet, in WHC, or on surrounding racks. This flexibility allows one of the two toilets to remain operational during maintenance operations.

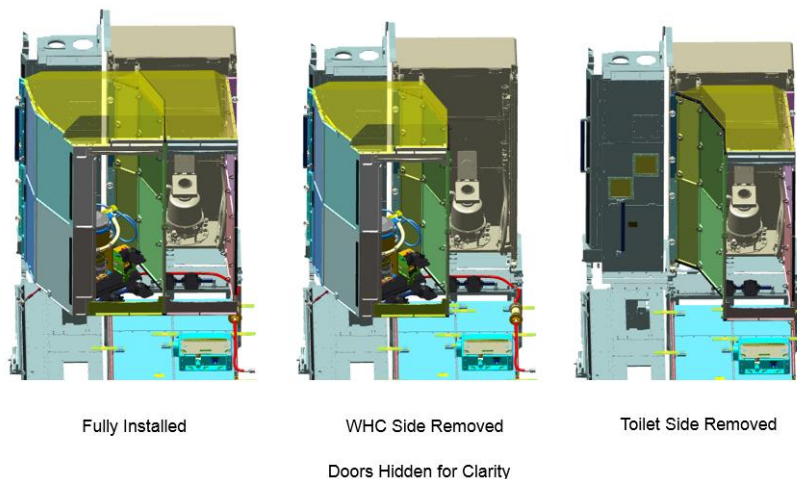

**Figure 3. Toilet Stall Configurations.**

Each Stall compartment has bi-fold doors that open inward and provide a door opening of 50.8 cm (20 in). When closed, the doors are latched in place to prevent inadvertent opening while the compartment is occupied. To open the doors from the inside, the user pulls the door handle down and then pulls the doors inward. There is also an exterior push button on each door to open the doors from the outside if they are inadvertently closed. The doors also have an emergency egress function if the doors fail closed while the Stall is occupied. Seat track is available on the Stall panels, both inside and outside each compartment for the crew to attach handrails for crew translation and mobility aids.

The top of each Stall compartment is covered by a Toilet Mesh Frame. The purpose of the mesh frames are to provide containment of free fluids and particles while still allowing airflow into the Stall volume. The mesh is made of a stainless steel material that provides approximately 25.4 cm (10 in) of additional head room above the height of the Stall walls. The two screens are attached to the top of the Stall walls via snaps and do not require tools to install or remove from the Stall. The screens are independent of each other meaning that each screen can be removed or installed without having to remove or install the other screen. The port side screen (above the Toilet) includes a notch to avoid interference with the Brine Processor Assembly (BPA) payload which is located in the Node 3 Midbay Overhead.

#### D. Toilet Mounting Adapter

The Mounting Adapter provides the mechanical interface between the Toilet hardware, Pretreat Tank Enclosure, Power Box, and Data Recorder to Node 3 of the ISS. The Mounting Adapter consists of a baseplate to attach the hardware, an adjustable strut, and a bracket for attachment to the vehicle. The overall dimension of the baseplate is approximately 76.2 cm by 88.9 cm (30 in by 35 in) and sits flush with the Stall 20.3 cm (8 in) above Node 3 Deck. The vehicle interface to the Mounting Adapter is standard ISS seat track. The Mounting Adapter bracket attaches to the seat track on the WRS2 rack and the strut attaches to the Node 3 Deck Midbay. The adjustable strut design accounts for on-orbit tolerances during installation and keeps the baseplate level with Deck. There is no interface between the Mounting Adapter and Stall with approximately 5 cm (2 in) between the baseplate and the Stall panels. The Mounting Adapter is removable without the need to remove the portion of the Toilet Stall encompassing the WHC Kabin volume. The Pretreat Tank Enclosure mounted on the baseplate of the Mounting Adapter supports the Russian Pretreat Tank and protects it from kick loads. The Mounting Adapter plate is grounded to the ISS structure via a ground strap. There is also seat track on the Mounting Adapter to allow crew to attach foot restraints as needed. Figure 4 shows the Mounting Adapter.

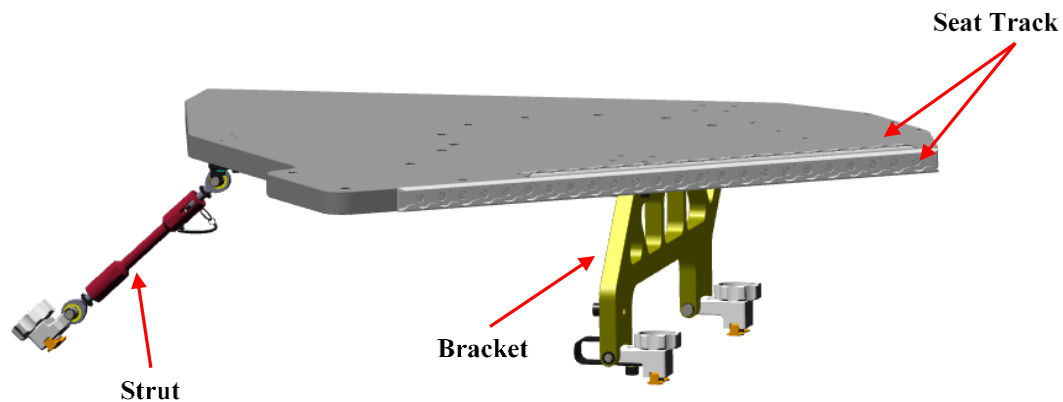
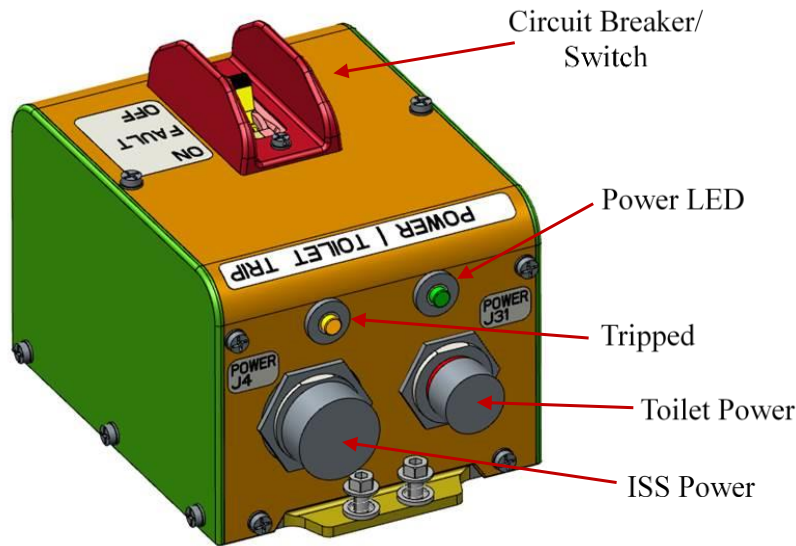

**Figure 4. Toilet Mounting Adapter provides the mechanical interface for the Toilet to Node 3.**

#### E. Toilet Power Box

The Toilet Power Box provides the electrical interface between the Toilet and the ISS. The enclosure measures 12.4 x 18.0 x 12.5 cm (4.87 x 7.10 x 4.91 in). The Power Box is mounted on top of the Data Recorder, on top of the Mounting Adapter. The Power Box connects to an ISS connection in Node 3 and provides the Toilet with power. The Power Box has the ability to disconnect power to the Toilet if the Toilet power draw is too high. Also, the

Power Box mimicks the soft start/stop and trip characteristics of the Orion power system. The Power Box has a circuit breaker reset capability, power on/off capability for Toilet Hardware maintenance, and visual indicators for switch position. There is a green Light Emitting Diode (LED) that indicates the Power Box is receiving power from ISS and an amber LED indicating when the toilet trips. The Power Box provides the power On/Off function for activities such as maintenance, as the Toilet does not have this capability. Figure 5 shows the Power Box.



**Figure 5. Toilet Power Box connects the Toilet to the ISS power interface.**

#### **F. Toilet Data Recorder**

The Toilet Data Recorder collects operational data from the Toilet to monitor nominal and off-nominal on-orbit operations. The data is sent to the ground at a real-time frequency and includes operational parameters such as pressure, temperature, conductivity and motor speed. The Data Recorder is based on a Modular Interchangeable Stackable Layers (MISL) system designed by the Avionic Systems Division (EV) at Johnson Space Center (JSC). The MISL system is a compact space-rated Central Processing Unit (CPU) system that is modular, scalable and reconfigurable as needed for specific hardware applications.

The interface between the Toilet and the Data Recorder is both a power and data interface. The Toilet sends data as well as provides power to the Data Recorder. Once the Data Recorder is interfaced to the Toilet, it does not require any crew interaction to operate. It only collects data when the Toilet is operational. While the Toilet is idle, the Data Recorder remains in a stand-by state and is monitoring the state of the Toilet. Once the Toilet is in use, the Data Recorder starts collecting data. The Data Recorder formats the data into Ethernet frames and then sends it to the Domain Adapter Node (DAN) computer before sending the data to the ground. The DAN computer is a single-board computer system that connects to the ISS Joint Station Local Area Network (JSL) via an Ethernet interface. The Data Recorder interfaces to the DAN box via an Ethernet interface. Prior to sending the data to the ground, the DAN computer also converts the Toilet data from hex to engineering units.

The Data Recorder includes two green LEDs. The LED labeled “Toilet Data” illuminates when data is being collected from Toilet and sent to the DAN computer. The LED labeled “Link” illuminates when the communication link with the DAN system is established and ready to receive data. The Data Recorder enclosure measures 18.8-cm long (7.4 in) by 14.7-cm wide (5.8 in) by 7.62-cm high (3.0 in) and is mounted on the Toilet Mounting Adapter with the other integration hardware. The Data Recorder provides the mounting interface for the Toilet Power Box which mounts directly on top of the Data Recorder.

## **G. Toilet Fluid Transfer Hoses**

### *1. Fluid Hoses*

The Toilet Integration Hardware for ISS includes three fluid hoses and one adapter to connect the Toilet to the vehicle fluid transfer systems. The hoses are all of similar construction with the differences being in diametric size and end connections. Each of the hoses are Teflon lined convoluted hoses with a braided exterior.

The Toilet mixes potable water and alternate pretreat concentrate to provide a solution for pretreating urine. The Toilet Water Hose supplies water to the Toilet from the Urine Monitoring System (UMS) Flush Water Connection. The water supply connection is located on the ISS WHC front panel. The Water Hose is 304.80 cm (120 in) long with a diameter of 0.95 cm (0.38 in). The Water Hose connects to both the Toilet and the ISS water bus via Parker Quick Disconnects (QDs). The Water Hose also includes a 90 degree forging nipple on the end connecting to ISS in order to avoid interference with the Middle Stall Wall. The hose is routed down the Middle Stall Wall (port side), under the Middle Stall Wall to the port side of the Stall, and behind the Mounting Adapter to connect to the Toilet.

The Toilet Pretreat Hose connects to the Russian supplied Pretreat Tank to supply alternate pretreat concentrate to the Toilet. The Toilet Pretreat Hose is 96.52 cm (38 in) long with a diameter of 1.27 cm (0.5 in). The Toilet Pretreat Hose is routed between the Pretreat Tank and Toilet which are mounted on the Mounting Adapter. The hose uses a Parker QD to interface to the Toilet and a Russian Handwheel Connector to connect to the Russian Pretreat Tank.

The Toilet Pretreated Urine (PTU) Hose transfers pretreated urine from the output of the Toilet to the Urine Transfer System (UTS), which connects to the ISS Urine Processor Assembly (UPA) for recycling. The UTS allows operation of both the existing Russian Toilet (ACY) located in the WHC rack and the new Toilet. The UTS consists of valves and controllers which open and close depending on the priority flow path from either the Toilet or WHC. Each toilet can deliver pretreated urine to the UPA or a Russian urine tank (EDV-Y). The PTU Hose also includes a 100-micron filter to reduce the number of particulates introduced into the UPA. The life of the hose is limited by filter throughput. The filter is 18.42 cm (7.25 in) long with a diameter of 11.43 cm (4.50 in). The PTU Hose is 457.20 cm (180 in) long, including the filter, with a diameter of 1.27 cm (0.50 in). The connections of the hose connecting to the Toilet output is a Parker QD. The connection of the hose connecting to the UTS is a Preece QD. The PTU Hose is routed behind the Mounting Adapter on Forward side under the Middle and Port Stall Walls and along the adjacent WRS1 seat track on Deck where the UTS is located. There are hose restraints that keep the PTU Hose secured.

In its nominal configuration, the Toilet EDV Adapter interfaces to the UTS to automatically deliver pretreated urine to an EDV-Y backup tank. This is required if both the Toilet and WHC are in use simultaneously or if the UPA is not available. Any stored pretreated urine is automatically offloaded to the UPA for processing by the UTS. In the event that both the UPA and UTS have failed, the Toilet EDV Adapter is reconfigured to bypass the UTS and UPA and directly connect to the Toilet PTU Hose to deliver pretreated urine to an EDV-Y. The EDV Adapter is 20.07 cm (7.90 in) long. The EDV Adapter contains a Russian Hydroconnector to connect to an EDV and a Preece QD to connect to UTS or to the PTU Hose.

### *2. Urine Funnels*

The Toilet Urine Funnel designs build on the previous Shuttle funnels and the current Russian funnel used on WHC. There are three basic designs consisting of a funnel with a hole, continuous sided funnel, and a funnel with a notch (Figure 6).



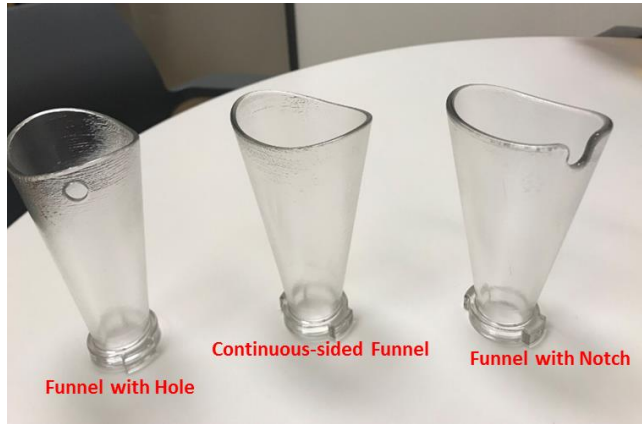

**Figure 6. Three urine funnel designs provide options for female crew during simultaneous urination and defecation.**

The designs are intended to aid female crew by allowing air to enter during docked use on the body. Urine funnels were launched on NG-10 and the crew of Expedition 56 evaluated the three designs. Additional funnel evaluations are on the schedule by the crews of Expedition 57 and 58 (two female crewmembers will be available for this evaluation.). Modification to the funnels that are in work include shortening the funnel itself to allow better cleaning, improving the cap material and closure mechanism, and changing the material of the tether.

### III. ISS Integration Challenges

#### A. Electrical Interface Challenges

The initial intent of the Power Box was to provide pass through of power from ISS to the Toilet. Though the Toilet is used on Orion, the technology is demonstrated on ISS. Both vehicle interfaces needed to be considered when designing the Power Box keeping in mind that the power characteristics of the ISS RPC are different than Orion RPC characteristics. This drew concern that the ISS RPC would trip due to initial inrush current. The Power Box had to implement FPGA firmware to mimic the Orion RPC as close as possible while drawing power from ISS, and at the same time limit inrush current to the Toilet. There was also concern that the Power Box circuit breaker would draw too much current and not trip at an adequate period causing damage to the Toilet Controller. This brought about a need to find a different circuit breaker for the Power Box that would approximate the trip characteristics of the Remote Power Controller Module. The complexity of the Power Box increased from the initial intent with the implementation of FPGA firmware and a circuit breaker with specific trip characteristics.

#### B. Mechanical Interface Challenges

##### 1. Toilet Mounting Adapter

One of the main challenges in designing the Mounting Adapter was to accommodate several hardware pieces mounted on the baseplate all within the Toilet Stall port side. The Mounting Adapter provided real estate to mount some of the Integration Hardware as well as the Toilet, taking into consideration adequate space for the Toilet air inlets and outlets, fluid hose bend radius, and cable bend radius. The overall Stall volume grew some after crew evaluations, which allowed the Mounting Adapter baseplate to expand some. Despite the baseplate dimensions increasing, there was still a fair amount of hardware to consider when arranging it on the baseplate. Several design iterations of the Mounting Adapter were necessary to accommodate the Toilet hardware as the design evolved. Figure 7 shows the Mounting Adapter with all the required hardware mounted.

The Mounting Adapter and the hardware mounted on it cannot interfere with existing on-orbit hardware, and at the same time must attach to existing seat track on Deck and WRS2 rack. Some of the interferences include the Intermodule Ventilation (IMV)



**Figure 7. Toilet Mounting Adapter inside Toilet Stall with Hardware Mounted (Note: Mounting Adapter is shown in grey).**

Inlet Covers in Forward Midbay, access to HEPA Filters on Deck Midbay, and the attachment area on WRS2 for foot restraints used for WHC. The Mounting Adapter had to be positioned such that the Toilet lid would not interfere with the IMV Inlet Covers when the Toilet lid is in full swing. The height of the Mounting Adapter relative to Deck Midbay could not be less than 7.62 cm (3 in) to allow the Deck Midbay panel to be removed in order to access the HEPA Filters for remove and replace procedures. The attachment mechanisms used to attach the Mounting Adapter to the WRS2 rack could not interfere with the WRS2 rack seat track at the point where the WHC foot restraints are attached. Figure 8 shows the existing on-orbit hardware the Mounting Adapter cannot interfere with.

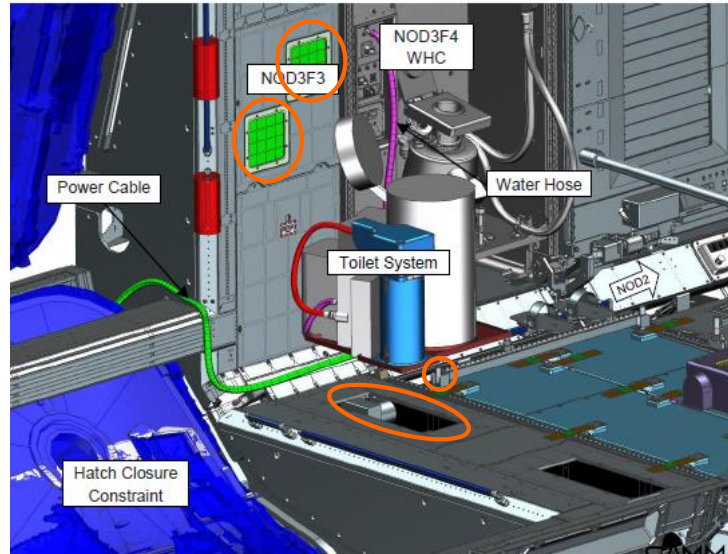
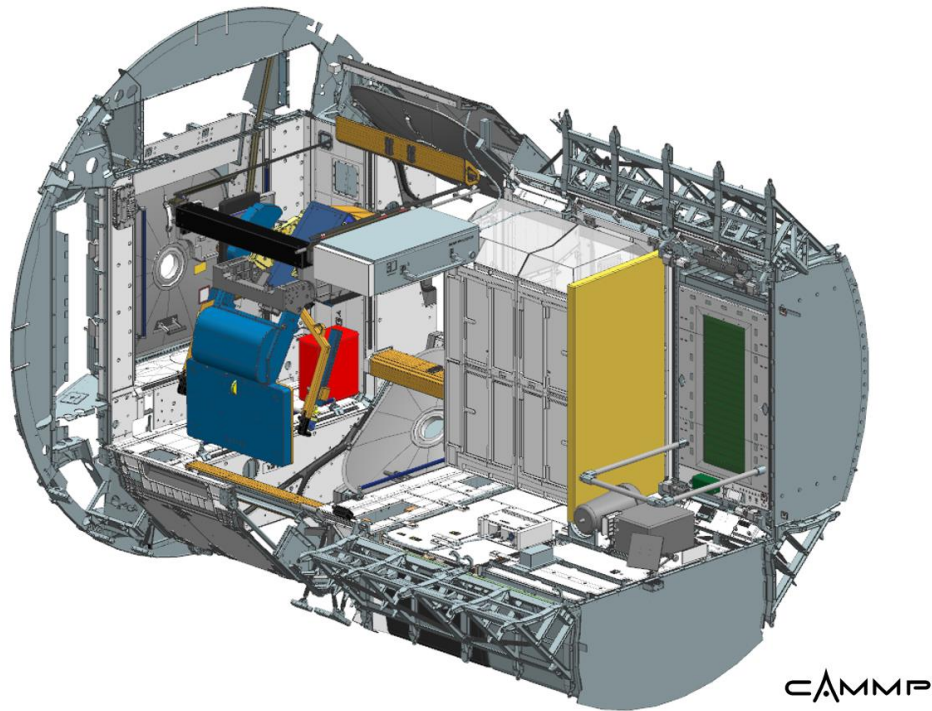

**Figure 8. Existing On-Orbit Hardware (circled in orange).**

All the restrictions along with the multiple pieces of hardware mounted on the Mounting Adapter in such tight quarters required several design iterations before finalizing the Mounting Adapter design.

## 2. Toilet Stall

One of the biggest challenges with integrating the new toilet on ISS was finding a more permanent deployment location. For the shorter technology demonstration, the original plan was to replace the existing WHC toilet with the new toilet for the length of the demonstration. Once completed, the WHC toilet would be re-installed. However, with a minimum three-year technology demonstration and the need for an additional toilet, this configuration is not ideal. Therefore, in 2016, the ISS program worked to identify a permanent location for the new toilet in Node 3. The challenge comes with the fact that Node 3 was not scarred for another toilet. The benefit of installing the new toilet in Node 3 is its proximity to the existing toilet and UPA. The program identified several potential locations in Node 3 and the ISS topology team assessed the pros and cons of each location with respect to accessibility, interferences, and volume. As part of this process, crew evaluations were also performed to assess crew acceptability of the different location options. Although not entirely ideal, the Node 3 Midbay was selected and the WHC Kabin would be replaced with a double stall enclosure (Figure 9). With the Stall concept, one of the early challenges was creating two usable waste collection volumes in a space that was not much larger than the existing WHC Kabin volume. The Midbay is essentially the width of half a rack at approximately 68.6 cm (27 in) wide. In a volume of about a rack and a half, the Stall would need to provide a volume for both the new toilet and WHC. The original Kabin volume in front of the WHC decreased so that there would be adequate volume in the Stall for the new toilet sitting out in the aisle way.



**Figure 9. Layout of Node 3 with the Toilet Stall Deployed.**

With the addition of the Stall to Node 3 came other complications with regards to interferences with existing hardware. Node 3 houses both the Advanced Resistive Exercise Device (ARED) and Treadmill 2 (T2) exercise equipment which have varying dynamic operating envelopes. During development, an interference was identified with the T2 dynamic motion envelope, the Starboard Stall wall and the Multipurpose Cargo Transfer Bags (MCTBs) that are used for Node 3 noise reduction<sup>7</sup>. To maximize the Stall volume for WHC, the design team considered extending the Starboard wall to attach directly to the seat track which is different than how the WHC Kabin walls attach (with an L-bracket). In addition, this would require moving the MCTBs 15.2 cm (6 in) in the aft direction on the Stall wall. Moving the MCTBs aft on the walls would not only degrade their sound absorption but would extend the blankets approximately 18 cm (7 in) into the aisle way. To avoid impacting the performance of other systems in Node 3, the solution was to revert to a design similar to WHC Kabin. At the seat track attachment the Stall panels would attach via an L-bracket and then the panels would extend out into the aisle way at an angle. This would allow the MCTBs to remain in their current deployed location without impeding on the T2 volume while also maximizing the Stall volume for WHC activities.

On the Port side of the Stall, an interference issue was also identified with the ARED dynamic volume, the Stall seat track knobs, and the seat track installed on the Stall panels for crew handrails. To resolve the interference with the Stall seat track, the piece on the Port bottom panel was shortened to 15.2 cm (6 in). This would limit placement of the handrails thus avoid the ARED volume. After this solution was implemented it was determined that the majority of the seat track on the Port side panels interfered with the ARED volume. The solution for this issue was an operational constraint on-orbit that identified the limited locations for installing a mobility aid. The other limitation was that a handrail could not be used in this location as it also intruded on the ARED volume. Currently NASA is developing handrail offset brackets that attach to the current Stall seat track but move the handrail interface approximately 17.3 cm (6.8 in) into the middle of the Stall panels. As a temporary solution, two seat track studs would be installed with an adjustable tether between them to aid in translation through the Node.

Both the top and bottom seat track knobs on the bottom Port side Stall panel also protrude into the ARED envelope by 2.9 cm (1.14 in) and 2.2 cm (0.85 in) respectively. Although the hardware was already in manufacturing at the time that this interference was discovered, the project team did identify two options to reduce but not eliminate the knob protrusions. The options required redesign of the knob attachment but would only reduce the

protrusion by a maximum of 1.9 cm (0.75 in). The ISS program made the decision not to implement the changes since the protrusion could not be completely eliminated. Instead, going forward the crew would be trained on the addition of these protrusions when using ARED.

The BPA payload is located in the Midbay Overhead just aft of the Stall. Regular access to BPA is required for regular maintenance. To accommodate these activities, the Stall panel closest to BPA and the mesh screen both include a cutout to allow more hardware clearance. In addition, the BPA includes a hose and two cables that route to different locations in Node 3. Because of its close proximity to the Stall, this required that the hose and cables be routed near and into the Stall volume. Since the mesh screens do not physically attach to the Forward Midbay or WHC this provided some flexibility in routing and allowed the hose and cables to access the inside Stall volume along the WHC rack face without any issues.

To add to the complexity of the Stall design, there is some variability in the orientation and installation of the seat track in Node 3 and on WHC. The seat track on the Midbay is installed at a 45 degree angle from the seat rack on a typical rack face. In addition, the seat track on the Midbay is offset approximately 0.9 cm (0.35 in) in the vertical direction from the seat track on the WHC rack. It was also determined during the Stall design phase that the WHC rack floats within its own structural interfaces. Therefore, because of the location uncertainty of the mounting interfaces it was vital that the Stall design include some flexibility to adapt to the on-orbit configuration. In order to do this, more accurate dimensions of the ISS mounting structures were needed. A NASA-wide crowd sourcing challenge was used to identify solutions for obtaining crucial on-orbit dimensions. Photogrammetry was suggested as a way to analyze photos of the area in question and determine these dimensions. Training photos were provided to the crew with the needed areas marked as well as detailed training instructions on camera and lens selection, locations, and number of views required. Over 300 photos were taken by the crew and downloaded for review and analysis. Dimensions needed were obtained, in general, to within approximately 0.25 cm (1/10 inch) accuracy. With these accurate dimension, two adjustable struts were designed to allow the Port side Stall wall to be adjusted as needed to properly interface with the other two Stall walls. To add to this challenge was the need for the Stall to also be rigid enough to reduce any audible rattle, modular to support maintenance activities, and still withstand all the on-orbit and crew loads.

One of the constraints on the Stall was launching it in standard Cargo Transfer Bags (CTBs). The Stall had to be a modular design (panels) to meet the mass and volume limits of a CTB. The challenge came with balancing the mass and size limits with designing hardware that would meet all the standard load requirements (launch and on-orbit) as well as simplify the crew interfaces for installation and use.

The original mesh screens were designed to be flush to the top of the Stall walls. The primary reason for this design was to avoid interference with other hardware in Node 3 specifically the BPA payload. However, at the critical design review, crew inputs recommended that the new mesh screen provide a similar amount of additional head room as the existing WHC screen. The WHC screen attaches to each side of the WHC Kabin and creates a “bubble” above the Kabin that provides several inches of additional head room. This posed a hardware interference challenge in that the screens needed to extend above the Stall wall but still stay clear of other hardware in the Overhead locations. The result was a newly designed mesh screen with a complex geometry that included a cutout on the Port side screen to accommodate the BPA. The newly designed screens provide approximately 25.4 cm (10 in) of additional head room and approximately 5 cm (2 in) clearance between the screen and the BPA hardware.

During the manufacturing of the screens, a materials issue was identified. The original screen design included using a Teflon material. The intent for this change was to improve on the existing metal mesh used on WHC to use a material that was easier to clean. While cutting and folding the material to prepare for assembly, it was observed that the Teflon material had a tendency to crack if folded in a certain direction. To resolve this issue, the project reverted back to a stainless steel material. While the stainless steel did not crack when folded it did introduce a sharp edge challenge during the assembly process. The ends of the stainless steel were puncturing through the material layup which required adding additional material. This increased the overall material thickness which resulted in longer assembly time to complete.

### *3. Crew Evaluations*

Crew evaluations were a major benefit in finalizing many design aspects of the Stall. Because the toilet is a very crew-centric piece of hardware, it was important to involve the crew in major decisions such as location, crew interfaces, and volume.

During the location discussion, several crew members were involved to assess the multiple locations and provide valuable input on ease of use and accessibility to the Toilet. Also during the design phase for the Stall, crew provided input on the amount of space for the new toilet. They identified the need to extend the volume as far as possible into Node 3 without impeding on other activities or the emergency egress path. Although this only

increased the volume by a few inches in a corner of the Stall, those additional inches changed the perception of the Stall volume and made it feel bigger to the crew.

Because of the limited volume inside the Stall, the original design was to have the bi-fold doors open outward. However, during a crew evaluation with a Stall mock-up, a concern was identified that if the doors opened outward, that the crew would use them to translate through the Node. The concern was that over time, this would degrade the life of the doors so that they would no longer function. To resolve this concern, the Stall mock-up was modified with doors opening inward and the crew evaluated this configuration for acceptability. Although in this configuration the doors encroached on the internal volume, it was deemed acceptable. The project team used all these inputs to modify the design when possible to provide the end-user a useable and functional piece of hardware.

#### IV. Conclusion

In February 2019, the Toilet Stall hardware was deployed in Node 3 (Figure 10). The remaining integration hardware and toilet will be launched and deployed at a later time. The crew will use the Starboard side stall in conjunction with the WHC for waste collection activities. The crew was given the option to perform other hygiene activities on the Port side of the Stall until remaining toilet hardware arrives on ISS.



**Figure 10. Toilet Stall deployed in ISS Node 3.**

Successful installation of the Toilet Stall confirms that several of the interface challenges with regard to integrating the new toilet have been resolved. Integrating any new hardware on ISS can introduce significant challenges especially when the vehicle was not scarred for the hardware. Overcoming these challenges requires a flexible design and extensive coordination efforts with hardware stakeholders and vehicle integration teams. Currently, the NASA and Collins Aerospace project teams are working to complete manufacturing and assembly of the new toilet and the remaining integration hardware. Adding this additional toilet on ISS will not only benefit the increased crew size but the technology demonstration will benefit other programs by proving the toilet capabilities over an extended period of time.

#### Acknowledgments

The authors would like to acknowledge the many team members across NASA and industry who contributed to the hardware necessary to integrate the Toilet into the ISS vehicle. This team includes the JSC Engineering, Technology, and Sciences (JETS) contract project team for the design, analysis, safety, testing, and assembly of the components; the Collins team for assistance with the Toilet interface requirements; and the various engineering technical teams and ISS vehicle teams for their invaluable expertise on tackling this unique and challenging interface.

## References

- 1 Sargusingh, M., Anderson, M. S., Broyan, J. L., Macatangay, A. V., Perry, J. L., Schneider, W. F., Gatens, R. L., Toomarian, N., "NASA Environmental Control and Life Support Technology Development and Maturation for Exploration: 2017 to 2018 Overview," ICES-2018-182, 48<sup>th</sup> International Conference on Environmental Systems, Albuquerque, New Mexico, 2018.
- 2 Anderson, M. S., Macatangay, A. V., McKinley, M. K., Sargusingh, M. J., Shaw, L. A., Perry, J. L., Schneider, W. F., Toomarian, N., Gatens, R. L., "NASA Environmental Control and Life Support Technology Development and Maturation for Exploration: 2018 to 2019 Overview," Submitted for publication, 49<sup>th</sup> International Conference on Environmental Systems, Boston, Massachusetts, 2019.
- 3 Broyan, J. L., "Waste Collector System Technology Comparisons for Constellation Applications," 2007-01-3227, 37<sup>th</sup> International Conference of Environmental Systems, Chicago, Illinois, 2007.
- 4 Stapleton, T. J., Baccus, S., Broyan, J. L., "Universal Waste Management System Development Review," AIAA2013-3400, 43<sup>rd</sup> International Conference on Environmental Systems, Vail, Colorado, 2013.
- 5 Drake, Bret (ed.), "Human Exploration of Mars Design Reference Architecture 5.0," NASA/SP-2009-566, July 2009.
- 6 Link, D. E., Broyan, J. L., Philistine, C., and Balistreri, S. F., "International Space Station USOS Waste and Hygiene Compartment Development," 2007-01-3101, 37<sup>th</sup> International Conference on Environmental Systems, Chicago, Illinois, 2007.
- 7 Broyan, J. L., Schlesinger, T., Ewert, M. K., "Exploration Mission Benefits From Logistics Reduction Technologies," ICES-2016-140, 46<sup>th</sup> International Conference on Environmental Systems, Vienna, Austria, 2016.