

# Recent Advancements in LAVA for Jet, Rotor-Blade and Fan Noise Prediction

Cetin C. Kiris, Gerrit-Daniel Stich, Joseph G. Kocheemoolayil,  
Jeffrey A. Housman, Francois Cadieux and Michael F. Barad

Computational Aerosciences Branch  
NASA Ames Research Center

Fall 2018 Acoustic Technical Working Group Meeting,  
October 16-17, 2018, Cleveland, OH



- **Motivation**
- **LAVA Framework**
- **Jet Noise Prediction**
  - Hybrid RANS/LES efforts on round jet – Overset Curvilinear Navier-Stokes (NS)
  - Orion/MPCV Launch Abort System transient loads prediction - Cartesian NS
- **Rotor Blade Noise: Isolated UAS Rotor in Hover Validation**
  - Overset Curvilinear NS
  - Cartesian NS
  - Cartesian Lattice Boltzmann
- **NASA Rotor Alone R4 Noise Source Diagnostics Test (SDT) – Cartesian NS**  
(Preliminary)

# Motivation



- ✓ **Increase predictive use of computational aerosciences capabilities for next generation aviation and space vehicle concepts.**
  - The next frontier is to use wall modeled and/or wall resolved large-eddy simulation (LES) to predict:

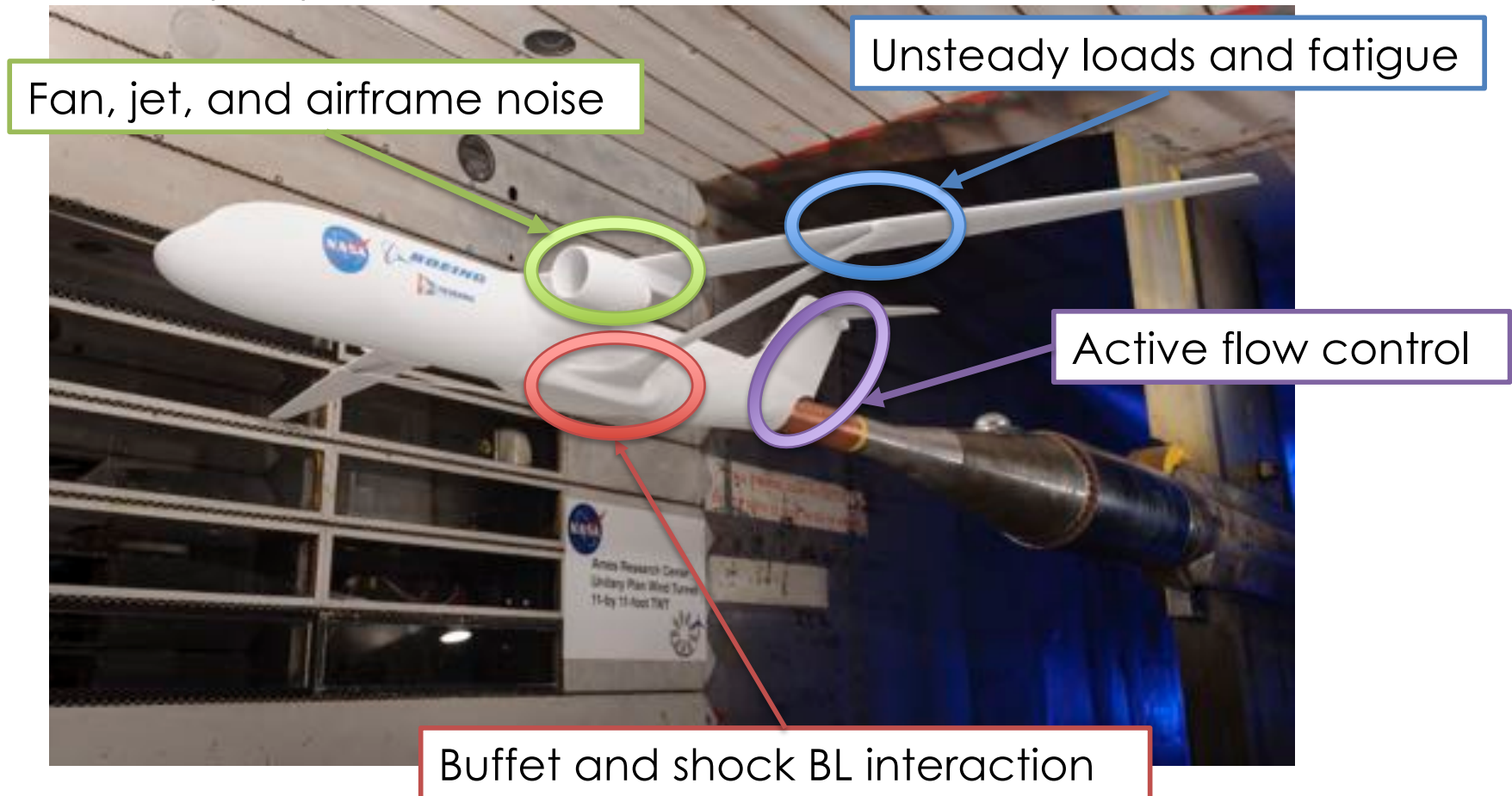

# Challenges in Computational Aero-Acoustics



## ✓ Grid Generation

- Structured Cartesian, Unstructured Polyhedrals, Structured Curvilinear; each paradigm has its own pros and cons → flexibility to pick best suited approach
- Remains a bottleneck → automation and solution-adaption

## ✓ Resolving/Modeling Turbulent Scales

- Resolving thin wall-bounded turbulence is too computationally costly for most aerospace applications → hybrid methods & wall-models
- Resolving all relevant scales of turbulent motion away from walls is also prohibitive → Higher order less dissipative numerics & subgrid-scale modeling

## ✓ Computational Requirements

- Space and time resolution requirements for acoustics problems are demanding.
- Explore revolutionary approaches to reduce computational time to reach converged statistics and spectra like Lattice-Boltzmann

# Computational Grid Paradigms



## Structured Cartesian AMR

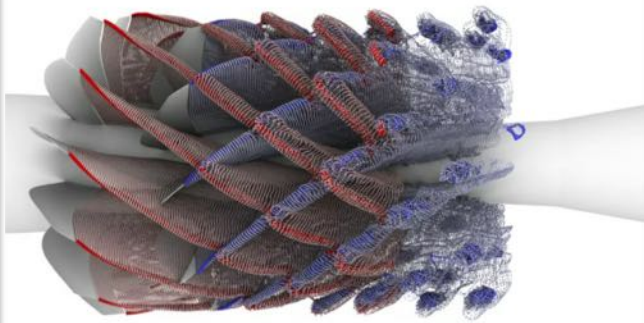
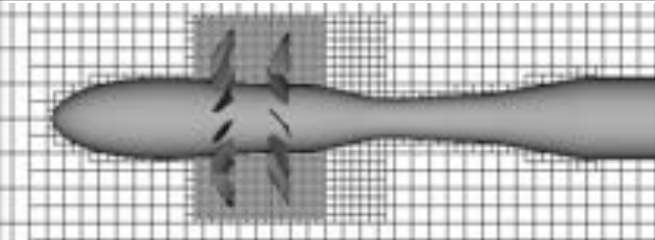

0:05.47

- Essentially no manual grid generation
- Highly efficient Structured Adaptive Mesh Refinement (AMR)
- Low computational cost
- Reliable higher order methods
- Non-body fitted -> Resolution of boundary layers inefficient

## Unstructured Arbitrary Polyhedral

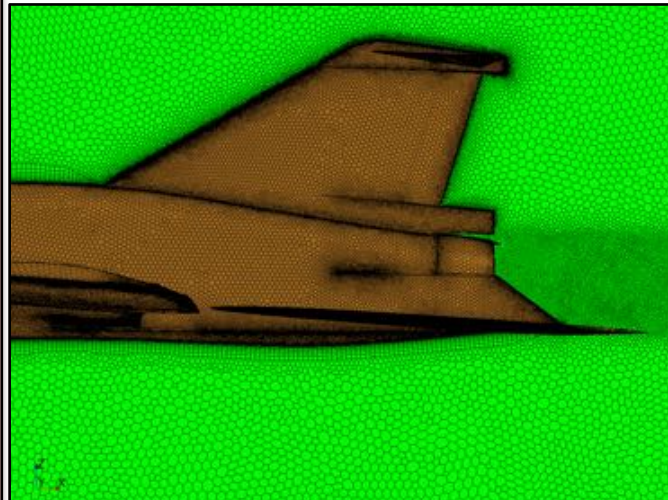
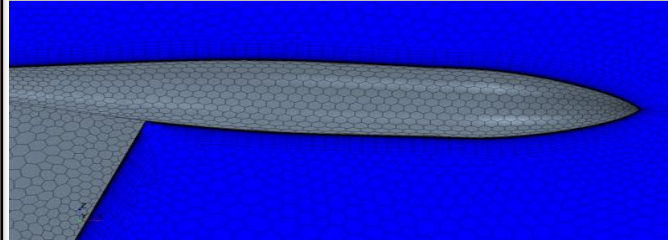

- Partially automated grid generation
- Body fitted grids
- Grid quality can be challenging
- High computational cost
- Higher order methods yet to fully mature

## Structured Curvilinear

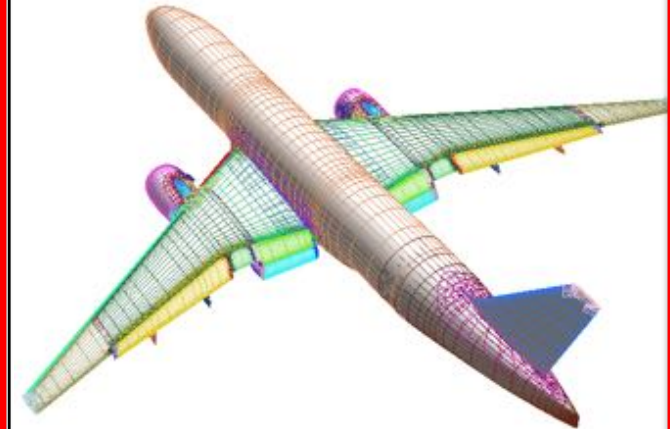
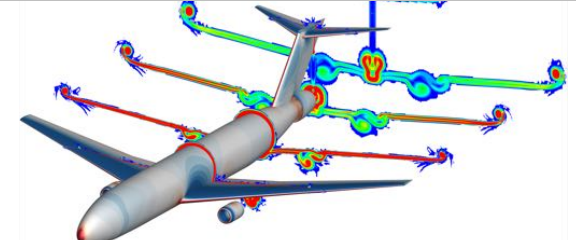

- High quality body fitted grids
- Low computational cost
- Reliable higher order methods
- Grid generation largely manual and time consuming



## LAVA Framework

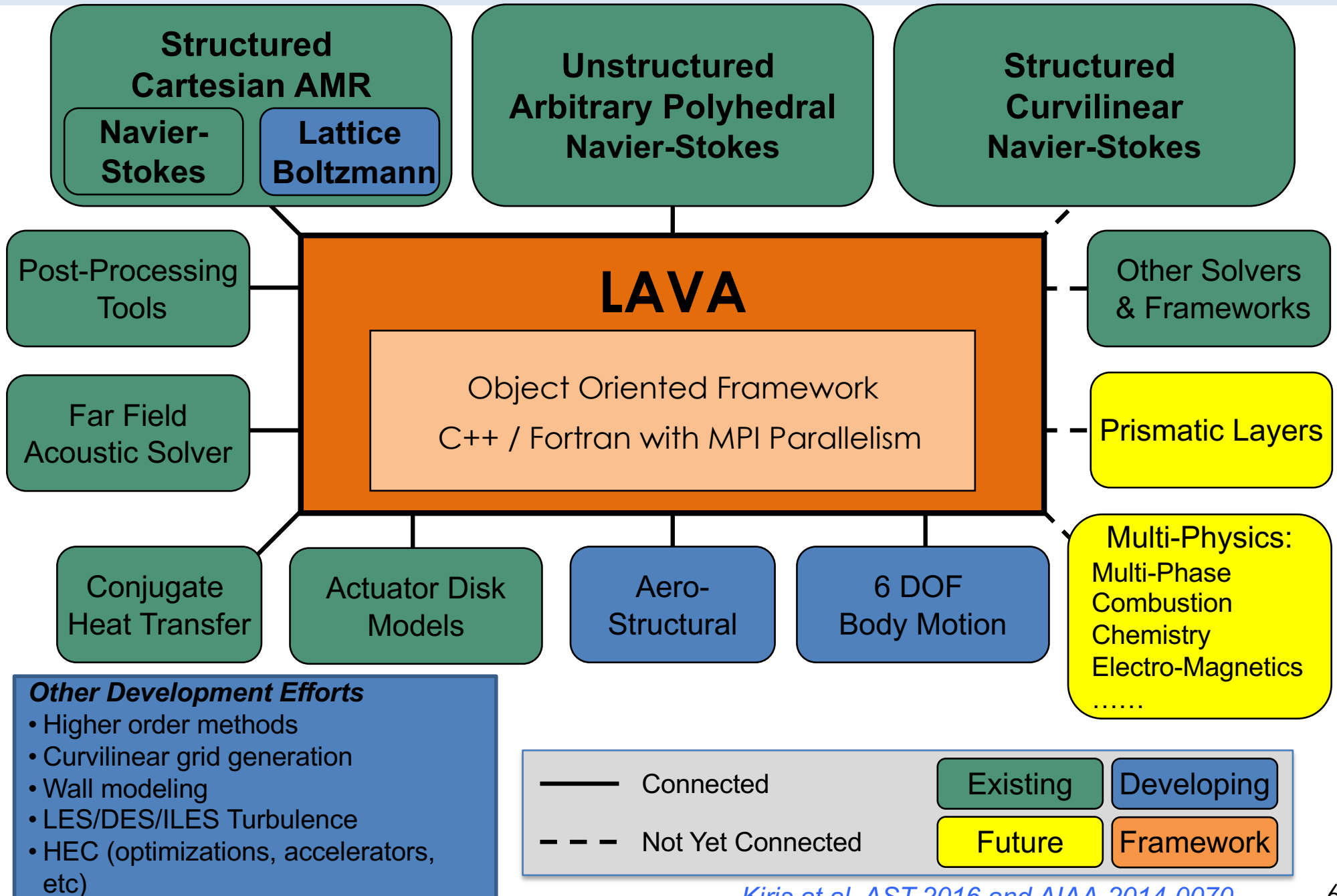

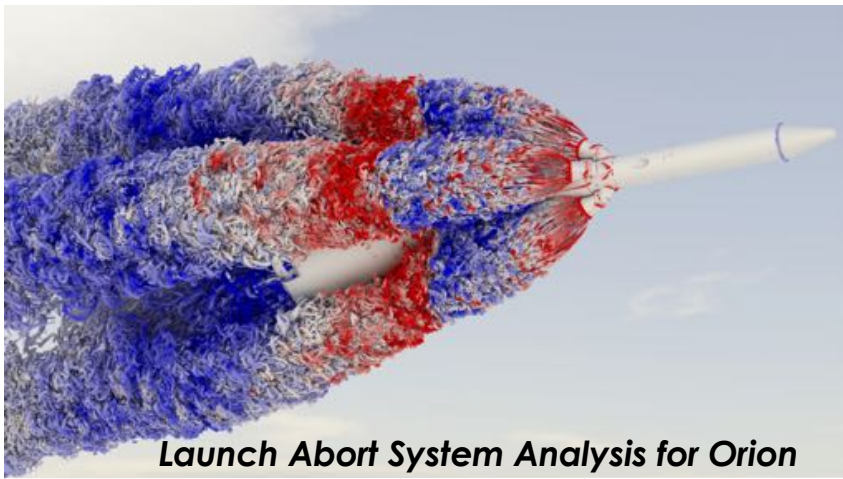

Launch Abort System Analysis for Orion

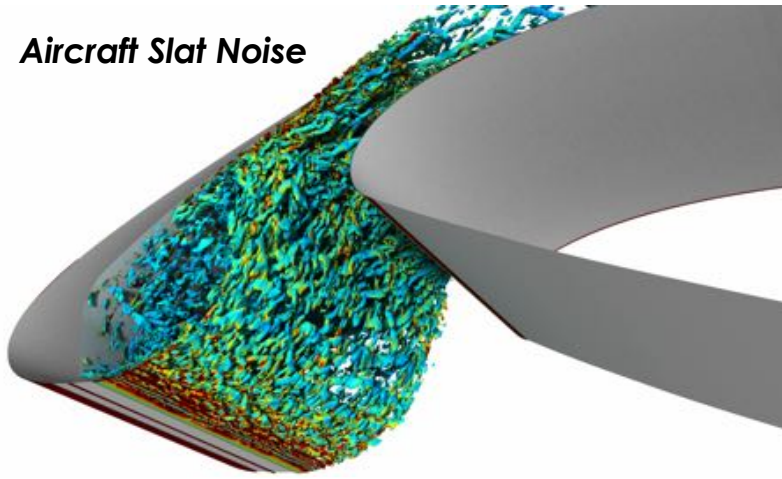

Aircraft Slat Noise

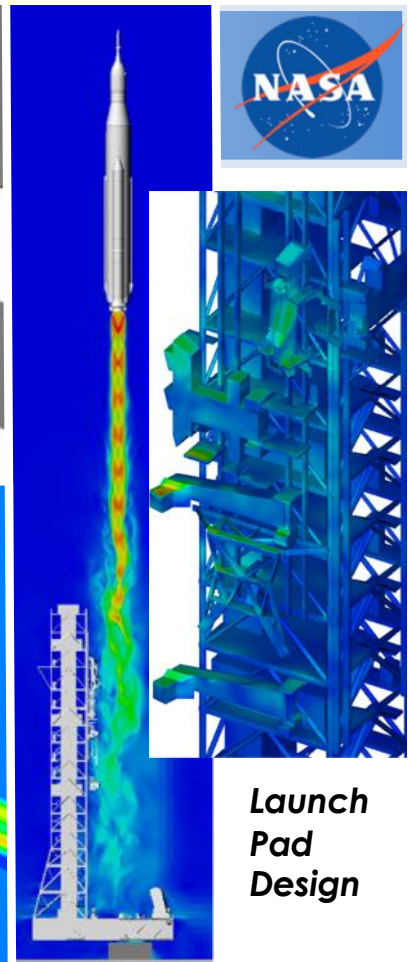

Launch Pad Design

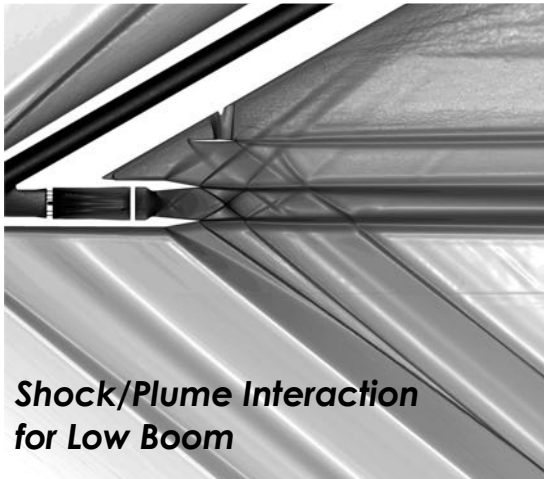

Shock/Plume Interaction for Low Boom

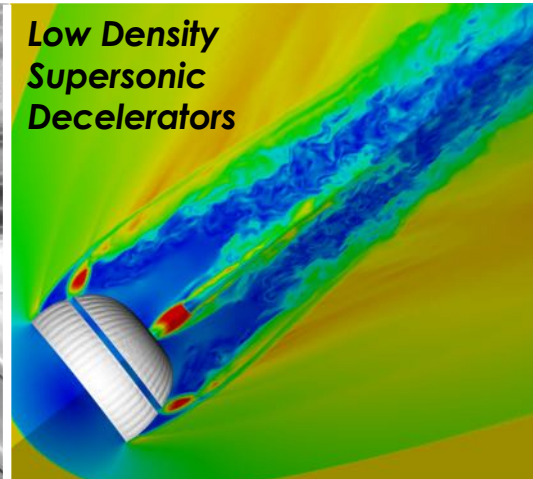

Low Density Supersonic Decelerators

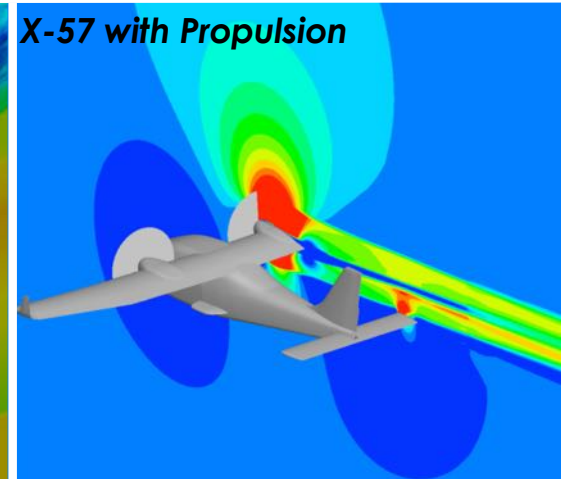

X-57 with Propulsion

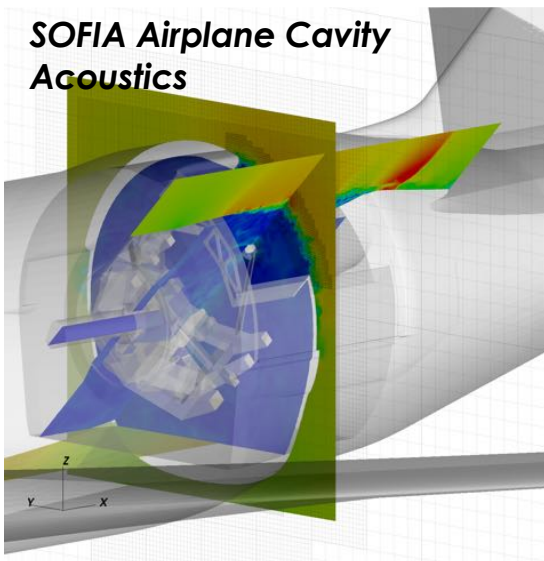

SOFIA Airplane Cavity Acoustics

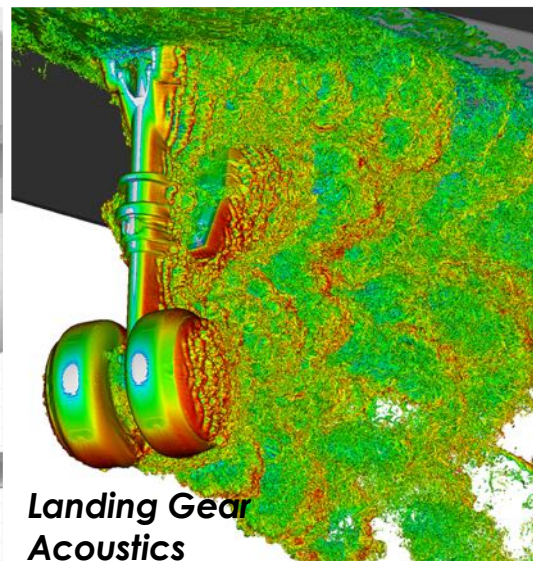

Landing Gear Acoustics

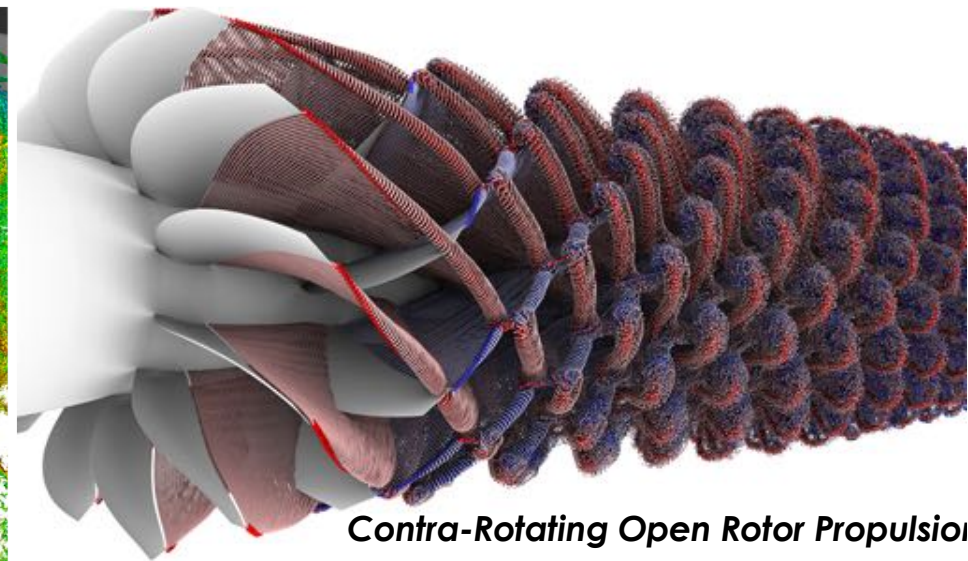

Contra-Rotating Open Rotor Propulsion



- **Motivation**
- **LAVA Framework**
- **Jet Noise Prediction**
  - Hybrid RANS/LES efforts on round jet – Overset Curvilinear Navier-Stokes (NS)
  - Orion/MPCV Launch Abort System transient loads prediction - Cartesian NS
- **Rotor Blade Noise: Isolated UAS Rotor in Hover Validation**
  - Overset Curvilinear NS
  - Cartesian NS
  - Cartesian Lattice Boltzmann
- **NASA R4 Noise Source Diagnostics Test (SDT)** – Cartesian NS (Preliminary)



# High Fidelity Jet Noise Simulation Methodology for Airport Noise Prediction of Emerging Commercial Supersonic Technologies

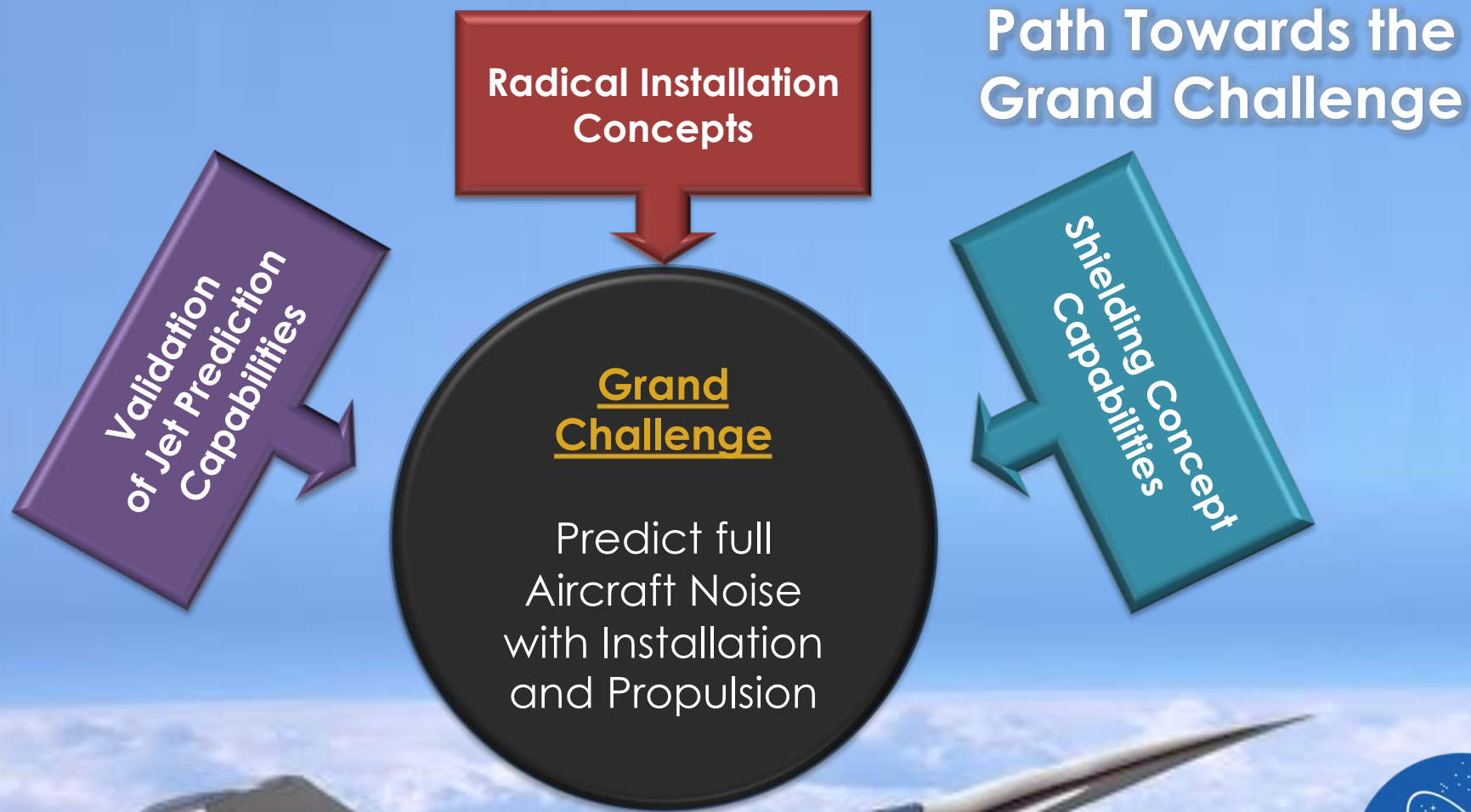

Commercial Supersonic Technologies (CST)  
Advanced Air Vehicle Program (AAVP)

# Validation of Jet Noise Prediction Capabilities



## Initial Validation

- ✓ Experiment performed by Bridges and Wernet using the Small Hot Jet Acoustic Rig (SHJAR) at NASA Glenn
- ✓ Baseline axisymmetric convergent Small Metal Chevron (SMC000) nozzle at Set Point 7 (SP7) & Set Point 3 (SP3)

Bridges et. al. (NASA-TM-2011-216807)	SP3	SP7
Acoustic Mach number $U_{jet}/c_{\infty}$	0.5	0.9
Jet temperature ratio $T_e/T_{\infty}$	0.950	0.835
Nozzle pressure ratio $p_t/p_{\infty}$	1.197	1.861
Nozzle Diameter D	0.0508 [m] 2.0 [inch]	

PIV measurement device

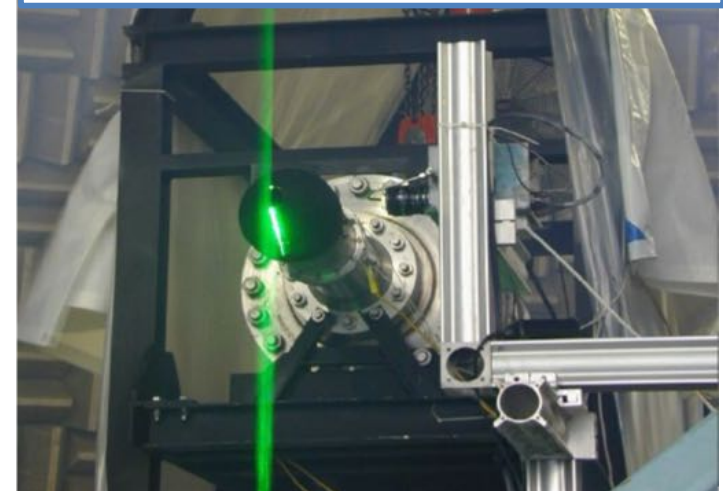

Similar conditions were analyzed in Bres *et. al.* AIAA-2015-2535, but the boundary layer thickness is 5.5 times smaller in this study

# Validation of Jet Noise Prediction Capabilities



## Initial Validation

### Objective:

- ✓ Assessment of Jet Noise Prediction Capabilities within LAVA solver.

### Approach:

- ✓ Hybrid RANS/LES, wall-modeled LES (ZDES Mode III) efforts on canonical round jet geometries at different Mach numbers (SP7, SP3).

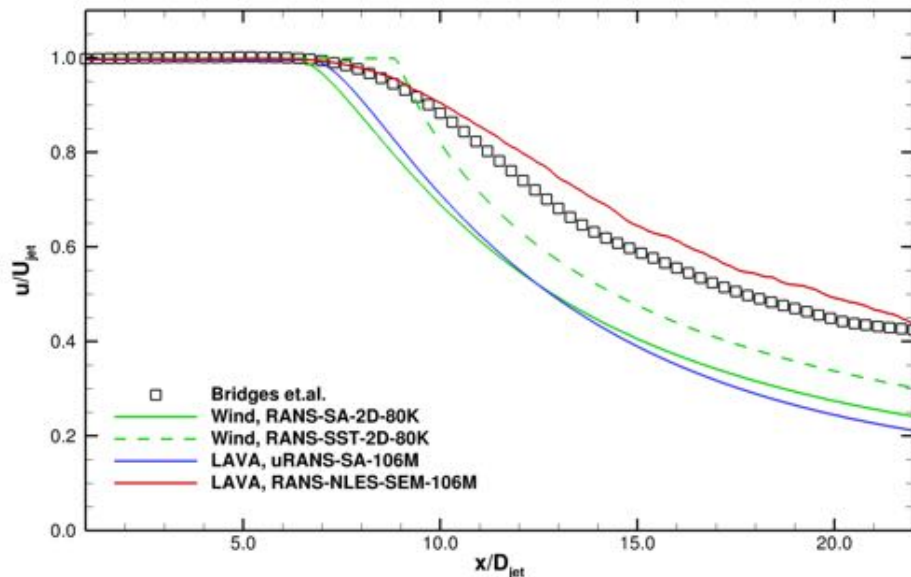

solver	$x/D_j$ [-]	Error [%]
Bridges & Wernet	7.8	-
Wind, RANS-SA-2D	6.84	-12.3
Wind, RANS-SST-2D	9.01	15.5
LAVA, uRANS-SA-3D	7.22	-7.5
<b>LAVA, RANS-NLES-SEM-3D</b>	<b>7.90</b>	<b>1.2</b>

**89.6% improvement**

<sup>1</sup> Wind Data, Objectives and Metrics from NASA Turbulence Modeling Resource (TMR) website: <https://turbmodels.larc.nasa.gov>

# SP 7 Round Jet – Farfield Results



RMS center-line velocity

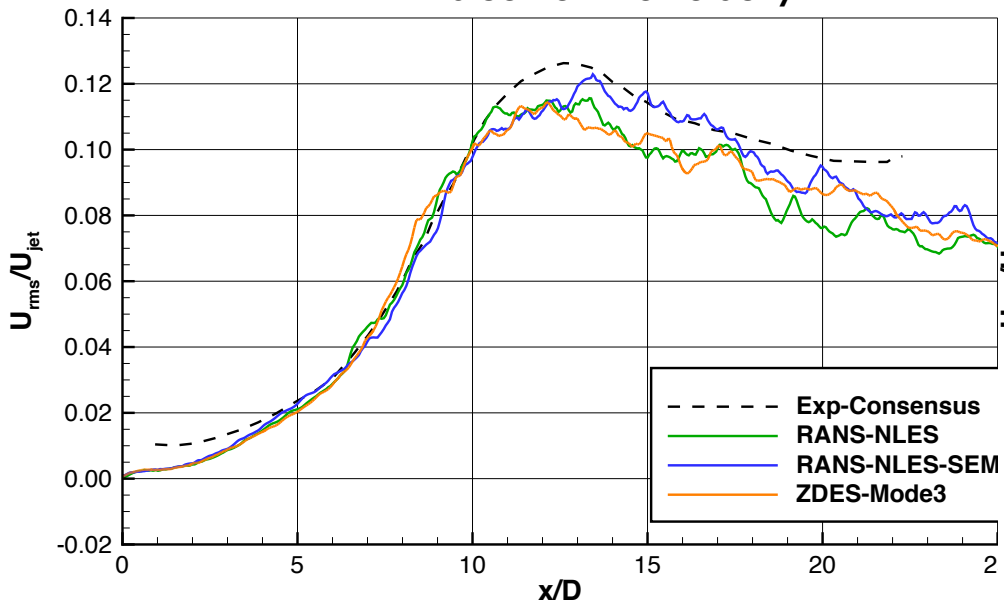

RMS lip-line velocity

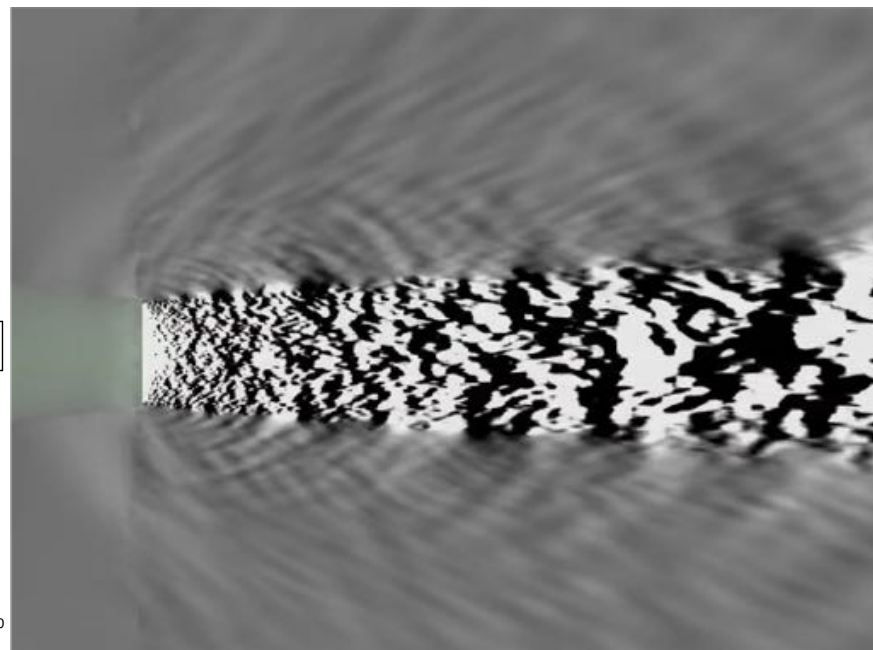
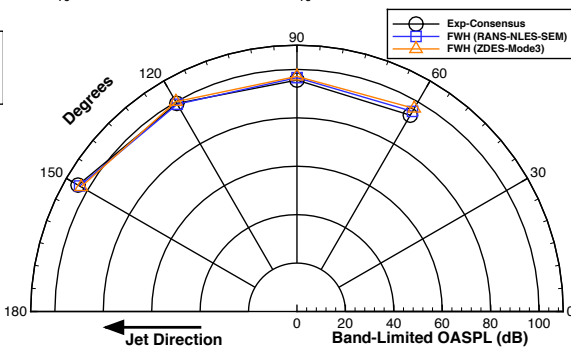
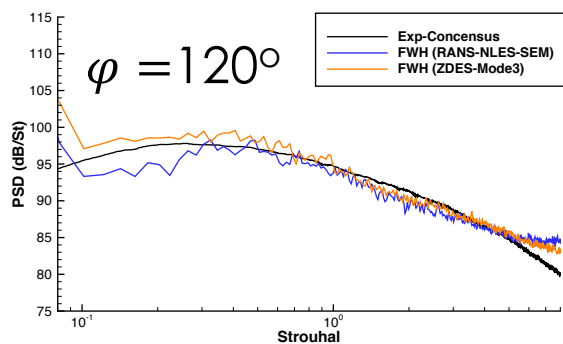
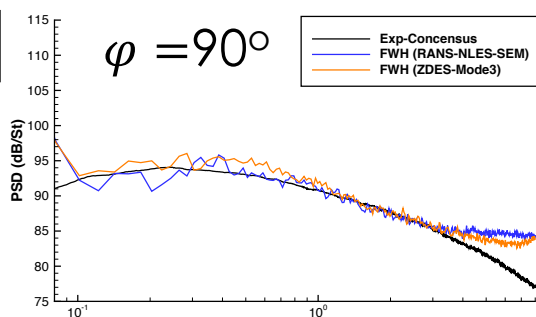
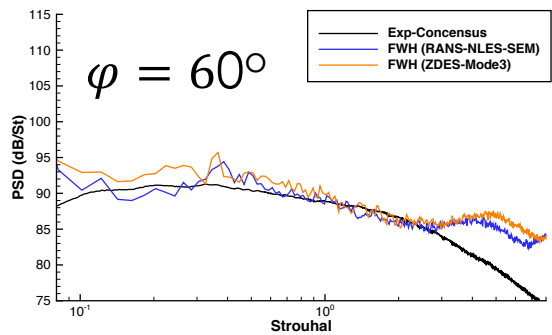
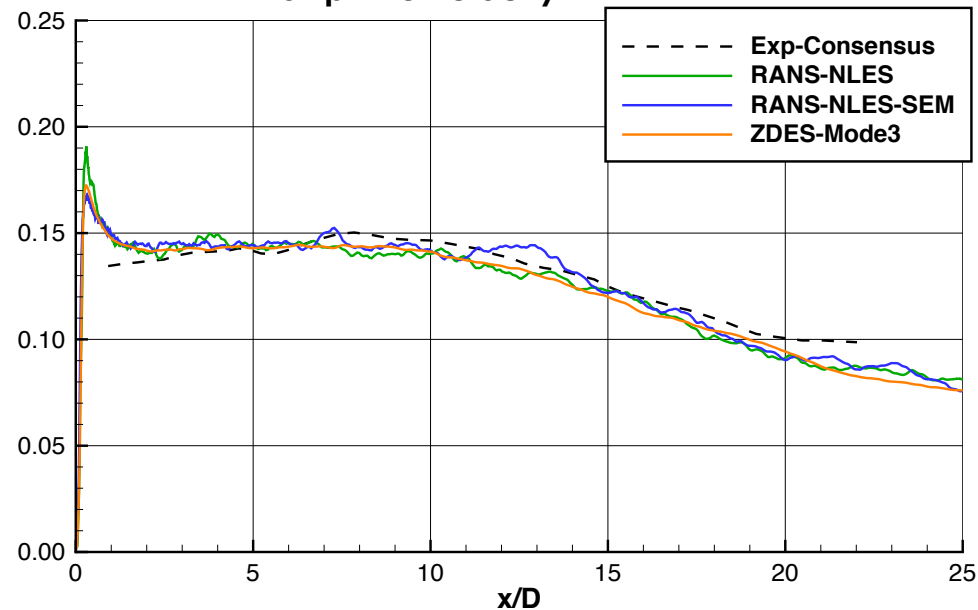

# SP 3 Round Jet – Farfield Results

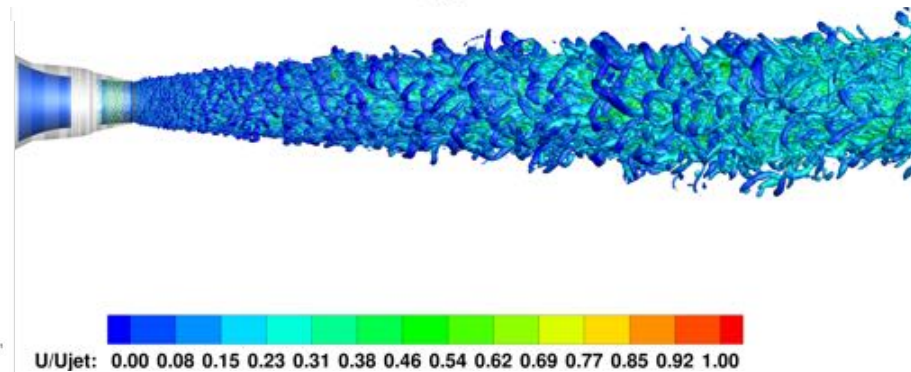
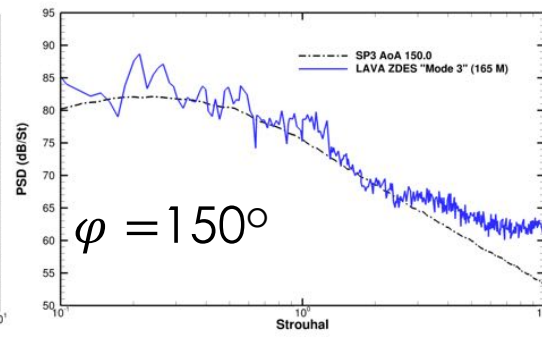
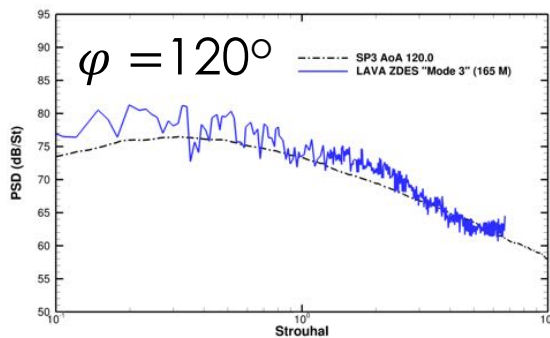
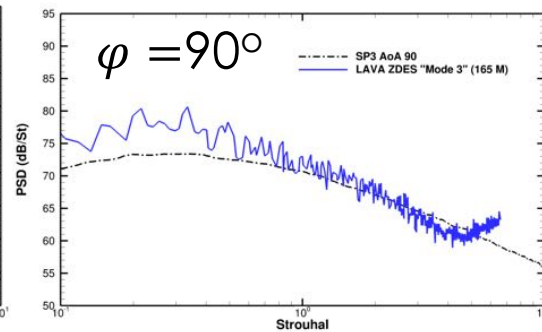
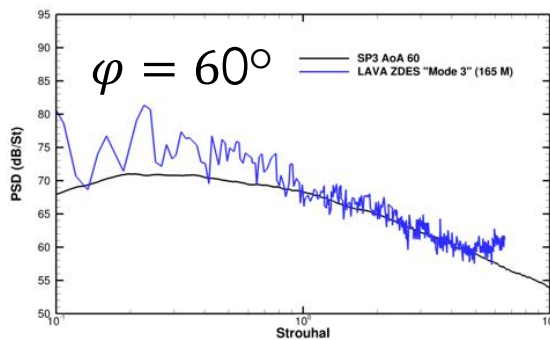
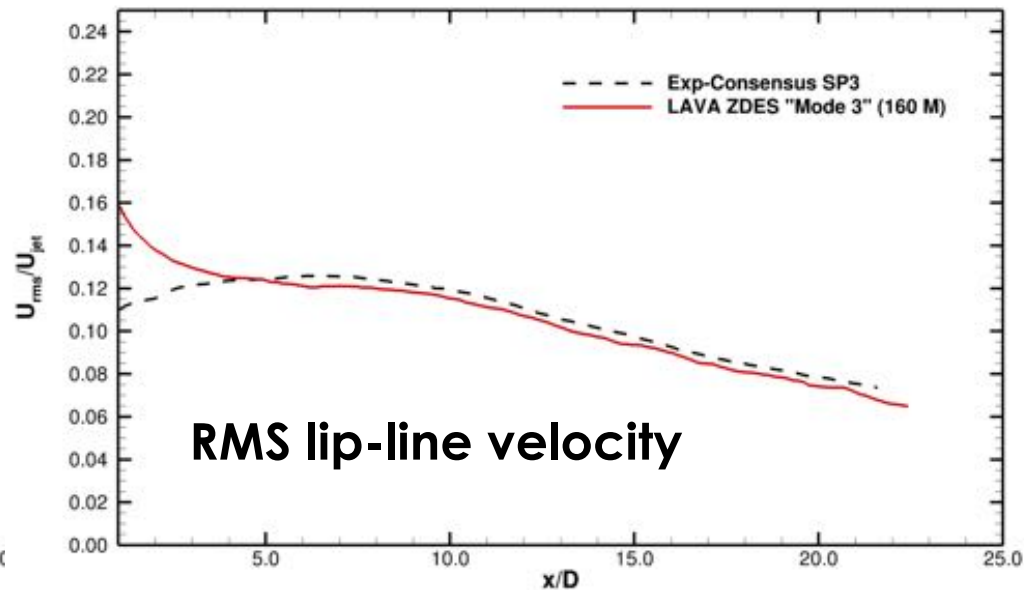
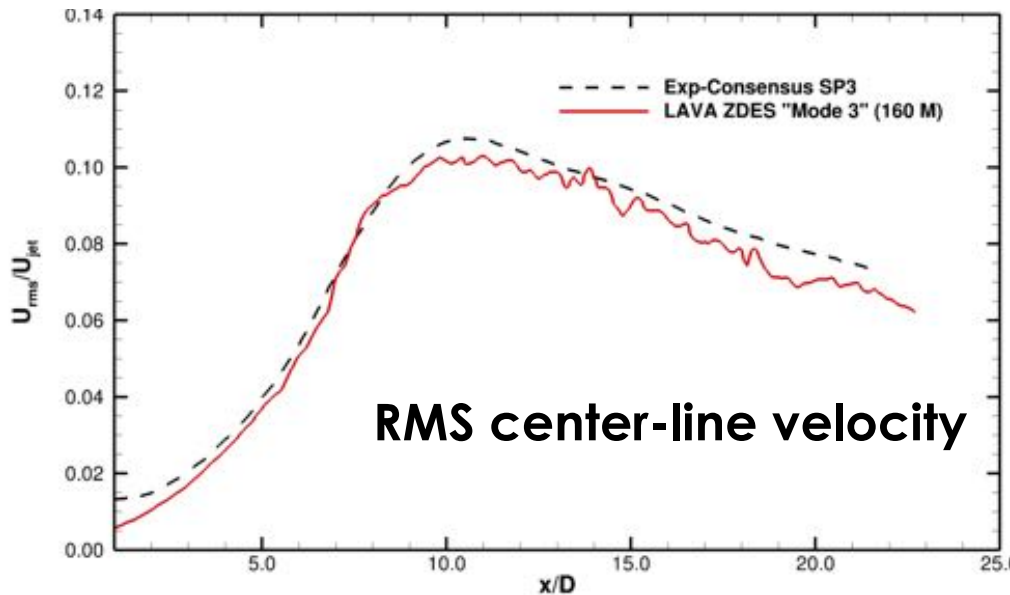

- ✓ Good agreement with measurements
- ✓ Lower Jet Mach number significantly more challenging

# First Step Towards Radical Installation Concepts



Initial Validation

Shielding  
Concept

SP7 SMC0000

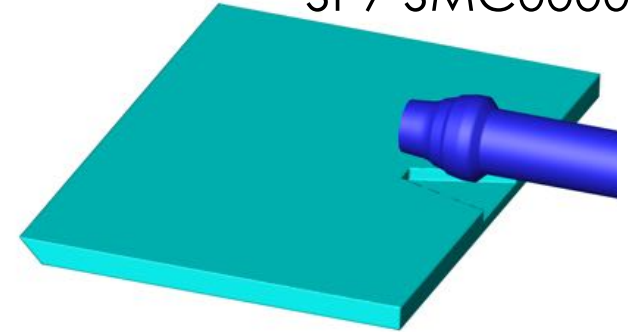

## Objective:

- ✓ Moving towards radical installation concepts.
- ✓ Jet-surface interaction noise is difficult to predict.

## Approach:

- ✓ Assess Jet Surface Interaction Noise with ZDES (Mode 3).
- ✓ Improve Post-Processing tools to gain better understanding of the sound generation and shielding physics (permeable and impermeable FWH, beamforming)

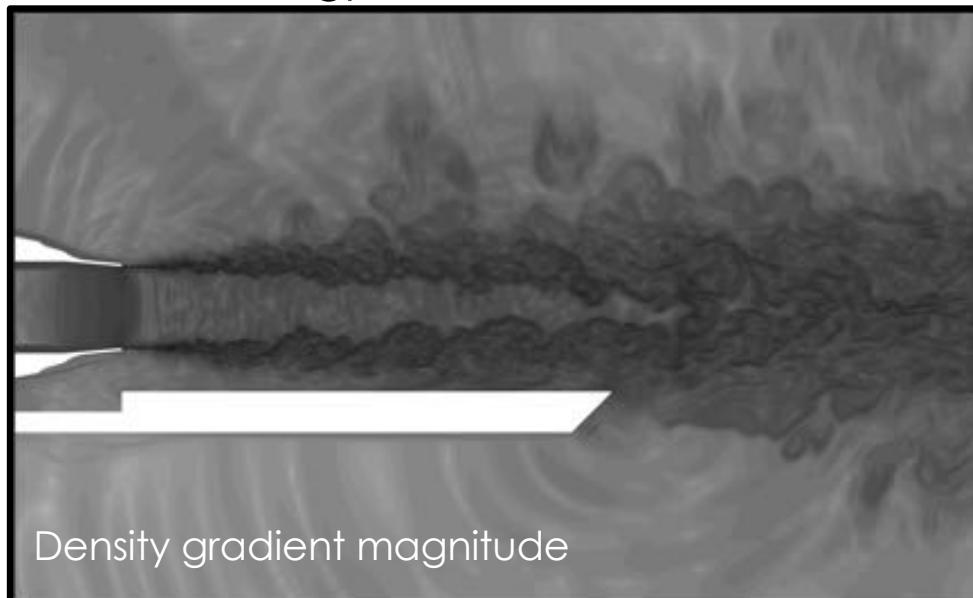

# First Step Towards Radical Installation Concepts

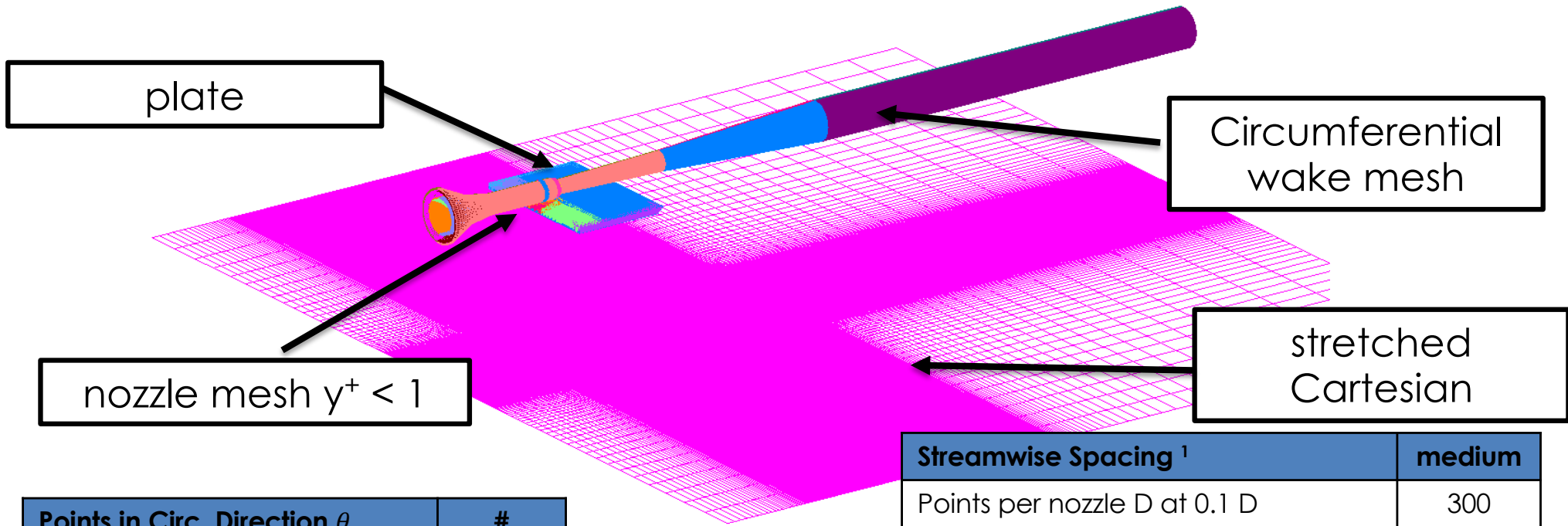

Points in Circ. Direction $\theta$	#
$d\theta_4$	354
$d\theta_3$	178
$d\theta_2$	90
$d\theta_1$	90

Streamwise Spacing <sup>1</sup>	medium
Points per nozzle D at 0.1 D	300
Points per nozzle D at 1 D	71
Points per nozzle D at 10 D	60
Points per nozzle D at 25 D	54

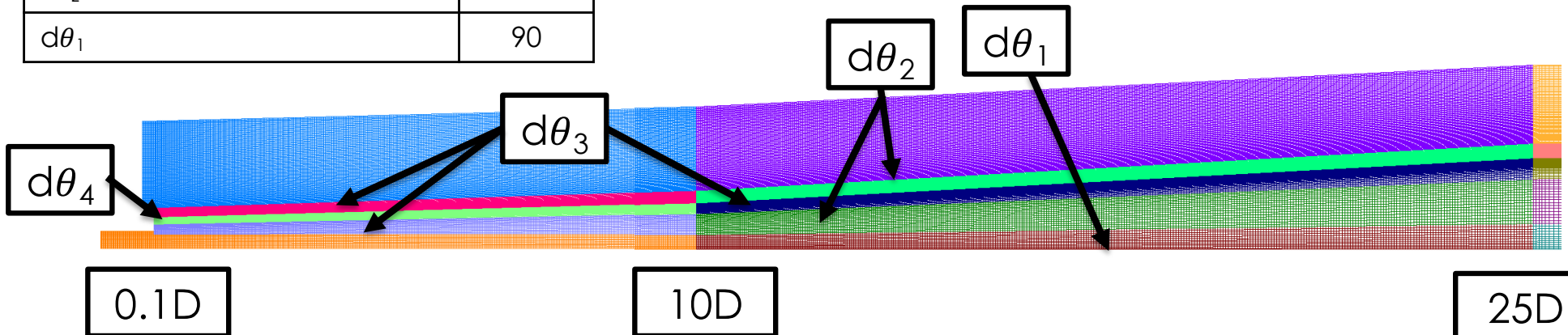

<sup>1</sup> Following Guidelines and recommendation of: Bres, et.al. Towards Best Practices for Jet Noise Predictions with Unstructured Large Eddy Simulations. AIAA 2012-2965

Medium mesh 175M

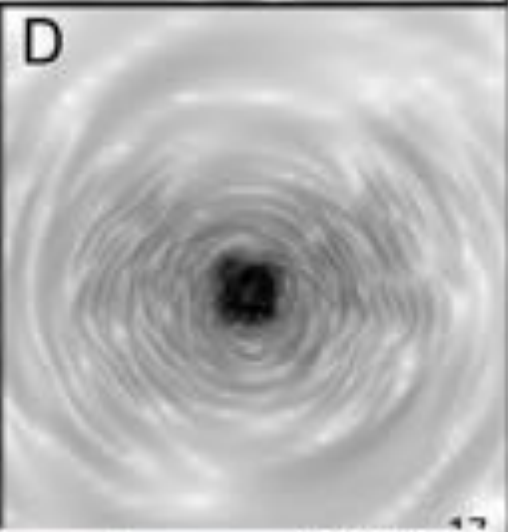
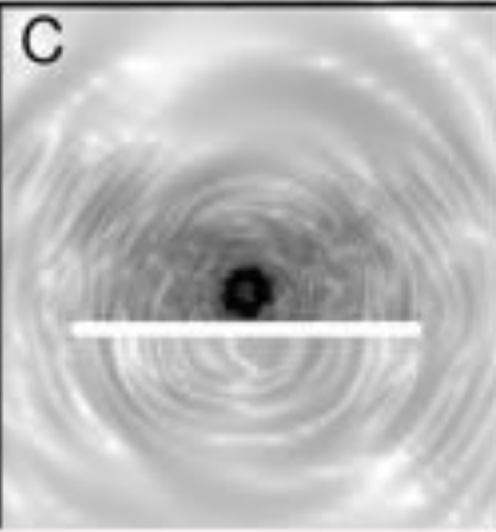
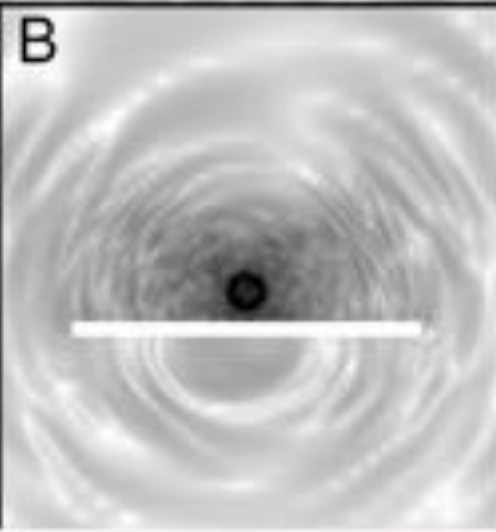
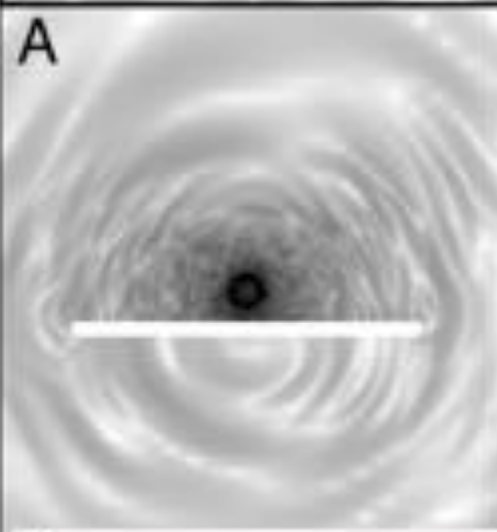
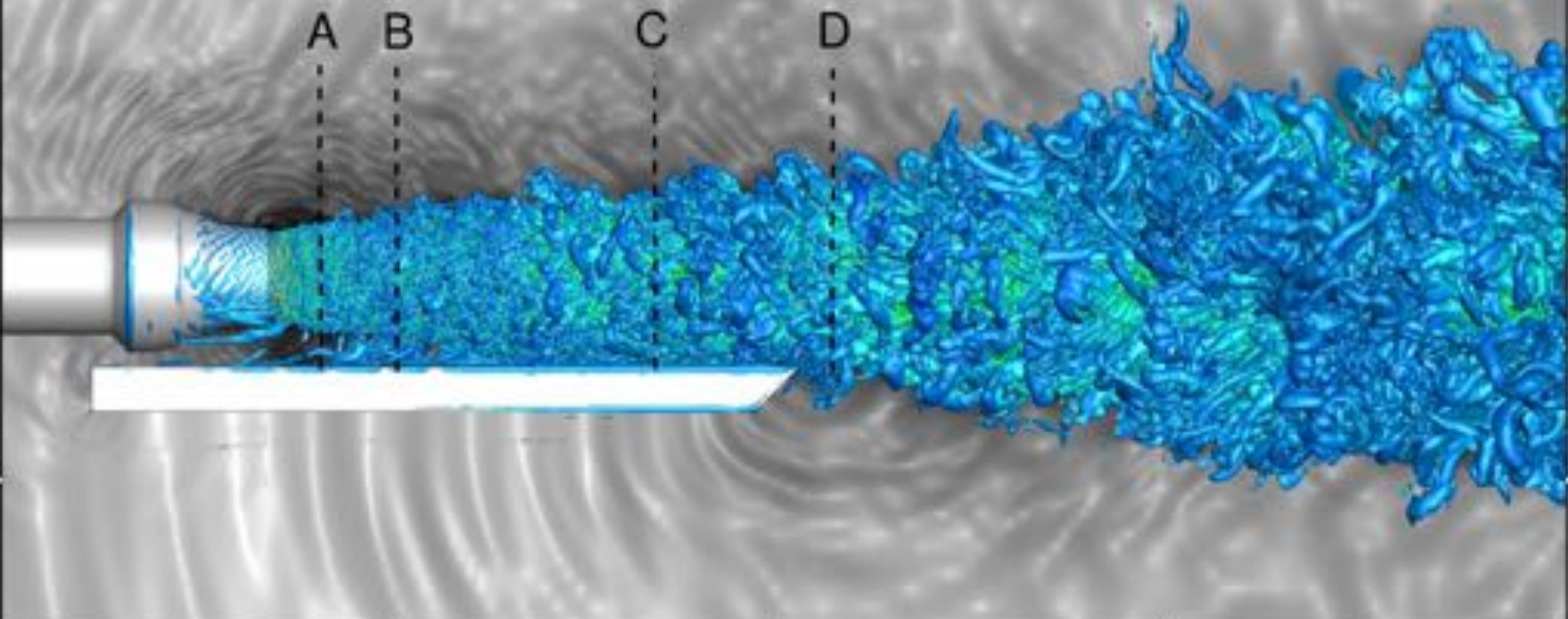



# First Step Towards Radical Installation Concepts



Initial Validation

Shielding  
Concept

FWH1: Big Box  
(grey)

FWH2: Small Cone  
(blue)

FWH2: Small Box  
(cyan)

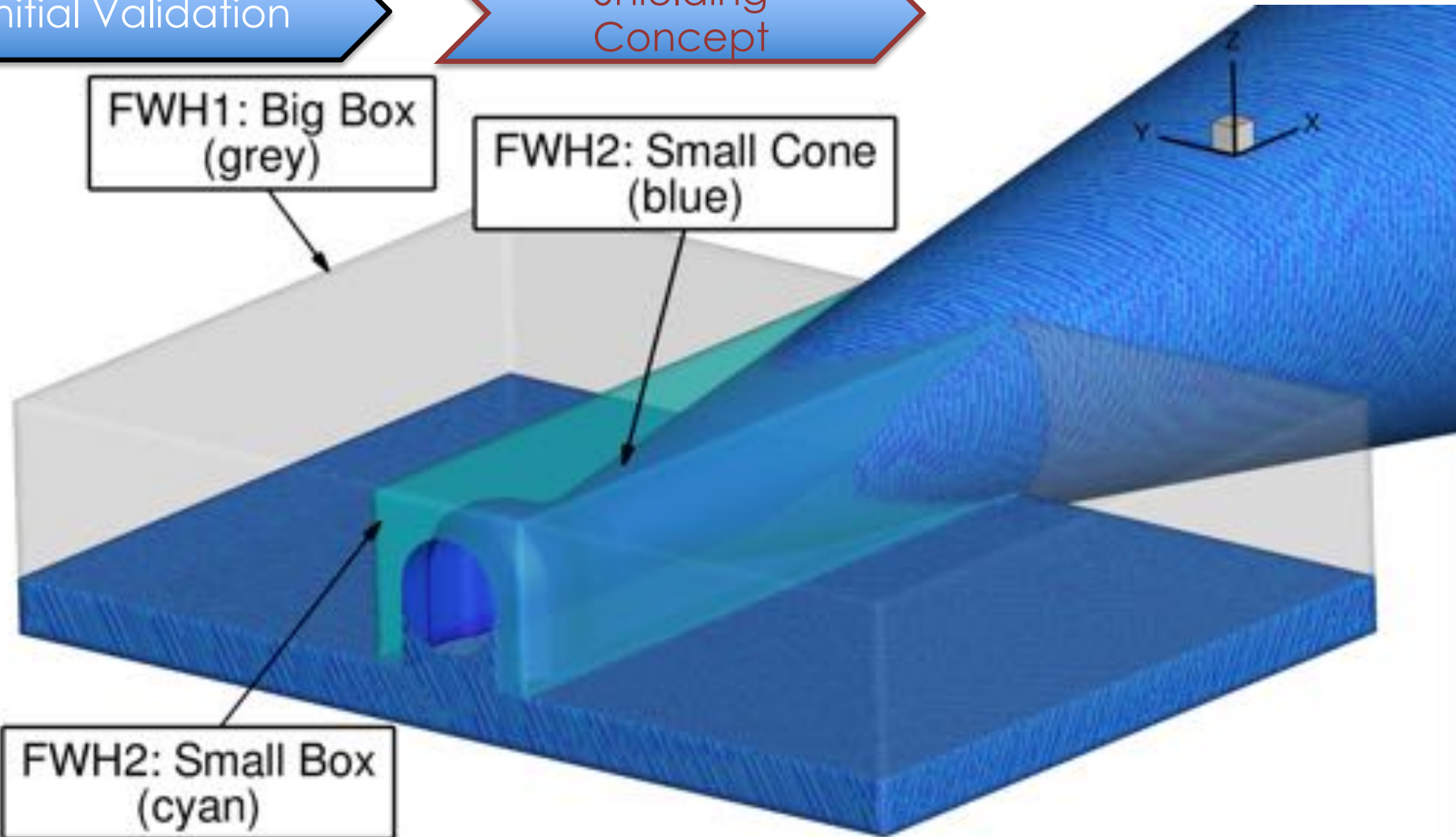

- ✓ Choice of FWH surface not trivial.
- ✓ Conflicting requirements on resolution and inclusion of all relevant sound generation and shielding physics.

# First Step Towards Radical Installation Concepts



Initial Validation

Shielding Concept

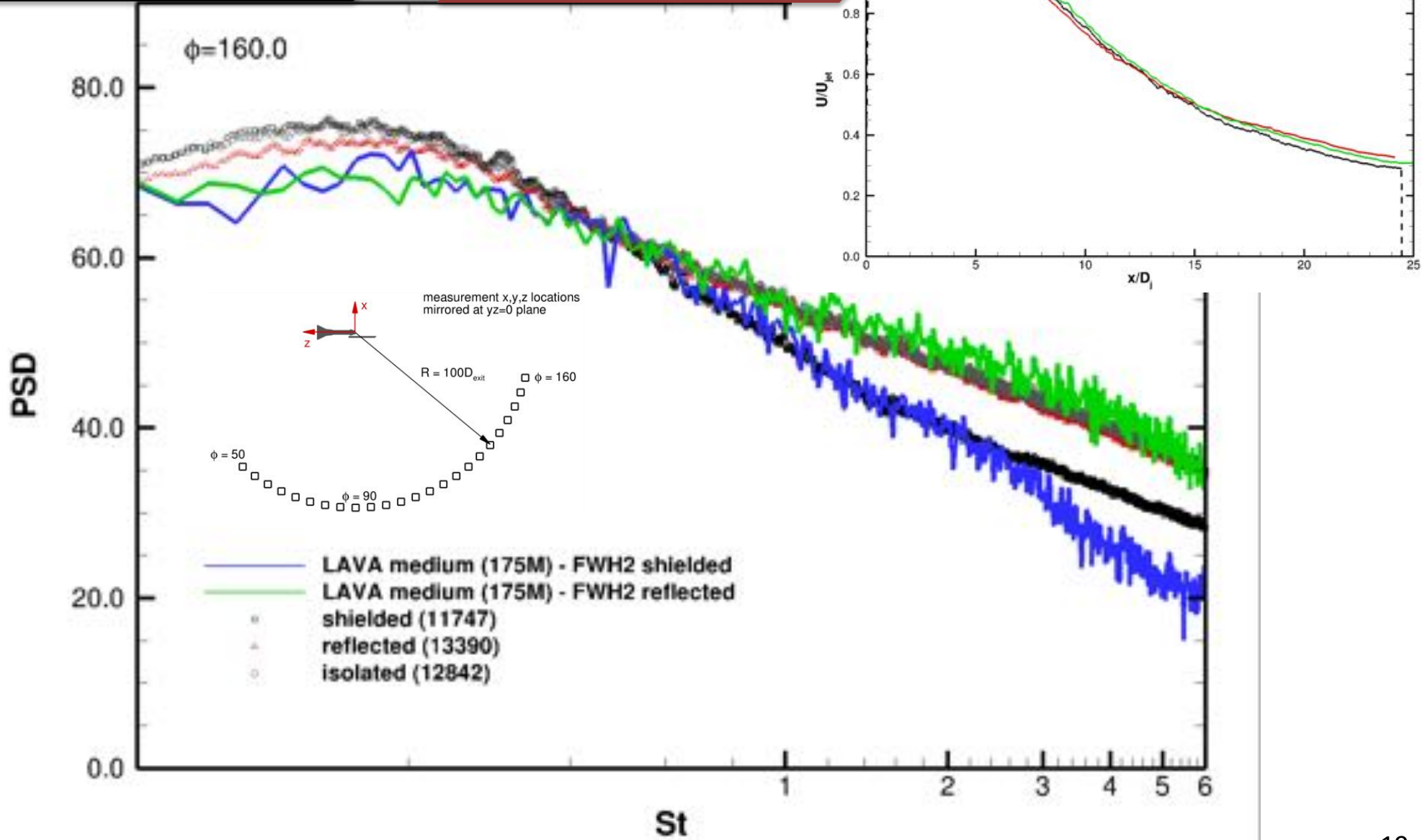

# Next Step Towards Radical Installation Concepts



Initial Validation

Shielding  
Concept

Radical Installation  
Concepts

## Objective:

- ✓ Significantly increase complexity (last step before “grand challenge”).
- ✓ Multi-stream nozzle with shielding and installation effects.
- ✓ Comparison with comprehensive experimental database.



Picture taken from:  
Test Report: Top-Mounted Propulsion Test 2017 (TMP17),  
James Bridges

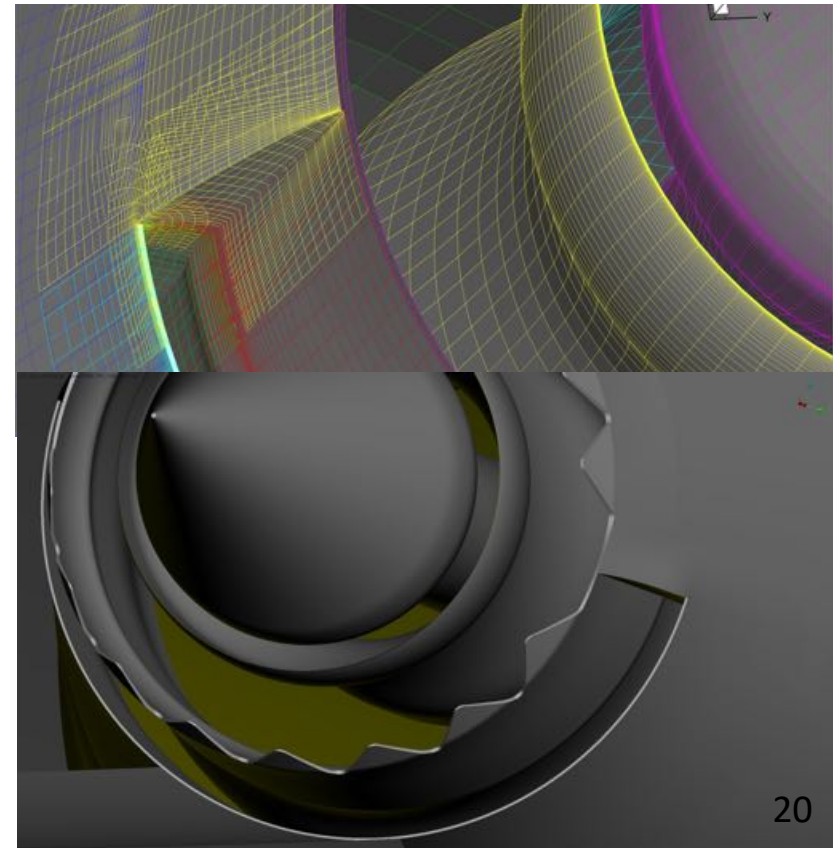
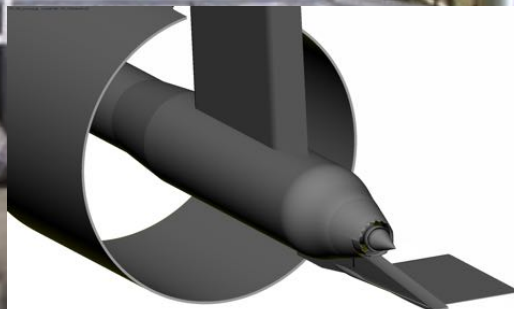



# ORION

## Launch Abort System (LAS)



# NASAfacts

### Ensuring Astronaut Safety

NASA is developing technologies that will enable humans to explore new destinations in the solar system. America will use the Orion spacecraft, launched atop the Space Launch System rocket, to send a new generation of astronauts beyond low-Earth orbit to places like an asteroid and eventually Mars. In order to keep astronauts safe in such difficult, yet exciting missions, NASA and Lockheed Martin collaborated to design and build the Launch Abort System.

# Validating Acoustics Against 80AS Experiment



- Wind Tunnel Measurements
- LAVA Predictions

Third-Octave Spectra for Sensor K117,  $df=3.6\text{Hz}$

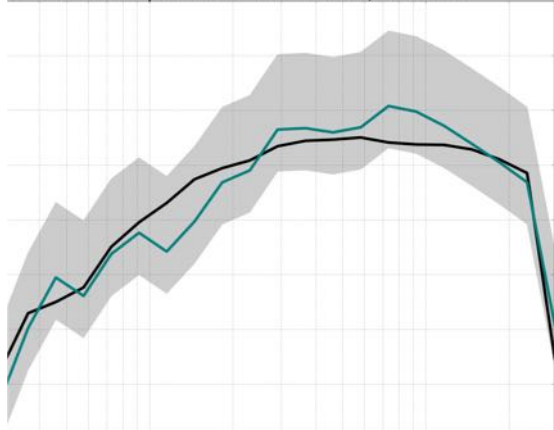

Third-Octave Spectra for Sensor K059,  $df=3.6\text{Hz}$

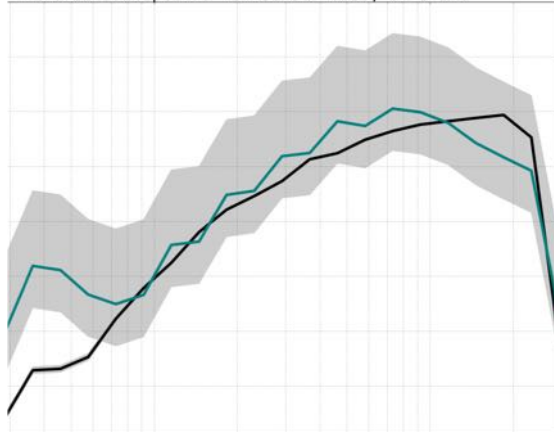

Third-Octave Spectra for Sensor K173,  $df=3.6\text{Hz}$

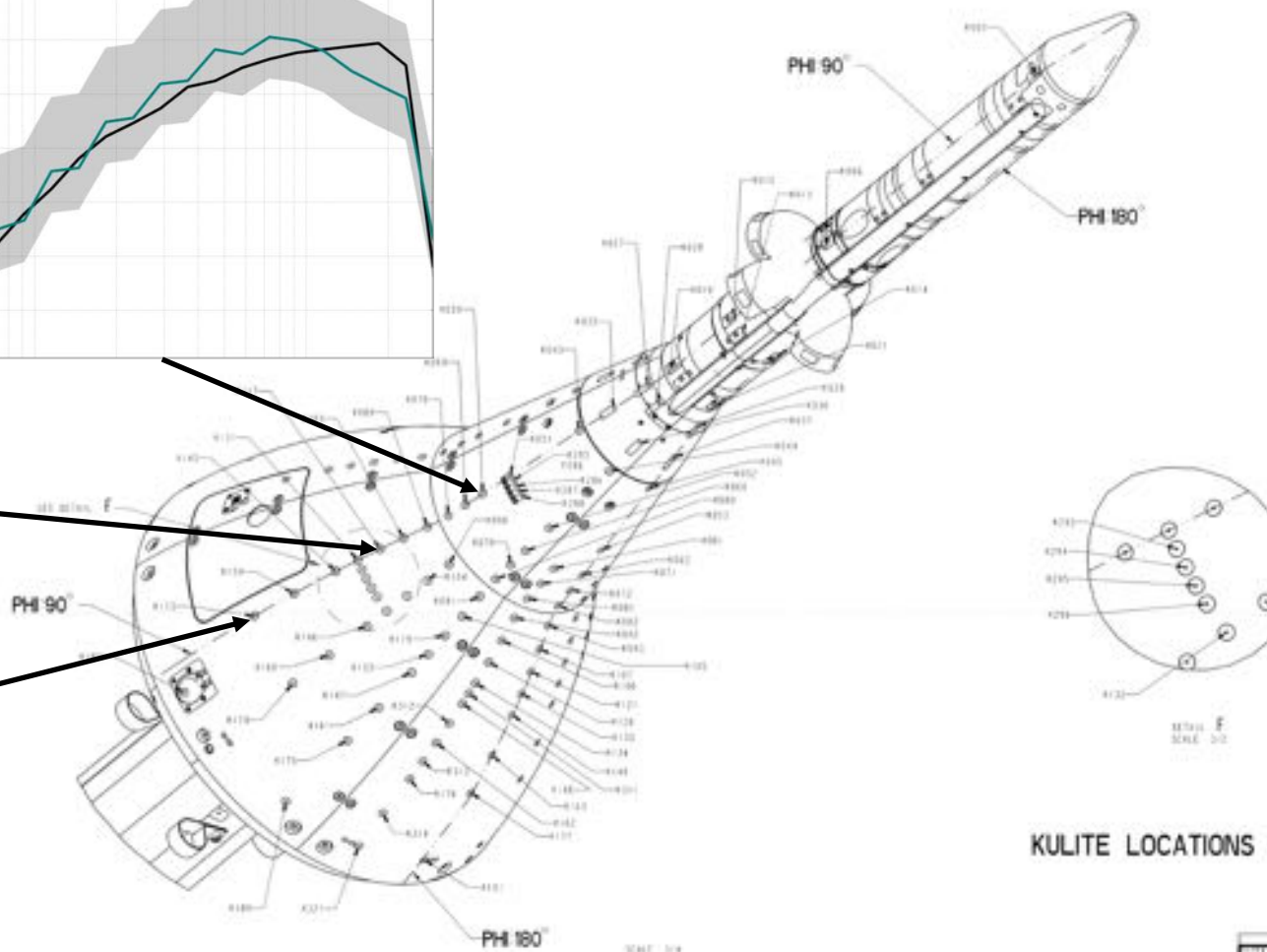
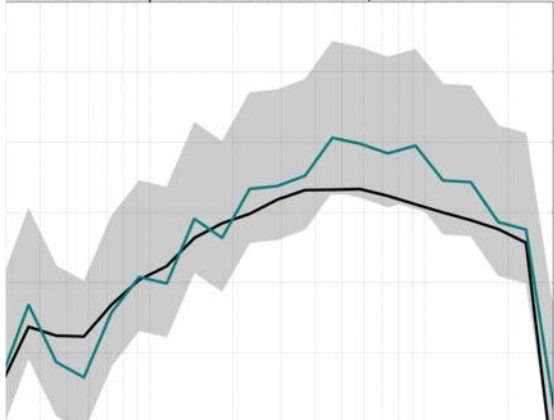

KULITE LOCATIONS



# Launch Abort Vehicle



- Collaborated with the Orion Loads and Dynamics team at JSC to help characterize the vibro-acoustic environment of the Orion Launch Abort Vehicle (LAV) for launch and ascent abort scenarios
- LAVA solver was used to perform many scale-resolving, time-accurate simulations to investigate trends in vibration levels on the LAV surface across a range of Mach numbers and angles of attack, and to help reduce uncertainty in areas where experimental or test data are not available

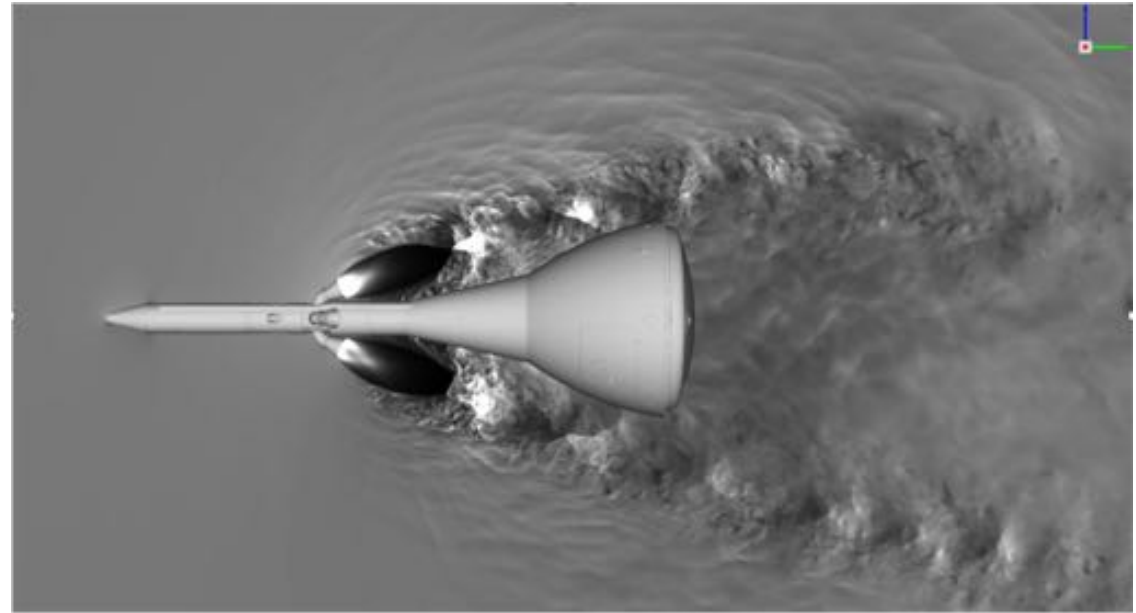

*Pressure on the vertical plane (white is high, black is low) during ascent abort*

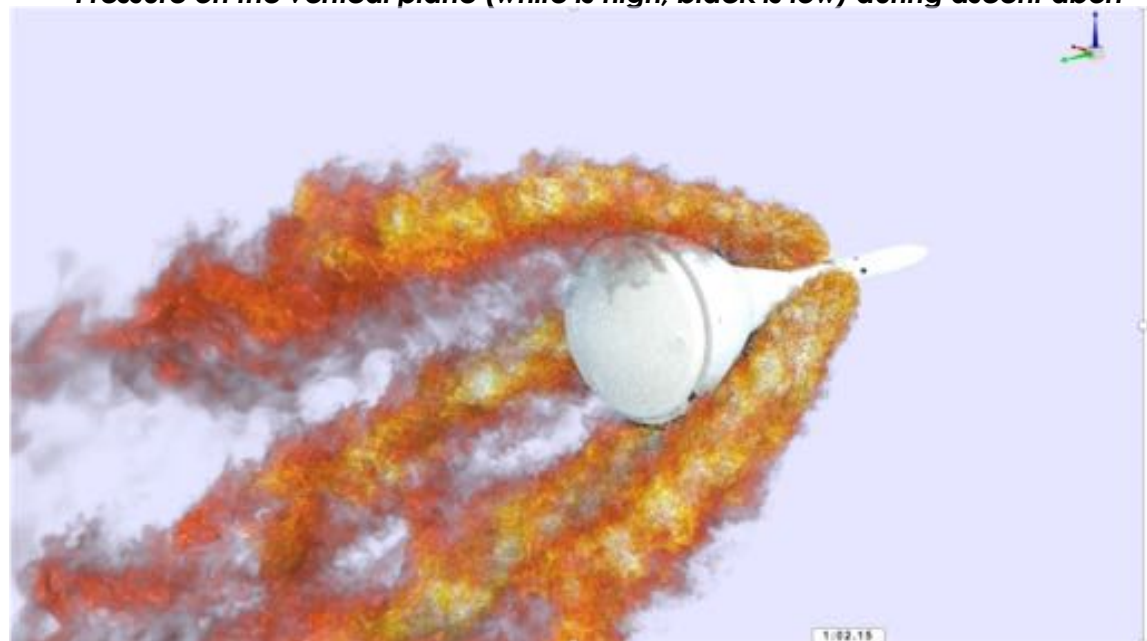

*Volume rendering of temperature (white is hot, black is warm) during ascent abort*



- **Motivation**
- **LAVA Framework**
- **Jet Noise Prediction**
  - Hybrid RANS/LES efforts on round jet – Overset Curvilinear Navier-Stokes (NS)
  - Orion/MPCV Launch Abort System transient loads prediction - Cartesian NS
- **Rotor Blade Noise: Isolated UAS Rotor in Hover Validation**
  - Overset Curvilinear NS
  - Cartesian NS
  - Cartesian Lattice Boltzmann
- **NASA R4 Noise Source Diagnostics Test (SDT)** – Cartesian NS (Preliminary)

Picture credit: NASA / Lillian Gipson

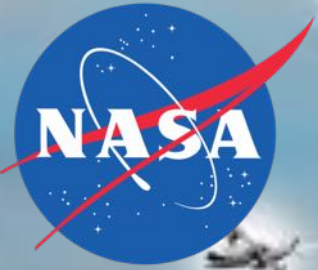

**Towards Urban Air Mobility (UAM)**

**High-Fidelity Modeling and Optimization Method Development  
NASA Revolutionary Vertical Lift Technology Rotary Project (RVLT)**



# Isolated UAS Rotor in Hover Validation

## Objective:

- ✓ Validate LAVA for RVLT applications
- ✓ Assess pros and cons of body-fitted/Cartesian Grid as well as Navier-Stokes/Lattice Boltzmann approaches

## Computational Methodology :

- ✓ Navier-Stokes (NS) URANS solver on Structured Overset Grid
- ✓ Navier-Stokes as well as Lattice Boltzmann (LB) on Cartesian Grid

## Validation:

- ✓ Propeller Performance
- ✓ Far-field Acoustics

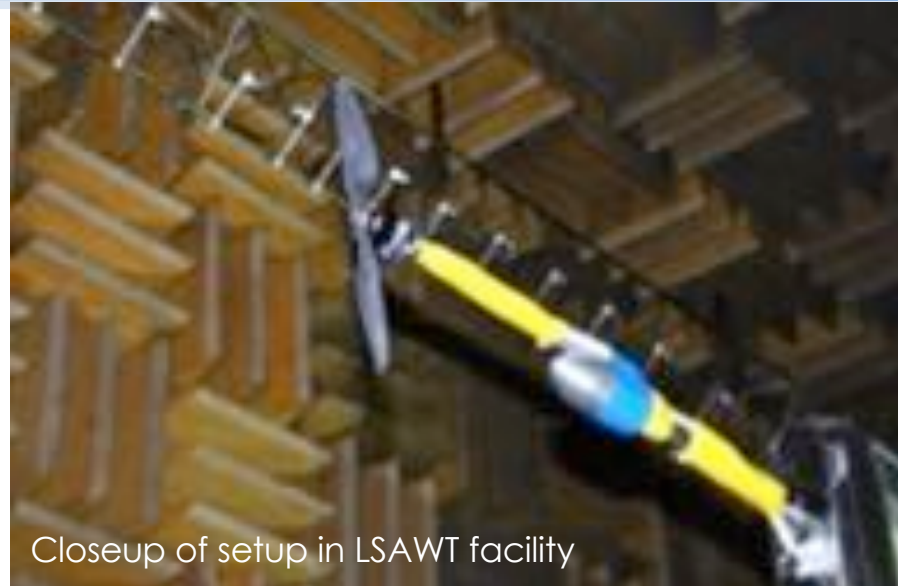

Closeup of setup in LSALT facility

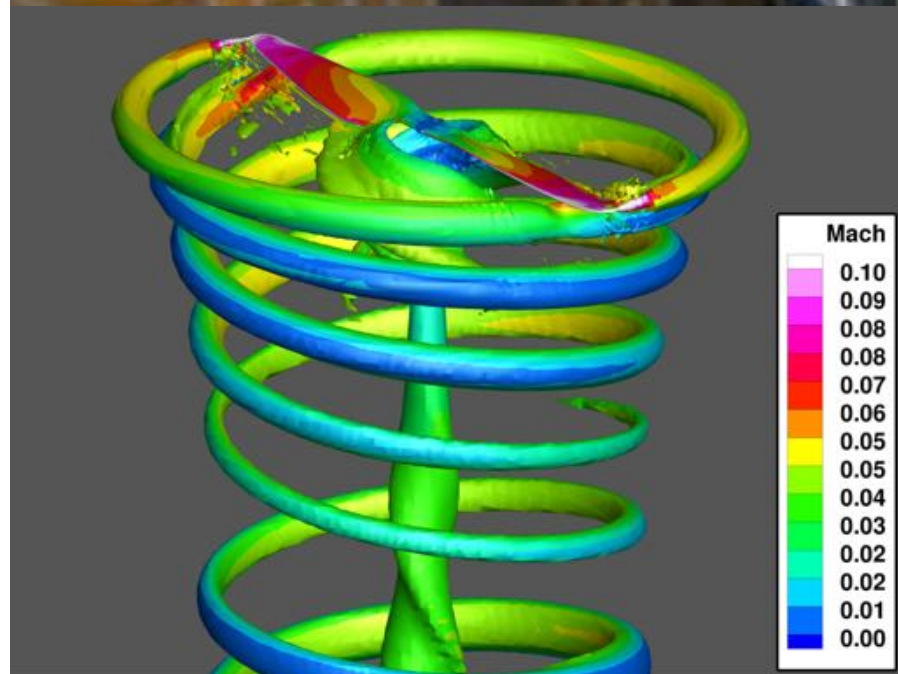

LAVA uRANS simulation at 5400 RPM

# Isolated UAS Rotor in Hover Validation

**Zawodny and Haskin**  
(AIAA-2017-3709)

Rotor Span R	0.1905 [m]
Microphones (M1-M5)	10R
Considered RPM	5400

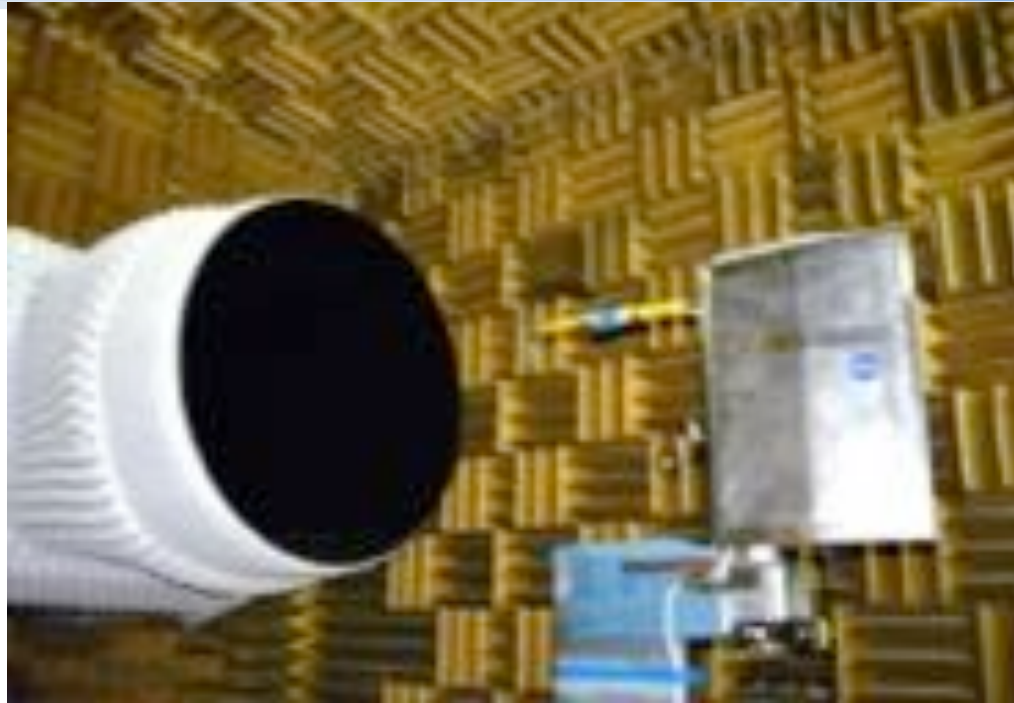
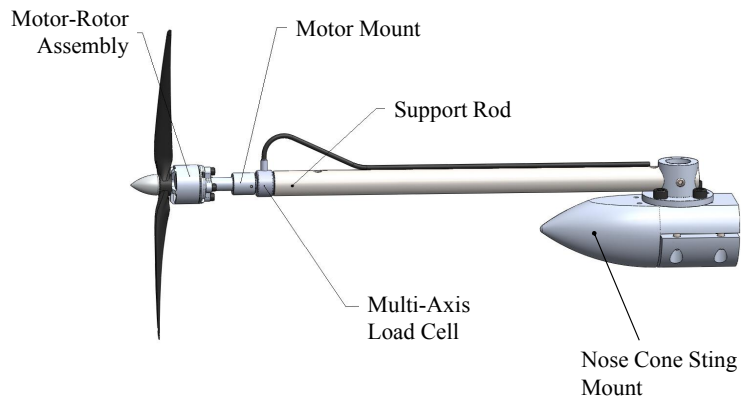

- ✓ Experiments conducted at NASA Langley LSAWT as well as in the Structural Acoustics Loads and Transmission (SALT) anechoic chamber.
- ✓ Motor-Rotor Assembly as well as Mount and Support structure not considered in simulations.

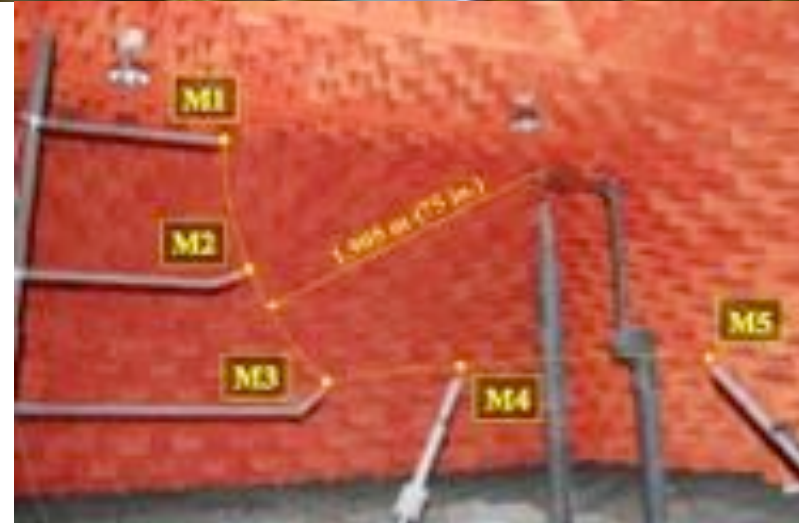

Experimental Data from Zawodny and Haskin AIAA-2017-3709

# Structured Overset Curvilinear URANS Mesh Refinement Study



Coarse

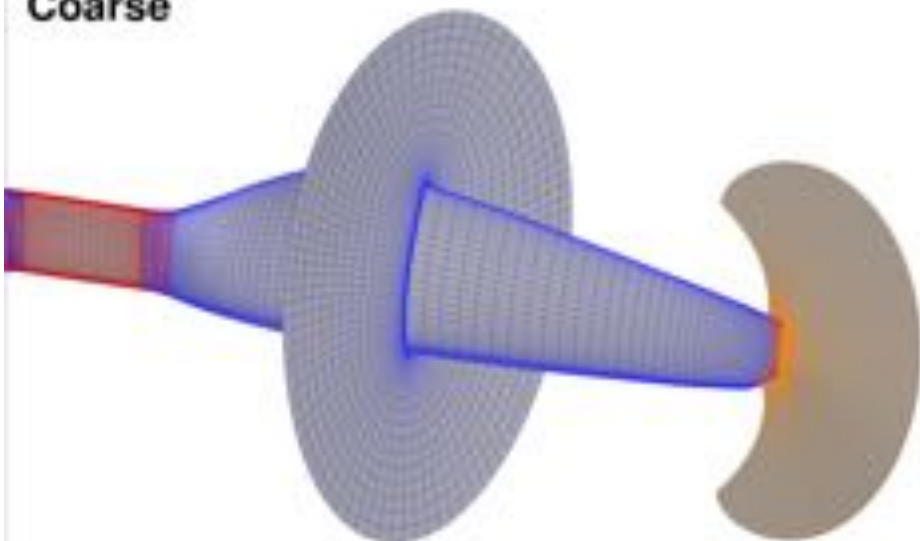

Medium

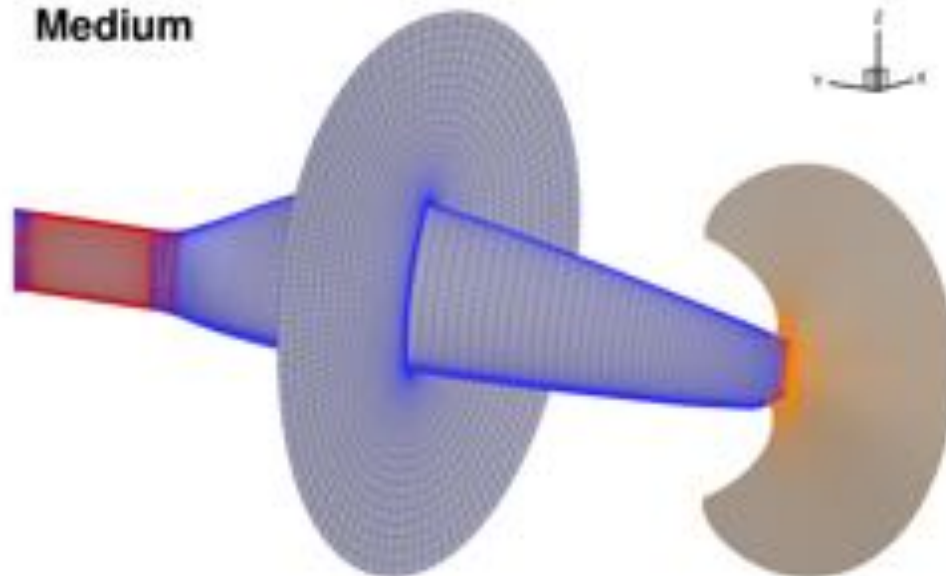

Fine

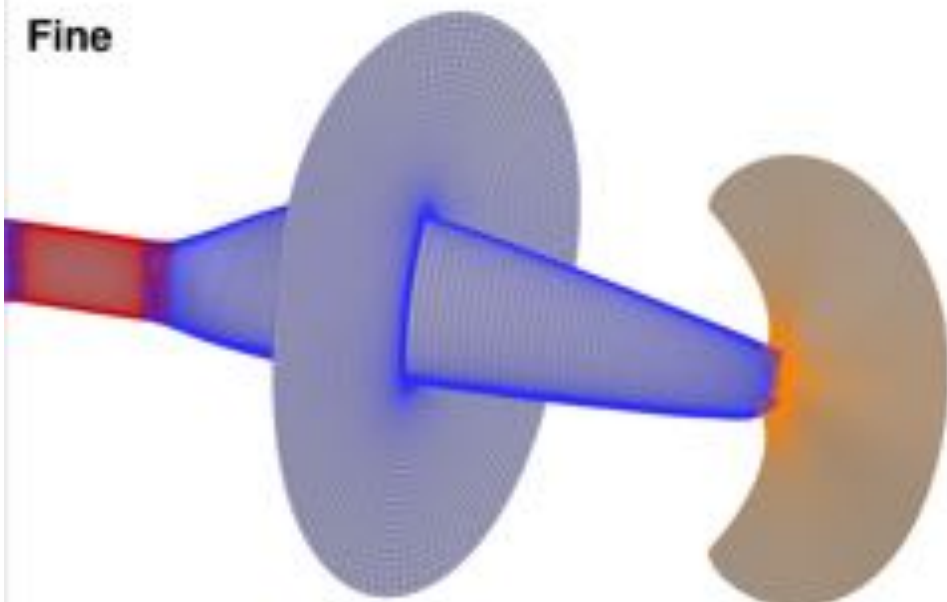

Family of 3 Structured Overset Grid Systems

Coarse: 6.64 M grid points

Medium: 14.61 M grid points

Fine: 35.73 M grid points

Each mesh built with double fringe and 0 orphans

# Structured Overset Curvilinear URANS Rotor Performance at Different RPM

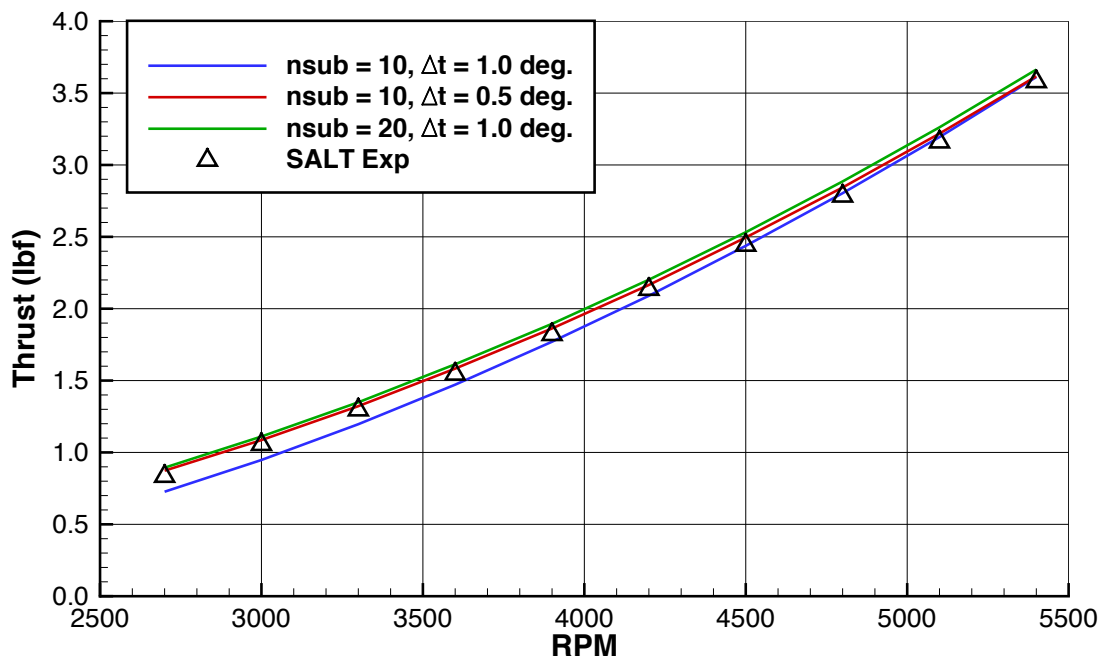
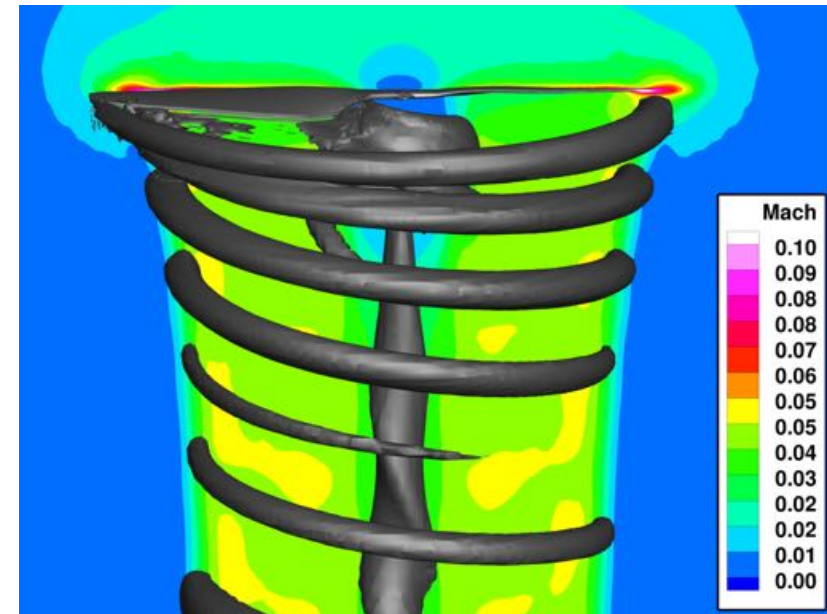
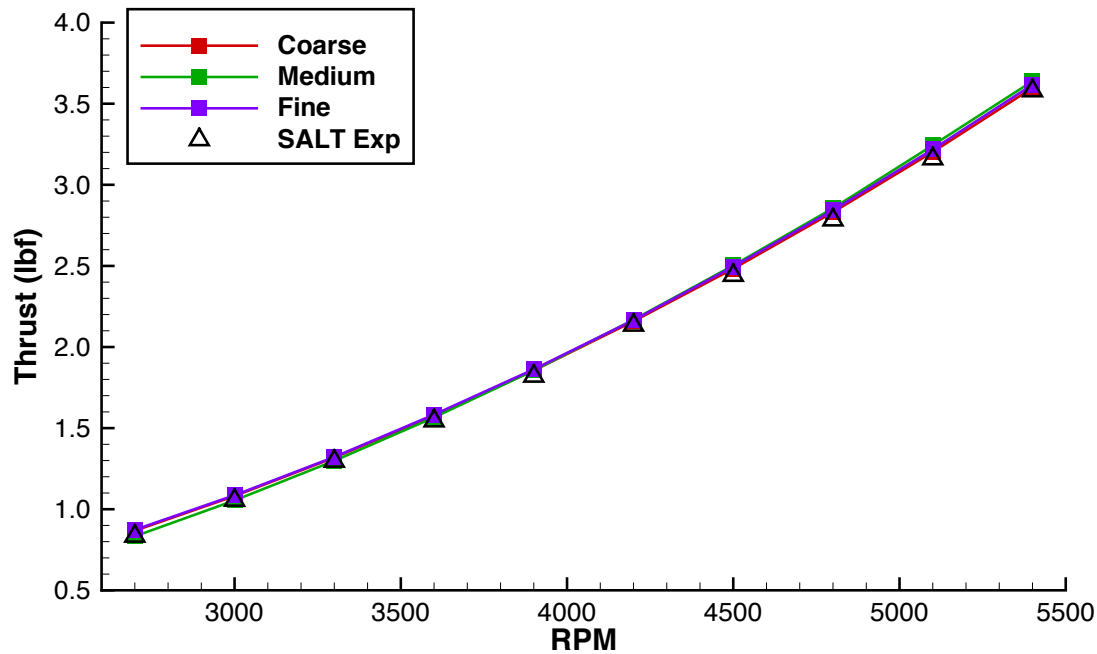

- ✓ uRANS with Spalart Allmaras Turbulence model SA
- ✓ Results verified to be grid independent
- ✓ No strong sensitivity to timestep choice or number of sub iterations per implicit timestep

# Structured Overset Curvilinear URANS

## Farfield Noise – Comparison to Microphone Data M1 & M3

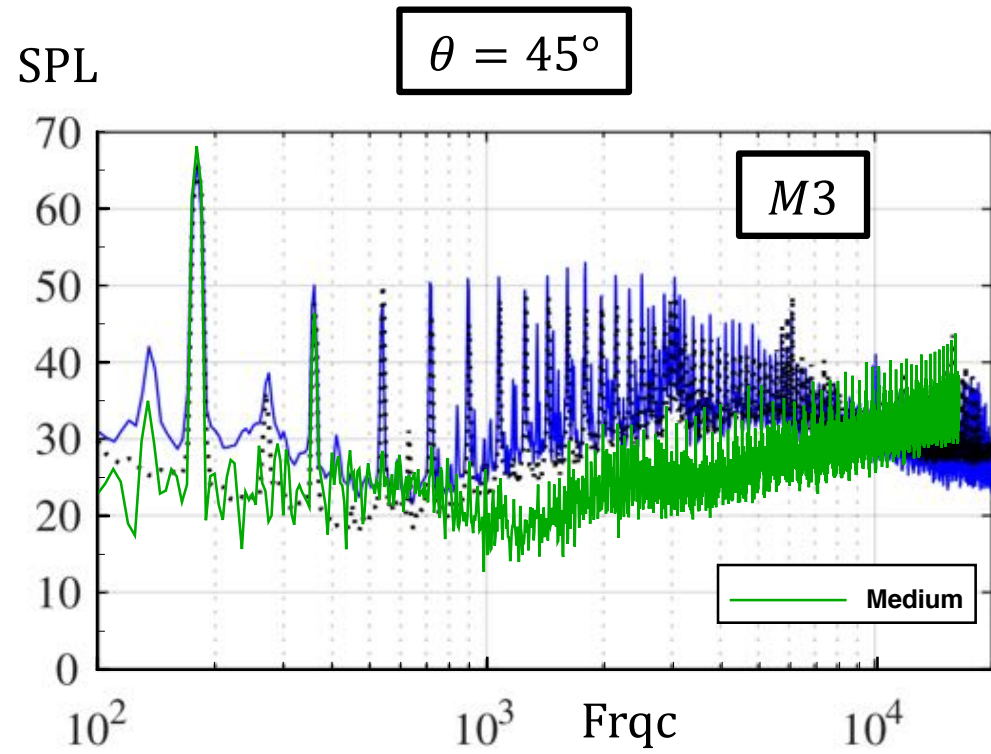
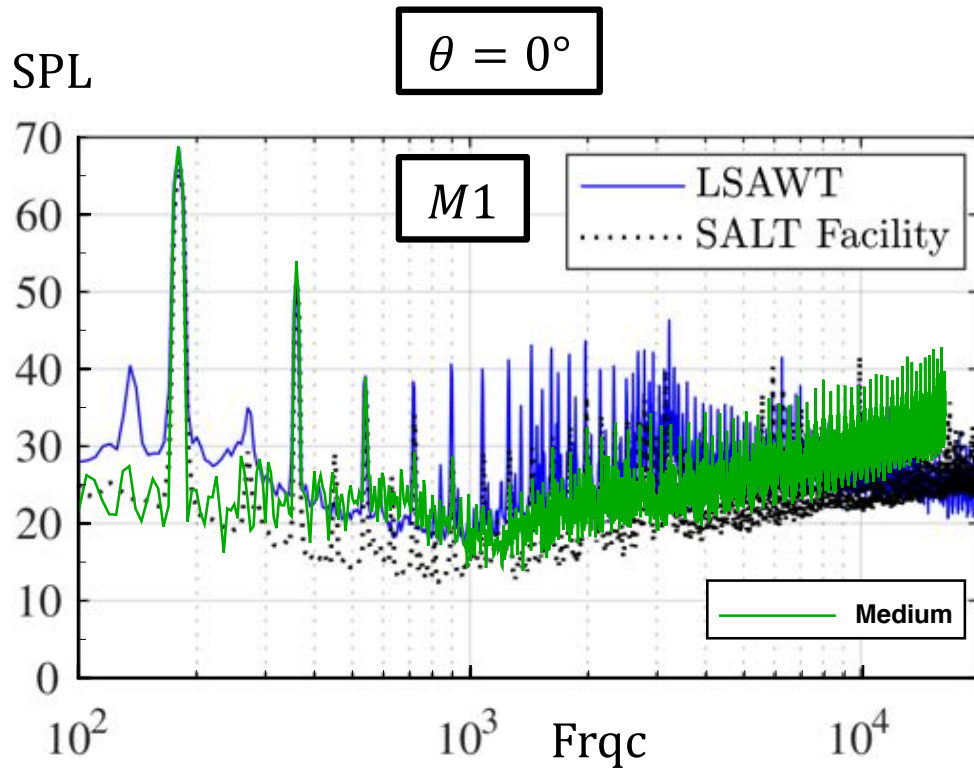

Spectrum (df = 5Hz , RPM = 5400)

- ✓ Acoustic propagation using permeable FWH formulation
- ✓ Good agreement with SPL spectrum for leading harmonics of the Blade Pass Frequency (BPF)

# Structured Overset Curvilinear URANS Farfield Noise – Directivity for Linear Microphone Array

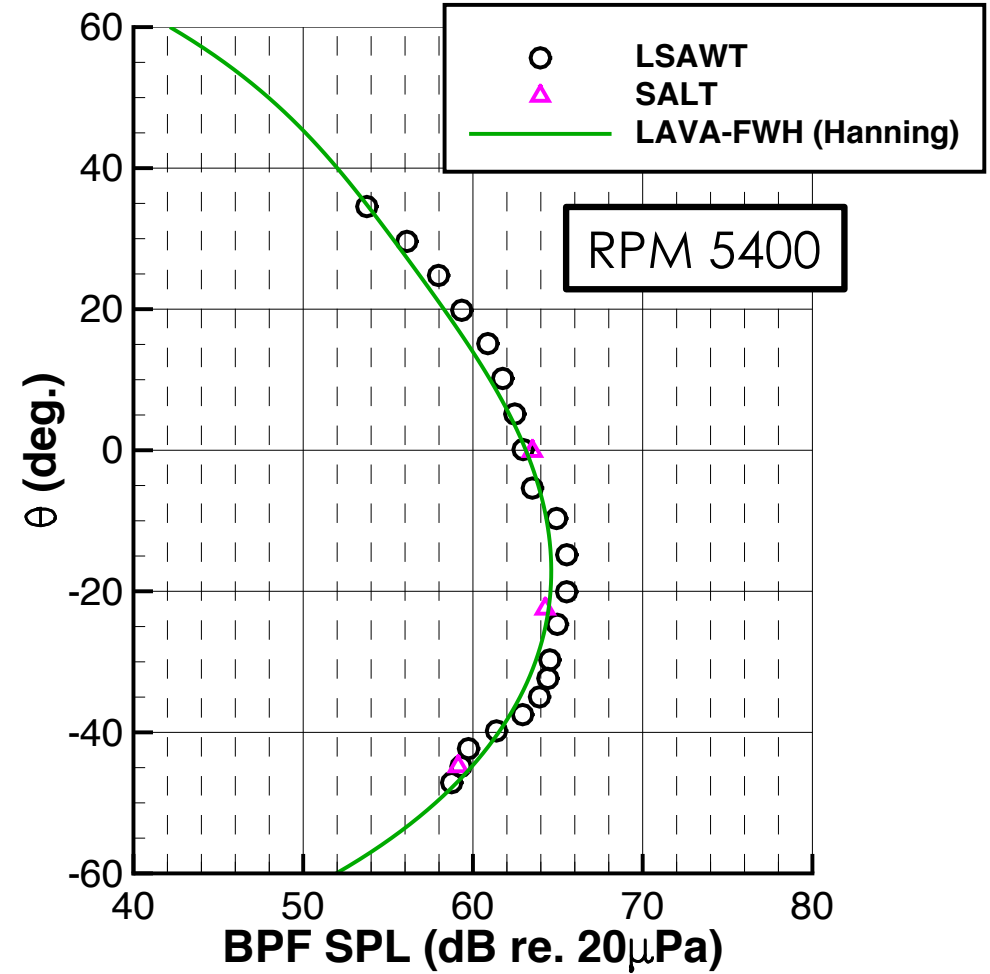
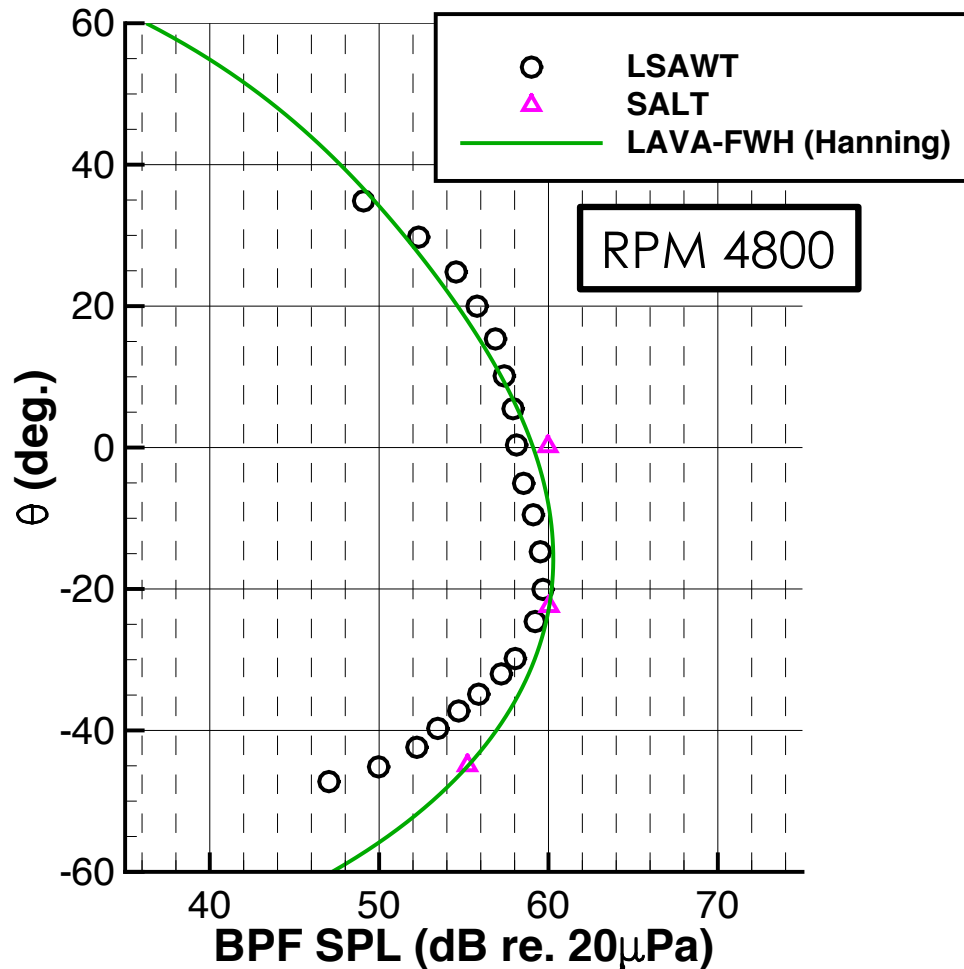

- ✓ Excellent agreement observed in directivity for different RPM
- ✓ Better Agreement with SALT data for RPM 4800

# LAVA Cartesian Methods

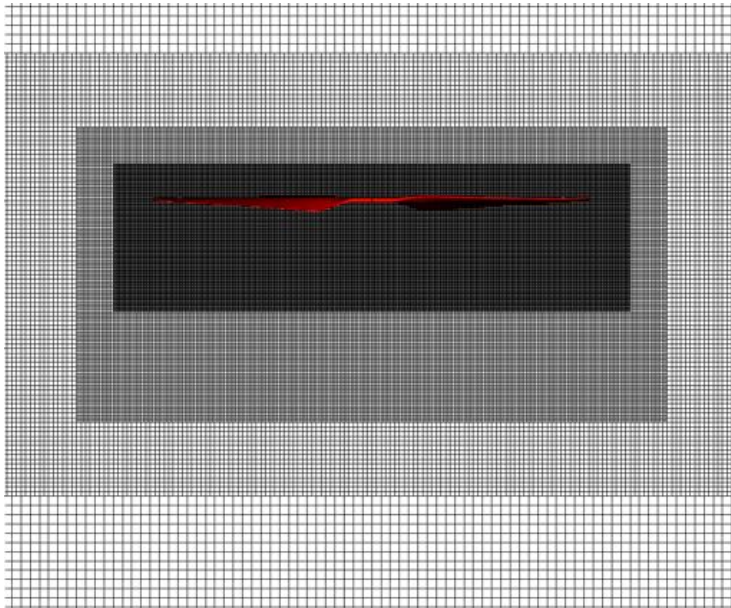
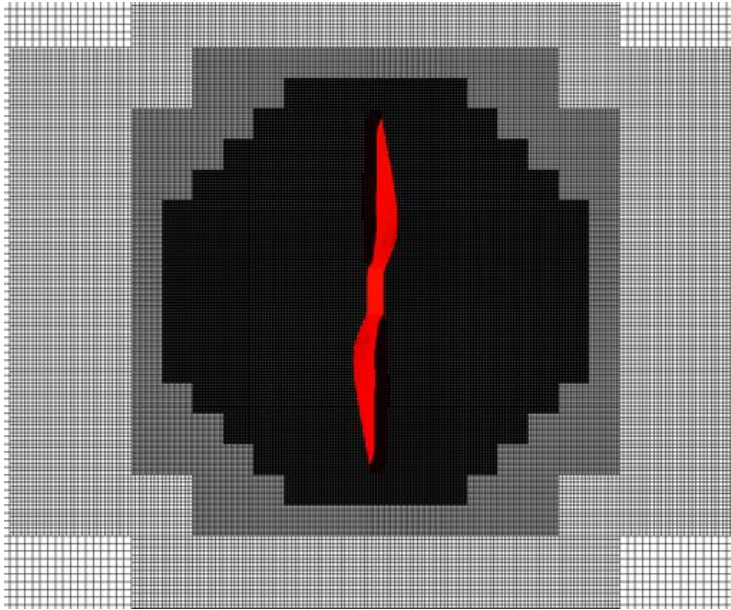

Lattice Boltzmann  
(LBM – EMRT)

Navier-Stokes  
(NS – WENO6)

- ✓ Refinement ratio of 2:1
- ✓ Very Coarse : 40% tip chord ( 8lev)
- ✓ Coarse : 20% tip chord ( 9lev)
- ✓ Medium : 10% tip chord (10lev)
- ✓ Fine : 5% tip chord (11lev)

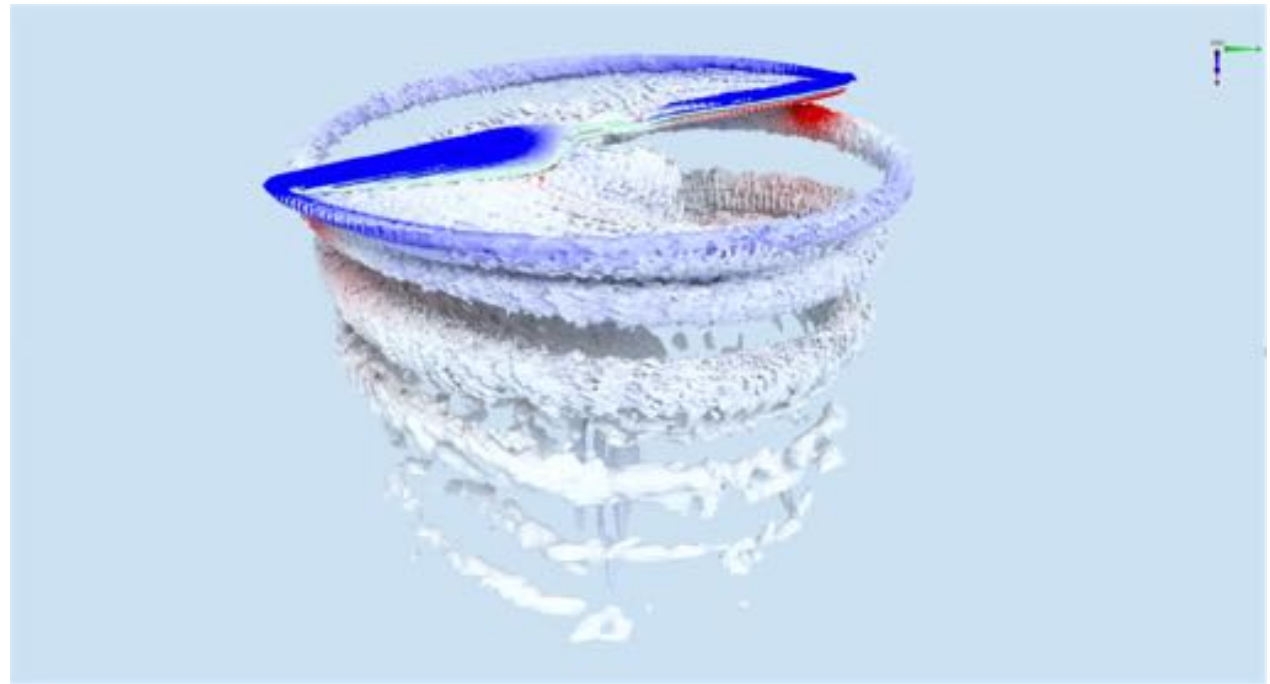

Isocontour of Q-criterion colored by Pressure. Simulation on medium Cartesian mesh.

# Lattice Boltzmann Method Rotor Performance at 5400 RPM

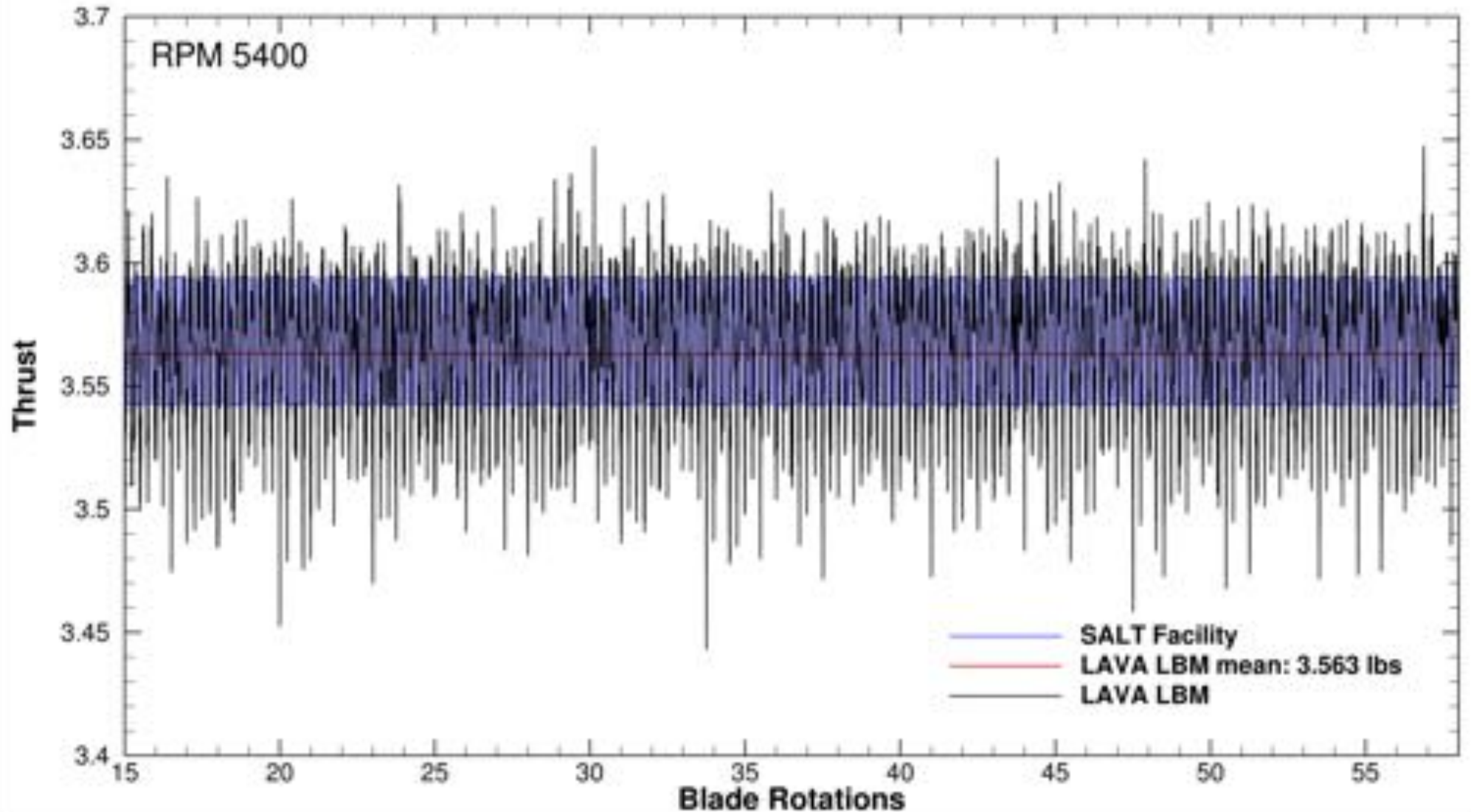

- ✓ Excellent agreement with experimental measurements
- ✓ Differences ( $< 1\%$ ) well within measurement uncertainty (highlighted in blue)



# Lattice Boltzmann Method Farfield Noise – SPL Spectrum for Observer M1 & M3

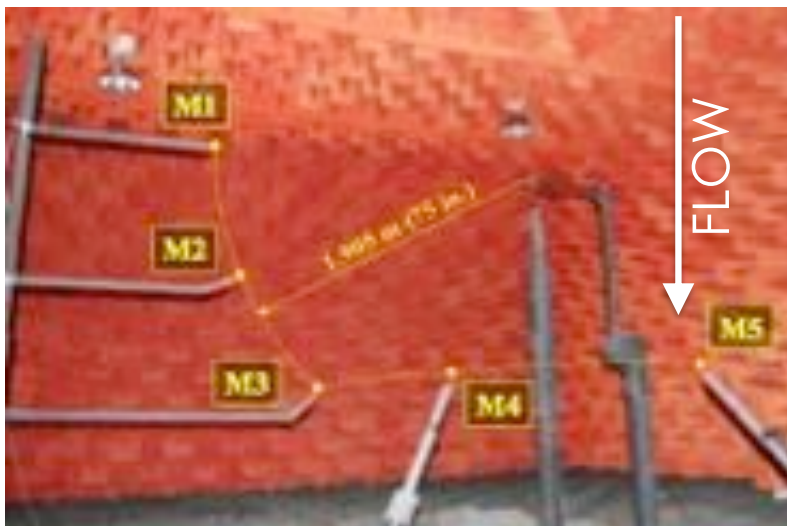
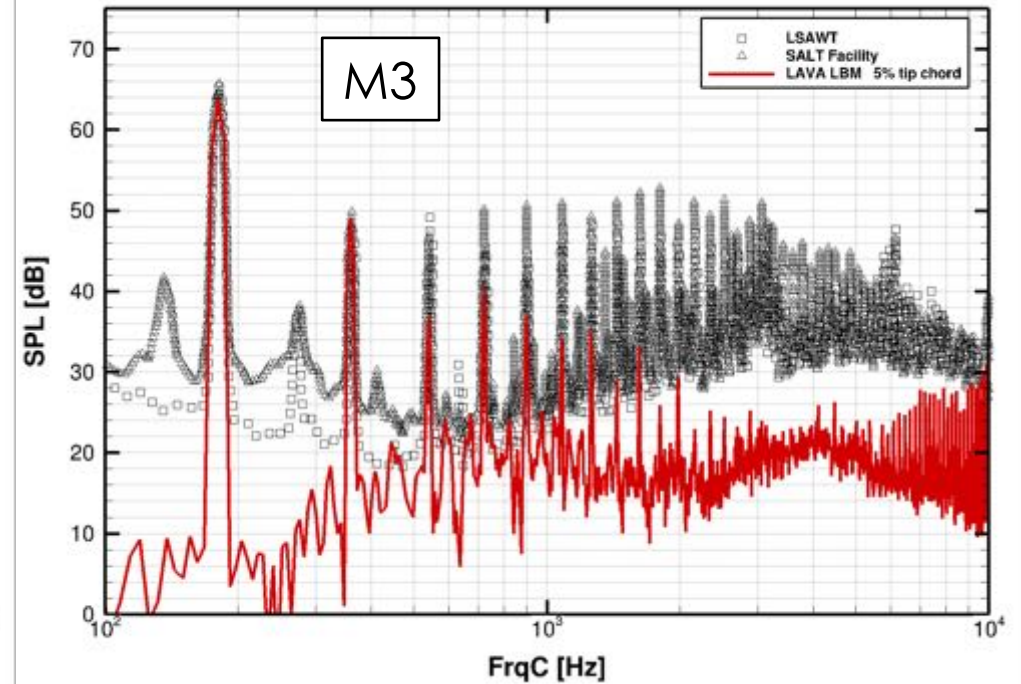
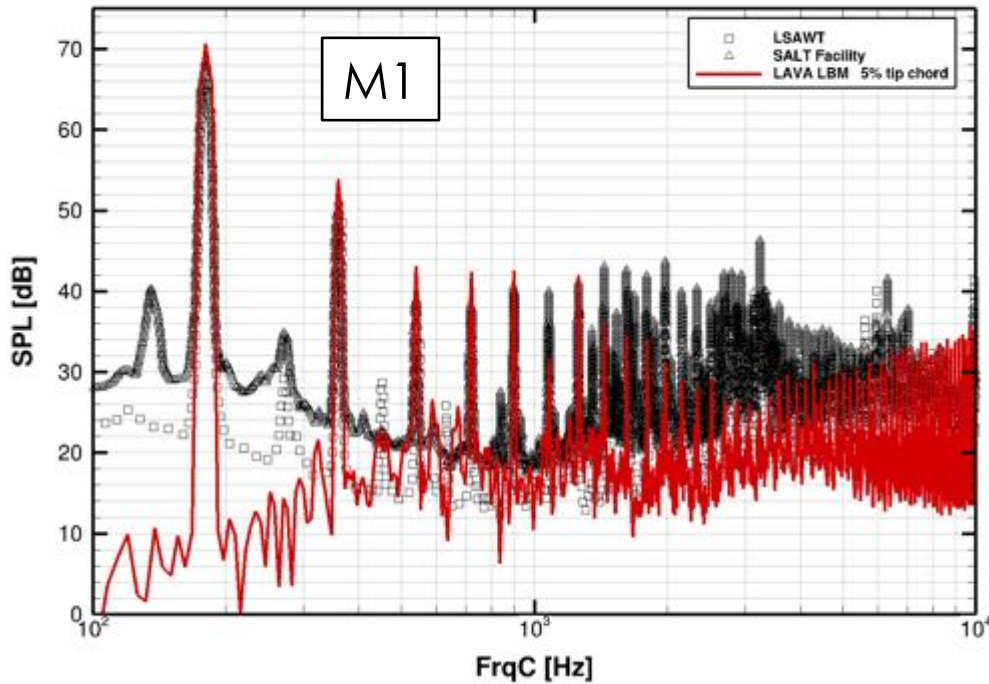

- ✓ Excellent agreement with BPF1-BPF5 for M1 ( $0.0^\circ$ ) microphone location
- ✓ Excellent agreement with BPF1 & BPF2 for M3 ( $45.0^\circ$ )
- ✓ Different FWH formulations (permeable and impermeable) currently under investigation

# Lattice Boltzmann Method Farfield Noise – Mesh Refinement Study

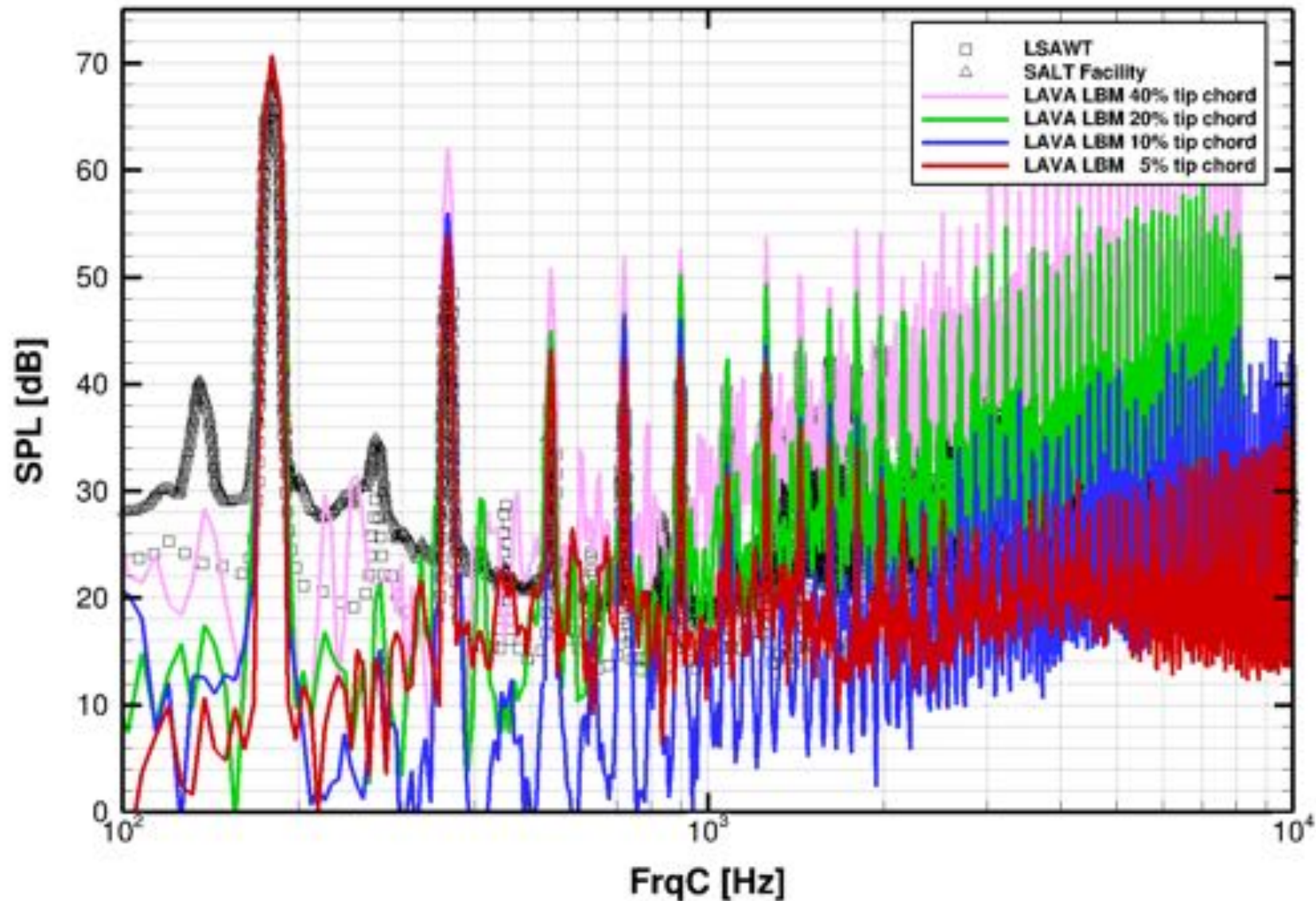

- ✓ Consistent agreement for BPF1 on all mesh levels, BPF2 more sensitive.
- ✓ Good agreement for BPF 1 even on very coarse mesh.

# Comparison between URANS and LBM

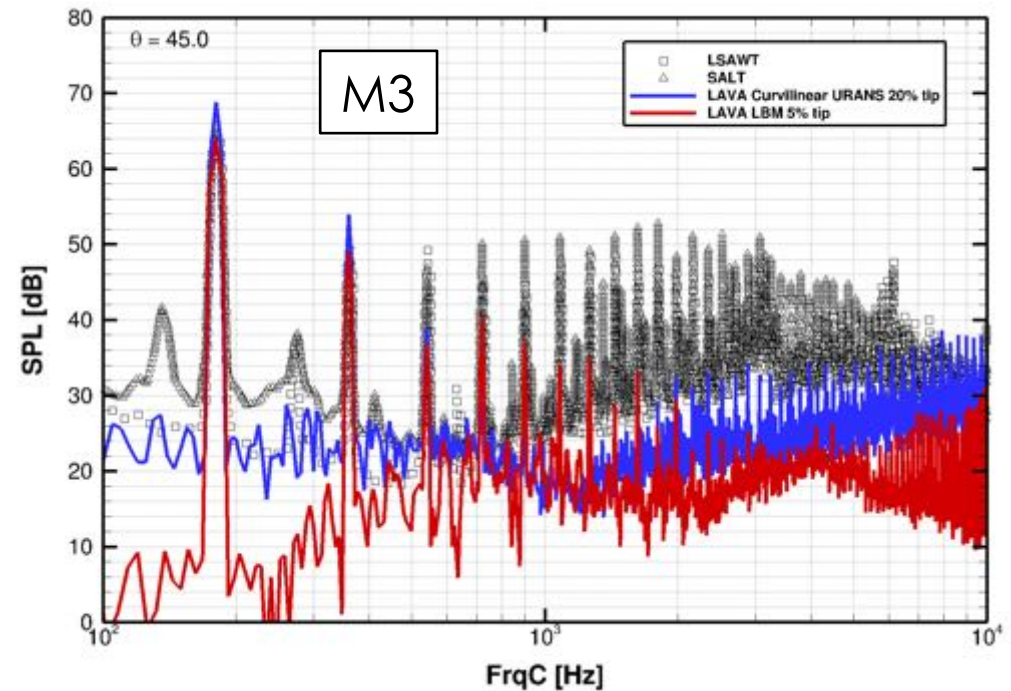
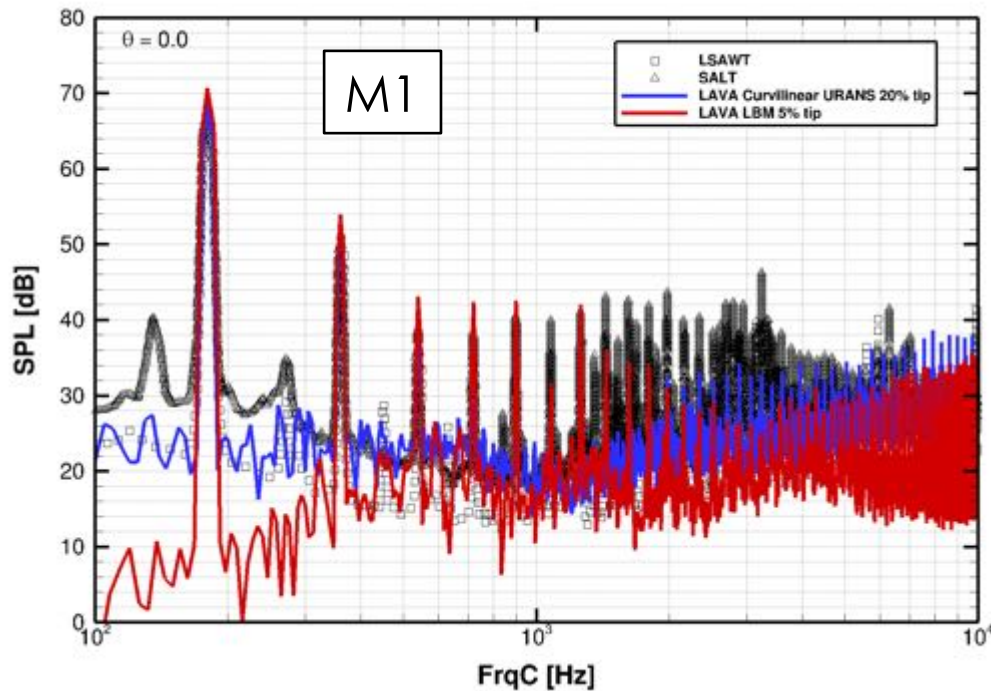

- ✓ Consistent prediction using both approaches
- ✓ Computational efficiency and complete absence of manual volume mesh generation key advantage of LBM
- ✓ Manual meshing efforts significantly increase upon considering installation effects (e.g. full Quadcopter or tiltwing urban air taxis)



- **Motivation**
  - **LAVA Framework**
  - **Jet Noise Prediction**
    - Hybrid RANS/LES efforts on round jet – Overset Curvilinear Navier-Stokes (NS)
    - Orion/MPCV Launch Abort System transient loads prediction - Cartesian NS
  - **Rotor Blade Noise: Isolated UAS Rotor in Hover Validation**
    - Overset Curvilinear NS
    - Cartesian NS
    - Cartesian Lattice Boltzmann
- **NASA R4 Noise Source Diagnostics Test (SDT)** – Cartesian NS (Preliminary)



## **Aircraft Noise Reduction (ANR)**

### **High Fidelity Acoustic and Performance Simulation of NASA R4 Noise Source Diagnostics Test (SDT)**

POC for the experimental data : Ed Envia (GRC)

# R4 Source Diagnostic Test

## Toward Fan Broadband Noise Prediction



- ✓ Fan Noise Workshop Realistic Case 2 (RC2v2) at approach speed (7808 RPM) with baseline OGV design with goal to compare to hot-wire, LDV, and microphone test data
- ✓ LAVA Cartesian with fixed isotropic refinement zones from fan to exhaust
- ✓ Running two cases:
  - 6th order adaptive WENO [1]
  - 2<sup>nd</sup> order Kinetic-Energy Preserving (KEP) flux [2] with JST Artificial Dissipation [3]
- ✓ Moving geometry with immersed boundary representation
  - Impose slip boundary condition with 2<sup>nd</sup> order ghost cell method with ghost-in-fluid for thin geometry
- ✓ Coarse grid:
  - Min cell size = 2 mm
  - Number of degrees of freedom = 84M
- ✓ Medium grid:
  - Min cell size = 1 mm
  - Number of degrees of freedom = 387M

[1] Hu, X. Y., Q. Wang, and Nikolaus Andreas Adams. "An adaptive central-upwind weighted essentially non-oscillatory scheme." *Journal of Computational Physics* 229.23 (2010): 8952-8965.

[2] Yuichi Kuya, Kosuke Totani, Soshi Kawai. "Kinetic energy and entropy preserving schemes for compressible flows by split convective forms." *Journal of Computational Physics* 375 (2018): 823-853

[3] Jameson, Antony. "Origins and further development of the Jameson-Schmidt-Turkel scheme." *AIAA Journal* (2017): 1487-1510.

# R4 Source Diagnostic Test Toward Fan Broadband Noise Prediction

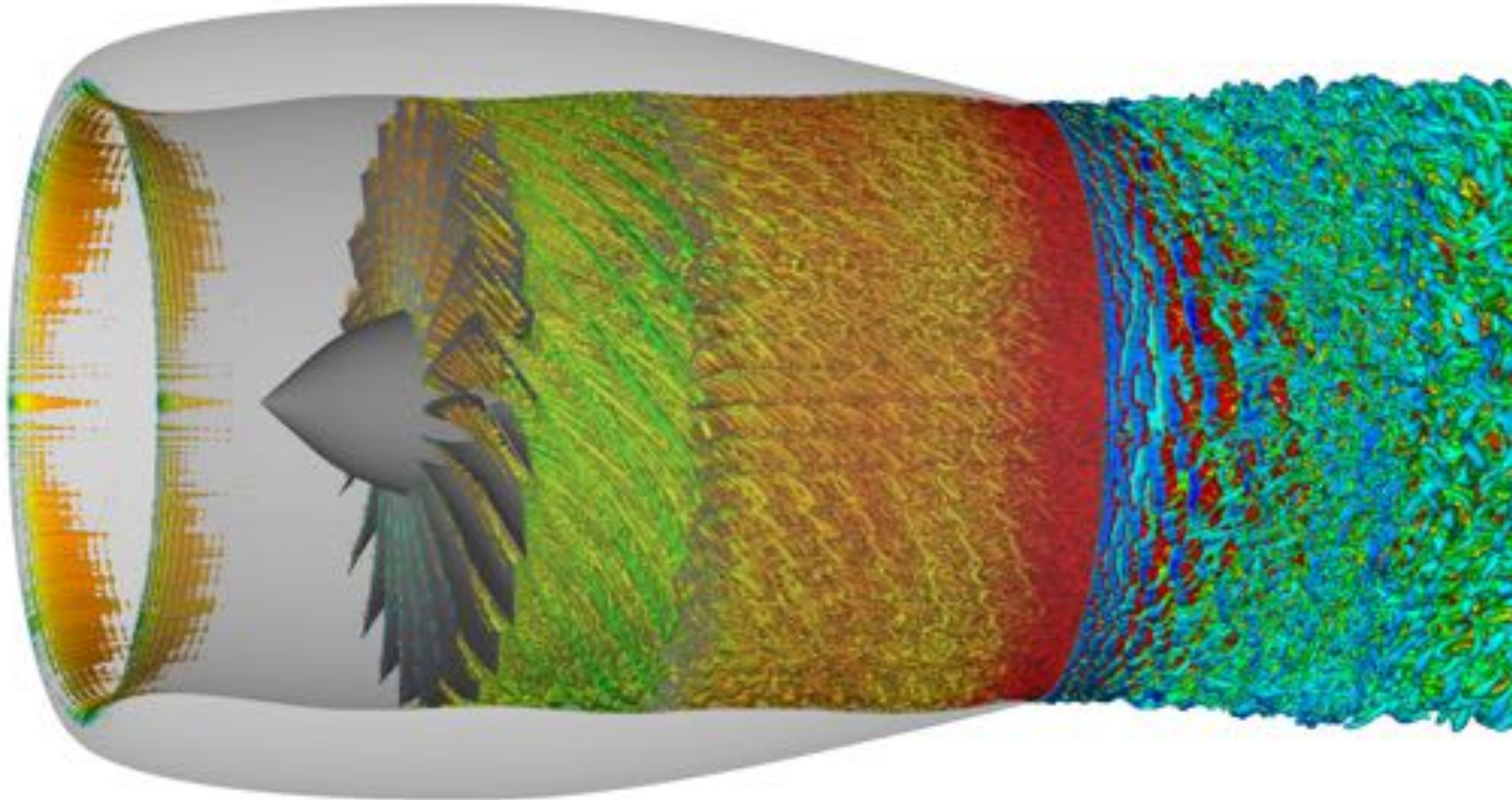

*Isosurface of Q-criterion colored by axial velocity from LAVA Cartesian medium grid scale-resolving simulation with 2<sup>nd</sup> order kinetic energy preserving scheme (KEP)*

# R4 Source Diagnostic Test Toward Fan Broadband Noise Prediction

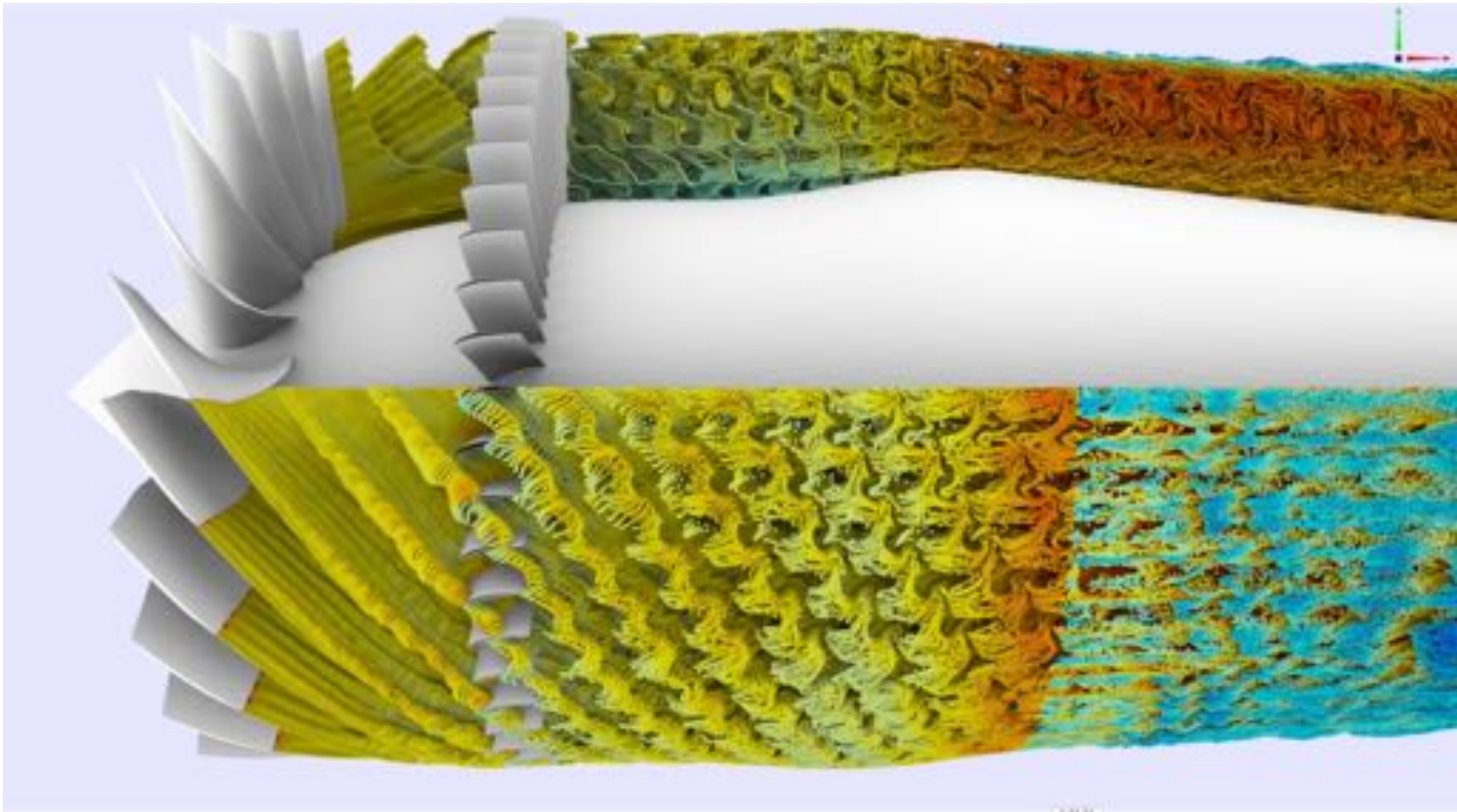

*Particle traces colored by  $U$  velocity magnitude*



# R4 Source Diagnostic Test Toward Fan Broadband Noise Prediction

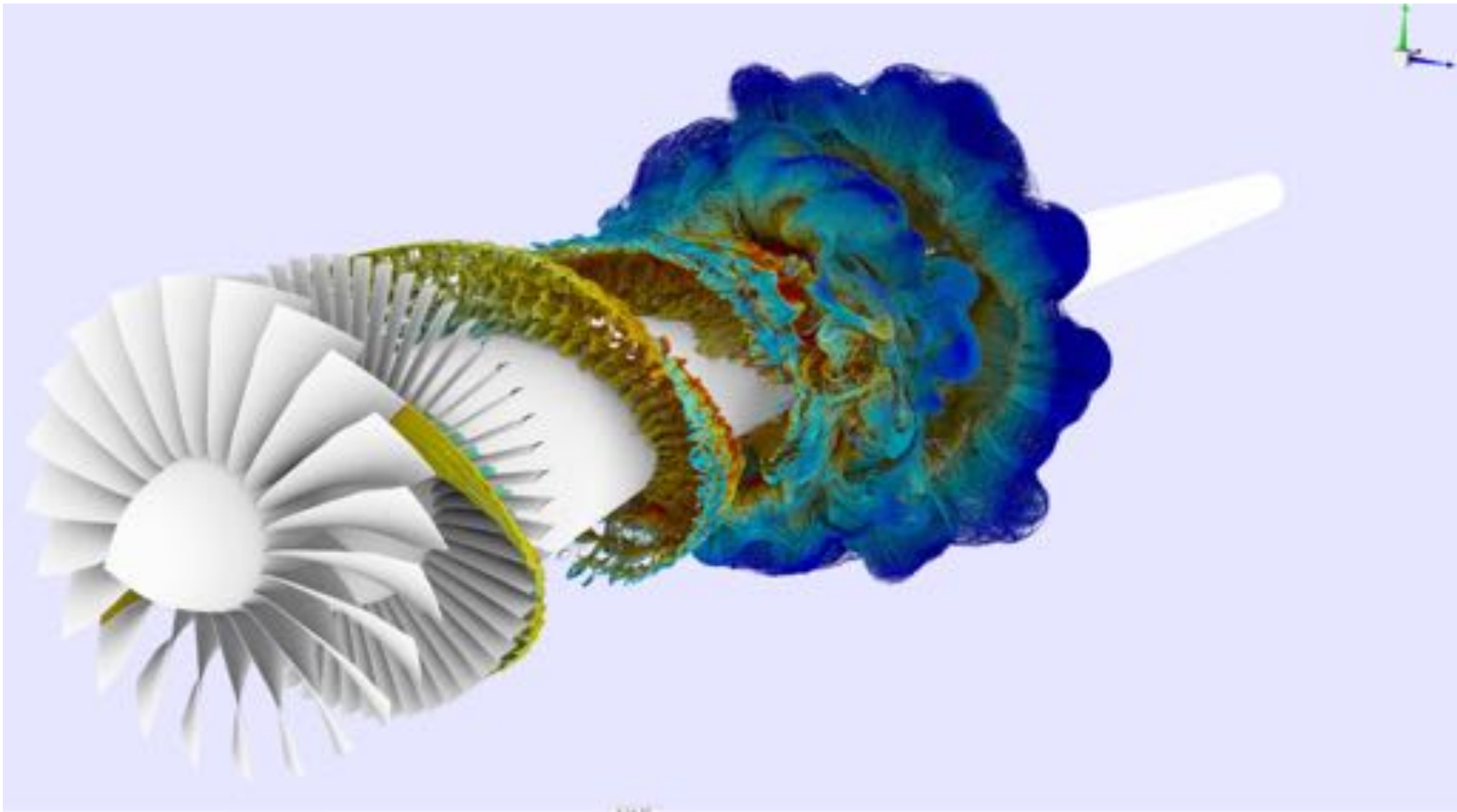

*Particle traces colored by U velocity magnitude*

# Summary



Demonstrated predictive computational aeroacoustics capabilities

- Flexibility with respect to mesh paradigms
- Advancing revolutionary approaches like Lattice-Boltzmann Method

- Jet and aircraft noise
- Rotor and Fan noise
- Orion Launch Abort System
- Launch Pad design



# Acknowledgments



- ✓ This work was partially supported by the NASA ARMD's Transformational Tools and Technologies (T<sup>3</sup>), Advanced Air Transport Technology (AATT), Commercial Supersonic Transport (CST), Revolutionary Vertical Lift Technology (RVLT), and NASA HEOMD's projects
- ✓ Computer time provided by NASA Advanced Supercomputing (NAS) facility at NASA Ames Research Center