

Electric Aircraft Cryogenic Cooling with Thermo-acoustic Exergy Management

Rodger Dyson

NASA Glenn Research Center

CEC/ICMC

Hartford, CT

July 24, 2019



Electric Aircraft Thermal Challenge

Current proposed solutions include:

- Ram air HX
 - adds weight and aircraft drag
- Convective skin cooling HX
 - adds weight, drag, and inefficient
- Dumping heat into fuel
 - limited thermal capacity
- Dumping heat into lubricating oil
 - limited thermal capacity
- Active cooling
 - adds weight and consumes engine power
- Phase change cooling
 - adds weight and limited thermal capacity
- Heat pipe, pumped multiphase, vapor compression
 - adds weight and consumes engine power

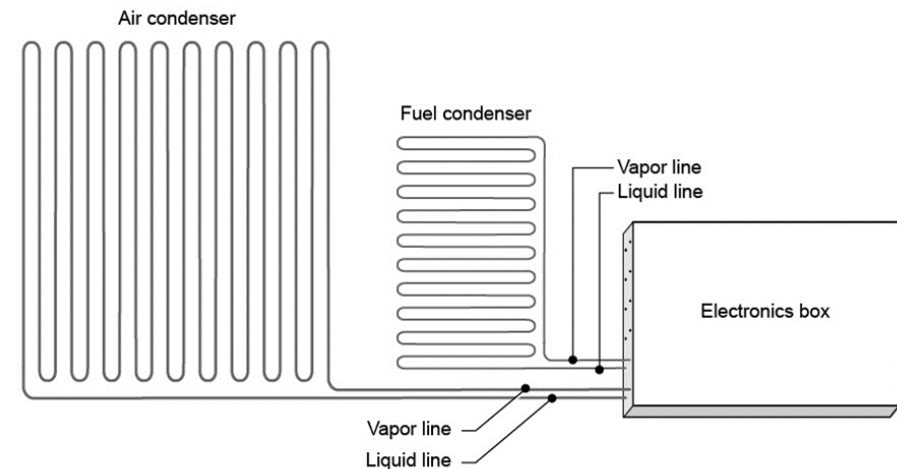
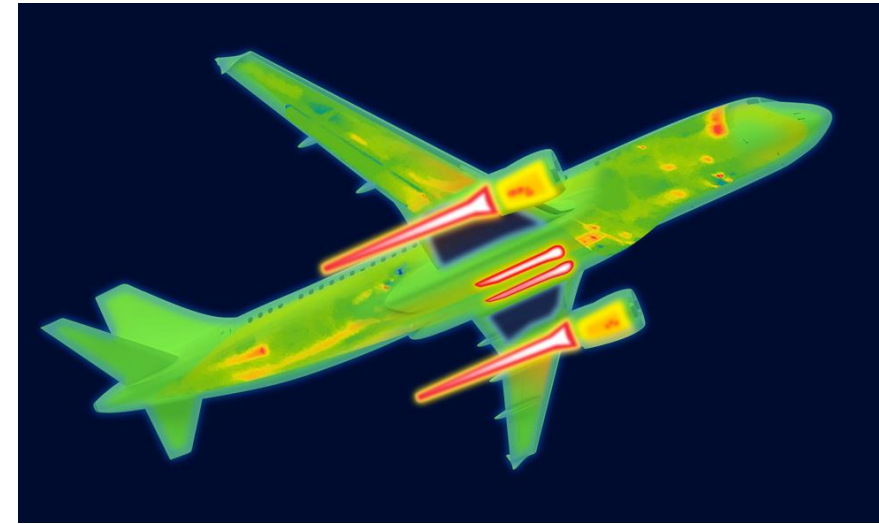

50kW to >800kW of low grade thermal heat trapped within composite aircraft body



Thermal Limits

Dumping heat into:

- Fuel (limited 50 kW),
- outer mold line (limited 300 kW),
- ram air (see below for losses),
- by-pass air (see below for losses),

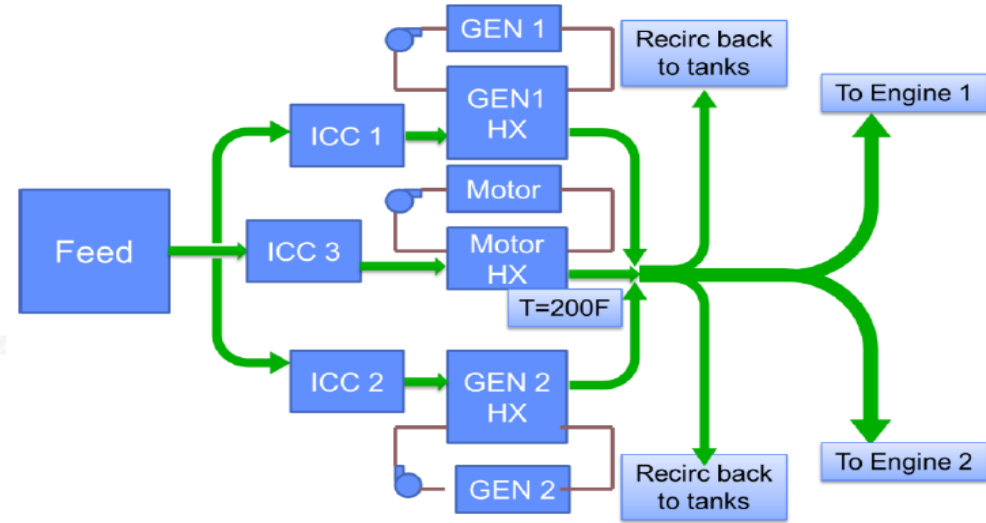
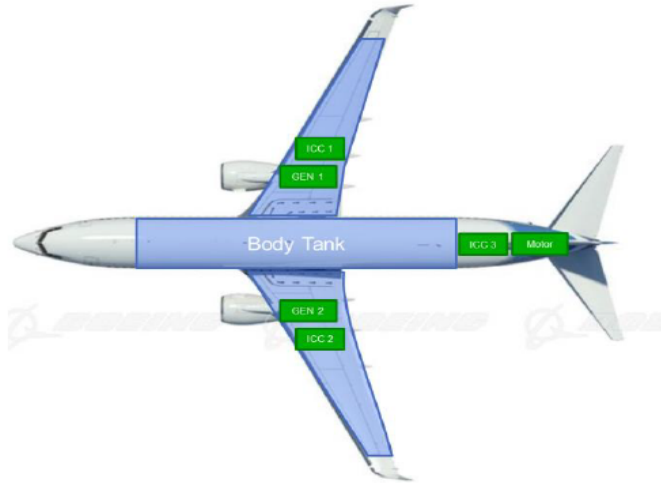

	1% Hot Day		Standard Day	
	Total Penalty (zero exit Velocity)	Total Penalty (non-zero exit velocity)	Total Penalty (zero exit Velocity)	Total Penalty (non-zero exit velocity)
900NM	4.98%	3.31%	2.76%	2.36%
3500NM	5.00%	3.62%	3.01%	2.57%

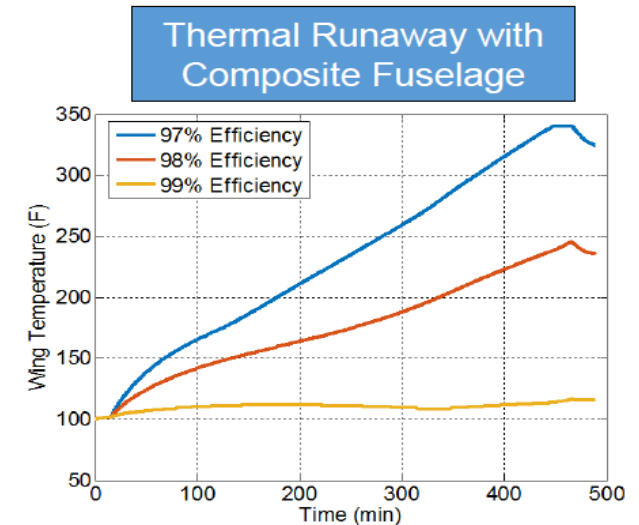

Electric Aircraft Propulsion Thermal management technology impacts performance and safety certification

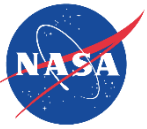

Power, Propulsion, Thermal, Airframe Integration

- Prefer technology that:
 - improves fuel efficiency,
 - reduces emissions,
 - removes heat from:
 - small core engines, more electric composite aircraft, and high power electric propulsion systems
 - reduces vehicle mass
 - reduces thermal signature for military

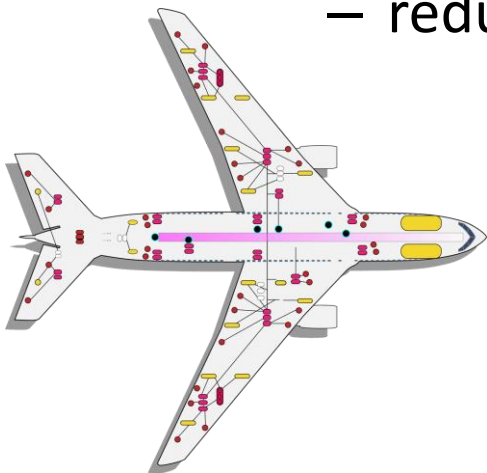

Low Grade Waste Heat Produced Throughout Insulated Aircraft

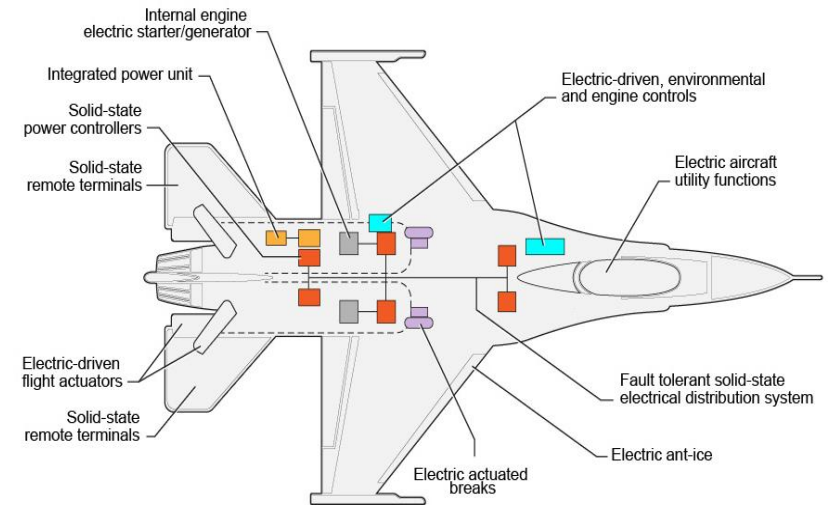
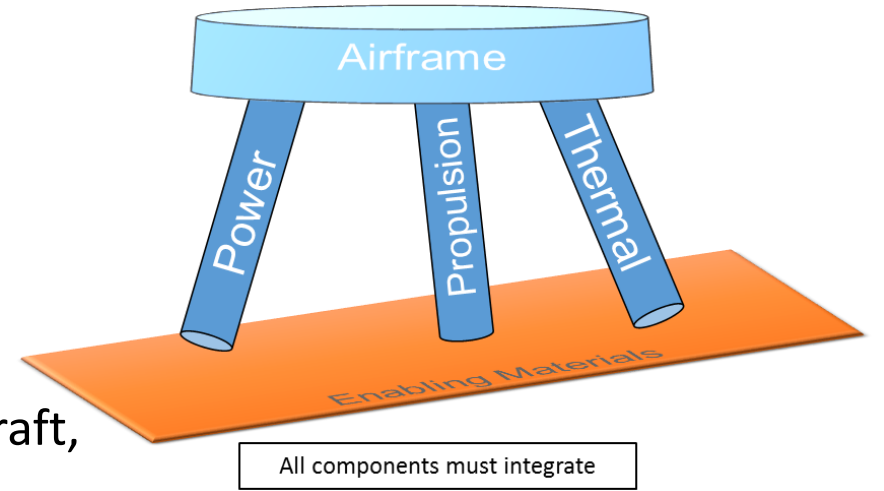



IDEA: Aero-Vascular Energy Management with Acoustic and Vapor Energy Transport

Thermal management: Human vs. Aircraft

<u>Human</u>	<u>Aircraft</u>
Heart	Turbofan
Artery	Acoustic Pipe
Vein	Heat Pipe
Skin	Skin
Blood	Helium/Gas

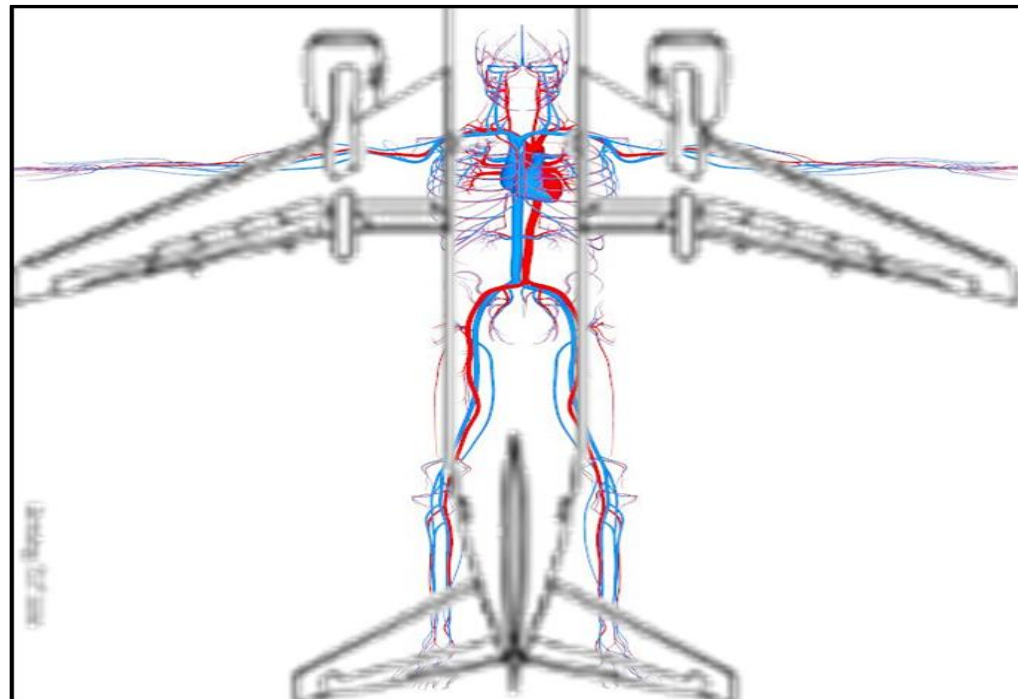

Three Key Points:

1. Recycle waste energy with heat pumping powered with core waste energy
2. Additive manufactured airframe enables sophisticated heat transport
3. Solid-state thermal control allows transporting energy with no moving parts

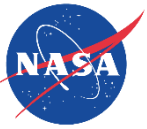

Heat Energy Extraction

- Key Point: Most thrust (>80%) produced in by-pass air of commercial aircraft
 - Turbofans have bypass ratio from 6 to 12
 - Turboprop have bypass ratio from 50 to 100
 - Hybrid electric distributed propulsion up to 100
 - Small core further increases by-pass ratio

Majority of thrust here

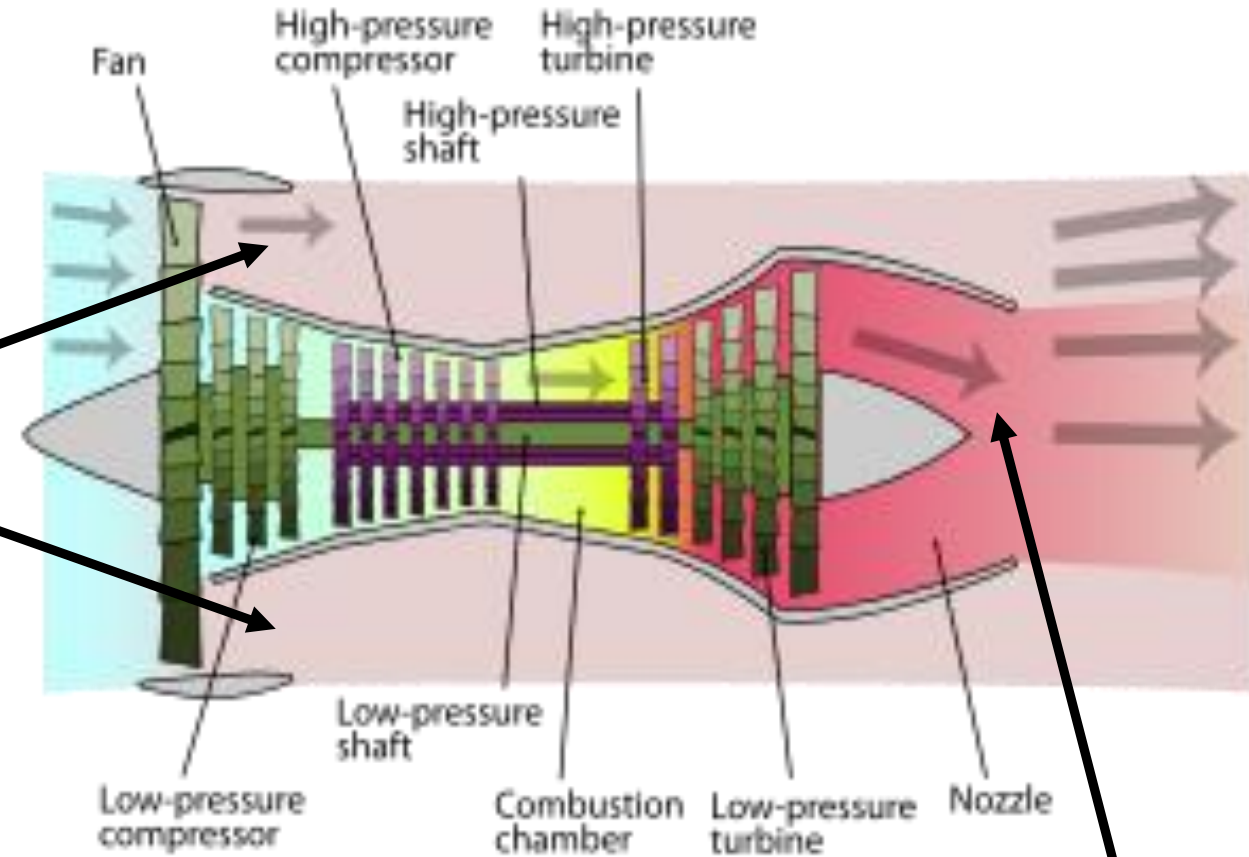

- Idea: Extract waste energy from core
 - Minimal impact on overall thrust
 - Reduce jet noise that scales as V^8
 - ~30 MW waste heat available on B737

Extract only 10%, 3 MW -> 1MW acoustic energy available

Extract heat here

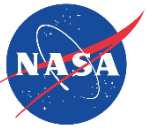

Energy Transport With Acoustic Waves

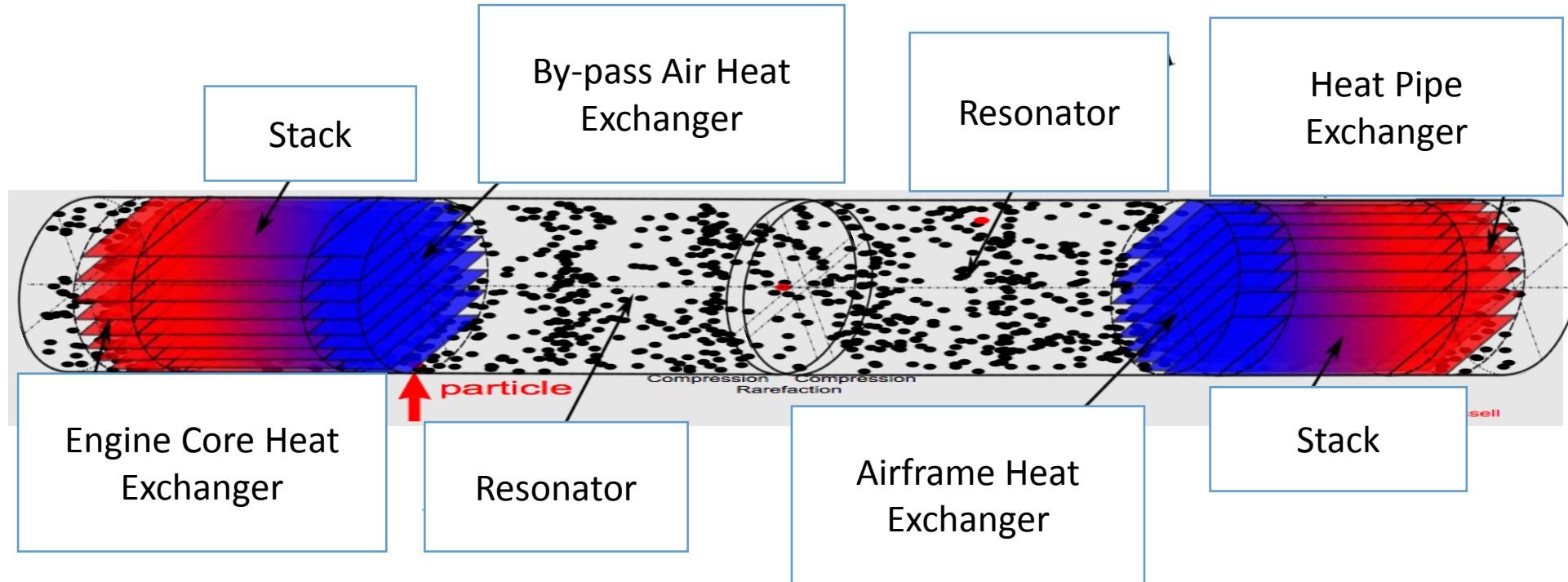

Basic principle is to use aircraft engine waste heat to produce a high intensity acoustic wave with no hot moving parts that can be used for power generation or component cooling. The temperature gradient between hot and cold HX efficiently creates the acoustic waves.

All energy is delivered through small hollow acoustic tubes.

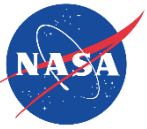

No Moving Part Acoustic Heat Pump

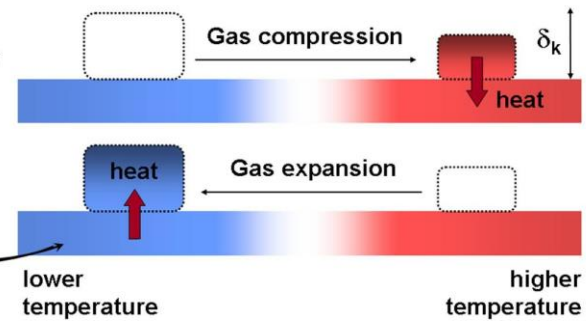
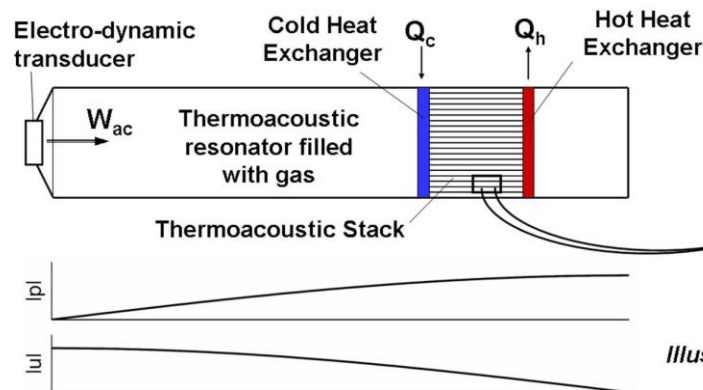
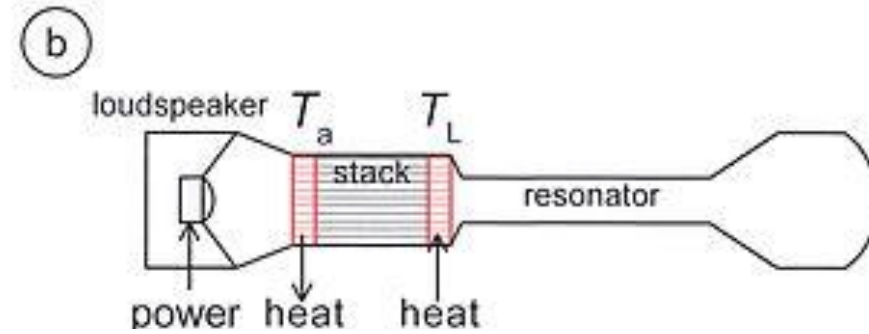
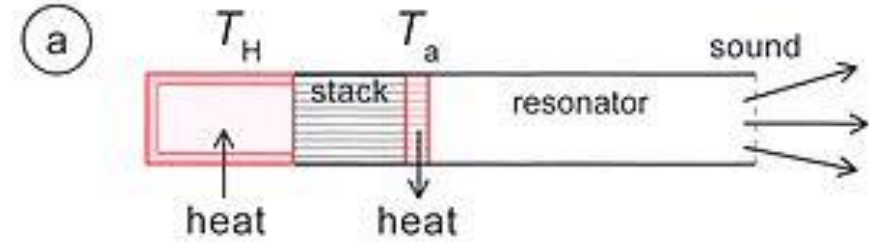
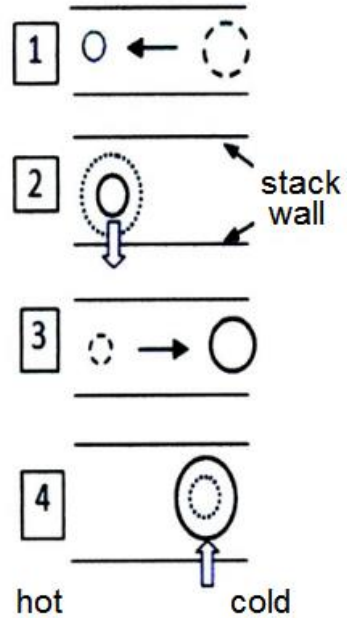
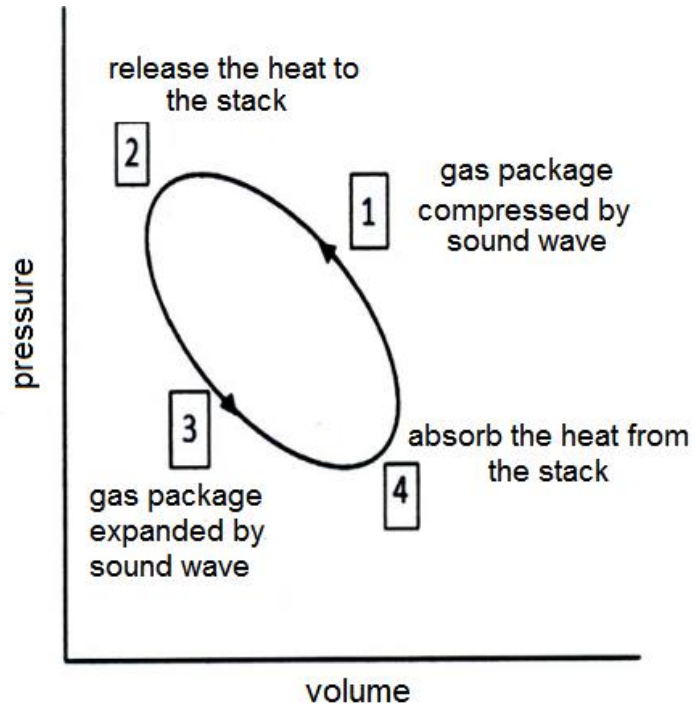

Illustration of the hydrodynamic energy transfer up the temperature gradient (heat pump, refrigerator)

Acoustic Mechanical Work Energy Moves Heat From Cold to Hot



Acoustic Heat Pump Efficiency

All aircraft waste heat is now useful high temperature heat

Free Acoustic Mechanical Work Input From Nozzle

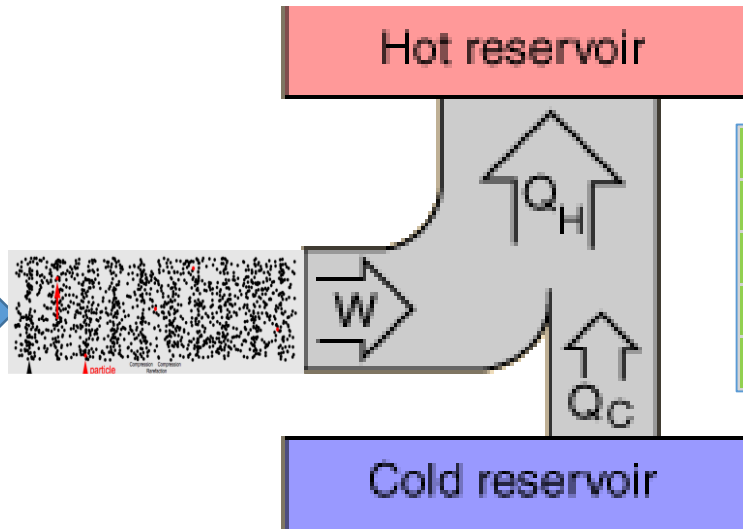

Th (K)	Tc (K)	Ratio W/Qc	Qout (W)	WorkIn (W)	Qin (W)
400	300	1:3	1000	250	750
600	300	1:1	1000	500	500
900	300	2:1	1000	666.66667	333.33333
1200	300	3:1	1000	750	250
300	50	40:1	1025	1000	25

Free Superconducting

Electric Actuators, Cabin, Cables, Power Electronics, Protection, Machines

Makes electric parts and powertrain effectively 100% efficient

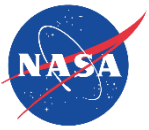

Solid-State Energy Transfer Control

Acoustic Energy Control Method



Vapor Energy Control Method

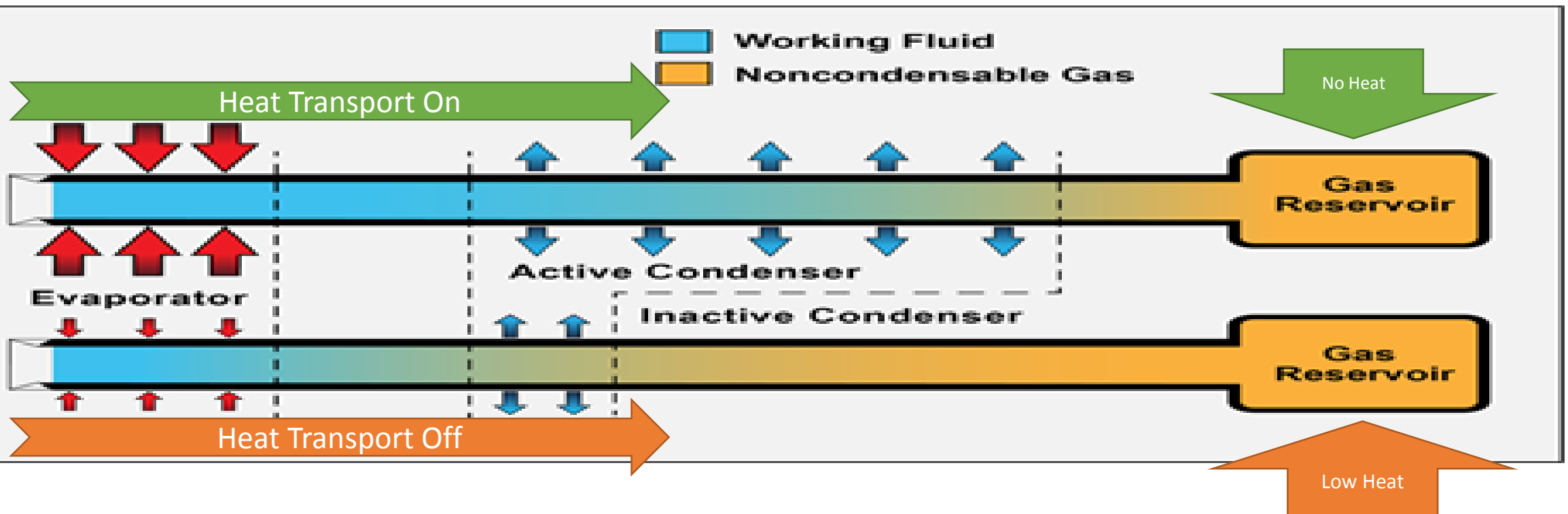



Waste Heat Re-Use Options

Solid-state (no moving part) energy recycle and distribution

- localized skin heating
 - for active lift/drag management,
- de-icing/anti-icing,
- powertrain cooling,
- cabin thermal management,
- engine recuperation,
- thrust enhancement with by-pass air
- military cloaking with thermal skin temperature shifting or nozzle rejection

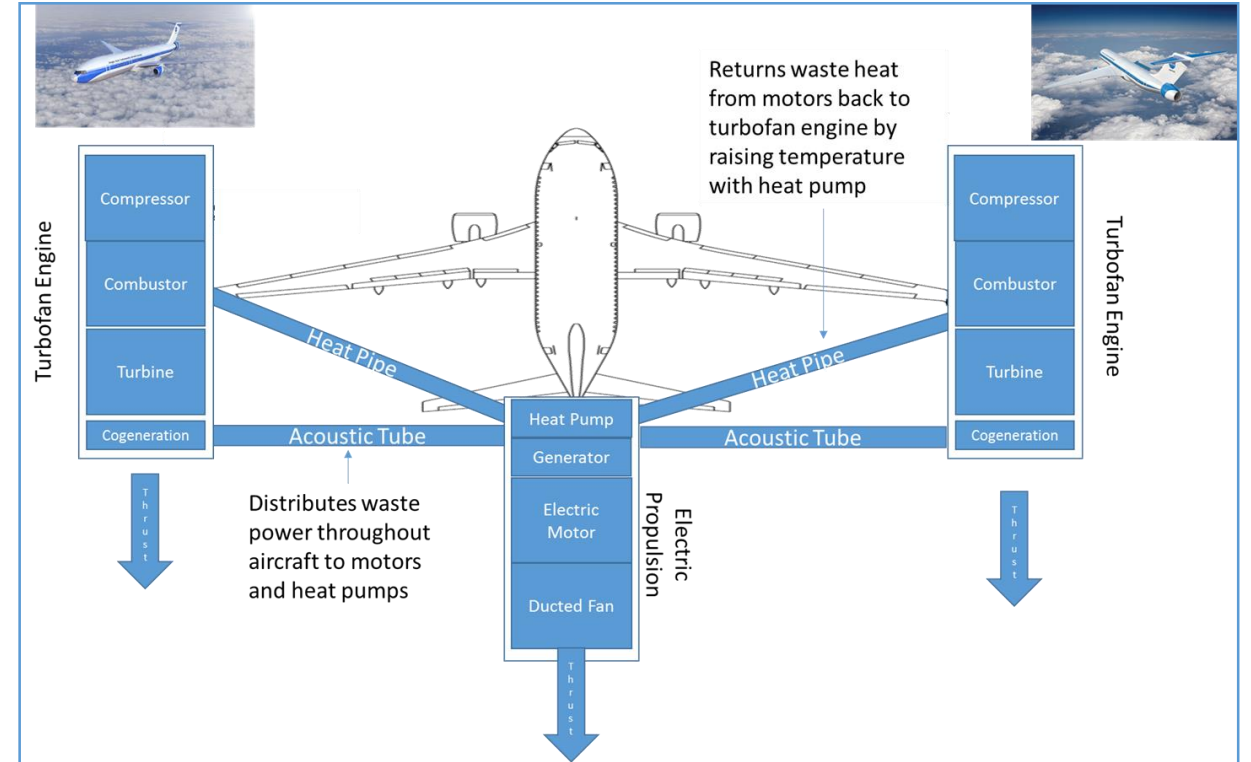

Simple solid-state heat distribution and recycling



Installation Example

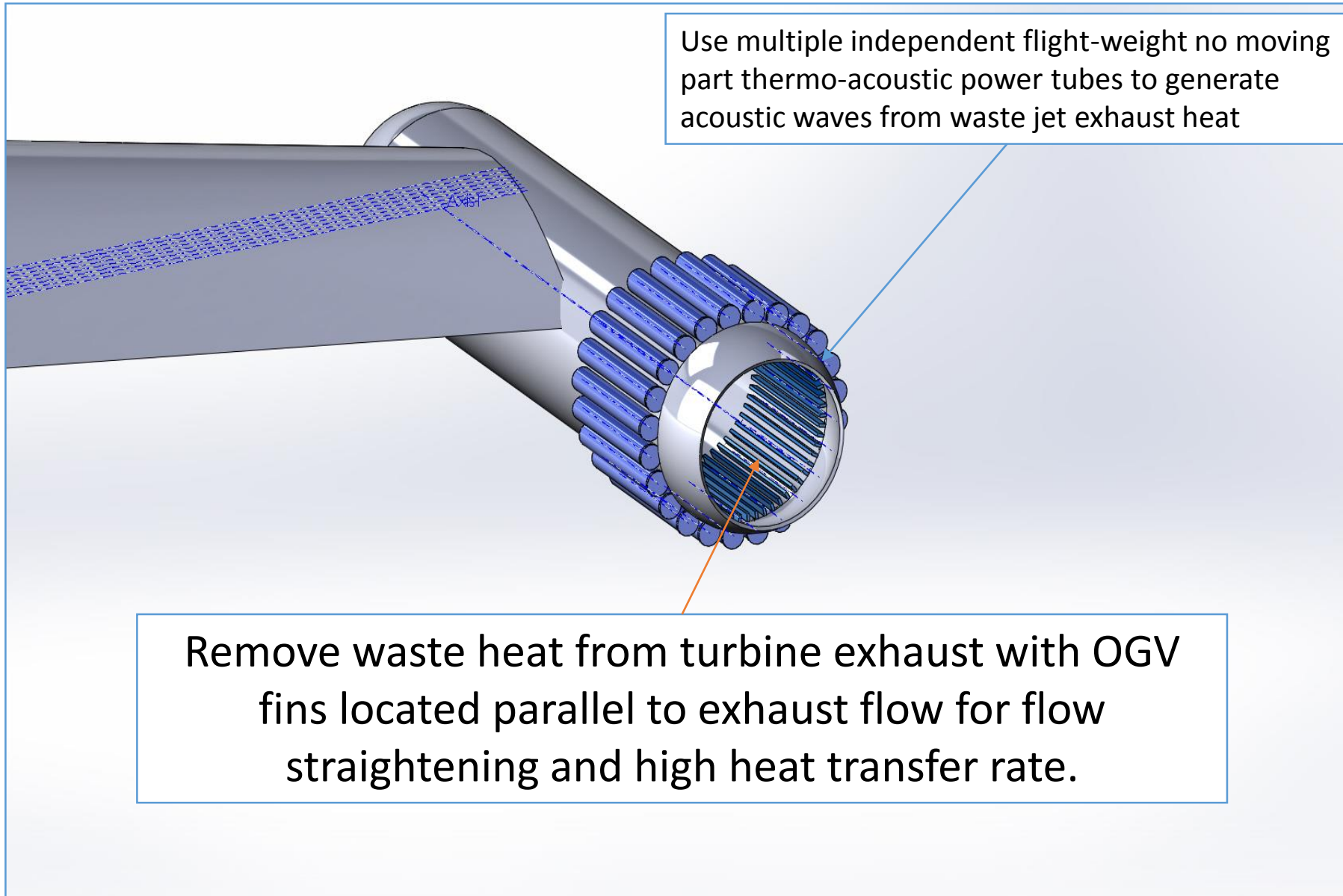

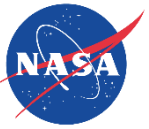

Structural Pressurized Acoustic Tubes

Light-weight gaseous pressurized helium filled tube delivers energy from turbine to anywhere on aircraft and provides flight-weight structural support.

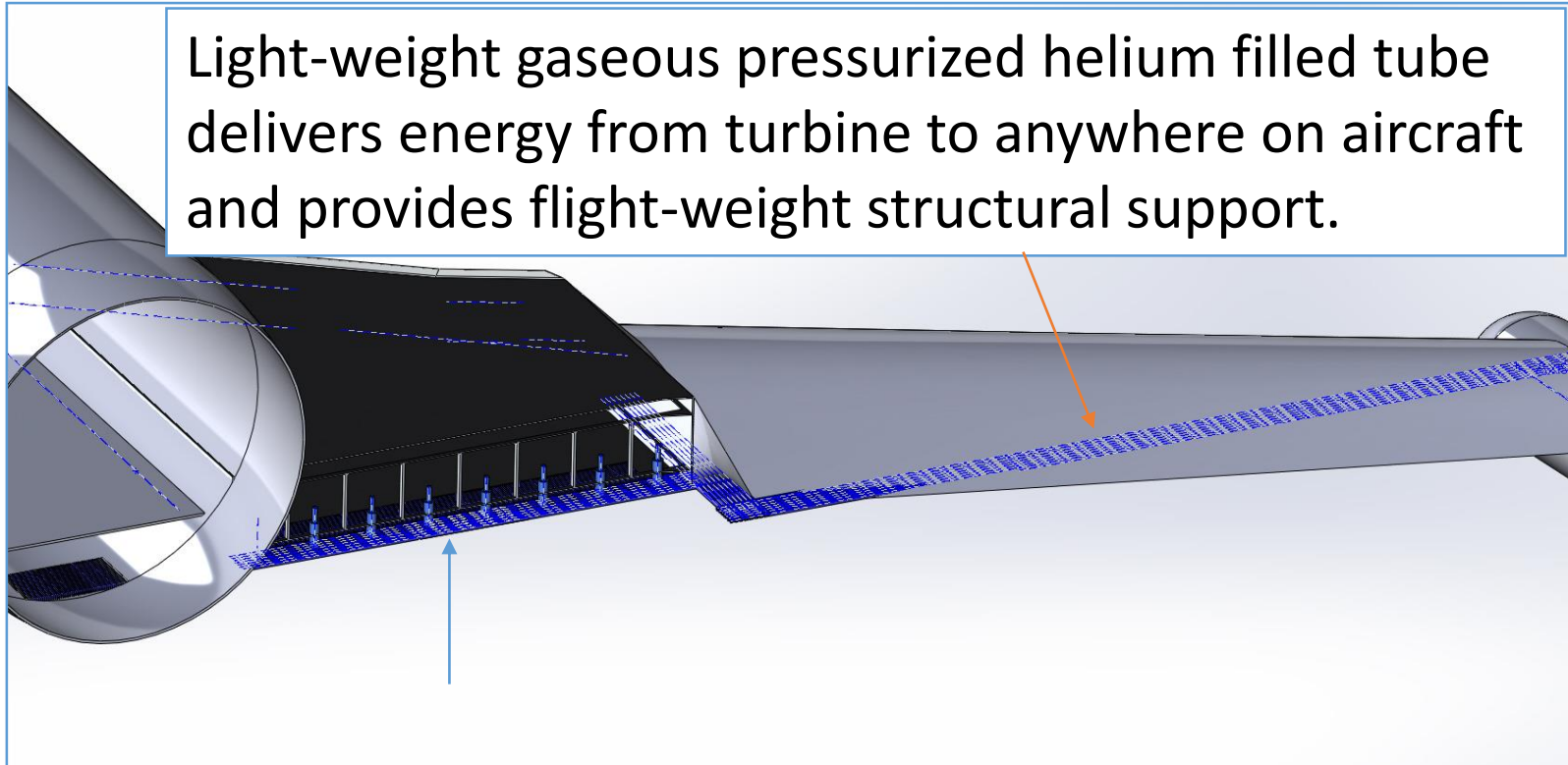

Acoustic heat pumps can provide cooling using the delivered acoustic energy.

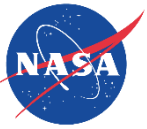

Net System Cycle Benefit Range (1.6% - 16%)

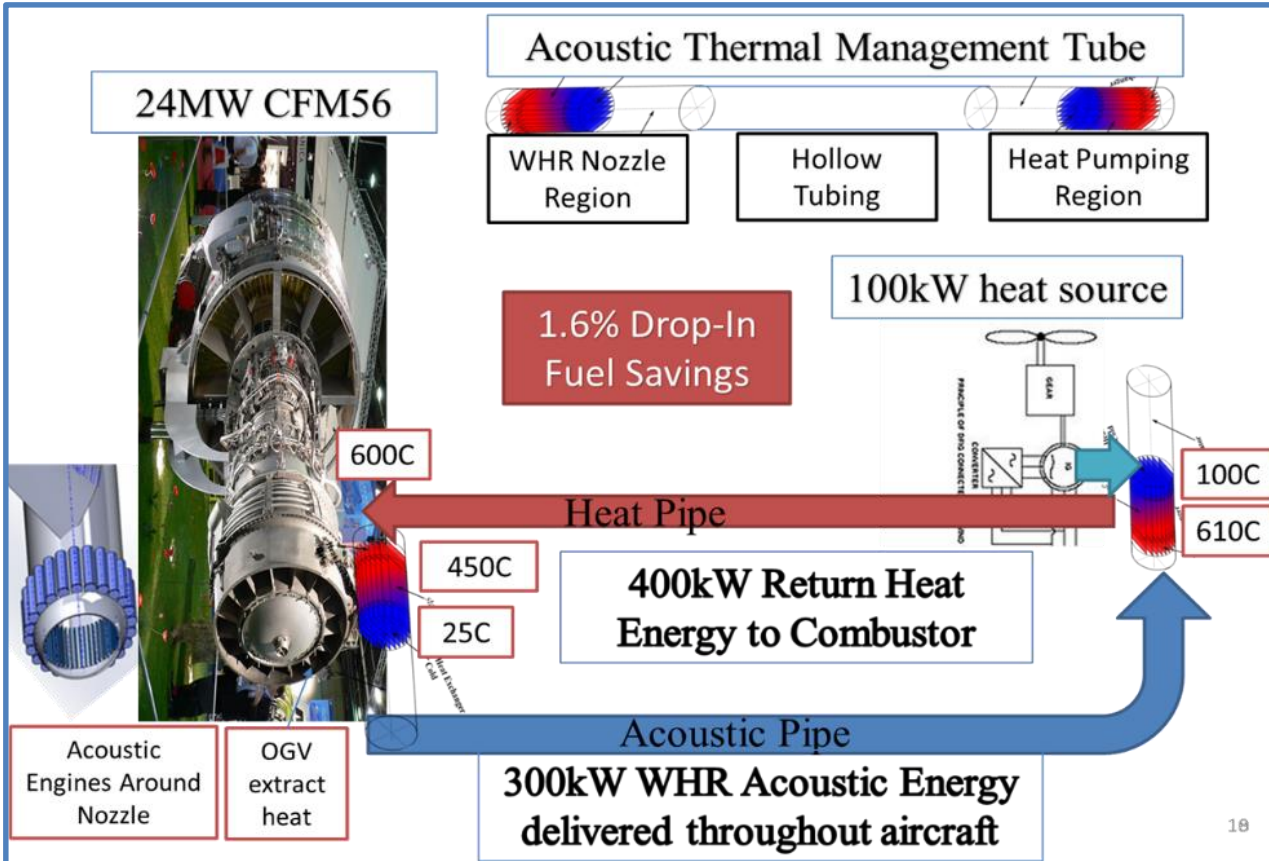

Example idealized net benefit calculation (16% fuel savings):

- 24MW thrust for Boeing 737 using a pair of CFM56 engines operating at 50% efficiency produce ~12MW of waste heat at 450C out the nozzle with 25C by-pass fan air surrounding it
 - **52%** of Carnot Efficiency for WHR, approximately 4MW of mechanical acoustic energy available
 - 1MW of low-grade 100C distributed heat sources throughout the insulated composite aircraft requires ~3MW of mechanical input to raise to 600C
 - **44%** of Carnot Efficiency for heat pump, heat pipes return the 600C 4MW of energy to combustor
- Best case idealized scenario achieves fuel savings of 16% while providing a flight-weight method for managing the aircraft's heat sources without adding aircraft drag and weight. All heat is used in the most optimal way and ultimately rejected out the nozzle instead of through the aircraft body.

Drop-in Solution with Conservative Assumptions (1.6% fuel savings):

Note that the outlet guide vanes as currently installed in the CFM56 could act as WHR fins extracting about 10% of the nozzle waste heat so that 100kW of low-grade distributed 100C aircraft heat sources could be returned to the combustor as 400kW, 600C useful heat resulting in a potential fuel savings of 1.6%.

This changes aircraft thermal management from being a burden on aircraft performance to an asset.

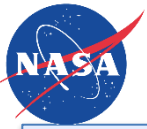

Conclusion

TREES changes aircraft thermal management from being a necessary burden on aircraft performance to a desirable asset. It improves the engine performance by recycling waste heat and ultimately rejecting all collected aircraft heat out through the engine nozzle.

- **Key Features Include:**

- **Turbofan and/or fuel cell waste heat is used to generate ducted acoustic waves that then drive distributed acoustic heat pumps and/or generate power throughout the aircraft.**
- **Low grade powertrain waste heat is converted into high grade recycled heat and returned to the engine combustor via heat pipes or additional acoustic tubes**
- **Pressurized acoustic and heat pipe tubes can be directly integrated into the airframe to provide structure support with mass reduction.**
- **Fuel savings of 16% are estimated with a purpose-built system**
- **All aircraft heat is rejected through engine nozzle, by-pass stream, outer mold line de-ice**
- **Non-provisional Patent Filed With Priority Date November 6, 2015.**

Appendix: Basic Theory

Example Wave Generation, Acoustic Tube, and Heat Pump as One Unit

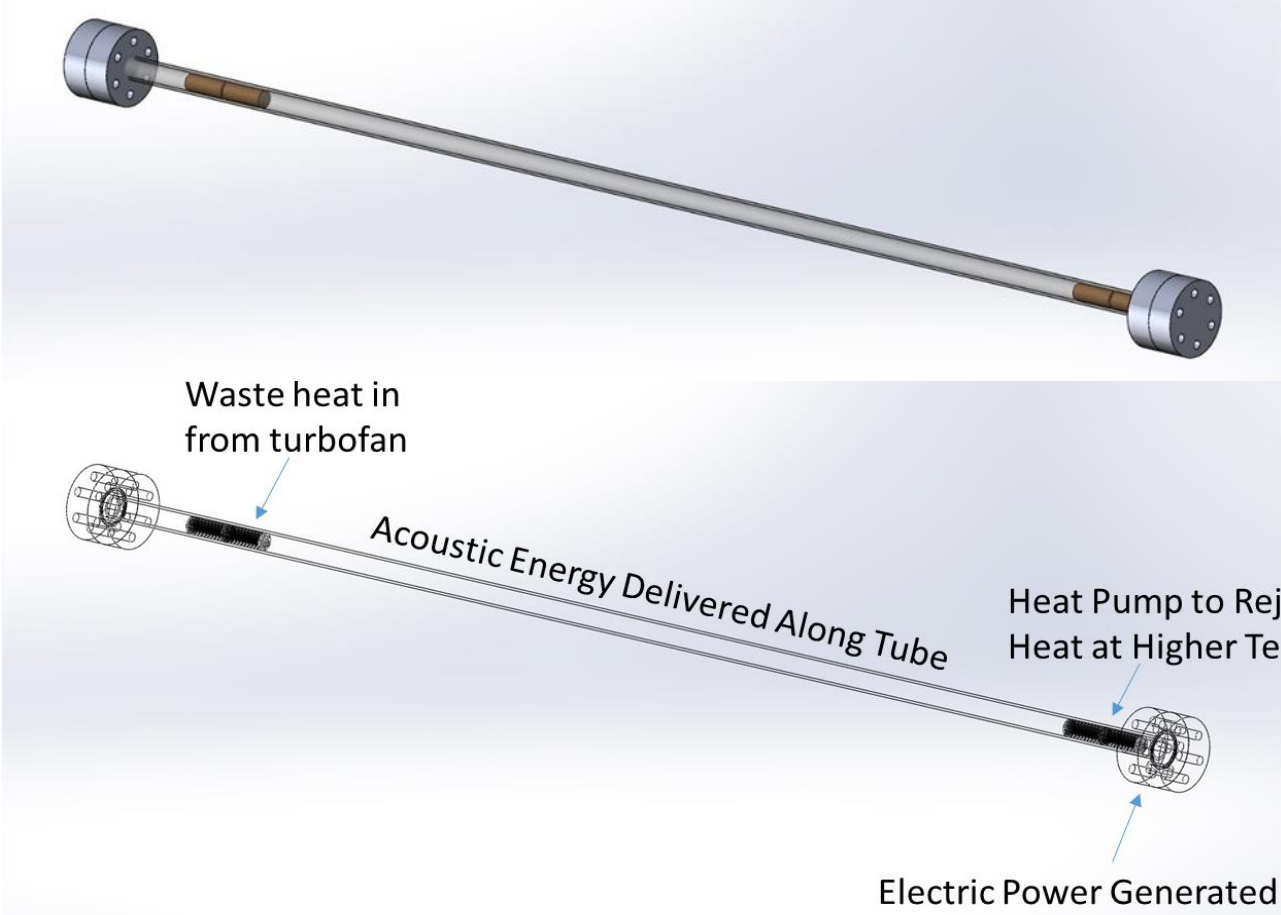

Note the power generation, distribution, and heat pump tube can be any length and curved to fit within aircraft. Electric power or cooling can be delivered anywhere in the aircraft without power conductors.

Thermodynamic Cycle

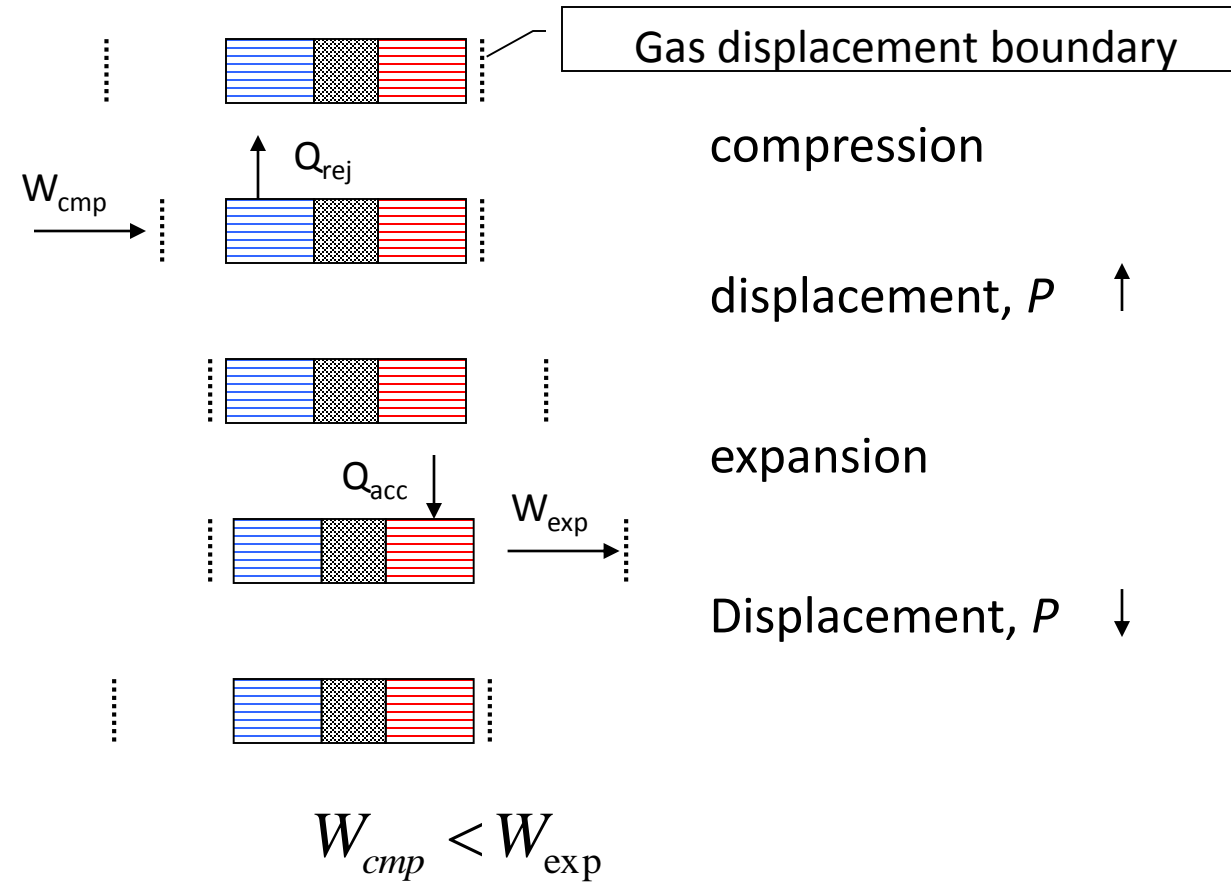

Two stage cascade

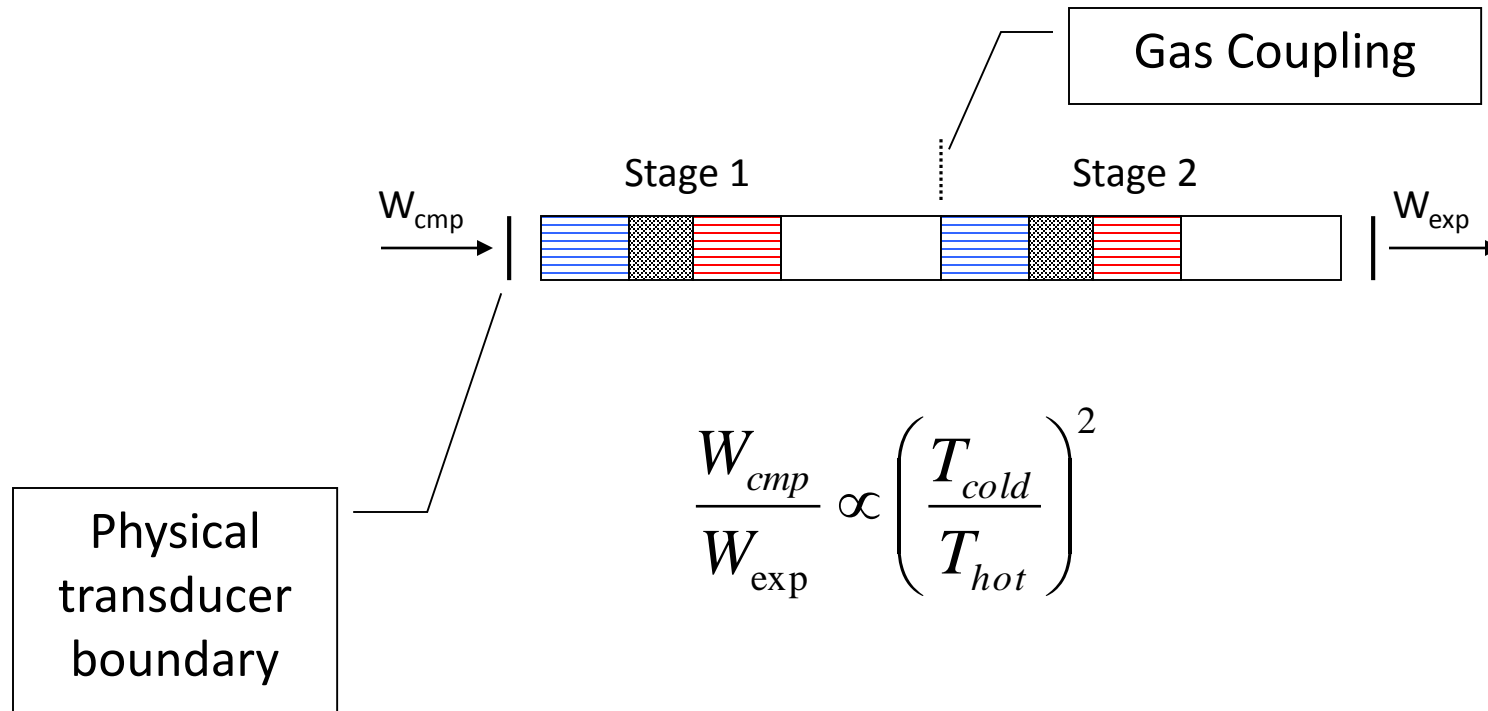

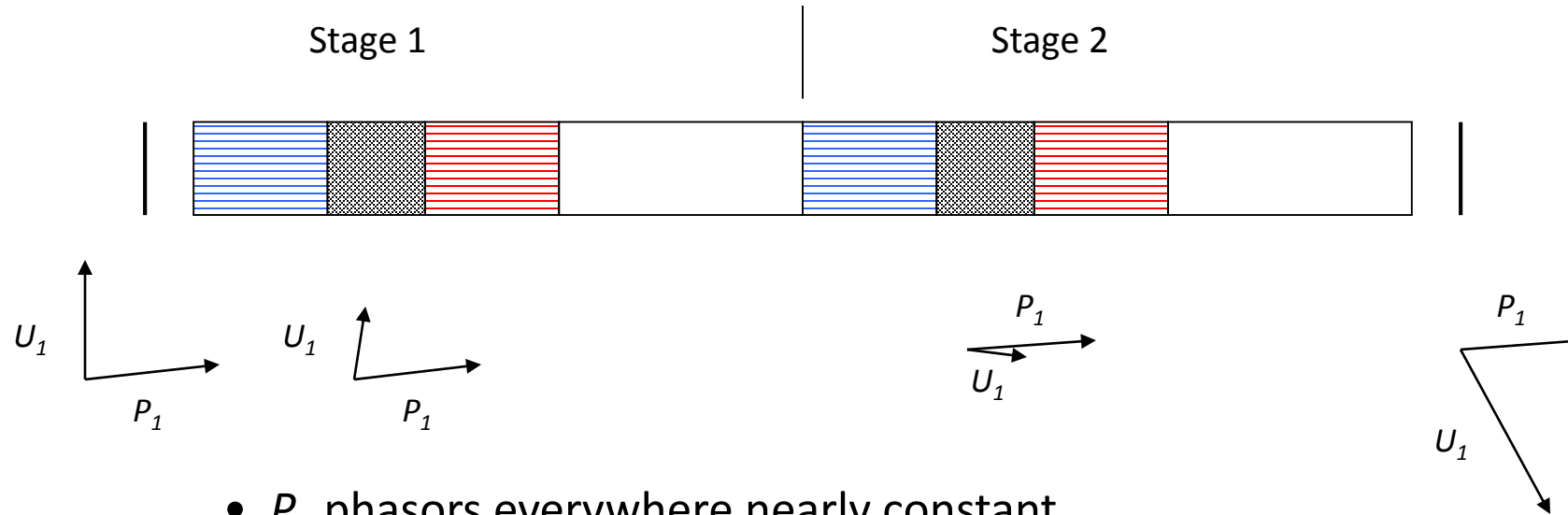

- P_1 phasors everywhere nearly constant
- U_1 phasors progressively lag due to volume (compliance)
- Ideally, P_1 and U_1 in phase in regenerators
- Gas inertia (inertance) can be used to counter U_1 lag
- E.g. Swift inter-stage inertance tube (see reference 4)

End Transducer Options

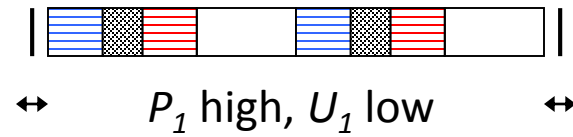

High Impedance
(Piezo or magnetostrictive)

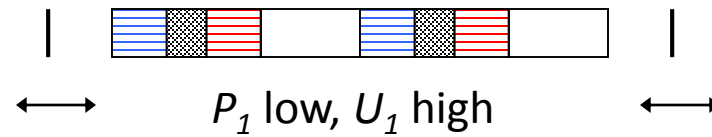

Low Impedance
(Moving Magnet actuator)

Impedance is P_1 / U_1

High Impedance Matching

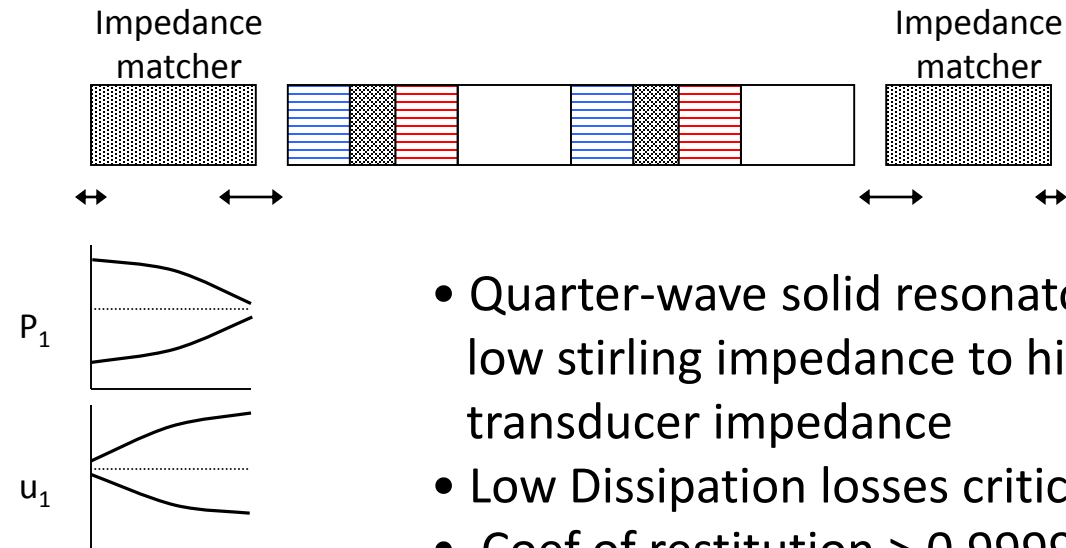

- Quarter-wave solid resonator converts low stirling impedance to high transducer impedance
- Low Dissipation losses critical
- Coef of restitution > 0.9999
- Three-dimensional effects?
- Piezo transducers prefer higher frequency than stirling thermodynamics allows

Electro-acoustic transducer (size & weight versus capacity)?

- Not required since can use standing wave driver (see Swift ref. 1)

Key Point is the type and size of driver can be very small because of thermo-acoustic amplification from multiple stages in series. Next series of slides explains this.

And note that TREES uses a traveling wave without the loop shown in F1. b) by using an RC Helmholtz terminator.

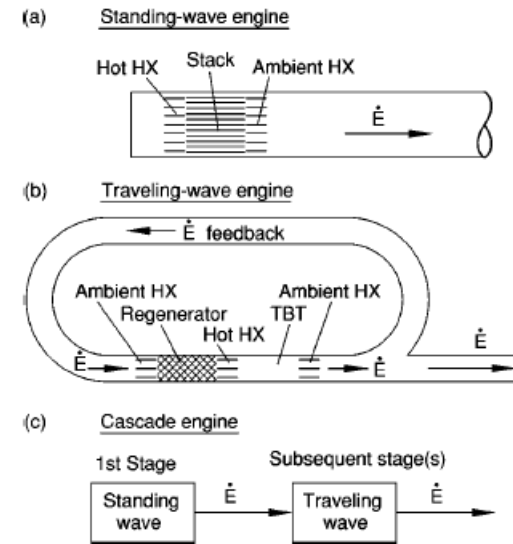

FIG. 1. Some thermoacoustic engine topologies. HX=heat exchanger, TBT=thermal buffer tube, \dot{E} =acoustic power. (a) In a standing-wave engine, the temperature difference between the hot heat exchanger and the ambient heat exchanger falls across the stack, whose pore dimensions are of the order of a few thermal penetration depths. Here, the standing-wave engine is in a simple cylindrical resonator, closed at its hot end and delivering acoustic power through its ambient end. (b) In a traveling-wave engine, the temperature difference between the hot heat exchanger and the ambient heat exchanger falls across the regenerator, whose pore dimensions are much smaller than a thermal penetration depth. Acoustic power can only be produced if some is fed into the ambient end of the regenerator, such as through the acoustic feedback path shown here. (c) The cascade engine combines one standing-wave engine with one or more traveling-wave engines. The standing-wave engine supplies the acoustic power needed at the ambient end of the adjacent traveling-wave engine.

References

1. Swift. JASA, 114(4), 2003 – Fig. 1c
2. Kim, IECEC 2006-4199
3. Timmer, JASA, 143, 841, 2018
4. Swift, LA-UR 11, 2011
5. Al-Khalil, J. Propulsion, 89-0759
6. Gelder, NACA TN 2866, 1953