



# An Analysis of the Strayton Engine, a Brayton and Stirling Cycle Recuperating Engine

Jeffryes W. Chapman

Donald L. Simon

Ezra O. McNichols

NASA Glenn Research Center

*AIAA Propulsion and Energy Forum,  
Indianapolis, IN  
Aug 19-22, 2019*



# Introduction

- **What is the Strayton Engine?**
  - A hybrid Brayton cycle / Stirling cycle engine concept
  - Concept developed by Rodger Dyson of NASA Glenn Research Center
- **Why investigate the Strayton?**
  - Benefits in efficiency and specific power may be realized by utilizing the synergies between the two cycles.
- **Task :**
  - Two week micro seeding was funded to investigate the Strayton cycle advantages and identify key technologies and challenges

The purpose of this paper is to disseminate task findings

# Thermodynamic Brayton Cycle

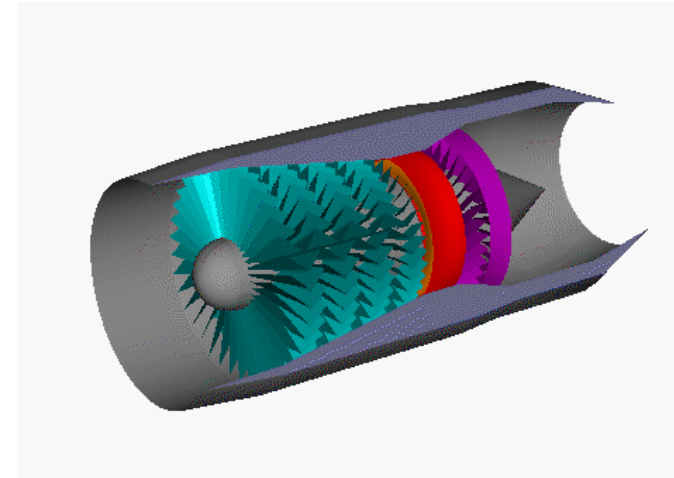
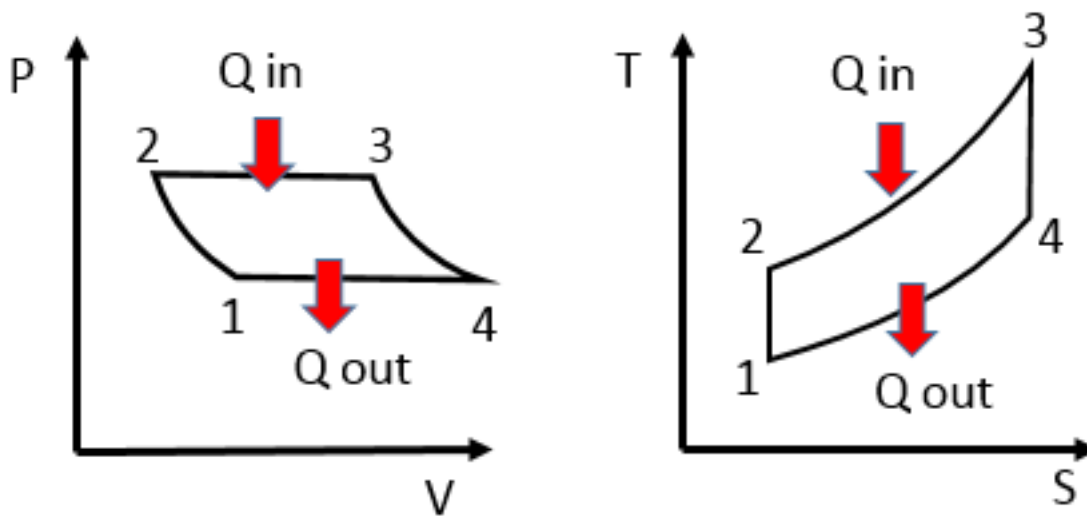

<https://www.grc.nasa.gov/www/k-12/airplane/Animation/turbpar/Images/engslo.gif>

- (1-2) : Isentropic compression on a gas
- (2-3) : Heat is added to the system, with no loss in pressure
- (3-4) : Isentropic decompression occurs where energy can be taken from the system as work
- (4-1) : Waste heat is rejected

# Thermodynamic Stirling Cycle

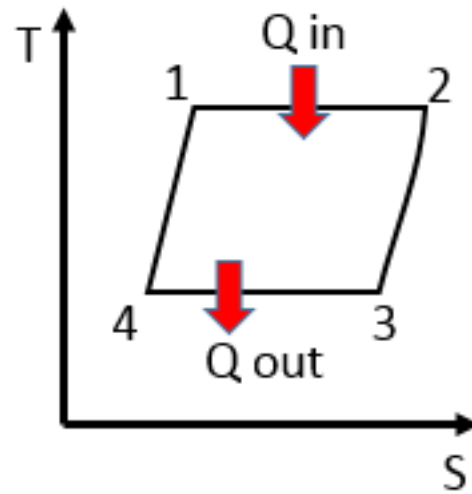
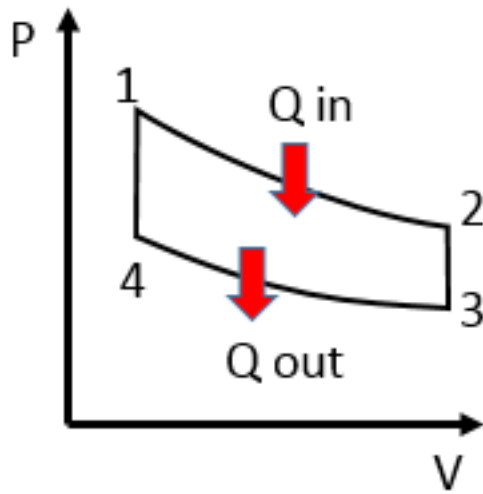

- (1-2) : Isothermal volume expansion making use of an external heat source
- (2-3) : Constant volume heat transfer heating up the regenerator
- (3-4) : Isothermal compression with waste heat rejected to an external cold source
- (4-1) : Constant volume heat transfer occurs to cool the regenerator.

# Strayton Engine

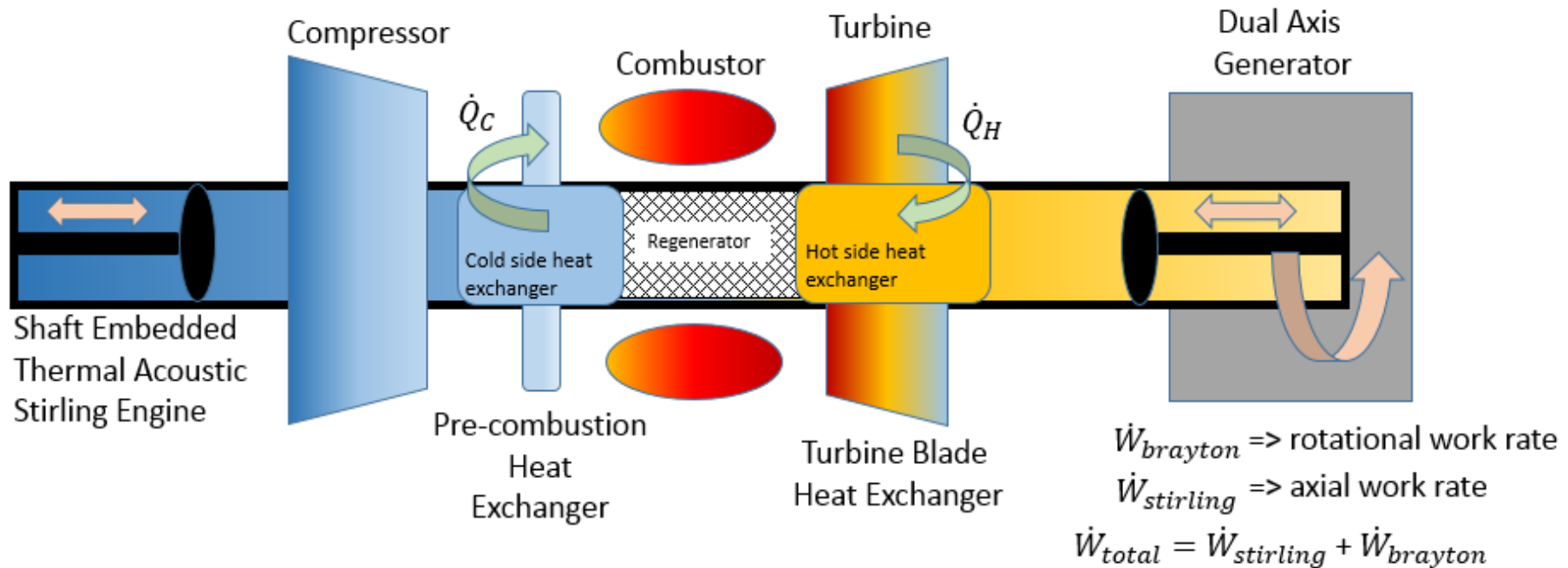

- Single shaft turboshaft with stirling engine embedded within the shaft
  - Thermal acoustic Stirling engine
  - Energy moves from the Brayton cycle gas path into the Stirling through turbine blade heat transfer
  - Stirling waste heat is reintroduced to the Brayton cycle before the combustor
  - Work is gathered from a dual-axis generator (rotational work from the Brayton engine and axial work from the Stirling engine)



# Simulating the Strayton Cycle

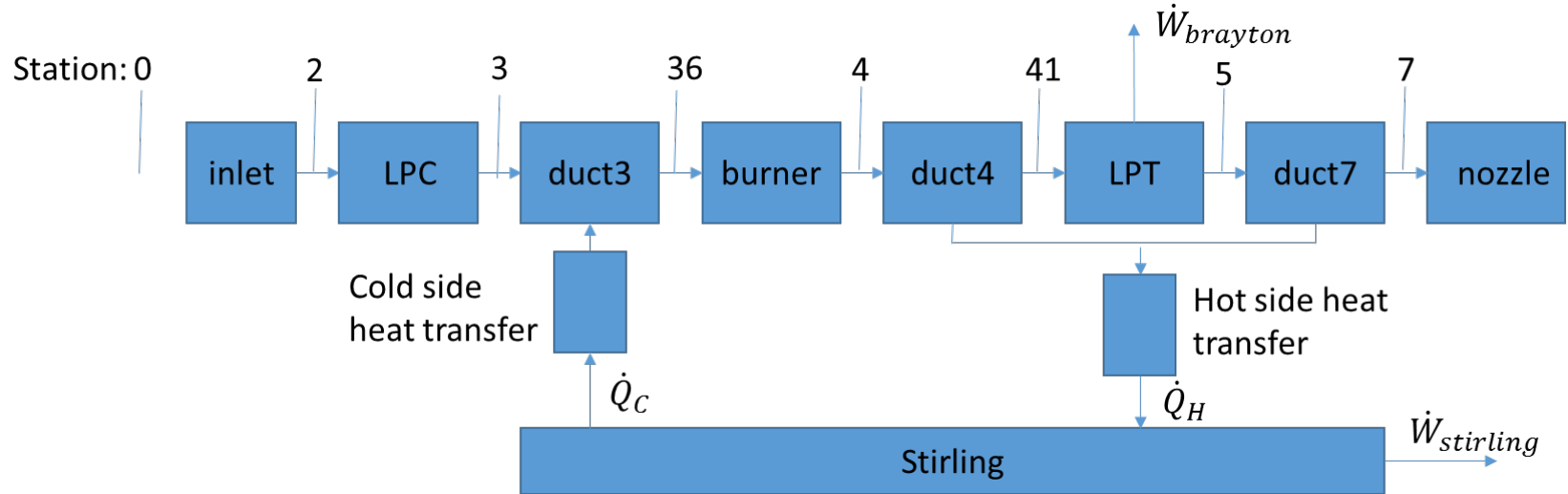

- Simulation created within the numerical propulsion system (NPSS)
  - NPSS native turbomachinery elements used for Brayton cycle engine components
  - Stirling cycle engine assumed to be a heat engine with an efficiency of 50% Carnot

$$\text{Carnot Efficiency} = 1 - \frac{T_C}{T_H}$$

- Interaction between two components managed through power movement into or out of the NPSS duct component

# Thermal circuit modeling

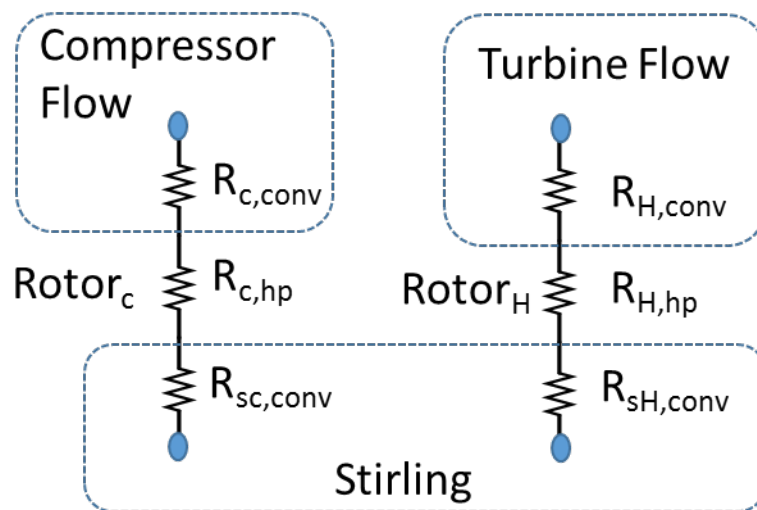

- **Thermal modeled as:**

- Brayton hot side heat transfer through turbine blades
  - Modeled as convection over flat plates
- Heat was transferred to and from Brayton and Stirling engines using oscillating heat pipes (OHP)
  - Modeled using an assumed heat transfer coefficient
- Stirling hot and cold side heat transfer
- Brayton cold side heat transfer applied into stage 3
  - Modeled as a heat exchanger with constant effectiveness

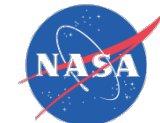

# Effect of Brayton cycle engine design criteria

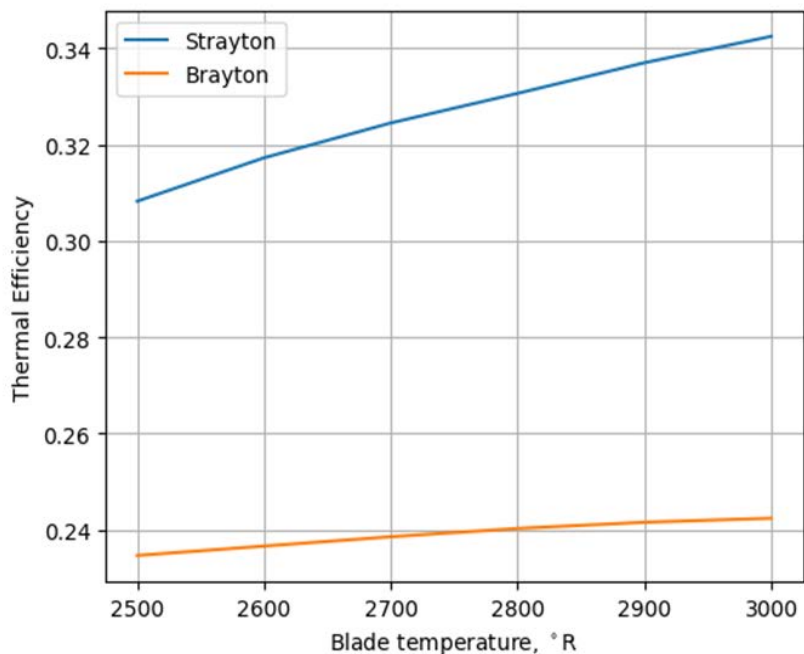

- **Designed turbine blade temperature limit**
  - Thermal efficiency rises as temperature increases
  - Strayton benefits larger than Brayton only benefits due to system synergies

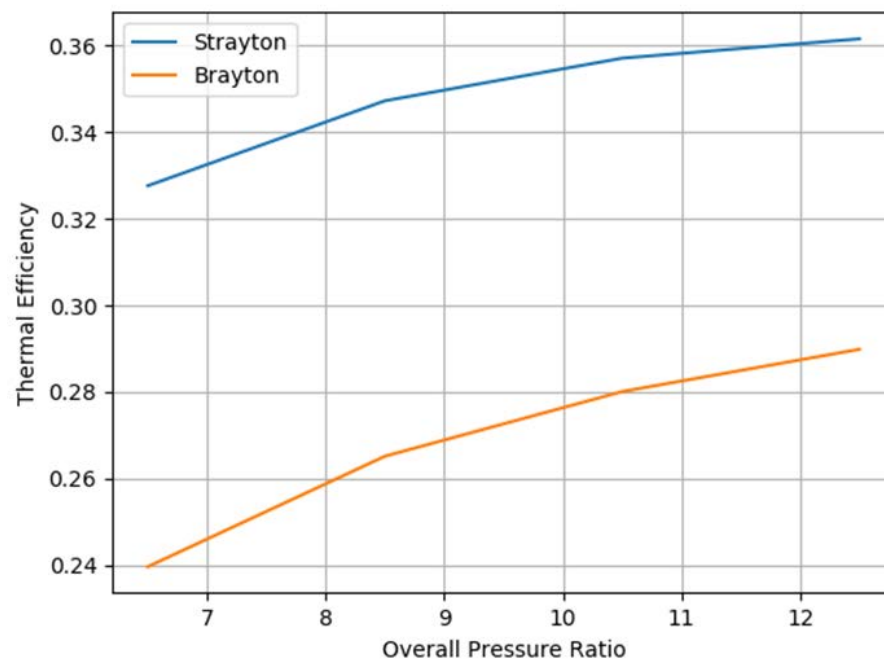

- **Overall Pressure ratio**
  - Thermal efficiency rises as temperature increases
  - Brayton cycle benefits greater than Strayton due to increases in  $T_3$  which reduce the Stirling temperature ratio.



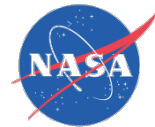

# Effect of Stirling design power

- Stirling power fraction :

- Increases in power fraction achieved by increasing power flow through the hot section, but only up to a point.
- Inflection occurs when the drop in Stirling efficiency, due to a reduction in Stirling temperature ratio, begins to outweigh the effects of power flow increase
- Overall Strayton efficiency drops as the Strayton power ratio continues to reduce

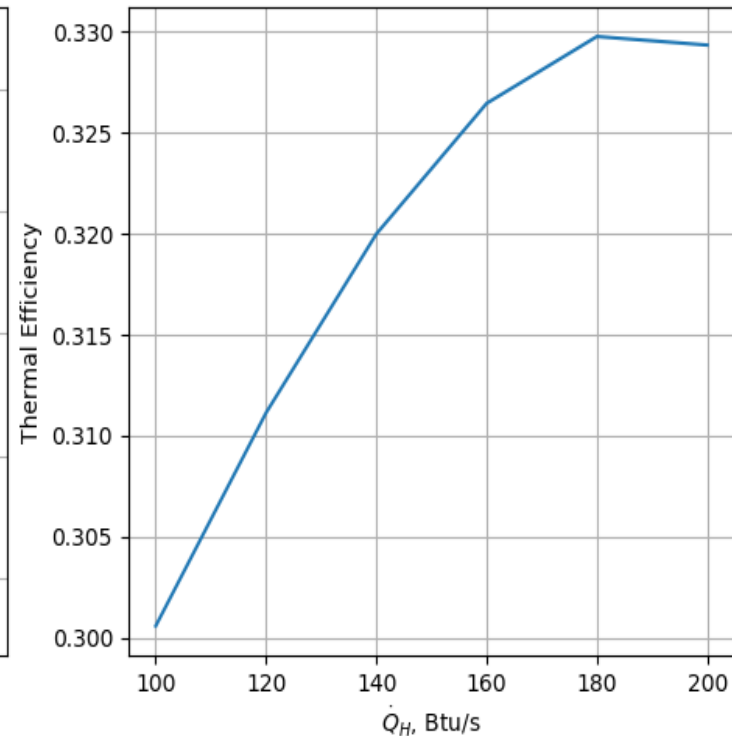
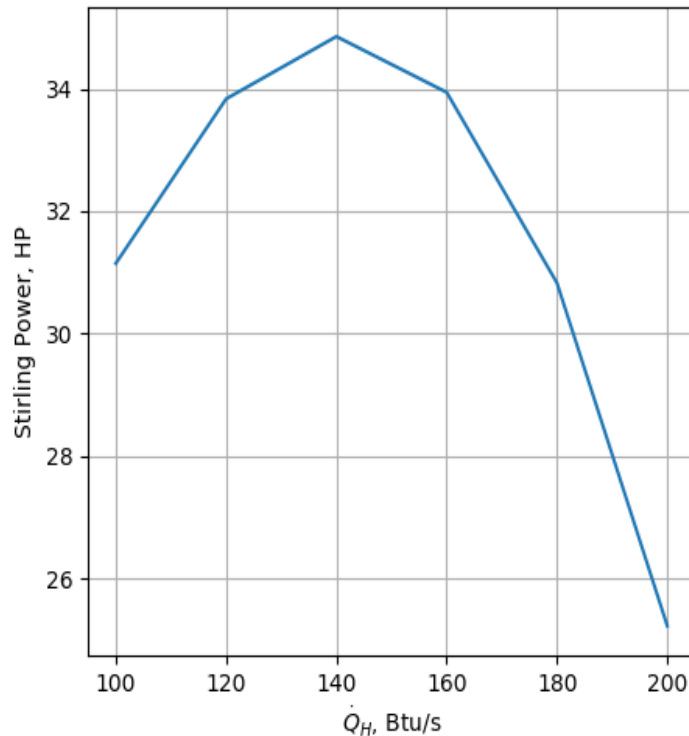



# Strayton Temperature profiles

- Temperature vs. power flow to the hot side of the stirling
  - Blade cooling
    - Constant Blade cooling shows increase in Stirling blade cooling effect
  - Reduction of Stirling temperature ratio
    - As power flow increases Stirling temperature ratio decreases which reduces the efficiency of the Stirling (Note: there is an assumed required 1.4 temperature ratio for the Stirling to operate)

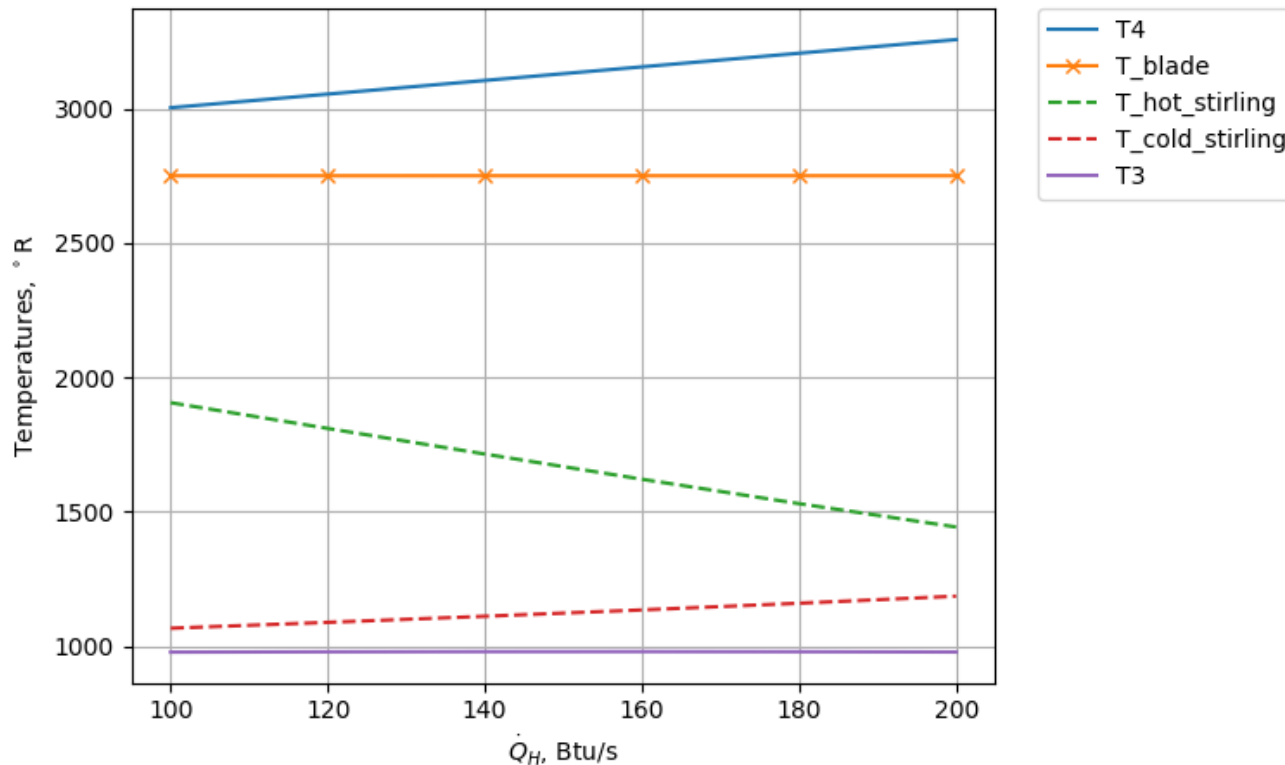

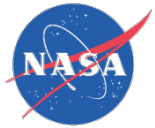

# Optimized systems

- 2 power levels were analyzed for this study, 200 HP and 670 HP
  - Baseline Brayton cycle and Strayton cycle concepts were developed for comparison purposes,  $T_{\text{blade}} = 2750 \text{ }^\circ\text{R}$
  - Efficiency gain of ~10% and ~3% at 200 HP and 670 HP power points respectively

## Brayton Cycle Engines

Total Power (HP)	Brayton Power (HP)	OPR	T liner ( $^\circ\text{R}$ )	Efficiency	SFC (lbm/HPh)	Air Mass Flow (lbm/s)
200	200	6.5	2750	0.24	0.566	1.11
670	670	10	2750	0.29	0.433	3.23

## Strayton Cycle Engines

Total Power (HP)	Brayton Power (HP)	Stirling Power (HP)	OPR	$T_{\text{st,H}}$ ( $^\circ\text{R}$ )	$T_{\text{st,C}}$ ( $^\circ\text{R}$ )	T liner ( $^\circ\text{R}$ )	Efficiency	SFC (lbm/HPh)	Air Mass Flow (lbm/s)	Stirling Temperature Ratio
200	166.62	33.38	6.5	1598	1141	3167	0.33	0.402	0.87	1.4
670	640	30.01	10	1761	1246	3117	0.32	0.394	2.57	1.41

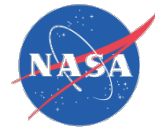

# SFC comparison

Comparison of IC, Turbine, and Strayton Engines  
SFC Vs Shaft Power

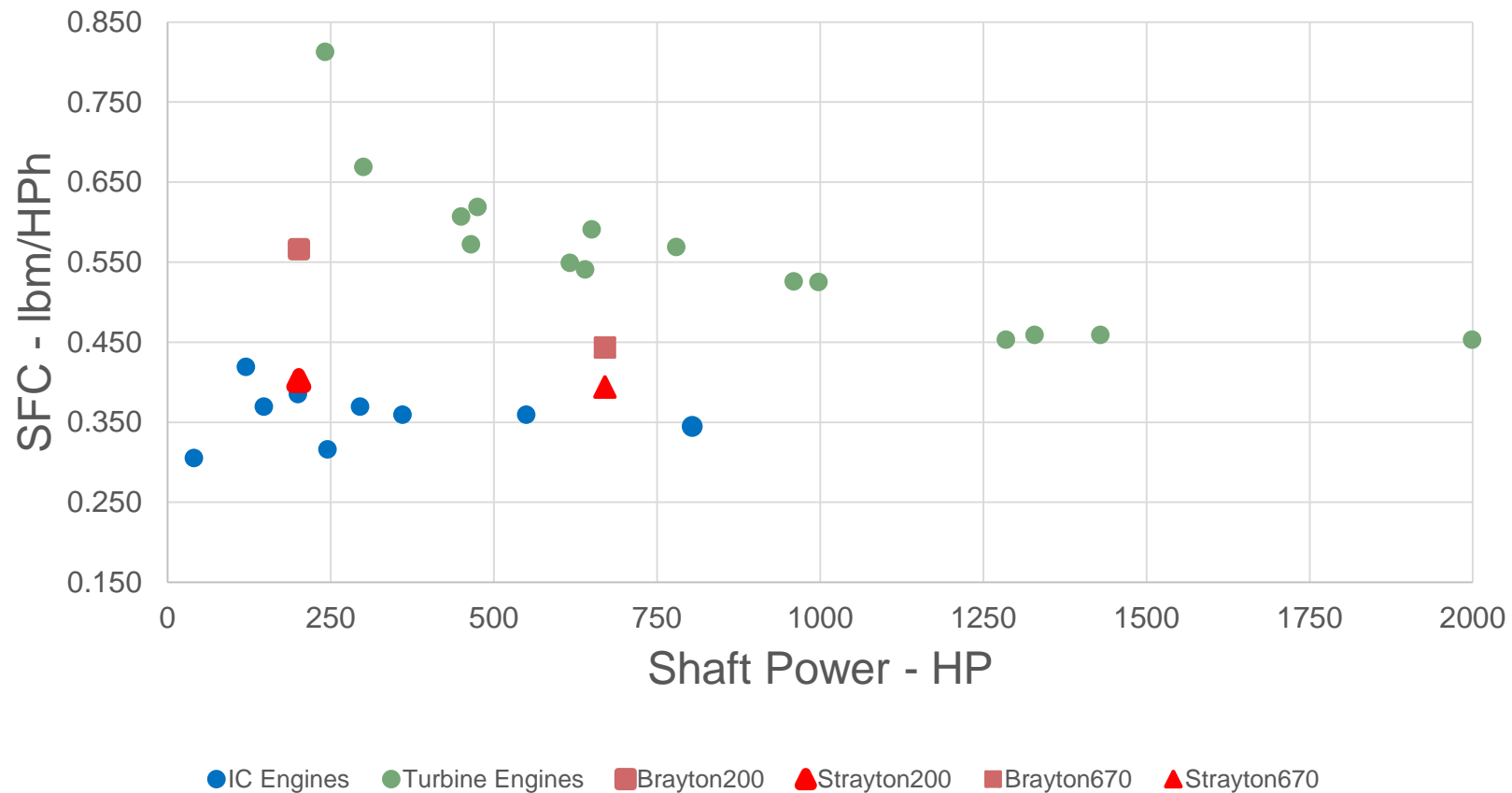

Strayton engine shows SFC similar to internal combustion engines at low power

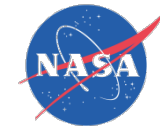

# Specific power comparison

Comparison of IC, Turbine, and Strayton Engines  
Specific Power Vs Shaft Power

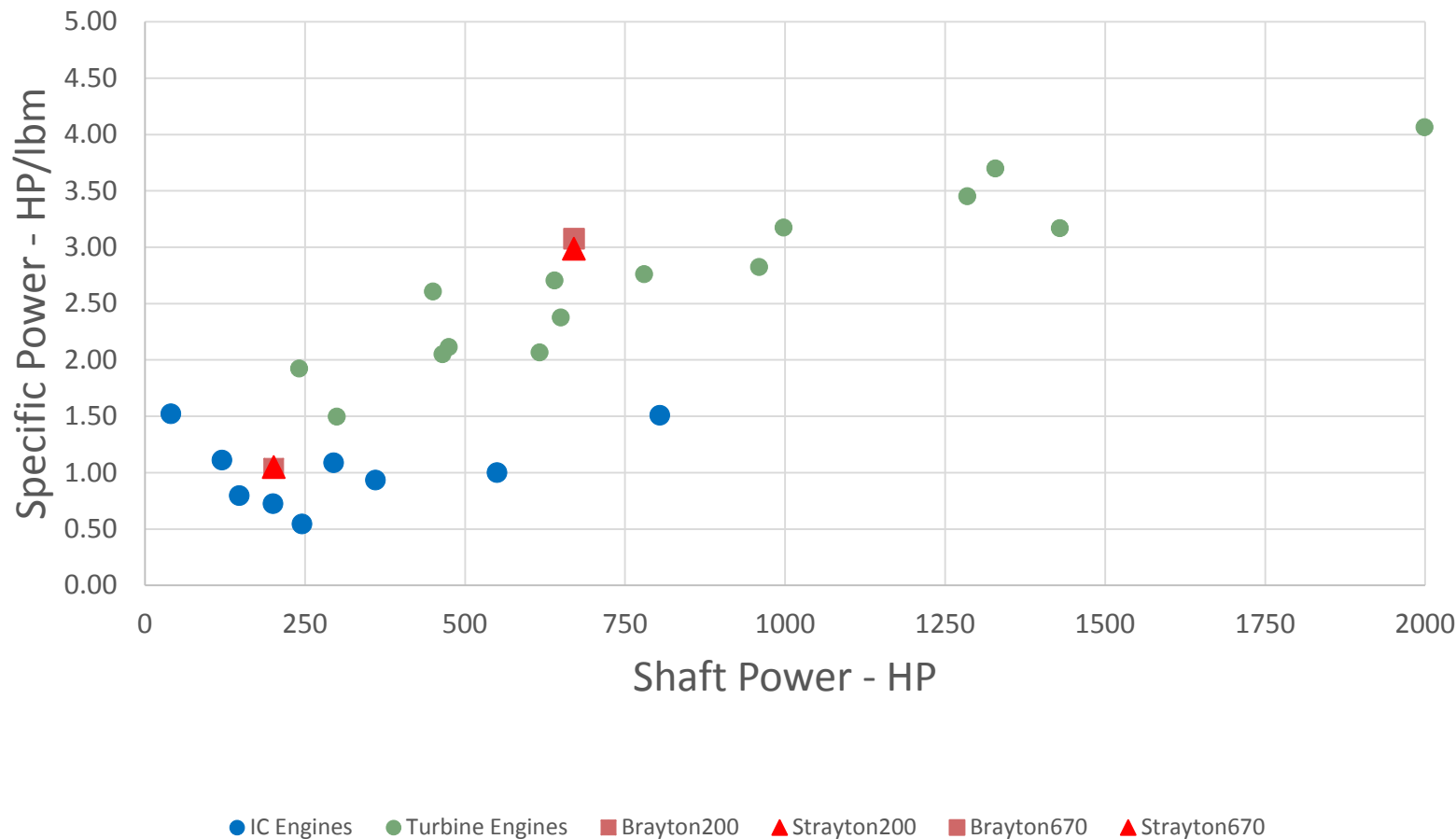

Estimated weights of Strayton similar to that of an unmodified gas turbine.

# Stirling controls model

- Dynamic Stirling controls model (DSCM) based on Ohio University Stirling Engine Analysis (SEA) software, within MATLAB
  - Design parameters of compression and expansion swept volume and clearance volume, cooler, heater, and regenerator size, Stirling frequency, operating fluid, and pressure were tuned to meet predicted power, Stirling temperature ratios, and efficiency taken from the NPSS model.

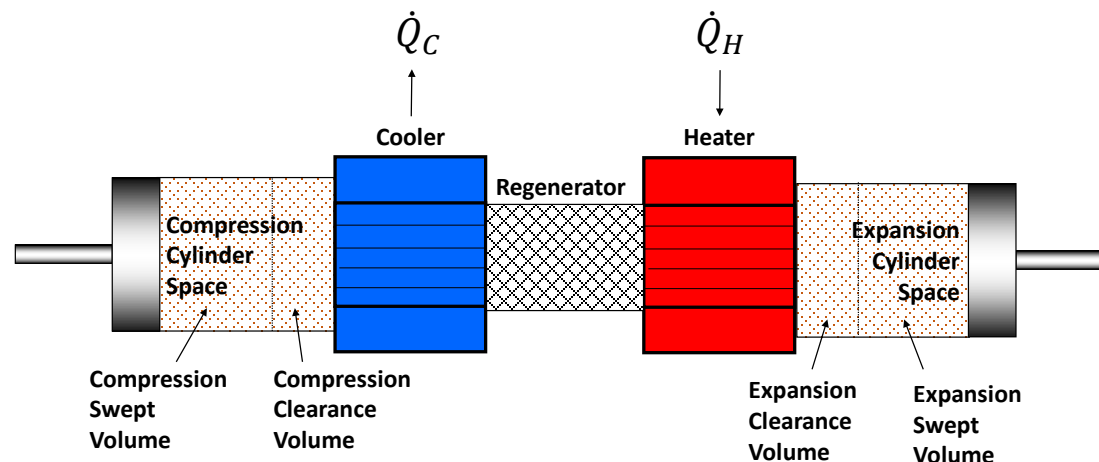



# Stirling controls model

- Operation begins at the design point and reduces power and adjusts stroke length

- Strayton efficiency maximized when stroke length reduced as stirling power is reduced
- Efficiency increased by up to ~3%
- Highlights requirement for a coupled method of control and potential off design efficiency benefit to the system.

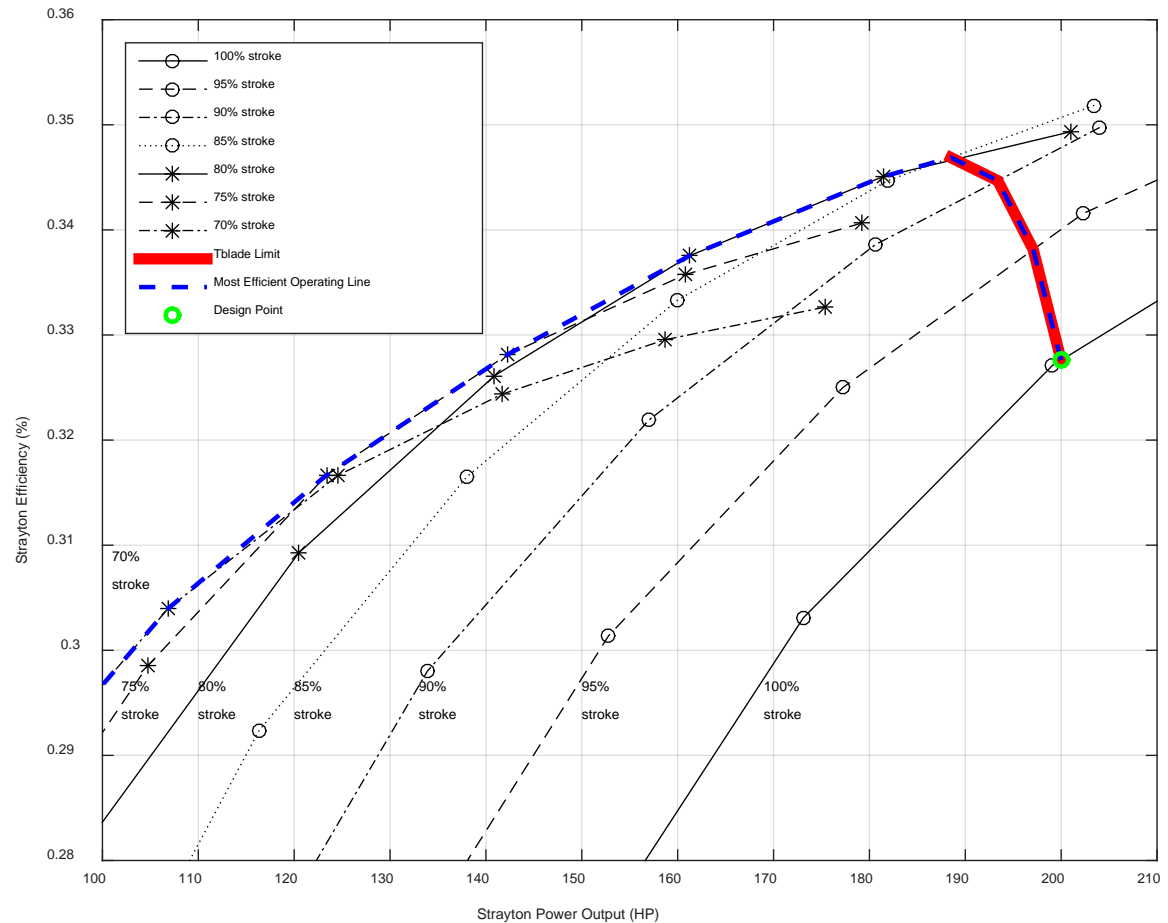



# Key technologies

## High temperature materials

- Key to efficient and higher power Strayton is developing higher temperature turbine components.
  - Currently, low power turbine engines operate with a  $T_4$  around 2000 °R for maintenance and cost benefits
  - This study examined potential turbine blade temperatures of 2750 °R and liner temperatures of 3200 °R, which are more in line with large gas turbines with robust blade and liner cooling mechanisms.
- To achieve the required temperatures materials must be developed to allow greater hot side temperatures at a low cost
  - Research in high temperature ceramics has shown promise, with next-generation ceramic matrix composites expected to reach roughly 3200 °R
  - Additional thermal coatings could raise this to 3500 °R





# Key technologies Stirling Engines

- **New Stirling technologies will need to be examined**
  - High power Stirling engines
    - Thermal acoustic stirling development
    - Multi-stage Stirling
  - Reliability of stirling engines (Gas turbines typically run for 1000s of hours)
    - Rotating Stirling
  - Installation/manufacturing of Stirling within a gas turbine shaft
  - Maintainability of Stirling that support line replaceable unit (LRU) access and removal



## Key technologies

### Blade cooling / Heat exchangers / heat pipes

- Heat transfer technologies:

### Gas turbine to Stirling heat exchanging

- Rotating/ no pressure rise heat exchanger to increase heat transfer on cold side of Stirling
- Safe and efficient heat pipes usable at high rotational speeds and temperatures.
  - Non-volatile medium materials
- Turbine blade thermal transfer materials or coatings to optimize the ratio between turbine blade cooling effect and Stirling power transfer.



# Key technologies

## Coordinated control system

- Ability to operate transiently through different power levels and within the operational envelope
  - In a typical gas turbine engine component temperature transients can extend into minutes, while customer power demands may need to be met in seconds.
  - Strayton control system must manage this disparity to guarantee power as requirements demand.
    - Maintain stall margins and temperature limits during transient operation utilizing potential control effectors, such as fuel flow, and Stirling stroke length
    - Identifying required control methodology: sensor suite, potential operational schedules.



## Summary and Conclusions

- **The Strayton Engine: Brayton cycle, Stirling cycle hybrid engine concept.**
  - Cycle analysis shows significant efficiency gain over the Brayton cycle only engine with increasing gains as temperature is increased.
    - With a 10% increase (over the Brayton cycle only engine) in efficiency at 200 HP engine level
  - Generally greater efficiency gain for lower power generating engines because Stirling power level scales with temperature ratio, not Brayton power production.
  - Controls study demonstrates system sensitivity to design parameters and illustrates Stirling off design operation
- **Key Technologies**
  - High temperature materials
  - Stirling Engines (manufacturability, maintainability, high power capability)
  - Heat transfer (rotating heat exchangers, heat pipes, turbine blades)
  - Coordinated control system (seamless operation between systems with very different time constants)



# Acknowledgments

Funding for this work was provided by the Convergent Aeronautics Solutions (CAS) project.