

# Radiation Hardness Assurance: Evolving for *NewSpace*

**Michael J. Campola,**

NASA Goddard Space Flight Center (GSFC)

**Jonathan A. Pellish**

NASA Electronic Parts Manager /

NASA Electronic Parts and Packaging (NEPP) Program Deputy Manager

# Acronyms

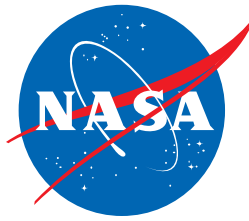

CME	Coronal Mass Ejection
COTS	Commercial Off The Shelf
DDD	Displacement Damage Dose
EEE	Electrical, Electronic, and Electromechanical
ELDRS	Enhanced Low Dose Rate Sensitivity
EP	Enhanced Performance
ESA	European Space Agency
GCR	Galactic Cosmic Ray
GOMAC	Government Microcircuits Applications and Critical Technologies Conference
GSFC	Goddard Space Flight Center
GSN	Goal Structuring Notation
HEART	Hardened Electronics and Radiation Technology
LEO	low earth orbit
LET	Linear Energy Transfer
MBMA	model based mission assurance
MRQW	Microelectronics Reliability and Qualification Workshop
NAND	Negated AND or NOT AND
NASA	National Aeronautics and Space Administration
NEPP	NASA Electronic Parts and Packaging
NEPP ETW	NASA Electronic Parts and Packaging (NEPP) Program Electronics Technology Workshop
NSREC	Nuclear and Space Radiation Effects Conference

RADECS	Radiation Effects on Components and Systems
RHA	Radiation Hardness Assurance
SAA	South Atlantic Anomaly
SEE	Single Event Effects
SEE/MAPLD	SEE-MAPLD Single Event Effects (SEE) Symposium/ Military and Aerospace Programmable Logic Devices (MAPLD) Workshop
SEGR	Single Event Gate Rupture
SEL	Single Event Latchup
SEP	Single Event Effects Phenomena (includes SEU, SEL, SEGR and SET)
SERESSA	School on the Effects of Radiation on Embedded Systems for Space Applications
SET	Single Event Transient
SEU	Single Event Upset
SLU	Saint Louis University
SwaP	Size, weight, and power
TID	Total Ionizing Dose
TID	Total Ionizing Dose
TMR	triple-modular redundancy
TNID	Total Non-Ionizing Dose
UV	Ultra-Violet

# NEPP Program- Small Mission Efforts

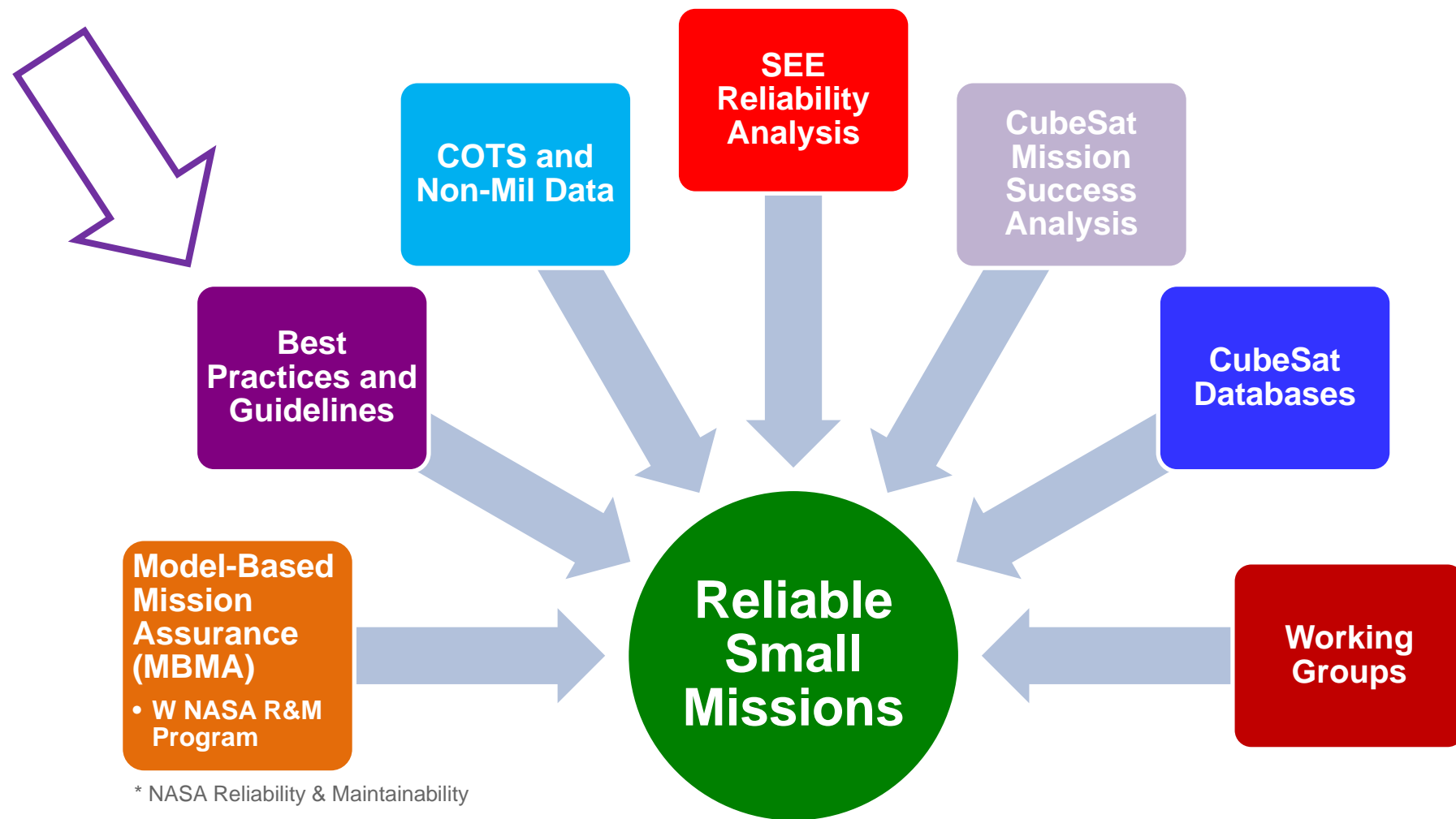
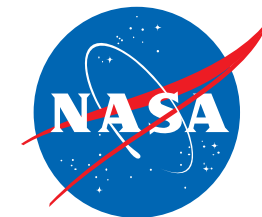

# Outline

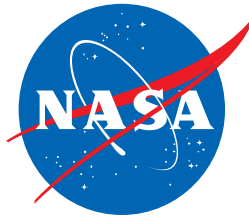

- **New Space and SmallSat Considerations**
- **The Natural Space Radiation Environment Hazard**
- **Radiation Effects on Micro-Electronics**
- **Hardness Assurance, as a Discipline, with its Challenges**
  - **New Technologies**
  - **New Architectures**
  - **Unbound Risks**
- **Building Smart Requirements**
- **Risk Acceptance and Guidance**

# New Space – New Point of View

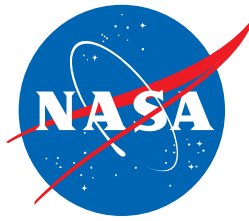

## SmallSats Come in Many Sizes

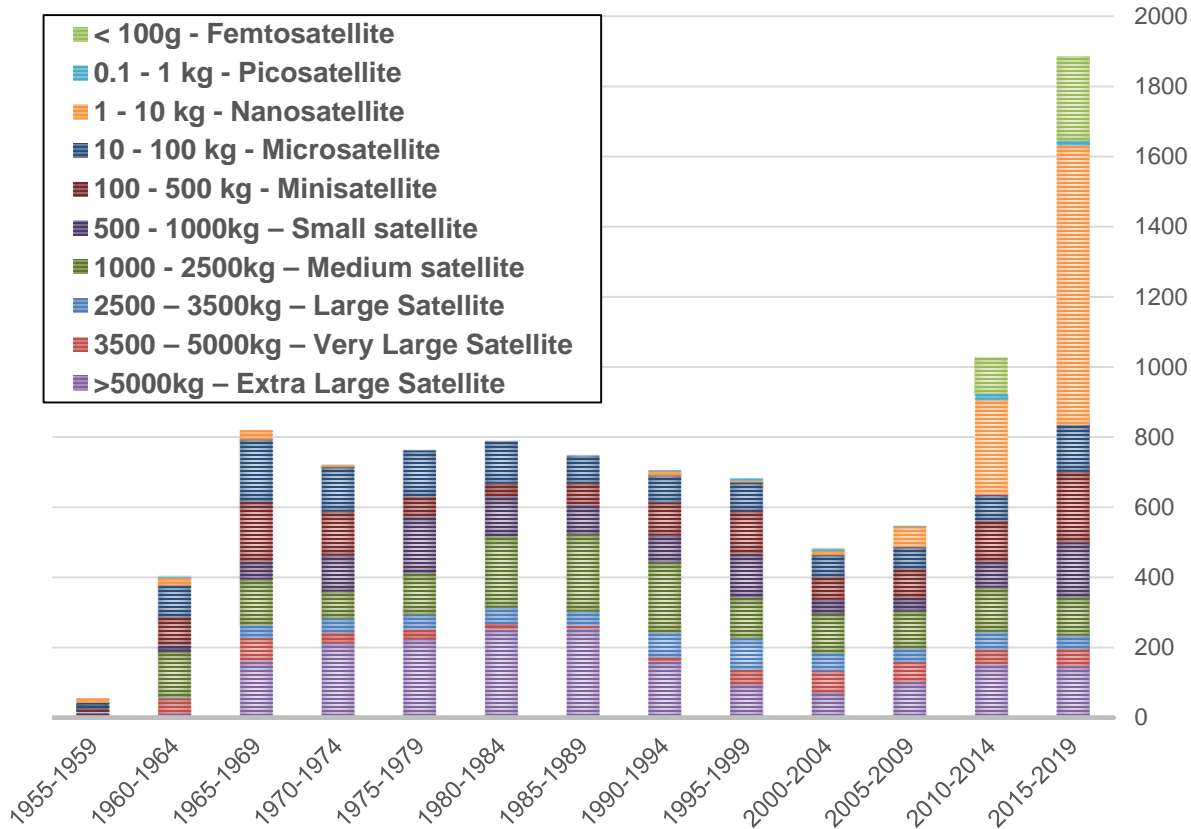

Seradata SpaceTrak Data

## Component Grades are Merging

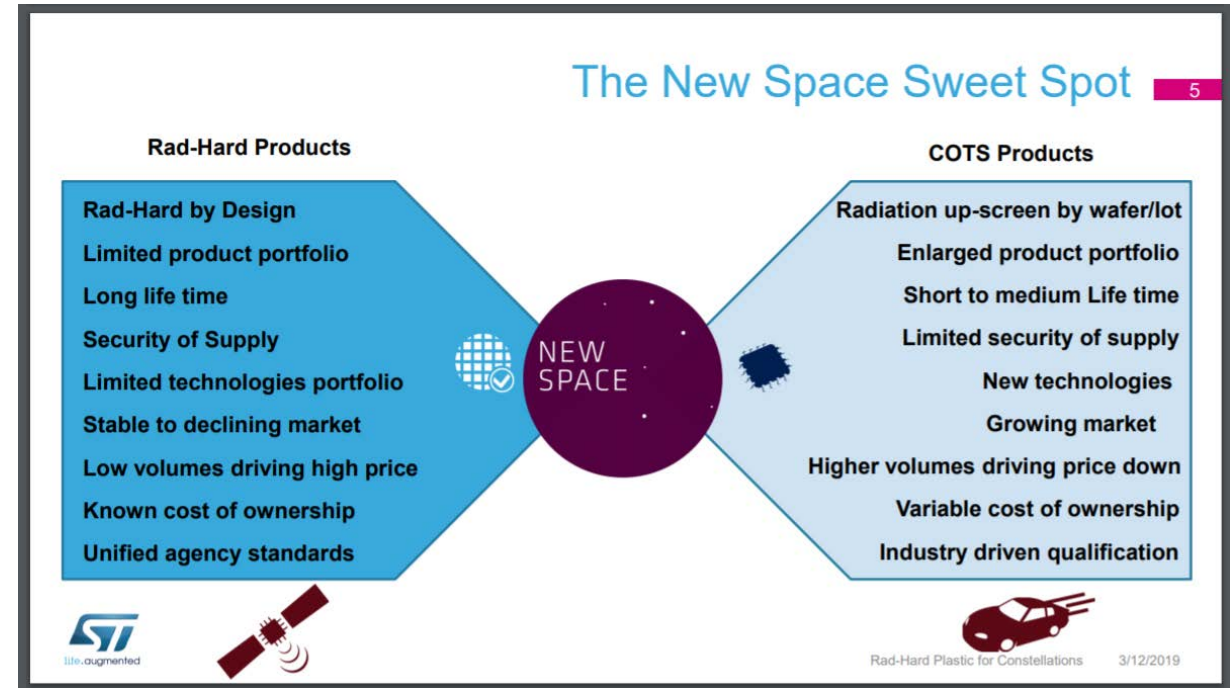

ESSCON : Eccofet

**Risk acceptance is being used as a means to enable innovation**

# New Space – Looking Ahead

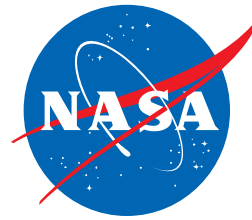

## Constellations and Swarms

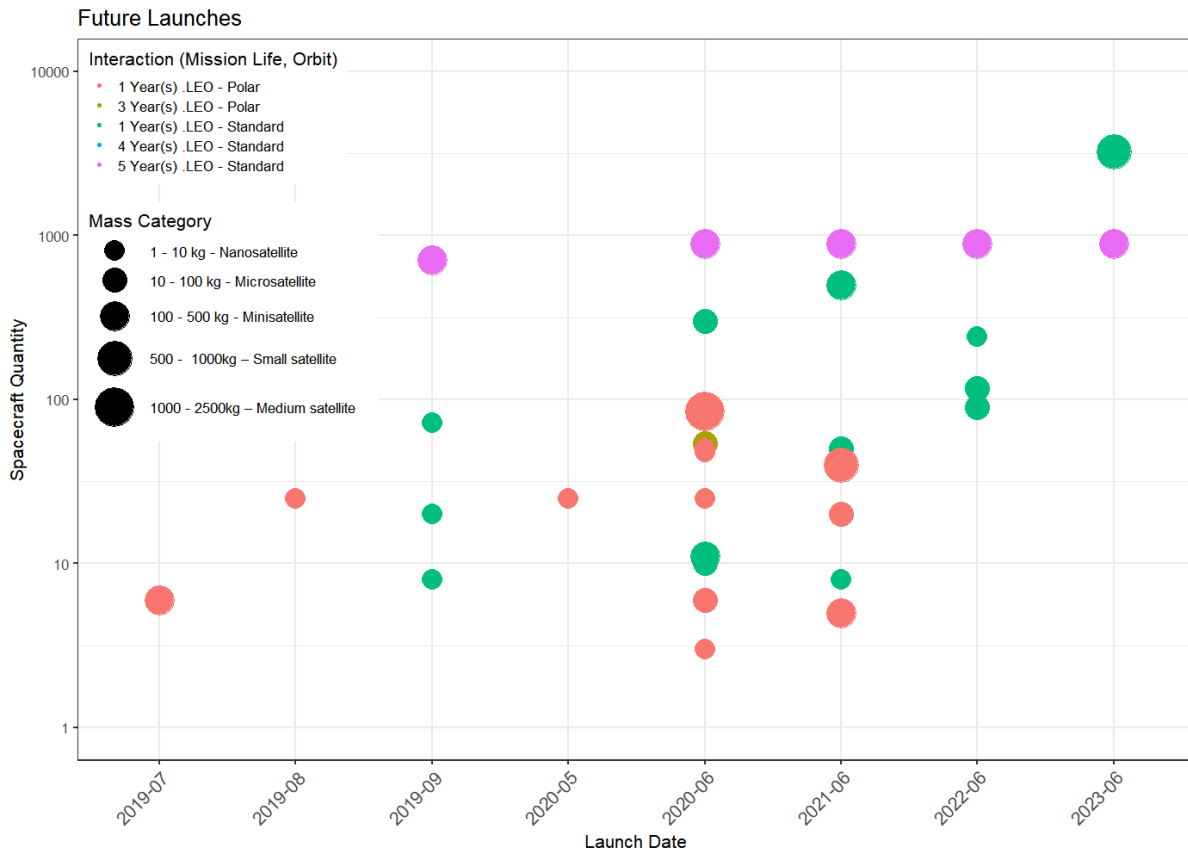

### Seradata SpaceTrak Data (Notional Launches)

To be presented by Michael J. Campola at Radiation and its Effects on Components and Systems (RADECS), Montpellier, France, September 16<sup>th</sup>, 2019

## New Space = New Companies

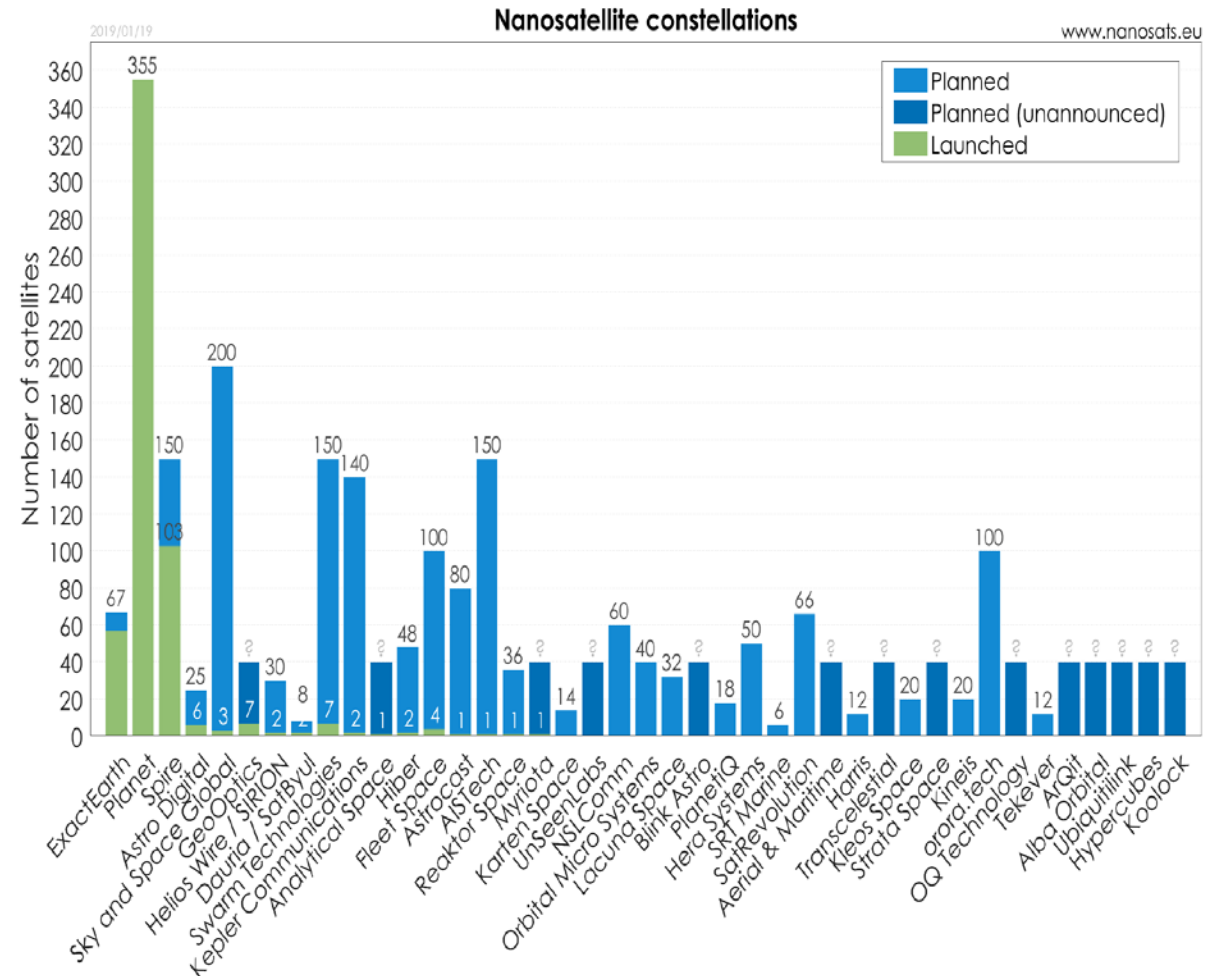

# New Space – Same Old Radiation

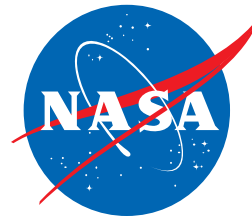

- **New mission concepts and SmallSat paradigm**
  - Radiation challenges identified in the past are here to stay; adoption of new technologies are often the risk driver
  - Commercial Space, Constellations, Small missions, etc. will benefit from detailed hazard definition and mission specific requirements
- **The need for Radiation Hardness Assurance (RHA)**
  - Radiation effects are a mix of disciplines, evolve with technologies and techniques
  - Misinterpretation of failure modes / misuse of available data can lead to over/under design
  - RHA flow doesn't change, risk acceptance needs to be tailored
- **Some Top Level Resources**
  - NPR-7120.5 – NASA Agency Program Management
  - GPR-8705.4 – NASA Goddard Risk Classification Guidelines
  - NASA-STD-8739.10 – NASA Parts Assurance Standard

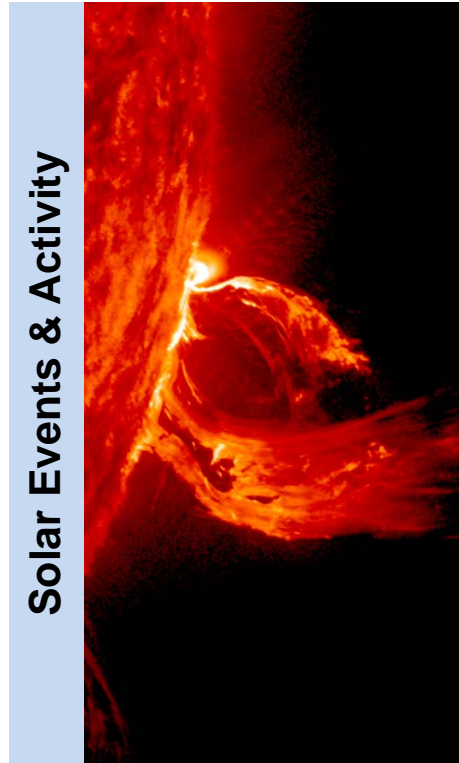

Solar Events & Activity

<https://sdo.gsfc.nasa.gov>

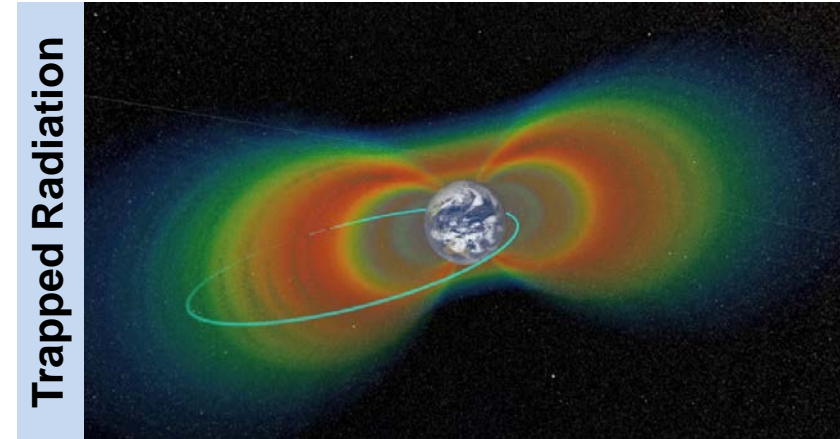

Trapped Radiation

<https://www.nasa.gov/van-allen-probes>

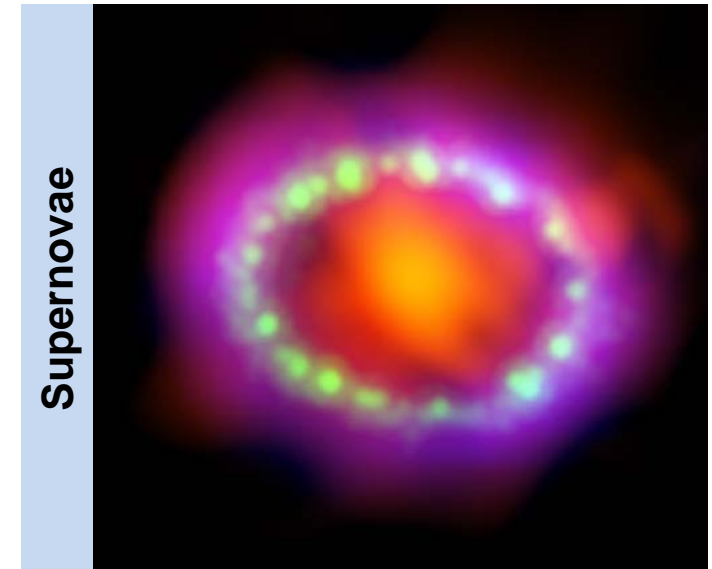

Supernovae

[NASA, ESA, and L. Hustak \(STScI\)](#)



# Who Needs This Guidance?

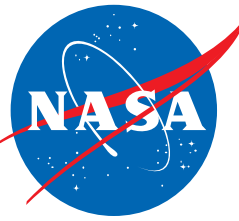

- **Universities / CubeSats**

- May be first-time designers, or previous missions did not have requirements
- Schedule driven, limited time for development
- Rideshares – could end up in multiple environments

- **Space Agencies / Government**

- More compact designs in new destinations
- Cost savings of SmallSat platform, with more reliable outcome
- More willing to trade risk for capability

- **Device / Subsystem Manufacturers**

- Product / Device offerings: Space Plastic, EP, LeanRel, radiation tolerant, modified HiRel, etc.
- Fault tolerance in designs

## CubeSat Metrics

Total Count of CubeSats Produced by an Organization

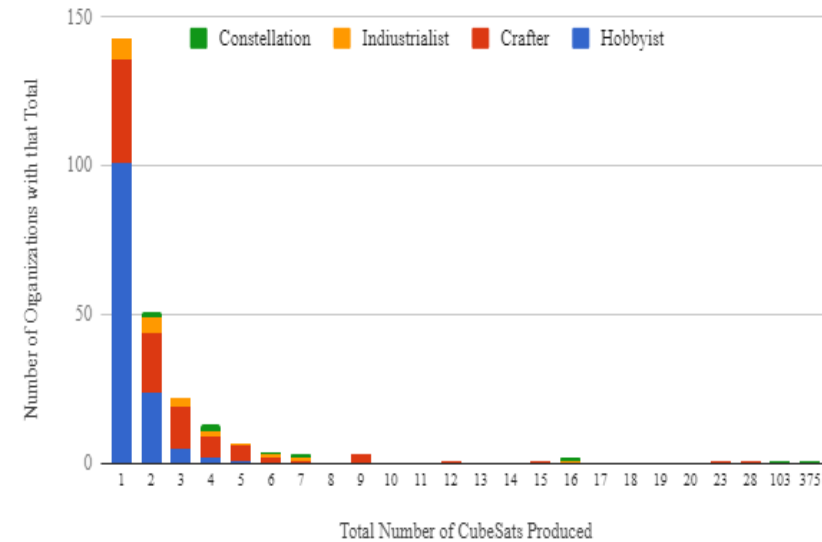

Michael Swartwout, SLU CubeSat Database

## Dellinger

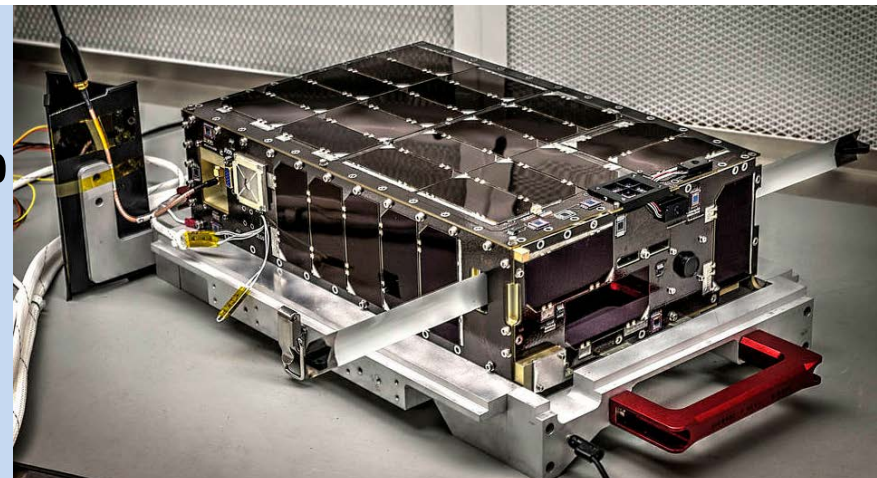

NASA's Goddard Space Flight Center/Bill Hrybyk



# Natural Space Radiation Environment

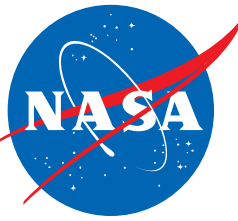

## Galactic Cosmic Rays

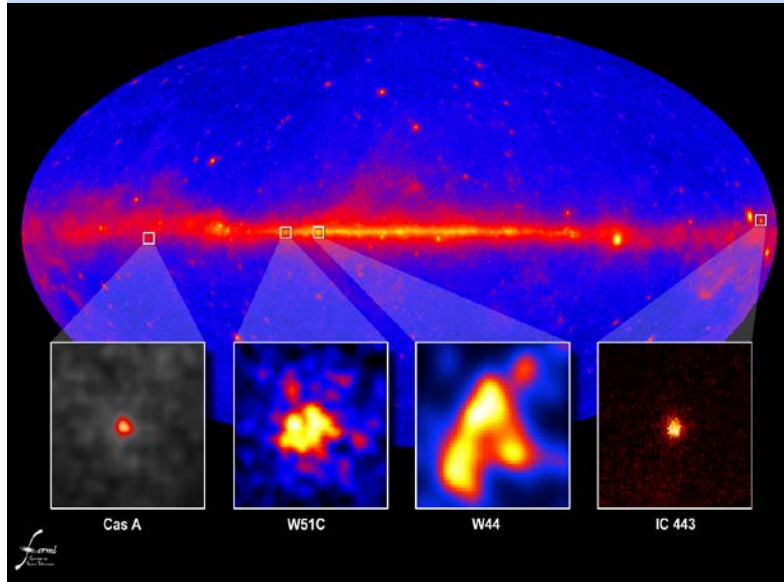

Energetic supernovae remnants  
(~GeV, Z=1-92)  
Originate outside of our solar system

## Solar Activity



Solar Wind, Solar Cycle  
CMEs (proton rich)  
Flares (heavy ion rich)

## Trapped Particles in Planetary Magnetic Fields

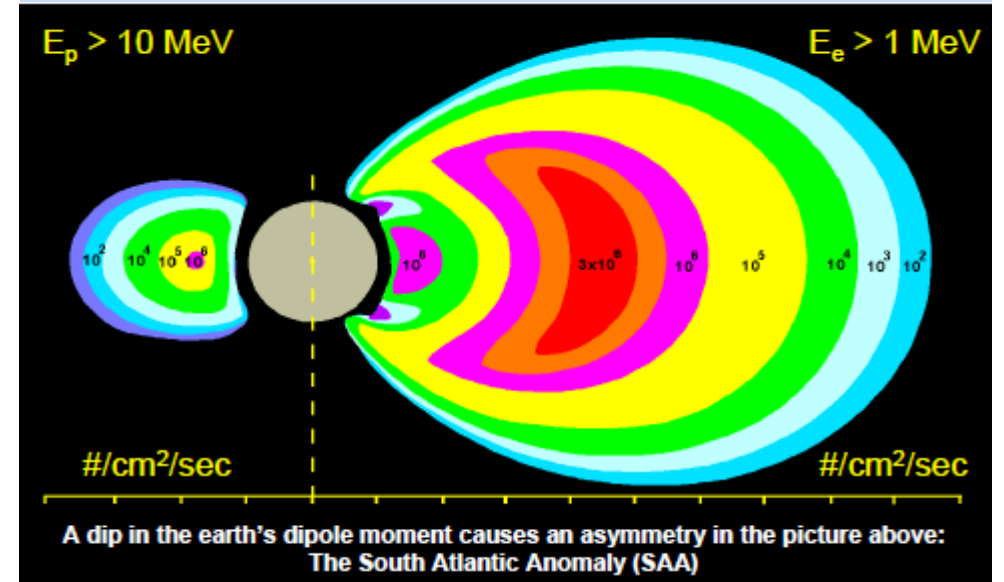

Fluctuate with Solar Activity and Events  
Not a perfect dipole  
Protons and Electrons trapped at different  
L-shell values and energies

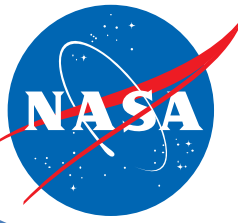

# Natural Space Radiation Environment

- Plasma
- **Particle Radiation**
- Neutral Gas Particles
- UV and X-Ray
- Orbital Debris

wear-out

Degradation of micro-electronics  
Degradation of optical components  
Degradation of solar cells

instantaneous

Data corruption  
Noise on images  
System shutdowns or resets  
Circuit Damage  
Part tolerances exceeded

(After Barth)

Spacecraft Charging, Ionizing Dose, Non-Ionizing Dose, Single Event Effects, Drag, Surface Erosion, Debris/Micro-Meteoroid Impacts, Thermal Cycles

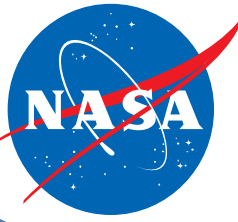

# Natural Space Radiation Environment

- **Particle Radiation**

wear-out

Degradation of micro-electronics  
Degradation of optical components  
Degradation of solar cells

instantaneous

Data corruption  
Noise on images  
System shutdowns or resets  
Circuit Damage  
Part tolerances exceeded

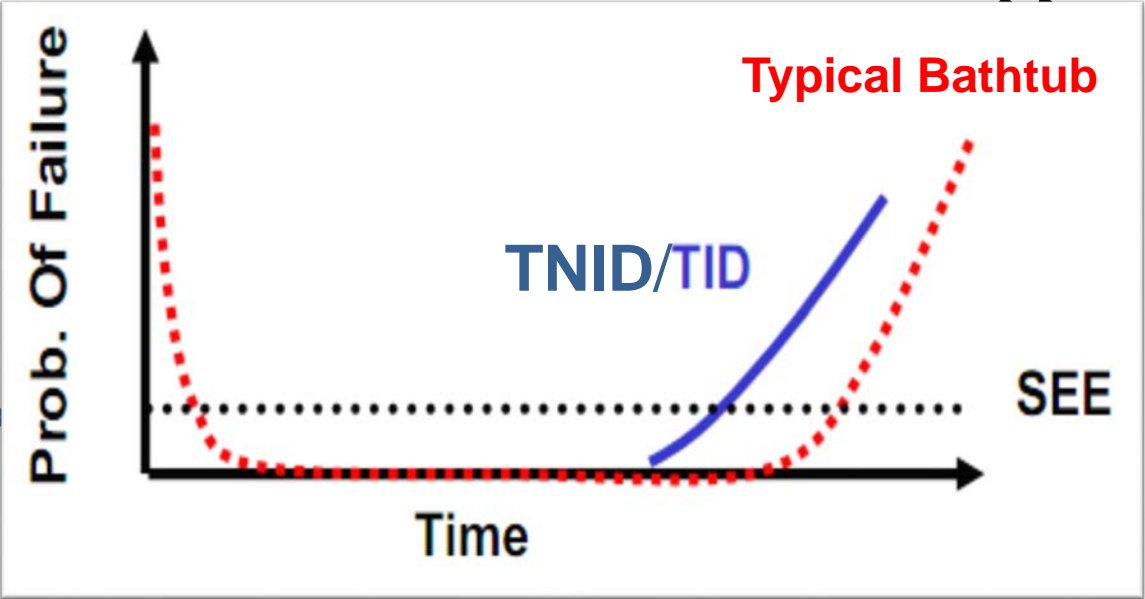

(After Buchner)

# Conventional Units Explanation

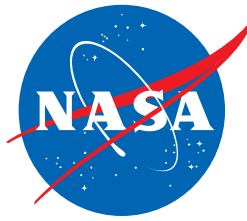

## Degradation

- **Total Ionizing Dose (TID)**

- Absorbed dose (rad(Si))

1 rad = 100 erg/g = 0.01 J/kg; 100 rad = 1 Gy

- Always specified for a particular material

1 rad(SiO<sub>2</sub>), 10 krad(Si), 100 Gy(H<sub>2</sub>O)

- This is not exposure (R), or dose equivalent (Sv)

- **Total Non-ionizing Dose (TNID)**

- Fluence (particles/cm<sup>2</sup>)

Number of particles per unit area

- Displacement Damage Dose (DDD)

Specified at a given incident particle energy - e.g.,  
10 MeV p+, 50 MeV p+, 1 MeV eq. neutrons, etc.

## Single Event

- **Linear Energy Transfer (LET)**

- Stopping power normalized to target material

$$S = -\frac{dE}{dx} \Rightarrow \text{LET} = -\frac{1}{\rho} \frac{dE}{dx}$$

- Units are MeV·cm<sup>2</sup>/mg

- **Cross Section ( $\sigma$ )**

- Device particle interaction (cm<sup>2</sup>)

- Used in calculation of rate

Can be /device or /bit per time interval

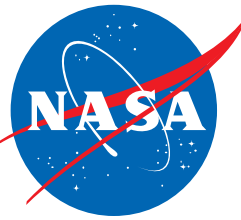

# Degradation Contributors vs. Single Event

- **Cumulative effects**
  - Depend highly on which contributors and duration in their presence
  - Mimic wear-out/aging
  - TNID and TID must be accounted for
- **Typical destinations (LEO, GEO)**
  - LEO at low altitude/inclination is more protected by the Geomagnetic field
  - Proximity to the poles & SAA show a large variability in dose despite short mission durations
  - Electrons and their braking radiation are the big offender in Geostationary orbits (don't forget about spacecraft charging...)
- **Note that**
  - A little bit of shielding goes a long way
  - Altitude plays a huge role when in/near the radiation belts (even transiting)
  - Beyond Geomagnetic field, highly variable solar environment contributions (Solar cycle)

***Degradation has a strong dependence on where you go, not just how long you are on orbit***

Total Ionizing Dose vs. Shielding

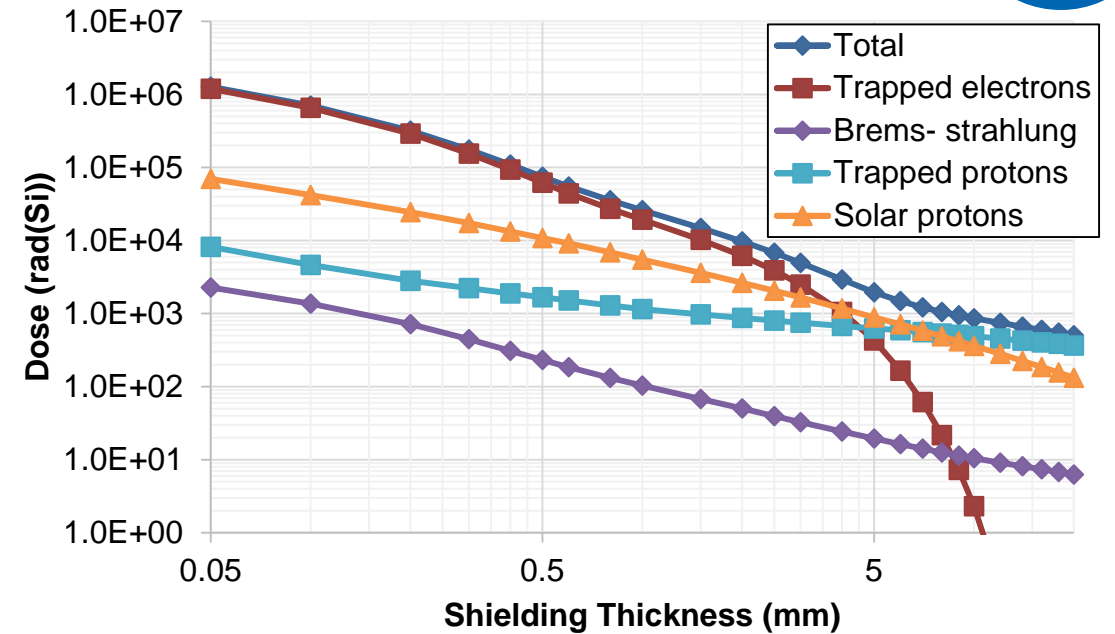

Approximate Dose Behind ~2.5mm Al

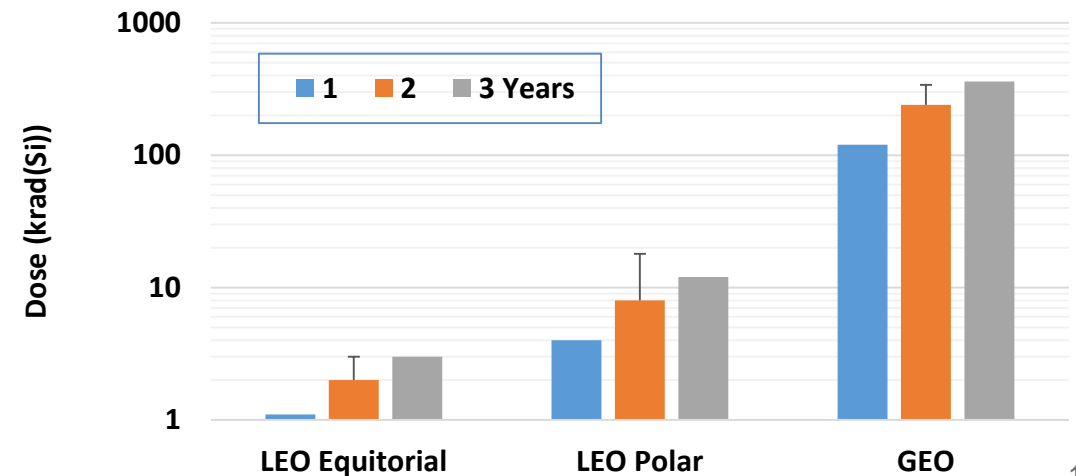

# Degradation vs. Single Event Contributors

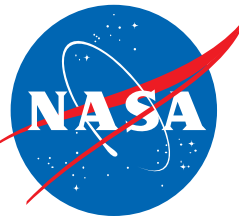

- **One particle causes the effect**
  - Random in nature, particle must traverse sensitive structure within device and have sufficient charge creation along its path
  - Shielding doesn't do so much for highly energetic particles
  - Device technology can be dependent on particle species
- **Typical Destinations (LEO, GEO)**
  - Again altitude plays a role; for some devices that is a direct threat
  - You are exposed to more GCR + Solar contribution as geomagnetic protection is reduced
  - Natural phenomena like the South Atlantic Anomaly (SAA), magnetic poles, are temporal drivers
- **Note that**
  - There will be a background rate, solar cycle dependence, solar event rate, increased rate for poles or SAA – **not just one rate to consider**

*Single event contributors benefit very little from shielding, have dependence on where you are*

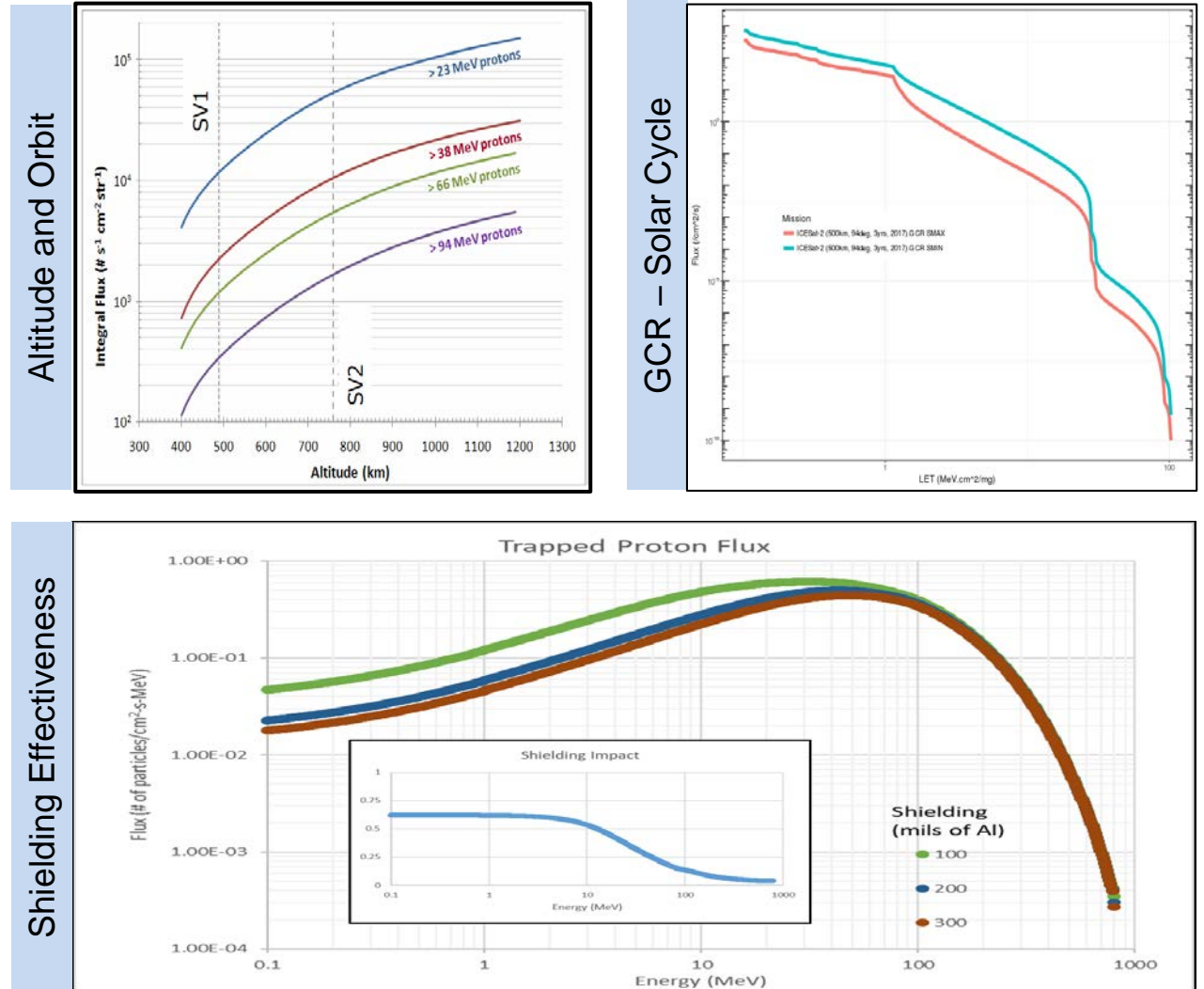



# Summary of Environmental Hazards

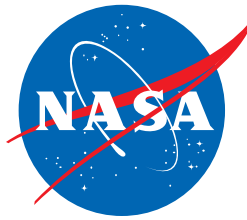

	Plasma (charging)	Trapped Protons	Trapped Electrons	Solar Particles	Cosmic Rays	Human Presence	Long Lifetime (>10 years)	Nuclear Exposure	Repeated Launch	Extreme Temperature	Planetary Contaminates (Dust, etc)
<b>GEO</b>	Yes	No	Severe	Yes	Yes	No	Yes	No	No	No	No
<b>LEO (low-incl)</b>	No	Yes	Moderate	No	No	No	Not usual	No	No	No	No
<b>LEO Polar</b>	No	Yes	Moderate	Yes	Yes	No	Not usual	No	No	No	No
<b>International Space Station</b>	No	Yes	Moderate	Yes - partial	Minimal	Yes	Yes	No	Yes	No	No
<b>Interplanetary</b>	During phasing orbits; Possible Other Planet	During phasing orbits; Possible Other Planet	During phasing orbits; Possible Other Planet	Yes	Yes	No	Yes	Maybe	No	Yes	Maybe
<b>Exploration – Lunar, Mars, Jupiter</b>	Phasing orbits	During phasing orbits	During phasing orbits	Yes	Yes	Possibly	Yes	Maybe	No	Yes	Yes

[https://radhome.gsfc.nasa.gov/radhome/papers/SSPVSE05\\_LaBel.pdf](https://radhome.gsfc.nasa.gov/radhome/papers/SSPVSE05_LaBel.pdf)



# Radiation Hazard Contributors for Dose and SEE

## Environment

		Environment		
		LEO Equatorial	LEO Polar (Sun Sync)	GEO / Interplanetary
Mission Lifetime	> 3 Years	Moderate Dose / Attenuated GCR, Trapped Proton, SAA, Some Solar Proton dependence for variation	High Dose / Higher GCR, High Energy Trapped Protons in SAA and Poles, Some Solar Proton dependence for variation	High Dose / High GCR, High Solar Proton Variability
	1-3 Years	Manageable Dose / Attenuated GCR, Trapped Proton, SAA, Some Solar Proton dependence for variation	Moderate Dose / Higher GCR, High Energy Trapped Protons in SAA and Poles, Some Solar Proton dependence for variation	High Dose / High GCR, High Solar Proton Variability
	< 1 Year	Manageable Dose / Attenuated GCR, Trapped Proton, SAA, Some Solar Proton dependence for variation	Moderate Dose / Higher GCR, High Energy Trapped Protons in SAA and Poles, Some Solar Proton dependence for variation	Moderate Dose / High GCR, High Solar Proton Variability

# Radiation Effects on Active Microelectronic Devices

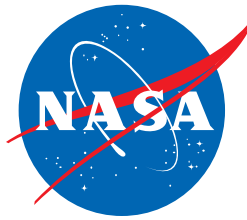

- **Cumulative effects and single event effects can both be permanently damaging**
  - TID/DDD lead to wear-out of device operation and degrade devices beyond acceptable operations internally and externally
  - Single Event Effects can be catastrophic instantaneously by turning on parasitic devices within the semiconductor or inducing electric field across dielectrics that eventually break down
  - Synergistic effects can make ground based testing very difficult
- **Destructive Single Event Effects (SEEs)**
  - Irreversible processes
  - Terms: Latchup, Burnout, Gate Rupture
- **Non-Destructive SEEs**
  - Lead to interruptions in operation and/or errors leading to unknown state spaces or loss of science / mission if not accounted for
  - Terms: Functional Interrupt, Transients, Upsets
- **IEEE / Papers / Short Courses / Presentations**
  - GOMAC, HEART, MRQW, NEPP ETW, NSREC, RADECS, SEE/MAPLD, SERESSA, SPWG

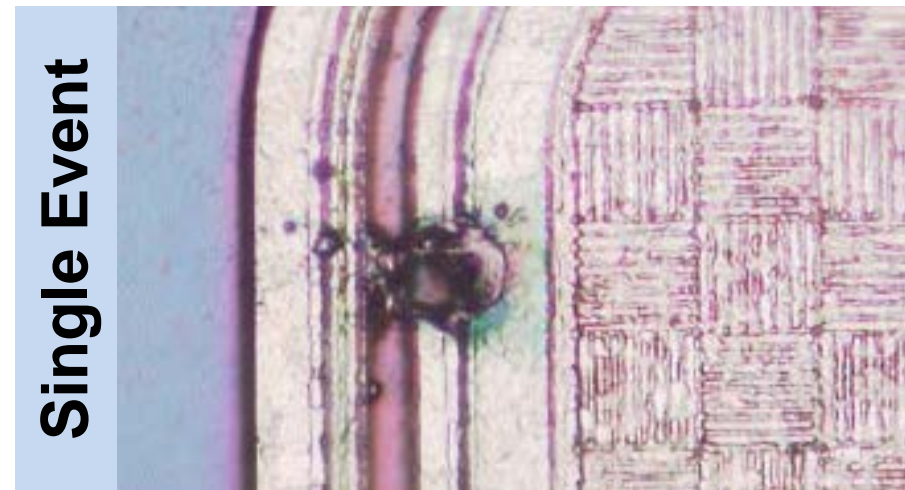
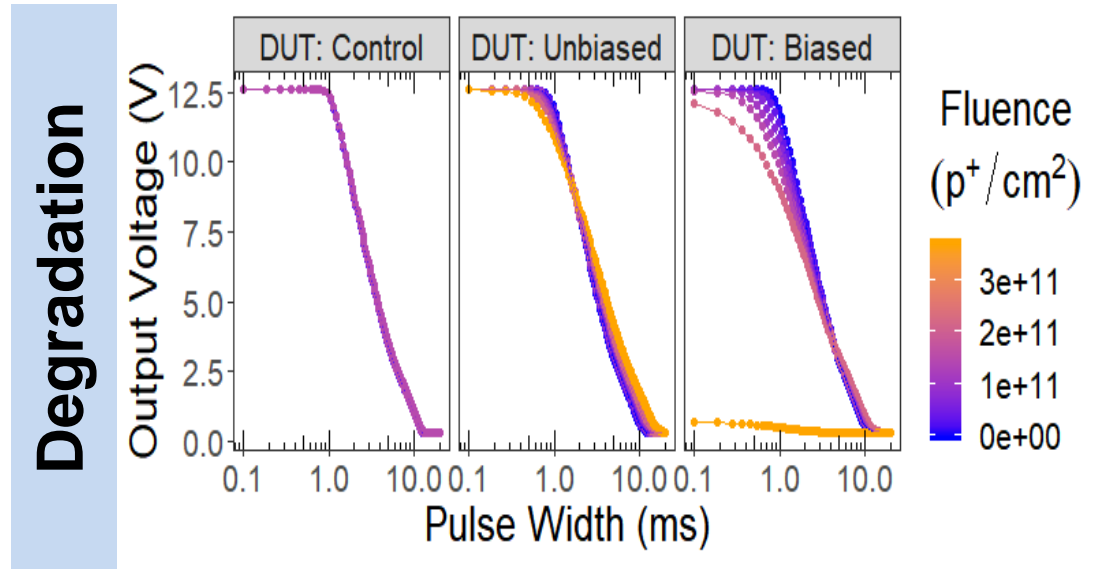

# Device and Particle Interaction

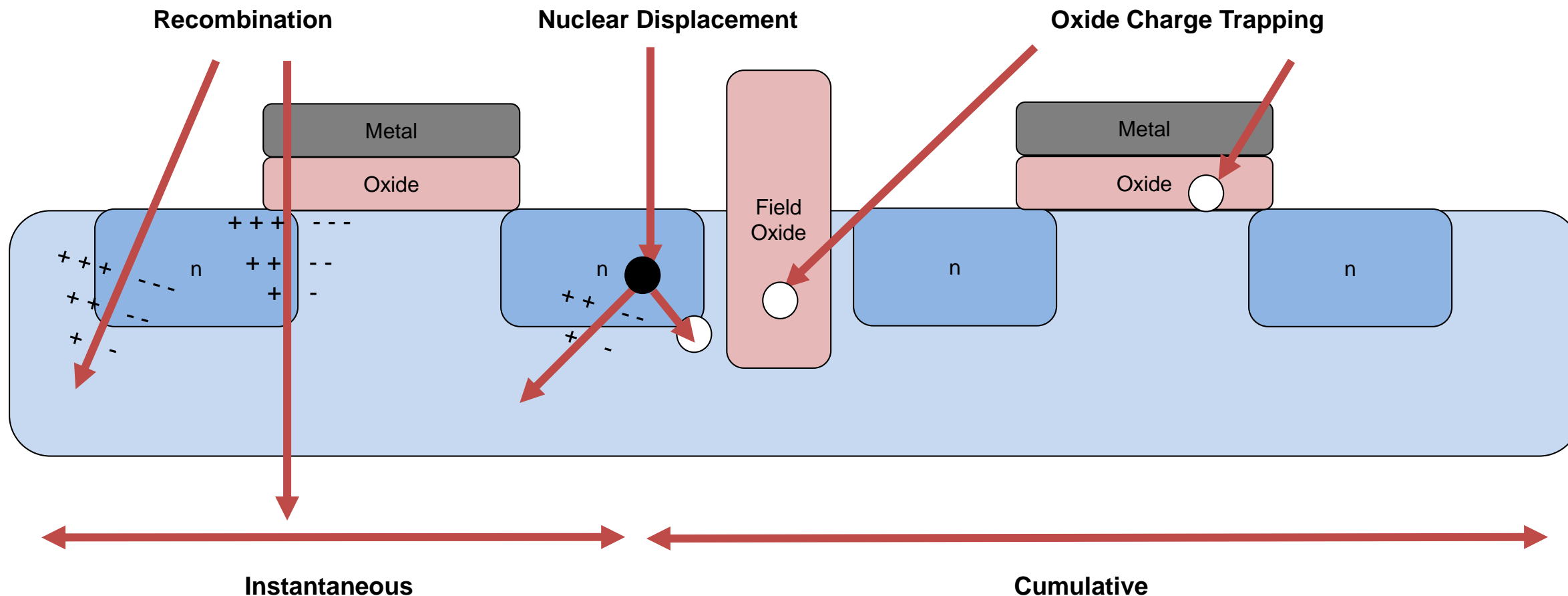

Brock J. LaMeres, Colin Delaney, Matt Johnson, Connor Julien, Kevin Zack, Ben Cunningham Todd Kaiser, Larry Springer, David Klumpar, "Next on the Pad: RadSat – A Radiation Tolerant Computer System," Proceedings of the 31<sup>st</sup> Annual AIAA/USU Conference on Small Satellites, Logan UT, USA, Aug. 5-10, 2017, paper: SSC17-III-11, URL: <http://digitalcommons.usu.edu/cgi/viewcontent.cgi?article=3618&context=smallsat>



# Table of SEE Susceptibility

SEL	SEGR	SEB	SEDR	Stuck Bit	SEU/MCU	SET	SEFI
CMOS	MOSFET	POWER MOSFET	One-time Prog. FPGA	SRAM	Digital/bistable technologies	bipolar technology	Complex Microcircuits
Bipolar?	FLASH	Power JFET	Bipolar Microcircuits	DRAM	Deep submicron CMOS more MCU susceptible	Analog microcircuit	ADCs
	Schottky Diode	Power BJT		FLASH		Digital microcircuit	PWMs

## Part-Level Consequences

- Catastrophic failure possible
- Destructive but limited
- Nondestructive

## How Common is Issue?

- Common in technology
- Catastrophic failure possible
- Not seen but possible in principle

Ray Ladbury, <https://ntrs.nasa.gov/archive/nasa/casi.ntrs.nasa.gov/20170006865.pdf>

**List is not exhaustive, but new failure modes are found in new devices, so it would not be possible to capture all**

# Outline

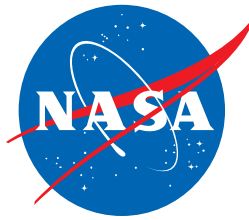

- New Space and SmallSat Considerations
- The Natural Space Radiation Environment Hazard
- Radiation Effects on Micro-Electronics
- **Hardness Assurance, as a Discipline, with its Challenges**
  - **New Technologies**
  - **New Architectures**
  - **Unbound Risks**
- **Building Smart Requirements**
- **Risk Acceptance and Guidance**



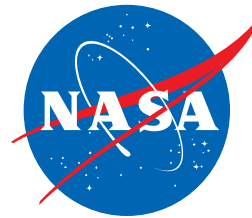

# The Job: Watch For the 'ilities

## Survivability

- Must survive until needed
- Entire mission?
- Screening for early failures in components

## Availability

- Must perform when necessary
- Subset of time on orbit
- Operational modes
- Environmental response

## Criticality

- Impact to the system
- Part or subsystem function
- Mission objectives

## Reliability

- Resultant of all
- Many aspects and disciplines
- Known unknowns

# The People: Radiation Effects Engineers

## Materials

- Material Property degradations with radiation
- Energy loss in materials

## Device Physics

- Charge transport
- Device Process Dependencies
- Charge dependency of device operation

## Electrical Engineering

- Part to part interconnections
- Understanding circuit response
- Device functions and taxonomy

## Systems Engineering

- Requirements
- System Level Impacts
- Understanding interconnections
- Understanding functionality

## Space Physics

- Space weather
- Environment models/modeling
- Radiation Sources and variability

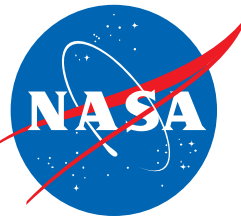

# Paths to Space Radiation

## Space Radiation Ecosystem

Systems  
Engineering  
Background

- Radiation Reqs. Definition
- SPENVIS, OMERE, Fastrad, etc.
- Radiation Testing Management

Device Physics /  
Electrical Engineering  
Background

- Radiation Testing + Qualification
- EEE Parts Programs

Space Weather  
Physics  
Background

- Mission Scientists / PIs
- Model Developers (e.g. AP9/AE9)
- Often University + Research Lab based

*After Whitney Lohmeyer, presented at JPL meeting 2019*

# Radiation Hardness Assurance (RHA) Overview

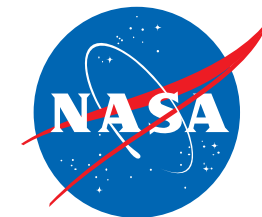

RHA consists of all activities undertaken to ensure that the electronics and materials of a space system perform to their *design* specifications throughout exposure to the mission space environment

(After Poivey 2007)

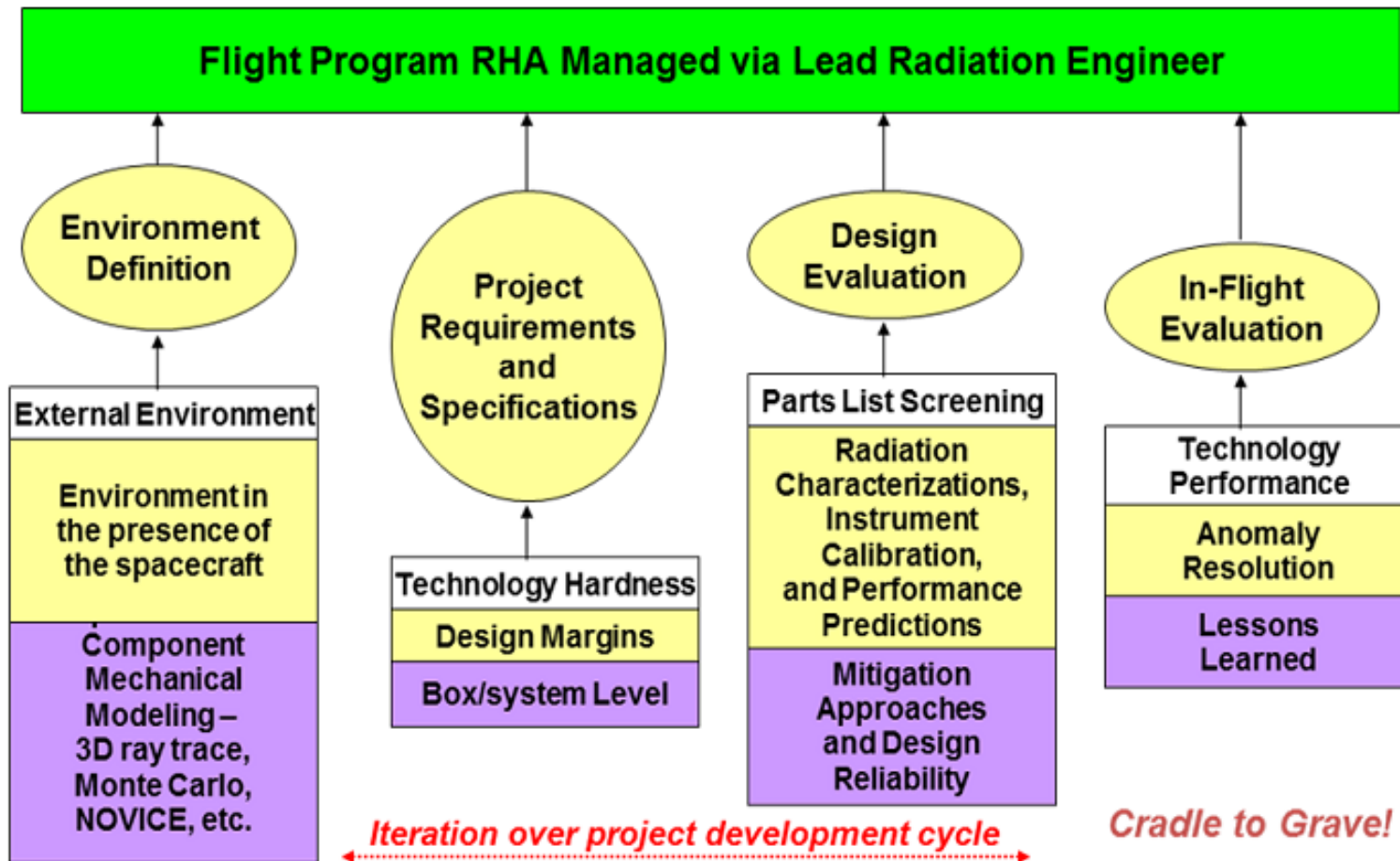

(After LaBel 2004)

# RHA Challenges... Not So Small

- Always in a **dynamic** environment
- **New Technologies**
  - Device Topology / Speed / Power
  - Increased COTS parts / subsystem usage
- **New Mission Architectures**
  - Profiles of mission life, objective, and cost are evolving
  - Oversight gives way to insight in some mission classifications
  - Ground systems, do no harm, hosted payloads
  - Similarity and heritage data requirements widening
- **Quantifying Risk**
  - Translation of system requirements to radiation trades can be problematic
  - Determining appropriate mitigation level (operational, system, circuit/software, device, material, etc.)

***Unbound radiation risks are likely***

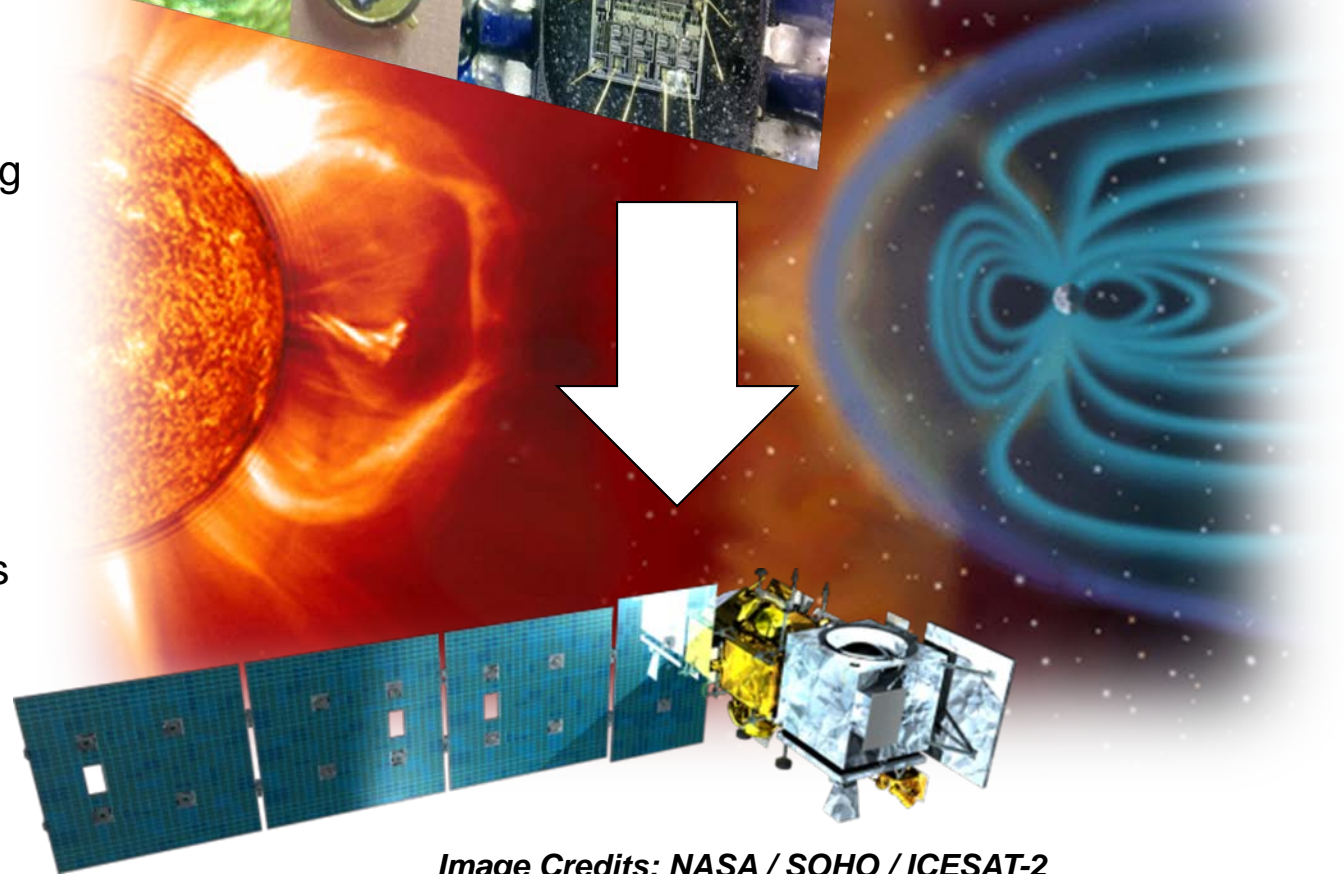
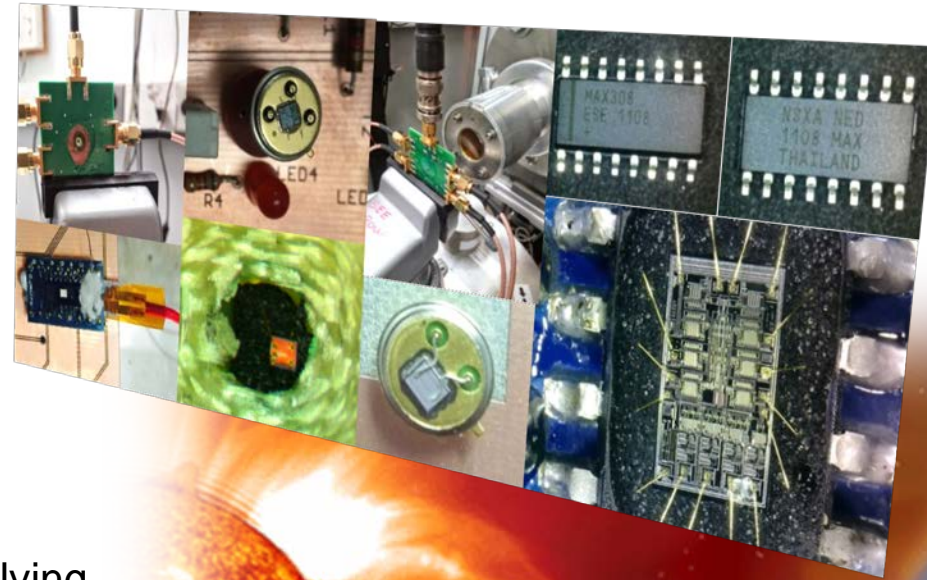

**Image Credits: NASA / SOHO / ICESAT-2**



# New Technologies - New Susceptibilities

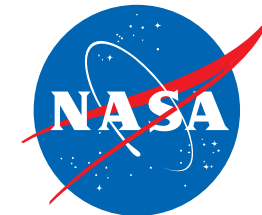

- **Feature Size / Critical Charge**
  - Sensitivity to muons? Low energy protons?
- **3D Stacking / Structures**
  - Deep sensitive volumes
  - New materials within structure
- **Testing Challenges**
  - Complexity (e.g., Systems-on-a-Chip)
    - Speed of interfaces
    - Obfuscation of state-space
  - Flux / range of beam at facilities
- **Function**
  - Integrated Photonics, MEMS, Hybrids

***Without detailed part information you do not have certainty of the radiation threats***

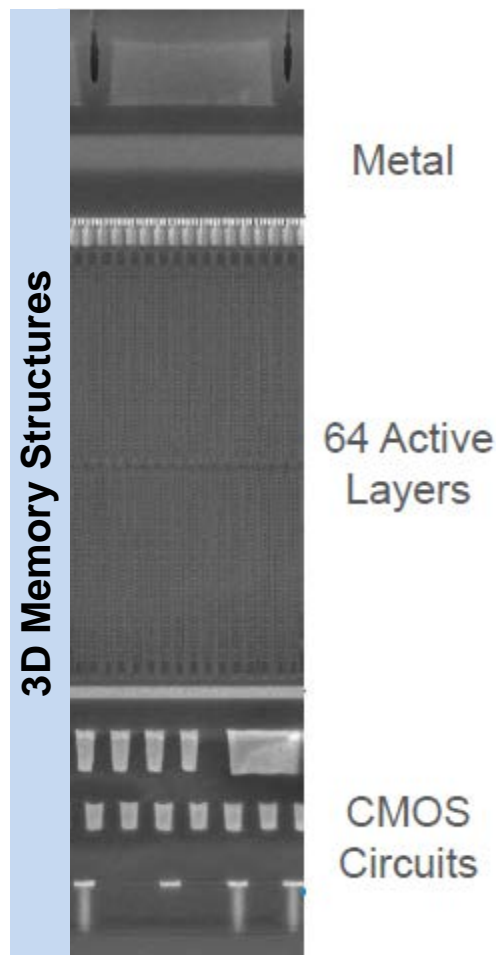

[www.micron.com](http://www.micron.com)

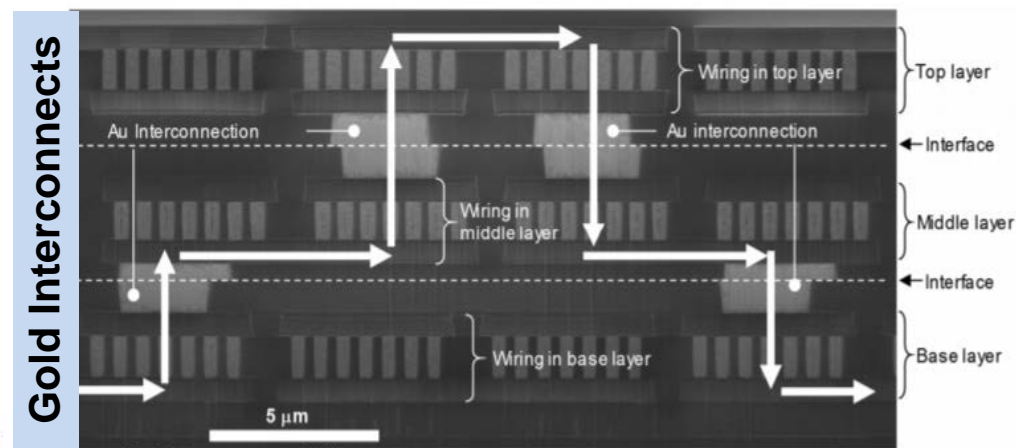

IEEE/DOI: [10.1109/TCPMT.2019.2910863](https://doi.org/10.1109/TCPMT.2019.2910863)

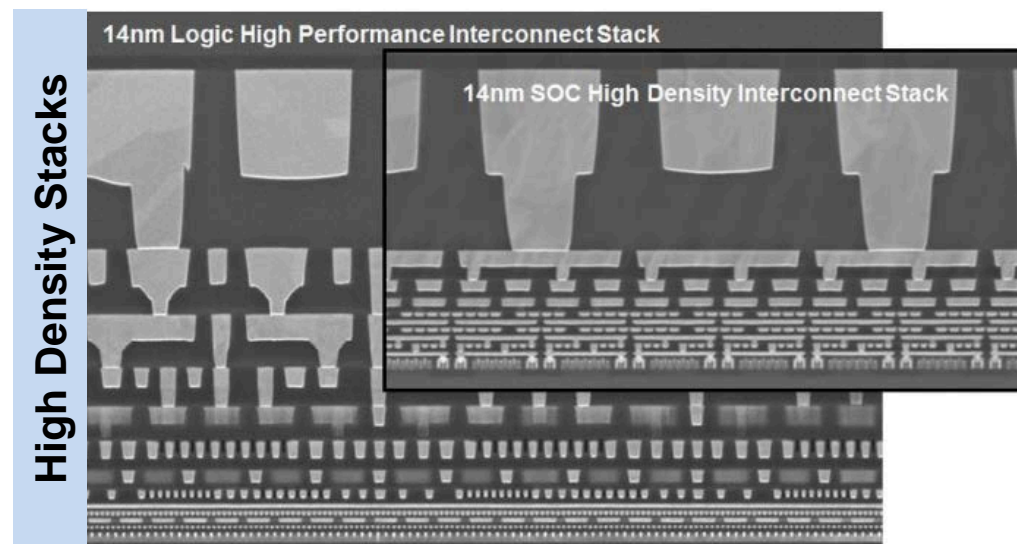

IEEE/DOI: [10.1109/IITC-AMC.2016.7507637](https://doi.org/10.1109/IITC-AMC.2016.7507637)

# New Mission Architectures - How Many to Succeed?

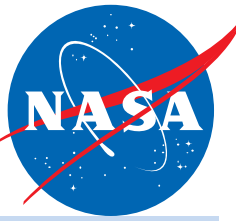

## Single Strain

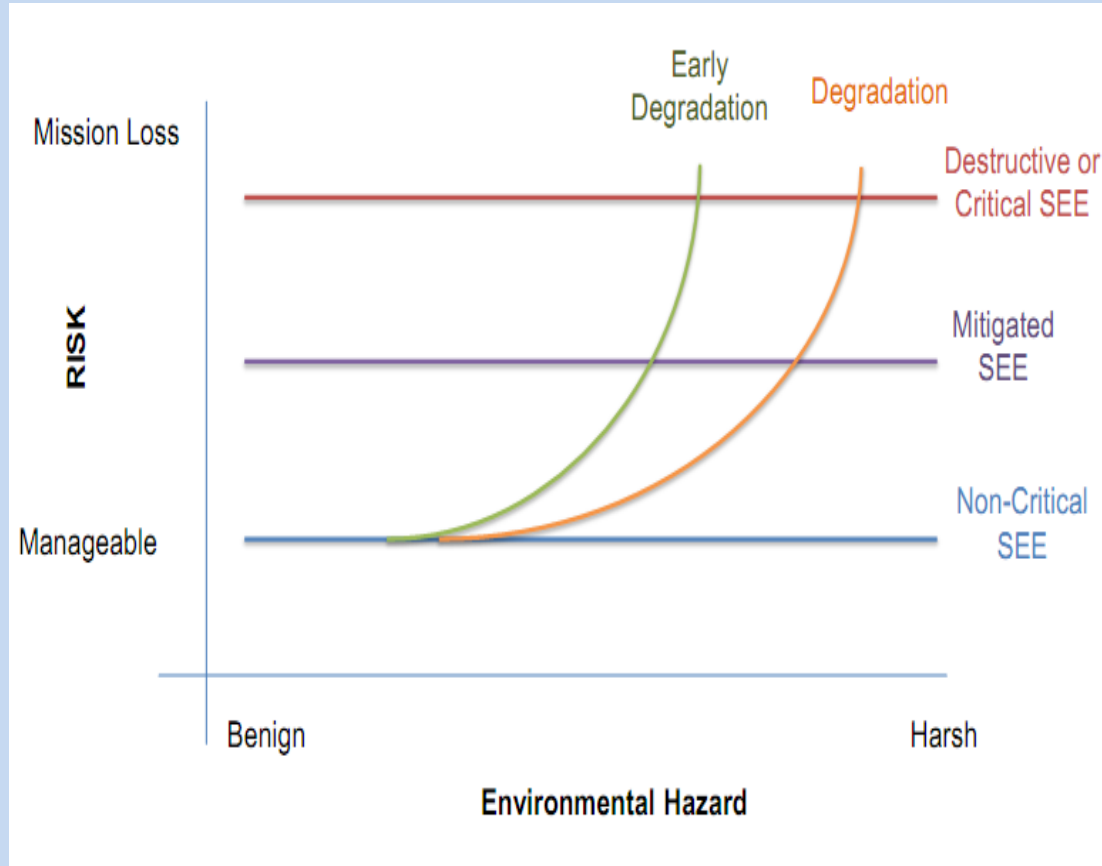

VS

## Allowable Losses

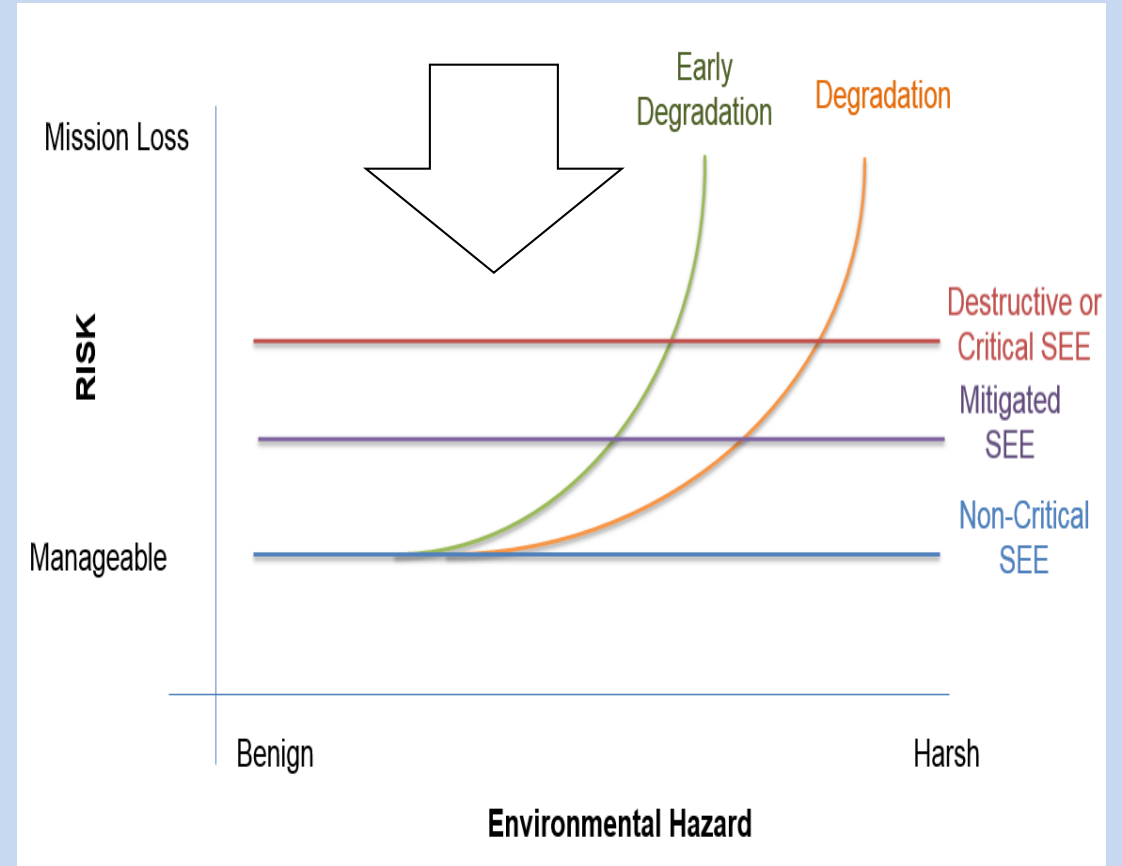

**Redundancy alone does not remove the threat, adds complexity**



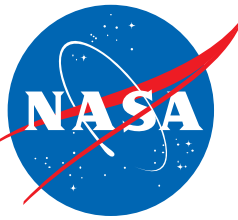

# New Challenges in Quantifying Risk

*From Risk Assessment section of NASA Program Management 7120.5*

Likelihood	Safety Estimated likelihood of Safety event occurrence	Technical Estimated likelihood of not meeting performance requirements	Cost Schedule Estimated likelihood of not meeting cost or schedule commitment
5 Very High	$(P_{SE} > 10^{-1})$	$(P_T > 50\%)$	$(P_{CS} > 75\%)$
4 High	$(10^{-2} < P_{SE} \leq 10^{-1})$	$(25\% < P_T \leq 50\%)$	$(50\% < P_{CS} \leq 75\%)$
3 Moderate	$(10^{-3} < P_{SE} \leq 10^{-2})$	$(15\% < P_T \leq 25\%)$	$(25\% < P_{CS} \leq 50\%)$
2 Low	$(10^{-5} < P_{SE} \leq 10^{-3})$	$(2\% < P_T \leq 15\%)$	$(10\% < P_{CS} \leq 25\%)$
1 Very Low	$(10^{-6} < P_{SE} \leq 10^{-5})$	$(0.1\% < P_T \leq 2\%)$	$(2\% < P_{CS} \leq 10\%)$

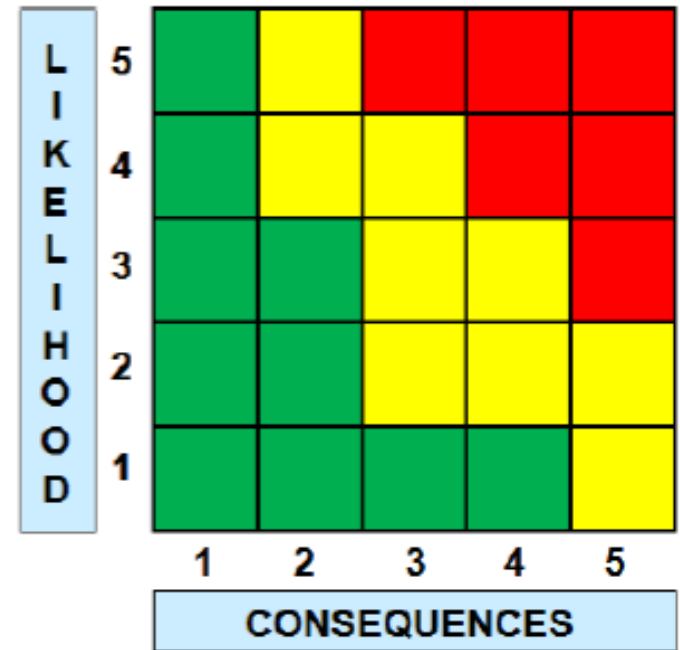

*Can only get there with enough information about the system or the chosen device, need to have a known hazard and a known response*

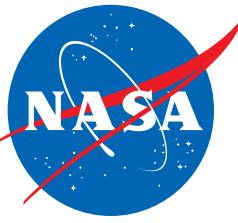

# RHA Building Blocks

## *Define and Evaluate the Hazard*

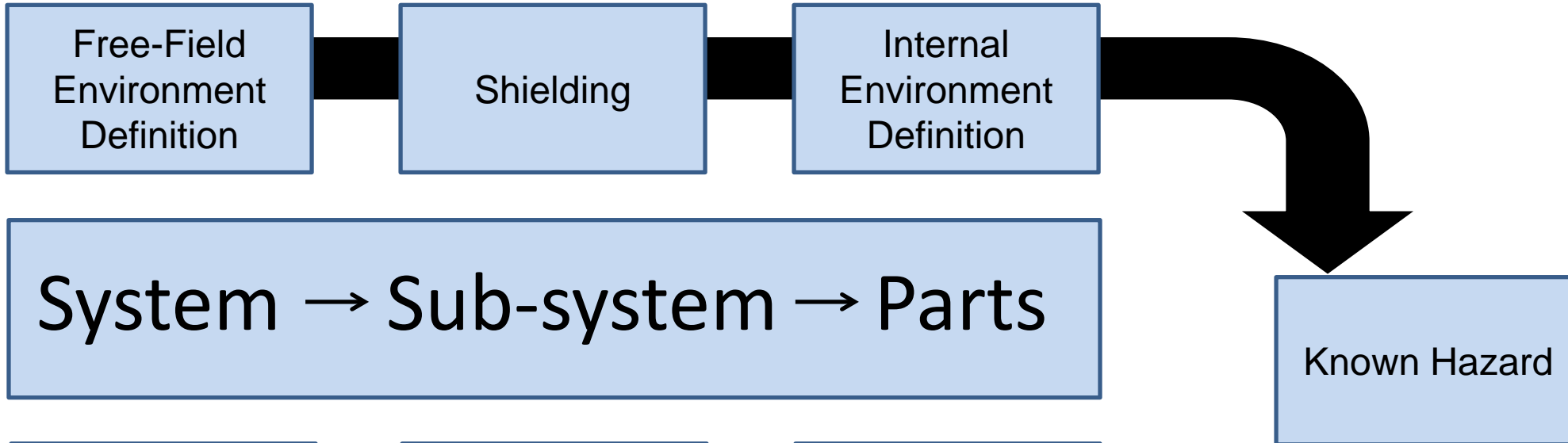

## *Derive Smart Requirements*

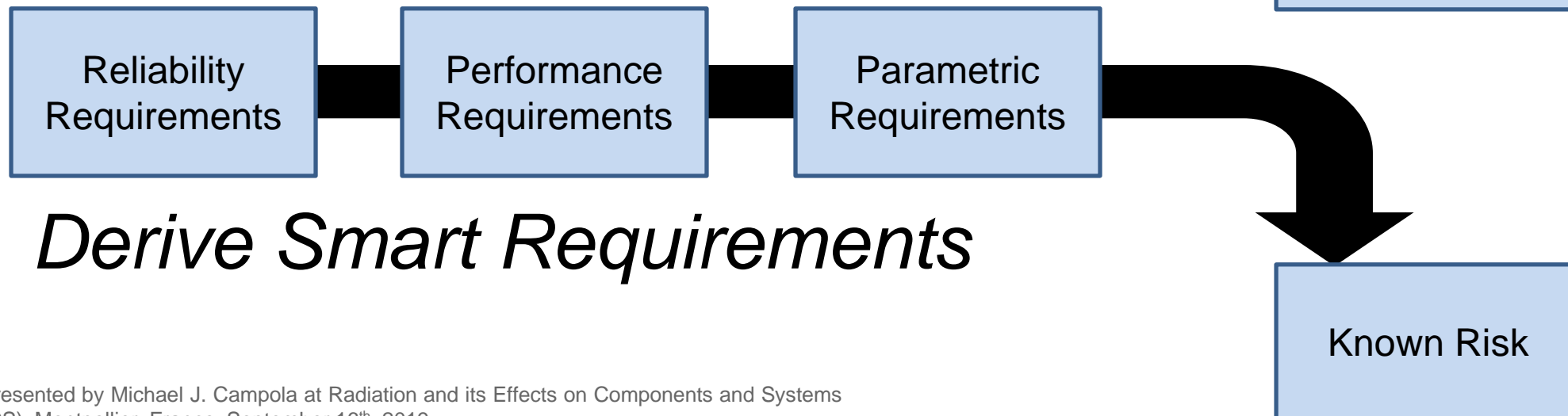

# Risks Abound, What is Critical?

- **Parts**
  - Parametric degradation and leakage currents allowable in application?
  - Downstream/peripheral circuits considered?
  - Reset/refresh capability?
  - Mitigation within too complex?
  - Predicted radiation response unknown– loss of part functionality critical?
- **Subsystem**
  - Functionally required to mission that the subsystem work?
  - Interfaces allow you to get to a known state if all goes wrong?
- **System**
  - Increased power dissipation a mission ender?
  - Availability outweighed by error circumvention?
  - Data retention through reboots? What if there is science data loss?
  - Communications interruptions overwhelm?
  - Navigation or Attitude determination unable to deal with faults?

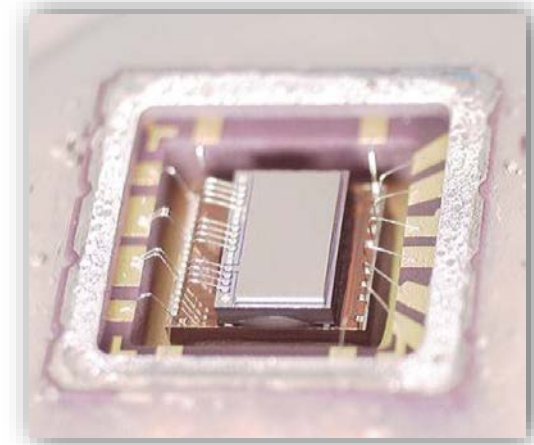

**VS.**



# RHA Flow Doesn't Change With Accepted Risk

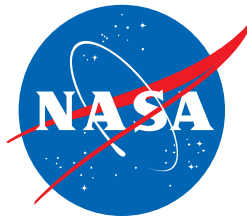

- **Hardness Assurance is the practice of designing for radiation effects**
- **What it takes to overcome the radiation challenges**
- **Competing failure modes**

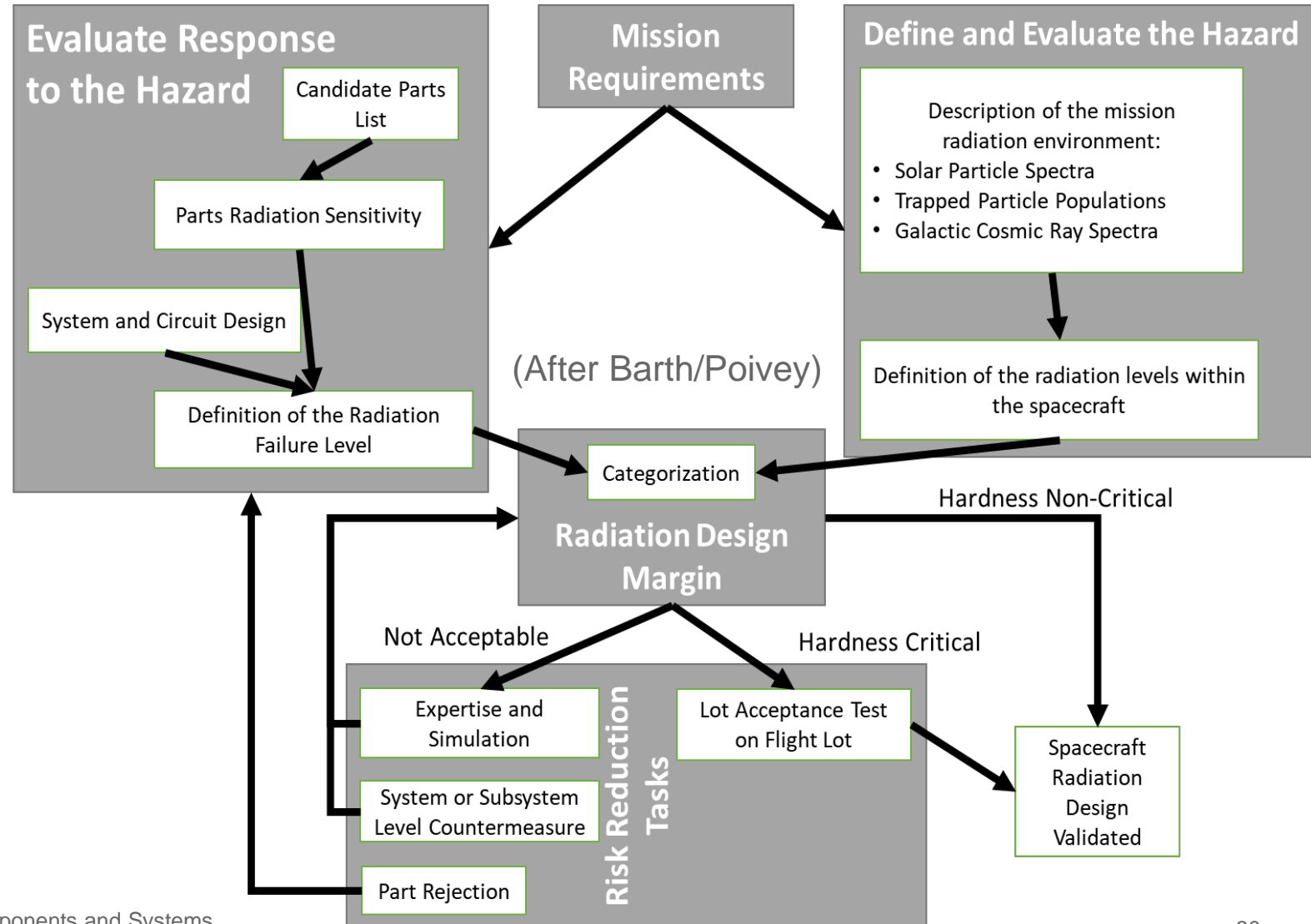

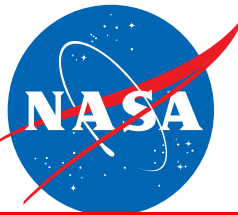

# RHA Flow Doesn't Change With Accepted Risk

- **Hardness Assurance is the practice of designing for radiation effects**
- **What it takes to overcome the radiation challenges**
- **Competing failure modes**
- **Focus for impact on risk acceptance:**

- Failure Awareness
- Countermeasures/Mitigation
- Mission Requirements

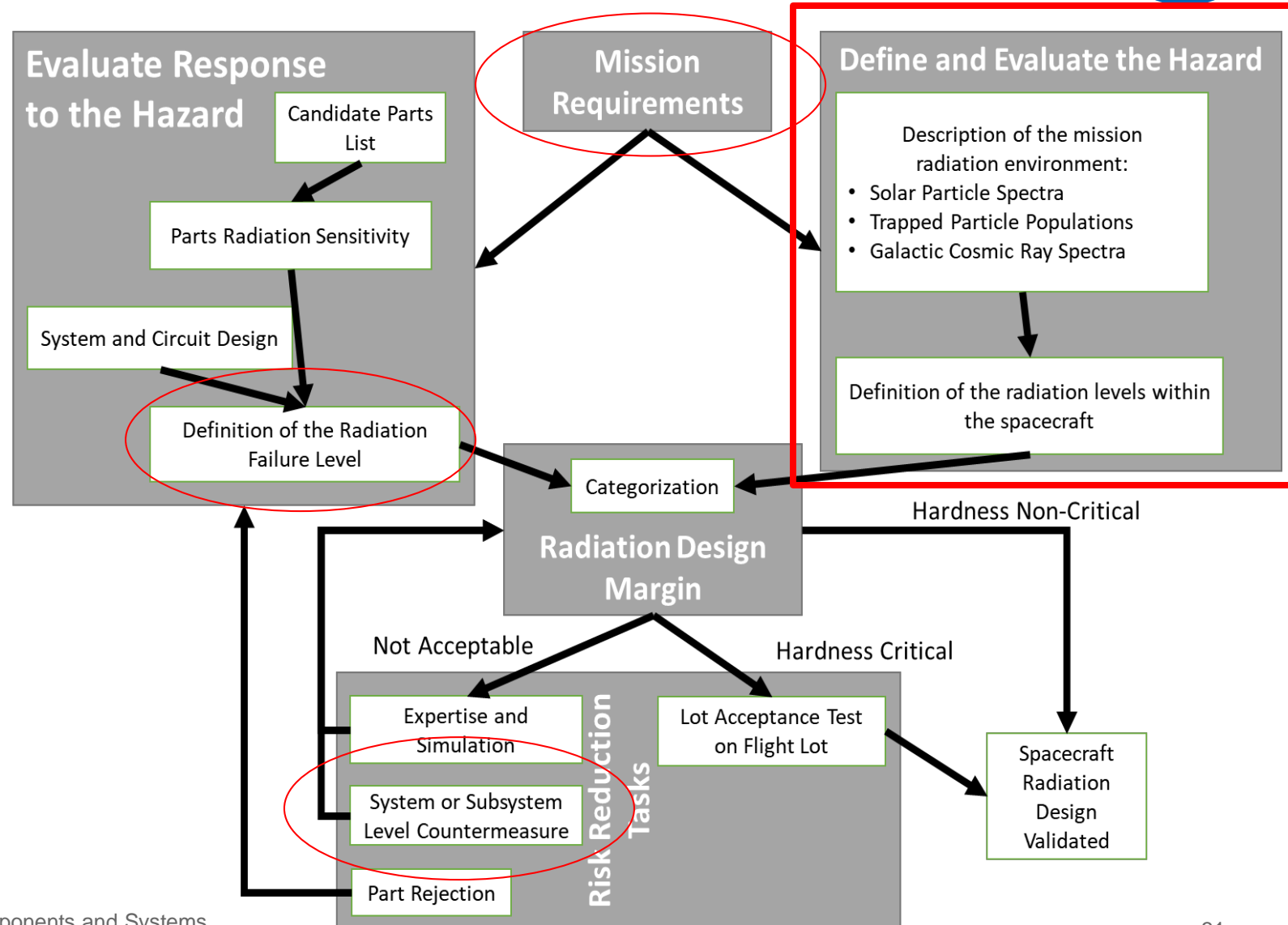

# Focus For Risk Acceptance

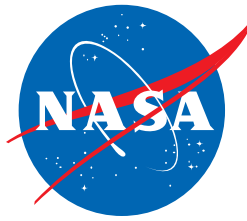

- **Failure Awareness**
  - Know your hazard from the natural environment
  - Know your devices potential failure mechanisms or response (data)
- **Countermeasures and Mitigation**
  - Where are they necessary?
  - At what level (part, card, box, mission)
- **Smart Requirements – and Eventually Smart Trades**



# Define and Evaluate the Hazard



## Environment Severity/Mission Lifetime

		Low	Medium	High
Criticality/Availability	High	Manageable Dose / SEE impact to survivability or availability	Moderate Dose / SEE impact to survivability or availability	High Dose / SEE impact to survivability or availability
	Medium	Manageable Dose / SEE needs mitigation	Moderate Dose / SEE needs mitigation	High Dose / SEE needs mitigation
	Low	Manageable Dose / SEE do no harm	Moderate Dose / SEE do no harm	High Dose / SEE do no harm

- **Define the Environment**
  - External to the spacecraft
- **Evaluate the Environment**
  - Internal to the spacecraft
- **Define the Requirements**
  - Define criticality factors
- **Evaluate Design/Components**
  - Existing data/Testing
  - Performance characteristics
- **“Engineer” with Designers**
  - Parts replacement/Mitigation schemes
- **Iterate Process**
  - Review parts list based on updated knowledge

# Derive Smart Requirements

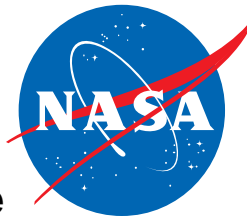

- **Define the Environment**
  - External to the spacecraft
- **Evaluate the Environment**
  - Internal to the spacecraft
- **Define the Requirements**
  - Define criticality factors
- **Evaluate Design/Components**
  - Existing data/Testing
  - Performance characteristics
- **“Engineer” with Designers**
  - Parts replacement/Mitigation schemes
- **Iterate Process**
  - Review parts list based on updated knowledge

Environment Severity/Mission Lifetime

		Low	Medium	High
Criticality/Availability	High	Dose-Depth / Ray-trace GCR and Proton Spectra for typical conditions	Dose-Depth / Ray-trace GCR and proton Spectra for all conditions	Ray-Trace for subsystem / GCR and proton Spectra for all conditions
	Medium	Dose-Depth / GCR and proton spectra for background	Dose-Depth / GCR and Proton Spectra For background	Dose-Depth evaluation at shielding / All spectra conditions
	Low	Similar mission dose, same solar cycle / GCR spectra	Dose-Depth / GCR spectra	Dose-Depth / GCR and Proton Spectra For background

# Mitigation and Countermeasure Optimization

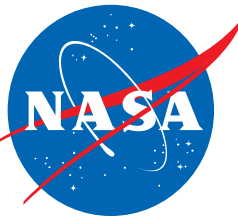

- **Define the Environment**
  - External to the spacecraft
- **Evaluate the Environment**
  - Internal to the spacecraft
- **Define the Requirements**
  - Define criticality factors
- **Evaluate Design/Components**
  - Existing data/Testing
  - Performance characteristics
- **“Engineer” with Designers**
  - Parts replacement/Mitigation schemes
- **Iterate Process**
  - Review parts list based on updated knowledge

## Degradation

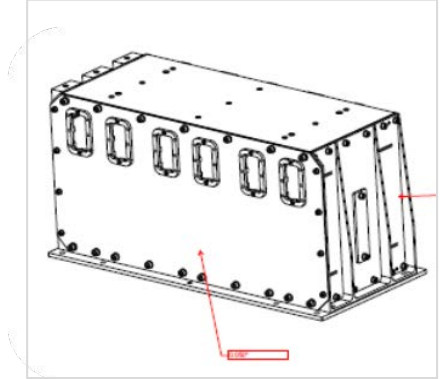
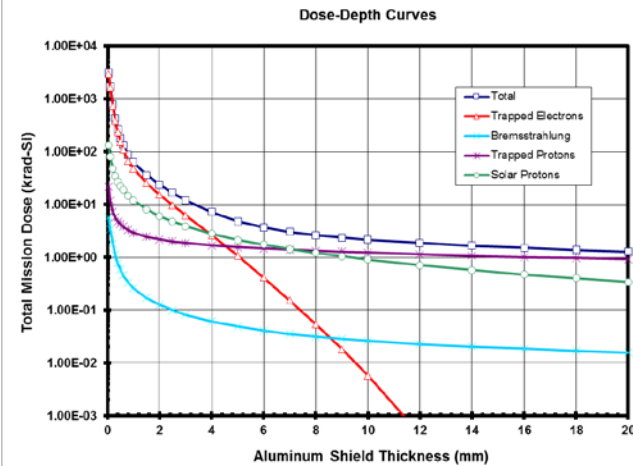

## Single Event

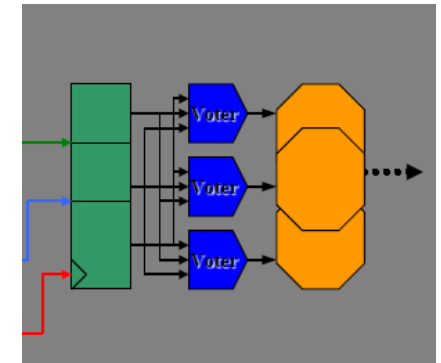
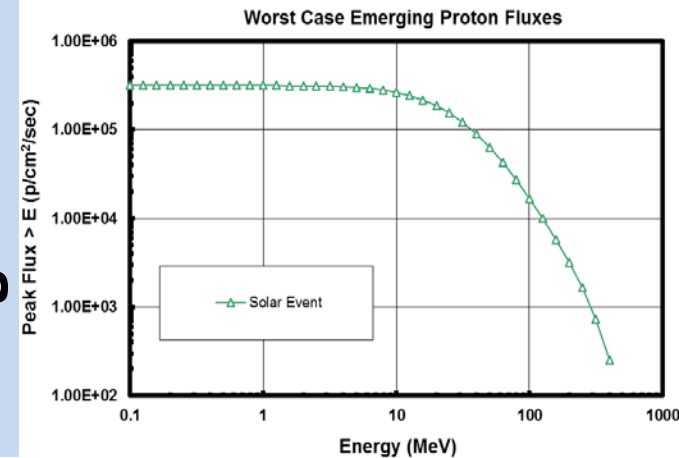

K.A. LaBel, A.H. Johnston, J.L. Barth, R.A. Reed, C.E. Barnes, “Emerging Radiation Hardness Assurance (RHA) issues: A NASA approach for space flight programs,” *IEEE Trans. Nucl. Sci.*, pp. 2727-2736, Dec. 1998.

# Building Requirements

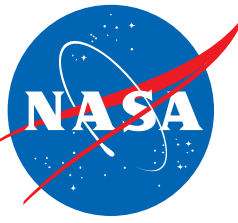

- **Requirements by Environment**
- **Requirements by Technology**
- **Additional Considerations**
  - **LET Requirements for SEE**
  - **Dose Calculation**
  - **Operation During Flare Conditions**
  - **Radiation Data**

# Requirements by Environment

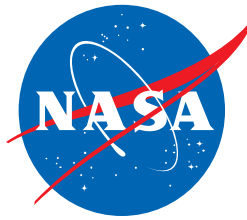

- **Trapped Radiation Belts**

- Can lead to high doses in a short mission:  
Jovian
- Can lead to spatially dependent SEE responses: South Atlantic Anomaly (SAA)

- **Heliocentric Orbits**

- Solar Events, highly dynamic, energetic, directional
- Solar Wind, will depend on the solar cycle
- No planetary magnetic field attenuation

***In essence the requirements are always driven by the environment, some more than others create a unique challenge***

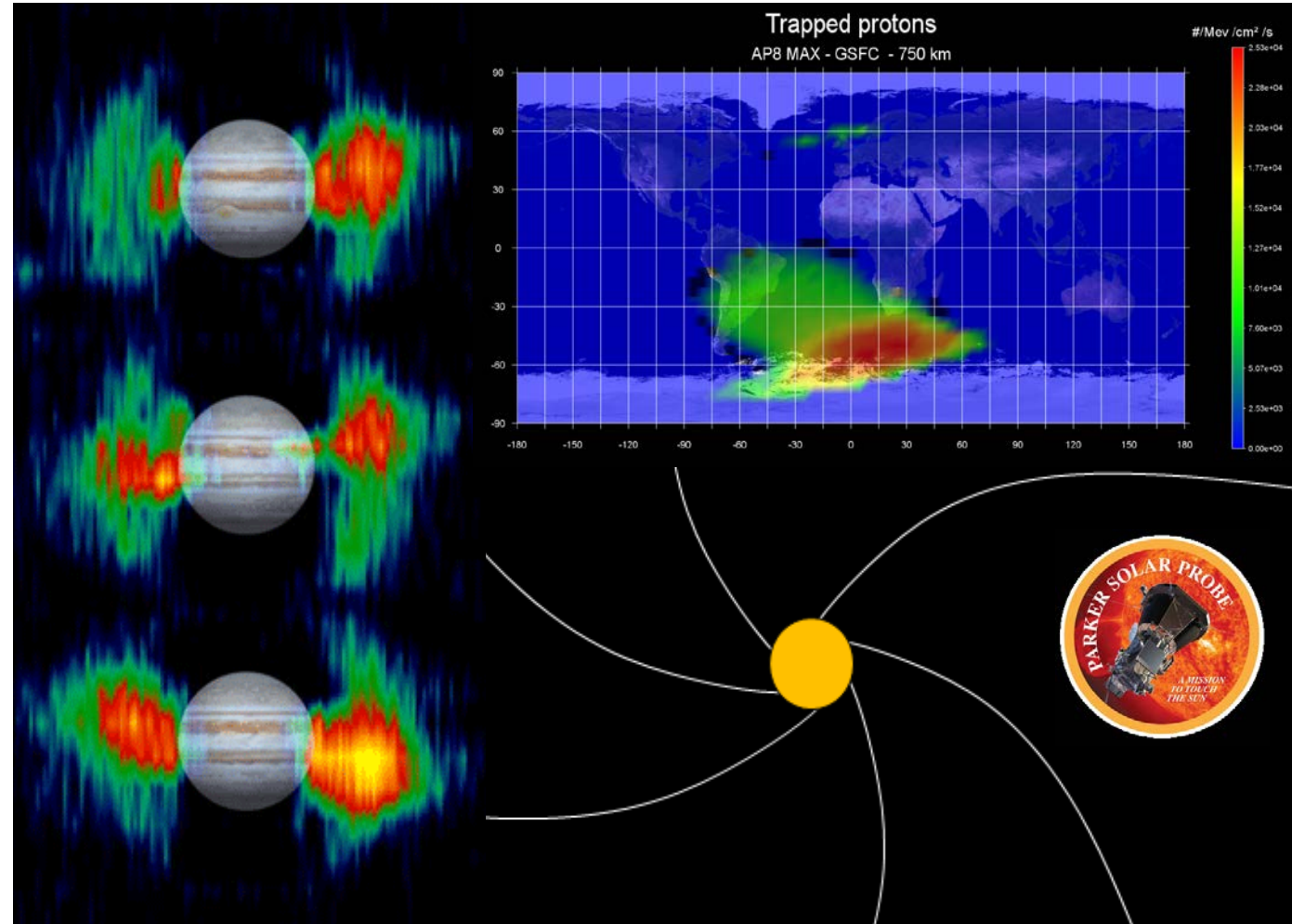

NASA JPL Cassini, <http://saturn.jpl.nasa.gov>,  
Output from OMERE freeware <http://www.trad.fr/en/space/omere-software/>



# Requirements by Technology

- **Technologies exhibit specific physics of failure**

- Not easy to group them all
- Opto-electronics - Displacement in the material
- Bipolar - Enhanced Low Dose Rate Sensitivity
- Digital CMOS - Latchup or SEFI
- Power devices - SEGR/SEB
- Analog/Mixed-Signal – Interruptions on PLLs, SERDES, clock dividers, etc.

- **Test Data requirements**

- Failure distributions, often not enough parts
- Destructive effects are one data point, variability from part to part
- Statistics of the fit for rate calculations

**Requirements should only be made applicable to the technologies that need to meet mission objectives and can benefit**

R. Zuleeg, "Radiation Effects In GaAs FET Devices," Proc. IEEE, Vol. 77, p.389, 1989.

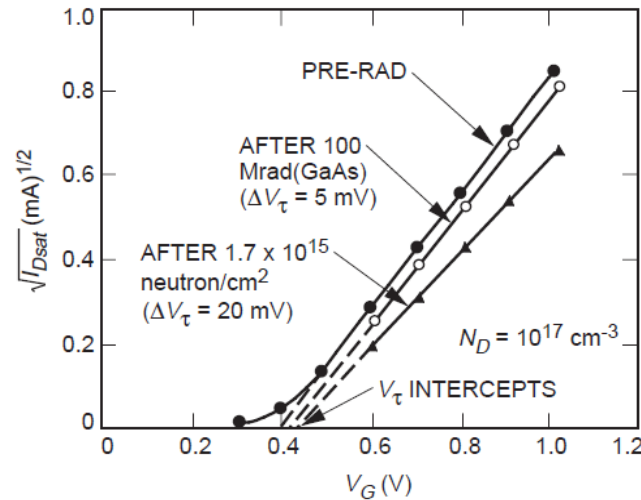

$I_{B+}$  vs. Total Dose for LM111 Voltage Comparators

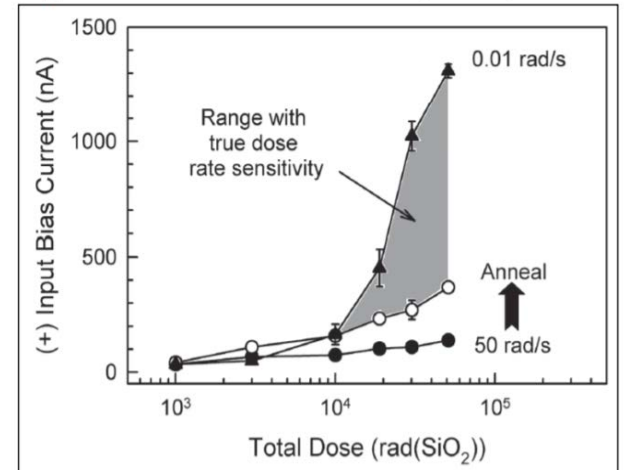

M. R. Shaneyfelt, et al., IEEE TNS, 2000.

D. Chen, test report nepp.nasa.gov, 2016

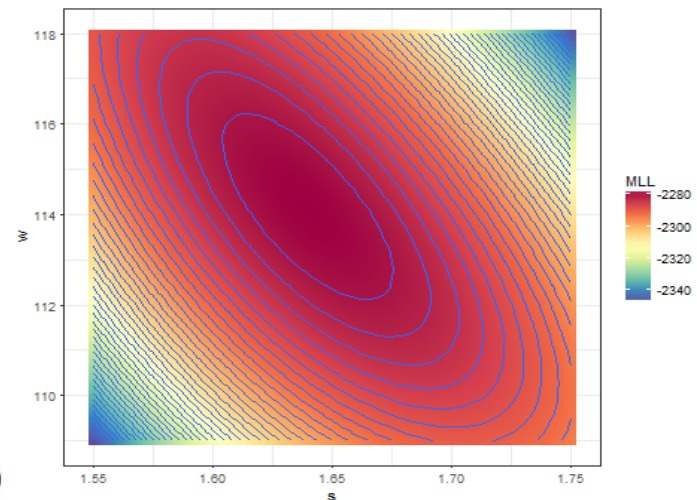
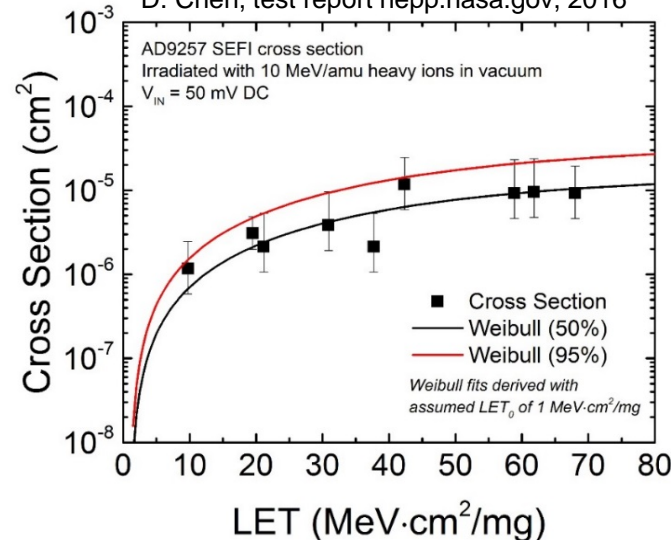



# Considerations for SEE Requirements

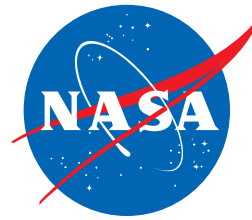

- **SEL**
  - Environment and technology driven, risk avoidance
  - Protection circuitry / diode deratings
- **SEGR, SEB**
  - Effect driven, normally incident is usually the worst case
  - Testing to establish Safe Operating Area (SOA)
- **SET**
  - Don't harm downstream parts via overvoltage/overstress on I/O, or accumulate over integrations
  - Can be internal - hybrids
- **SEU**
  - Tailored Filtering, EDAC, or Scrubbing
- **MBU, MCU, SEFI, Locked States**
  - Application Voltage or Pattern dependence
  - Watchdogs / reset capability
- **Proton SEE susceptible parts need evaluated in detail:**
  - Low-energy proton effects:
  - May have direct ionization
  - RHA for proton sensitivity update coming:
  - [https://nepp.nasa.gov/files/25401/Proton\\_RHAGuide\\_NASAAug09.pdf](https://nepp.nasa.gov/files/25401/Proton_RHAGuide_NASAAug09.pdf)

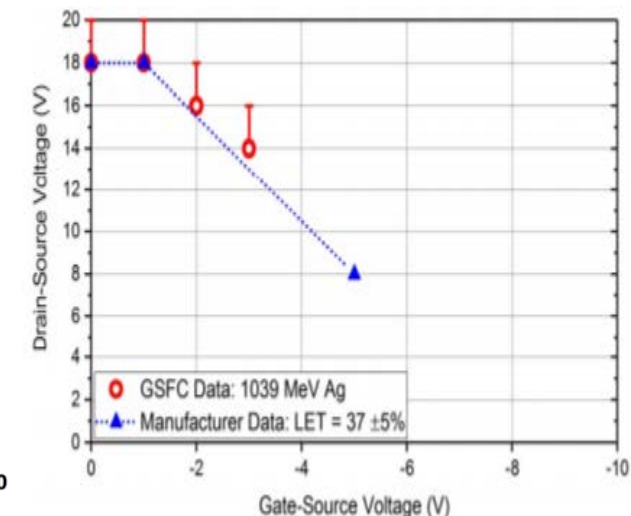
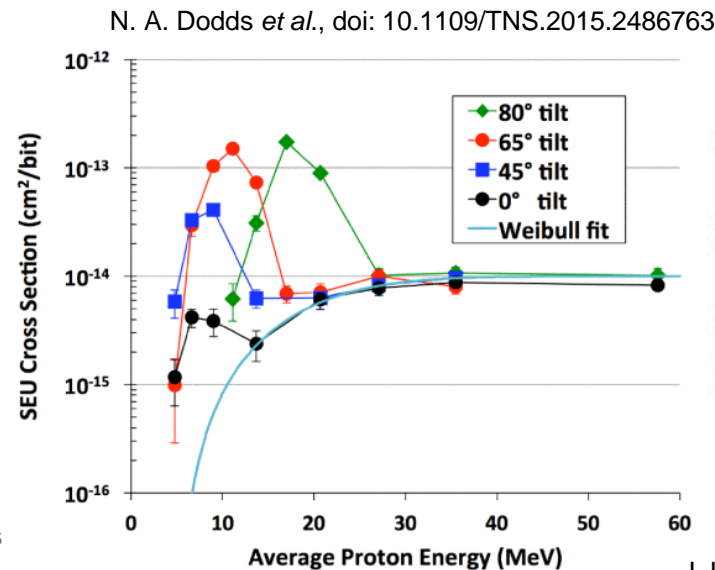
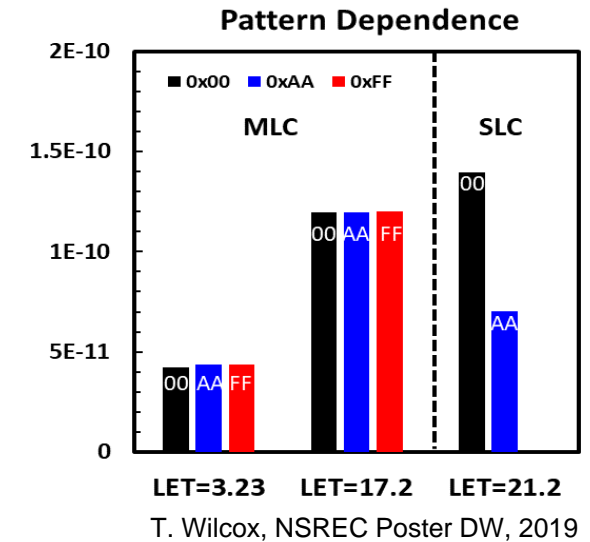
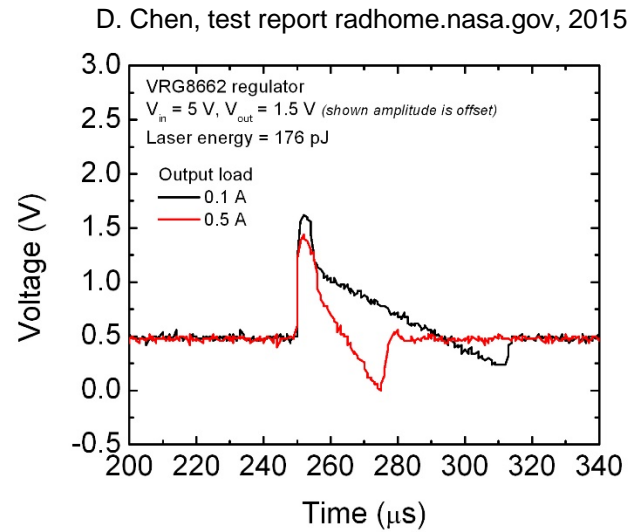

J. Lauenstein *et al.*, doi:10.1109/NSREC.2017.8115473

# Why You Can't Relax an LET Requirement

- **Rate calculations are not the same for Destructive vs. Non-destructive**

- Data are a limiting factor, one part = one data point
- For SEE types that exist in a given technology, they present a constant risk in time domain

- **When you require by LET:**

- Spectrum from environment is imparted on sensitive volumes, where we get LET thresholds (>75 vs. 60 vs. 37 MeV·cm<sup>2</sup>/mg)
- Effective LET increases with angle – critical charge is what we are trying to determine
- CRÈME calculation integrates the two
- Deep sensitive volumes won't necessarily get same LET each time with mono-energetic beams

Rate calculations

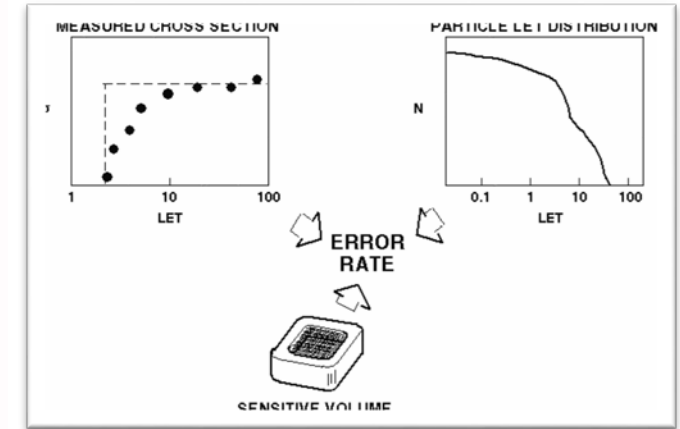
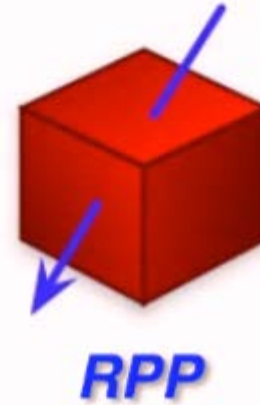

"Space Radiation Effects on Microelectronics," NASA Jet Propulsion Laboratory

Sensitive Volumes

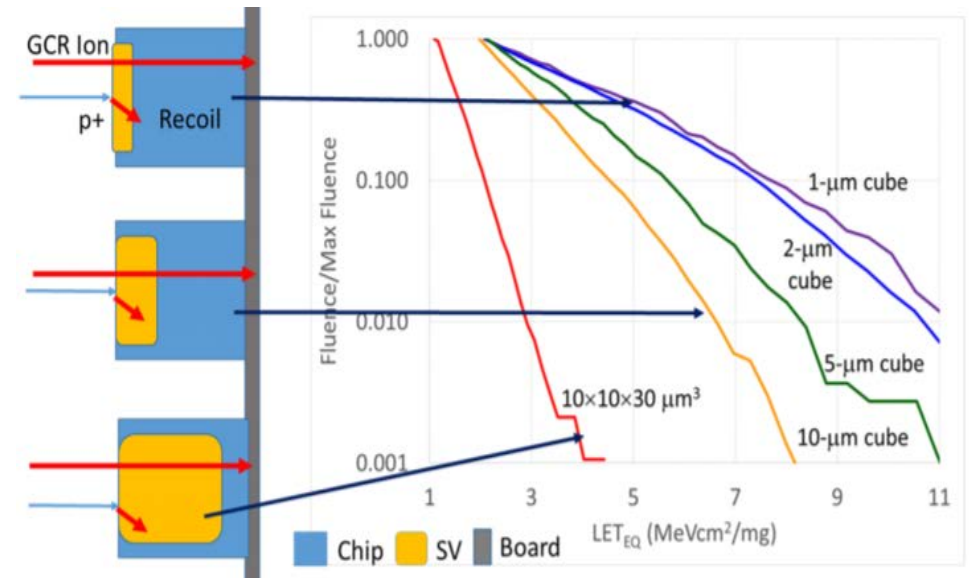

# Appreciable Mission Doses

- Maybe degradation of a part beyond usage is okay?
  - Criticality and Application
- Did you forget about DDD?
  - External materials are susceptible as well, polymers can be bad actors and are often on commercial ground based optical systems
- Even short missions can have a common failure mode
- Low mass budget?
  - Can optimize shielding if you have failure distribution of intended components

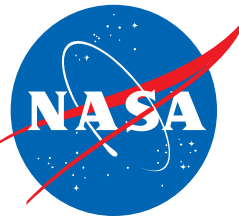

Non-Ionizing Energy Loss – Displacement Damage Dose

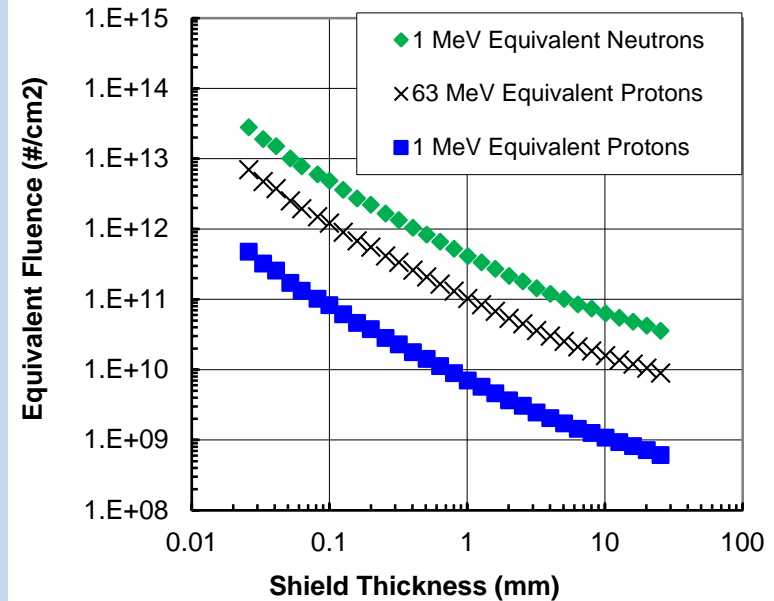

Shielding Optimization

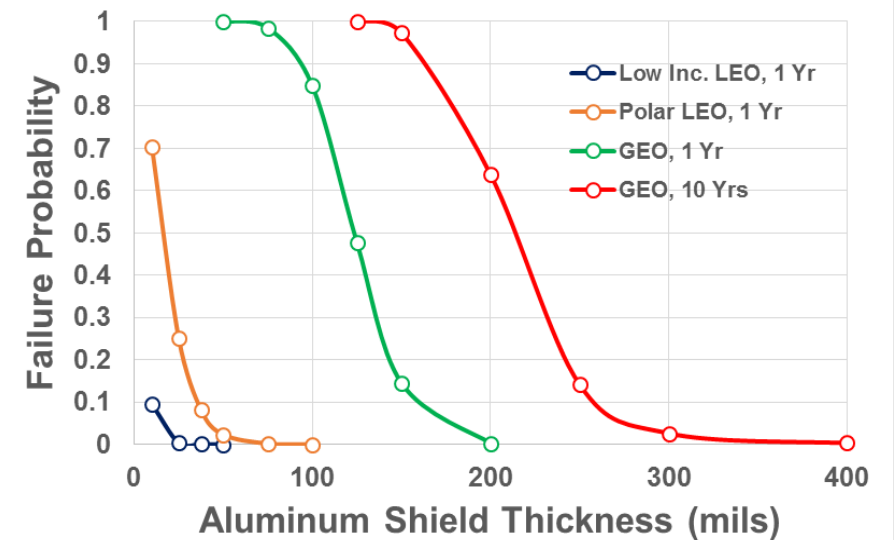

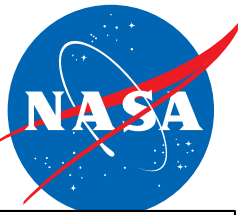

# Operation During Flare Conditions: Think Availability

- **Don't dose out during storm (nor the full mission)**
  - Calculate the dose (TID/TNID) of the mission in full –  
95% confidence level recommended
  - Calculate the dose contribution from N number of events (protons & x-rays), if dose from N is > 5% of the total dose, increase confidence level of full mission model
- **Don't destructively fail from a single particle during the storm (nor the full mission)**
  - Standard risk-avoidant SEE approach: no destructive effects allowed
  - LET threshold for single event latchup (SEL)  
> 75 MeV.cm<sup>2</sup>/mg (some use 60 MeV.cm<sup>2</sup>/mg)
  - LET threshold for single event burnout, gate rupture, dielectric rupture (SEB, SEGR)  
> 37 MeV.cm<sup>2</sup>/mg (particles must come from normal incidence to cause effect)
- **If you have non-destructive single event upsets, they can't overwhelm critical instruments/systems during the storm**
  - Rate calculation requires part data representative of the application, looking for cross-section over LET.
  - If parts' LET threshold from 20 to 75 MeV.cm<sup>2</sup>/mg, need heavy ion rate
  - If parts' LET threshold is below 20, need indirect ionization from recoil ions contribution to rate (need proton data) – make sure packaging materials don't add to this, direct ionization from protons (can be built-in to heavy ion calculation) possible
  - Do you need to mitigate or not – confirm that event rates are not higher than mitigation (Markov process... i.e. EDAC beats the number accrued, scrub rate is faster than critical number of upset accumulation)

Many Solar Models

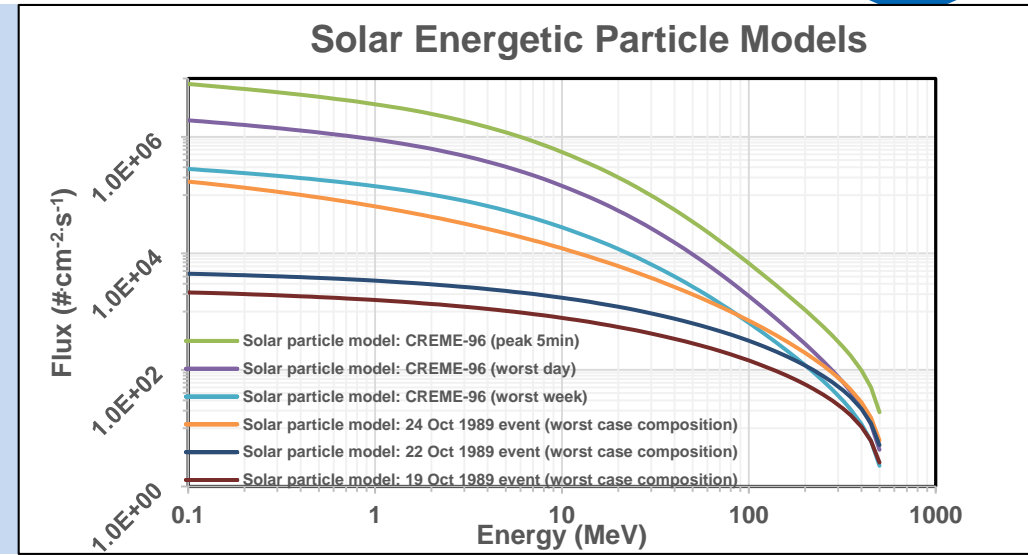

Spectrum Translates to LET

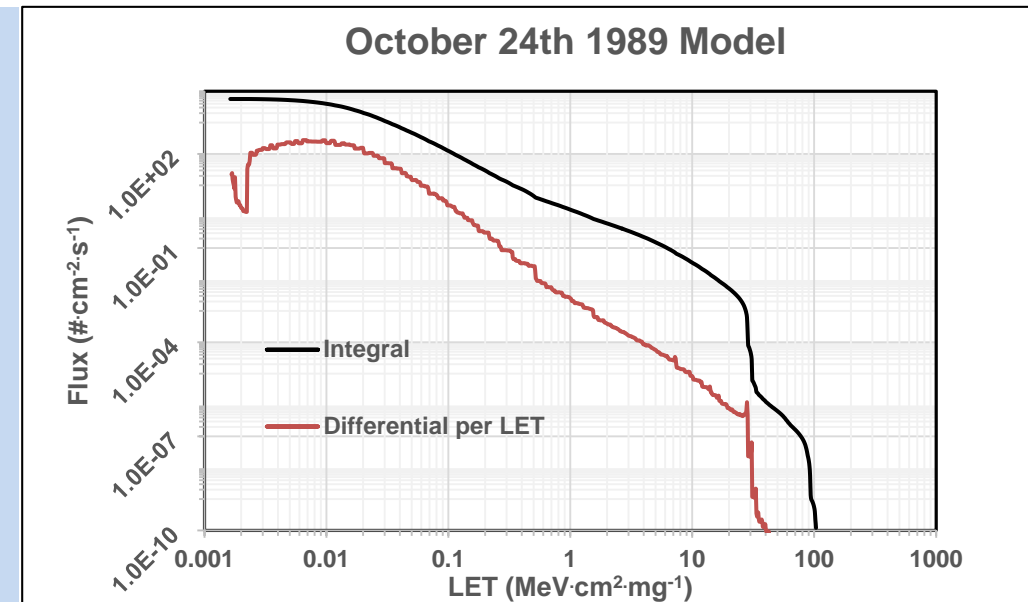

# Risk Acceptance – Data Available?

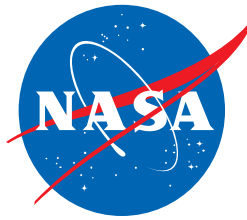

- **Part Classifications Growing**
  - Mil/Aero vs. Industrial vs. Medical
  - Automotive vs. Commercial vs. Modified HiRel
- **Substitute COTS in this diagram**
  - Now you have another degree of separation
  - Failure modes not fully understood
  - Unlikely to have historical data
  - Similarity data no applicable due to fab, process, or design rules
  - Cost of testing usually too high

***Without traceability you may be depending on non-representative data.***

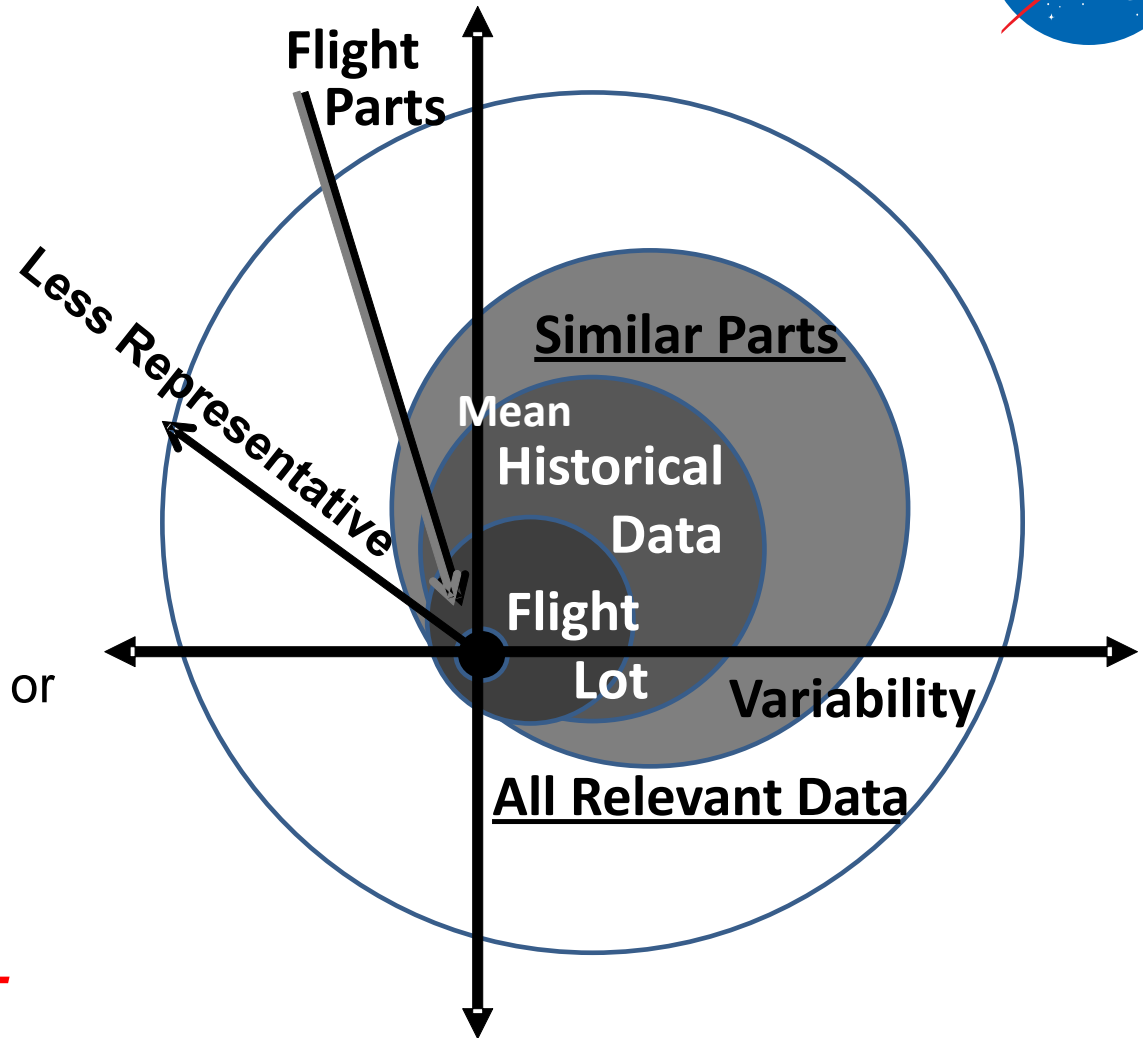

Ray Ladbury, NSREC2017 SC,  
<https://ntrs.nasa.gov/archive/nasa/casi.ntrs.nasa.gov/20170006865.pdf>



# Notional Radiation Data Collection Guidelines

## Environment

		LEO Equatorial	LEO Polar (Sun Sync)	GEO / Interplanetary
Mission Lifetime (With Assumed Risk Acceptance)	> 3 Years	Data on all SEE for critical parts, and have data on dose failure distribution on similar parts	Consider mission consequences of all SEE (Data for critical parts), have Dose failure distribution on lot	Have Data on all SEE, Have Data Dose failure distribution on lot
	1 - 3 Years	Have Data on DSEE for critical parts	Consider mission consequences of all SEE (Data for critical parts), have data Dose failure distribution on similar parts	Have Data on all SEE for critical parts, Have Data on Dose failure distribution on similar parts
	< 1 Year	Look for data on DSEE for critical parts	Consider mission consequences of all SEE, and look for data on dose failure distribution on similar parts	Consider mission consequences of all SEE, and have data on dose failure distribution on similar parts



# When Do You Test? When Do You Model?

- **Divine your risk threshold**
  - There's a doc coming for that...  
[radhome.gsfc.nasa.gov/nepp.nasa.gov](http://radhome.gsfc.nasa.gov/nepp.nasa.gov)
- **Unknown failure modes that would not be acceptable to the mission**
  - Known unknowns can be carried as a risk if you already know that the outcome is mitigated at the board or box level
  - New technologies should be identified early on
- **Fault propagation may be the problem you wish to mitigate**
  - This can include cumulative effects!
  - Fault injection may not be able to cover the state space
- **Destructive single event effects are an obvious target**
- **Can you tolerate a part replacement in your design cycle?**
  - Lead times, board re-spins, etc.

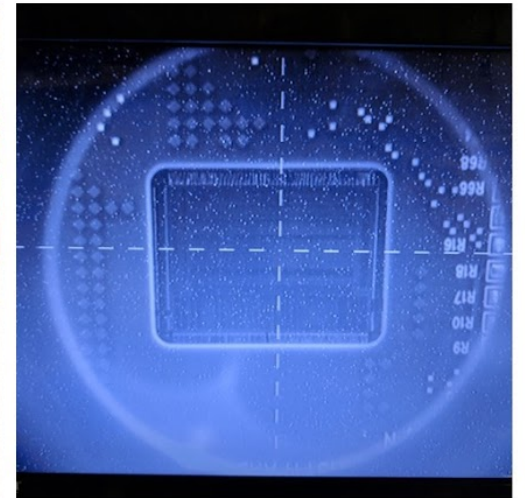
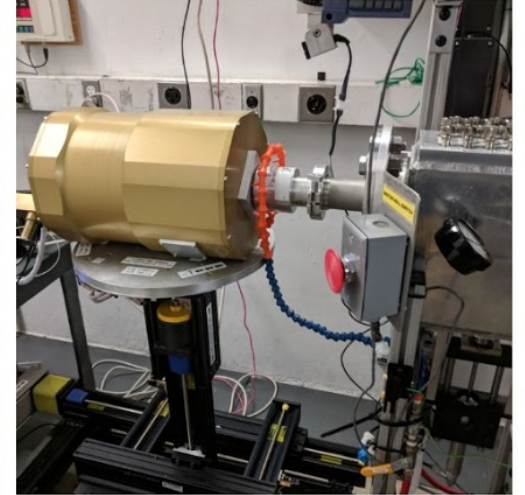
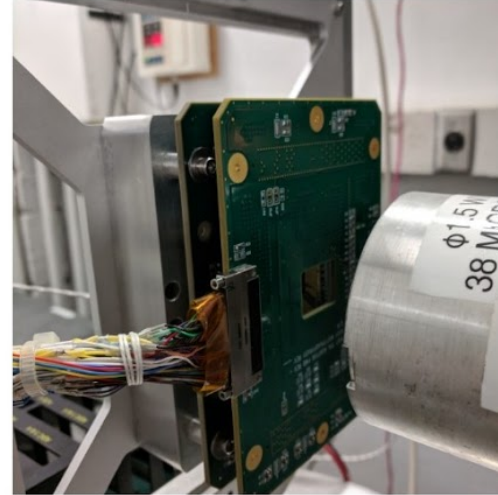

# Model Based Mission Assurance (MBMA) as a Tool

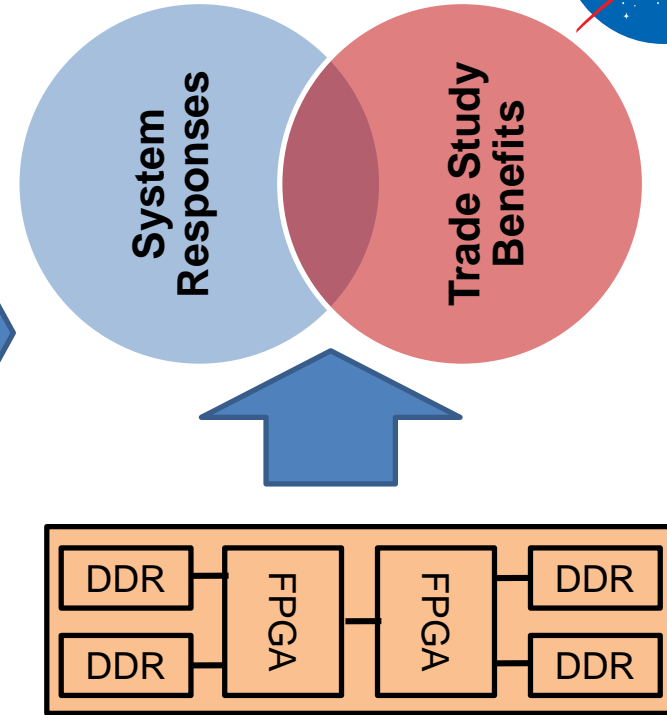
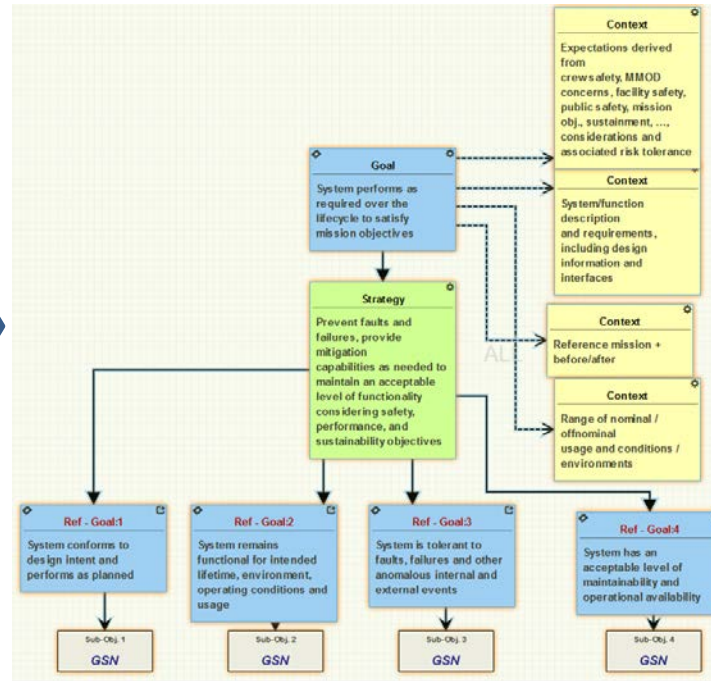
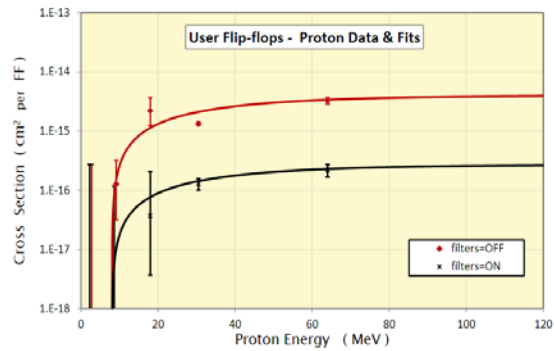
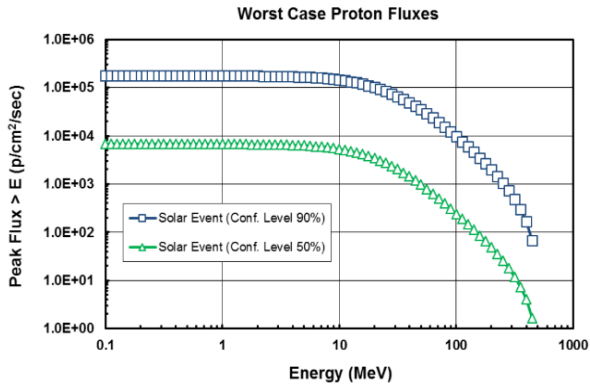
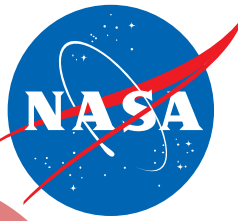

## Environment, Device, & Design

- **Models and Test Data** are brought together to get rates of upset / failure distributions
- **Resources and Utilization** are the scaling factors with criticality

## Goal Structuring Notation (GSN)

- Concept of operations
- **Requirements and Availability** are fed down correctly to subsystem
- Evidence is presented
- Assumptions are tracked

## Systems Modeling Language

- Description of System Connections and Dependencies
- Receives GSN readily
- **Fault propagation** can be identified

# Goal Structuring Notation (GSN)

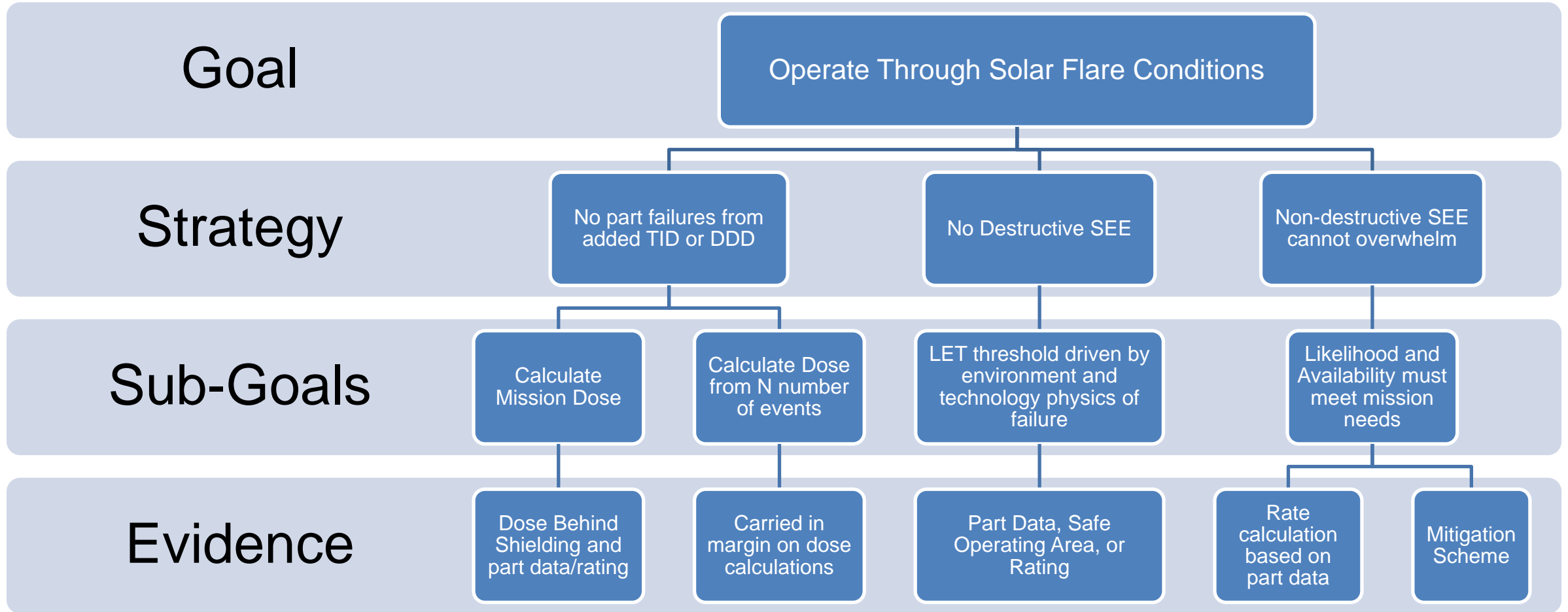
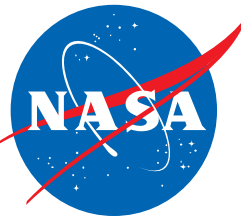





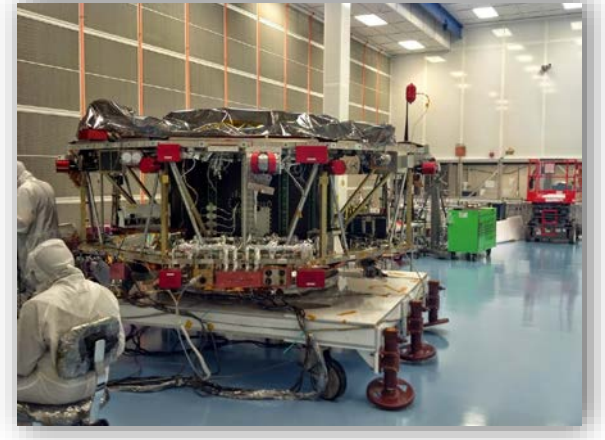
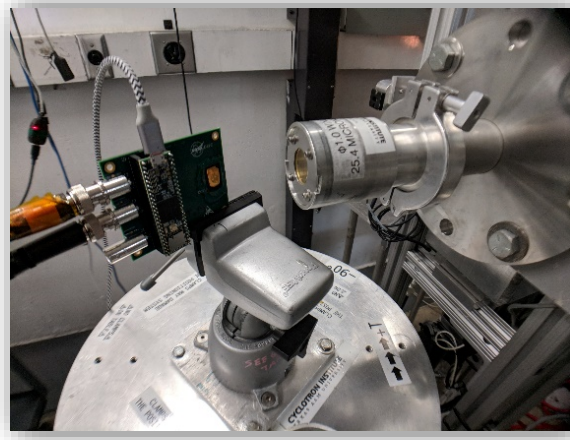
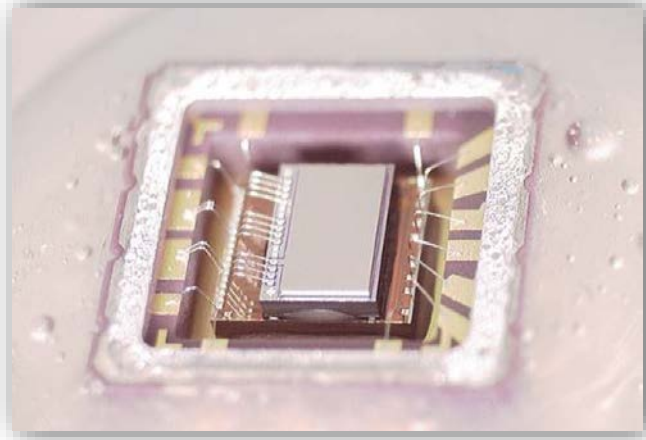

[michael.j.campola@nasa.gov](mailto:michael.j.campola@nasa.gov)

# THANK YOU