

NASA/TM-2019-220404



Airborne Spacing for Terminal Arrival Routes (ASTAR) Proof-of-Concept Flight Test

*Roy D. Roper, Michael R. Koch, William C. Johnson, and Kurt A. Swieringa
Langley Research Center, Hampton, Virginia*

September 2019

NASA STI Program . . . in Profile

Since its founding, NASA has been dedicated to the advancement of aeronautics and space science. The NASA scientific and technical information (STI) program plays a key part in helping NASA maintain this important role.

The NASA STI program operates under the auspices of the Agency Chief Information Officer. It collects, organizes, provides for archiving, and disseminates NASA's STI. The NASA STI program provides access to the NTRS Registered and its public interface, the NASA Technical Reports Server, thus providing one of the largest collections of aeronautical and space science STI in the world. Results are published in both non-NASA channels and by NASA in the NASA STI Report Series, which includes the following report types:

- **TECHNICAL PUBLICATION.** Reports of completed research or a major significant phase of research that present the results of NASA Programs and include extensive data or theoretical analysis. Includes compilations of significant scientific and technical data and information deemed to be of continuing reference value. NASA counter-part of peer-reviewed formal professional papers but has less stringent limitations on manuscript length and extent of graphic presentations.
- **TECHNICAL MEMORANDUM.** Scientific and technical findings that are preliminary or of specialized interest, e.g., quick release reports, working papers, and bibliographies that contain minimal annotation. Does not contain extensive analysis.
- **CONTRACTOR REPORT.** Scientific and technical findings by NASA-sponsored contractors and grantees.

- **CONFERENCE PUBLICATION.** Collected papers from scientific and technical conferences, symposia, seminars, or other meetings sponsored or co-sponsored by NASA.
- **SPECIAL PUBLICATION.** Scientific, technical, or historical information from NASA programs, projects, and missions, often concerned with subjects having substantial public interest.
- **TECHNICAL TRANSLATION.** English-language translations of foreign scientific and technical material pertinent to NASA's mission.

Specialized services also include organizing and publishing research results, distributing specialized research announcements and feeds, providing information desk and personal search support, and enabling data exchange services.

For more information about the NASA STI program, see the following:

- Access the NASA STI program home page at <http://www.sti.nasa.gov>
- E-mail your question to help@sti.nasa.gov
- Phone the NASA STI Information Desk at 757-864-9658
- Write to:
NASA STI Information Desk
Mail Stop 148
NASA Langley Research Center
Hampton, VA 23681-2199

NASA/TM-2019-220404



Airborne Spacing for Terminal Arrival Routes (ASTAR) Proof-of-Concept Flight Test

*Roy D. Roper, Michael R. Koch, William C. Johnson, and Kurt A. Swieringa
Langley Research Center, Hampton, Virginia*

National Aeronautics and
Space Administration

Langley Research Center
Hampton, Virginia 23681-2199

September 2019

Acknowledgments

The work contained herein would not have been possible without the many individuals who eagerly dedicated their time (including nights, weekends, and holidays) in support of this effort. The authors gratefully acknowledge the many individuals who made important contributions to the ASTAR Flight Test, and through their flexibility and hard work, brought this effort to fruition. They include: Terry Abbott, Brenda Andrews, Bryan Barmore, Janice Bayer, Tom Britton, Chad Chapman, Jim Davis, Mike Day, Michael Harper, Stella Harrison, Fred Hibbard, Daniel Hill, Lynn Jenkins, Richard Jessop, Patrick Johnson, Joe King, Steven Kohler, Gary Lohr, Ron Maddox, Mike Madson, Carolyn Malloy, Doug Mielke, Brendan Moeller, Sharon Otero, Mike Palmer, Leighton Quon, Lisa Rippy, Ed Scearce, Jim Smail, Jim Sturdy, Jerry Thomas, Steve Velotas, and Chris Wyatt.

Key partnerships between NASA and The Boeing Company, Seattle Air Route Traffic Control Center, and Moses Lake Air Traffic Control were also fundamental to the successful launch of this flight. The authors are particularly thankful to Gabe Brewer from Boeing for his exhaustive effort and support from concept to completion including software development, ground testing, flight testing, and logistical complement. The authors are also very appreciative of the tremendous support from Dan Boyle, Clarence Courtney, Lisa Foulk, Leon Fullner, Brett Russell, Al Sipe, and Jim Yuan.

The use of trademarks or names of manufacturers in this report is for accurate reporting and does not constitute an official endorsement, either expressed or implied, of such products or manufacturers by the National Aeronautics and Space Administration.

Available from:

NASA STI Program / Mail Stop 148
NASA Langley Research Center
Hampton, VA 23681-2199
Fax: 757-864-6500

Abstract

The Airborne Spacing for Terminal Arrival Routes (ASTAR) Flight Test was conducted by the NASA Air Traffic Management Technology Demonstration – 1 (ATD-1) project to demonstrate the use of NASA’s ASTAR algorithm beyond a simulated environment and assess the operational risks of performing a multi-aircraft flight test of Flight-deck Interval Management (FIM). Utilizing contemporary tools of the Federal Aviation Administration’s Next Generation Air Transportation System (NextGen) such as ADS-B, the ASTAR algorithm calculated speeds that the flight crew flew to achieve a precise spacing interval behind another aircraft at the final approach fix. Airspeed commands issued by the algorithm were flown by the flight crew of the FIM-equipped aircraft to achieve or maintain an assigned spacing goal from a target vehicle. The ASTAR algorithm was integrated with the Boeing supplied B-787 ecoDemonstrator aircraft, and five flight trials were conducted as a joint effort between NASA and Boeing on December 12, 2014. Initial results indicated arrival times within several seconds of accuracy of the planned termination point between two aircraft performing FIM in a real world environment. This flight test opened the way for the much more expansive ATD-1 Avionics Phase II flight test which occurred in early 2017. The flight trials under Phase II preceded further testing by the community in preparation for inclusion of the Interval Management concept as a part of the NextGen environment.

Contents

Acknowledgments.....iii

Abstract.....iv

Nomenclature.....1

1. Introduction.....2

2. Implementation: ASTAR & FIM.....3

 2.1 FIM Equipment Architecture.....4

 2.2 Simulation Testing.....7

 2.3 Boeing 787 Lab Testing.....8

 2.4 Ground Test Integration.....8

3. Implementation: Flight Test Operations.....9

 3.1 Test Location.....9

 3.2 Route Design.....13

 3.3 Test Plan.....15

 3.4 Test Aircraft.....16

 3.4.1 EcoDemonstrator Research Aircraft.....16

 3.4.2 Boeing T-38 Talon Fighter Jet.....17

4. Implementation: Functional Test Flight.....17

5. Implementation: Ancillary.....18

 5.1 Approvals.....18

 5.2 Staging Locations.....18

 5.3 Training.....19

6. Test Flight.....19

 6.1 Data Collection.....20

 6.2 Results.....21

 6.2.1 Summary of Flight Trial One.....22

 6.2.2 Summary of Flight Trial Two.....26

 6.2.3 Summary of Flight Trial Three.....28

 6.2.4 Summary of Flight Trial Four.....32

 6.2.5 Summary of Flight Trial Five.....35

7. Lessons Learned.....37

8. Conclusions.....37

References.....39

Appendix..... 40

ASTAR Flight Test Developed Materials..... 40

 i. Pilots – Data Cards, Routes..... 40

 ii. NASA representatives to ATC facilities 46

 iii. Air Traffic Control – Route Briefing Manual 46

List of Figures

Figure 1. Interval Management Operations	2
Figure 2. Flight test concept diagram.....	4
Figure 3. Flight research diagnostic tool.....	5
Figure 4. Electronic flight bag (left) and configurable graphics display (right).	6
Figure 5. Flight test gateway window.....	7
Figure 6. Ground speed pre-process data anomalies.....	9
Figure 7. Boeing Field satellite view.	10
Figure 8. Airspace surrounding Boeing Field airport.	11
Figure 9. Grant County International Airport satellite view.	12
Figure 10. Airspace surrounding Grant County International Airport.....	13
Figure 11. Original route structure.....	14
Figure 12. SUBDY and KNOCK arrival routes.	15
Figure 13. Developed test routes for a Seattle STAR.	18
Figure 14. Flight trial one on SUBDY route.....	23
Figure 15. Flight trial one vertical error (difference from profile altitude).....	23
Figure 16. Flight trial one FIM command speeds.....	25
Figure 17. Flight trial one spacing error vs. distance from the achieve-by point.....	25
Figure 18. Flight trial two on KNOCK route.....	26
Figure 19. Flight trial two Target and Ownship positioning.....	26
Figure 20. Flight trial two FIM command speeds.....	27
Figure 21. Flight trial two spacing error vs. distance from the achieve-by point.	28
Figure 22. Flight trial three on SUBDY route.	28
Figure 23. Flight trial three aircraft flight paths near SUB42 waypoint.	29
Figure 24. Flight trial three FIM command speeds.....	30
Figure 25. Flight trial three spacing error vs. distance from the achieve-by point.	30
Figure 26. Flight trial three aircraft ground speed vs. distance from the achieve-by point.	31
Figure 27. Flight trial four aircraft on both routes.	32
Figure 28. Flight trial four FIM command speeds.....	33
Figure 29. Flight trial four spacing error vs. distance from the achieve-by point.....	33
Figure 30. Flight trial four aircraft ground speed vs. distance from the achieve-by point.....	34
Figure 31. Flight trial five aircraft on both routes.....	35
Figure 32. Flight trial five spacing error vs. distance from the achieve-by point.	36
Figure 33. Flight trial five FIM command speeds.	36
Figure 34. Flight trial five aircraft ground speed vs. distance from the achieve-by point.	37

List of Tables

Table 1. Run Test Conditions	16
Table 2. ASTAR Flight Test Support	20
Table 3. Interval Management Precision	21
Table A1. B787 Route Waypoints	41
Table A2. T-38 Route Waypoints	42
Table A3. T-38 SUBDY Profile Card.....	43
Table A4. T-38 KNOCK Profile Card.....	43
Table A5. B787 SUBDY Profile Card.....	44
Table A6. B787 KNOCK Profile Card.....	45
Table A7. Pilot Scenario Run Card.....	45

Nomenclature

ABS	Aircraft Bus Simulator
ADS-B	Automatic Dependent Surveillance - Broadcast
ARTCC	Air Route Traffic Control Center
ASTAR	Airborne Spacing for Terminal Arrival Routes
ASTOR	Aircraft Simulations for Traffic Operations Research
ATC	Air Traffic Control
ATD-1	Air Traffic Management Technology Demonstration - 1
CAS	Calibrated Airspeed
CDN	Common Data Network
CDU	Control Display Unit
CGD	Configurable Graphics Display
CMS	Controller Managed Spacing
COTS	Commercial Off-The-Shelf
DTG	Distance-to-go
EFB	Electronic Flight Bag
ERAM	En route Automation Modernization
ETA	Estimated Time of Arrival
FAA	Federal Aviation Administration
FAF	Final Approach Fix
FIM	Flight deck-based Interval Management
FMC	Flight Management Computer
ft.	feet
GPS	Global Positioning System
ILS	Instrument Landing System
IM	Interval Management
ISS	Integrated Surveillance System
KBFI	Boeing Field/King County International Airport, Seattle, WA
KMWH	Grant County International Airport, Moses Lake, WA
MCDU	Multipurpose Control Display Unit
MCP	Mode Control Panel
MOPS	Minimum Operational Performance Standards
NAS	National Airspace System
NASA	National Aeronautics and Space Administration
NextGen	Next Generation Air Transportation System
NGD	Navigation and Guidance Display
nmi	nautical mile
OPD	Optimized Profile Descent
RNAV	Area Navigation
RNP	Required Navigation Performance
s.	seconds
STAR	Standard Terminal Arrival Route
TMA-TM	Traffic Management Advisor with Terminal Metering
UDP	User Datagram Protocol
ZSE	Seattle ARTCC

1. Introduction

The Air Traffic Management Technology Demonstration-1 (ATD-1) is a major applied research and development sub-project of NASA's Airspace Operations and Safety Program (AOSP). ATD-1 is the first in a series of Air Traffic Management sub-projects that demonstrate innovative NASA technologies that have attained a sufficient level of maturity to merit more in-depth evaluation and development at the system level. A primary goal of ATD-1 is to operationally demonstrate an integrated set of NASA arrival management technologies for planning and executing efficient arrival operations in the terminal environment for high-density airports. These technologies are: Traffic Management Advisor with Terminal Metering (TMA-TM) (for planning), Flight deck-based Interval Management (FIM) (for airborne spacing), and Controller Managed Spacing (CMS) (for ground-based spacing in the terminal airspace). Currently published Federal Aviation Administration (FAA) plans envision airborne spacing pre-implementation starting in 2017 with operational availability in the National Airspace System (NAS) by 2020.¹

In order to address the airborne spacing component, researchers at NASA Langley Research Center developed a trajectory-based control law, called Airborne Spacing for Terminal Arrival Routes (ASTAR). Using Automatic Dependent Surveillance - Broadcast (ADS-B) In messaging and onboard sensors to determine current position along their intended trajectories, the ASTAR algorithm computes expected times of arrival of the Interval Management (IM) aircraft (i.e., **Ownship**) and followed aircraft (i.e. **Target**) to a pre-defined achieve-by point. The difference between the expected times of arrival is used in conjunction with an operationally desired spacing goal prescribed by Air Traffic Control (ATC) to determine a spacing error. The ASTAR speed control algorithm computes the amount of speed compensation needed to achieve the spacing goal at the achieve-by point.² The desired spacing goal is required to be met when the Ownship crosses the achieve-by point. In Figure 1, air traffic controllers provide an IM clearance to the aircraft near the top of descent (left). The pilots follow the onboard speed guidance to achieve a precise spacing interval, Δ , behind the Target aircraft (right). Both the achieve-by point and the planned termination point were co-located at the final approach fix (FAF). As the flight crews follow the speed guidance, the aircraft will achieve a precise spacing interval, thereby enabling increased runway throughput, airport arrival capacity, and more efficient aircraft operations.³

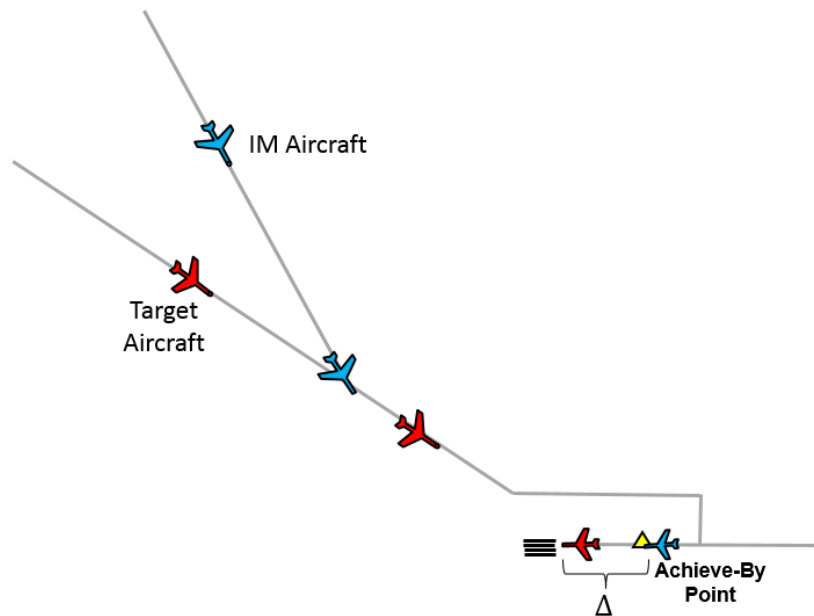

Figure 1. Interval Management Operations

The ATD-1 concept is envisioned for a mid-term airspace environment (prior to 2020) where integrated communication tools, such as Controller Pilot Data Link Communication, are unavailable. Therefore, the Target aircraft's trajectory intent information is not actively broadcasted to the IM-equipped aircraft. The NASA ASTAR spacing algorithm compensates for this lack of information by using published speed constraints to compute the estimated time of arrival (ETA) of both the IM and Target aircraft. Since test IM technology is not integrated with the aircraft flight management computer, wind forecast data for the Target aircraft is also unavailable to the algorithm. Therefore, the amount of uncertainty in the Target's ETA calculations increases when the Target aircraft is on a different route.

Although ATD-1 benefits are only fully realized by the integration of all three stated technologies (TMA-TM, FIM, and CMS), an interim activity demonstrating the flight deck automation alone would facilitate avionics development, operational risk assessment, and assist in the planning of the final ATD-1 flight test in 2017. In April 2013, an opportunity presented itself when NASA and Boeing were searching for emerging aviation technologies that could be rapidly integrated with and demonstrated on Boeing's ecoDemonstrator test aircraft.⁴ Occasionally, Boeing designates an aircraft, known as ecoDemonstrator, to function as a flight test bed, which serves two purposes. First, it serves as schedule risk mitigation by accelerating the technical readiness of prototype systems. This risk mitigation is accomplished by providing a means to conduct flight tests on systems outside of the certification process. Second, it opens the door for Boeing to collaborate with vendors and research facilities to test new concepts in an operationally relevant flight environment. Researchers gain access to affordable flight test time, and Boeing can evaluate new technologies sooner than it otherwise could.

Candidate technologies for the proposed collaboration were required to be sufficiently mature, have relatively few integration requirements, and promise benefit to the aviation community. It was determined that the enabling technology behind the airborne component of the ATD-1 suite of tools was a good fit and was selected for the project, which was subsequently named the ASTAR Flight Test.

The primary objective of the ASTAR Flight Test was to identify operational risks for the future ATD-1 flight test. It also served to exercise in-flight use of the ASTAR algorithm on a modern transport category aircraft to show the potential for safe and efficient spacing operations in the NAS. Data collected were used to validate some ATD-1 FIM system requirements and investigate FIM operations prior to release of the Minimum Operational Performance Standards (MOPS) for FIM.⁵ A final objective was to demonstrate a collaborative rapid prototype effort with an industry partner. Success relied on the ability of NASA and Boeing to rapidly port an ASTAR-based application to a laptop computer, integrate it with the ecoDemonstrator 787 test aircraft, and conduct flight tests by the fall of 2014.

The ASTAR Flight Test was conducted as a collaborative effort between NASA and Boeing. Boeing contributed flight test time on the company's 2013 ecoDemonstrator aircraft (B787-800), and NASA developed the prototype FIM system. In addition, NASA and Boeing collaborated to integrate the FIM avionics into the aircraft and staff flight operations.

2. Implementation: ASTAR & FIM

Development of the ASTAR-based FIM application for the flight test was a challenge due to schedule and budget constraints. The first task was to identify a viable approach and architecture that could be implemented without large software and avionics development efforts. Leveraging previous work was essential for success. Another challenge was the limited flight test window, which allowed only one attempt at the flight test. If for any reason the demonstration was unsuccessful, there would be no opportunity to make adjustments and try again. Additionally, there was also no expectation that the equipment would fly prior to the test for system verification and validation. This constraint represented a significant risk which could only be mitigated through extensive simulations and ground testing. The following sections provide an overview of the FIM application development.

2.1 FIM Equipment Architecture

To meet the aggressive schedule goals and minimize the development costs, it was essential that the airborne equipment hosting the FIM application leverage commercial-off-the-shelf (COTS) components and software that were already in use. To that end, the FIM application was hosted on a COTS laptop computer, which ran virtual avionics software that was based on software used in NASA Langley flight deck simulators. The primary development task was a mechanism to obtain ADS-B data and aircraft state data from the ecoDemonstrator.

Fortunately, the ecoDemonstrator aircraft model in service in 2014 (B787) was conducive for such an implementation. The B787 avionics were developed with an open architecture to aid in the adoption of new applications with relative ease. The primary communication vehicle is not the ubiquitous ARINC 429 bus in use on many higher-end commercial and transport aircraft, but something more akin to Ethernet known as the Common Data Network (CDN). CDN systems support common Ethernet ports facilitating a direct connection between a laptop computer and the aircraft avionics. A survey of available CDN ports showed that all Target and Ownship data necessary to support the ASTAR application could be made available on two accessible buses: the Integrated Surveillance System (ISS) Bus and the Flight Test Bus. Therefore, a laptop computer with two independent Ethernet interface ports was deemed necessary for the ASTAR Flight Test.

To rapidly develop a FIM application, several simulated avionics systems were utilized from NASA Langley's Aircraft Simulations for Traffic Operations Research (ASTOR) simulation program. ASTOR simulates the flight of a single aircraft with interactive access to several avionics systems such as a Mode Control Panel (MCP), a Navigation and Guidance Display (NGD), a Multipurpose Control Display Unit (MCDU), and many others. Two ASTOR avionics systems developed for the study of FIM applications are an Electronic Flight Bag (EFB) and a Configurable Graphics Display (CGD).⁶ The EFB serves as an interface to the crew for data entry, application control, status, and situation awareness. The CGD provides the speed guidance for the crew to follow during a FIM operation. The EFB and CGD are key components of the FIM application developed for the ASTAR Flight Test. Another key component borrowed from the ASTOR application is the Aircraft Bus Simulator (ABS). The ABS simulates an ARINC 429 data bus infrastructure common on most flight decks. Each simulated avionics system (e.g., MCDU, NGD, EFB, etc.) is connected virtually to others via the ABS just as they would on an actual flight deck. Data is passed using the protocol and word format defined in the ARINC 429 standard resulting in a high fidelity simulated data communication function. Figure 2 illustrates the FIM equipment architecture developed for the ASTAR Flight Test. Each subsystem is described herein.

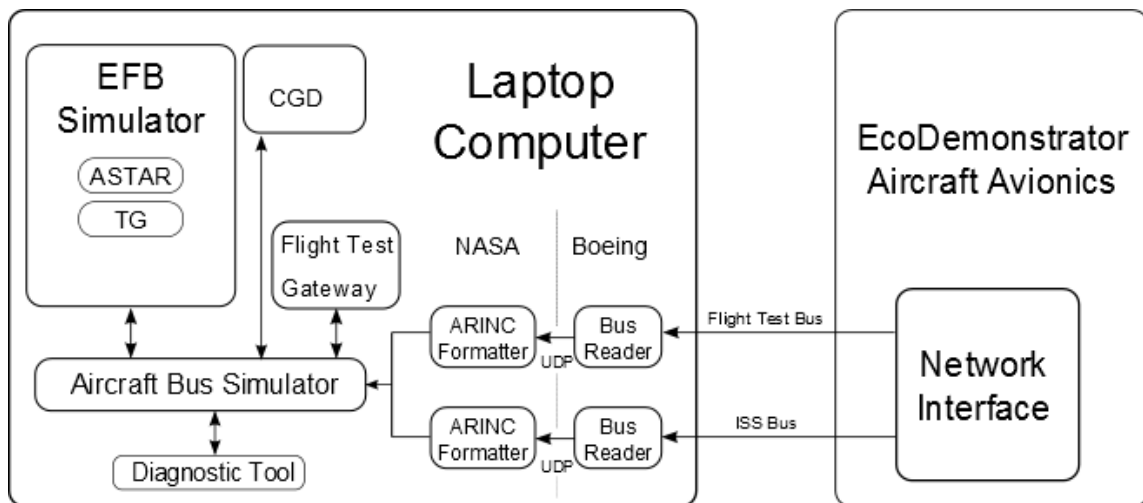

Figure 2. Flight test concept diagram.

Aircraft Bus Simulator: The ABS was the backbone of the system to which simulated avionics systems connected in order to pass data. It consisted of multiple links; each based on ARINC 429 protocol and data formatting.

Bus Reader: While the physical layer of the link between the flight test laptop computer and the ecoDemonstrator avionics was akin to the open Ethernet standard, the network protocol and data format was proprietary intellectual property of Rockwell Collins. This constraint caused hurdles that prevented NASA from gaining access to Interface Control Documents necessary to develop an interface to flight deck avionics. To overcome the issue, Boeing developed a bus reader to bridge proprietary protocol and data formats to the open User Datagram Protocol (UDP). NASA then developed the FIM application to read the aircraft data from an interface utilizing UDP.

ARINC Formatter: Since the simulated avionics systems connected virtually to the ABS, the data was required to be in ARINC 429 format. The ARINC Formatter parsed data from UDP packets, formatted them into ARINC 429 words and used the ARINC 429 protocol to transfer data on the ABS.

Diagnostic Tool (Figure 3): An application that read data from the ABS and displayed it in a diagnostic window allowing users to view real-time aircraft state data. The diagnostic tool facilitated troubleshooting by providing the research engineer a means to determine that state data was properly placed and correctly interpreted by the ASTAR algorithm to generate speed commands.

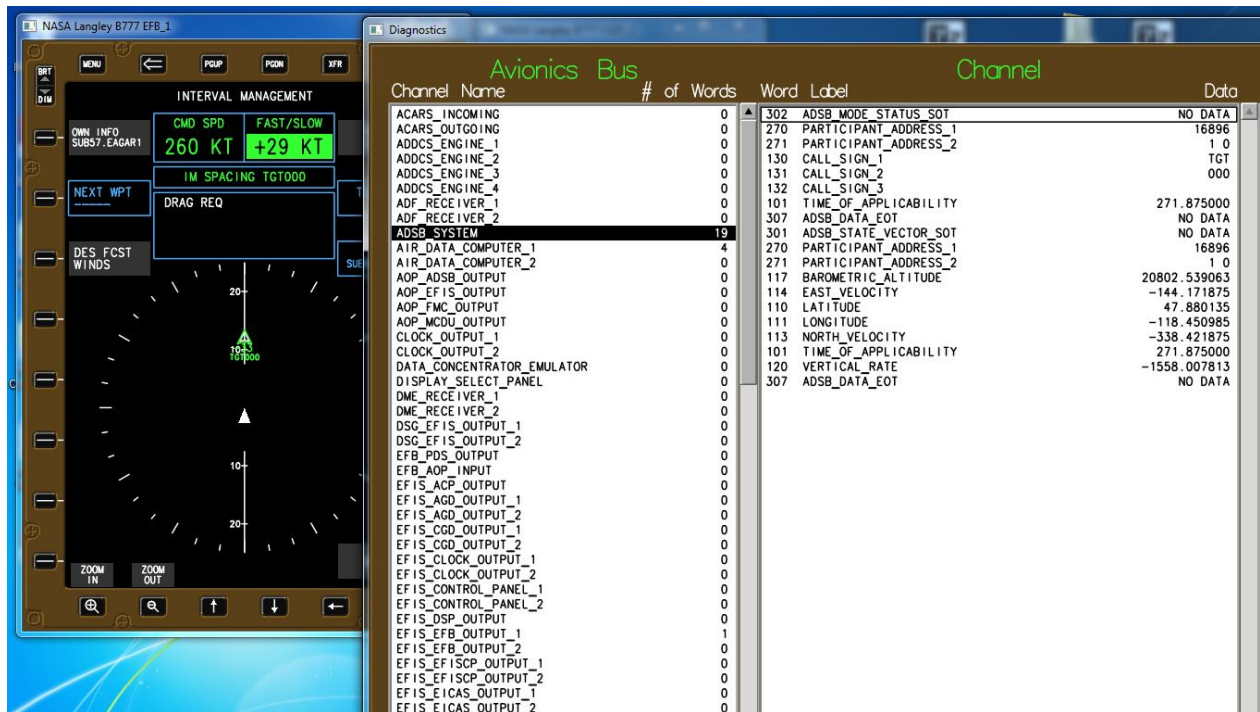

Figure 3. Flight research diagnostic tool.

Configurable Graphics Display (CGD): The CGD presented speed guidance for the research engineer to follow during a FIM operation. It also provided messages about the operation (e.g. drag required) and alerting when the FIM application detected that speed guidance was not being followed. These messages appeared in the IM alert message box (Figure 4, right).

Electronic Flight Bag (EFB): The EFB functioned as an auxiliary display on a laptop from which the research engineer interacted with automation required for a FIM operation (Figure 4, left). After the user specified a two-dimensional continuous flight path, the trajectory generator calculated a full four-

dimensional trajectory defined by a series of trajectory change points⁷. The FIM application executed on the laptop as follows:

- Received clearance and other operator input
- Received traffic and Ownship state data from the ecoDemonstrator
- Calculated speed guidance
- Sent speed guidance, operational messages, and alerts to the CGD

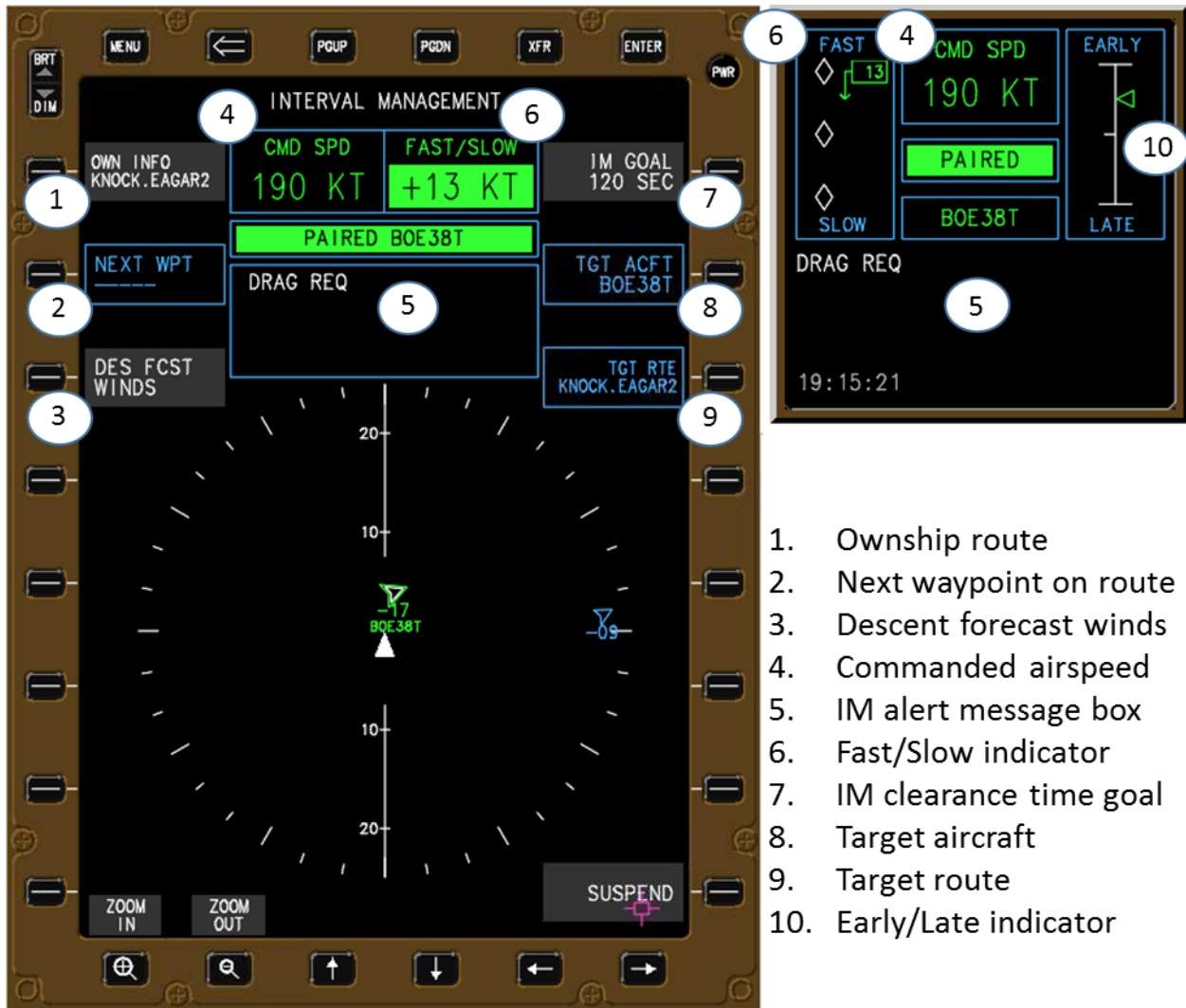

Figure 4. Electronic flight bag (left) and configurable graphics display (right).

Flight Test Gateway: To provide greater situational awareness to the researcher, the Flight Test Gateway window displayed a subset of data from all ADS-B In messages received from traffic in the proximity (Figure 5). Data displayed were magnetic bearing (degrees), range (nautical mile), relative altitude (in hundreds of feet), and the callsign.

```

CA: ATM FlightTestGW PARTS
nge-nm><delta-FL>
  Better matches will be at the end of the list

spec :
196/192/+295 1697
281/172/+285 UAL902 ←
276/199/+265 ETD171
344/150/+285 286
146/147/+265 AFL106
179/064/+275 4874
356/071/+265 PAL118
059/070/+235 GTI4352
300/190/+101 101
261/158/+002 KAL020
254/149/+005 475
256/126/+039 UAL1732
056/092/+016 SCX8667
235/019/-075 BOE400
359/034/-064 N285SB
114/062/+014 BOE783
177/006/-012 BOE38T ←

United Airlines Flight 902:
281 degrees (SSW)
172 nautical miles away
28,500 feet above ownship altitude

Boeing 38T:
177 degrees (South)
6 nautical miles away
1,200 feet below ownship altitude

USE THE MINIMIZE BUTTON WHEN FINISHED. DO NOT PRESS THE 'X' BUTTON.

To generate proximate traffic list, enter an empty line or <nag-bearing-deg>/
nge-nm><delta-FL>
  Better matches will be at the end of the list

```

Figure 5. Flight test gateway window.

2.2 Simulation Testing

Initial testing of the FIM equipment was conducted prior to the flight demonstration to verify that it was functioning properly. Two ASTOR stations were used to model a pair of aircraft conducting a FIM operation. Both ASTOR stations used aerodynamic and engine models representative of a large 250,000-lb twin-engine commercial transport category aircraft. One ASTOR station emulated the ecoDemonstrator B787 and was integrated with the ASTAR-based FIM equipment (the laptop application described in section 2.1) to serve as a FIM-equipped Ownship. The other station, which emulated a T-38, served as the Target aircraft against which the Ownship achieved precision spacing. Each ASTOR included simulations of the following: a six degrees of freedom aircraft model, Primary Flight Display, Multi-Function Display, autopilot and auto-throttle systems, Flight Management Computer (FMC), MCDU, MCP, and ADS-B.

For the ASTAR flight test, communication did not exist between the EFB, which hosted ASTAR, and the FMC, which hosted the active aircraft route information. Since route information used by NASA's ASTAR algorithm was encoded in a particular format, specialized route files were developed using information from published procedures. These route files were used to determine the aircraft's trajectory, which were then used to calculate the flight time to the achieve-by point. Therefore, simulation testing was particularly crucial to verify a nominal trajectory had been correctly matched with the vehicle's optimized descent.

Due to proprietary rights restrictions, actual B787 flight optimized descent profile data was unavailable to researchers during the development phase. Therefore, a 'best guess' optimized descent was derived using commonly available Mach numbers and other published performance data for the B787. Flight profiles were also derived from each route to determine speed and altitude constraints that allowed the T-38 Target aircraft to mimic the descent of a standard transport category aircraft.

The T-38 ASTOR station was configured using the developed flight profiles, then placed in a separate room in order to isolate the Target aircraft pilot from knowledge of FIM activities at the B787 station. A live phone intercom connected the two pilots and remained on mute, except during periods of

communication between the two aircraft in order to simulate the actual demonstration. The FIM laptop was placed near the B787 ASTOR station, but positioned such that the laptop was not visible to the pilot, and therefore the speed command data was relayed verbally. Commanded speed changes were entered in manually to the flight director by the B787 ASTOR pilot, after which the auto-throttles reacted accordingly.

Three separate scenarios, identical to those planned for the flight test (see section 3.2), were conducted to verify and validate the simulated avionics system (e.g. ABS, EFB, CGD, bus reader, etc.), the ASTAR algorithm, trajectory generator, data integrity and format, and performance of the system. The spacing goal for all scenarios was 120 seconds between both aircraft by the achieve-by-point (located at the final approach fix). Using typical approach speeds, this criterion provided a minimum 4.4 nmi separation at the achieve-by-point. The scenarios were tested in two configurations: 1) with the T-38 station on autopilot using the preconfigured altitude and speed restrictions that were developed, (Appendix A, Tables 6, 7) and 2) with the T-38 simulation under human control without the autopilot in order to test for nonconformity due to human variability.

In all test conditions, the ASTOR that was conducting FIM operations maintained adequate separation throughout each run and arrived on time with greater than 4 nmi separation from the T-38 at the Final Approach Fix. This result suggested an acceptable level of separation for the planned flight test aboard the ecoDemonstrator, since the FAA requirements were a minimum of 3 nmi.

2.3 Boeing 787 Lab Testing

Aircraft and research systems testing were conducted at Boeing Company facilities for software checkout. A software interface was developed to retrieve ASTAR required data from Boeing proprietary B787 network buses.

The Boeing bench test virtual environment allowed researchers to simulate multiple aircraft moving at predefined altitudes along specified trajectories. The primary objective for bench testing was to validate correct data flow from the ADS-B receiver to the ASTAR algorithm. The benefit of using a bench test for the ASTAR Flight Test was the ability to stop time and verify all aircraft state data matched from both sides of the data stream (i.e., altitude-in is equal to altitude-out, etc.).

As Boeing worked with the Rockwell Collins ISS unit, it became necessary to ensure correct parsing of received ADS-B data to the correct frame without overflow. Once parsed to the correct frame, aircraft state data was reformatted to ARINC 429 format to run on the NASA designed Aircraft Bus Simulator. During the effort, state data from simulated aircraft was expected in a specified format. When the data passed through, some garbled data created state data of an incorrect length and caused an offset into the next frame. Therefore, if uncorrected, subsequent aircraft state data would be parsed incorrectly, causing the ARINC formatter to declare an error state. Through subsequent testing the parsing error was resolved collaboratively by Boeing and NASA.

2.4 Ground Test Integration

A ground test onboard the B787 was conducted at Boeing Field to determine positive connectivity and functionality for the aircraft avionics-to-laptop setup. ADS-B functionality was confirmed with the T-38 nearby on the same airfield, as well as confirmation of the expected alphanumeric identifier for the Target aircraft.

There were two network buses sourcing required ASTAR data: 1) the Rockwell Collins Integrated Surveillance System processing unit, and 2) the Flight Test Bus. Information traveled from the B787 ecoDemonstrator flight deck computer via Ethernet cord to the carry-on laptop. An Ethernet interface for the ISS unit was handled through utilization of a USB to Ethernet Adapter. During the ground test, the carry-on laptop resided at a dedicated laptop workstation in the passenger cabin. The laptop queried the bus to supply traffic information back to the laptop, which included both Ownship and Target aircraft state data.

Each station was equipped with research power provisions and no changes to existing power supply components were necessary. Headphones were also supplied at each station location.

The algorithm could only be partially tested in static aircraft mode, because speed inputs from the Ownship were unavailable (since the aircraft was not moving). Flights in the air surrounding Boeing Field were available, though, and could serve as relevant Target aircraft. As speed inputs from selected Target aircraft came through the ADS-B unit, the ground speed and ground track produced data anomalies with approximately 10 to 60 knot speed impulses prior to ASTAR processing (Figure 6). The data anomalies were uncharacteristic of the surrounding signal noise, therefore a tolerance limit was implemented to exclude velocities from updating on a given report when there were unrealistic deviations. Since the algorithm could ‘coast’ for up to 30 seconds, there was a reasonable amount of time for the ground speed information to update and pass the filter parameters. None of the other parameters (Latitude, Longitude, Altitude, Vertical Speed, or Time-of-applicability) showed similar data anomalies. Data from the actual flight test still contained spikes, although the detection filter significantly reduced the frequency.

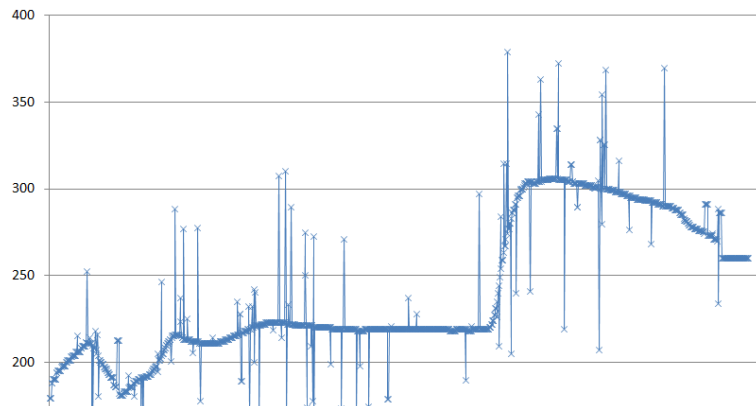

Figure 6. Ground speed pre-process data anomalies.

3. Implementation: Flight Test Operations

3.1 Test Location

The flight demonstration occurred at two test locations: Airspace surrounding Boeing Field/King County International Airport, Seattle, WA (KBFI) and airspace around Grant County International Airport, Moses Lake, WA (KMWH). The flight originated from KBFI (Figure 7) with all flight participants and equipment onboard. KBFI is a Class D airport underlying Seattle-Tacoma Class B airspace (Figure 8). The flight test commenced in Class A airspace approximately 100 nautical miles northeast of Grant County Airport.



Figure 7. Boeing Field satellite view.

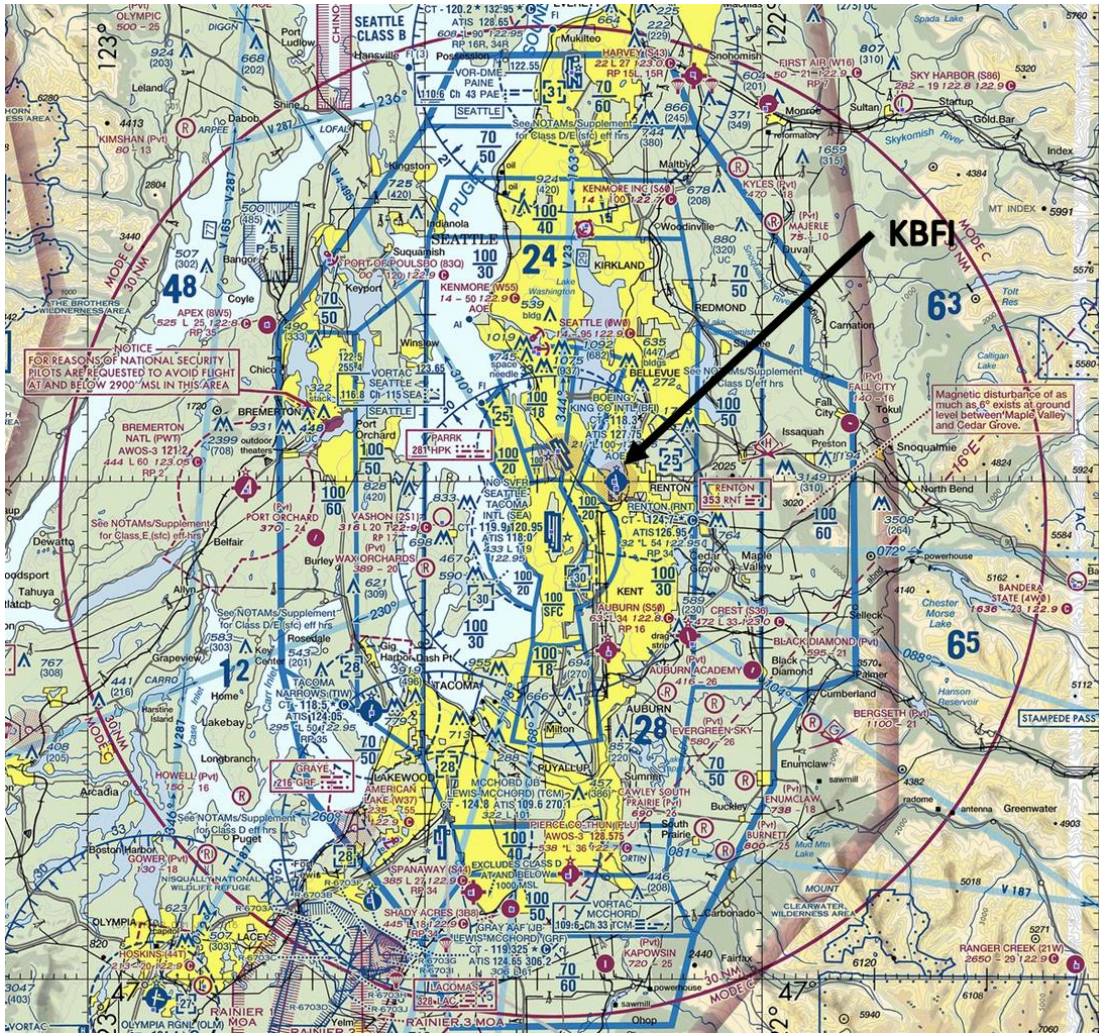

Figure 8. Airspace surrounding Boeing Field airport.

Grant County International Airport is a class D airport located in a sparsely populated area making it an ideal test location (Figure 9). Average operations from January 1 to December 31, 2013 were 163 aircraft per day. Fifty-two percent of all operations were military, forty-five percent general aviation, and four percent air taxi.⁸ Ephrata Municipal Airport (KEPH), ten nautical miles to the northwest from KMWH, hosts on average 370 aircraft operations each day (Figure 10). All operations at EPH are general aviation in nature with heavy glider activity April to October.⁹



Figure 9. Grant County International Airport satellite view.

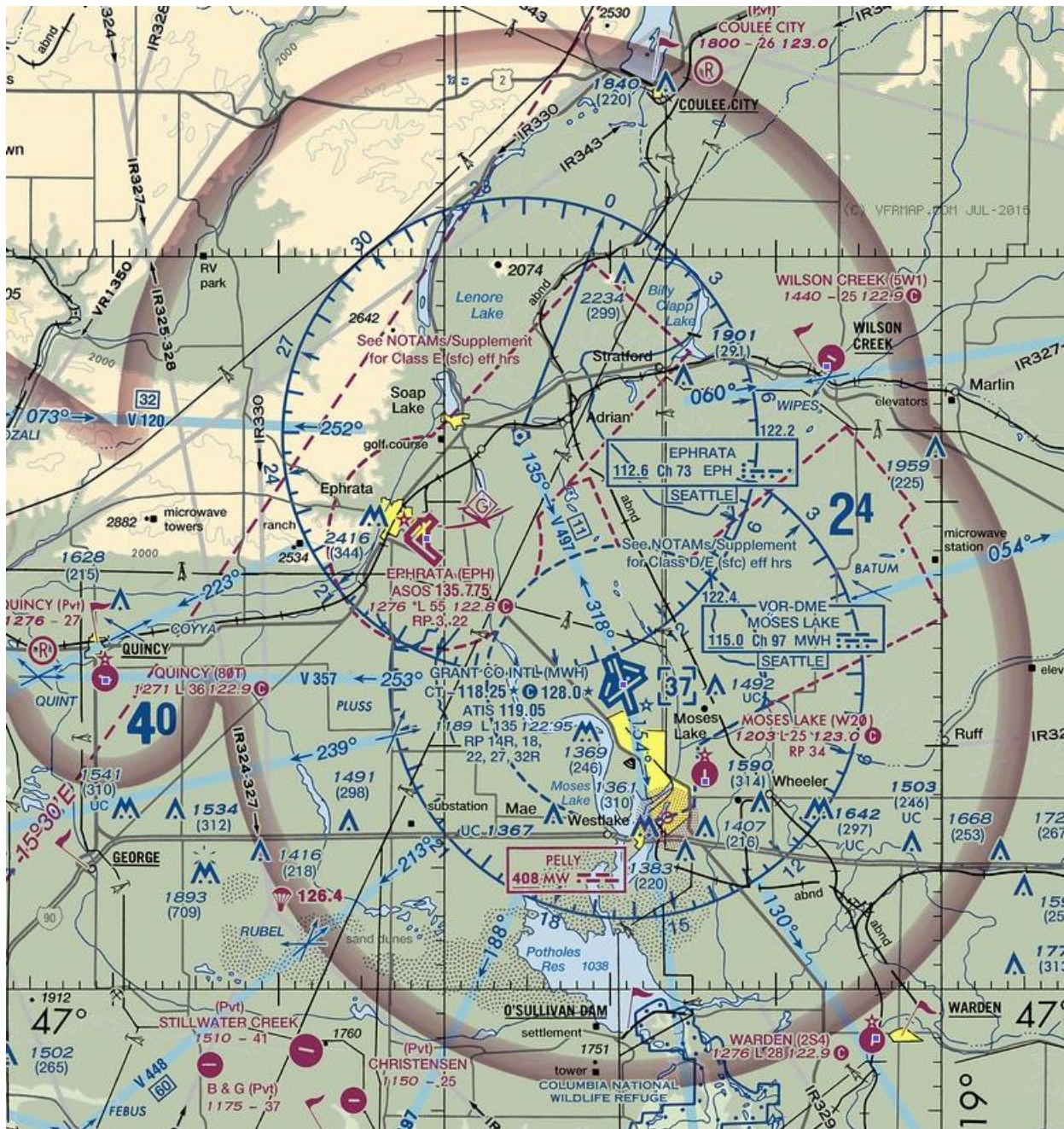

Figure 10. Airspace surrounding Grant County International Airport.

3.2 Route Design

In order to conduct the demonstration within the necessary operational conditions, new airspace routes were developed that would allow the FIM operation to be tested during in-trail operations where the Ownship aircraft was on a coincident route with the Target aircraft and merging operations where the Ownship aircraft was on a different route than the Target aircraft. In the merging operations, the two aircraft merged on the same route downstream after the FIM operation was initiated.

Originally, a previously used Boeing test route (Figure 11) was expected to be used for the ASTAR Flight Test, but simulation testing indicated a need for NASA to modify the existing route. The inbound

turn of approximately 135 degrees led to speed conformance losses and caused the spacing error to change by as much as 10 seconds during simulation testing. With input from Seattle Center, the HAMUR waypoint was added between SUBDY and UPBOB which softened the turn and reduced the time loss (Figure 12). The original route was also truncated by 15 nmi. Because the waypoint off the SUBDY 003 degree radial 57 nmi away (Figure 11, SUBDY003/57) was considered too close to the Okanogan and Roosevelt Military Operation Areas for a test flight, so a closer waypoint 42 nmi along the same radial became the new initial waypoint, designated SUB42 (Figure 11, SUBDY003/42).

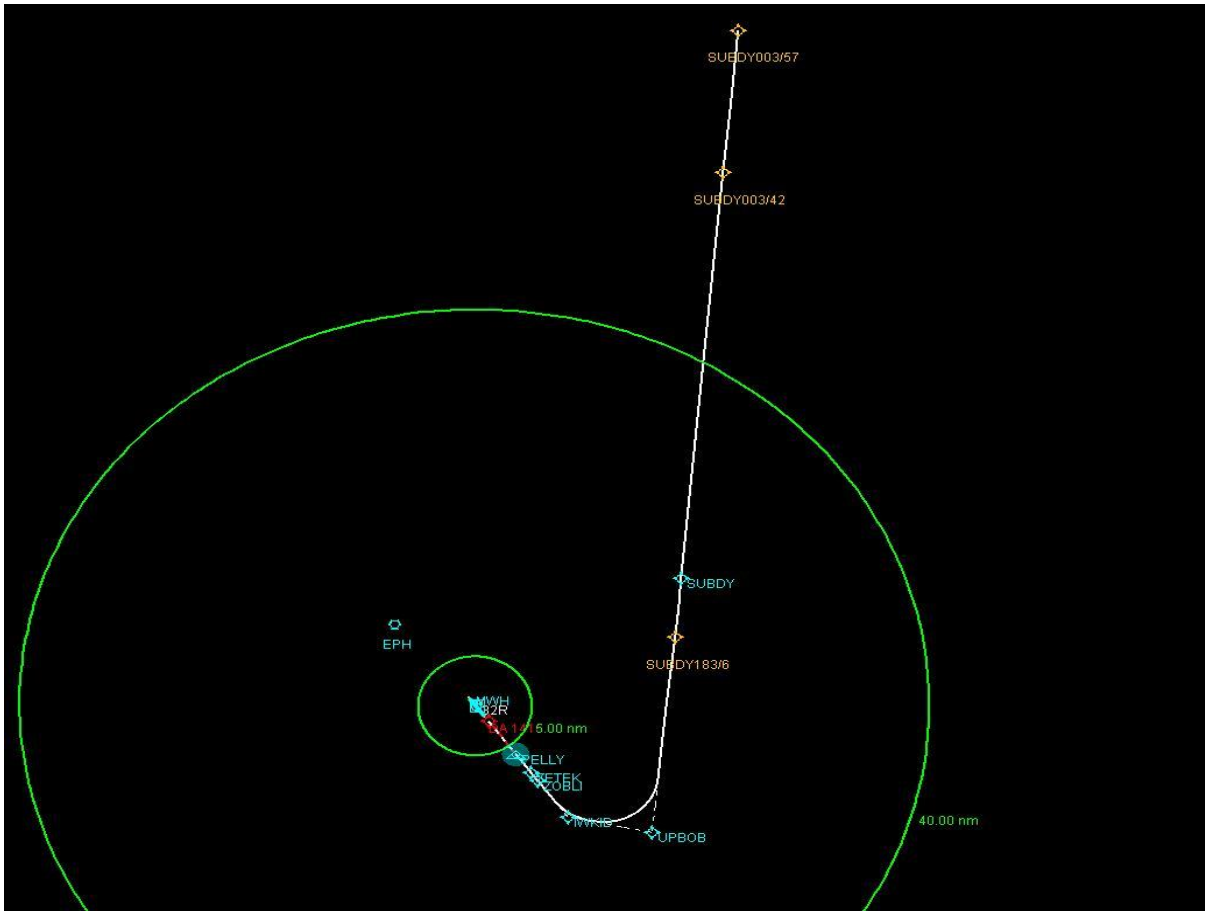

Figure 11. Original route structure.

A second route was added to meet the needs of both Boeing and ATC. For ATC, multiple routes allowed the two aircraft to be pre-positioned based on local traffic loads to maximize the chances for an uninterrupted flight trial, whereas for Boeing, two routes increased the likelihood of avoiding adverse weather. The two available routes were the western SUBDY Arrival beginning at SUB42 and the eastern KNOCK Arrival beginning at KNOCK. Two staging locations, or Hold points, were also established but not used, which caused less than ideal positioning (Figure 12, WATRU and KS18I). Alternatively, during the planning phase, ATC suggested both aircraft may be requested to hold at different altitudes over a single location.

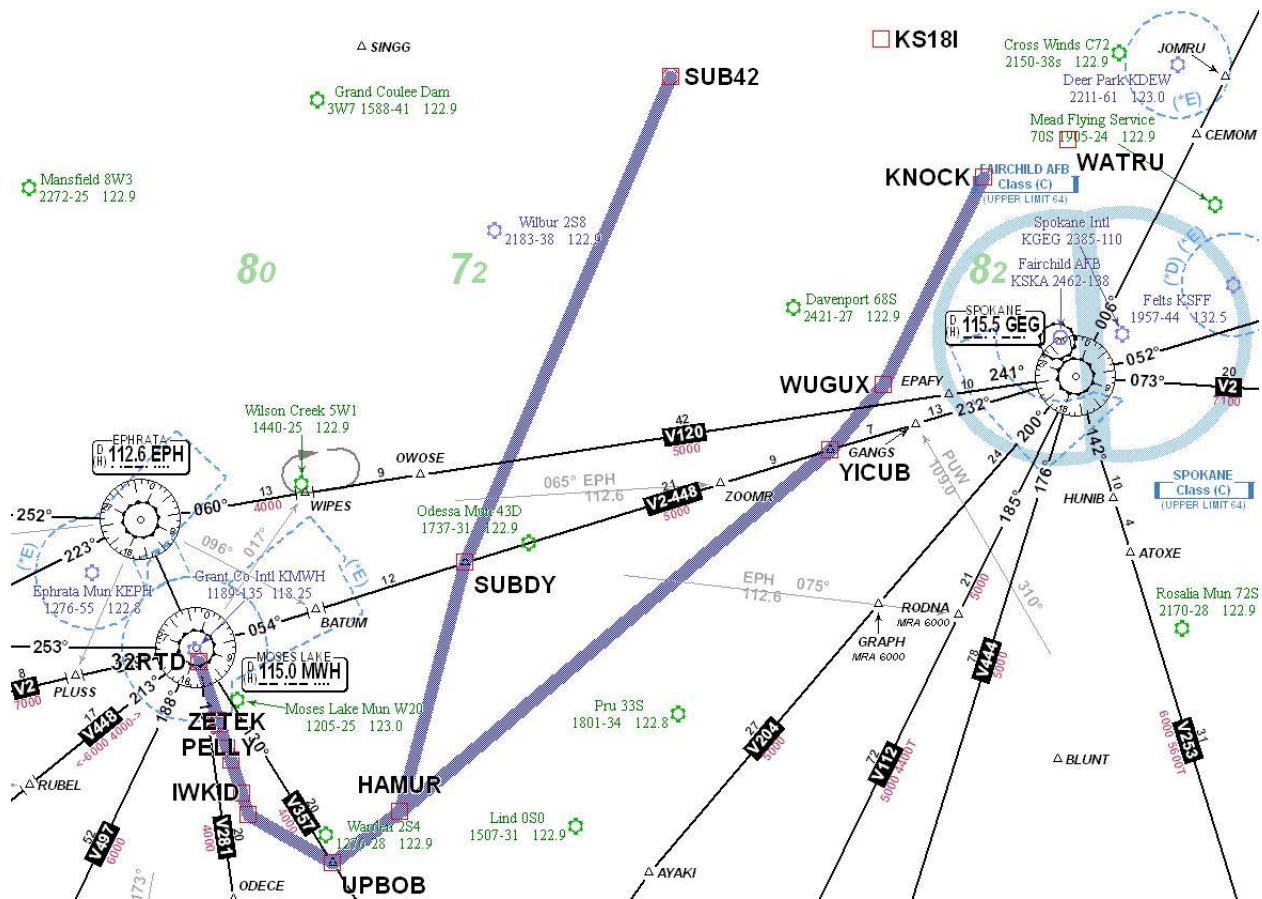

Figure 12. SUBDY and KNOCK arrival routes.

Both routes were also constructed roughly orthogonal to existing airways and jet routes in order to minimize the time of potential traffic conflict due to Spokane-Seattle traffic. Because previous ASTAR simulation studies at Langley Research Center and Ames Research Center had tested FIM operations with the Ownship and Target aircraft on merging routes, ASTAR was considered mature enough to implement flight trials in the real world for participant aircraft merging from separate routes.¹⁰⁻¹²

Three scenarios were used with the B787 Ownship following the targeted T-38. In Scenario One, both aircraft flew the SUBDY Arrival. In Scenario Two, both aircraft flew the KNOCK Arrival. For Scenario Three, the T-38 flew the SUBDY Arrival, whereas the B787 flew the KNOCK Arrival, merging at HAMUR behind the T-38.

3.3 Test Plan

Approximately two to five flight trials were expected during a single six-hour flight. Based on these expectations, the NASA team decided to complete a minimum of three trials along any *single* route for success, though testing of both Scenarios One and Two was preferred. If the flight test progressed successfully, the remaining trials would be dedicated to a multiple route structure. To ensure correct separation based on calculations prior to the event, the aircraft were given initial flight conditions for each trial of 120 seconds separation as the assigned spacing goal. Table 1 summarizes the planned test conditions.

Table 1. Flight Trial Test Conditions

Flight Trial	Scenario	Initial Flight Level (FL)	Initial Airspeed	Positioning
1	1	FL220	280 KIAS	13 NM In-Trail distance
2	2	FL220	280 KIAS	16 NM In-Trail distance
3	1	FL220	280 KIAS	10 NM In-Trail distance
4	3	FL220	280 KIAS	Arrive concurrently at Initial Approach Fixes (~7.5 nm along route distance)
5	3	FL220	280 KIAS	Arrive concurrently at Initial Approach Fixes (~7.5 nm along route distance)

In Flight Trials One, Two, and Three, the T-38 crossed the initial waypoint first with the B787 following. For Trials Four and Five, the T-38 planned to cross SUB42 waypoint at approximately the same time as the B787 crossed the KNOCK waypoint. Since the KNOCK Arrival was 7.5 nmi longer than the SUBDY Arrival, the B787 could be considered as initially having 7.5 nm along-route separation from the T-38.

Due to a difference in equipment, the T-38 flew the Instrument Landing System (ILS) approach to Runway 32R, while the B787 instead flew the Area Navigation/Required Navigation Performance (RNAV/RNP) approach to the same runway. The FAF for the RNAV (RNP) Z RWY 32R Approach, ZAVYO, was the pre-determined FIM termination point and also a convenient recognition point for the test pilots to begin other non-FIM-related testing. While both instrument approaches occur along the same lateral track, there exists a 0.3 nmi difference between FAF locations for the two approaches, which results in a spacing goal variance within the algorithm of 0.8 sec during the operational period of each FIM flight trial.

Prior to the flight test, NASA representatives familiar with FIM were prepositioned in the Seattle Air Route Traffic Control Center (ARTCC) facility and Grant County Approach facility. Each NASA representative was available to ATC personnel to answer questions and provide interpretation of the flight interaction between the T-38 and the ecoDemonstrator.

The flight test began at Boeing Field / King County International Airport (KBFI). Both aircraft departed KBFI and climbed to cruise altitude heading towards Grant County International Airport. Once above 10,000 ft., the laptop operator turned on the Boeing provided flight test laptop and set it up for the flight demonstration. The laptop operator requested Ownship information for the ecoDemonstrator aircraft such as cruise speed, descent speed, forecast winds, and expected initial route from the cockpit. All operations were conducted within the aircraft's normal flight envelope. Therefore, all flight conditions were coincident with passenger carriage using transport category operations.

3.4 Test Aircraft

3.4.1 EcoDemonstrator Research Aircraft

The Boeing ecoDemonstrator program supports long-term sustainable growth of aviation to improve commercial aviation's environmental performance throughout an airplane's lifecycle.¹³ To date, Boeing has tested three airplane types as flying test beds, a B737-800, B787-800, and B757, with future plans on two as-yet unannounced Embraer and wide-body twin aircraft. The 2014 B787 ecoDemonstrator was chosen by NASA due to schedule availability, as well as low risk for implementation of the bus architecture. The aircraft was a specially configured B787-800 Dreamliner model (ZA004, N7874), a mid-size wide-body, twin-engine jet airliner capable of long-haul direct routes. The modern on-board system architecture of this

aircraft is representative of NextGen capabilities. The Boeing ecoDemonstrator acted as the **Ownship** vehicle (the following vehicle) for the flight test.

3.4.2 Boeing T-38 Talon Fighter Jet

In coordination with the ecoDemonstrator, Boeing also supplied a 1961 Northrop/Thornton T-38A fixed-wing multi-engine aircraft to act as the **Target** vehicle for the flight test. N38TZ (BOE38T) was equipped with GE J85-5H turbojet engines with 3850 lbs. of thrust. The T-38 was equipped with a Global Positioning System (GPS) and ADS-B Out and flew ILS approaches along the same path as the B787's RNAV (RNP) approach. The aircraft was also equipped with engine anti-icing systems that were used during the flight test and required the engine to operate at high settings. The higher than normal engine settings affected normal operations since the T-38 was forced to maintain high ground speeds late in the trial, which created deviations from the nominal ground speeds calculated by the spacing algorithm.

4. Implementation: Functional Test Flight

Prior to the flight test, one hour of in-flight functionality testing was planned. The software package, transmission of data, and laptop readability were successfully tested on December 6, 2014.

With the foreknowledge that Boeing would depart from and return to Boeing Field, the team recognized a Standard Terminal Arrival Route (STAR) would be flown into Seattle prior to a landing at Boeing Field. Seizing on the opportunity to verify functionality and gather data, the team developed ASTAR routes into Seattle using the existing STAR structure already in place (Figure 13). Since the EFB and FMC were not connected with one another, route information for the B787 was not communicated directly to the EFB. Therefore, it was necessary to develop ASTAR routes specifically for the algorithm. The developed routes in Figure 13 include the CHINS Arrival (Cyan), HAWKZ Arrival (Red), MARNR Arrival (Orange), and GLAZR Arrival (Chartreuse). Testing on December 6 occurred over the Pacific Ocean and the aircraft returned using the HAWKZ4 Arrival, Battleground (BTG) transition near Portland.

Due to the risks associated with other experiments aboard this particular test flight, NASA was unable to participate onboard. A Boeing engineer familiar with the software was designated as the laptop operator for this flight. During the functional test flight, the laptop was turned on above 10,000 ft. with all valid fields completed by the operator prior to activation of the FIM software (as expected to be performed during the actual demo). After FIM Activation, the operator verified correctness of incoming data channels and laptop functionality.

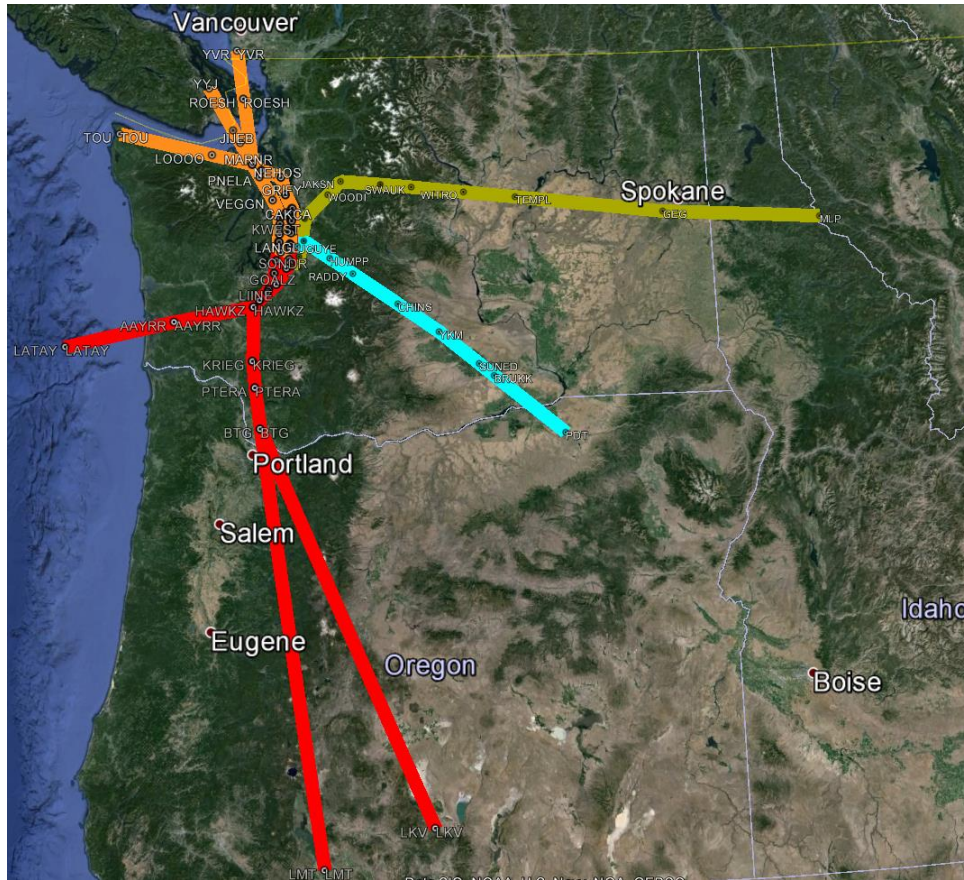

Figure 13. Developed test routes for a Seattle STAR.

The ecoDemonstrator pilot, with the help of Seattle Center, positioned the aircraft behind a Virgin America flight and successfully maintained timed-interval spacing from the preceding aircraft using speed guidance given by the ASTAR algorithm. The data received during the flight was verified with developers on the ground following the flight.

5. Implementation: Ancillary

5.1 Approvals

To meet flight safety requirements, Boeing provided a flight test training class for all participants that gave familiarization training in all applicable work areas. A flight clearance was also required by NASA Langley Research Center for all NASA participants that would ride aboard the Boeing aircraft. Therefore, NASA participants needed two sign-offs prior to flight in the demonstration aircraft.

All tested equipment and experiments aboard the B787 underwent an approval process with the Boeing Flight Test Coordination group. A Safe-To-Fly report was generated by Boeing with approval signatures needed before being allowed to participate in the ecoDemonstrator test flights. The NASA ASTAR flight test was paired with an experimental ADS-B system, resulting in two Safe-To-Fly reviews prior to allowing ASTAR on-board.

5.2 Staging Locations

Briefing, embarkation, and launch of both aircraft occurred at Boeing Field (KBFI). The Seattle ARTCC and Grant County Approach were the controlling authorities for the airspace associated with the ecoDemonstrator flight. NASA representation occurred at both FAA facilities – Seattle Center (ZSE) in

Auburn, WA and Grant County Approach in Moses Lake, WA. Two NASA and a Boeing representative observed at ZSE, while a former FAA terminal controller from NASA went to Grant County Approach. ZSE served as the initial hub of controller operations with Sector 11/07 providing air traffic control services out to the testing airspace.

Grant County Approach served as the receiving location for the inbound test flights and provided air traffic services from handoff at approximately FL220 until completion of the landing phase or missed approach.

As previously noted, two staging locations, or Hold points, were identified but not used: WATRU and KS18I. The hold points were intended to allow time for ATC to clear out the demonstration area, providing uninterrupted flight trials, and they were also intended to give the test pilots a means to coordinate the positioning of the test aircraft.

5.3 Training

Training for all laptop operators occurred throughout the development process. On the day of the flight, a safety briefing was conducted as part of the pre-flight brief for all riders onboard the B787, and once onboard, a second safety briefing identified the location of all flight safety equipment and egress ports. All flight crew and passengers were advised as to the required personal equipment and any restrictions on personal equipment use. All other personal equipment requirements and restrictions were briefed as part of the Boeing Flight Test Clearance Class.

ATD-1 experiments prior to the ASTAR flight test typically provided both classroom and simulator FIM training to pilots before actual testing. Because the ecoDemonstrator was conducting multiple flight experiments prior to the ASTAR flight test, the B787 pilots reached mandatory rest requirements the day prior to the test. Therefore, new pilots were assigned for the following morning. The only information available for the new pilots prior to the flight was the Boeing Flight Test Plan document and the morning briefing. This served as a lesson for the forthcoming ATD-1 FIM Flight Test to identify and train backup flight crews.

6. Test Flight

The ASTAR flight test occurred December 12, 2014 with five flight trials. During the test, flight test participants occupied six stations on board the ecoDemonstrator aircraft (Table 2).

Table 2. ASTAR Flight Test Participants

Flight Test Support	Title
NASA Laptop Operator	Principal Investigator
Development Support	NASA Software Engineer
ASTAR Support	NASA Software Engineer
Boeing Software Support	Boeing Project Lead
Boeing Flight Test Support	Flight Test Engineer
ecoDemonstrator Pilots	B787 Project Pilot
ecoDemonstrator Pilots	B787 Project Pilot
T-38 Pilot	Boeing Project Pilot
NASA Liaisons to Seattle Center	ATD Deputy Project Manager and ATD-1 Chief Engineer
NASA Liaison to Grant County Approach	ATC Specialist

As the main operator of the flight test, Boeing assumed responsibility for hazard mitigation and required both aircraft to see and avoid the ground and other aircraft. As part of the safe-to-fly report, the T-38 aircraft was also constrained from flight into known icing. Although the T-38 target aircraft does not have anti-icing capabilities for the wings, empennage, and inlet ducts, it does have engine anti-ice, pitot heat, and canopy defog heat which provides windshield heat for adverse weather operation.

The freezing level during the flight was approximately 10,000 ft., but the stratus cloud layer was much higher and presented no hazard to the T-38. While en route to the test location, a cloud layer existed from 16,000 ft. up, with tops typically around FL220. Therefore, cruise altitudes were adjusted to FL230 to the testing location, and for safety reasons, the T-38 performed a higher than normal descent rate until clear of the cloud layer.

6.1 Data Collection

Incoming data from the two ecoDemonstrator flight test buses was recorded electronically using the flight test laptop from the en route cruise to arrival phases of flight. Recorded data included ADS-B In Target state data as well as Ownship state data. Static video recorders placed within the cockpit of the B787 ecoDemonstrator captured videos of the Control Display Unit (CDU), Head-Up Display, Navigation Display, and Primary Flight Display for each trial. These videos were provided by Boeing. En Route Automation Modernization (ERAM) videos for Seattle Air Route Traffic Control Center Sector 11/07 and communication during the test flight were provided by Seattle Center. ERAM displays processed flight radar data and generated display data for air traffic controllers.

6.2 Results

The primary objective of this flight test was to assess the operational risks of performing IM in operational use airspace; therefore, a limited number of trials was considered sufficient for that purpose. During the course of the flight test, the operators of both vehicles maintained adequate levels of separation between their aircraft and were never placed in an unsafe condition due to commanded FIM speeds. Feedback received from all pilots and controllers involved in the flight test have been complimentary of the spacing accuracy of the arriving test aircraft.

While en route to the test location, weather model forecast winds from the cockpit CDU were relayed to the laptop operator for input into the simulated EFB. This single set of winds was the only available set for the duration of the flight test, with 16,000 ft. the lowest forecast altitude. The EFB was designed similar to many commercial transport category aircraft computers such that only four wind altitudes could be input into the simulated EFB. Therefore, the operator chose the below set as most representative for the test conditions:

FL230	190 degrees / 64 knots
FL210	193 degrees / 54 knots
FL180	190 degrees / 40 knots
16,000	260 degrees / 19 knots

The ASTAR algorithm linearly interpolated the values that were input in order to determine forecast wind values at other altitudes. Also, the version of the algorithm used during this flight was preconfigured for calm winds at the airport surface. Coincidentally, calm winds were broadcast at Grant County International Airport during the course of the demonstration.

The delivery error for timed aircraft arrivals presented in Table 3 was directly measured from the associated error for an individual trial. The delivery error is defined as the difference between the achieved spacing interval, which is the elapsed time between when the Ownship and Target aircraft cross the achieve-by point, and the assigned spacing goal set at the beginning of the trial. It should be noted the delivery error occurs at the end of the trial which differs from the spacing error that is calculated throughout the FIM operation. Negative numbers indicated the achieved spacing interval was less than the assigned spacing goal (i.e., the Ownship aircraft arrived earlier than anticipated). Positive delivery error indicated the achieved spacing interval was greater than the assigned spacing goal (i.e., the Ownship aircraft arrived later than anticipated). Based on previous experiments, a targeted goal was to demonstrate consistent final spacing with a mean delivery accuracy of ± 5 seconds at the FIM termination point.^{2,10,14-16} When weighing all trials against the expected time of arrival, the Ownship aircraft was on average -1.22 seconds early (Table 3). As noted previously, the test pilots had neither FIM training, nor FIM expertise prior to the flight test. On the initial trial, the B787 arrived 7.5 seconds early (112.5 s. separation), which is greater than twice the error for every subsequent trial and may be due to this lack of FIM training and experience. Discounting the initial trial, the Ownship aircraft was on average 0.35 seconds late (+0.35 s.) for Trials Two to Five. Both averages are less than two seconds from the desired spacing and highlight the efficacy of the algorithm.

Table 3. Delivery Error at Achieve-by Point

Flight Trial	Delivery Error (sec)
1	-7.5
2	1.5
3	1.4
4	2

5	-3.5
Average	-1.22
Std. Dev.	4.16
Range	9.5

The number of speed changes commanded by the ASTAR algorithm and then received by the flight crew was also evaluated against previous studies. Within this flight test, a total number of 61 speed commands were issued over the course of 5 trials for an average of 12.2 speed changes per trial. Fast time simulations have shown an average of 10.6 FIM speed commands, including published speed changes.¹⁷ On average, there were approximately 0.72 speed changes per minute for the ecoDemonstrator, or one speed change every 83 seconds. FIM studies in simulation have demonstrated a lower rate of speed commands, where humans-in-the-loop incurred 0.62 speed changes per minute, and 0.4 for fast time simulations without human variability.^{17, 18} In the case of the ecoDemonstrator, the Target T-38 vehicle was not always able to follow the descent profile of a transport category aircraft, which may have contributed to the increased rate of speed changes. In this flight test, there was no indication from the flight crew regarding acceptability of the number of speed changes experienced. Speed changes for an individual flight trial have been detailed at the end of each trial study.

For the following flight trial studies, the full route structure of the eastern SUBDY route and western KNOCK route are depicted graphically in orange on a Google Earth image. The T-38 travel route is always depicted in purple, while the B-787 travel route is always depicted in yellow. Since the T-38 was hand-flown, the purple flight path crosses back and forth along the autopilot-driven B787 route, which can be seen on the Google Earth image as varying yellow and purple.

It should also be noted for the following studies, the 4D trajectory Profile CAS was based on published speed constraints and a few additional assumptions, while the route used for these flight trials had a large deceleration segment just prior to the FAF. The spacing error often trended earlier during that deceleration segment due to a mismatch between the deceleration predicted by the ASTAR spacing algorithm and the deceleration of the Ownship. Since the ASTAR spacing algorithm is based on a proportional control law, spacing error is corrected by flying speeds above or below the nominal speeds. The speeds return to the nominal speed profile as the spacing error is corrected. There is an additional ground speed term that can augment this behavior if the Target aircraft is not flying its predicted groundspeed; however, that ground speed term is not active when the Ownship is close to the achieve-by point. In flight trials one, two, four and five, ASTAR commanded a speed below the nominal profile speed due to the spacing error. As the spacing error was corrected, the commanded speeds increased toward the nominal speed. This behavior caused a dip in the spacing and speed increases toward the end of the run.

6.2.1 Summary of Flight Trial One

On the initial flight trial, both aircraft were en route from Boeing Field and each performed a teardrop maneuver at the initial SUBDY route waypoint (SUB42), which placed the vehicles in correct starting positions for the trial. Figure 14 details the flight paths of both vehicles along the SUBDY route.

Cloud layers with icing potential in the vicinity of the test location forced the lead aircraft to modify its descent profile, which caused the spacing algorithm to command additional speed commands. The freezing level was forecast at 10,000 ft. with a broadcast 8000 ft. overcast cloud layer at Grant County airport. Cloud tops were approximately FL220 in the vicinity of the test location; therefore, initial altitudes for all flight trials were adjusted to FL230. In an effort to mitigate potential icing for the T-38 Target aircraft, the pilot descended steeply on his first pass through the cloud layer (Figure 15), broke out at 16,000 ft., and was able to maintain Visual Flight Rules until landing. The T-38 maintained a standard descent rate on subsequent trials once it was determined the cloud layer was a low icing threat.

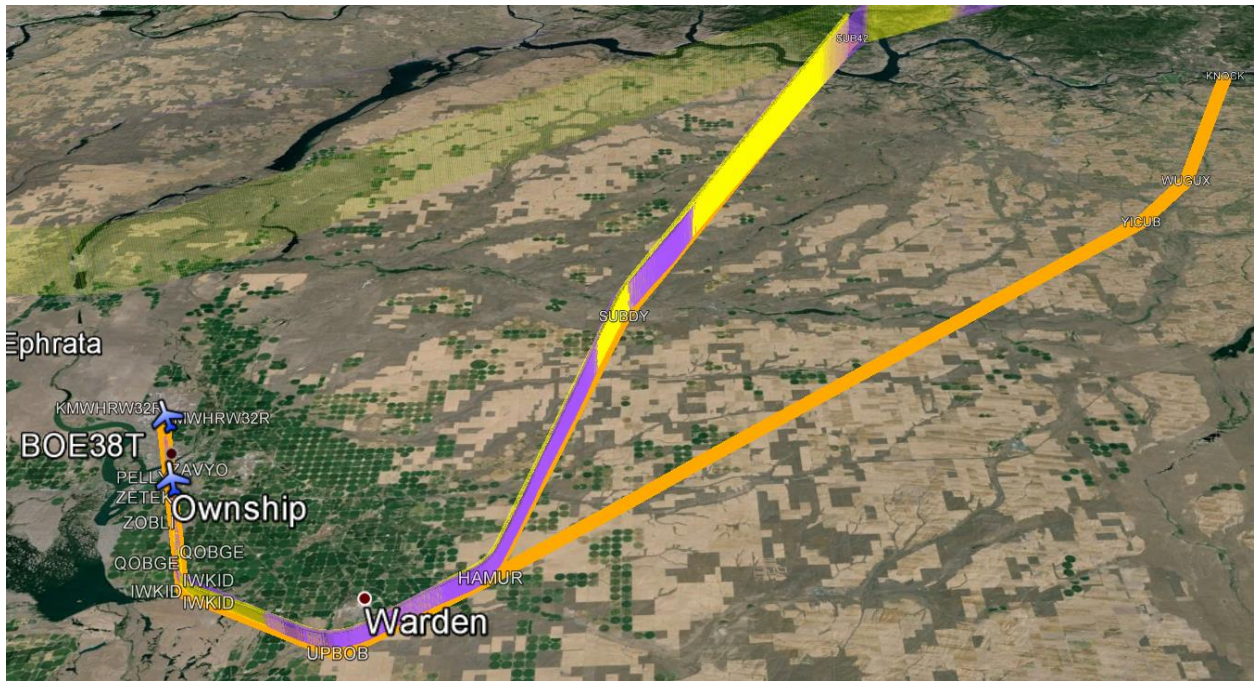

Figure 14. Flight trial one on SUBDY route.

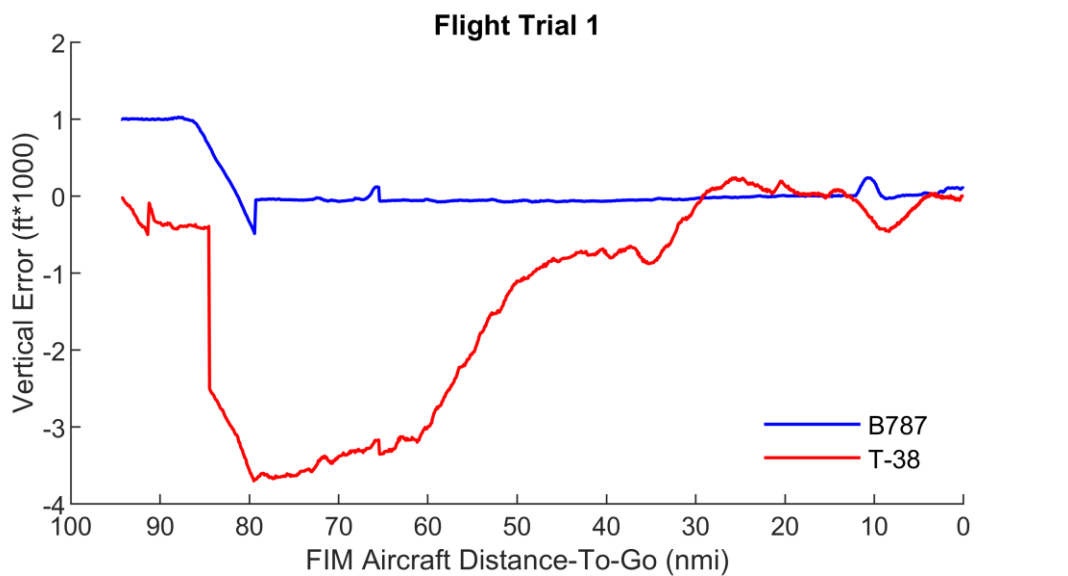

Figure 15. Flight trial one vertical error (difference from profile altitude).

Figure 16 and 17 show the progression of IM commanded speeds and spacing error throughout the IM operations. While the spacing error varied between approximately +/- 20 s., the delivery error at the end of the flight trial (primary metric) was -7.5 s. (early, see Table 3). There are a number of aspects that affected the changing commanded speed: the path and altitude conformance assumed by the FIM equipment and how well the Ownship conformed to the commanded speeds.

One notable change in spacing error occurred from 80 to 60 nmi from the achieve-by point when the Target flew an altitude approximately 4000 to 3000 ft. lower than the trajectory assumed by the FIM prototype (Figure 15) in order to avoid icing conditions, causing the commanded speeds and spacing error to change (Figures 16 & 17, A). During the same period, the Ownship had difficulty conforming to the commanded speeds without using speed brakes, which over time, led to a large change in the spacing error. Due to the highly efficient lift-to-drag design of the B787, the B787 took longer to slow down than the simulated B757 dynamics model used to test the spacing algorithm prior to the flight trials. This caused the B787 to lag behind the commanded speed for the aircraft. The profile calibrated airspeed (black line, Profile CAS) described the speeds used by ASTAR to calculate a nominal 4D trajectory for the Ownship. The nominal 4D trajectory speeds represent the speeds the aircraft should take based on assumed knowledge of aircraft cruise speed, altitude, and any procedural speed constraints along the specific route. The effects of both the Target's altitude deviation and the Ownship's inability to slow to the new commanded speed quickly are evident in the spacing error (Figure 17). At 75 nmi distance-to-go (DTG) to the achieve-by point (Figure 16), the commanded speed (blue line, Cmd Spd) slowed from 270 knots to 240 knots because the Target was flying an altitude lower than its nominal 4D trajectory altitude, causing the Target to have a slower ground speed than expected. The B787 took approximately 10 nmi to reduce the vehicle airspeed, recorded as the Calibrated Airspeed (red line, CAS), to the commanded speed, by which time the ASTAR algorithm increased airspeed to 280 knots. Commanded speeds continued to increase to 290 knots as the aircraft engines spooled up to meet the speeds commanded by the algorithm. At approximately 20 nmi DTG, commanded speeds began a stepwise decrease, which the aircraft aggressively employed speed brakes to meet.

Another notable behavior occurred between 12 and 7 nmi DTG. Even though the pilots, who were unfamiliar with the procedure, aggressively utilized speed brakes during the latter half of the trial, the vehicle remained faster than the commanded speed. The Ownship did not slow as fast as the algorithm expected which initially made the Ownship early (Figure 16 & 17, B). An aggressive slowdown caused the B787 to end up approximately 20 knots slower than the T-38 Target near final approach fix, which lessened the spacing error (Figure 17, C), while causing an increase in the Ownship commanded speed (Figure 16, C). Note, the achieve-by point occurs at the RNAV final approach fix, which is labeled 0 nmi in the graph. There were thirteen speed commands for the entire trial, with an average of one command every minute and thirty-three seconds.

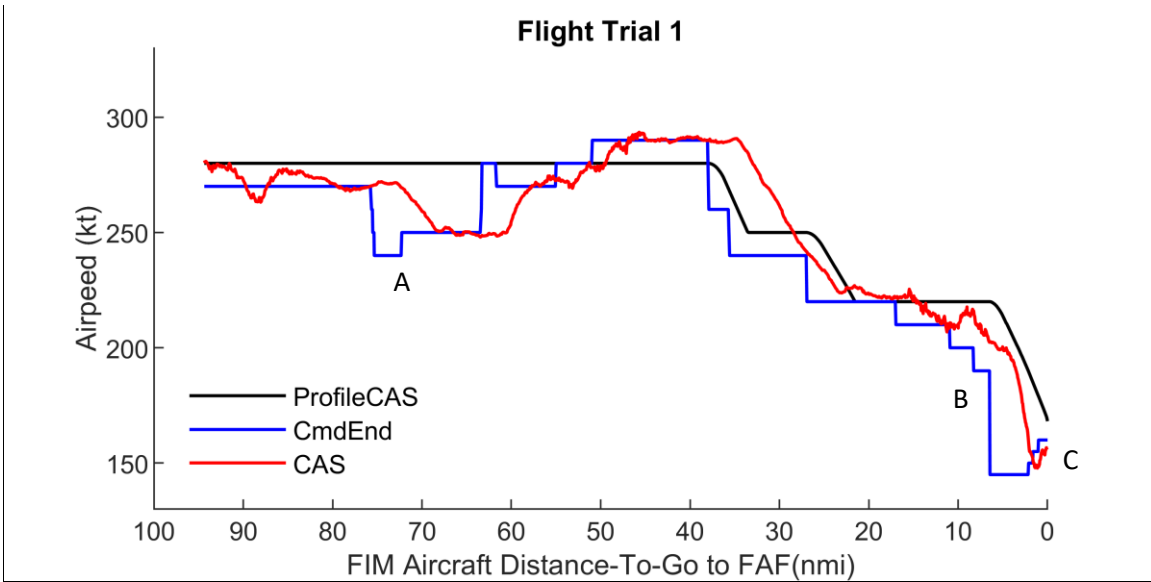

Figure 16. Flight trial one FIM command speeds.

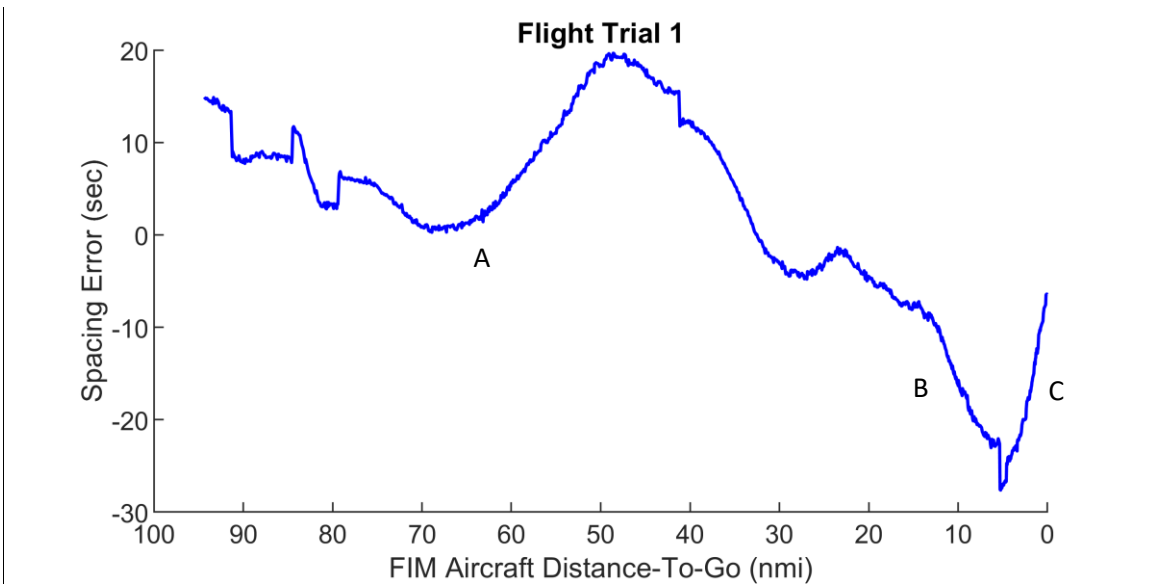

Figure 17. Flight trial one spacing error vs. distance from the achieve-by point.

6.2.2 Summary of Flight Trial Two

During the second flight trial on the easterly KNOCK route, non-uniform aircraft positioning placed the B787 far behind the T-38 Target. Figure 18 details the flight paths of both vehicles along the KNOCK route.

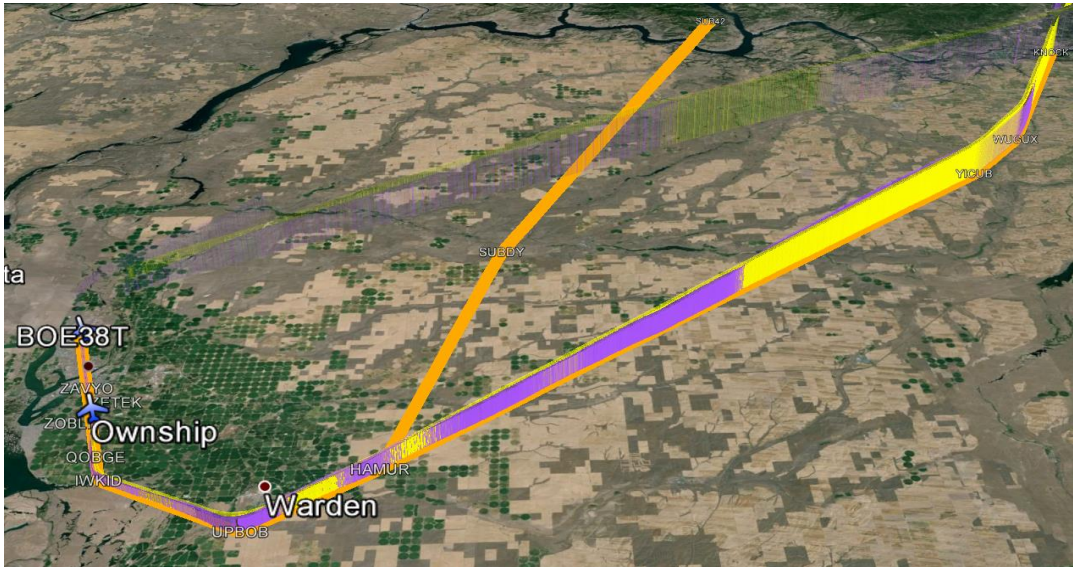

Figure 18. Flight trial two on KNOCK route.

The T-38, represented by the purple path, performed a teardrop entry, while the B787, represented by the yellow path, initiated a circling maneuver (Figure 19). In an attempt to make up the distance prior to trial initiation, the pilot of the B787 increased airspeed to 340 knots.

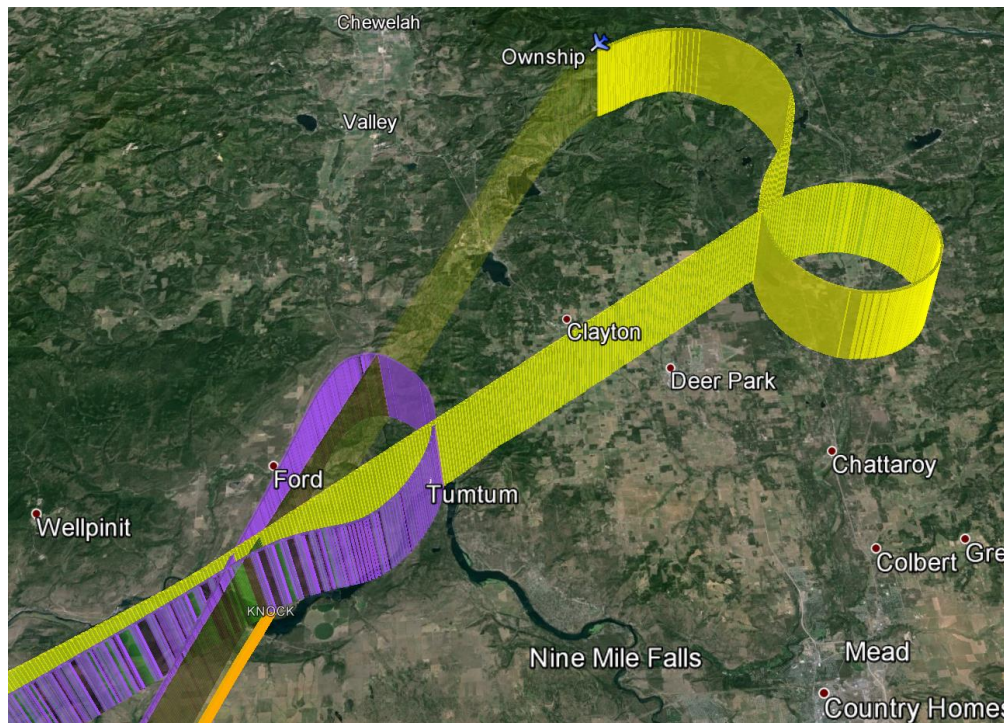

Figure 19. Flight trial two Target and Ownship positioning.

Rather than lose this particular trial, the laptop operator made the decision to change the timed spacing goal from 120 seconds to 150 seconds for two reasons. First, the spacing goal was changed to prevent a potentially unsafe condition caused by a combination of less than ideal aircraft set up and the fact that the laptop operator, who was seated outside the cockpit, did not have full awareness of separation trends between vehicles. Second, the algorithm by design was speed limited to 250 knots at 10,000 ft. and may have been unable to correct the large spacing error caused by the Ownship and Target positioning. After crossing 10,000 ft., the Ownship would have a constrained maximum speed, which could limit the chance of making up the lost distance. Modifying the spacing goal reduced the spacing error to an achievable value.

Since the primary goal of FIM is to achieve a precise spacing goal, the spacing goal that was used was only tangentially related to the success of the flight trial. In this case, 16 nmi distance between aircraft at trial initiation was planned, but actual distance was 24.12 nmi. The Ownship crossed the achieve-by point at 151.5 seconds, or 1.5 seconds later than the assigned spacing goal.

In Figure 20, the reader will notice commanded speeds (blue line) were higher than the profile speeds (black line) between 90 and 40 nmi. While 150 seconds spacing was input, the B787 Ownship was still approximately 120 seconds behind schedule at FIM initiation, which required slightly higher speeds to shorten the distance between Ownship and Target. At 75 nmi, the T-38 vectored 0.5 nmi off-route which caused a 30 knot slow ground speed error, resulting in a commanded speed decrease. The speed brake was underutilized for this and all remaining flight trials, and the trend can be seen here in the same figure where the B787 calibrated airspeed (red line, CAS) was usually faster than the commanded speed between 40 and 5 nmi.

Actively following the commanded speed guidance nullified the spacing error by the achieve-by point (Figure 21). There were a total of 14 speed commands, averaging one command every minute and 17 seconds over the course of the trial.

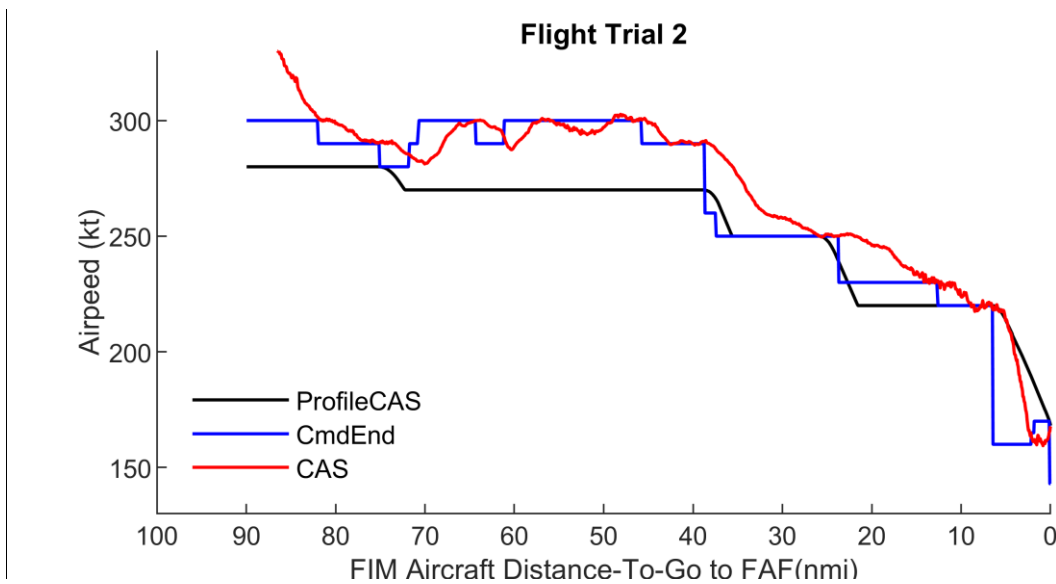

Figure 20. Flight trial two FIM command speeds.

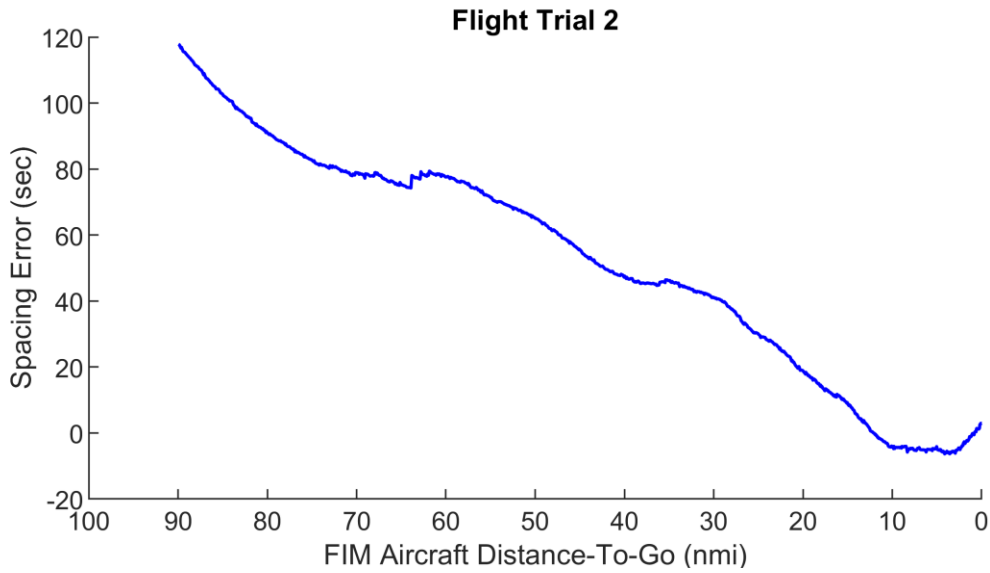

Figure 21. Flight trial two spacing error vs. distance from the achieve-by point.

6.2.3 Summary of Flight Trial Three

For flight trial three, a discrepancy between how aircraft chose to cross the initial fix for the western SUBDY route led to a near cancellation of the trial. Figure 22 details the flight paths of both vehicles along the SUBDY route.

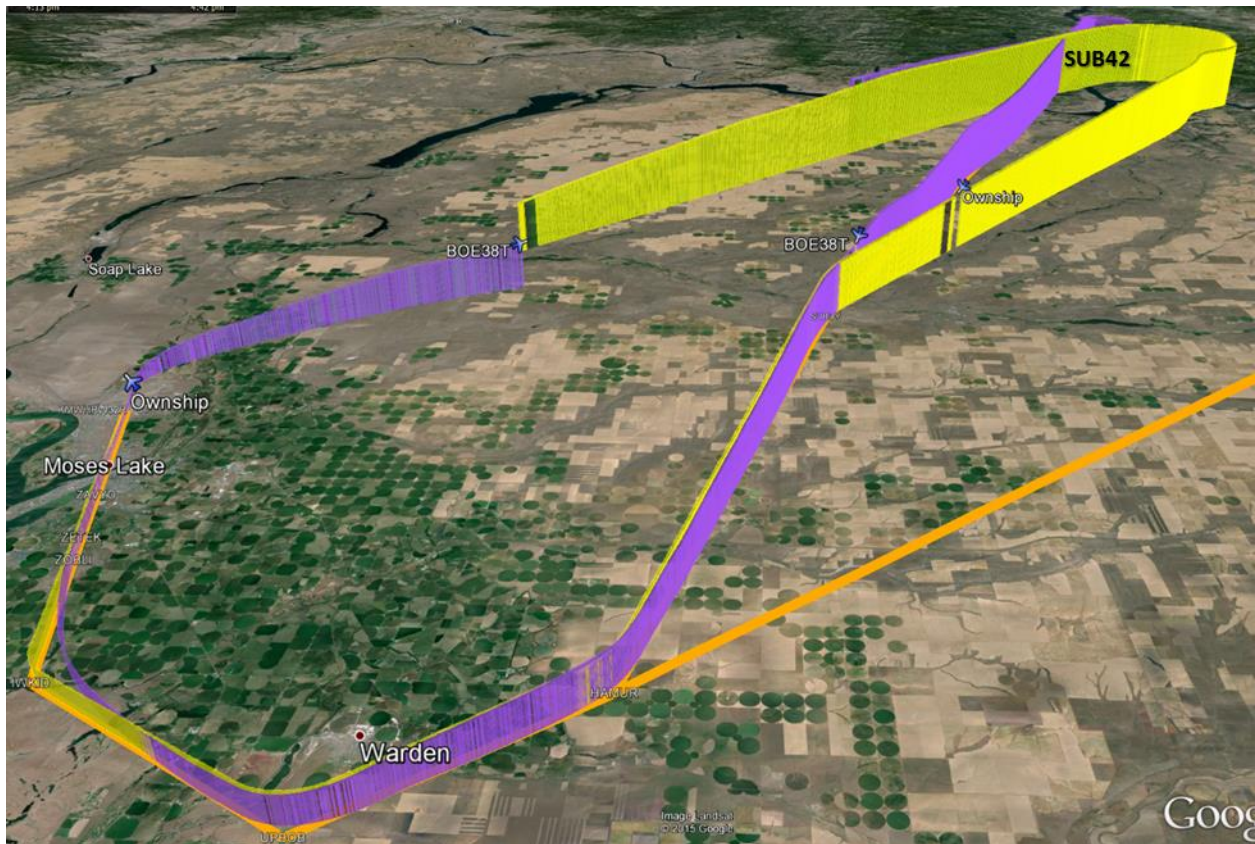

Figure 22. Flight trial three on SUBDY route.

While the T-38 overflew the initial waypoint (SUB42) and performed a teardrop entry to the route, the following B787 flight crew programmed a direct-to command into the FMC, which created a flight path crossing over SUB42, but then turned the aircraft south to rejoin the path (Figure 23). From the pilot's perspective, the aircraft was following the programmed flight path precisely, but from a performance standpoint, FIM would not initiate because the aircraft was greater than 0.5 nmi off the expected arrival route. Since the flight test gateway (Figure 5) displayed a reduced separation distance between test aircraft to the laptop operator, and the B787 pilots insisted the aircraft was on the correct flight path, engineers on-board the Ownship believed the laptop may have gone to a hung state and was not updating correctly, and therefore needed to be rebooted. In fact, the B787 was closing horizontally on the route path and would have begun displaying speed commands within the next few minutes. After rebooting and re-entering FIM information, the speed command immediately displayed. Forecast winds were not entered on this trial due to time constraints, which caused the estimated time-to-go calculated by ASTAR to be less accurate than it would have been if forecast winds had been entered.



Figure 23. Flight trial three aircraft flight paths near SUB42 waypoint.

The resultant data was half as long as other flight trials at 43.78 nmi length. Separation between aircraft was 6.23 nmi at the time of FIM initiation, which was below the planned 10 nmi. In Figure 24, the B787 maintained a calibrated airspeed (CAS) higher than commanded speed (CmdEnd) during much of the trial. The trend to null the spacing error steepened as the B787 speed aligned with the commanded speed (Figure 25).

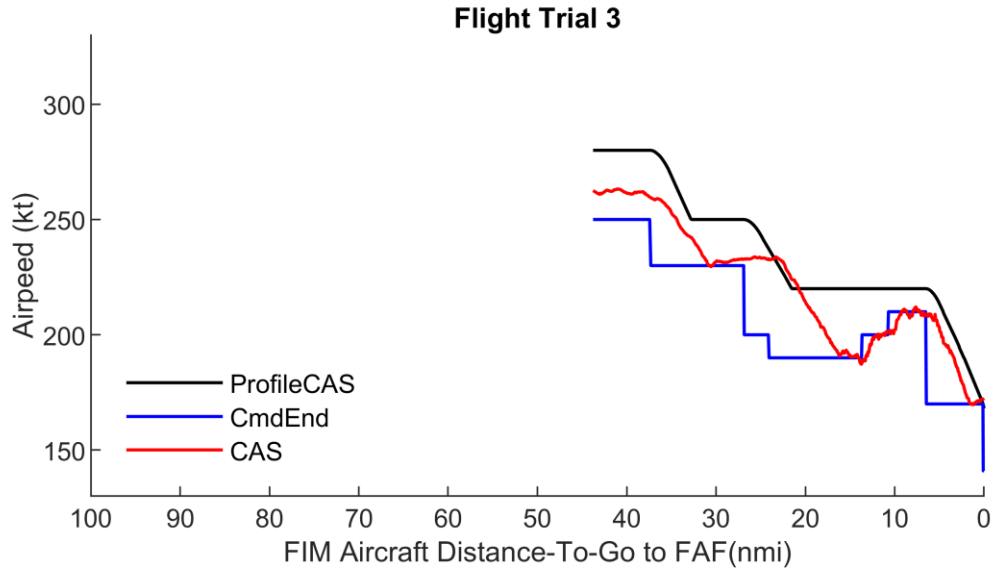

Figure 24. Flight trial three FIM command speeds.

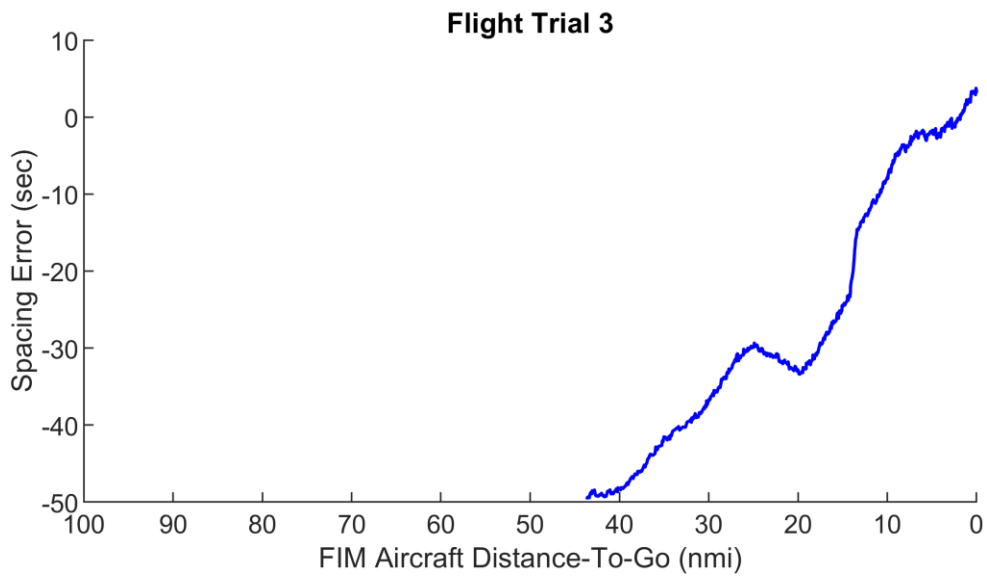

Figure 25. Flight trial three spacing error vs. distance from the achieve-by point.

During the period in which the T-38 leveled off and maintained a ground speed close to 180 knots (around 10 nmi distance), the B787 continued to slow down (Figure 26). The spacing correction trend slowed significantly, causing the Ownship to arrive 1.4 seconds late relative to the expected timed spacing interval of 120 seconds (Figure 26). During the course of the trial, there were seven speed commands with an average of one command every minute and seventeen seconds.

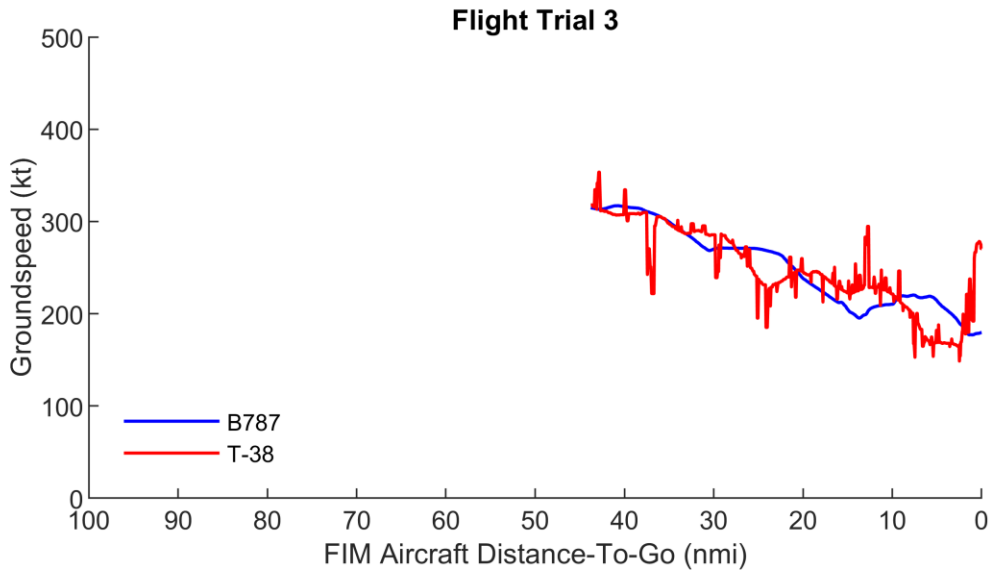

Figure 26. Flight trial three aircraft ground speed vs. distance from the achieve-by point.

6.2.4 Summary of Flight Trial Four

For flight trial four in Figures 27 to 30, the T-38 crossed SUB42 waypoint early, which caused the B787 to join at WUGUX waypoint. Figure 27 details the flight paths of the T-38 along the western SUBDY route and the B787 along the eastern KNOCK route.

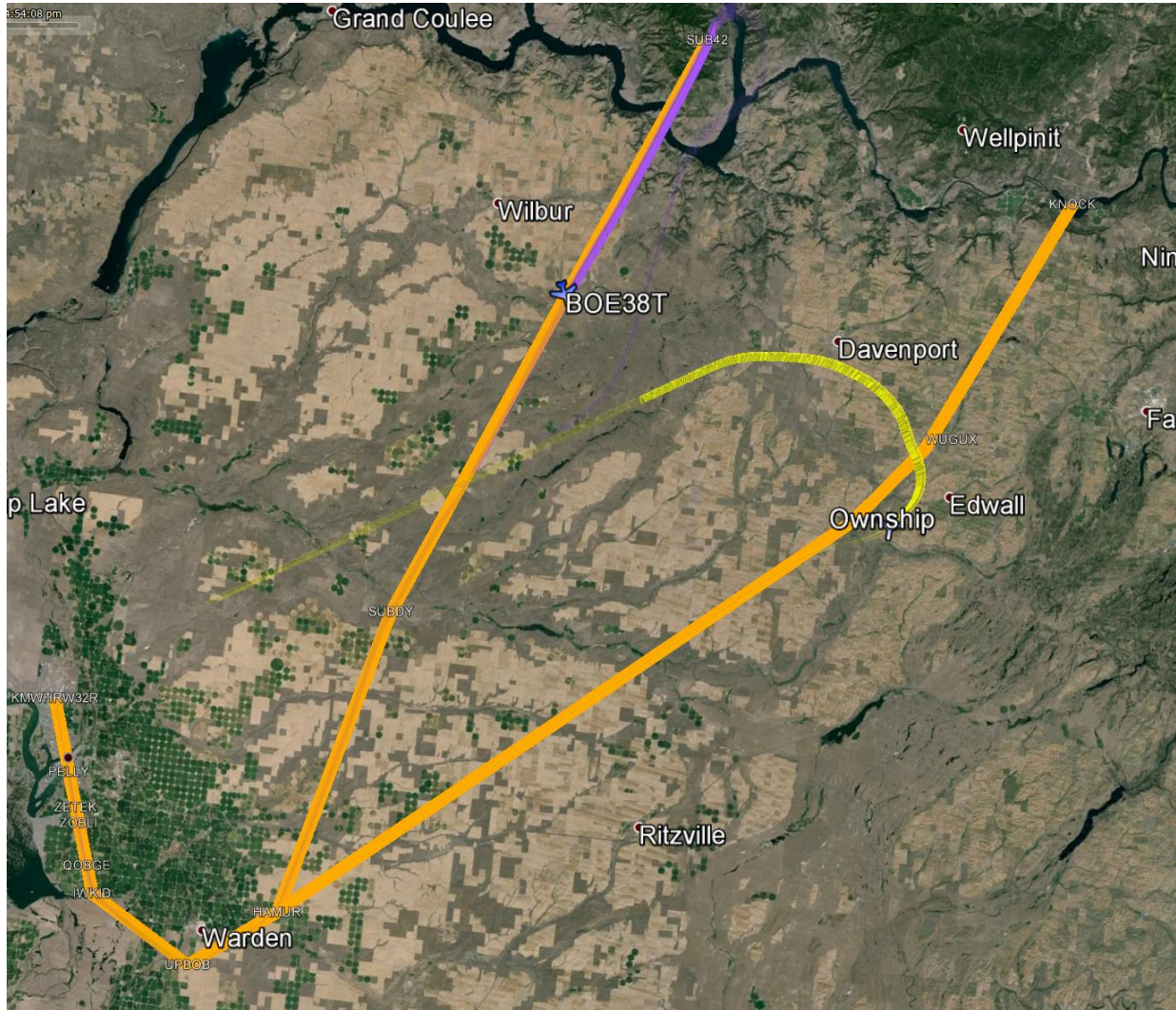

Figure 27. Flight trial four aircraft on both routes.

When calculating distance between each aircraft's present position and the achieve-by point, the difference between Ownship and Target was 1.63 nmi. In other words, if both aircraft had been on the same route there would be a 1.63 nmi 'along route' separation between them, a violation of regulatory separation minima criteria. The T-38 ground speed was also initially 50 knots slower than the B787. ASTAR managed to correct a very challenging spacing error of 80 seconds too early by commanding a much lower speed of 230 knots rather than the 270 knot profile speed in order to reduce the spacing error (Figure 28), which in turn, increased separation distance between both aircraft. A commanded speed which was much lower than nominal profile speed resulted in a steady progression to null the spacing error (Figure 29).

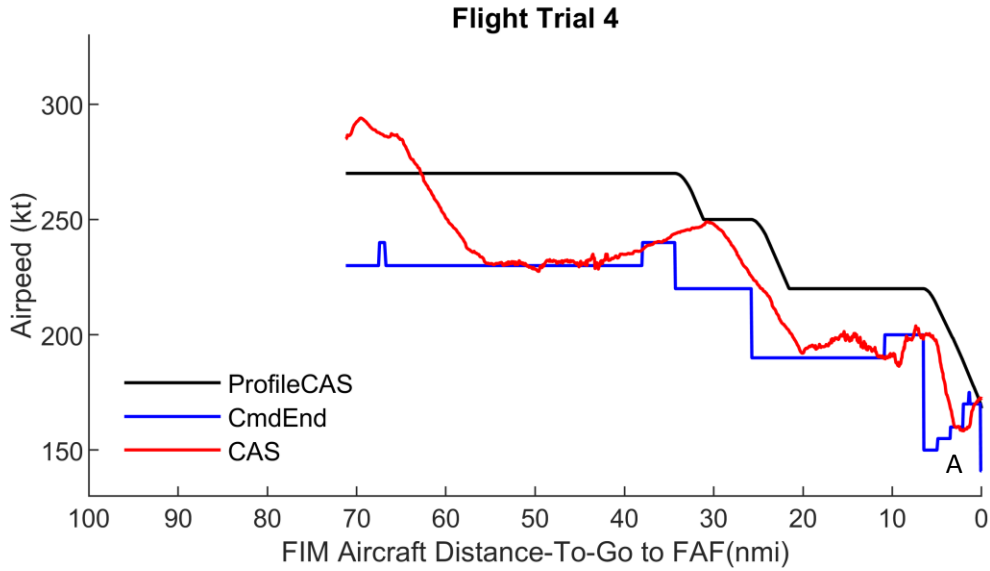

Figure 28. Flight trial four FIM command speeds.

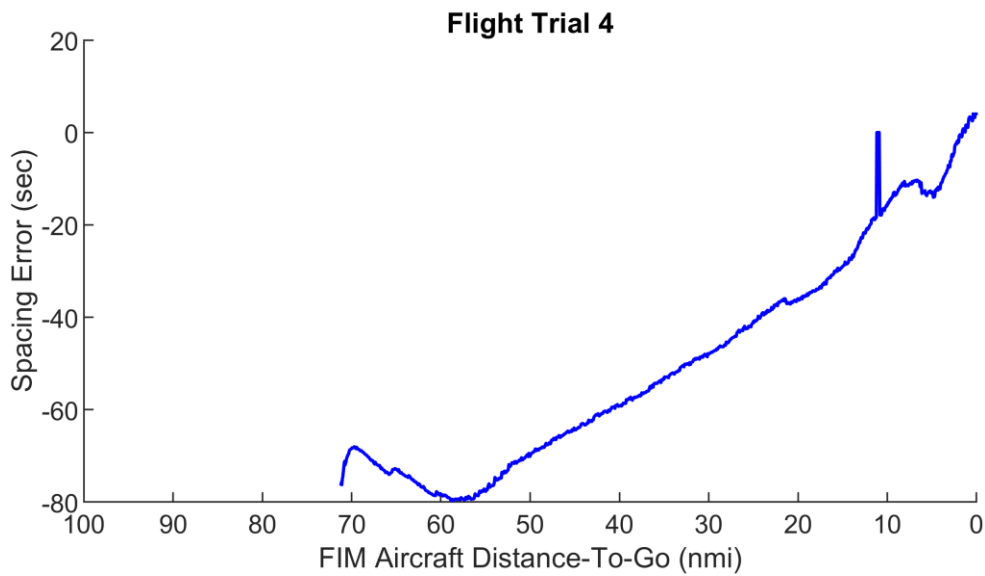

Figure 29. Flight trial four spacing error vs. distance from the achieve-by point.

Decelerations by the T-38 and design of the arrival led to large drops in Commanded FIM speeds. During the approach phase, increased airspeed by the T-38 to maintain level flight caused faster than expected ground speeds resulting in a stepwise increase to the commanded end speed (Figure 28, A). Similar increases to commanded speeds occurred due to excessive T-38 ground speeds at 68 and 40 nmi (Figure 30).

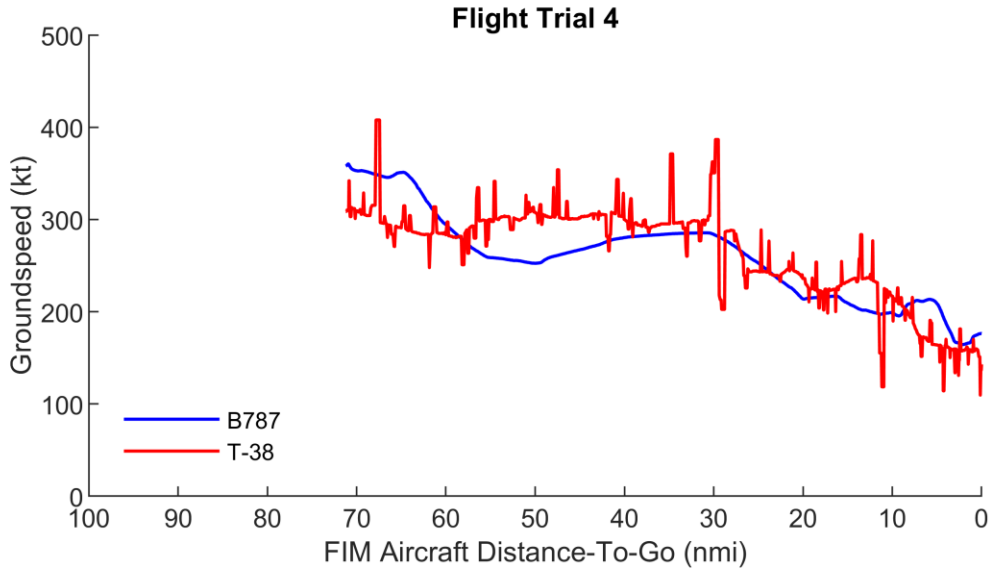

Figure 30. Flight trial four aircraft ground speed vs. distance from the achieve-by point.

A 7-second loss of Target trajectory data occurred approximately 11 nmi prior to the airport, resulting in a noticeable change of commanded speed within the EFB simulation on the research laptop. During the period of data loss, the Target trajectory data displayed a 120 degree shift from the correct heading and caused a noticeable spike in Figures 29 and 30. Over the course of the trial, there were thirteen speed commands with an average of one command every minute and twenty-six seconds.

6.2.5 Summary of Flight Trial Five

On the final flight trial, both aircraft concurrently arrived at their start locations for 10.83 nmi ‘along route’ separation. Figure 31 details the flight paths of the T-38 along the western SUBDY route and the B787 along the eastern KNOCK route.

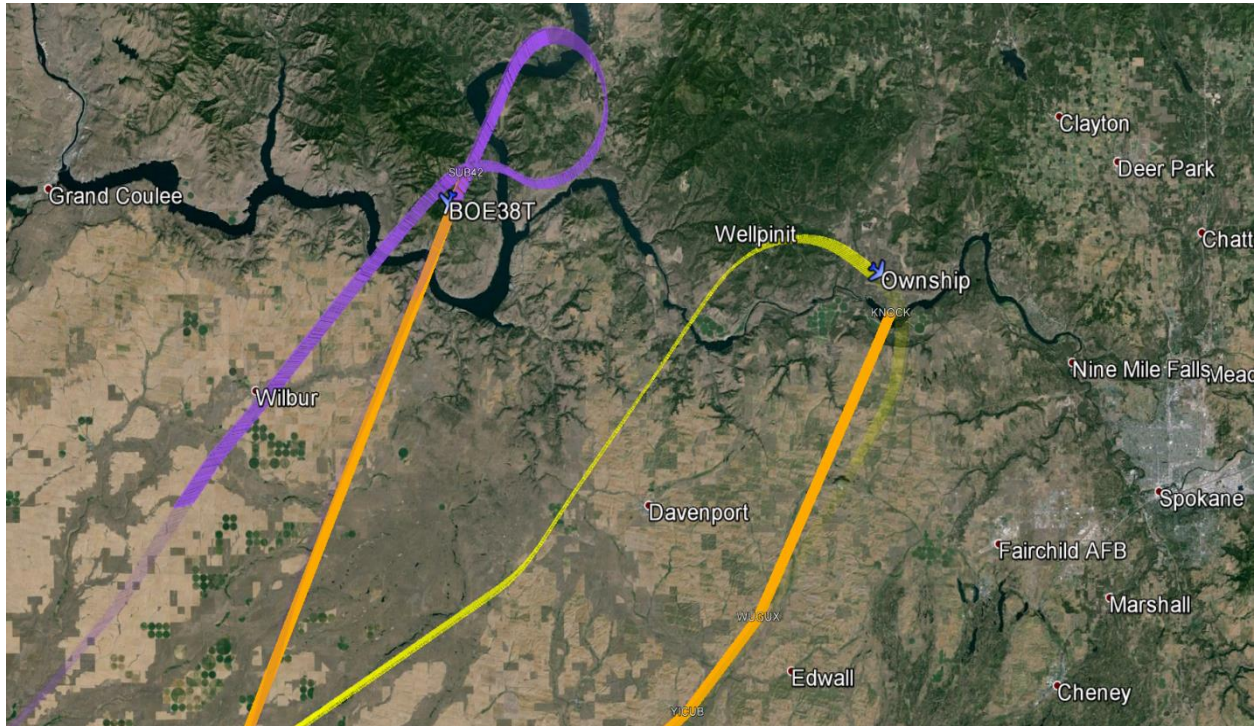

Figure 31. Flight trial five aircraft on both routes.

The aircraft set up placed the Ownship approximately 30 seconds later than the 120 second spacing goal (Figure 32). The B787 was fairly responsive to changes in the commanded speed for most of the trial. At approximately 67 nmi prior to the achieve-by point, the B787 descended more steeply through the cloud layer, causing an increase in airspeed (Figure 33).

A second trend reversal to the spacing error occurred 5 nmi prior to the achieve-by point due to action by the T-38 Target (Figure 34). The T-38 reduced speed by 40 knots, then held that speed to maintain level flight until the final approach fix. The Target’s altitude did not match the optimized descent profile expected to mimic a transport category aircraft, and instead was consistently lower during this trial. At approximately 8 nmi from the FAF, the Ownship’s 4D trajectory Profile CAS (Black line, Figure 33) reduced from 220 knots to 170 knots, a 50 knot speed decrease. As stated earlier in the paper, the 4D trajectory Profile CAS was based on published speed constraints and a few additional assumptions. At approximately 8 nmi from the FAF, the Ownship was 10 seconds early. As the Ownship decelerated, the spacing error was reduced causing the commanded speed to return to the 4D trajectory Profile CAS. However, following the speed commands did result in a delivery error of 3.5 seconds early (-3.5 s.). Over the course of the flight trial, there were fourteen speed commands with an average of one command every minute and twenty seconds.

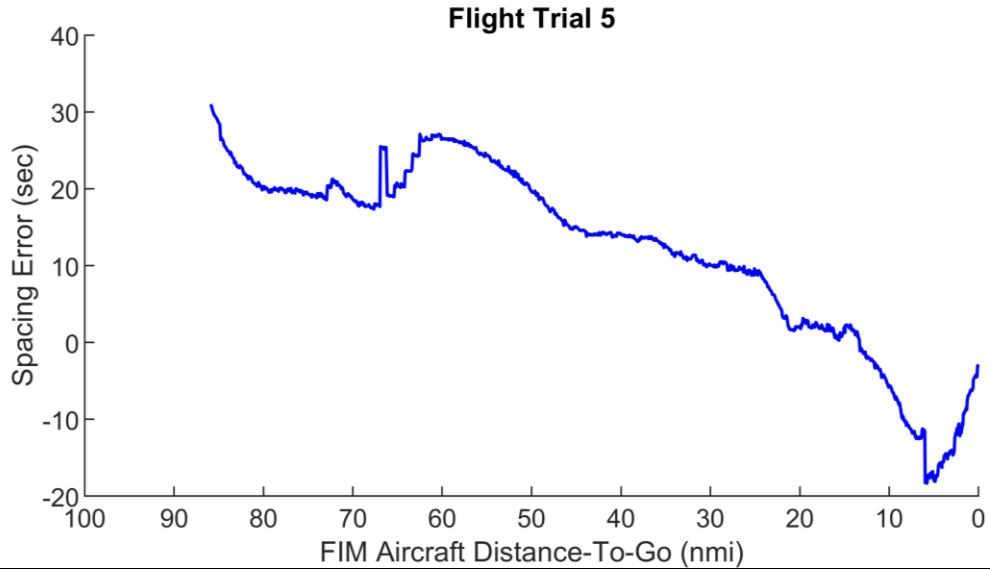

Figure 32. Flight trial five spacing error vs. distance from the achieve-by point.

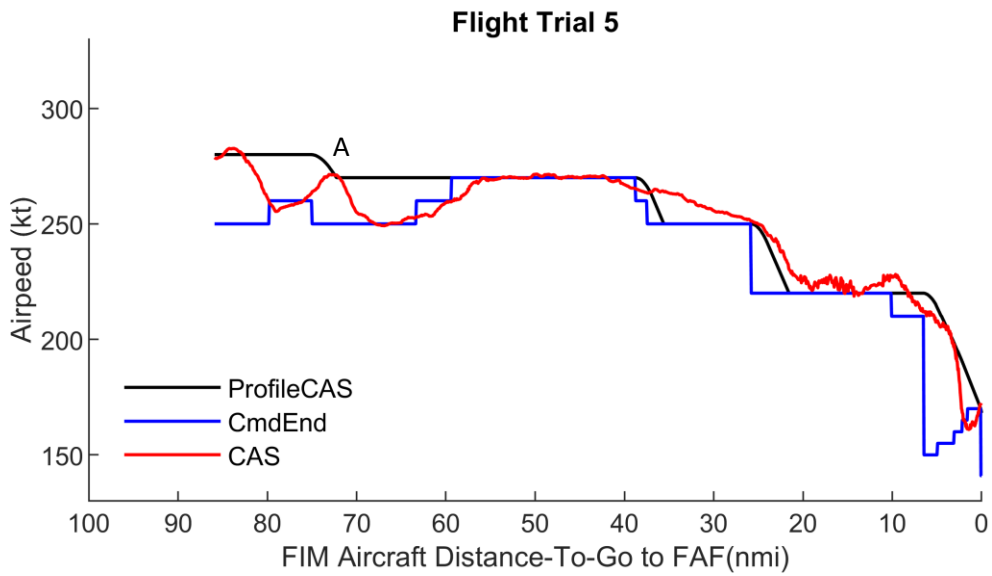

Figure 33. Flight trial five FIM command speeds.

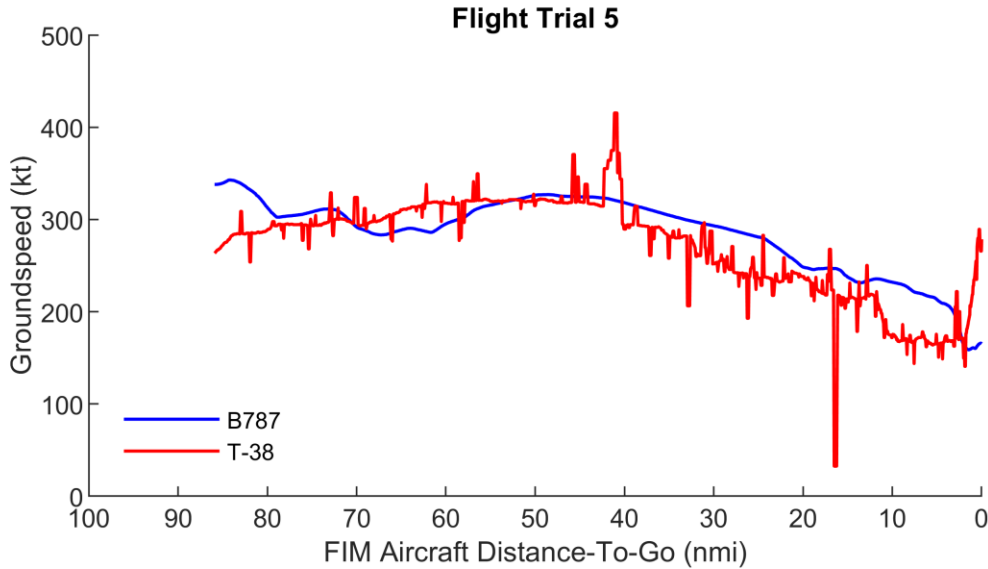

Figure 34. Flight trial five aircraft ground speed vs. distance from the achieve-by point.

7. Lessons Learned

Regular interaction to work out software integration issues would be highly desirable in future flight tests. Since the development group and testing facility were not co-located, the development phase occurred over a longer timeline than expected. NASA engineers were unable to perform some critical testing during portions of the development process without crossing the country, which significantly impacted the testing phase.

When defining the limitations for future flight tests, it is important to consider the operating limitations of the test vehicles. Time limitations due to fuel constraints may potentially affect operational decision-making such as set-up geometry for a flight trial. For the Moses Lake area, anti-icing capabilities would be more ideal to avoid Target vehicle deviations from a flight path that is representative of a commercial transport category aircraft. As mentioned previously, during the first flight trial, the T-38 left the flight path to dive through a cloud layer to avoid potential icing. Positioning for all flight test aircraft is very important, but challenging. Also, the Target aircraft's speeds, altitudes, and path conformance can have a significant impact on the commanded speeds and the spacing error. Therefore, future tests of FIM should require test vehicles with modern avionics that are more representative of NEXTGEN aircraft to ensure correct start positioning and precision along the flight path.

Regarding crew training, back-up flight test pilots should be identified ahead of time and given training similar to that received by the primary crew. Without such training, the new crew has the potential to introduce anomalies that otherwise could have been avoided.

The route design can impact the spacing error and commanded speeds close to the FAF. Very large deceleration segments prior to the FAF are not desirable. The FIM algorithm is designed to return the Ownship to the 4D trajectory Profile CAS as spacing error is corrected. Therefore, there are several cases where a speed decrease is commanded to correct an early spacing error and then speeds increase later in the arrival. Depending on the location of the speed increases, they may be undesirable to pilots.

8. Conclusions

The implementation of the NASA ASTAR algorithm aboard a B787 flight test aircraft proved successful in real world operations. On their first try, pilots with minor instruction and only speed

commands as input performed Interval Management with a maximum 7.5 seconds error from the goal time. Previous simulation studies of FIM suggested an acceptable deviation rate of 5 seconds of error, while initial results from the five-trial flight demonstration indicate an average error of approximately 1 second from the desired spacing goal. Future research should consider higher traffic airports with Standard Terminal Arrival Routes, where traffic controllers can position the Ownship behind a wider variety of aircraft along FAA derived routes. While this demonstration represented only a very few data points, it is clear the NASA ASTAR algorithm provided speed commands which acceptably reduced the spacing error.

References

1. Federal Aviation Administration, "NextGen Implementation Plan August 2014," URL: http://www.faa.gov/nextgen/library/media/implementation/media/nextgen_implementation_plan_2012.pdf [cited 24 April 2015].
2. Swieringa, K. A., Underwood, M. C., Barmore, B., Leonard, R. D., "An Evaluation of a Flight Deck Interval Management Algorithm including Delayed Target Trajectories" in 14th AIAA Aviation Technology, Integration, and Operations Conference (ATIO), Atlanta, 2014.
3. Wilson, S. R., Kibler, J. L., Hubbs, C. E., Smail, J. A., (2015) Air Traffic Management Technology Demonstration – 1 Research and Procedural Testing of Routes. NASA Technical Memorandum 218707.
4. Norris, G., "Advancing Eco," *Aviation Week and Space Technology*, Vol. 174, No. 26, 23 Jul. 2012, p. 18.
5. "Minimum Operational Performance Standards (MOPS) for Flight-deck Interval Management (FIM)," RTCA DO-361, RTCA, Washington, DC, 2015.
6. Baxley, B. T., Shay, R. F., Swieringa, K. A., (2014) The Development of Cockpit Display and Alerting Concepts for Interval Management (IM) in a Near-Term Environment. NASA Technical Memorandum 218659, pp. 51-53.
7. Abbott, T. A. (2015) An Overview of a Trajectory-Based Solution for En Route and Terminal Area Self-Spacing: Fifth Edition. NASA Contractor Report 218680, pp. 3-7.
8. "Grant County International Airport." [Airnav.com/airport/KMWH](http://airnav.com/airport/KMWH). AirNav, LLC., Web. 12 January 2014.
9. "Ephrata Municipal Airport." [Airnav.com/airport/KEPH](http://airnav.com/airport/KEPH). AirNav, LLC., Web. 12 December 2015.
10. Wilson, S. R., Murdoch, J. L., Hubbs, C. E., Swieringa, K. A., "Evaluation of Flight Deck-Based Interval Management Crew Procedure Feasibility", AIAA Modeling and Simulation Technologies (MST) Conference, Boston, 2013.
11. Murdoch, J. L., Wilson, S. R., Hubbs, C. E., Smail, J. A., "Acceptability of Flight Deck-Based Interval Management Crew Procedures", in AIAA Modeling and Simulation Technologies (MST) Conference, Boston, 2013.
12. Callantine, T. J., Kupfer, M., Martin, L., Mercer, J., Prevot, T., "System-Level Performance Evaluation of ATD-1 Ground-Based Technologies", 14th AIAA Aviation Technology, Integration, and Operations Conference (ATIO), Atlanta, 2014.
13. "Boeing ecoDemonstrator Backgrounder." [Boeing.com/resources/boeingdotcom/principles/environment/pdf/Backgrounder_ecoDemonstrator.PDF](http://boeing.com/resources/boeingdotcom/principles/environment/pdf/Backgrounder_ecoDemonstrator.PDF). Boeing Commercial Airplanes, Web. 3 March 2016.
14. Barmore, B. E., Abbott, T. E., and Capron, W. R., "Evaluation of airborne precision spacing in a human-in-the-loop experiment," AIAA 5th Aviation Technology, Integration, and Operations Conference (ATIO), 2005, pp. 26–28.
15. Baxley, B., Murdoch, J., Swieringa, K., Barmore, B., Capron, W., Hubbs, C., Shay, R., and Abbott, T., "Experiment Description and Results for Arrival Operations Using Interval Management with Spacing to Parallel Dependent Runways (IMSPiDR)," 2013.
16. Swieringa, K. A., Wilson, S. R., and Shay, R., "An Evaluation of Retrofit Flight Deck Displays for Interval Management," June 16–20 2014.
17. Swieringa, K. A. "The String Stability of a Trajectory-Based Interval Management Algorithm in the Midterm Airspace." 15th AIAA Aviation Technology, Integration, and Operations Conference. 2015.
18. Baxley, B. T., Wilson, S. R., Swieringa, K. A., Johnson, W. C., and Roper, R. D., (2016) Human-in-the-Loop Assessment of Alternative Clearances in Interval Management Arrival Operations. NASA Technical Memorandum, NASA Technical Paper 219362.

Appendix

ASTAR Flight Test Developed Materials

i. Pilots – Data Cards, Routes

Data cards were created for the pilots as a front and back quick reference card, laminated, and bound by loose leaf ring binders so the pilots could quickly flip through the reference material as needed.

Figure A1 was a descriptor card with overlay routes as a quick reference material for the ecoDemonstrator pilots' awareness of route waypoints. Table A1 appeared on the back side of the route descriptor card and contained latitude and longitude information should the pilots need to enter waypoint locations into the FMC.

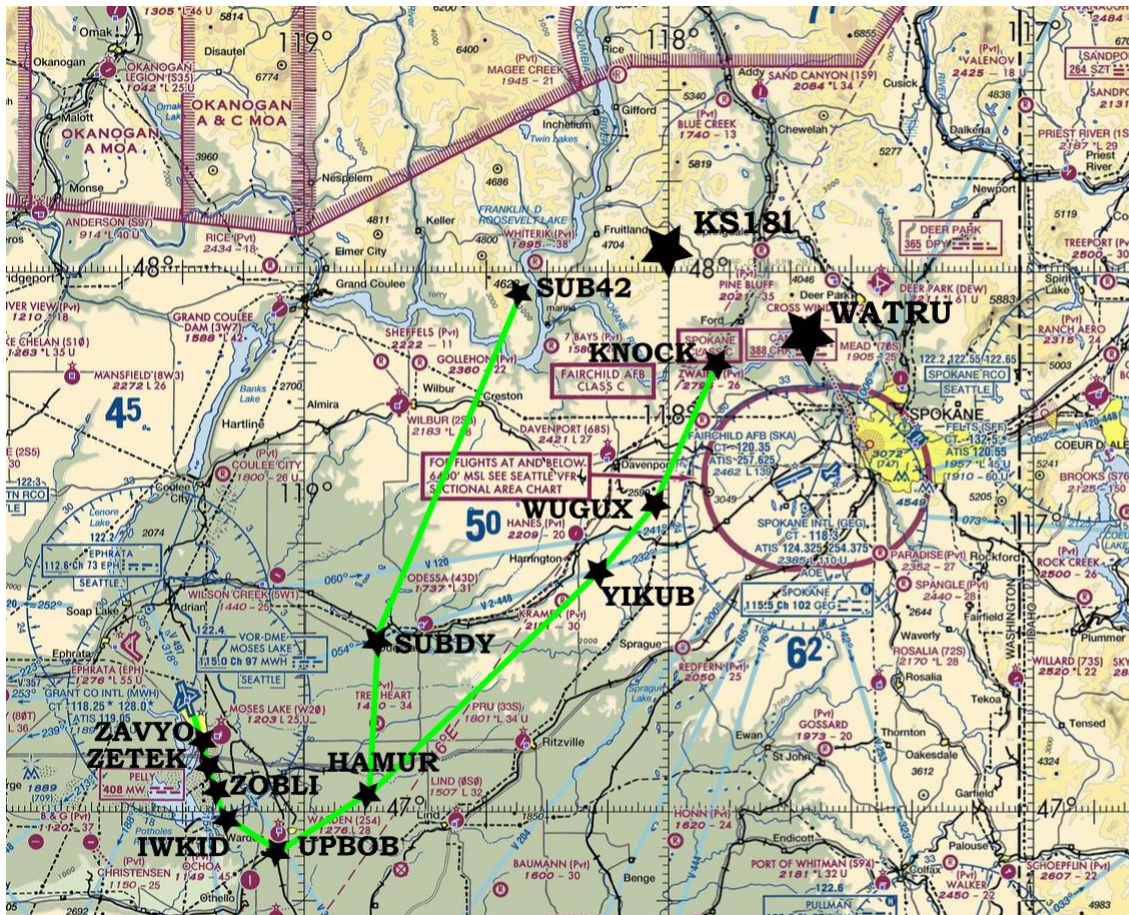

Figure A1. B787 route descriptor

Table A1. B787 Route Waypoints

KNOCK

FIX	Latitude	Longitude
KNOCK	N 47° 49' 23.05 "	W 117° 48' 10.46"
WUGUX	N 47° 33' 11.57"	W 117° 59' 46.74"
YICUB	N 47° 28' 09.22"	W 118° 05' 52.54"
HAMUR	N 46° 59' 45.03"	W 118° 55' 34.50"
UPBOB	N 46° 55' 46.29"	W 119° 03' 20.12"
IWKID	N 46° 59' 30.75"	W 119° 12' 58.85"
ZOBLI	N 47° 03' 48.83"	W 119° 15' 00.08"
ZETEK	N 47° 04' 45.93"	W 119° 15' 26.94"
ZAVYO	N 47° 06' 42.65"	W 119° 16' 21.91"
KMWH32R	N 47° 11' 25.54"	W 119° 18' 35.42"

SUBDY

FIX	Latitude	Longitude
SUB42	N 47° 57' 08.64"	W 118° 24' 18.00"
SUBDY	N 47° 19' 19.35"	W 118° 48' 04.51"
HAMUR	N 46° 59' 45.03"	W 118° 55' 34.50"
UPBOB	N 46° 55' 46.29"	W 119° 03' 20.12"
IWKID	N 46° 59' 30.75"	W 119° 12' 58.85"
ZOBLI	N 47° 03' 48.83"	W 119° 15' 00.08"
ZETEK	N 47° 04' 45.93"	W 119° 15' 26.94"
ZAVYO	N 47° 06' 42.65"	W 119° 16' 21.91"
KMWH32R	N 47° 11' 25.54"	W 119° 18' 35.42"

Figure A2 was a descriptor card with overlay routes as a quick reference material for the T-38 pilot's awareness of route waypoints. Table A2 appeared on the back side of the route descriptor card and contained latitude and longitude information should the pilot need to enter waypoint locations into the onboard GPS.

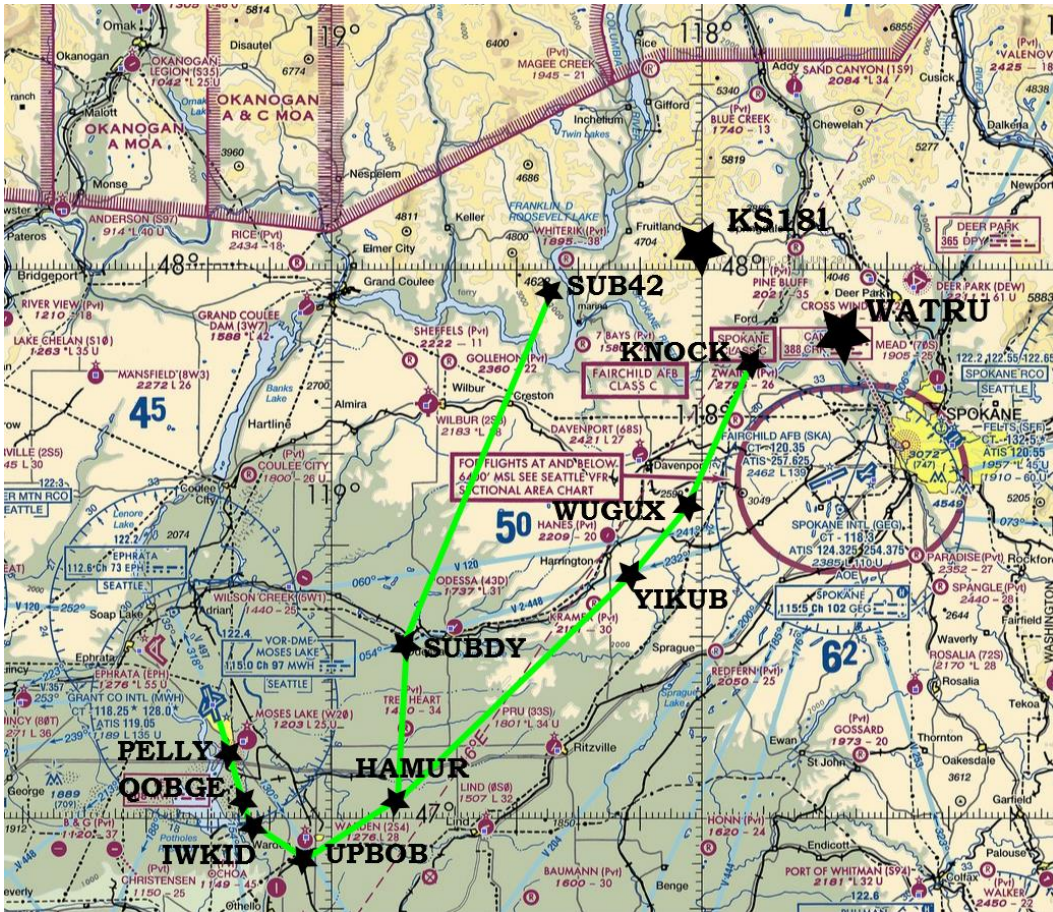

Figure A2. T-38 route descriptor.

Table A2. T-38 Route Waypoints

KNOCK

FIX	Latitude	Longitude
KNOCK	N 47° 49' 23.05 "	W 117° 48' 10.46"
WUGUX	N 47° 33' 11.57"	W 117° 59' 46.74"
YICUB	N 47° 28' 09.22"	W 118° 05' 52.54"
HAMUR	N 46° 59' 45.03"	W 118° 55' 34.50"
UPBOB	N 46° 55' 46.29"	W 119° 03' 20.12"
IWKID	N 46° 59' 30.75"	W 119° 12' 58.85"
QOBGE	N 47° 01' 12.96"	W 119° 13' 46.83"
PELLY	N 47° 06' 55.74"	W 119° 16' 28.05"
KMWH32R	N 47° 11' 25.54"	W 119° 18' 35.42"

SUBDY

FIX	Latitude	Longitude
SUB42	N 47° 57' 08.64"	W 118° 24' 18.00"
SUBDY	N 47° 19' 19.35"	W 118° 48' 04.51"
HAMUR	N 46° 59' 45.03"	W 118° 55' 34.50"
UPBOB	N 46° 55' 46.29"	W 119° 03' 20.12"
IWKID	N 46° 59' 30.75"	W 119° 12' 58.85"
QOBGE	N 47° 01' 12.96"	W 119° 13' 46.83"
PELLY	N 47° 06' 55.74"	W 119° 16' 28.05"
KMWH32R	N 47° 11' 25.54"	W 119° 18' 35.42"

In an effort to replicate the profile of a typical transport category aircraft, the descent profile for the T-38 was based on a nominal simulation profile of a B757 having flown the planned routes. It was not expected for the Target to have the same descent profile as the Ownship, although the pre-arranged descent

profile would closely model the descent profile of a mid-size, wide-body twin-engine jet airliner. Short level offs are acceptable but the overall test profile should be a descent of approximately three degrees to try and mimic an RNAV STAR. During the actual flight test, the T-38 was forced to descend rapidly between FL230 and 16,000 to pass through an overcast cloud layer. Visibility below the cloud layer was unrestricted with freezing levels forecast at 10,000 ft. The T-38 pilot observed no icing occurrence on the aircraft canopy (the most readily identifiable location for pilot observation of icing). The developed profile cards are described in Tables A3 and A4.

Table A3. T-38 SUBDY Profile Card

T-38	ILS32R	KMWH	SUBDY ROUTE
Fix	Alt	Max Speed	Distance to next fix
SUB42	22000	280	41 to SUBDY
SUBDY	12000		20 to HAMUR
HAMUR	7000	220	6.5 to UPBOB
UPBOB	5600		7.5 to IWKID
IWKID	≥4000		1.8 to QOBGE
QOBGE	≥3300		6 to PELLY
PELLY	≥2800	170	4.7 to RWY
R-32R	1222		

Table A4. T-38 KNOCK Profile Card

T-38	ILS32R	KMWH	KNOCK ROUTE
Fix	Alt	Max Speed	Distance to next fix
KNOCK	22000	280	18 to WUGUX
WUGUX	18000	270	6.5 to YICUB
YICUB	16600		44 to HAMUR
HAMUR	7000	220	6.5 to UPBOB
UPBOB	5600		7.5 to IWKID
IWKID	≥4000		1.8 to QOBGE
QOBGE	≥3300		6 to PELLY
PELLY	≥2800	170	4.7 to RWY
R-32R	1222		

The Ownship descended via a low-power optimized profile descent (OPD) calculated from the top-of-descent. The calculation was part of the performance characteristics of the Flight Management Computer

onboard the B787-800. The pilots met the OPD while in Speed Mode, following the ASTAR generated speed commands. The scenario descent profile card for the B787-800 allowed the pilots to program the MCDU to obtain the OPD similar to a typical STAR. The developed profile cards are described in Tables A5 and A6

Table A5. B787 SUBDY Profile Card

EcoD	RNAV32R	KMWH	SUBDY ROUTE
Fix	Alt	Speed*	Distance to next fix
SUB42	22000	280	41 to SUBDY
SUBDY	12000		20 to HAMUR
HAMUR	7000	220	6.5 to UPBOB
UPBOB	5600		7.5 to IWKID
IWKID	≥4000		4.5 to ZOBLI
ZOBLI	3100		1 to ZETEK
ZETEK	2900	170	2 to ZAVYO
ZAVYO	2800		5 to RWY
RWY32R	1222		

*Speed for programming the MCDU only

Table A6. B787 KNOCK Profile Card

EcoD	RNAV 32R	KMWH	KNOCK ROUTE
Fix	Alt	Speed*	Distance to next fix
KNOCK	22000	280	18 to WUGUX
WUGUX	18000	270	6.5 to YICUB
YICUB			44 to HAMUR
HAMUR	7000	220	6.5 to UPBOB
UPBOB			7.5 to IWKID
IWKID	4000		4.5 to ZOBLI
ZOBLI	3100		1 to ZETEK
ZETEK	2900		2 to ZAVYO
ZAVYO	2800	170	5 to RWY
RWY32R	1222		

*Speed for programming the MCDU only

The cards were designed so that when referencing the route, only one route could be visible to the pilot at any time. The routes were highlighted in yellow for ease of recognition.

The Scenario Run Card detailed route expectations for both test aircraft based upon the flight trial number (Table A7). Both the T-38 and B787 operator had copies on-board. Because the flight test may have been limited by either weather or traffic congestion, Run One, Two, and Three allowed pilot discretion to utilize the alternate flight path. The pilots advised the laptop operator prior to engaging the new route to verify the choice was feasible. When agreed upon, the pilots of the two participating aircraft notified each other, then ATC, of intended the intended flight path.

Table A7. Pilot Scenario Flight Trial Card

RUN	T-38	B787	In-Trail Distance
1	SUB42	SUB42	13 nm
2	KNOCK	KNOCK	16 nm
3	SUB42 or KNOCK	Same as T-38	10 nm
4	SUB42	KNOCK	Arrive at initial fixes
5			at same time

Preferred Route-If route no good due to weather/traffic, select route for the alternate run and advise, use in-trail distance for originally expected run.

ii. NASA representatives to ATC facilities

NASA representatives at the Air Traffic Control facilities were given printed sheets containing the route structure, latitude/longitude table, pilot data cards tables, and scenario run table which appear in Appendix A, Section i. While not actively engaged in the controller operation, the representatives were on-site to answer questions regarding the nature of the flight and provide FIM expertise, if requested, to those new to the operation.

iii. Air Traffic Control – Route Briefing Manual

Air Traffic Control developed a controller briefing manual jointly with NASA to ensure a seamless operational environment during the ASTAR flight test. What follows is the package exactly as delivered to FAA Air Traffic Controllers for both Seattle Center and Grant County Approaches, and also the NASA ASTAR flight test lead:



Figure A3. Boeing ecoDemonstrator B787 and T-38

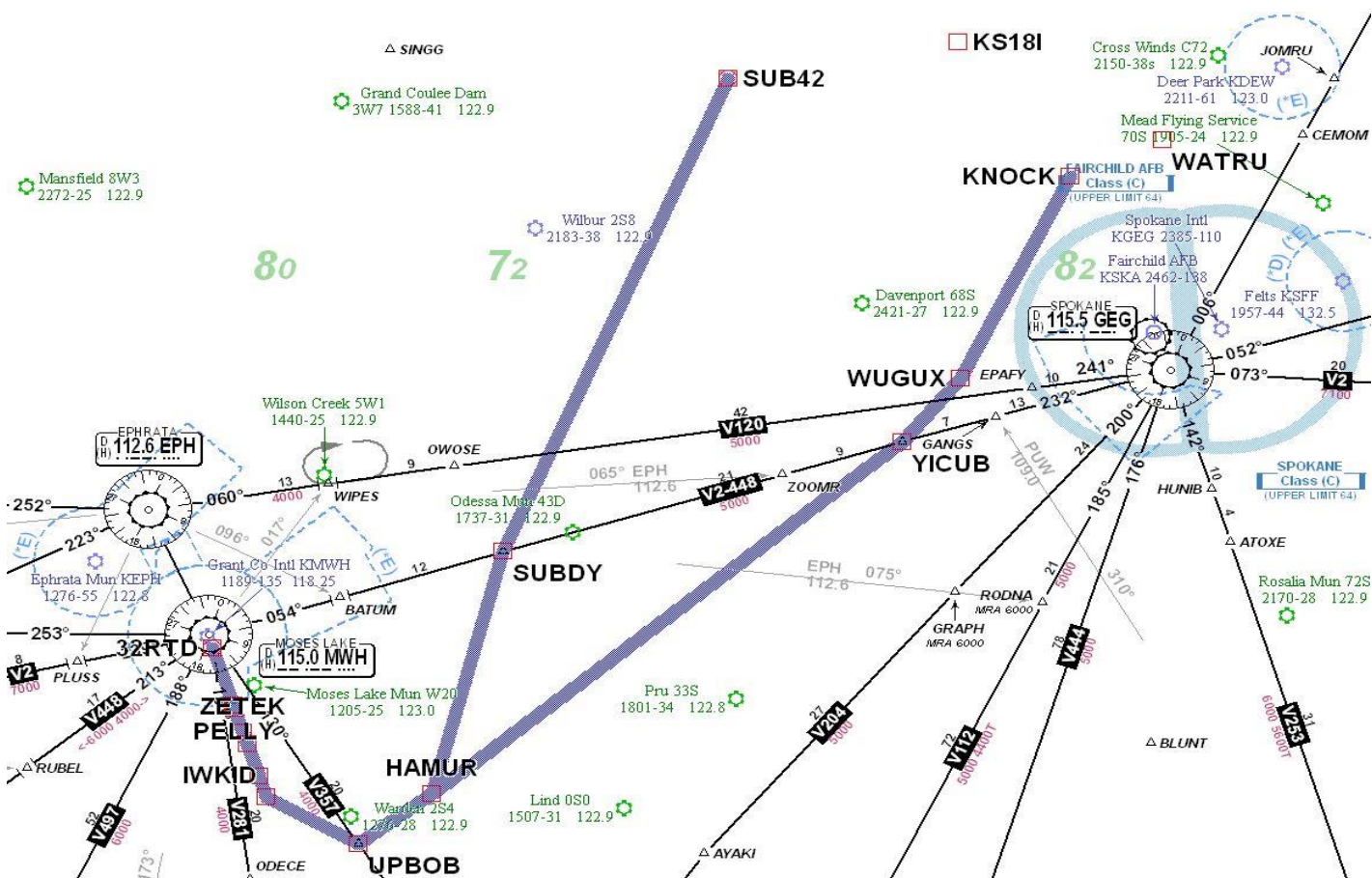

Figure A4. SUBDY and KNOCK Arrival Routes

Table A8. Pilot Scenario Run Card

RUN	T-38	B787	In-Trail Distance
1	SUB42	SUB42	13 nm
2	KNOCK	KNOCK	16 nm
3	SUB42 or KNOCK	Same as T-38	10 nm
4	SUB42	KNOCK	Arrive at initial fixes at same time
5			time

Preferred Route-If route no good due to weather/traffic, select route for the alternate run and advise, use in-trail distance for originally expected run.

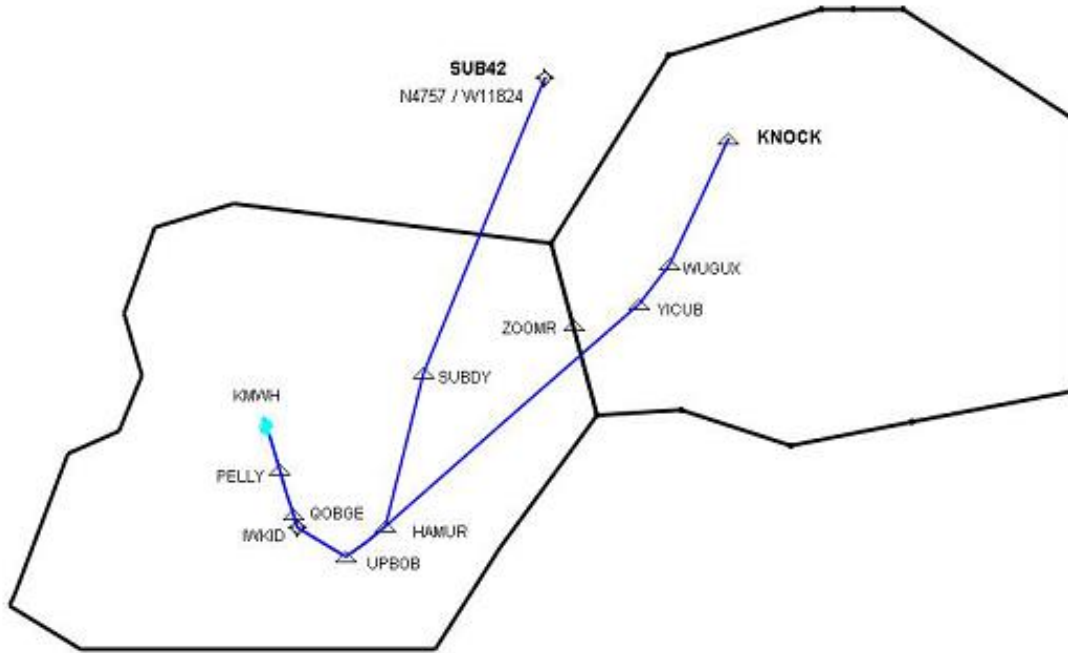

Figure A5. Moses Lake Airspace



Figure A6. Moses Lake Airspace

T-38	ILS32R	KMWH	SUBDY ROUTE
Fix	Alt	Max Speed	Distance to next fix
SUB42	22000	280	41 to SUBDY
SUBDY	12000		20 to HAMUR
HAMUR	7000	220	6.5 to UPBOB
UPBOB	5600		7.5 to IWKID
IWKID	≥4000		1.8 to QOBGE
QOBGE	≥3300		6 to PELLY
PELLY	≥2800	170	4.7 to RWY
R-32R	1222		

T-38	ILS32R	KMWH	KNOCK ROUTE
Fix	Alt	Max Speed	Distance to next fix
KNOCK	22000	280	18 to WUGUX
WUGUX	18000	270	6.5 to YICUB
YICUB	16600		44 to HAMUR
HAMUR	7000	220	6.5 to UPBOB
UPBOB	5600		7.5 to IWKID
IWKID	≥4000		1.8 to QOBGE
QOBGE	≥3300		6 to PELLY
PELLY	≥2800	170	4.7 to RWY
R-32R	1222		

EcoD	RNAV 32R	KMWH	SUBDY ROUTE
Fix	Alt	Speed*	Distance to next fix
SUB42	22000	280	41 to SUBDY
SUBDY	12000		20 to HAMUR
HAMUR	7000	220	6.5 to UPBOB
UPBOB	5600		7.5 to IWKID
IWKID	≥4000		4.5 to ZOBLI
ZOBLI	3100		1 to ZETEK
ZETEK	2900	170	2 to ZAVYO
ZAVYO	2800		5 to RWY
RWY32R	1222		

EcoD	RNAV 32R	KMWH	KNOCK ROUTE
Fix	Alt	Speed*	Distance to next fix
KNOCK	22000	280	18 to WUGUX
WUGUX	18000	270	6.5 to YICUB
YICUB			44 to HAMUR
HAMUR	7000	220	6.5 to UPBOB
UPBOB			7.5 to IWKID
IWKID	4000		4.5 to ZOBLI
ZOBLI	3100		1 to ZETEK
ZETEK	2900		2 to ZAVYO
ZAVYO	2800	170	5 to RWY
RWY32R	1222		

Figure A7. Test Aircraft Profile Cards

- B787 will depart from BFI
- T-38 may stage at MWH and wait for B787, then join as a non-standard flight. This could save fuel and time by allowing the T38 to stay airborne longer for first few runs. The T-38 will have to land at some point and refuel. The B787 will never land for the experiment because of adequate fuel loads onboard.
- When the two aircraft meet up in all cases, the concurrent altitude will be FL220
- The T-38 will be flight lead and declare "Flight of Two with a Nonstandard Formation". Both airplanes will squawk normal transponder codes during Nonstandard Formations and use the word "flight" in all transmission while a flight.
- All communications / clearances after join up will be thru T-38.
- The intent is to treat this exercise in the same manner as we do Aerial Refueling with all communications after flight join up through the flight lead
- There will be 3 runs with both aircraft on the same track then 2 runs with aircraft on separate tracks.
- T-38 will request holding at either SUB42 or KNOCK.
- Holding clearance will be: Hold North, Right Turns, (Leg lengths at your discretion?), EFC at your request
- For first 3 runs aircraft will hold at different altitudes at the same fix. FL220B230 with T-38 on bottom.
- When holding at different fixes or just simply flying the different tracks aircraft will hold at same altitude. (FL220)
- T-38 will provide two minute clearance request notification
- ZSE will coordinate with MWH, point out to GEG? and resolve traffic conflicts.
- The two tracks will be referred to as KNOCK and SUBDY "Descent", as in SQUIRL Descent
- On same track, ATC clearance will be... (T38) flight cleared SUBDY/KNOCK descent, maintain 5000, MWH altimeter. The intent here is to treat the exercise in the same manner as the SQUIRL Descent.
- On different tracks: Issue separate clearances thru the T38. Clear each aircraft via its respective track.
- Transfer radar and communications to MWH in a timely manner.
- ZSE may have to rejoin the aircraft depending on what MWH wants to do after ILS/low approach/touch and go.
- Controllers have the authority to issue crossing restrictions and will not interfere with test results if within +/- **4000 ft.** of card altitude.

REPORT DOCUMENTATION PAGE

Form Approved
OMB No. 0704-0188

The public reporting burden for this collection of information is estimated to average 1 hour per response, including the time for reviewing instructions, searching existing data sources, gathering and maintaining the data needed, and completing and reviewing the collection of information. Send comments regarding this burden estimate or any other aspect of this collection of information, including suggestions for reducing the burden, to Department of Defense, Washington Headquarters Services, Directorate for Information Operations and Reports (0704-0188), 1215 Jefferson Davis Highway, Suite 1204, Arlington, VA 22202-4302. Respondents should be aware that notwithstanding any other provision of law, no person shall be subject to any penalty for failing to comply with a collection of information if it does not display a currently valid OMB control number.
PLEASE DO NOT RETURN YOUR FORM TO THE ABOVE ADDRESS.

1. REPORT DATE (DD-MM-YYYY) 1-09-2019		2. REPORT TYPE Technical Memorandum		3. DATES COVERED (From - To)	
4. TITLE AND SUBTITLE Airborne Spacing for Terminal Arrival Routes (ASTAR) Proof-of-Concept Flight Test				5a. CONTRACT NUMBER	
				5b. GRANT NUMBER	
				5c. PROGRAM ELEMENT NUMBER	
6. AUTHOR(S) Roper, Roy D.; Koch, Michael R.; Johnson, William C.; Swieringa, Kurt A.				5d. PROJECT NUMBER	
				5e. TASK NUMBER	
				5f. WORK UNIT NUMBER 330693.04.10.07.07	
7. PERFORMING ORGANIZATION NAME(S) AND ADDRESS(ES) NASA Langley Research Center Hampton, VA 23681-2199				8. PERFORMING ORGANIZATION REPORT NUMBER L-20741	
9. SPONSORING/MONITORING AGENCY NAME(S) AND ADDRESS(ES) National Aeronautics and Space Administration Washington, DC 20546-0001				10. SPONSOR/MONITOR'S ACRONYM(S) NASA	
				11. SPONSOR/MONITOR'S REPORT NUMBER(S) NASA-TM-2019-220404	
12. DISTRIBUTION/AVAILABILITY STATEMENT Unclassified- Subject Category 05 Availability: NASA STI Program (757) 864-9658					
13. SUPPLEMENTARY NOTES					
14. ABSTRACT The Airborne Spacing for Terminal Arrival Routes (ASTAR) Flight Test was conducted by the NASA Air Traffic Management Technology Demonstration – 1 (ATD-1) project to demonstrate the use of NASA’s ASTAR algorithm beyond a simulated environment and assess the operational risks of performing a multi-aircraft flight test of Flight-deck Interval Management (FIM). Utilizing contemporary tools of the Federal Aviation Administration’s Next Generation Air Transportation System (NextGen) such as ADS-B, the ASTAR algorithm calculated speeds that the flight crew flew to achieve a precise spacing interval behind another aircraft at the final approach fix. Airspeed commands issued by the algorithm were flown by the flight crew of the FIM-equipped aircraft to achieve or maintain an assigned spacing goal from a target vehicle. The ASTAR algorithm was integrated with the Boeing supplied B-787 ecoDemonstrator aircraft, and five flight trials were conducted as a joint effort between NASA and Boeing on December 12, 2014. Initial results indicated arrival times within several seconds of accuracy of the planned termination point between two aircraft performing FIM in a real world environment. This flight test opened the way for the much more expansive ATD-1 Avionics Phase II flight test which occurred in early 2017.					
15. SUBJECT TERMS ASTAR; Flight Test; Interval Management					
16. SECURITY CLASSIFICATION OF:			17. LIMITATION OF ABSTRACT	18. NUMBER OF PAGES	19a. NAME OF RESPONSIBLE PERSON
a. REPORT	b. ABSTRACT	c. THIS PAGE			STI Help Desk (email: help@sti.nasa.gov)
U	U	U	UU	61	19b. TELEPHONE NUMBER (Include area code) (757) 864-9658