

Hybrid RANS/LES of Jet Surface Interaction Noise

Gerrit-Daniel Stich¹

Jeffrey Housman¹, Joseph Kocheemoolayil¹, Cetin Kiris¹
James Bridges², Clifford Brown²

NASA Ames Research Center (ARC)¹
NASA Glenn Research Center (GRC)²

Advanced Modeling & Simulation (AMS) Seminar Series
NASA Ames Research Center, June 27th, 2019
Based on AIAA 2019-2475

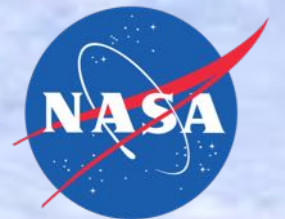
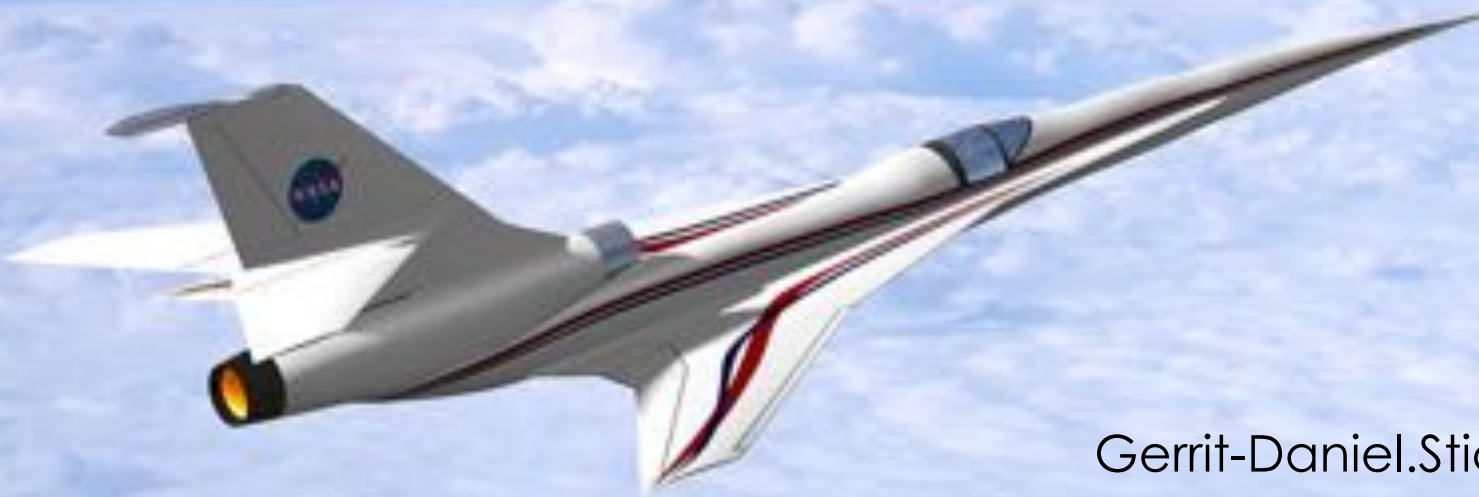

Gerrit-Daniel.Stich@nasa.gov

Objective

NASA's Commercial Supersonic Technologies (CST) Project



Picture Credit: NASA / Lockheed Martin



NASA planned Low Boom Flight Demonstration aircraft

- NASA initiated research activities towards Commercial Supersonic Technologies (CST)
- Within this project Three main Technical Challenges (TC) have been defined
 - TC 1.1 Low Boom Design Tools
 - TC 1.2 Sonic Boom Community Response Metric & Methodology
 - **TC 2.2 Low Noise Propulsion for Low Boom Aircraft**
- Develop an understanding of the effects of shielding surfaces on the aerodynamic noise sources from jet flows.

Objective



Progress Towards Full Aircraft Noise Prediction

Utilizing Computational Fluid Dynamics (CFD) to evaluate the effects of shielding surfaces on the aerodynamic noise sources from jet flows for a full aircraft configuration "Grand Challenge"

- First systematic validation effort to assess predictive capabilities for jet-noise shielding within NASA Ames Launch Ascend and Vehicle Aerodynamics solver (LAVA)



Objective



Progress Towards Full Aircraft Noise Prediction

Utilizing Computational Fluid Dynamics (CFD) to evaluate the effects of shielding surfaces on the aerodynamic noise sources from jet flows for a full aircraft configuration "Grand Challenge"

- First systematic validation effort to assess predictive capabilities for jet-noise shielding within NASA Ames Launch Ascend and Vehicle Aerodynamics solver (LAVA)





- Motivation
- **Experimental Setup**
- **Computational Methodology**
- **Structured Overset Grid System**
- **Axisymmetric Round Jet**
 - Flow Visualization
 - Near-Field Results
 - Far-Field Results
- **Jet Surface Interaction**
 - Near-Field Results
 - Far-Field Results
- **Summary and Future Work**

- Motivation
- **Experimental Setup**
- Computational Methodology
- Structured Overset Grid System
- Axisymmetric Round Jet
 - Flow Visualization
 - Near-Field Results
 - Far-Field Results
- Jet Surface Interaction
 - Near-Field Results
 - Far-Field Results
- Summary and Future Work

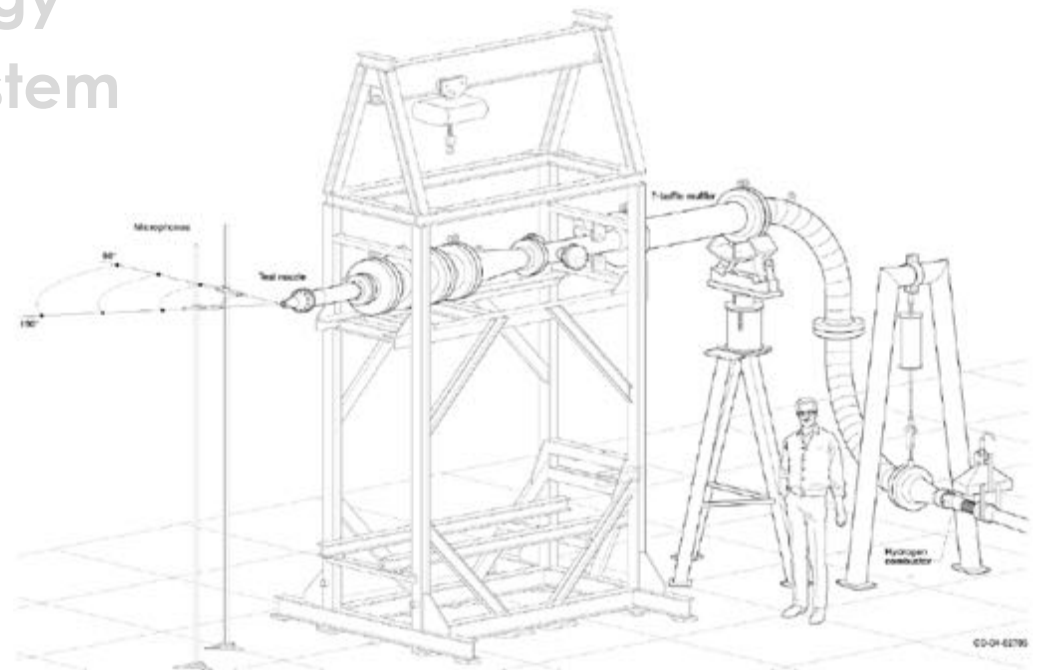

Experimental Facility

NASA Aero-Acoustics Propulsion Lab (AAPL)



AAPL



- 65" radius anechoic dome
- Located at Glenn Research Center (GRC)
- Small Hot Jet Acoustic Rig (SHJAR)
- Far-field acoustics, phased arrays, flow rakes, hotwire, shlieren, PIV, IR, Rayleigh, Raman, PSP



SHJAR

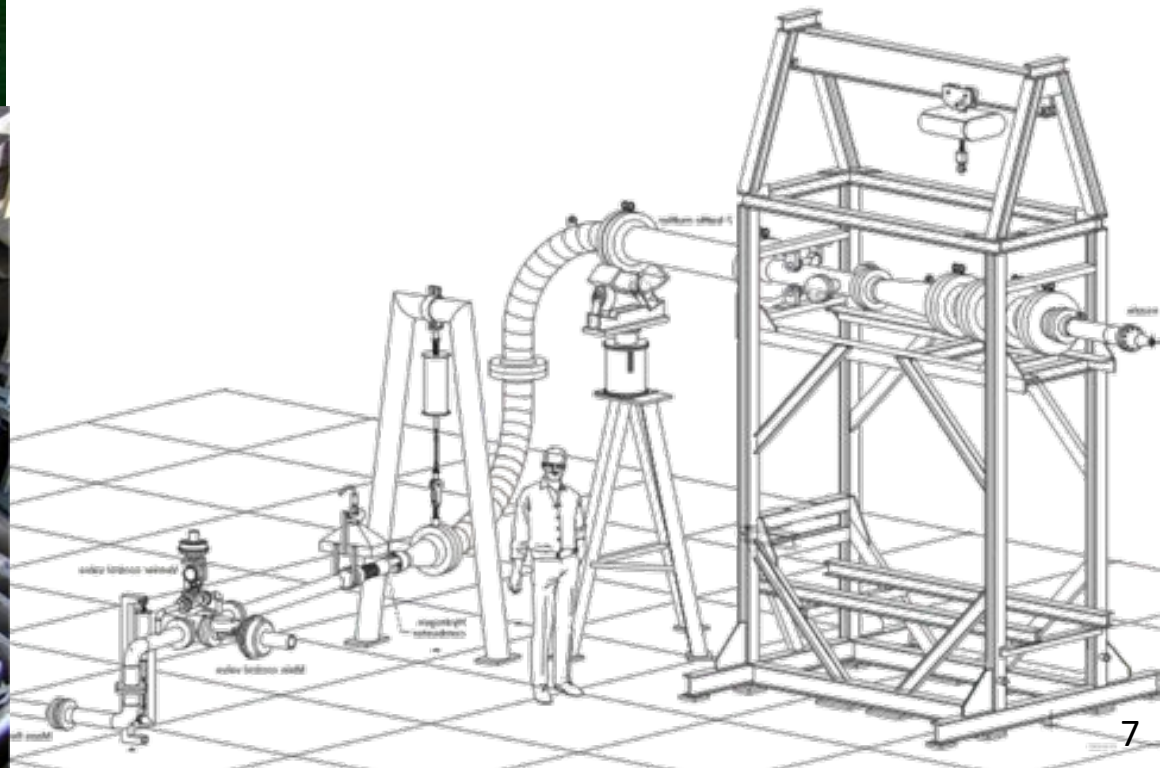

Experimental Facility

NASA Aero-Acoustics Propulsion Lab (AAPL)



- ✓ Baseline axisymmetric convergent Small Metal Chevron (SMC000) nozzle at Set Point 7 (SP7) with 12" extension
- ✓ Nozzle axis in downstream flow direction is marked as 180°

Bridges et. al. (NASA-TM-2011-216807)	SP7
Acoustic Mach number U_{jet}/c_{∞}	0.9
Jet temperature ratio T_e/T_{∞}	0.835
Nozzle pressure ratio p_t/p_{∞}	1.861
Nozzle Diameter D	0.0508 [m] 2.0 [inch]
Reynold number Re_D	1 Million
Reynolds number Re_{τ}	800
Boundary layer thickness	0.0128 D

PIV measurement device

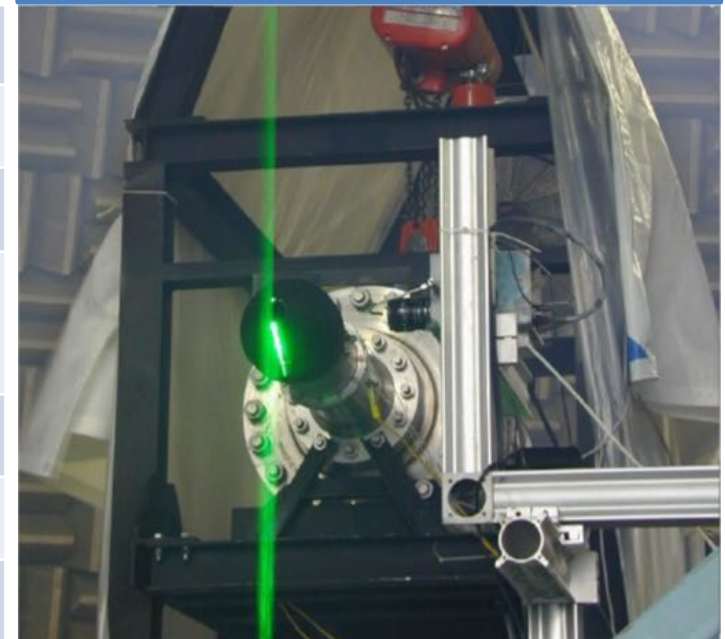

Similar conditions were analyzed in Bres *et. al.* AIAA-2015-2535, but the boundary layer thickness is 5.5 larger

Geometry and Setup



Round Convergent Nozzle (SMC000) with Jet Shielding Plate

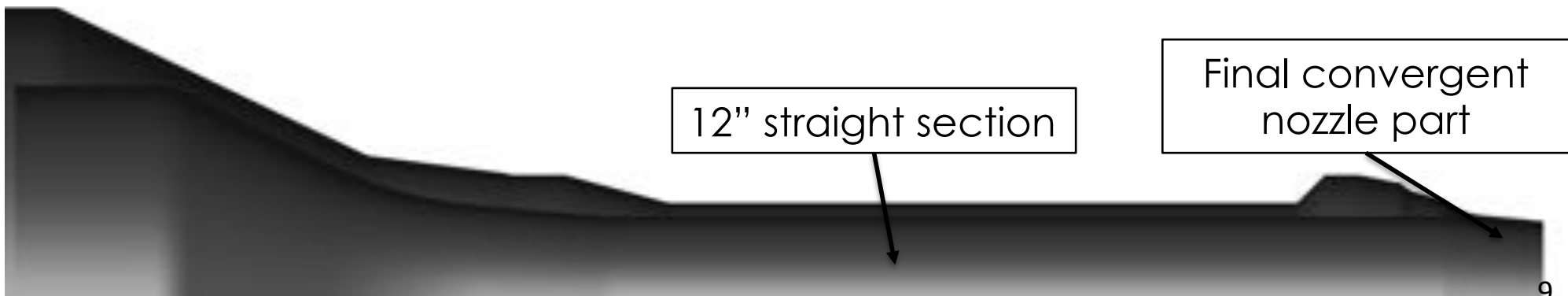
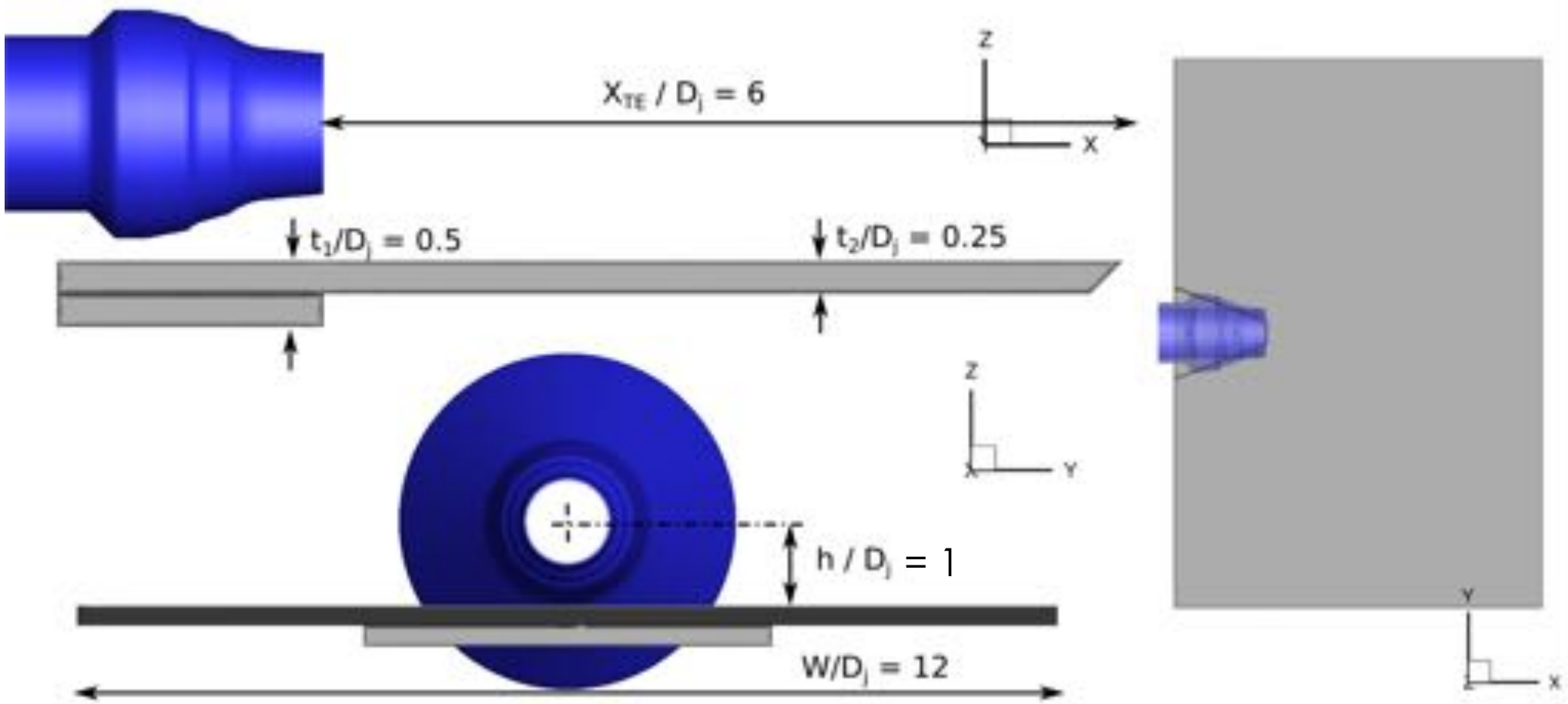

- Motivation
- Experimental Setup
- **Computational Methodology**
- Structured Overset Grid System
- Axisymmetric Round Jet
 - Flow Visualization
 - Near-Field Results
 - Far-Field Results
- Jet Surface Interaction
 - Near-Field Results
 - Far-Field Results
- Summary and Future Work

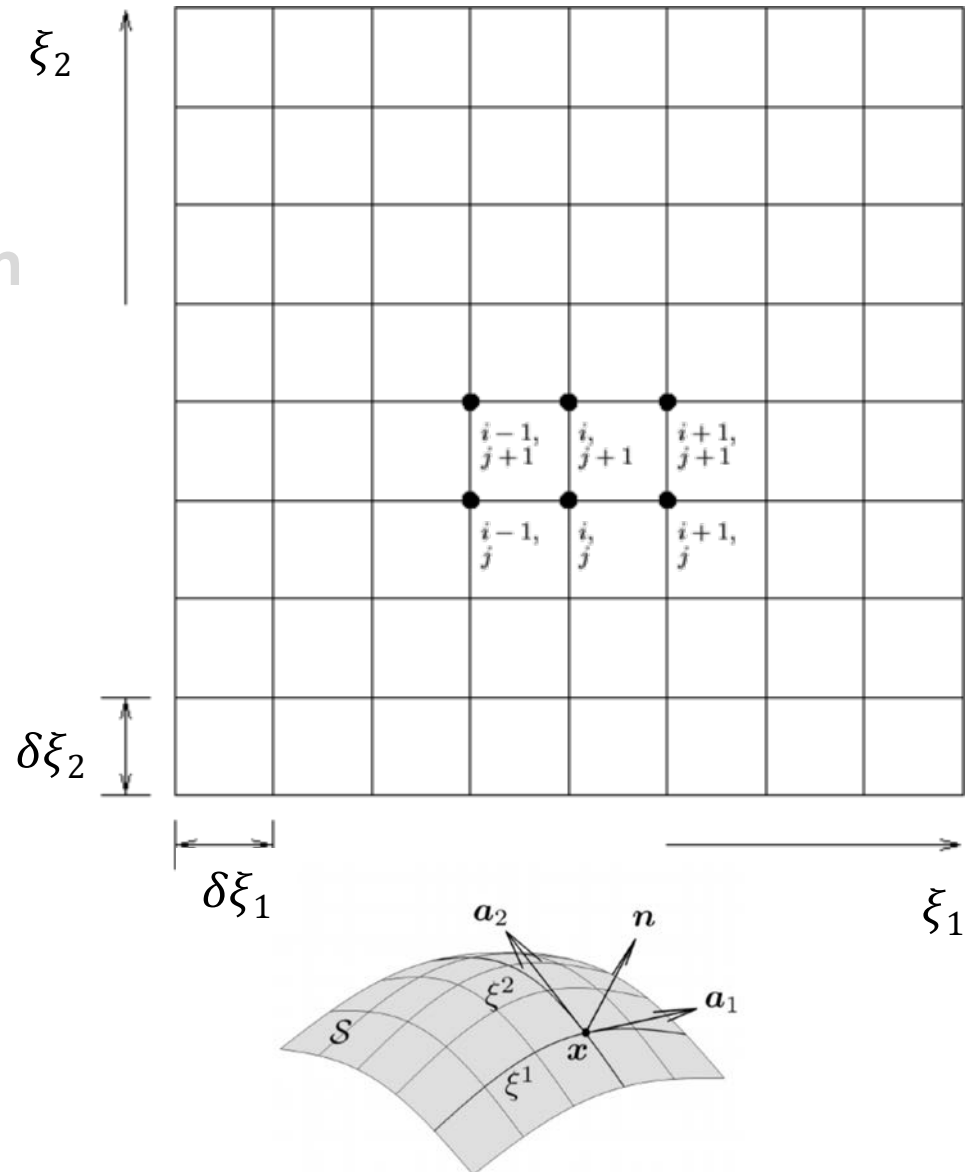



LAVA Framework

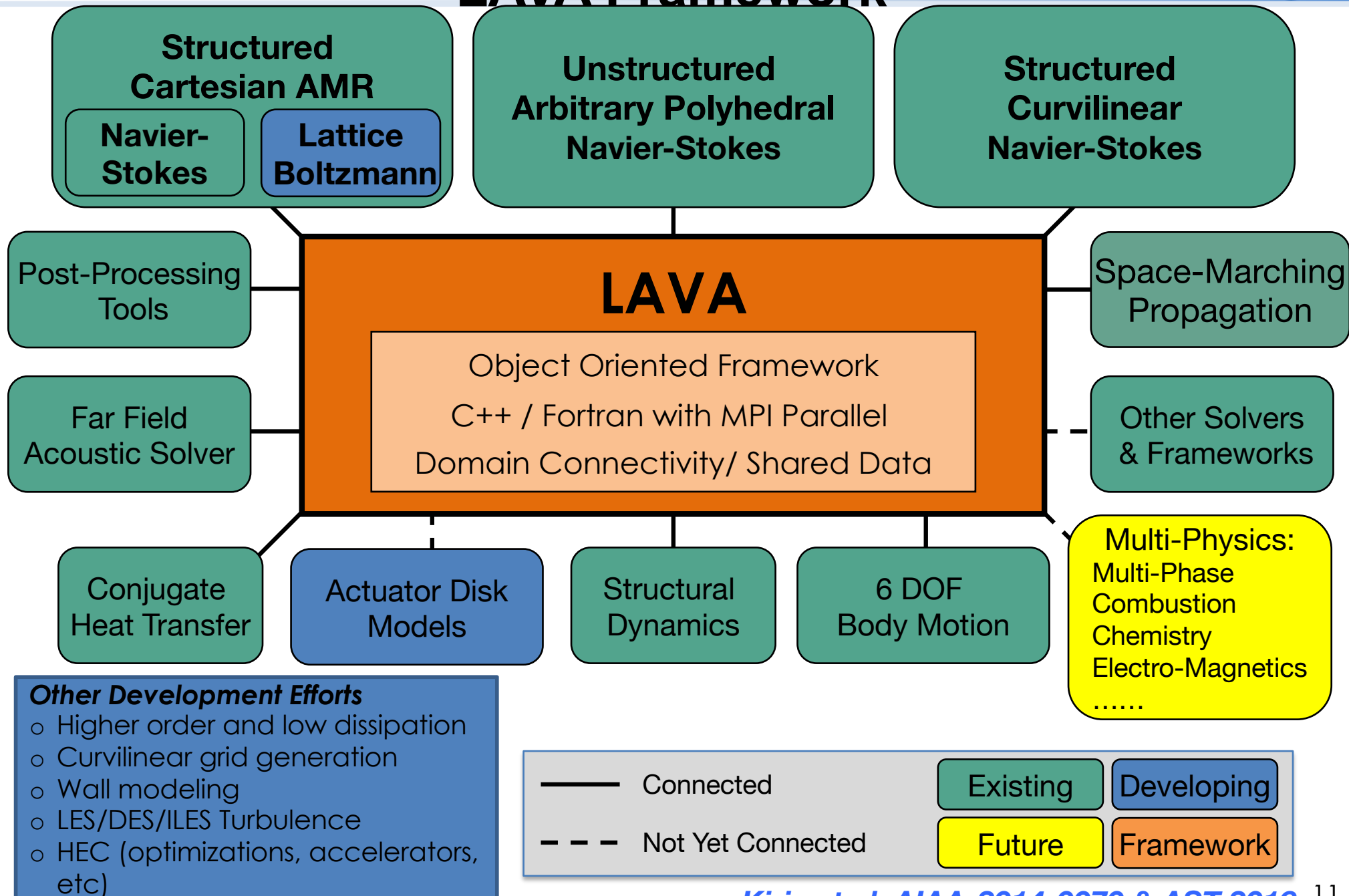

Numerical Method Used



3-D Structured Curvilinear Overset Grid Solver within LAVA framework

- Spalart-Allmaras turbulence model (baseline turbulence model)

Low-Dissipation Finite Difference Method [\(Housman et al. AIAA-2016-2963\)](#)

- 6th-order Hybrid Weighted Compact Nonlinear Scheme (HWCNS)
- Numerical flux is a modified Roe scheme
- 6th/5th-order blended central/upwind biased left and right state interpolation
- 2nd-order accurate differencing used for time discretization

Hybrid RANS/LES Model

- Zonal Detached Eddy Simulation (ZDES-Mode III & IV) with user selected RANS, LES, and Hybrid RANS LES zones [\(Deck, S. Theor. Comput. Fluid Dyn. 2012\)](#)

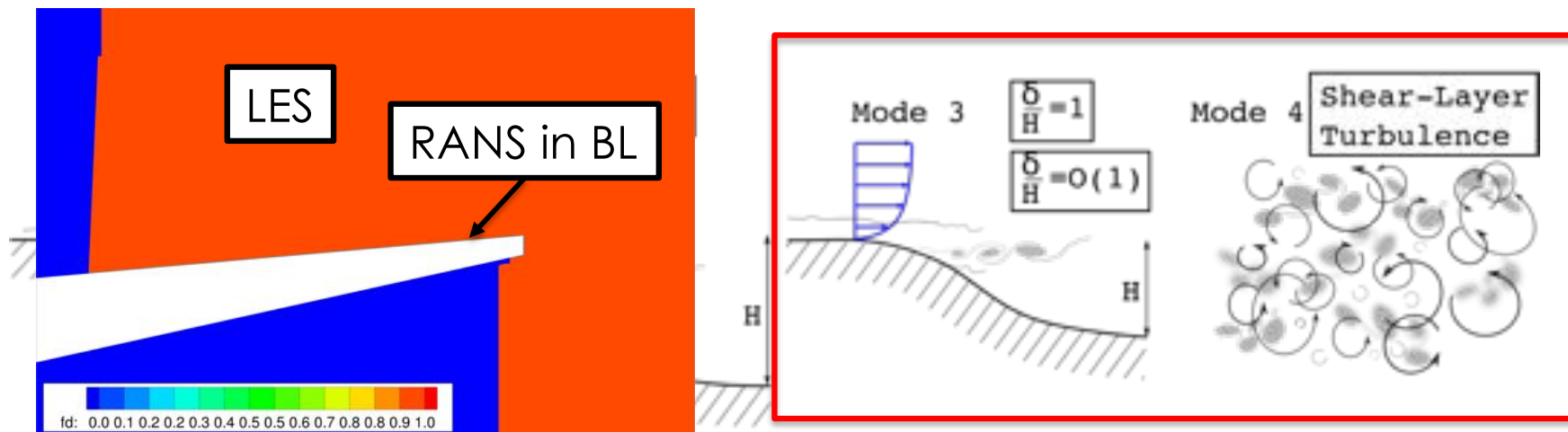

Computational Approach

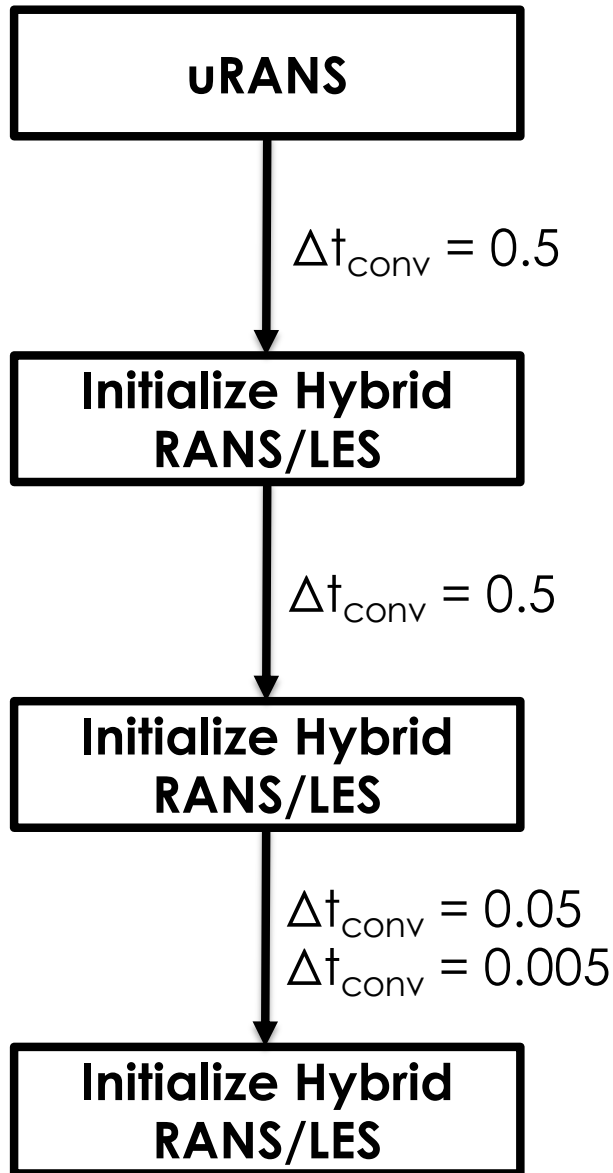

- Unsteady RANS until jet is fully developed and eddy viscosity maximum has plateaued
- Restart simulation with Hybrid RANS/LES and larger timestep
- Decrease time-step once flow is fully developed
- Ignore transients from changing model and time-step size (20,000 time-steps for this case)
- Record volume data at 100kHz sampling frequency for 30,000 steps ($\Delta t_{\text{conv}} = 200$) on isolated case and 120,000 steps ($\Delta t_{\text{conv}} = 800$) for shielding case.

$$\Delta t_{\text{conv}} = \Delta t c_{\infty} / D_j$$

Inflow Turbulence Generation



- When transitioning from RANS to LES in wall-bounded flows it is necessary to insert meaningful three-dimensional content at the interface
- The synthetic eddy method (SEM) is one approach which adds eddies in such a way that first and second order turbulent statistics can be satisfied. (approx. from the RANS solution with Bradshaw hypothesis)

Jet Case SP 7

$$\Delta x_{SEM} = x_{exit} - x_{SEM}$$

$$54 \delta < \Delta x_{SEM} < 55 \delta$$

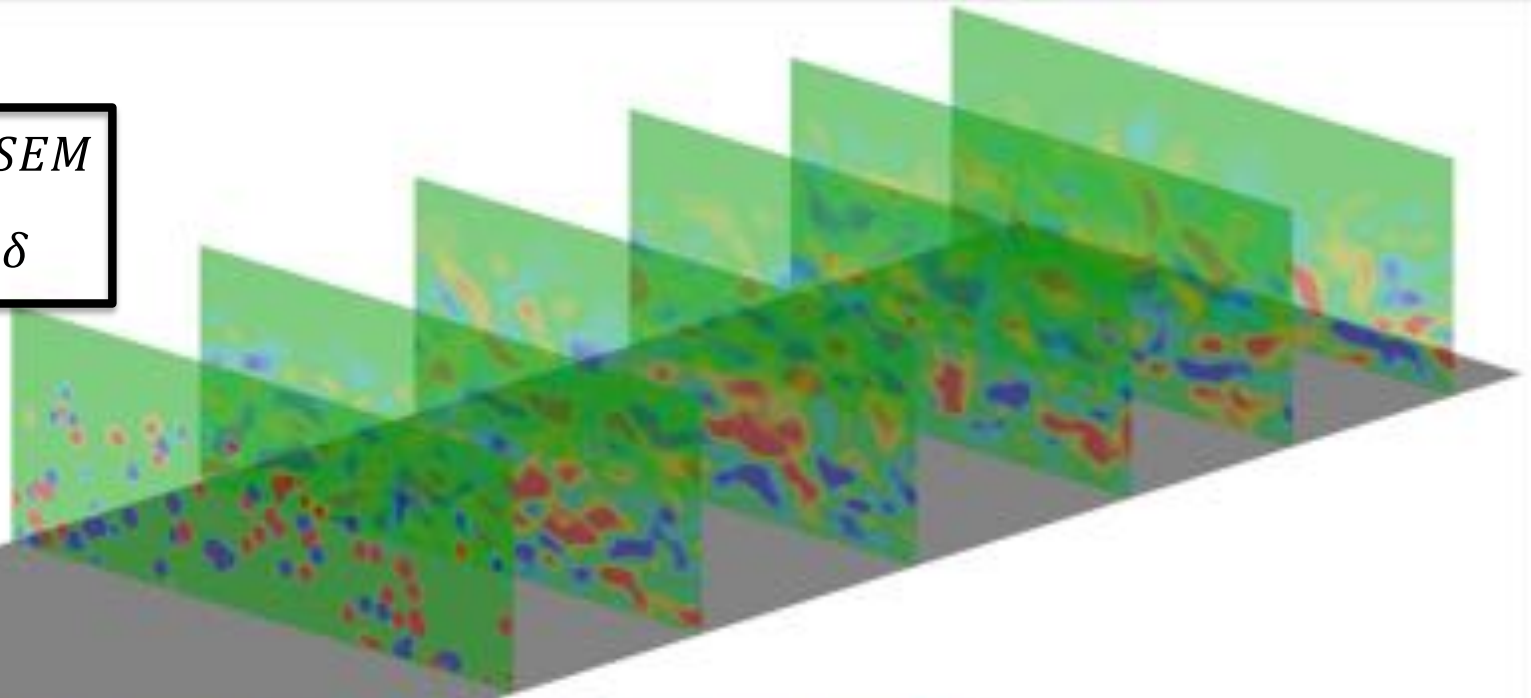

V: -0.010 -0.008 -0.007 -0.005 -0.004 -0.002 -0.001 0.001 0.002 0.004 0.005 0.007 0.008 0.010

- Motivation
- Experimental Setup
- Computational Methodology
- **Structured Overset Grid System**
- Axisymmetric Round Jet
 - Flow Visualization
 - Near-Field Results
 - Far-Field Results
- Jet Surface Interaction
 - Near-Field Results
 - Far-Field Results
- Summary and Future Work

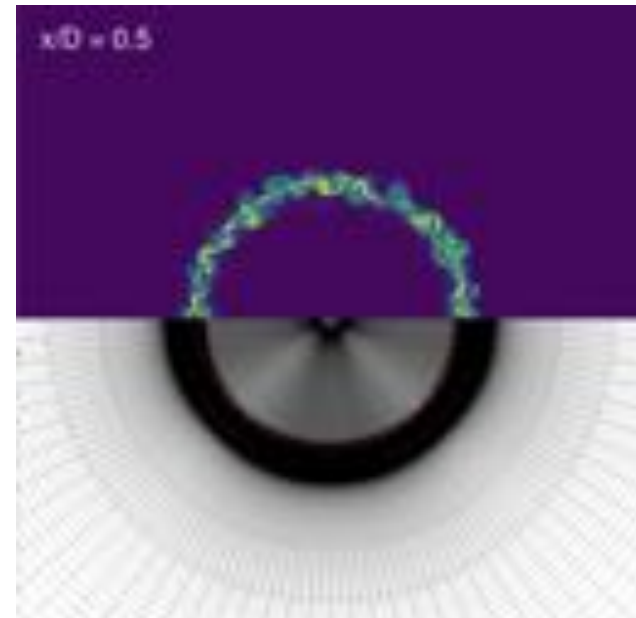
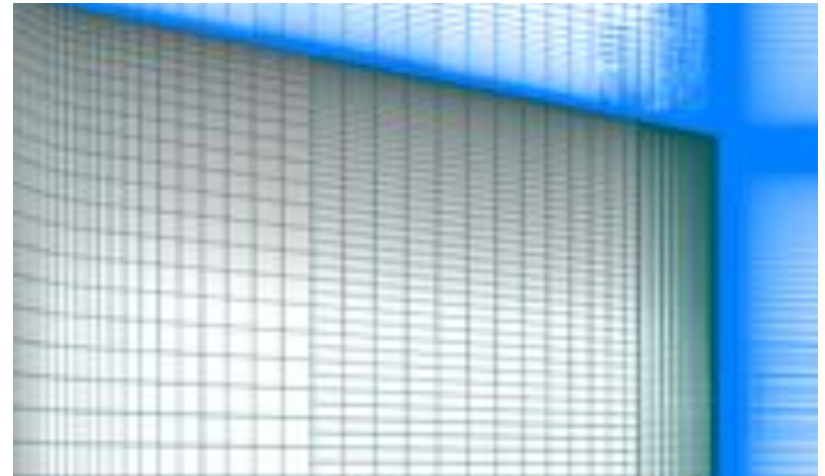

Geometry and Setup

Computational Mesh Round Jet



- Three mesh resolution for isolated axisymmetric round jet: coarse (90M), medium (120M), fine (210M)

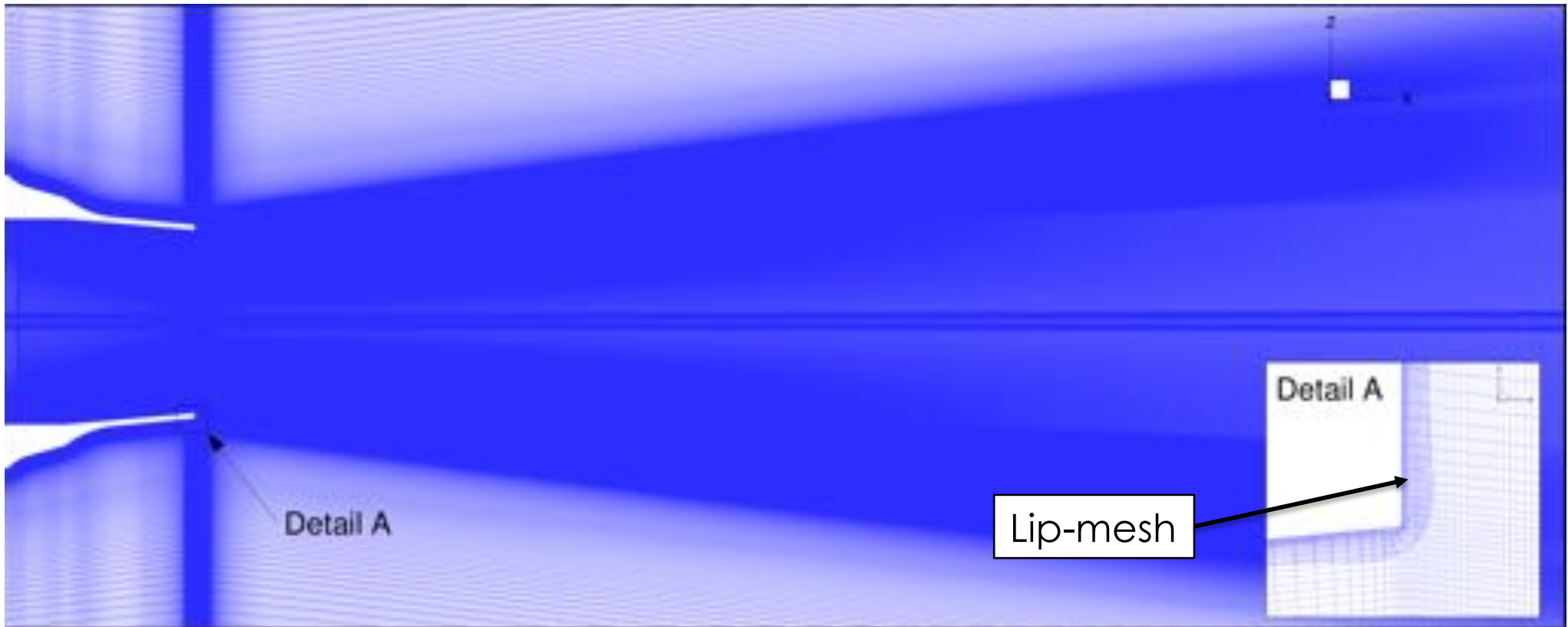

	Streamwise Points per D_j				Circumferential Points			
	$0.1D_j$	$1D_j$	$10D_j$	$25D_j$	θ_1	θ_2	θ_3	θ_4
coarse	250	45	45	40	360	180	90	90
medium	300	61	54	45	720	360	180	90
fine	300	71	60	54	1440	720	360	180

Geometry and Setup

Computational Mesh Round Jet

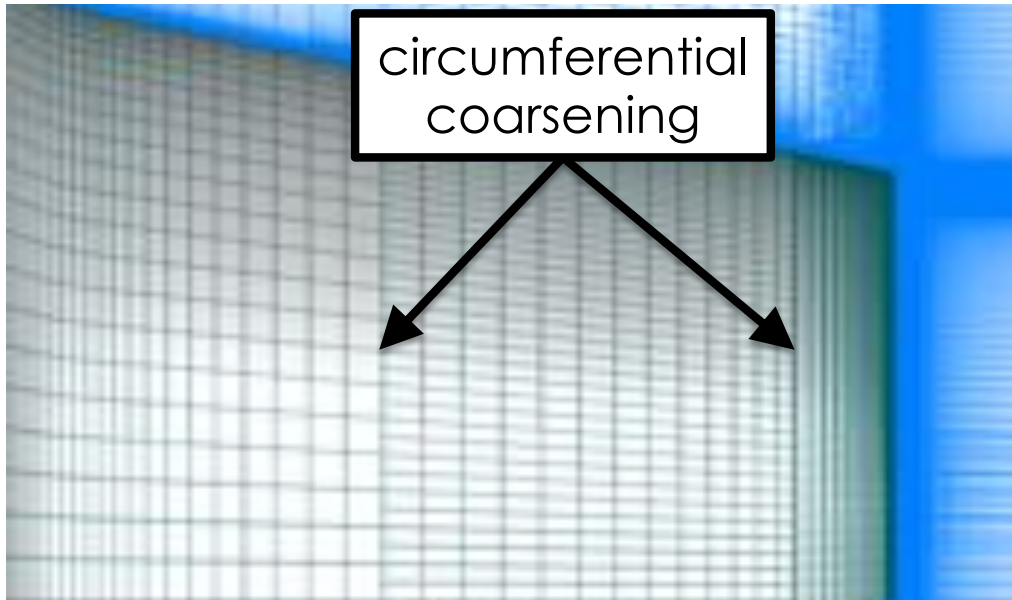

- Circumferential coarsening in axial and radial direction
Bres *et. al.* (AIAA-2015-2535)

	Circumferential Points			
	θ_1	θ_2	θ_3	Θ_4
coarse	360	180	90	90
medium	720	360	180	90
fine	1440	720	360	180

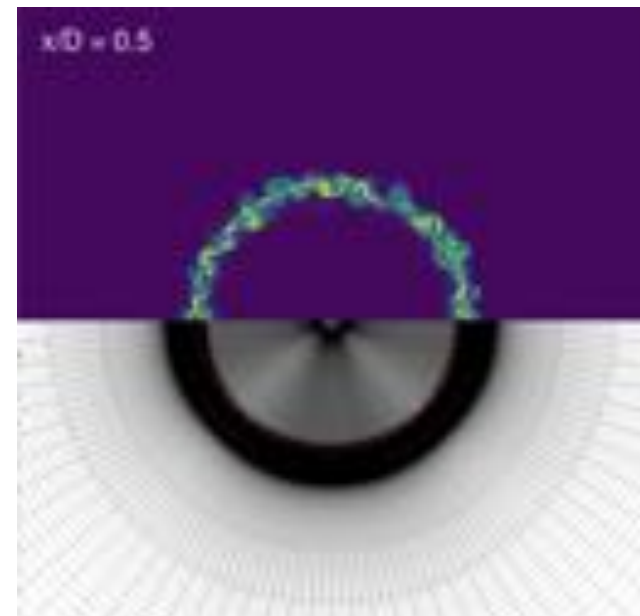
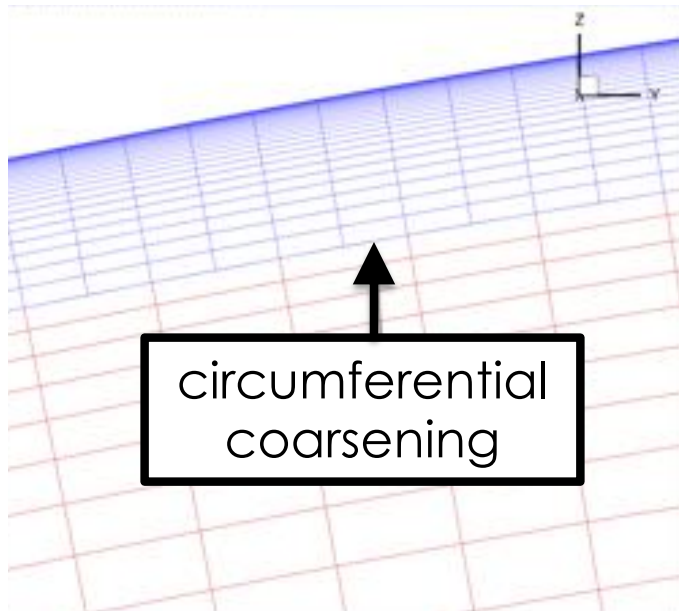

Geometry and Setup

Computational Mesh Jet Shielding Plate

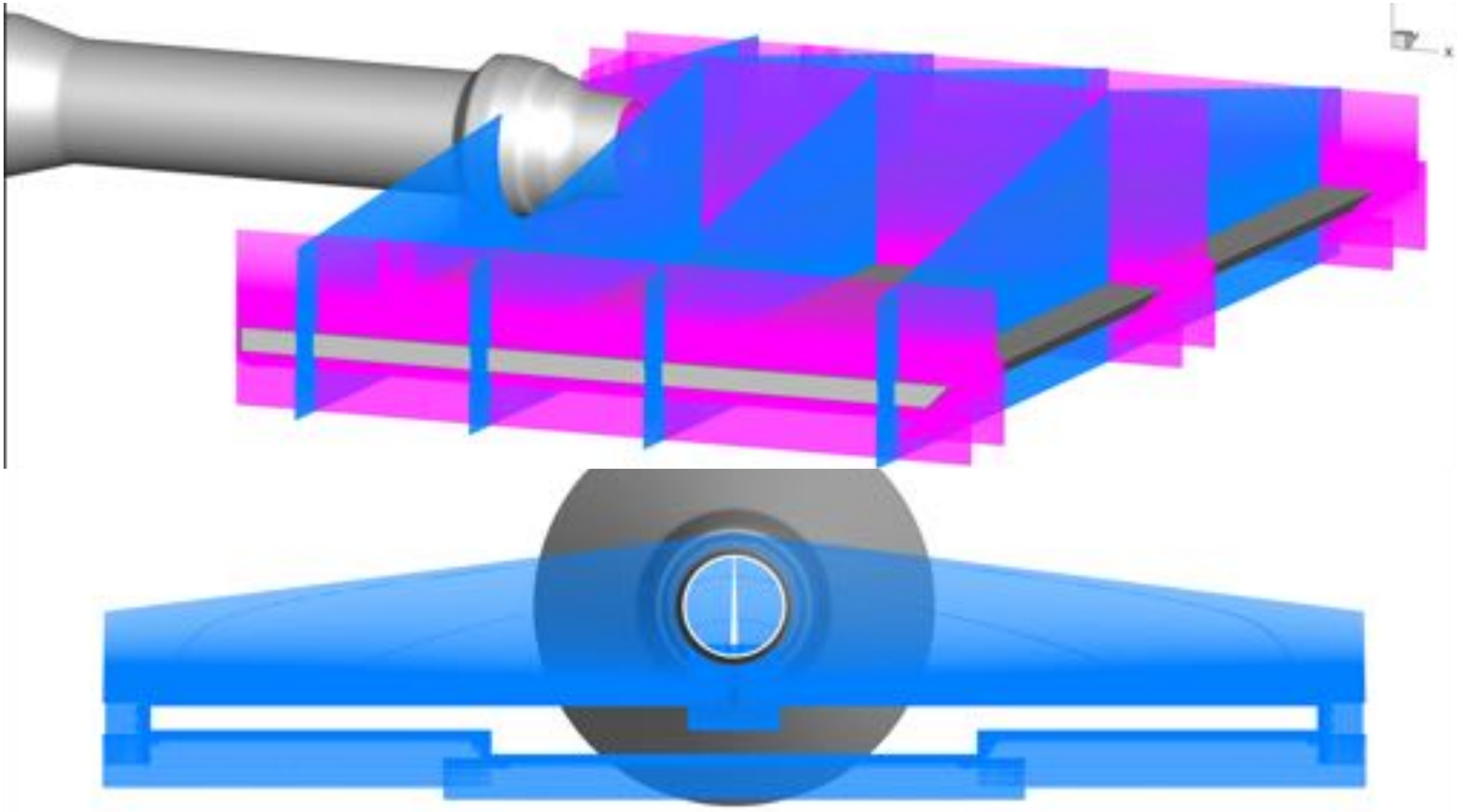

- Mesh surrounding jet shielding plate consists of 130M grid points (combined with medium isolated mesh 230M)

- Motivation
- Experimental Setup
- Computational Methodology
- Structured Overset Grid System
- **Axisymmetric Round Jet**
 - Flow Visualization
 - Near-Field Results
 - Far-Field Results
- Jet Surface Interaction
 - Near-Field Results
 - Far-Field Results
- Summary and Future Work

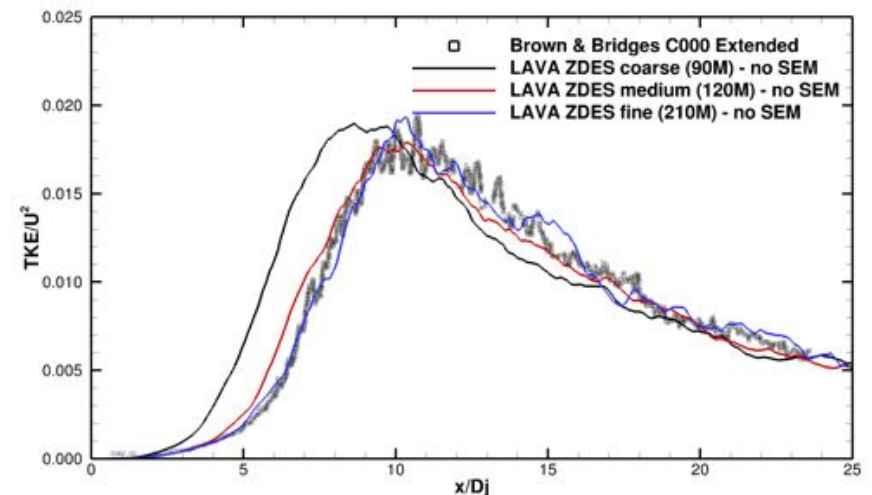
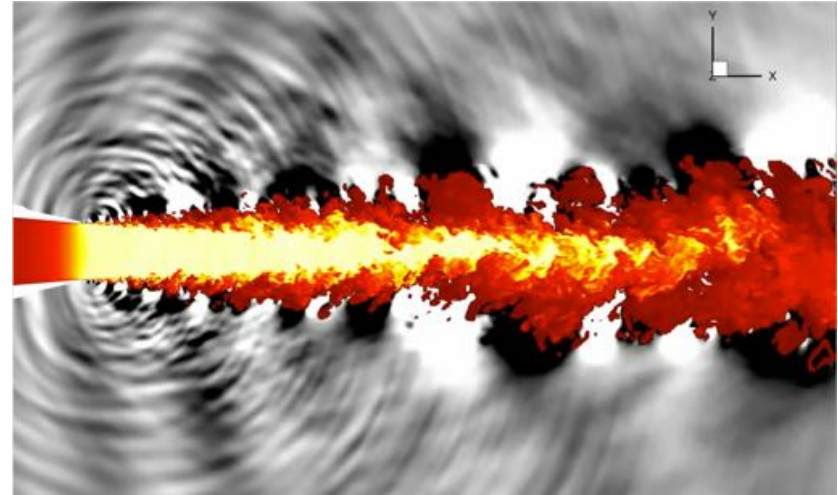

Flow Field Visualization

Isocontour of Q-Criteria colored by axial Velocity



Coarse (90M)

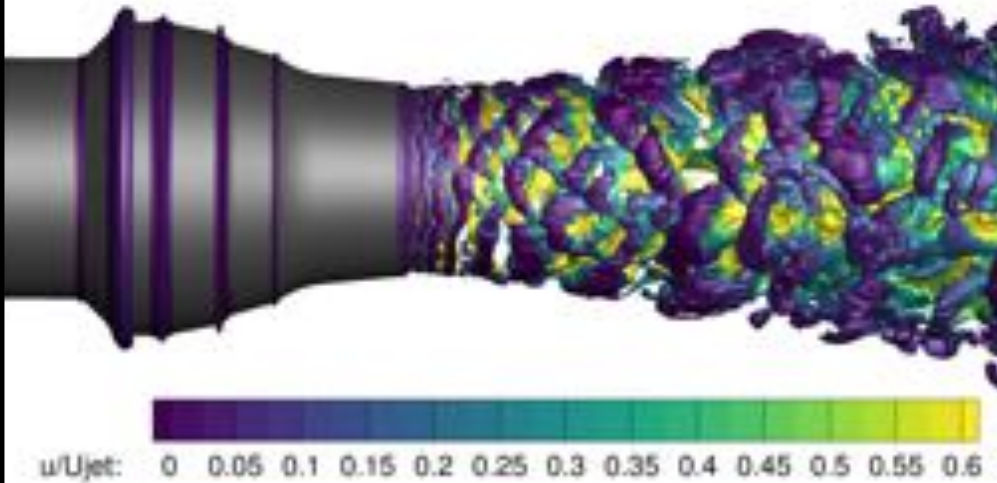

Medium (120M)

Jeff H. : "Waffle Cone"

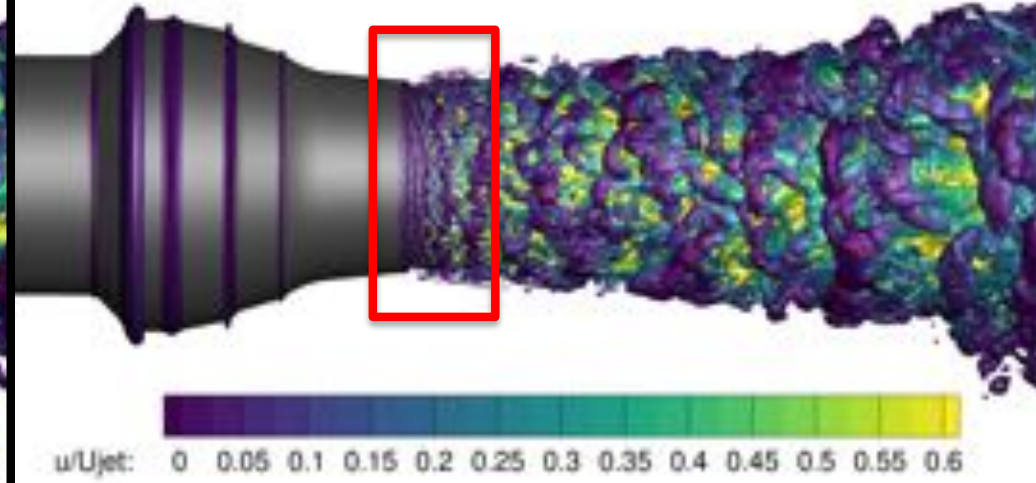

Fine (210M)

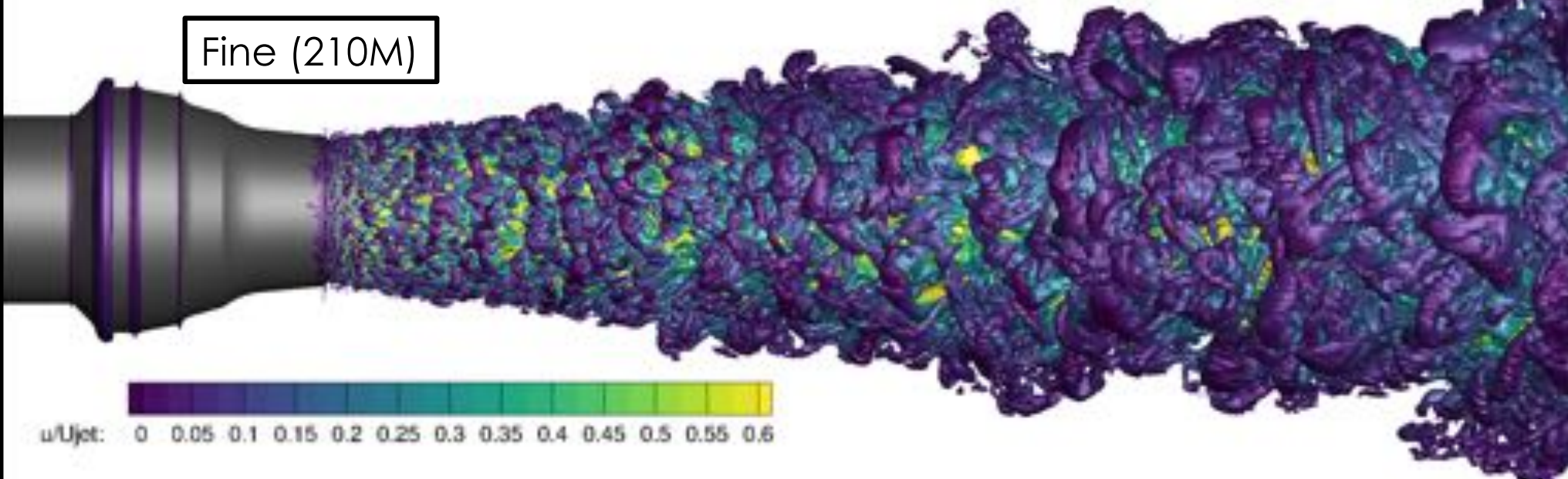

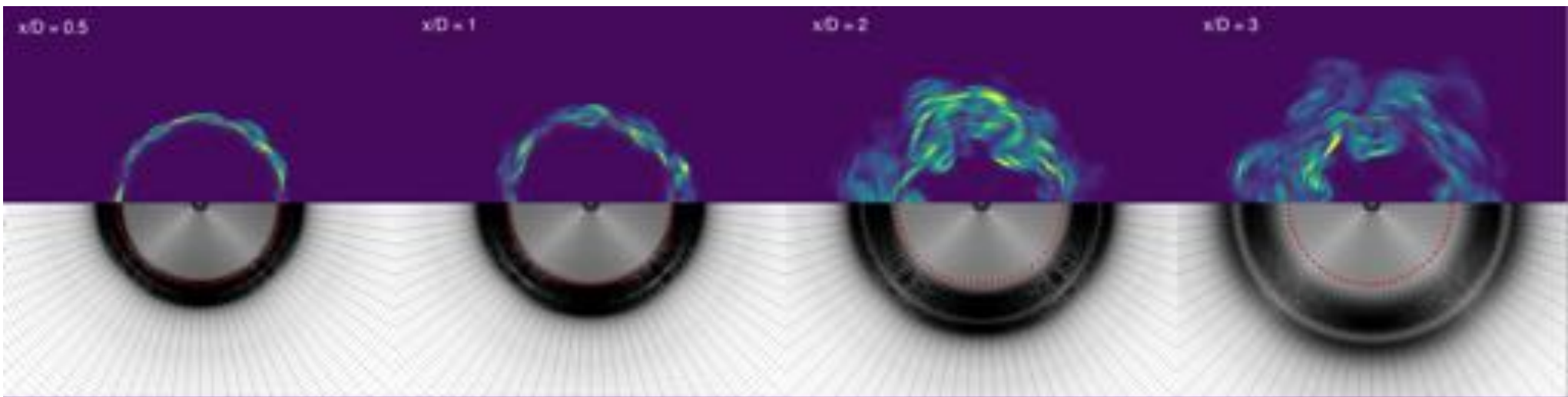

Coarse (90M) vorticity magnitude

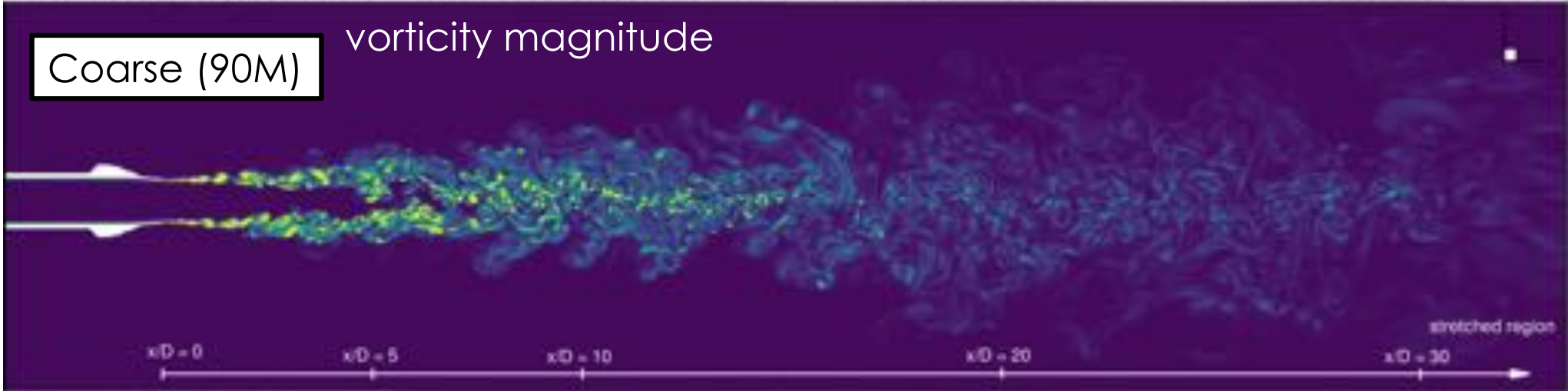

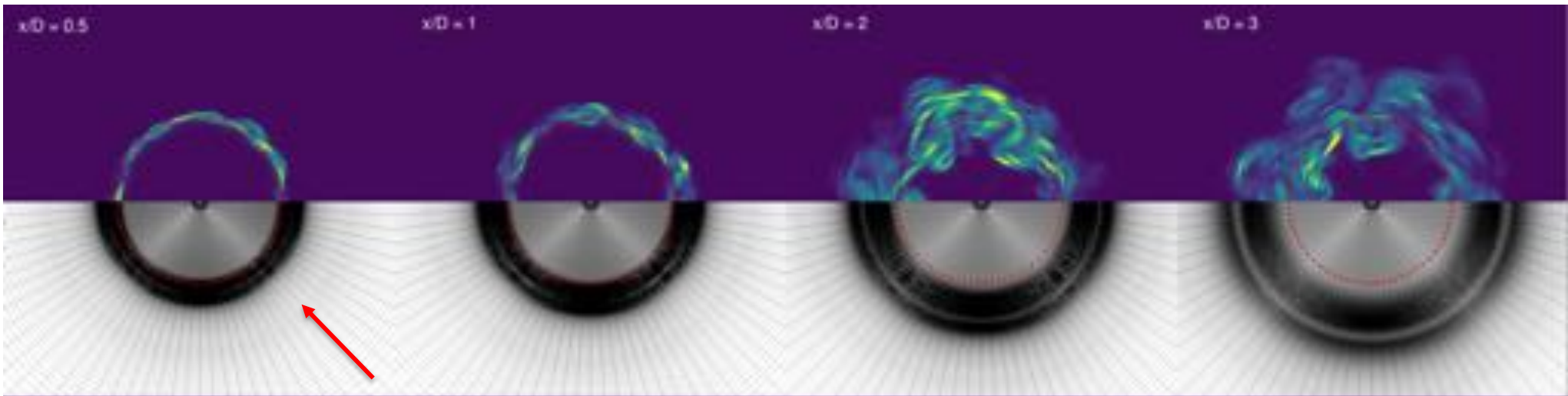

Coarse (90M) vorticity magnitude

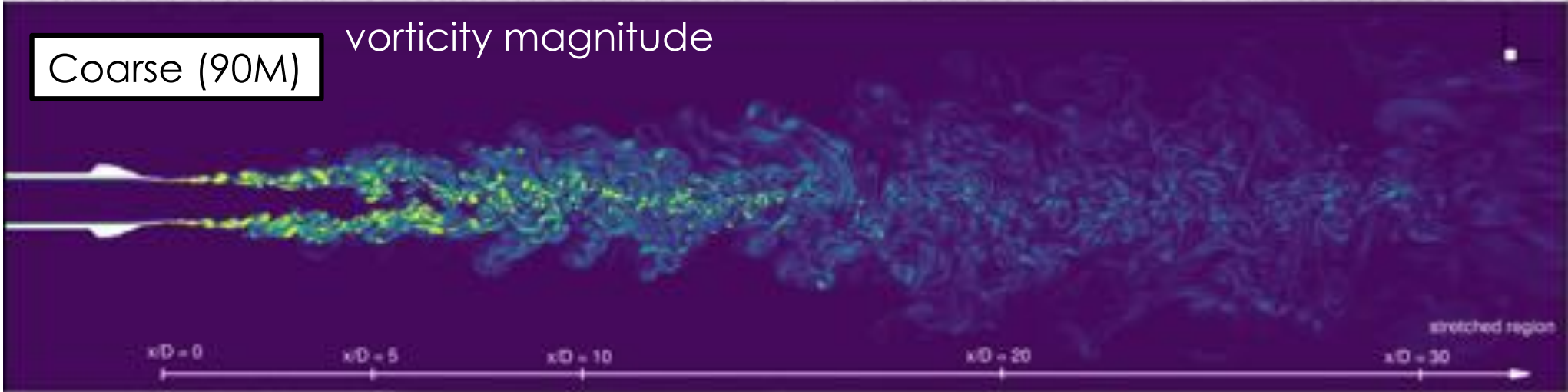

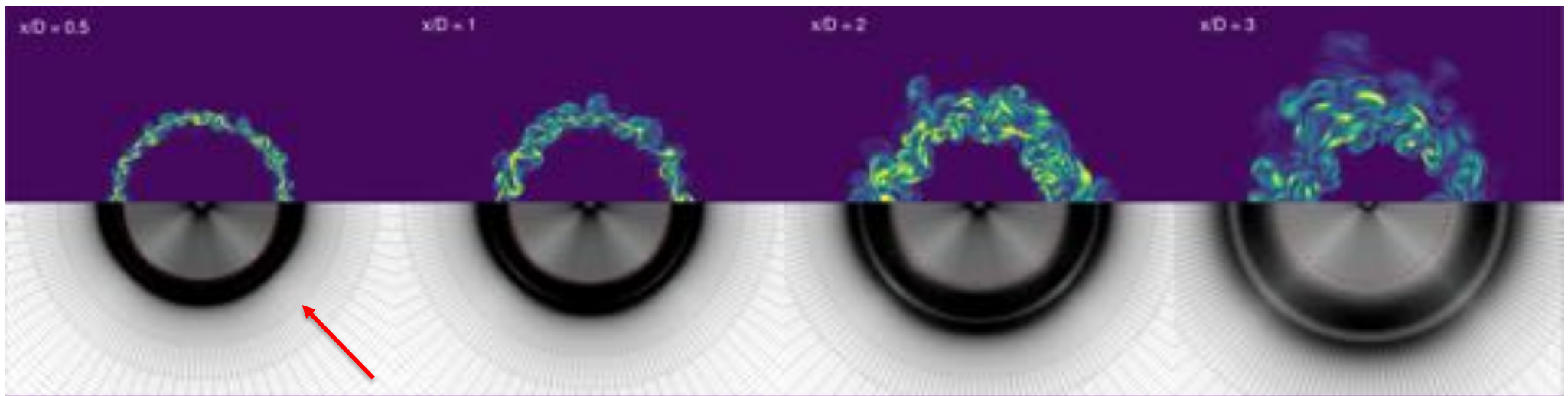

Fine (210M)

vorticity magnitude

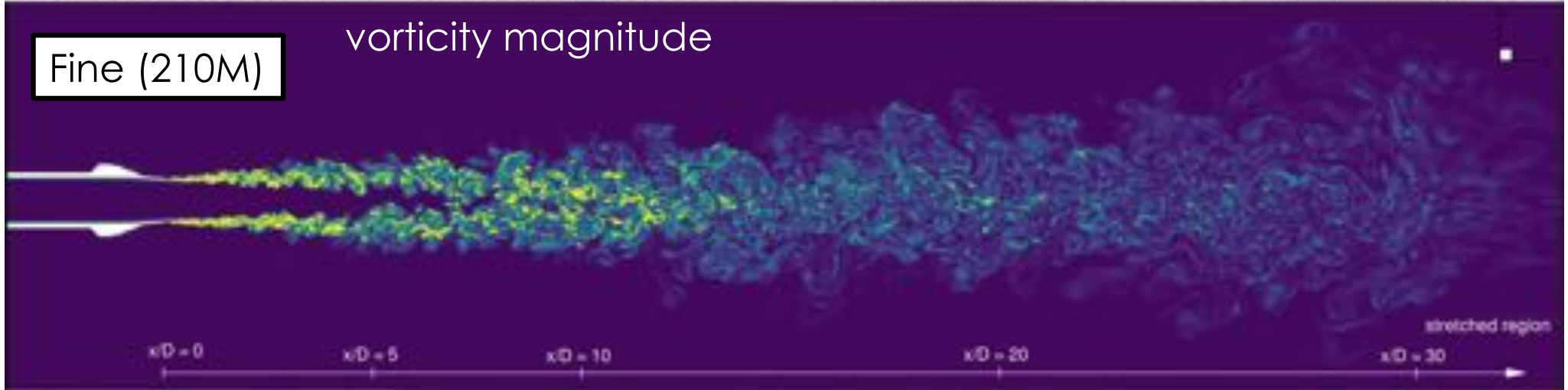

Near-Field

Centerline Axial Velocity and Turbulent Kinetic Energy



(a) axial velocity

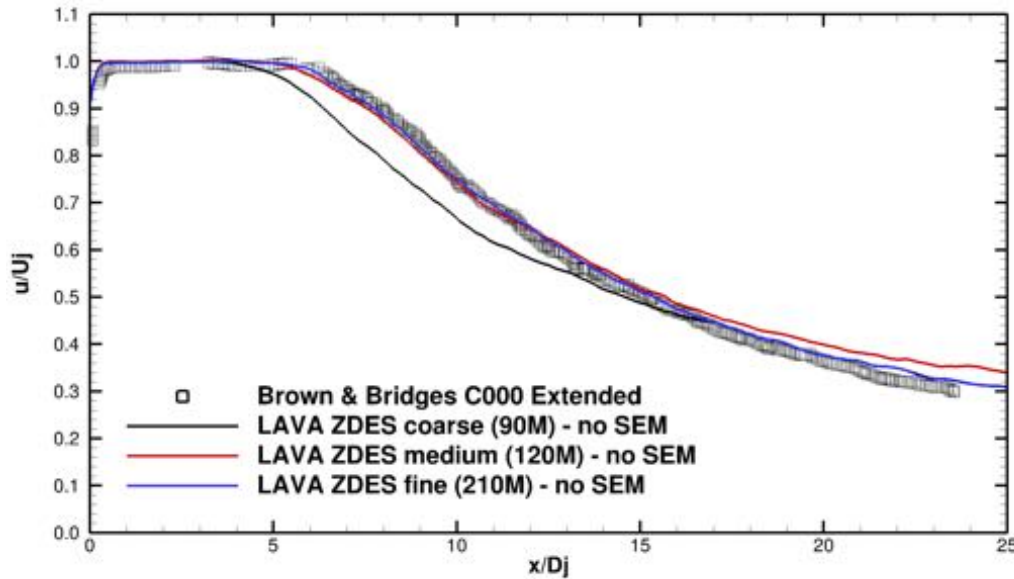

(b) turbulent kinetic energy (TKE)

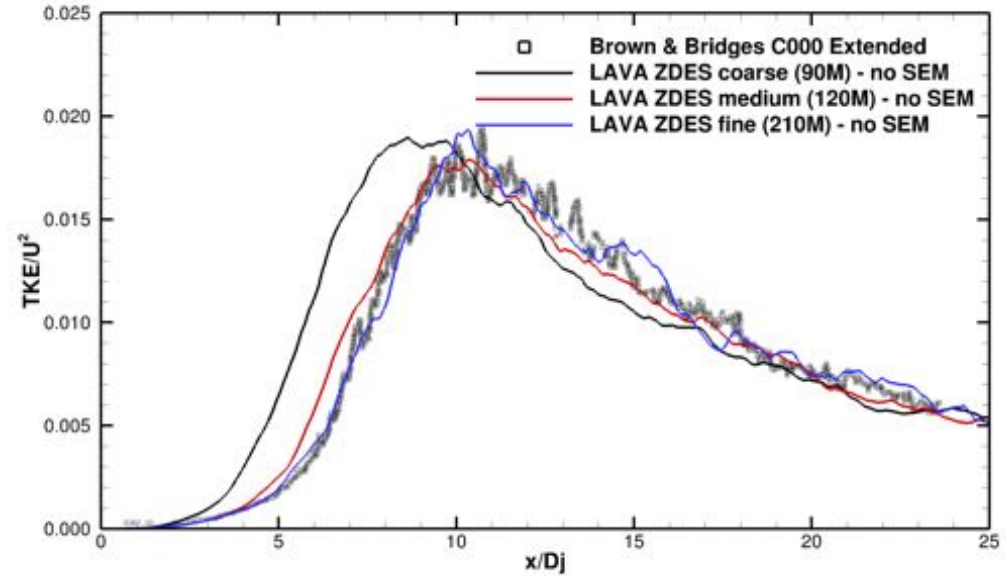

- Length of potential core X_C taken where centerline velocity 98% U_{jet}
- Prediction of medium and fine mesh within 2.5% of measured value.
- Peak and location of Turbulent Kinetic Energy (TKE) predicted very well.

Length Potential core:

Experiment	$5.9D_j$
coarse	$4.85D_j$
medium	$5.75D_j$
fine	$5.8D_j$

Near-Field

Time-Averaged Axial Velocity at Radial Slices

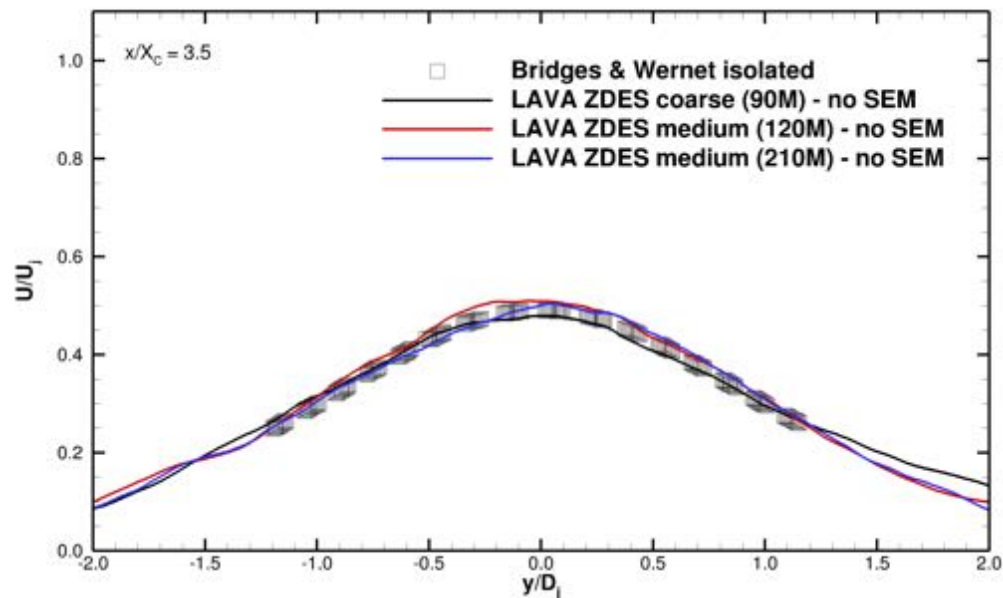
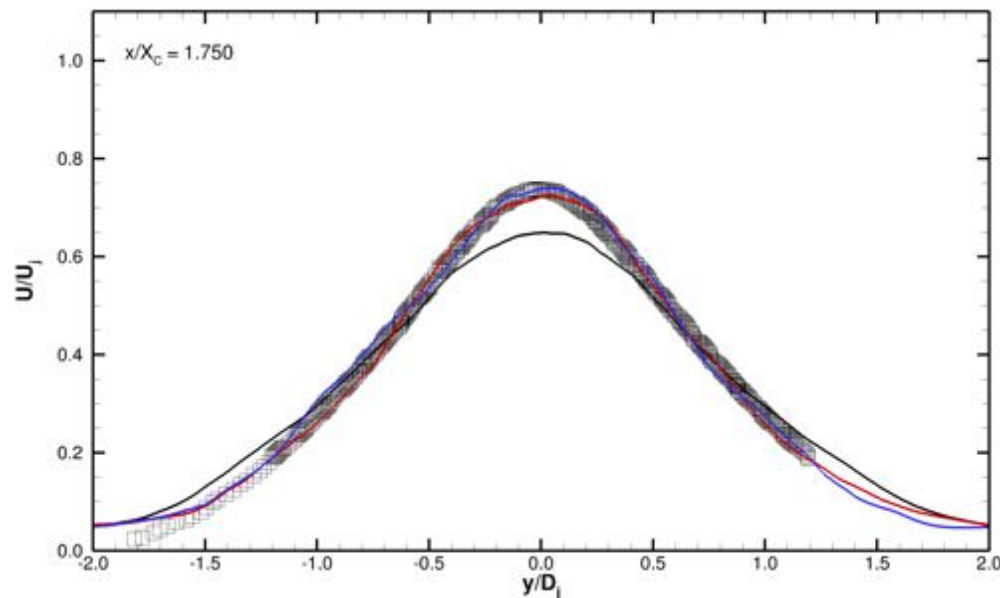
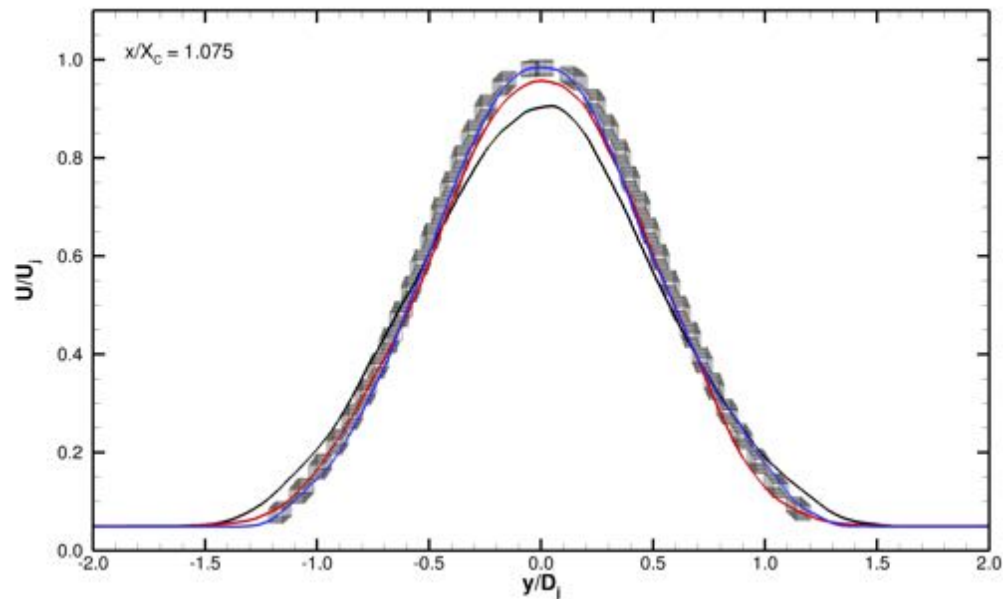
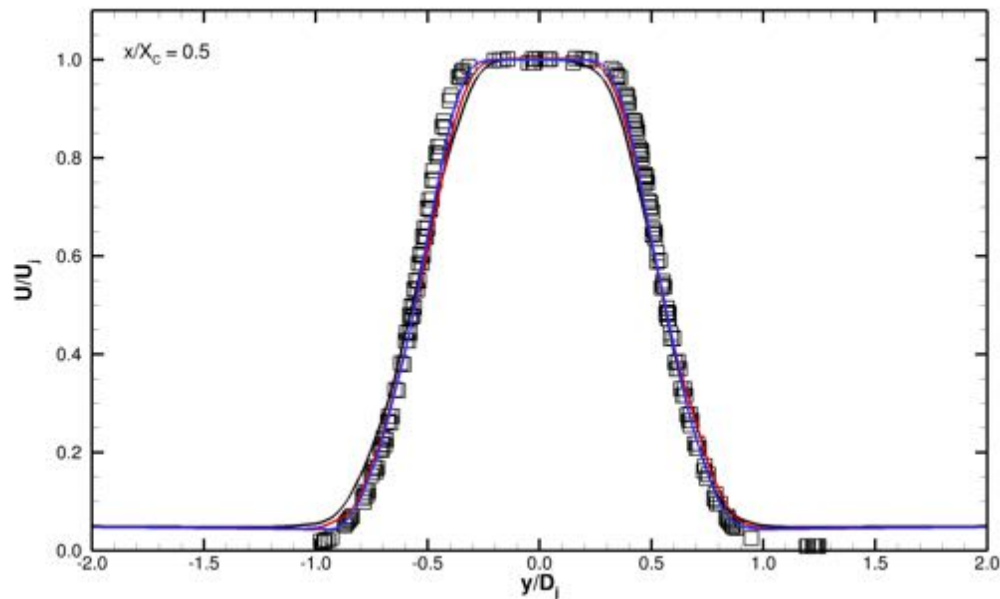

- Location of axial slice normalized by potential core length $X_c = 5.9$

Far-Field – Setup and Procedure



Frequency Domain Permeable Ffowcs Williams-Hawkings (FWH)

Formulation consistent with
Lockhard AIAA-2002-2580

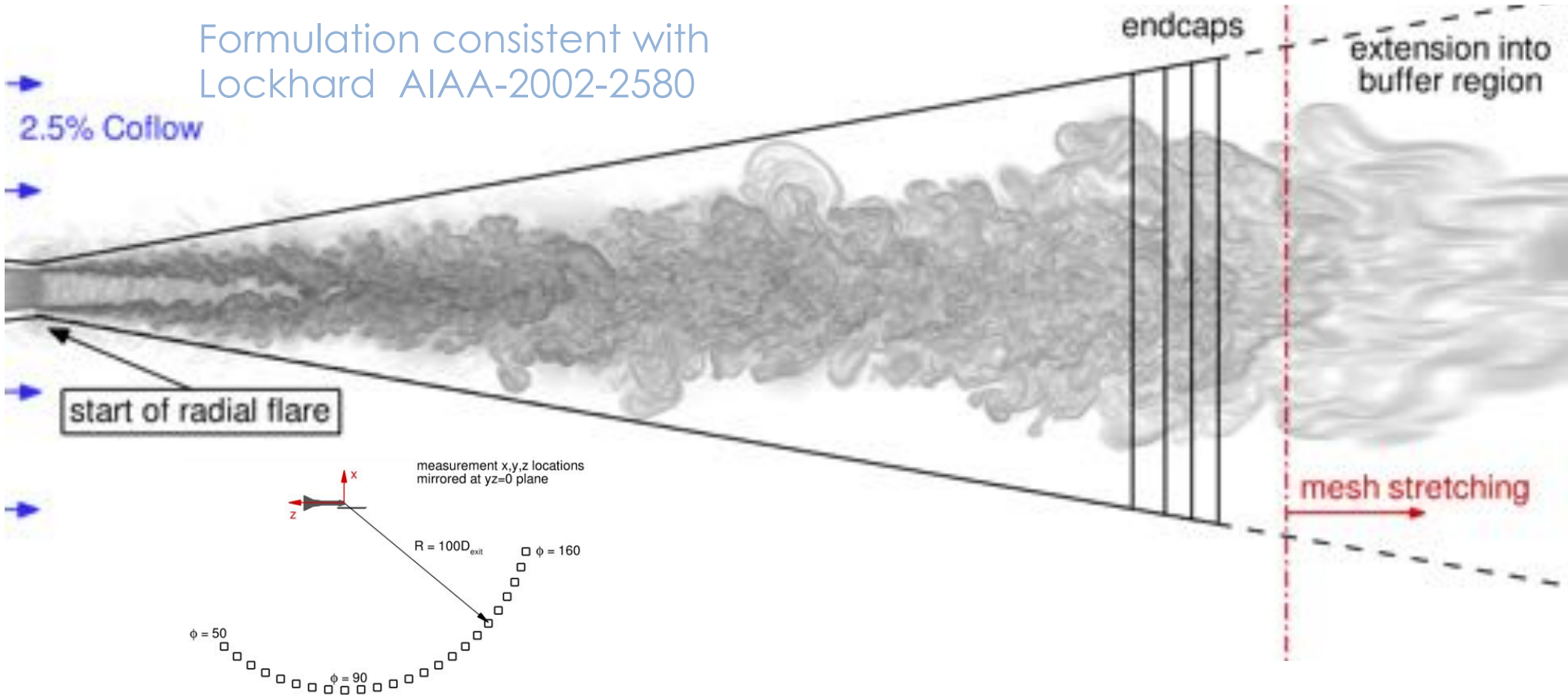

- Interpolate Volume solution to FWH surface at sampling rate 100kHz
- Samples taken over last 200 convective time units ($\Delta t c_\infty / D_j$)
- Time Sample Split in 5 segments with 50% overlap $St_{bin} = 0.02$
- Hanning Window is applied in the time-domain
(PSD multiplied with $\sqrt{8/3}$ to recover energy loss from Hanning window)
- PSD data assemble averaged over 360 observers per angle (60, 90, 120, 150)
- Developed automated tool to adapt number of faces on FWH surface

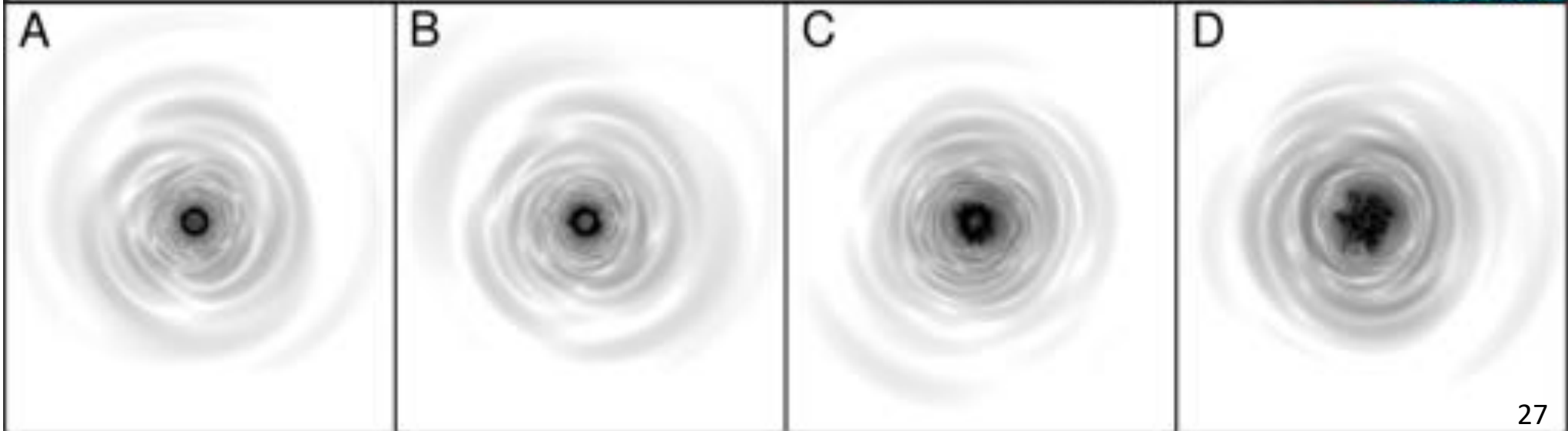
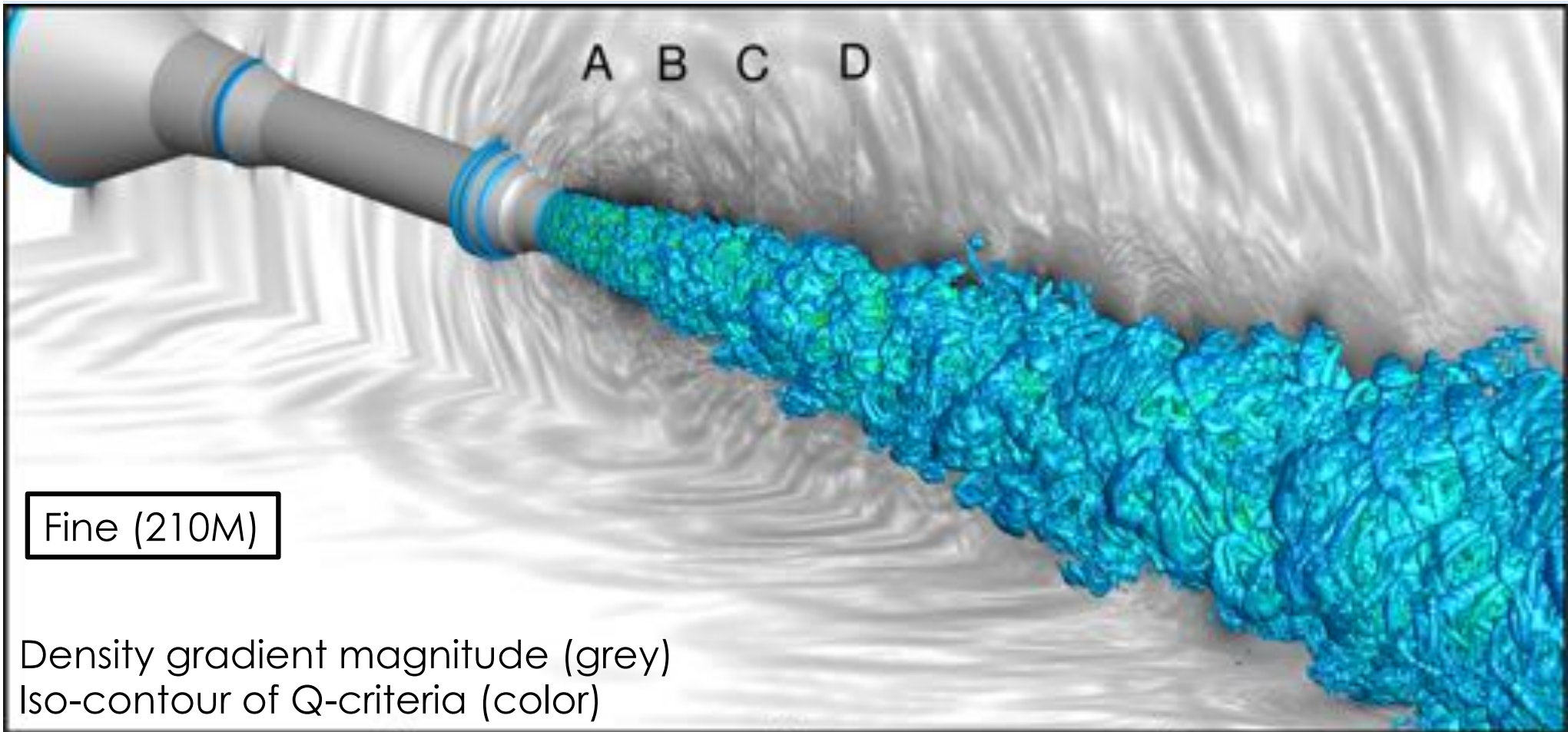

Far-Field – CFD Mesh Resolution

Comparison of PSD Spectrum 100D away from nozzle exit

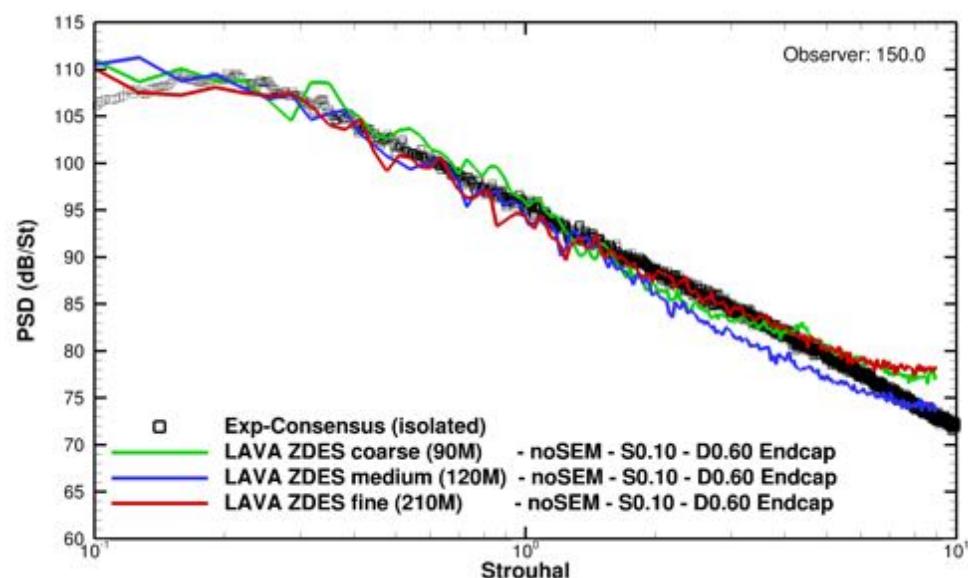
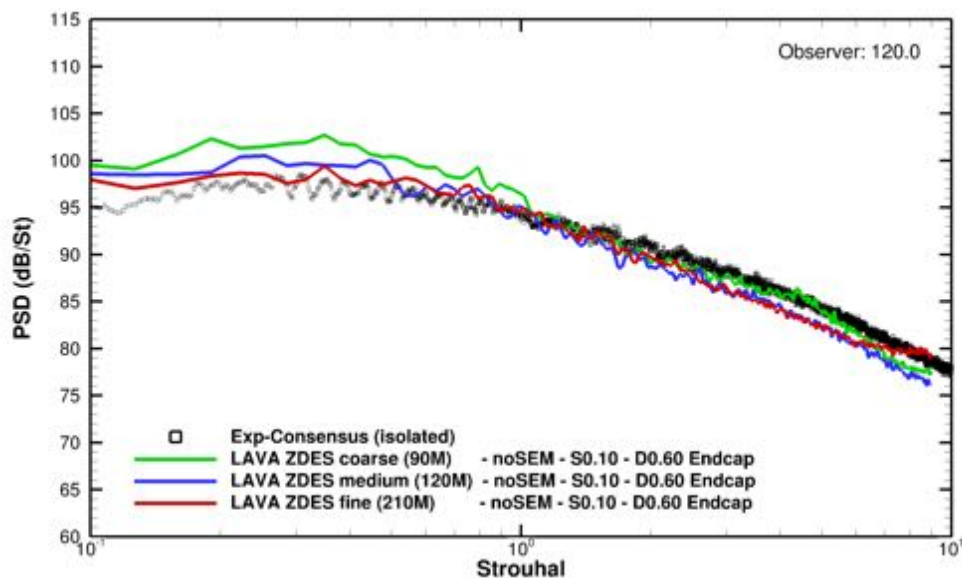
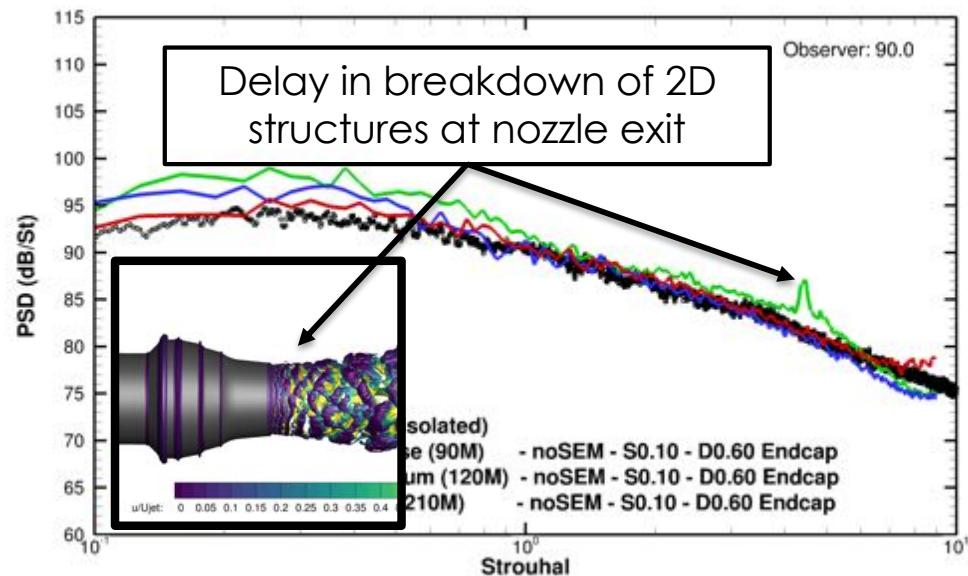
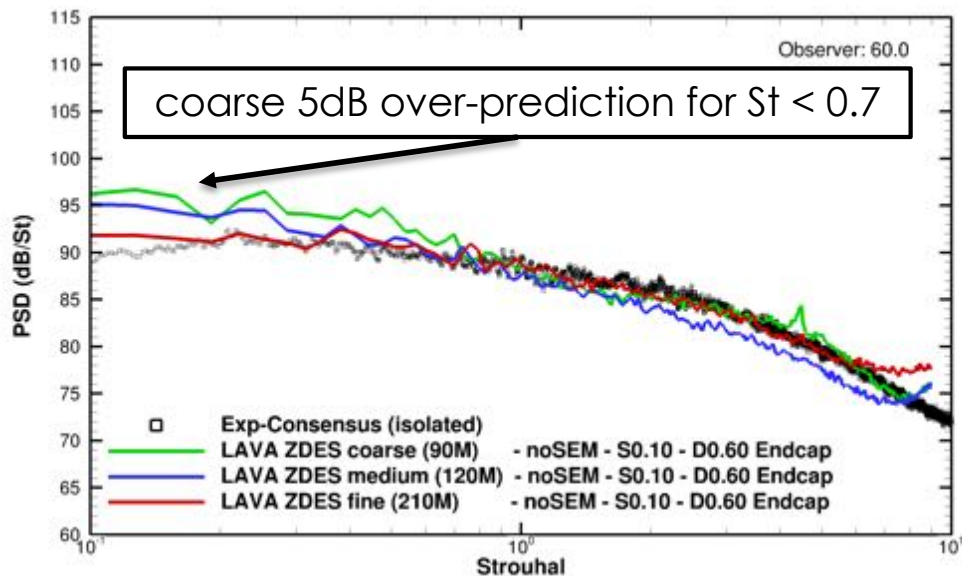

- Details of selected FWH Surface can be found in paper
- Overall excellent agreement with Exp-Consensus

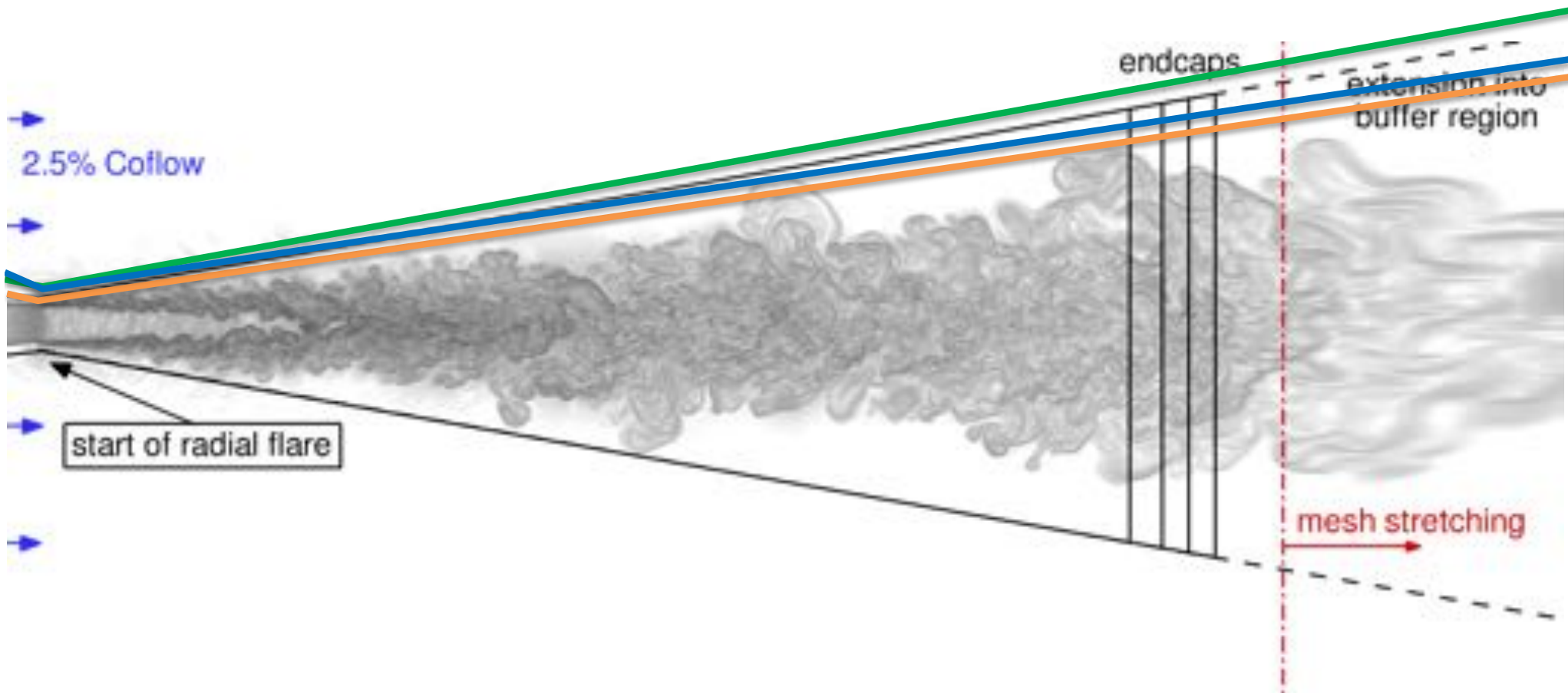

1. Start radial Flare at $x/D_j = 0.6$ or $x/D_j = 0.55$
2. Variation of slopes $S = 0.12$, $S = 0.11$, $S = 0.10$
3. Combination of (1) and (2)



Far-Field – Choice of FWH Surface

Comparison of PSD Spectrum 100D away from nozzle exit

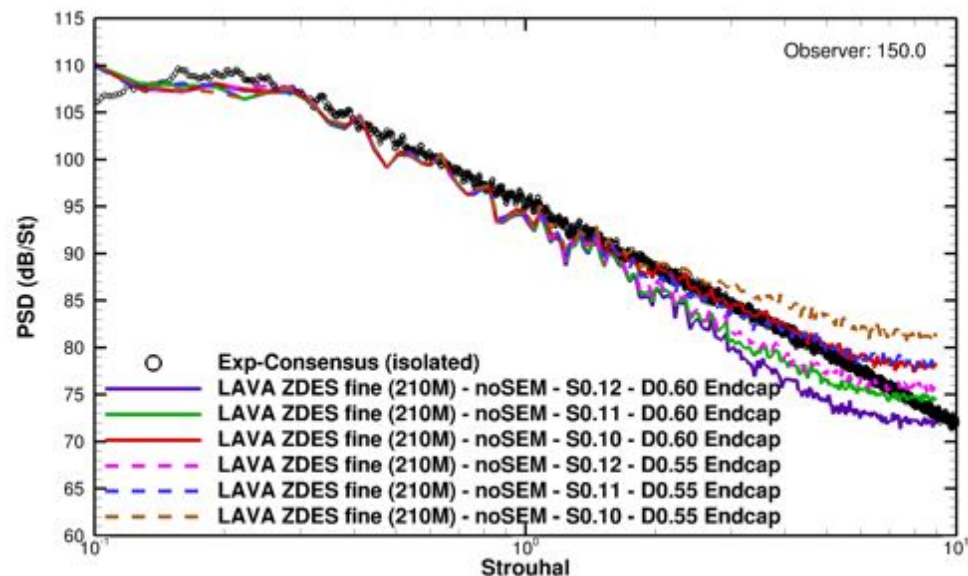
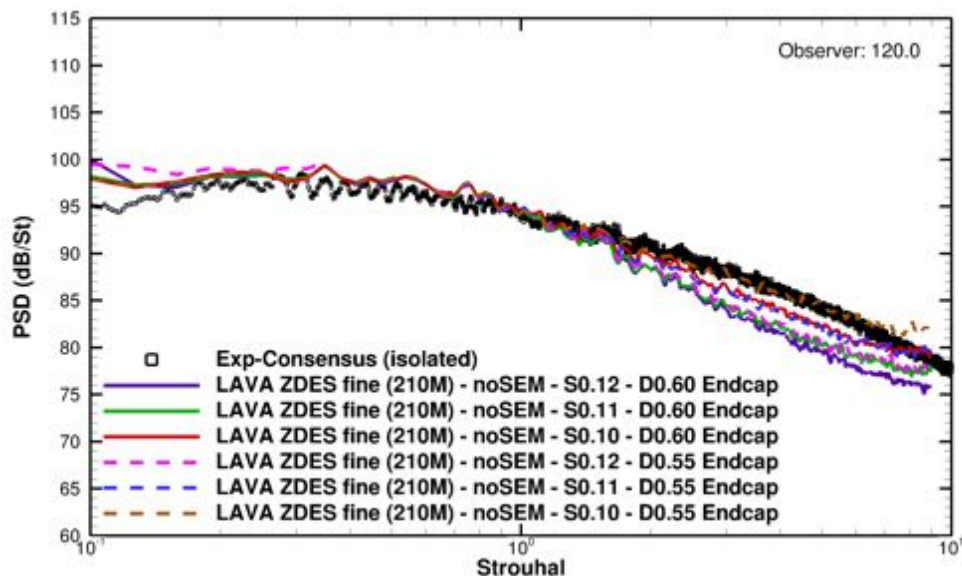
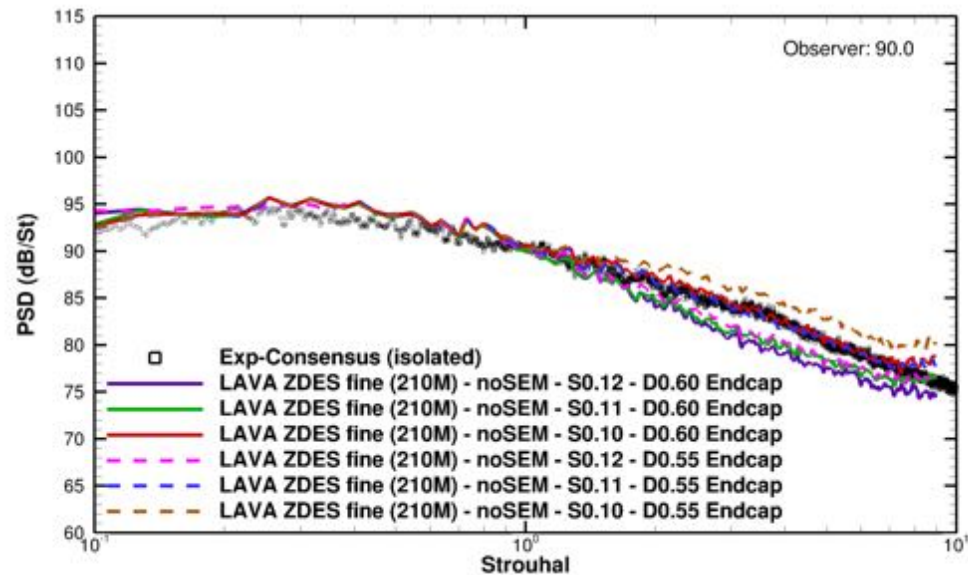
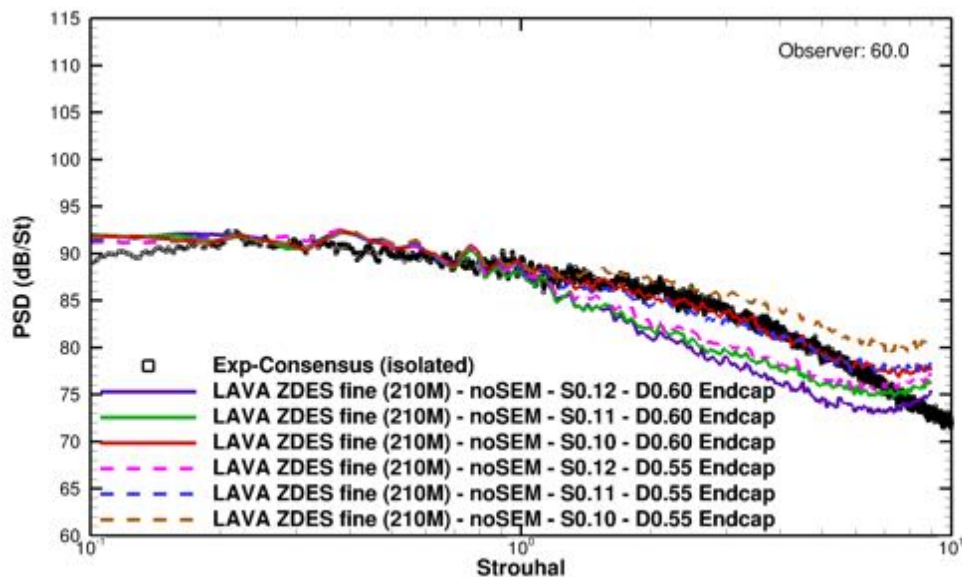

- Results sensitive to choice of FWH surface.
- Less dissipative scheme than WCNS might reduce sensitivity



Far-Field – Inflow Turbulence (SEM)

Comparison of PSD Spectrum 100D away from nozzle exit

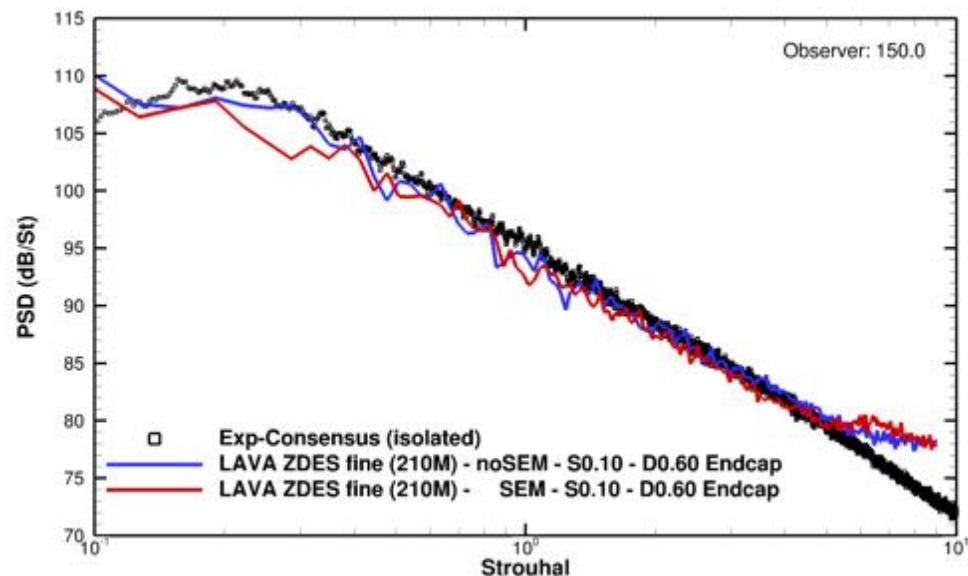
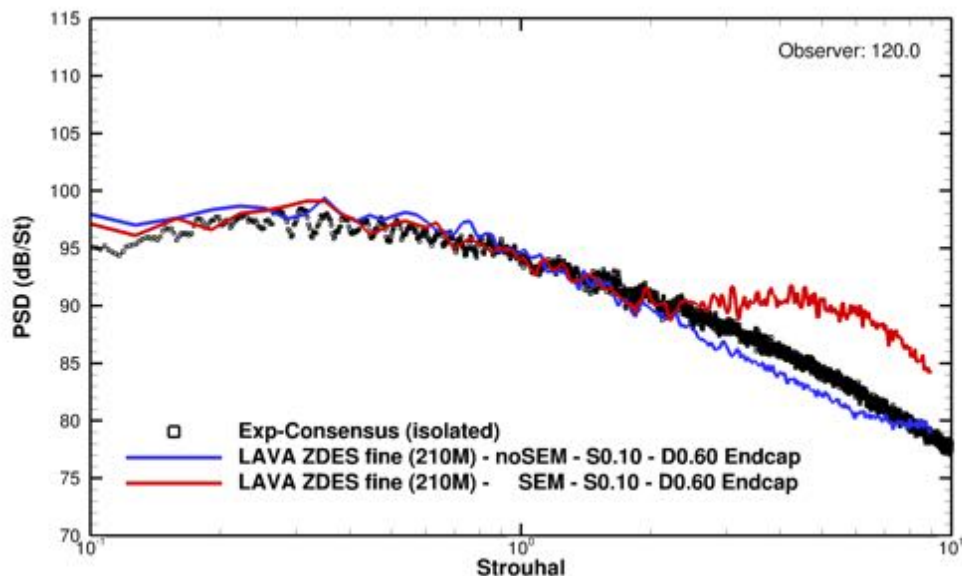
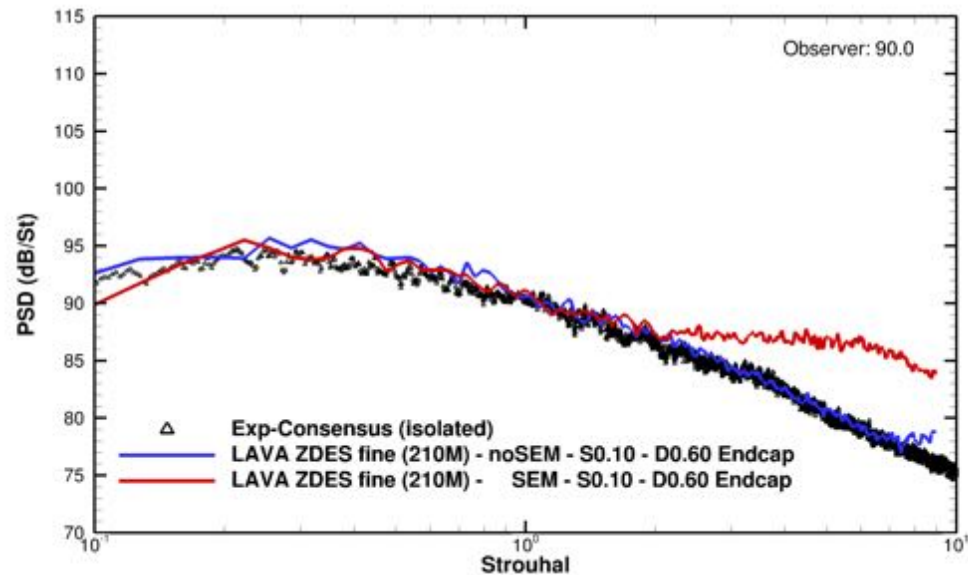
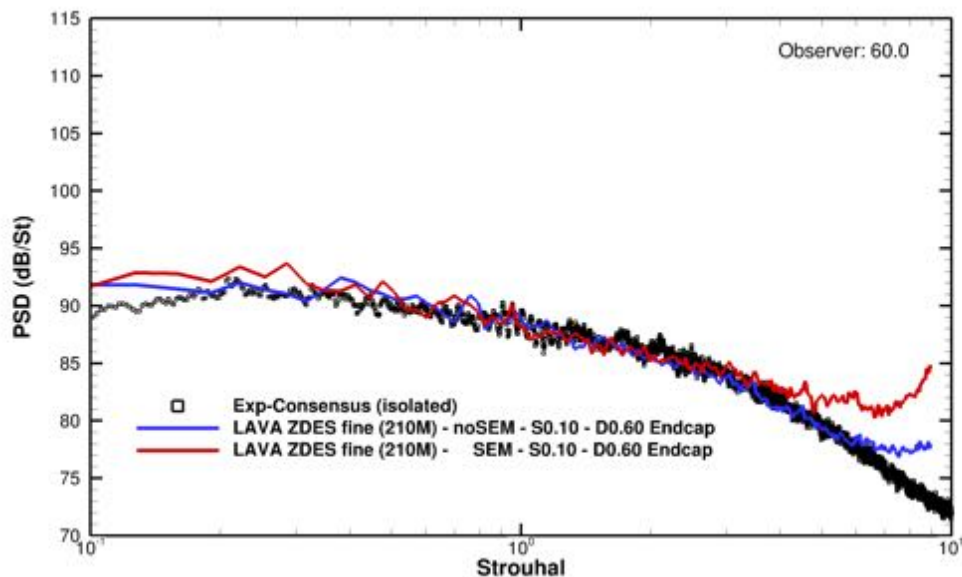

- Influence of inflow turbulence on PSD spectra.
- Smaller effect of inflow turbulence on shallower angles (150.0)

Far-Field – Inflow Turbulence (SEM)

Comparison of PSD Spectrum 100D away from nozzle exit

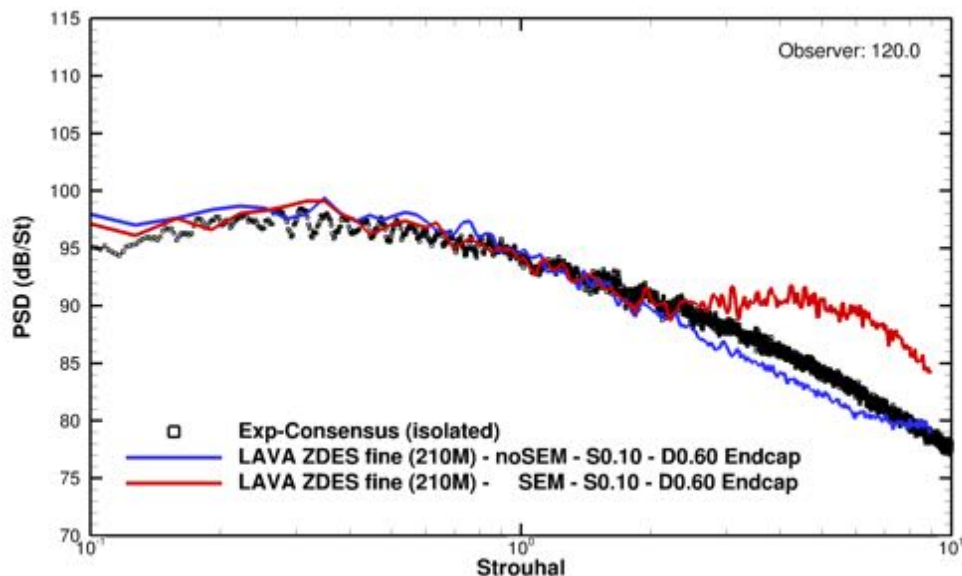
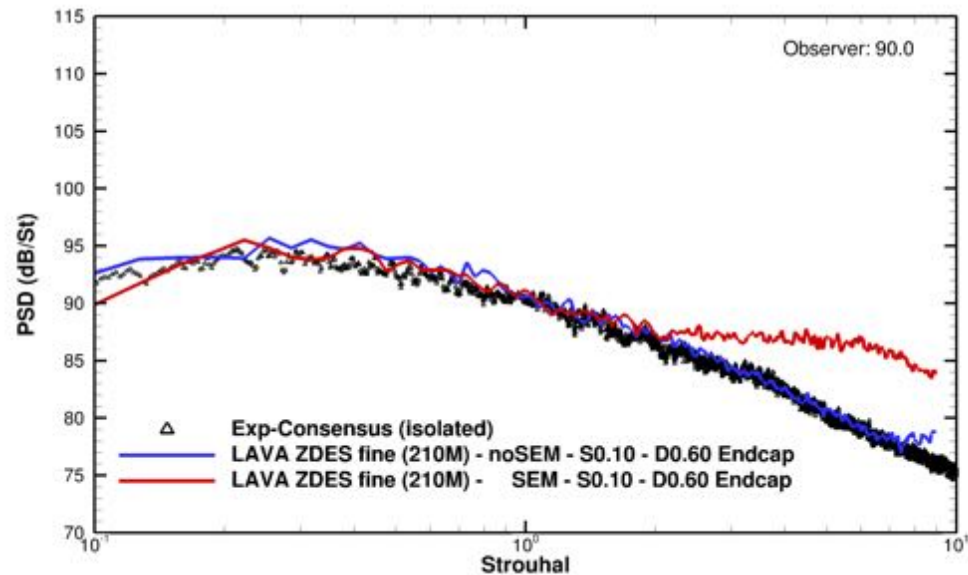
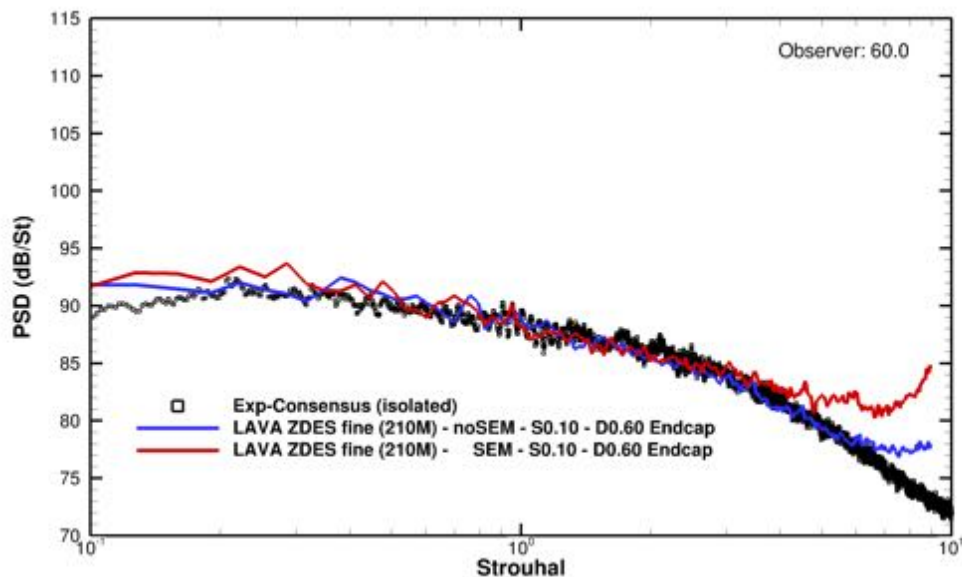

Velocity Magnitude taken from RANS

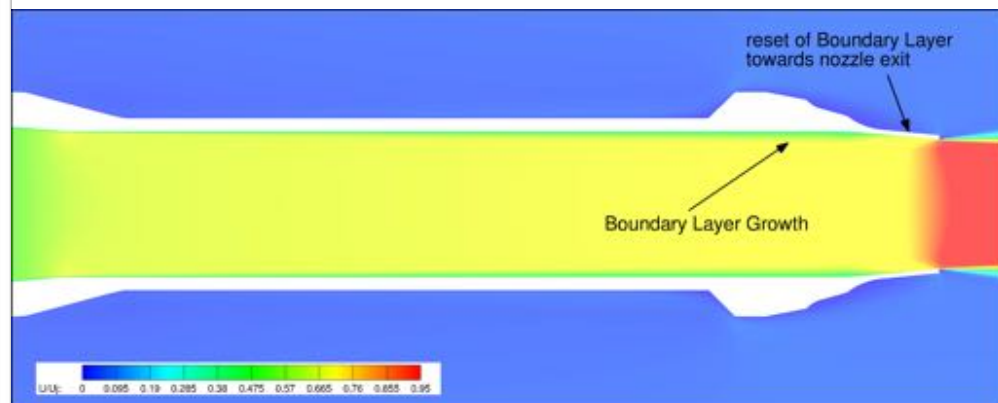

- Enhanced influence on noise spectra for SMC000 with 12"
- Addition inflow generation methods currently under consideration.

- Motivation
- Experimental Setup
- Computational Methodology
- Structured Overset Grid System
- Axisymmetric Round Jet
 - Flow Visualization
 - Near-Field Results
 - Far-Field Results
- **Jet Surface Interaction**
 - Near-Field Results
 - Far-Field Results
- Summary and Future Work

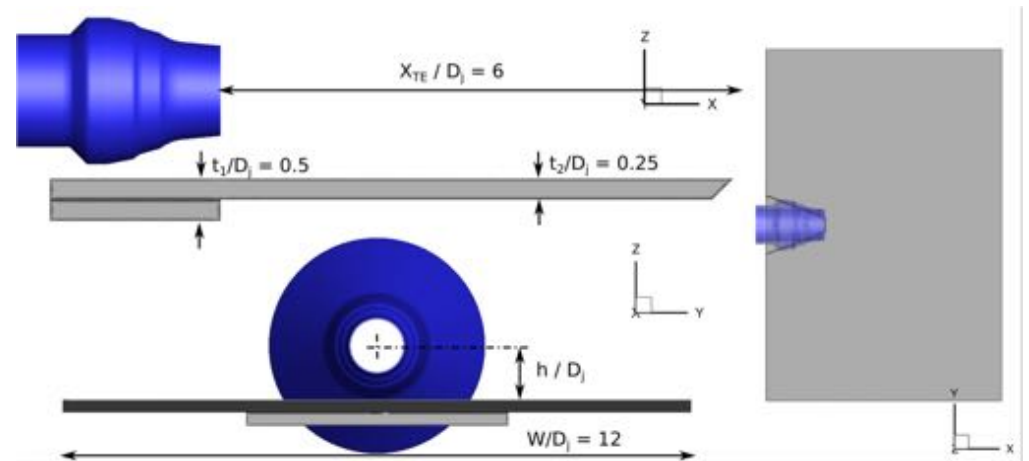
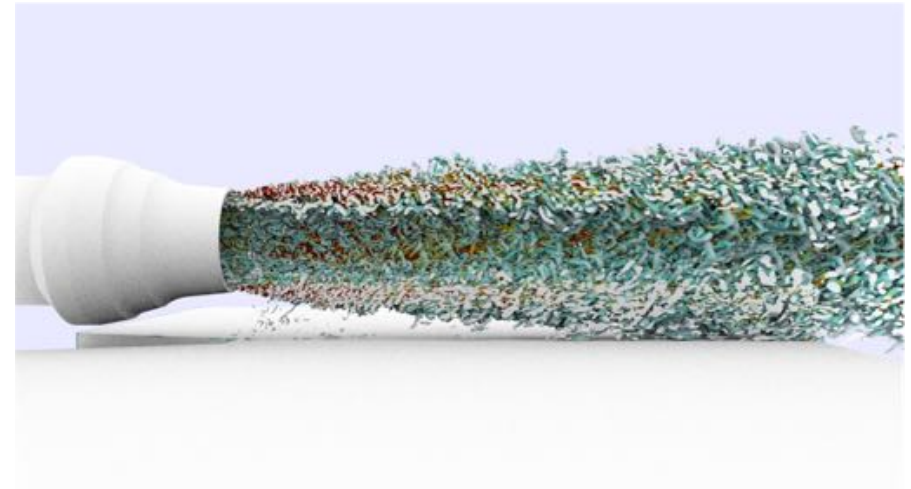

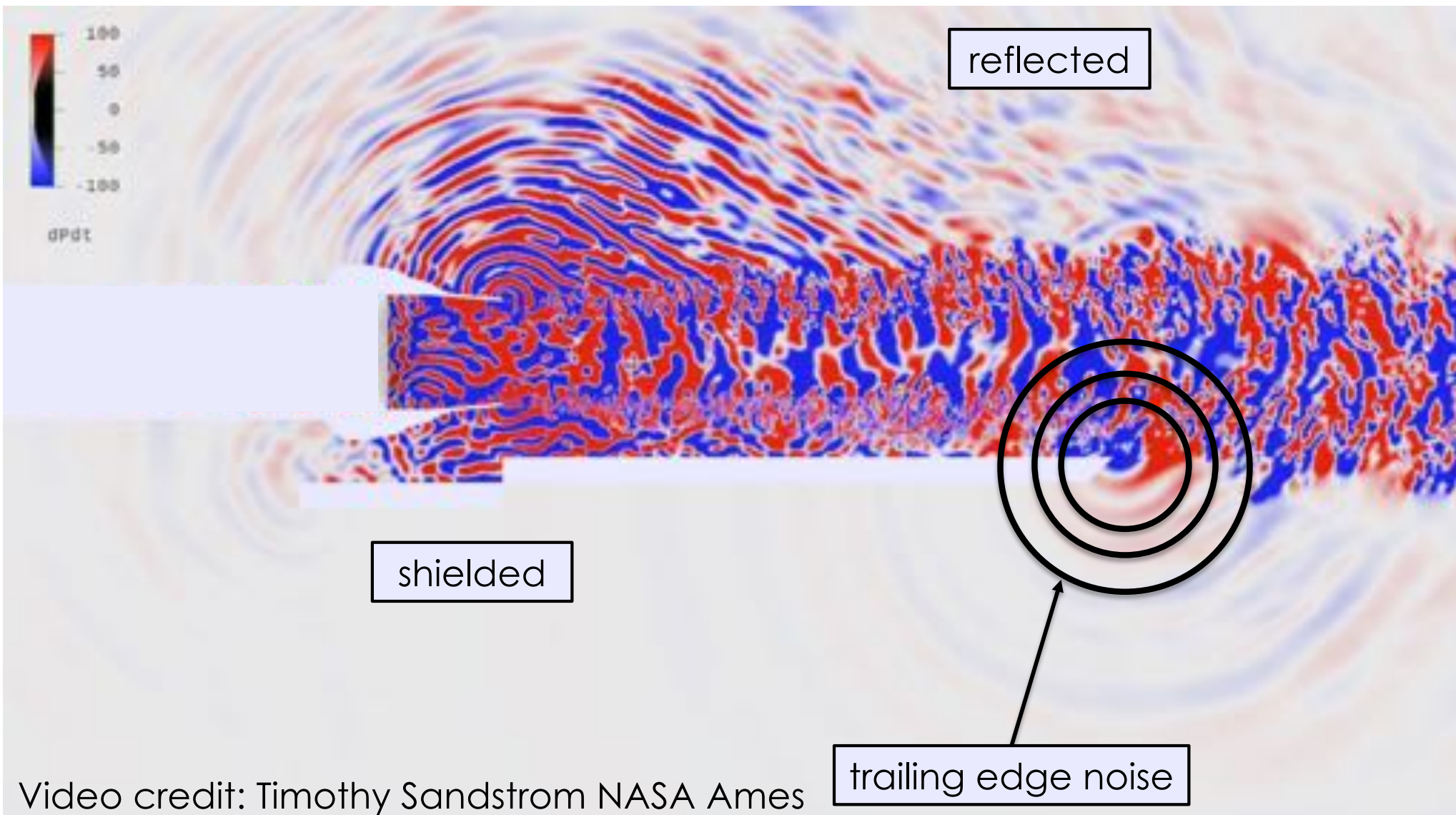

Video credit: Timothy Sandstrom NASA Ames

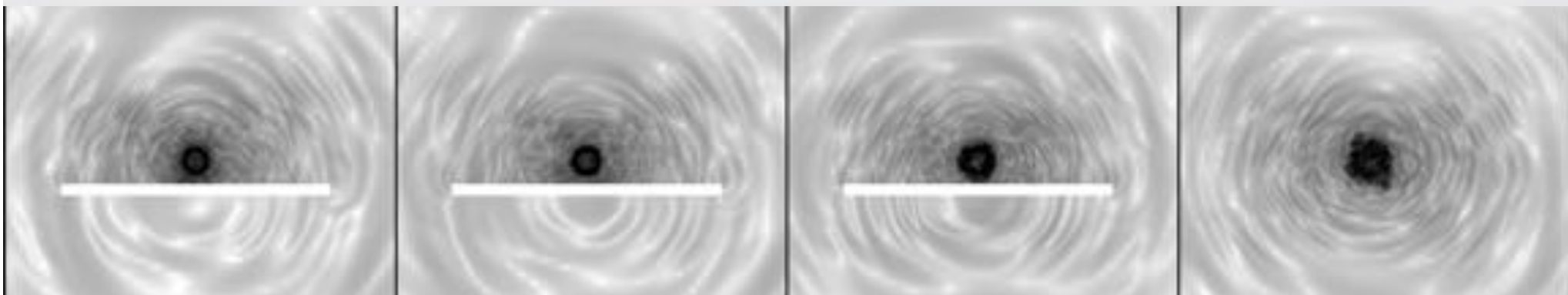

Near-Field Comparisons

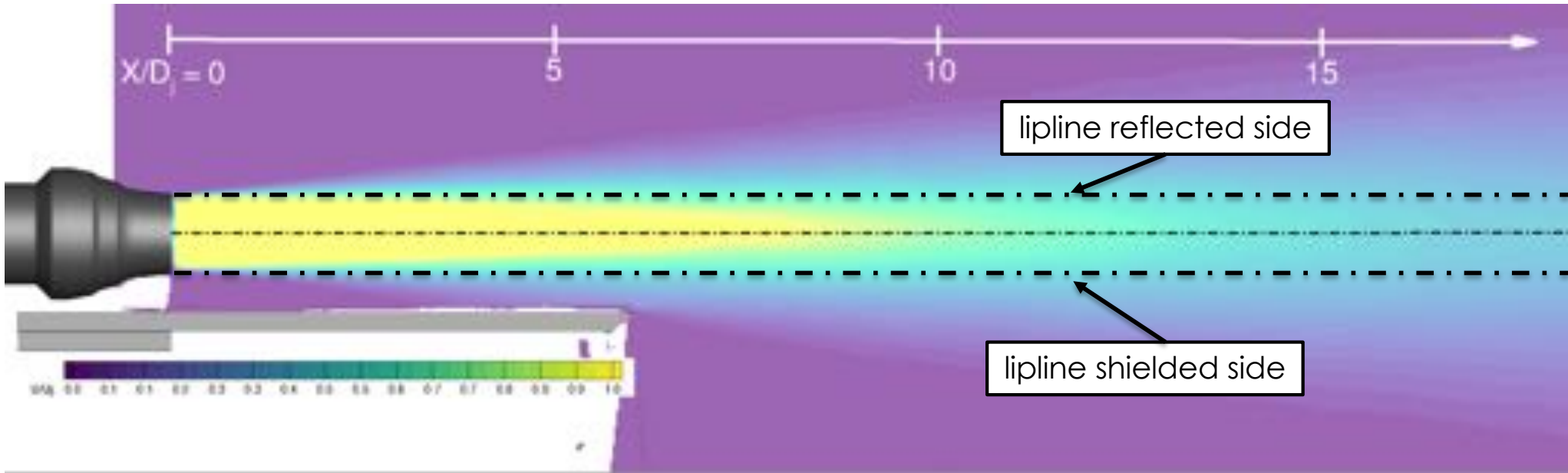

(a) PIV measurements from Experiment

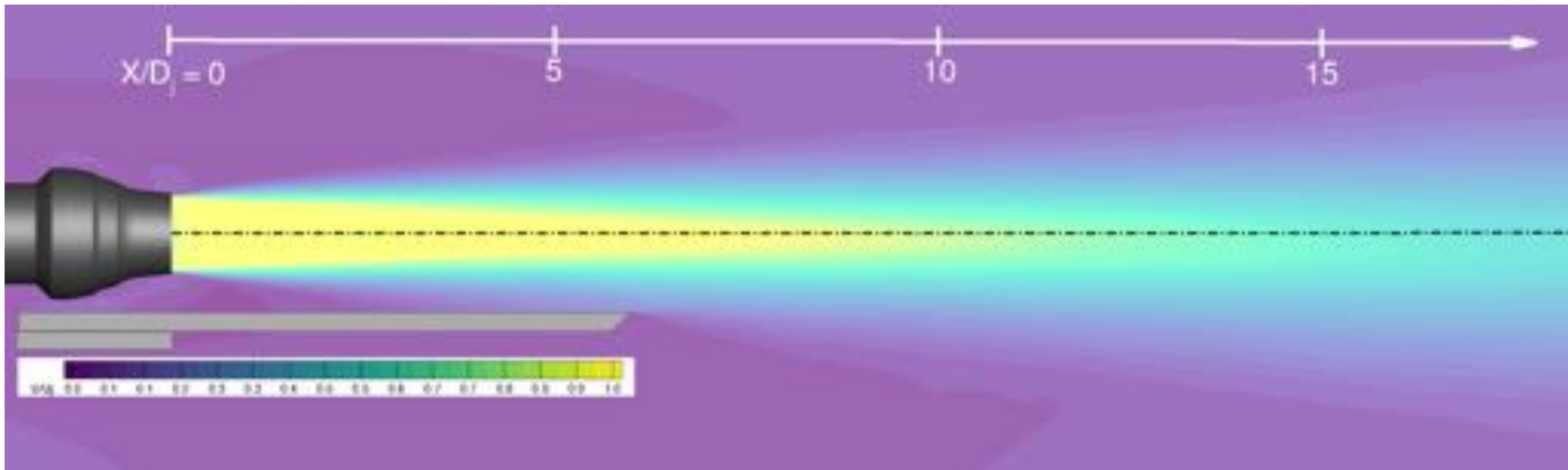

(b) Contour plot from CFD

Near-Field

Time-Averaged Axial Velocity and Turbulent Kinetic Energy

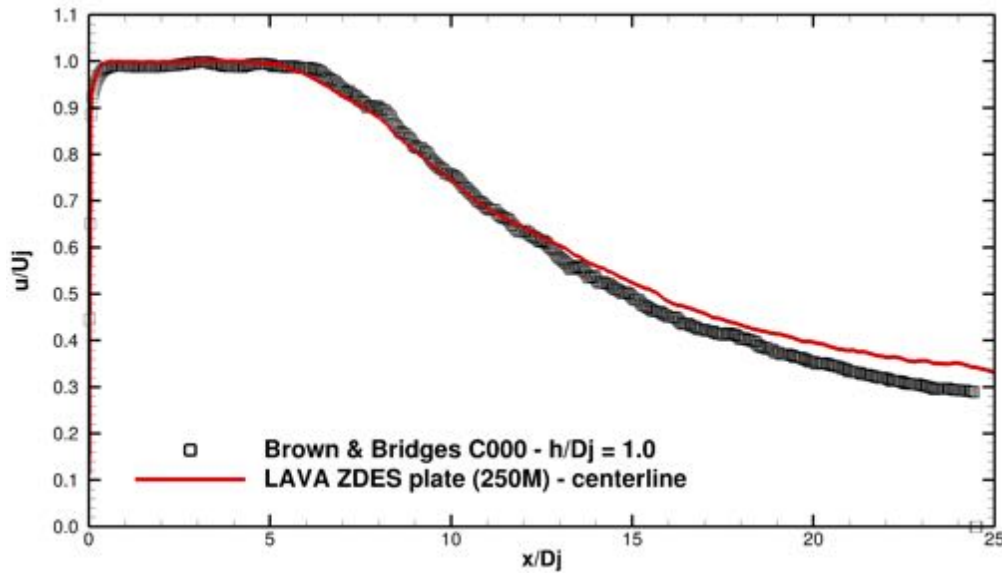

(a1) Centerline Velocity

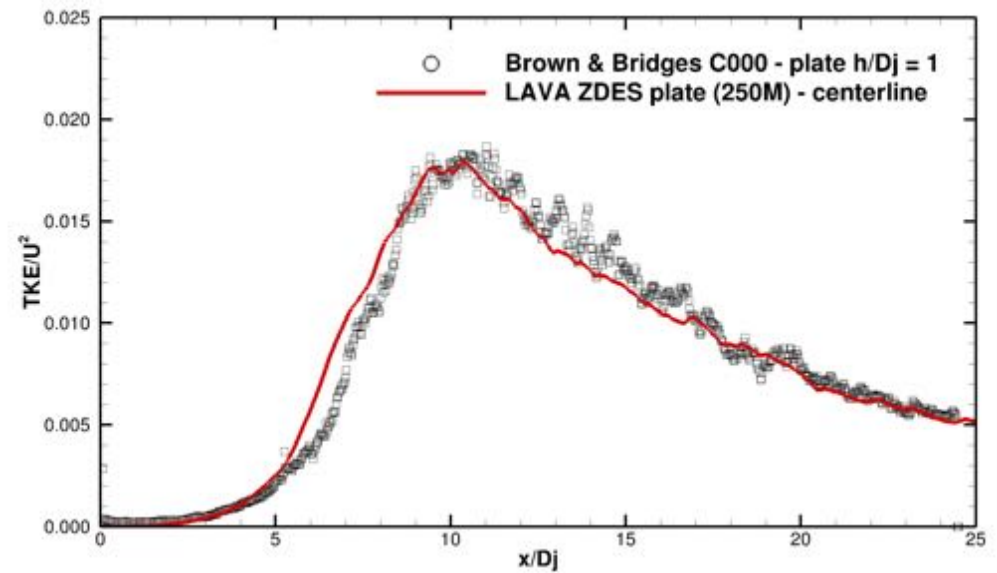

(a2) Centerline TKE

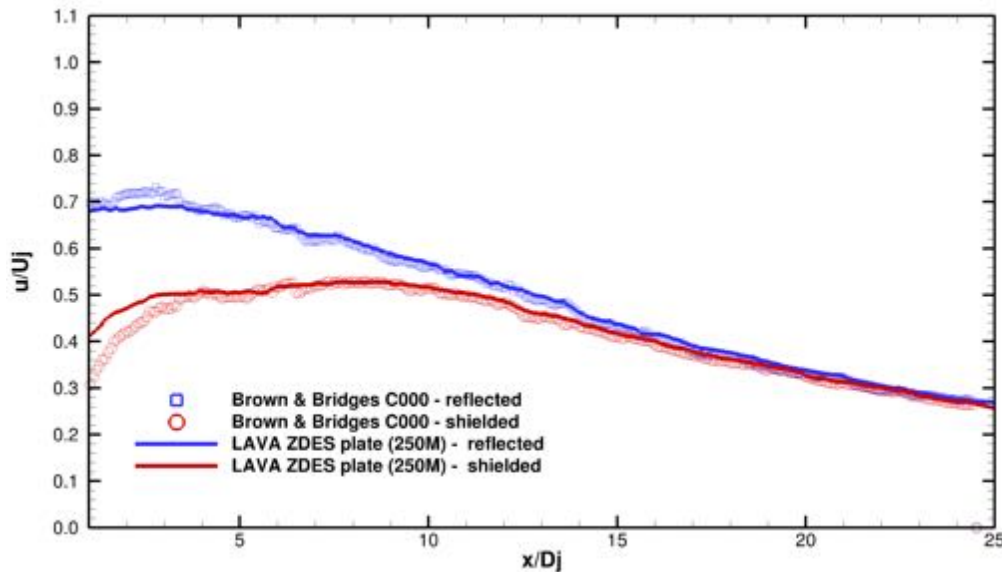

(a1) Lipline Velocity

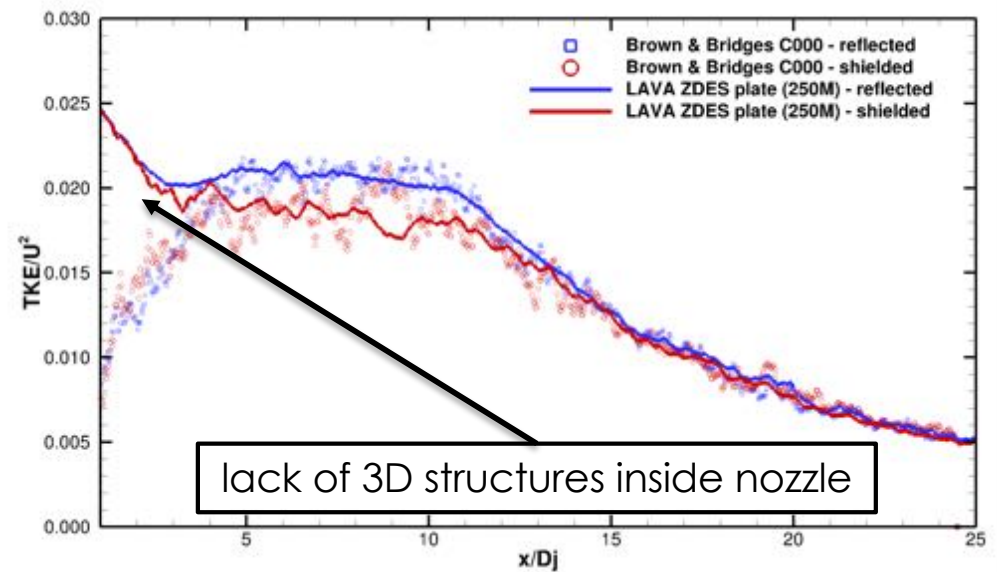

(a2) Lipline TKE

Far-Field – FWH Surface Definition

Tight FWH Surface



- Best practice guidelines established for isolated round-jet do not apply directly on case with enclosed surface (non-symmetric)
- Inclusion of all necessary sources important to predict noise spectra correct

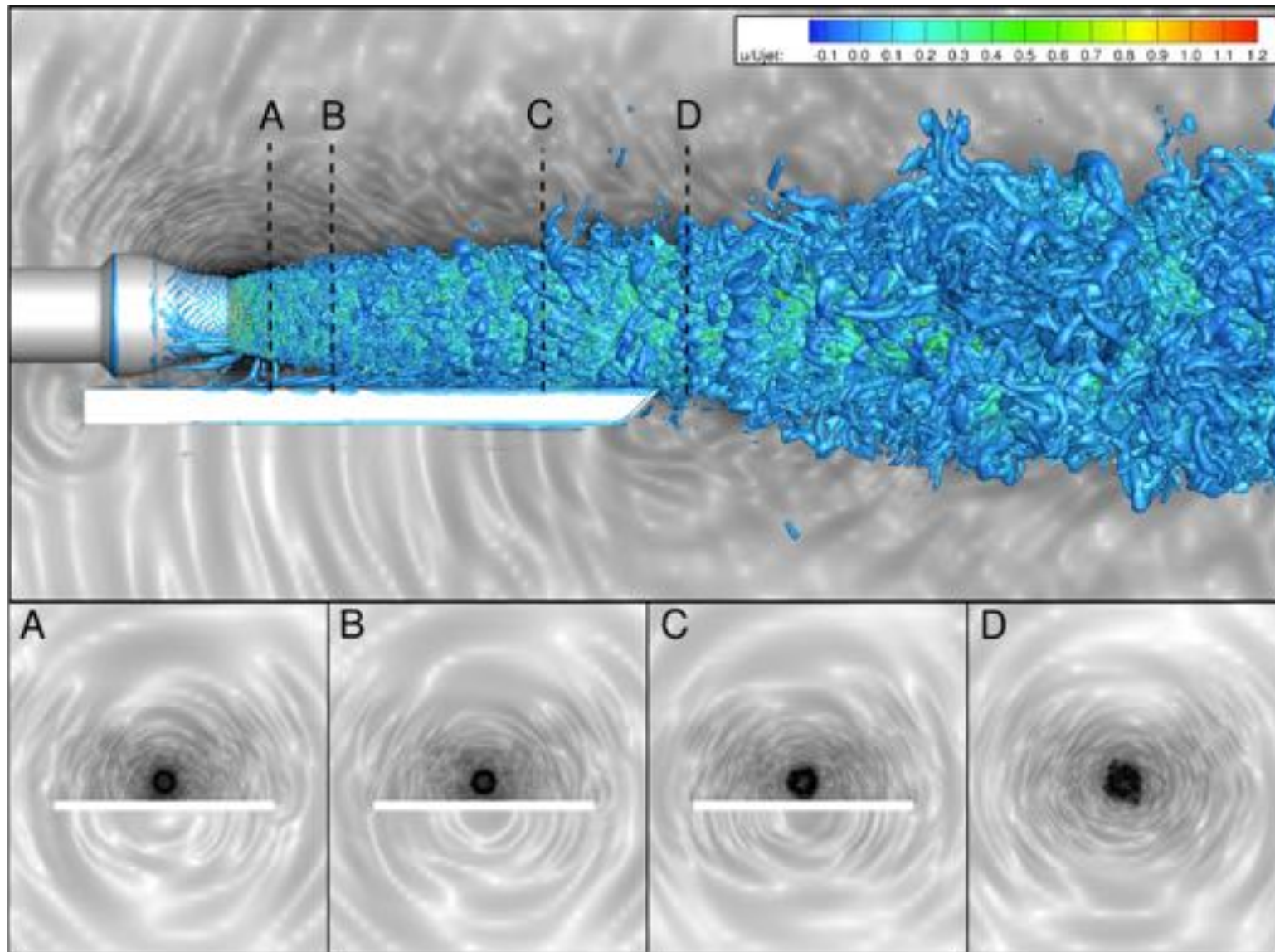

Far-Field – FWH Surface Definition

Tight FWH Surface



- 1000 convective time units
- 25 FWH segments $St_{bin}=0.02$

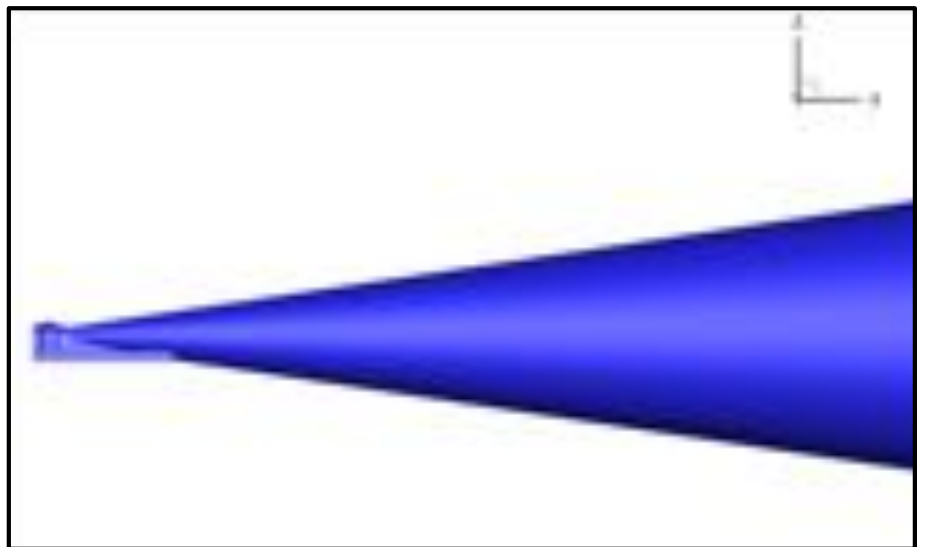
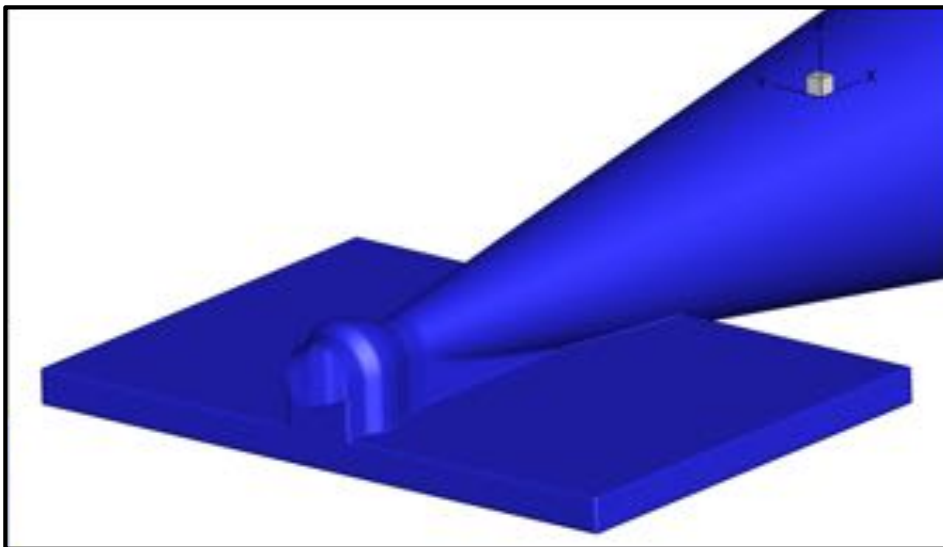
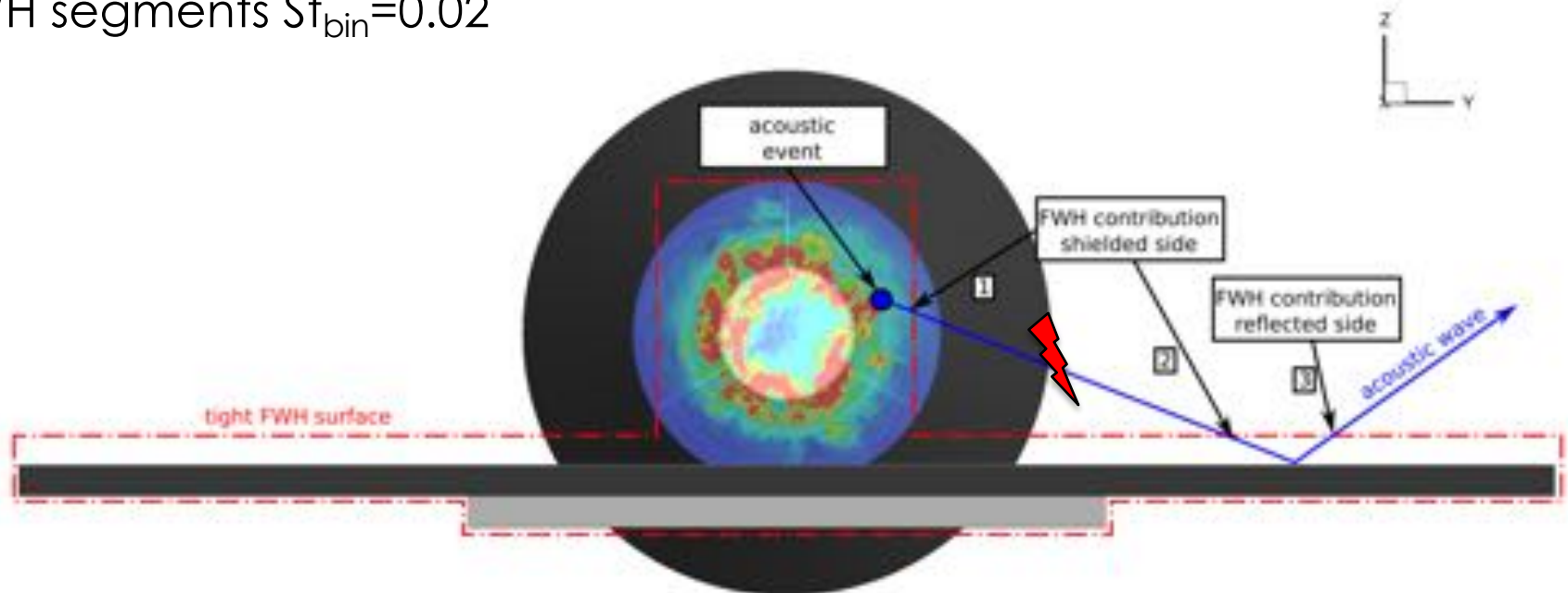

Far-Field – Tight FWH Surface



Comparison of PSD Spectrum 100D away from nozzle exit

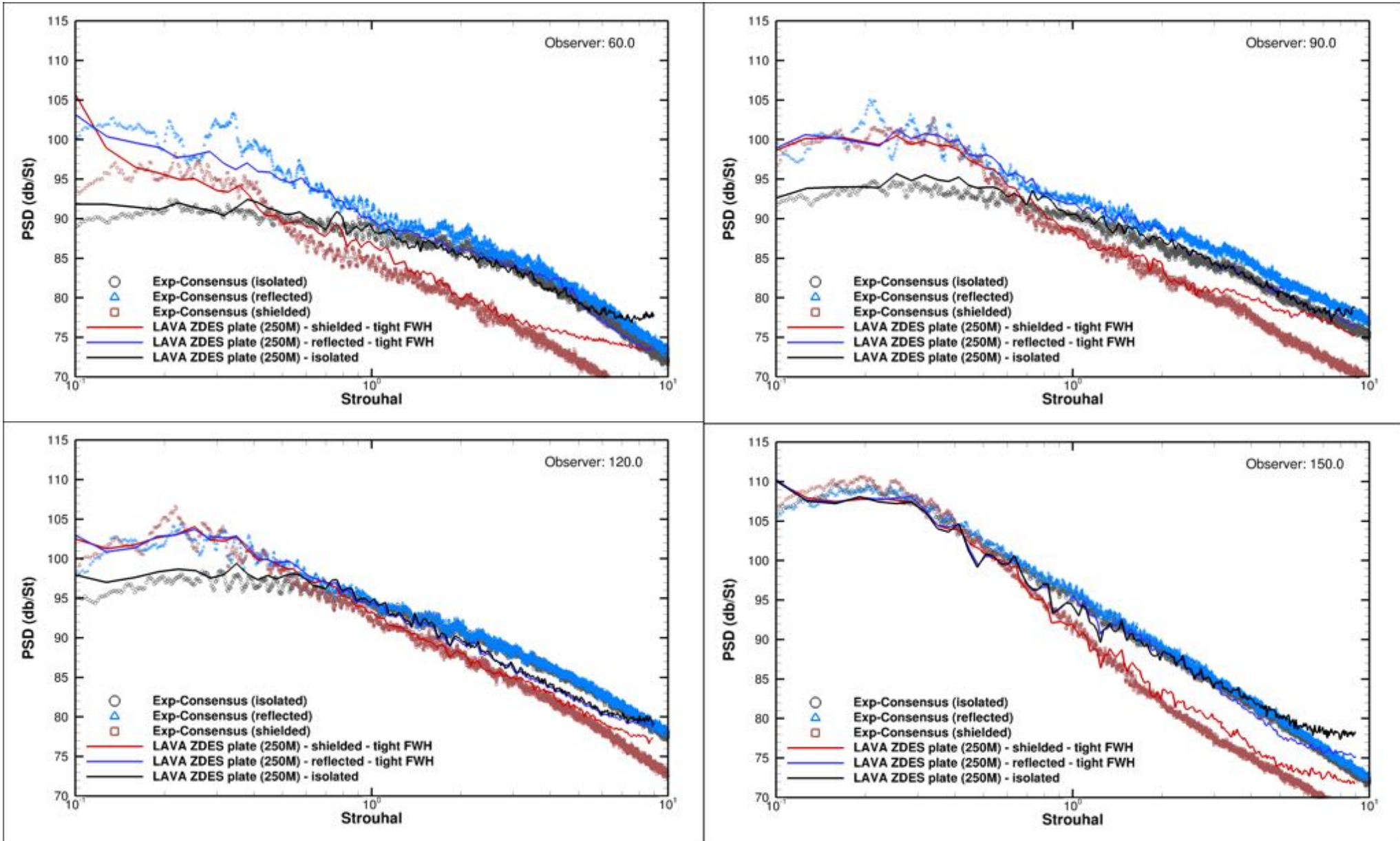

- Excellent agreement with measurements, split captured accurately.
- Resolution in plate region not sufficient for high-frequencies.

Far-Field – FWH Surface Definition

Loose FWH Surface



- 1000 convective time units
- 25 FWH segments $St_{bin}=0.02$

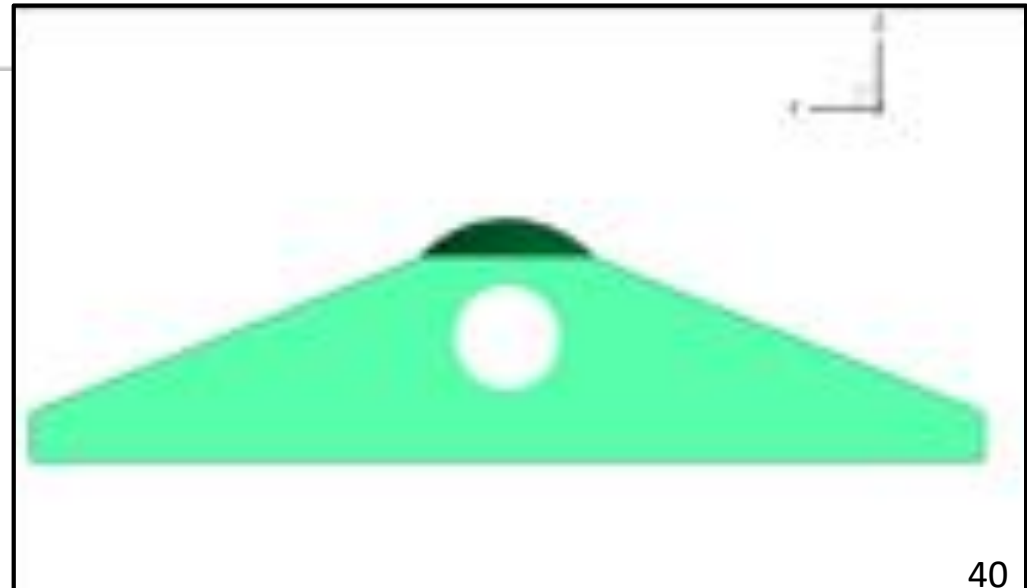
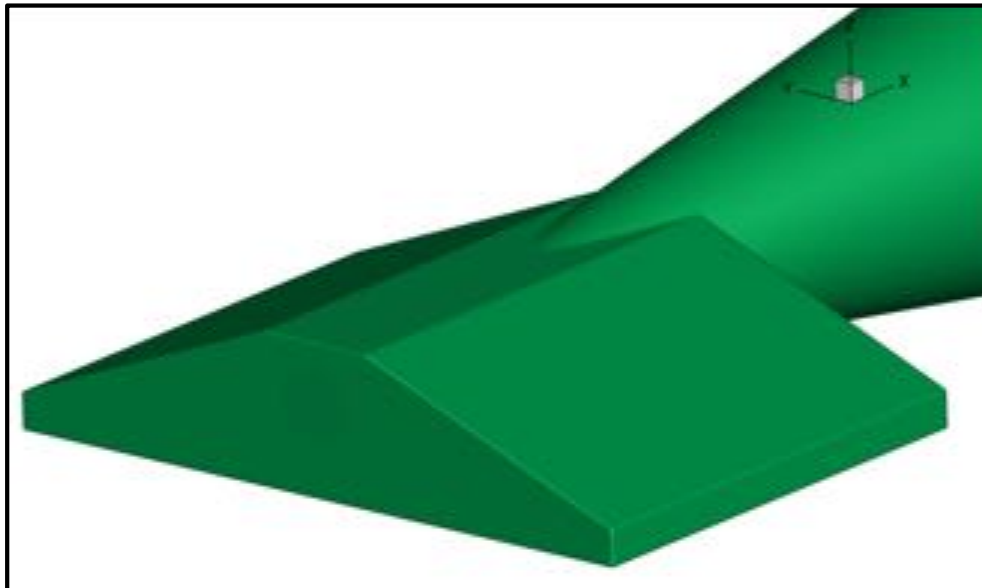
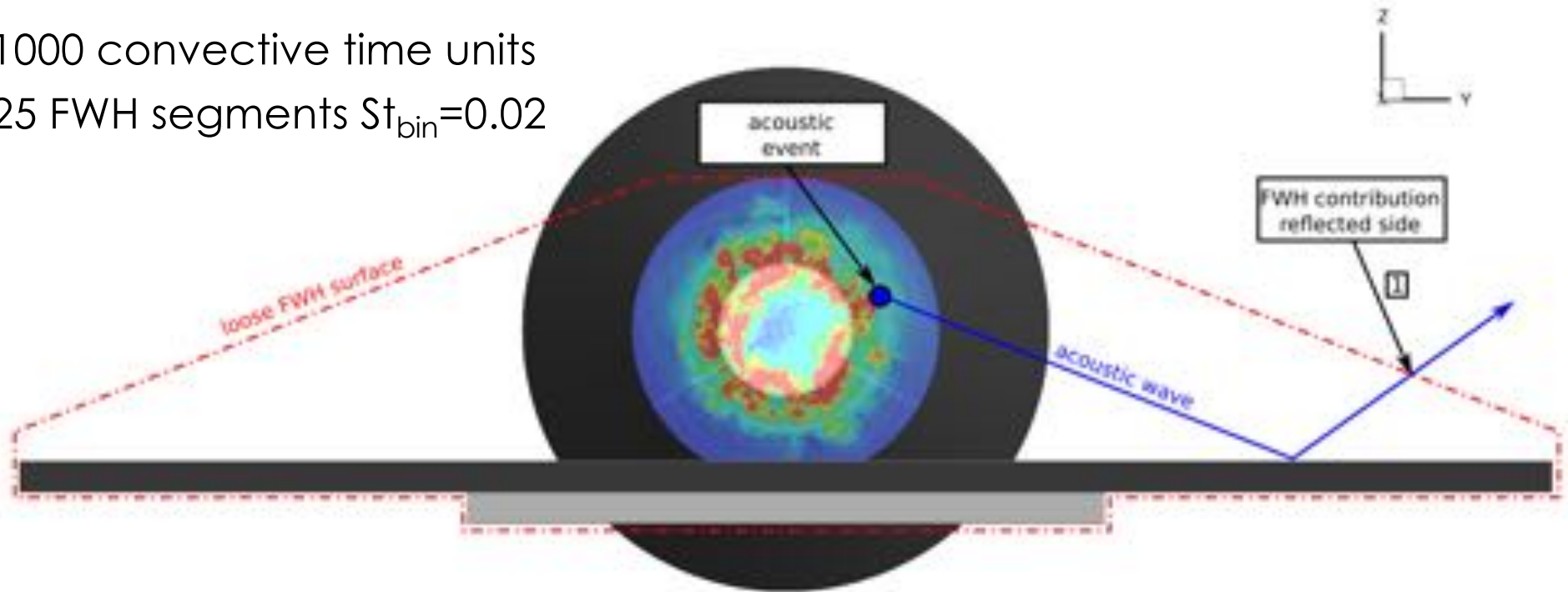

Far-Field – Tight FWH Surface



Comparison of PSD Spectrum 100D away from nozzle exit

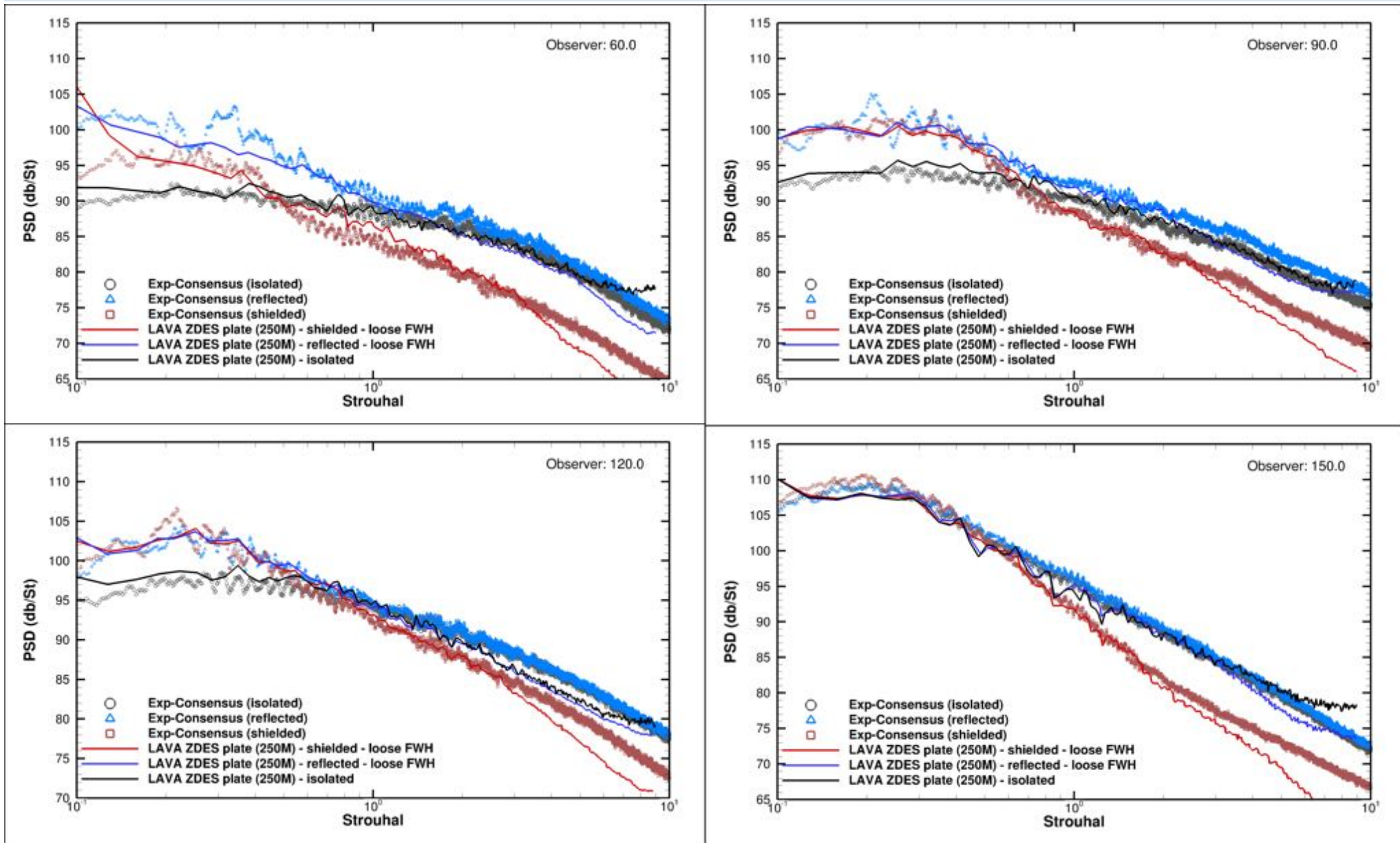

- Excellent agreement with measurements, split captured accurately.
- Resolution in plate region not sufficient for high-frequencies.

Geometry and Setup

Computational Mesh Jet Shielding Plate

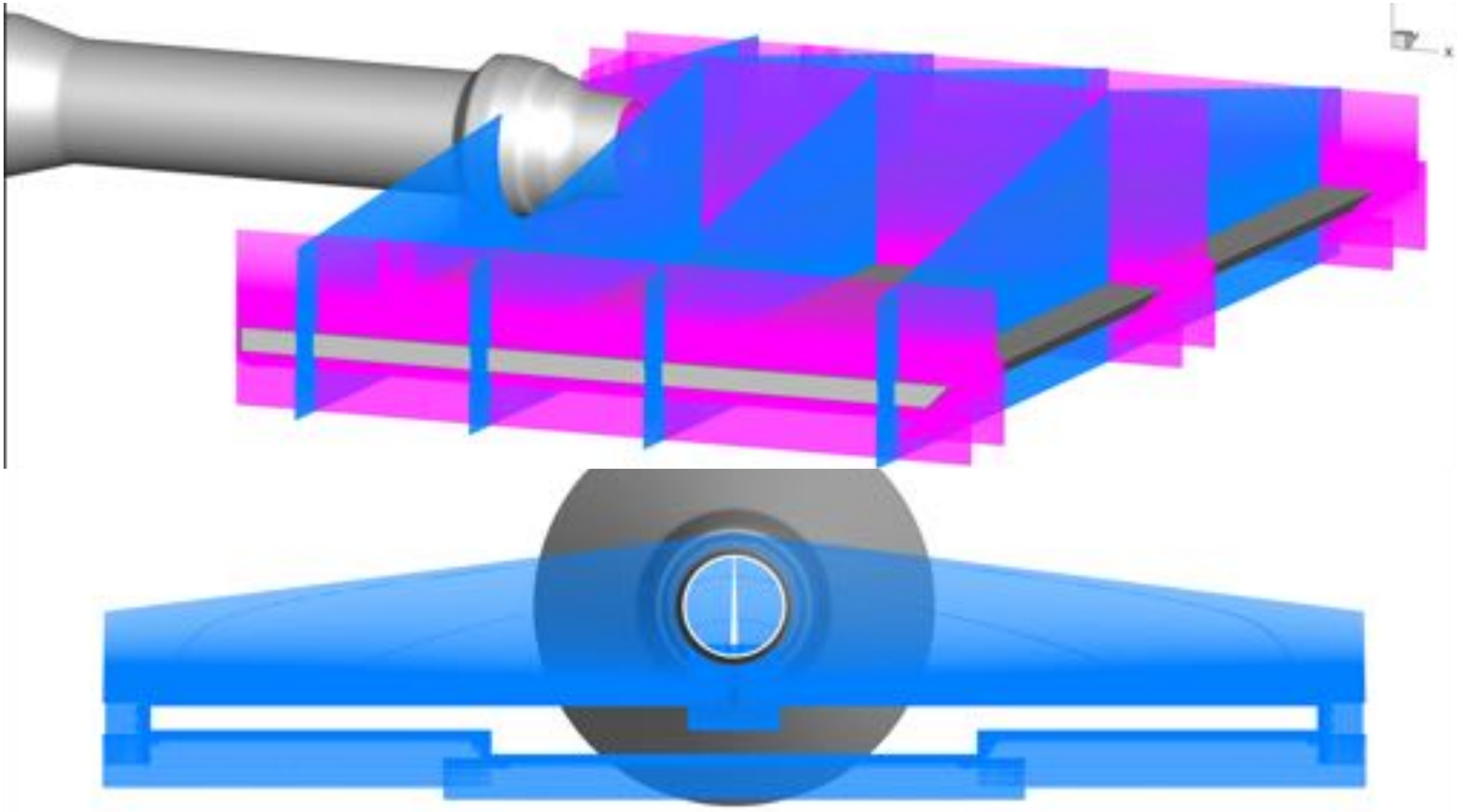

- Mesh surrounding jet shielding plate consists of 130M grid points (combined with medium isolated mesh 230M)

Future Work

Progress towards the "Grand-Challenge"





Round Jet with chevron nozzle SMC001

- Completed structured curvilinear mesh for complex chevron nozzle design.

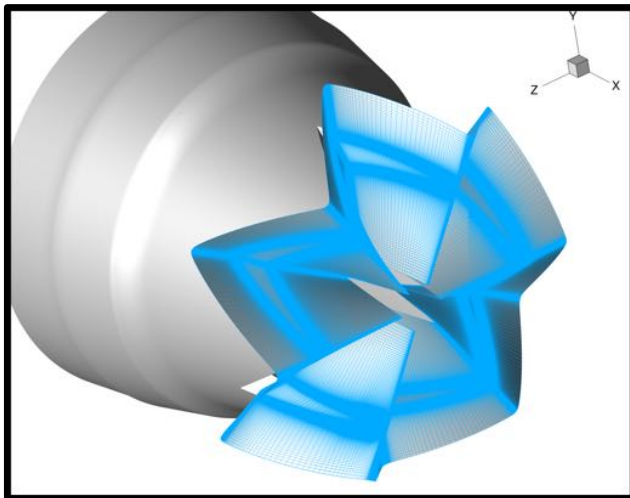
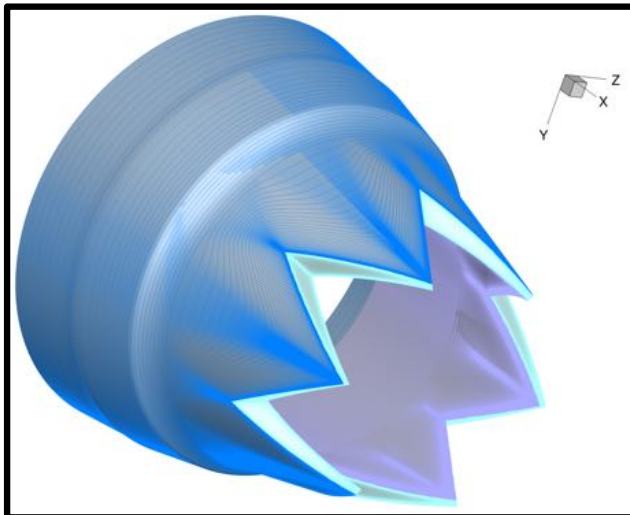

Uzun et al. 2012

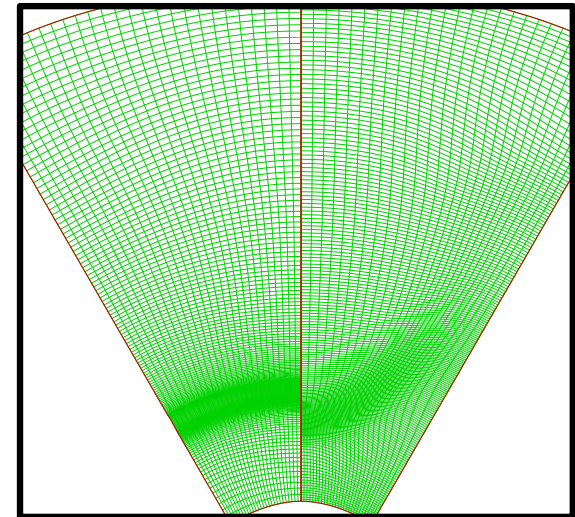
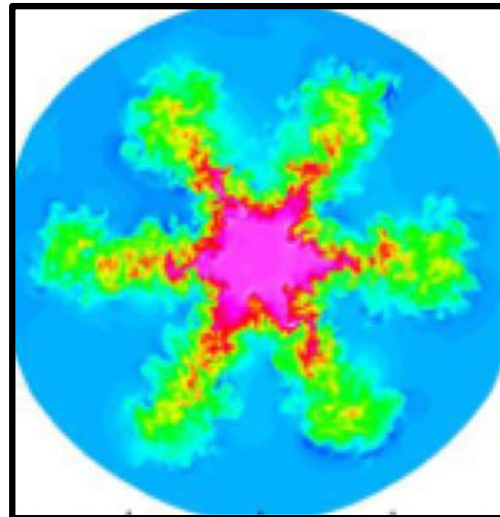

- Automated mesh refinement/ redistribution to track flow features of chevron nozzle (see Uzun et.al. 2012)

Future Work

Progress towards the "Grand-Challenge"



Combination of isolated problems into one nozzle TMP17 (Multi-stream, Plug, Chevron, Shielding)

- Surface meshing for TMP17 almost completed

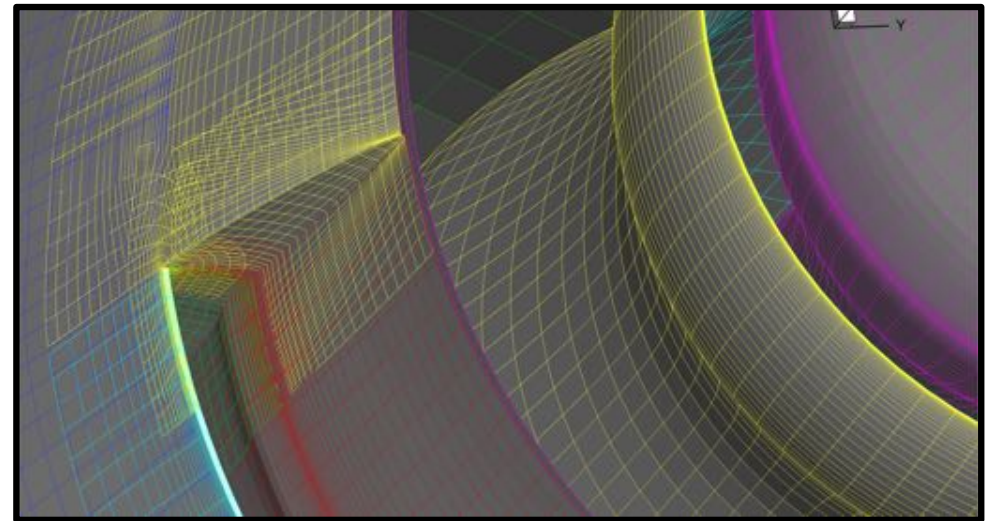
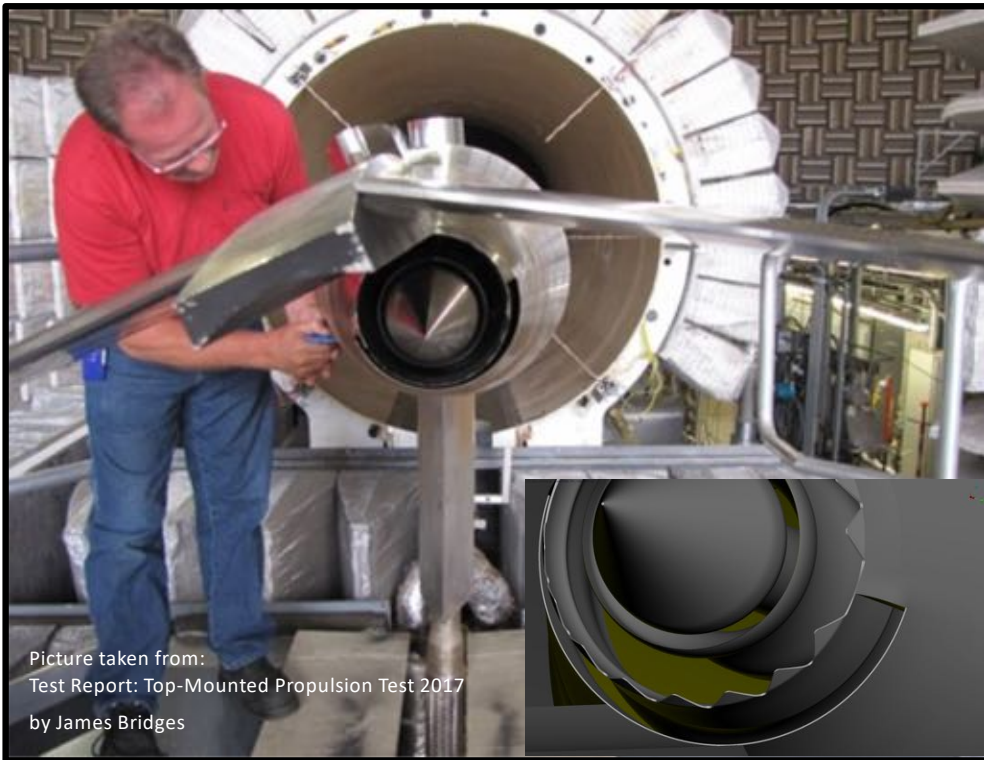

Summary



- Hybrid RANS/LES within the LAVA framework using structured curvilinear overlapping grids is successfully applied to predict jet noise.
- Good comparison with experiments for both near-field and far-field achieved for round-jet as well as surface interaction noise case.
- Completed far-field acoustic propagation
 - Mach wave radiation noise in the jet direction is well-captured
 - Strong influence on utilized SEM investigated, further improvements necessary (tripping, quiter inflow)
- BL needs to be resolved better inside of nozzle for further improvements.

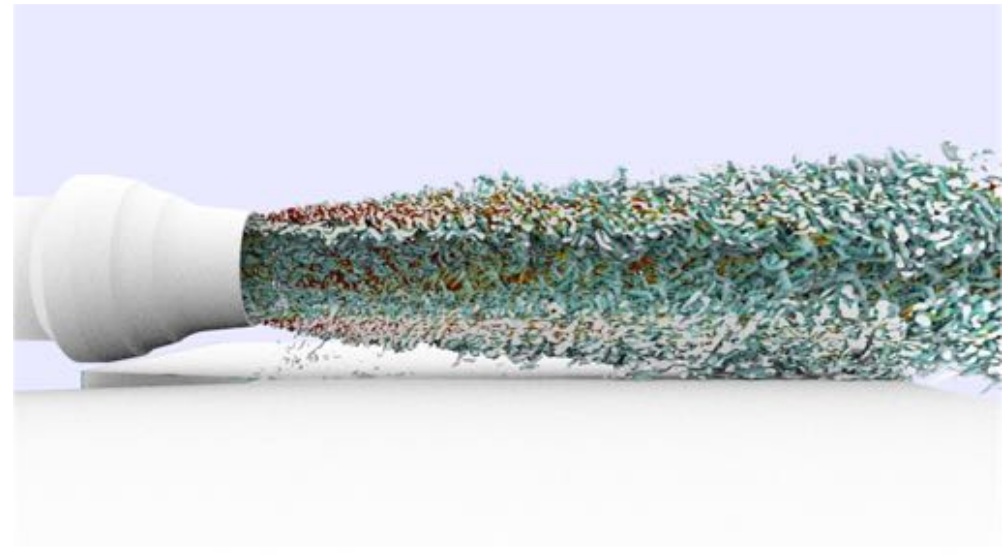

Acknowledgments



- This work was partially funded by the Commercial Supersonics Technology (CST) project and the Transformational Tools and Technology (T³) project under the Aeronautics Research Mission Directorate (ARMD).
- Computer time has been provided by the NASA Advanced Supercomputing (NAS) facility at NASA Ames Research Center.
- Timothy Sandstrom from NASA Ames visualization team for particle flow visualizations.
- Team members of LAVA group for helpful discussions and advice

Questions?

