

An Introduction to Global Navigation Satellite Systems

Ben Ashman

Navigation and Mission Design Branch

Goddard Space Flight Center, Greenbelt, MD

Introduction to Satellite Based Navigation

Navigation

- Navigation is the process of determining position and direction
- Generalization of the problem: estimate unknown parameters based on related observations

$$\mathbf{z} = \mathbf{h}(\boldsymbol{\theta}) + \mathbf{v}$$

$\boldsymbol{\theta}$ = parameter vector (e.g., Cartesian position and velocity, our “state”)

\mathbf{Z} = observation vector (i.e., set of measurements)

\mathbf{V} = observation noise vector (i.e., measurement error)

$\mathbf{h}(\cdot)$ = relation between parameter set and observation set (i.e., measurement model)

- Given a parameter set, we seek an observation set, a relation between our parameters and observations, and an estimator $\hat{\boldsymbol{\theta}}(\cdot)$, in order to form an estimate: $\hat{\boldsymbol{\theta}} = \hat{\boldsymbol{\theta}}(\mathbf{z})$
- Elegant and effective solutions have been devised by humans and other species for millennia

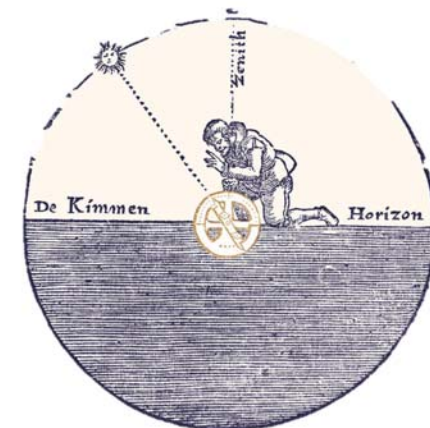
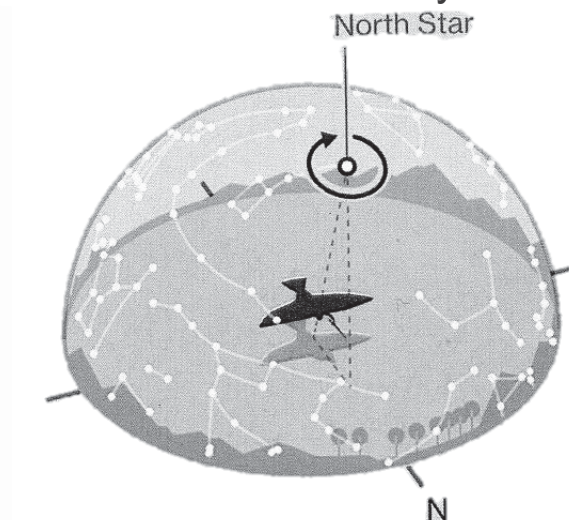
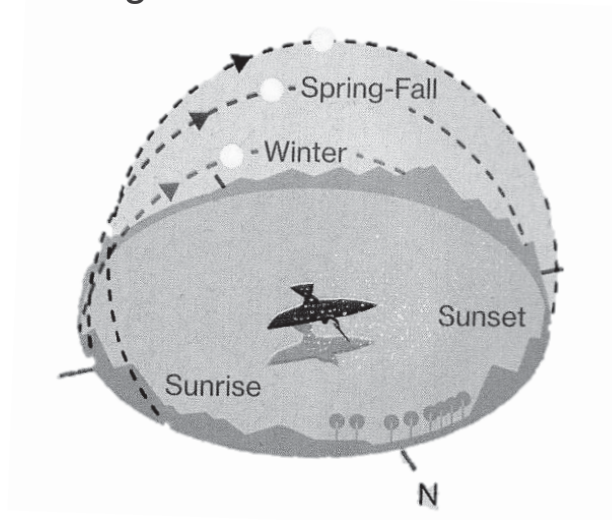

From left: day and night bird migration [20], astrolabe 1619 [21]

Navigation (continued)

- **Relative navigation**

Dead reckoning: monitor rate of travel and heading using a compass; prone to error, especially at sea

Landmark bearings: angles to two known landmarks will constrain position in two dimensions

- **Absolute navigation: latitude and longitude (clocks vs. celestial)**

Latitude: Measure the elevation of pole star above the horizon with a sextant or astrolabe

Longitude: Very good clock or celestial (sextant for the elevation of celestial bodies above the horizon, accurate clock to determine the time of observations, almanac to find the predicted position of the body, magnetic compass to determine azimuth and maintain course continuity between celestial observations)

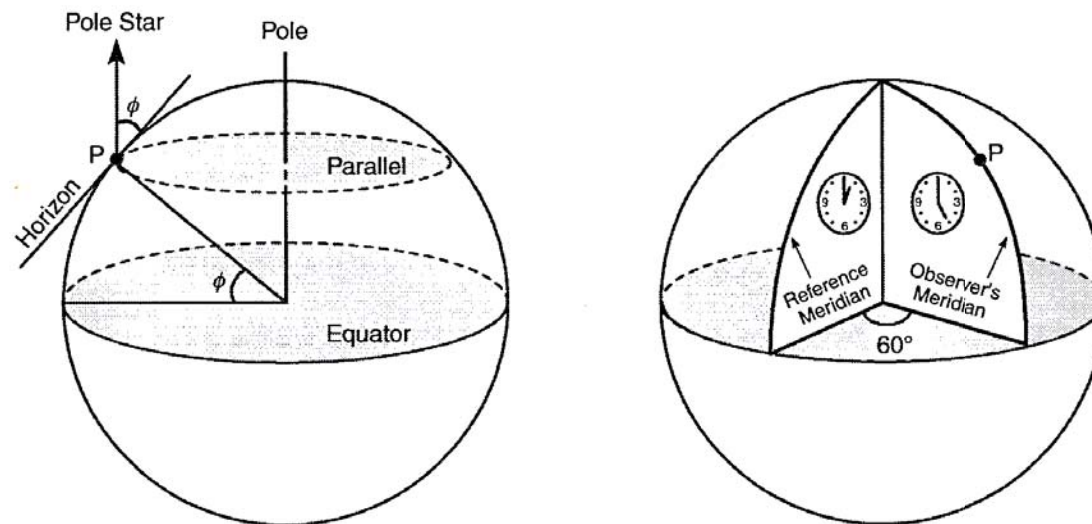

Latitude (left) and longitude (right) [1]

Radionavigation

- Measurements: *distances* from known transmitter locations via the measurement of radio frequency signal transit time
- Solution to the estimation problem: *trilateration*, the determination of absolute or relative locations of points by measurement of distances using the geometry of circles, spheres, or triangles
- Ground based:
LORAN (1940s), Omega (1960s)
- Satellite-based:
Sputnik I (1957), Parus and Tskikada, Transit, MOSAIC, and SECOR (1960s)

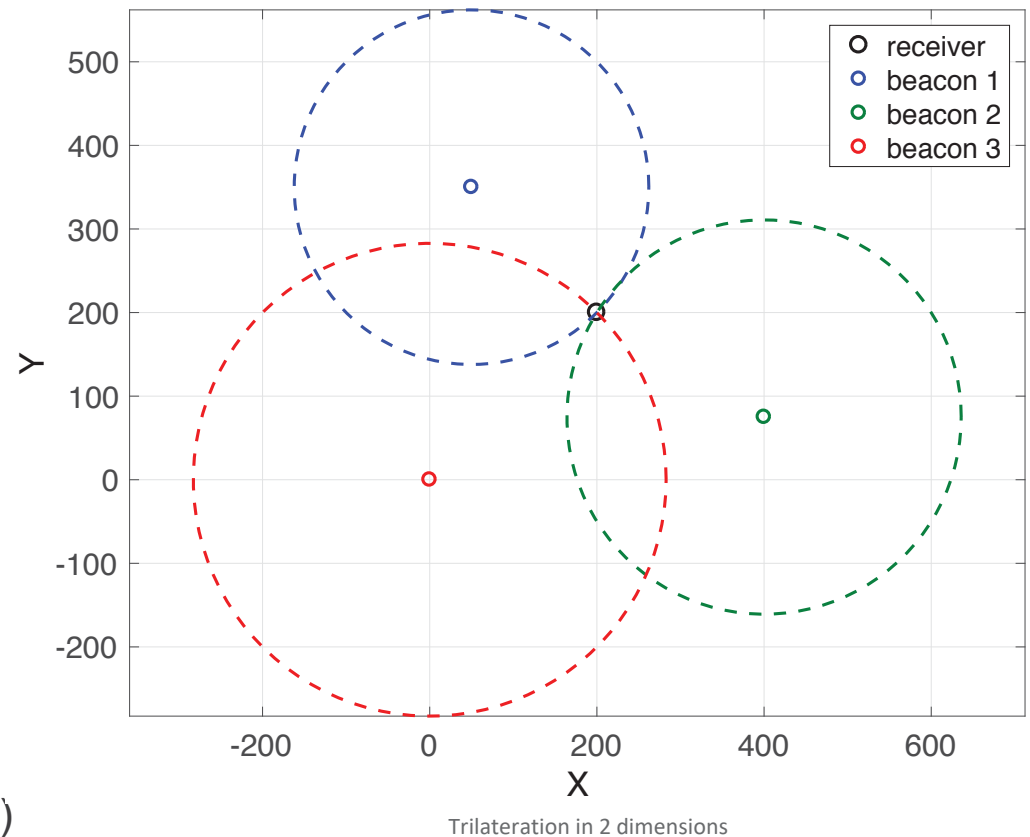

GNSS

- Global Navigation Satellite Systems (GNSS): radionavigation perfected
- Features

Accuracy: 3D accuracies of a few meters and down to millimeters for users with specialized equipment and processing

Availability: signal availability anywhere on Earth with a clear view of the sky

Integrity: the assurance that expected performance will be realized

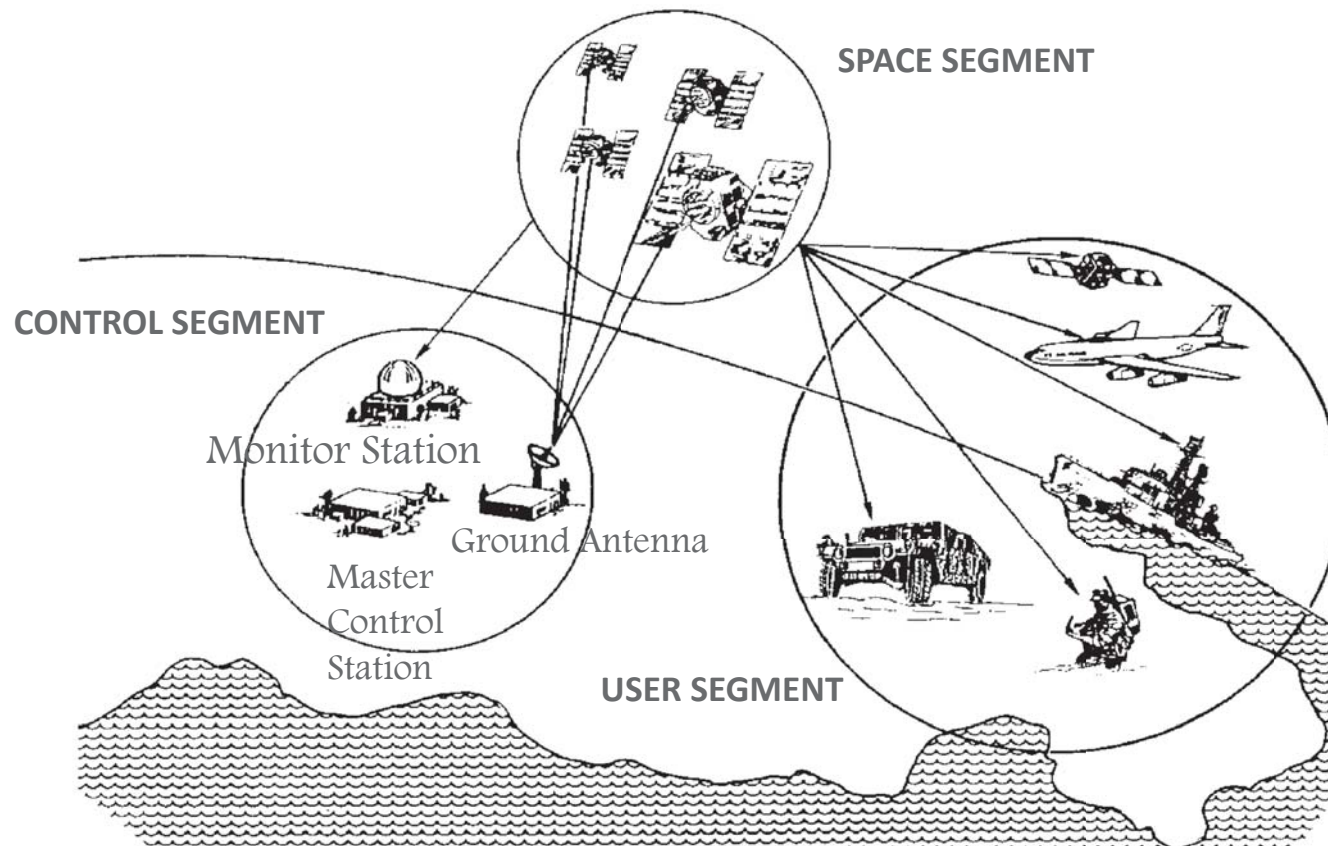

GNSS (continued)

- Space segment

Constellation of satellites in near-circular, Medium Earth Orbits (~20,000 km) or Geosynchronous Earth Orbits (~36,000 km), each satellite equipped with atomic clocks

- Control segment

Network of ground stations and antennas that perform monitoring of the constellation, check for anomalies, generate new orbit and clock predictions, build and send upload to spacecraft

- User segment

GNSS receivers—specialized radios that track GNSS signals and produce position and velocity solutions, typically with low-cost clocks

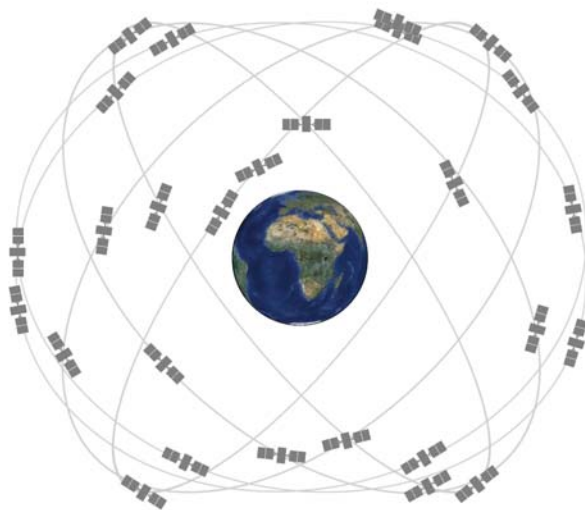

GPS Space Segment [4]

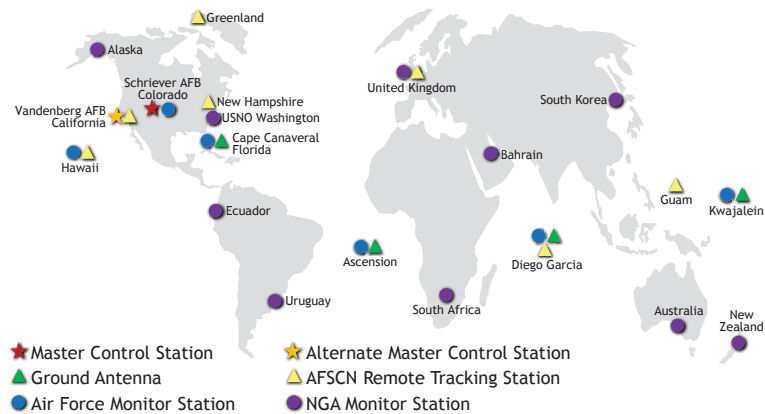

GPS Control Segment [5]



GPS Receivers [6]

GNSS constellations

- GNSS is an umbrella term for satellite constellations that broadcast signals from space for radionavigation



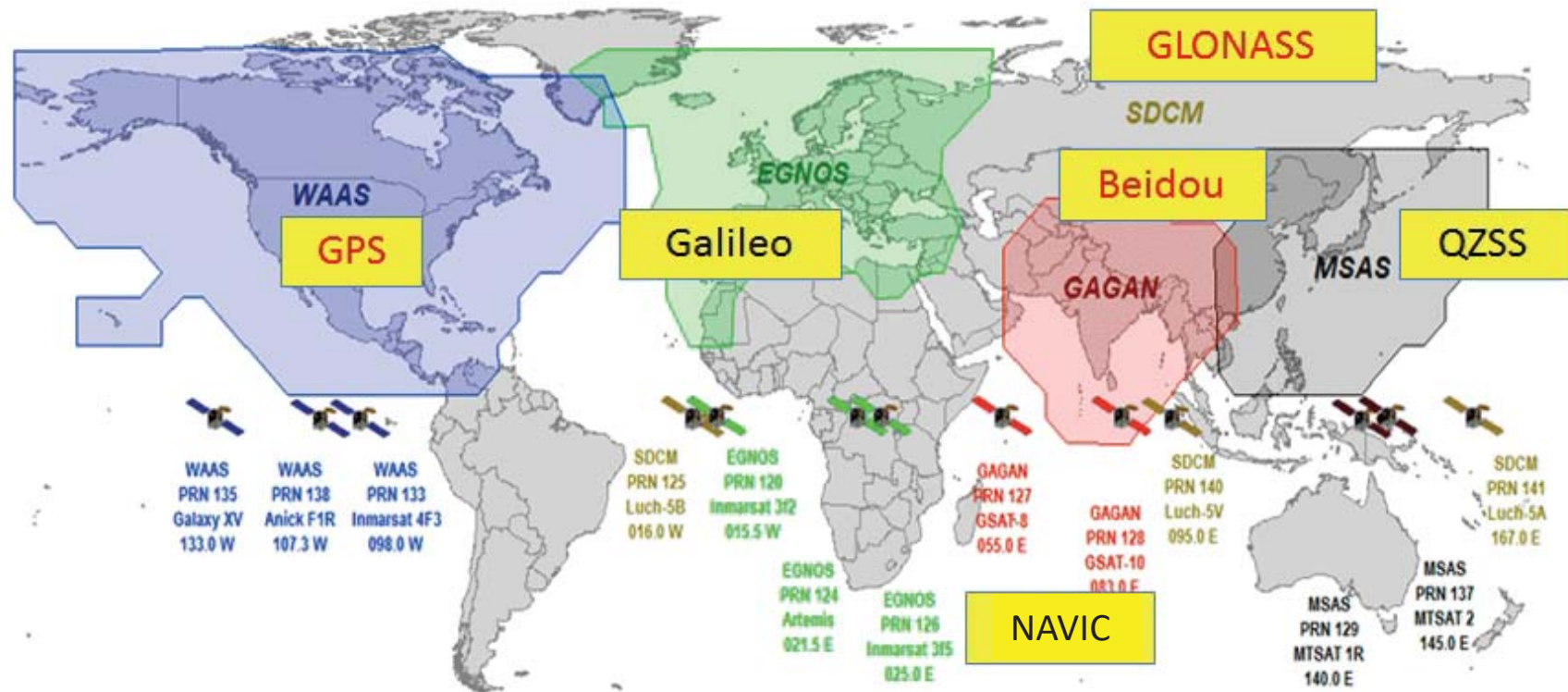

Systems with global coverage: GPS (United States), Galileo (European Union), GLONASS (Russia), BeiDou (China)

Systems with regional coverage: NAVIC (India), QZSS (Japan)

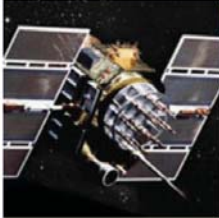

GNSS constellations, augmentations, and regional constellations [7]

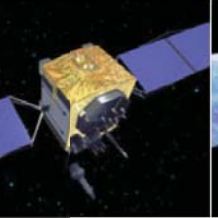
GPS modernization: space segment status

LEGACY SATELLITES		MODERNIZED SATELLITES		
				
BLOCK IIA	BLOCK IIR	BLOCK IIR-M	BLOCK IIF	GPS III/IIIF
1 operational	11 operational	7 operational	12 operational	1 in checkout
<ul style="list-style-type: none"> Coarse Acquisition (C/A) code on L1 frequency for civil users Precise P(Y) code on L1 & L2 frequencies for military users 7.5-year design lifespan Launched in 1990-1997 	<ul style="list-style-type: none"> C/A code on L1 P(Y) code on L1 & L2 On-board clock monitoring 7.5-year design lifespan Launched in 1997-2004 <p>LEARN MORE ABOUT GPS IIR AT AF.MIL →</p>	<ul style="list-style-type: none"> All legacy signals 2nd civil signal on L2 (L2C) LEARN MORE → New military M code signals for enhanced jam resistance Flexible power levels for military signals 7.5-year design lifespan Launched in 2005-2009 <p>LEARN MORE ABOUT GPS IIR-M AT AF.MIL →</p>	<ul style="list-style-type: none"> All Block IIR-M signals 3rd civil signal on L5 frequency (L5) LEARN MORE → Advanced atomic clocks Improved accuracy, signal strength, and quality 12-year design lifespan Launched in 2010-2016 <p>LEARN MORE ABOUT GPS IIF AT AF.MIL →</p>	<ul style="list-style-type: none"> All Block IIF signals 4th civil signal on L1 (L1C) LEARN MORE → Enhanced signal reliability, accuracy, and integrity No Selective Availability LEARN MORE → 15-year design lifespan IIIF: laser reflectors; search & rescue payload First launch in 2018 <p>LEARN MORE ABOUT GPS III AT AF.MIL →</p>

As of April 24, 2019, there were a total of 31 operational satellites in the GPS constellation

<https://www.gps.gov/systems/gps/space/#generations>

GNSS Fundamentals

GPS signal structure

- What is required of a radionavigation signal?
 1. Propagation delay between transmitter and receiver can be measured
 2. Transmitters can be distinguished, enabling geometric diversity
 3. Modulation allowing the signal to propagate through space
- For any signal $p(t)$ combined with Additive White Gaussian Noise (AWGN) $n(t)$,

$$p(t) + n(t)$$

correlation with a copy of $p(t)$ maximizes the output signal to noise ratio (SNR) (i.e., optimal estimator in the Maximum Likelihood sense), so $p(t)$ is designed to have a correlation shape that satisfies signal requirements 1 and 2

- Delay estimation

Consider a known, continuous-time signal $p(t)$ generated at the transmitter that arrives at the receiver with some delay τ :

$$p(t - \tau)$$

In order to estimate τ , a local replica of $p(t)$ is formed at the receiver with test delay $\tilde{\tau}$.

The delay estimate, $\hat{\tau}$, is the test delay that maximizes the average (over T_I) of the inner product:

$$\hat{\tau} = \arg \max_{\tilde{\tau}} \frac{1}{T_I} \int_{t-T_I}^t p(\alpha - \tilde{\tau}) p(\alpha - \tau) d\alpha$$

GPS signal structure: code

- Autocorrelation in terms of alignment error, $\epsilon = \tilde{\tau} - \tau$:

$$R(\epsilon) = \frac{1}{T_I} \int_{t-T_I}^t p(\alpha - \tilde{\tau})p(\alpha - \tau)d\alpha$$

The ideal autocorrelation function would be

$$R(\epsilon) = \begin{cases} 1 & \text{for } \epsilon = 0 \\ 0 & \text{elsewhere} \end{cases}$$

- Multiple signals are required in order to form a position estimate, however. The trilateration problem relies on geometric diversity. One means of distinguishing transmitters is to minimize the cross correlation of signals from different transmitters:

$$R_x(\tau) = \frac{1}{T_I} \int_{t-T_I}^t p^i(\alpha)p^j(\alpha - \tau)d\alpha \qquad R_x(\epsilon) = 0 \quad \forall \epsilon$$

- These auto- and cross-correlation properties could be achieved with infinitely long random sequences of +1 and -1, known at the transmitter and receiver, and unique to each transmitter

GPS signal structure: code

- This is accomplished using **Pseudorandom Noise (PRN) codes**

Must be deterministic and finite for practical implementation, but sufficiently long and noise-like to approximate the desired autocorrelation and cross-correlation properties

- GPS Coarse Acquisition Code (C/A code) solution: Gold codes (modulo-2 sum of two linear feedback shift registers)

Periodic sequence of $\{+1, -1\}$ pulses called chips, unique to each GPS satellite, length 1023 with period of 1 ms (i.e., $f_{\text{chip}} = 1.023 \text{ MHz}$)

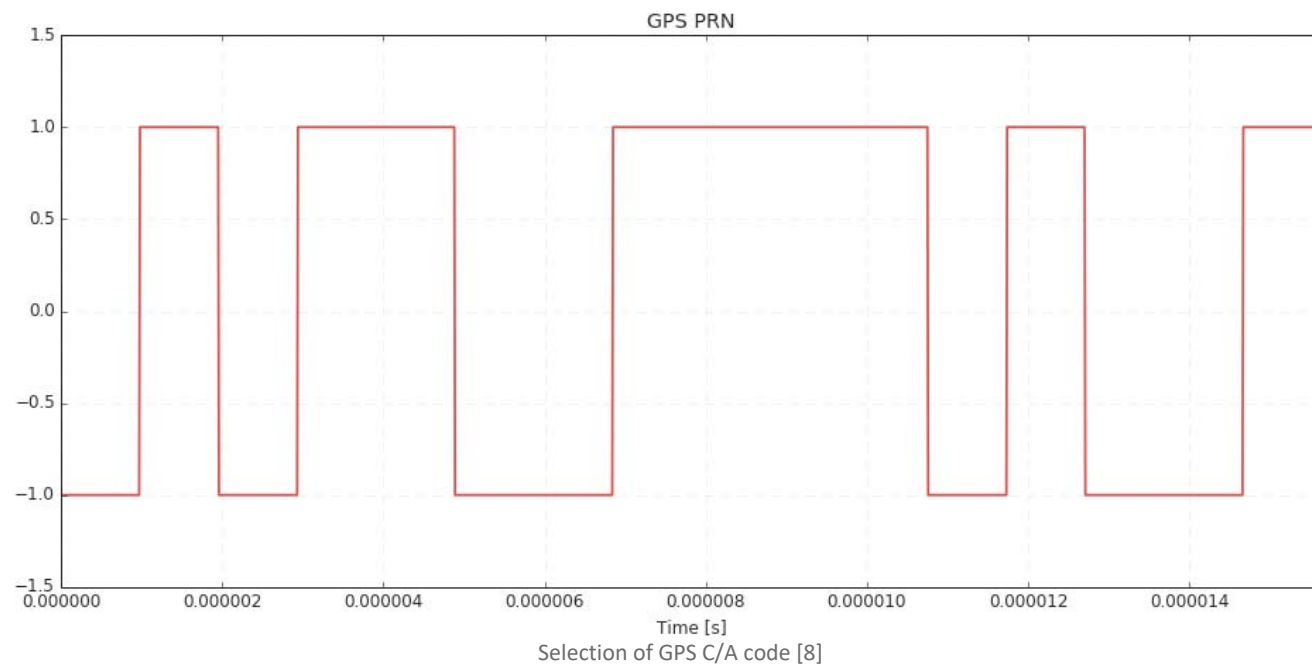

GPS signal structure: carrier

- Third navigation signal requirement: modulation allowing the signal to propagate through space

$$p(t) \cos(2\pi f_{carr}t)$$

- Radio frequencies used for satellite navigation—must penetrate atmosphere
- Apparent frequency at the receiver is Doppler shifted due to the relative motion of the transmitter and receiver

$$p(t - \tau(t)) \cos(2\pi f_{carr}(t - \tau(t)))$$

$$p(t - \tau(t)) \cos(2\pi(f_{carr} + f_D)t - \theta(t_0))$$

where $\tau(t) = \dot{\tau}t + \tau(t_0)$ and $f_D = -\dot{\tau}t = -\dot{r}(t)f_{carr}/c$

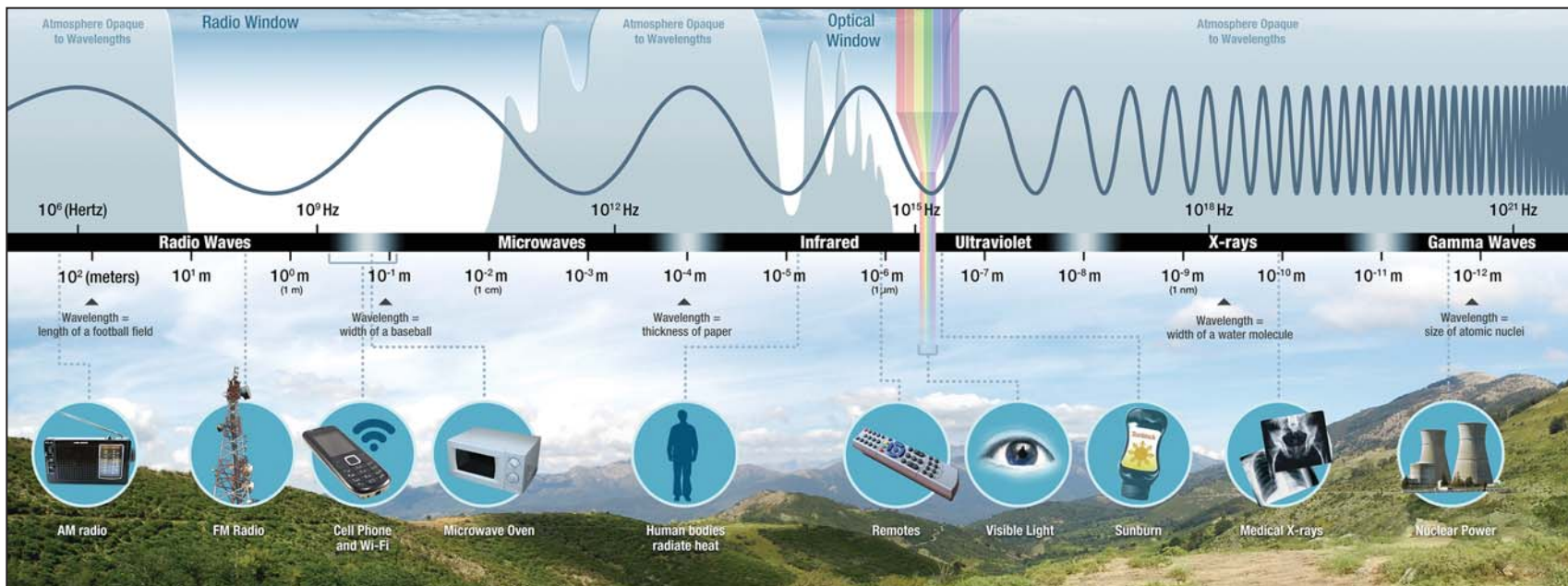

EM spectrum [9]

GPS signal structure (continued)

- Finally, signal is also modulated with 12.5 minute navigation message, a 50 bps binary sequence containing time tags, GPS satellite ephemerides (i.e., transmitter locations), etc.
- Time domain signal:

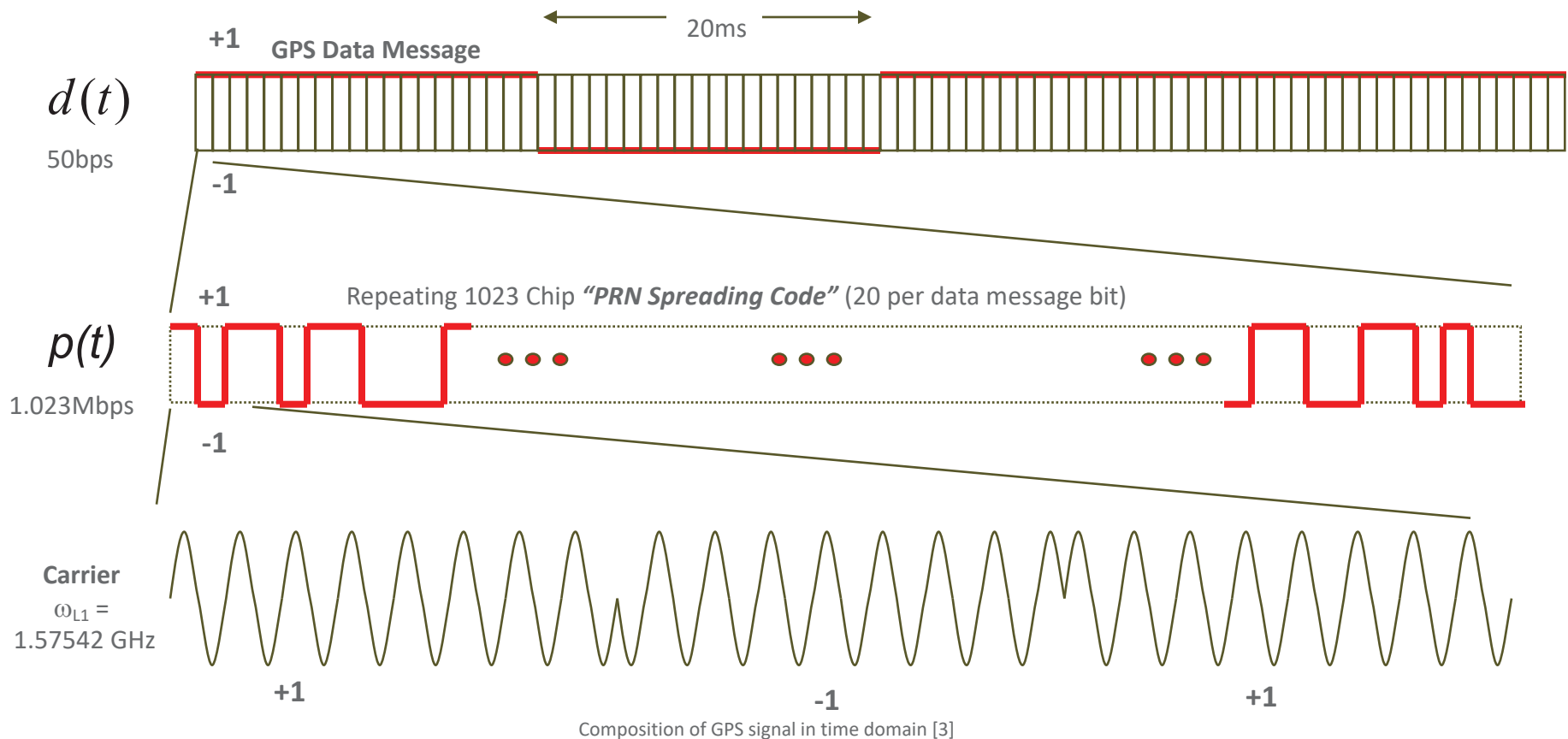

- Received L1 frequency signal from the i -th satellite

$$y^i(t) = \sqrt{2P_R} d^i(t - \tau^i(t)) p^i(t - \tau^i(t)) \cos(2\pi(f_{L1} + f_D^i)t + \theta^i(t_0)) + v^i(t)$$

GNSS receivers

- Receiver has three main tasks:
 1. **Acquisition:** Determine which satellites are visible and estimate the propagation delay and Doppler associated with each
 2. **Tracking:** Refine the delay and Doppler estimates and track these features as they change over time
 3. **Navigation:** Use measurements from all visible signals to estimate the receiver's position and velocity
- GNSS observables (i.e., receiver outputs)
 1. **Pseudorange:** propagation delay plus receiver clock bias (measured from the PRN code to a fraction of a chip: ~meter level accuracy)
 2. **Doppler:** measured frequency shift of the received carrier
 3. **Carrier phase:** measured fractional and accumulated whole cycle phase of the carrier (measured to small fraction of 19 cm cycle: ~mm precision)
 4. **C/N₀:** carrier to noise spectral density estimate in dB-Hz

GNSS receivers: acquisition

- Acquisition seeks to determine whether a particular satellite is visible (via its unique PRN) and estimate its delay (modulo one code period, 1 ms) and Doppler
- Correlation of an incoming signal with a local replica, mismatched in frequency and delay, forms what is known as an asymmetric ambiguity function:

$$\chi(\tau, f_D) = \int_{t-T_I}^t p(\alpha)p^*(\alpha - \tau)e^{i2\pi\Delta f_D\alpha} d\alpha$$

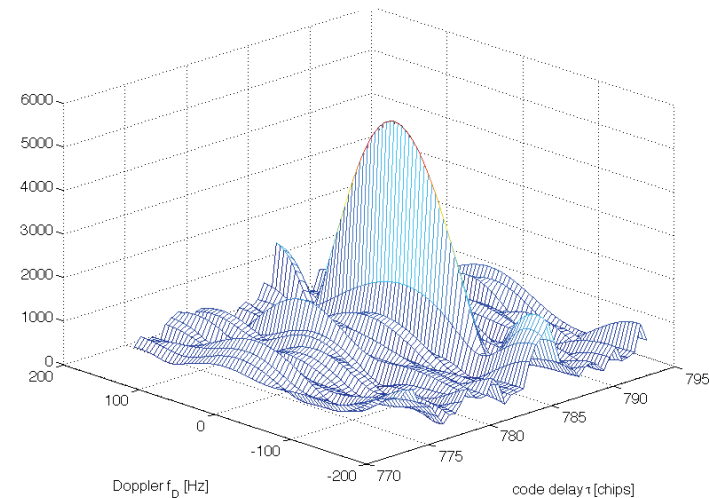
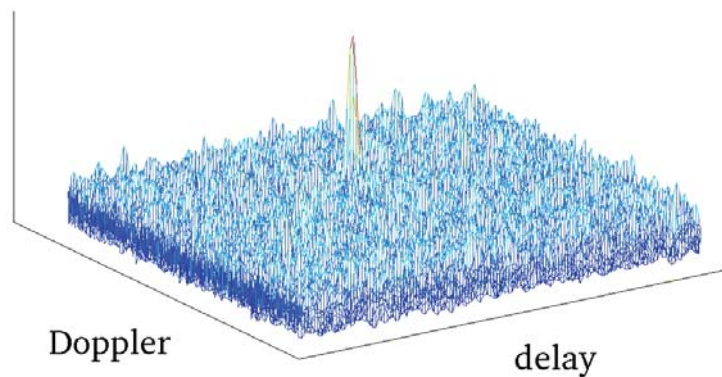

Ambiguity function magnitude complete [3] (left) and zoomed in [11] (right)

- Delay and Doppler values are tried over a search space. Correlation magnitudes are compared to the noise floor—if the carrier to noise spectral density exceeds a threshold, the signal is determined visible and the delay and Doppler at the correlation peak are used to seed tracking.
- Pre-detection integration time, T_I , is an important parameter in detecting weak signals.

GNSS receivers: tracking

- Tracking seeks to refine the delay and Doppler estimates produced by acquisition
 - Input signal is correlated with a local replica
 - Correlation result is filtered to produce error terms that quantify the difference between the input and local signal
 - A feedback process makes adjustments to the local signal replica according to the error terms
- In addition to converging on the input signal delay and Doppler parameters, the tracking of a dynamic signal allows for measurements of changing signal features and more accurate estimates of the signal to noise ratio
- Most receivers compute three correlations per signal: Early, Prompt, and Late
 - Phase of prompt corr. gives error signal for carrier tracking
 - Comparing size of Early and Late corr. gives error signal for PRN code tracking
- Coupled feedback loops DLL and PLL maintain lock on code and carrier signal parameters

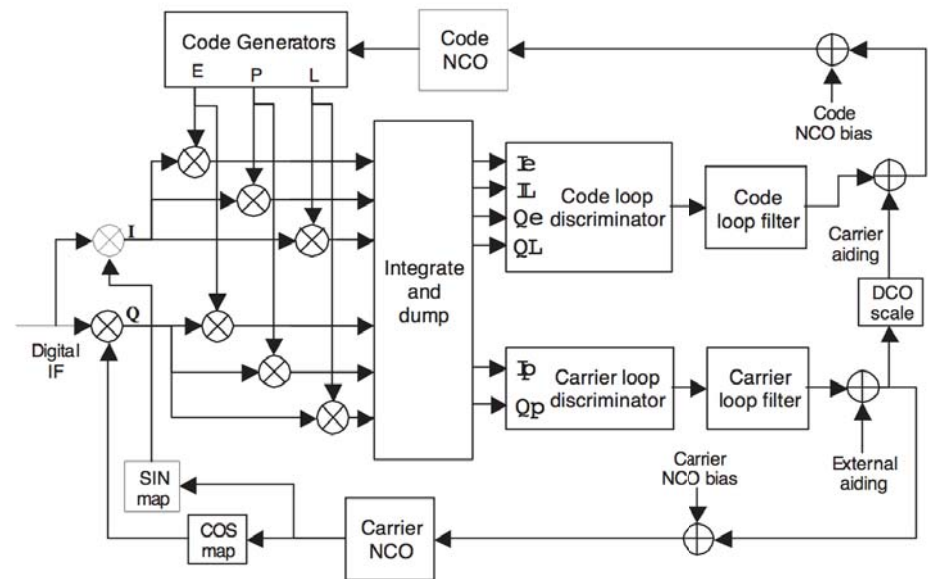

Code and carrier tracking [3] from [11]

GNSS measurements: pseudorange

- Pseudorange measured from the i -th satellite (“pseudo” because of receiver clock bias):

$$\rho^i = c(\tilde{t}_r - \tilde{t}_t^i)$$

time of reception according to receiver clock

time of transmission according to satellite clock

GNSS measurements: pseudorange

- Pseudorange measured from the i -th satellite (“pseudo” because of receiver clock bias):

$$\begin{aligned}\rho^i &= c(\tilde{t}_r - \tilde{t}_t^i) \\ &= c((t_r + \delta t_r) - (t_t^i + \delta t_t^i)) + \epsilon\end{aligned}$$

time of reception according to receiver clock

time of transmission according to satellite clock

- Transmission and receive times each expressed as a sum of the “true” time (i.e., the time according to a common time standard, such as GPST) plus an unknown bias

GNSS measurements: pseudorange

- Pseudorange measured from the i -th satellite (“pseudo” because of receiver clock bias):

$$\begin{aligned}\rho^i &= c(\tilde{t}_r - \tilde{t}_t^i) \\ &= c((t_r + \delta t_r) - (t_t^i + \delta t_t^i)) + \epsilon \\ &= c\delta t_r - c\delta t_t^i + |x - x_t^i| + Q^i + I_{L1}^i + T^i + \epsilon\end{aligned}$$

Diagram illustrating the components of the pseudorange equation:

- Green box: true receiver position (points to $|x - x_t^i|$)
- Blue box: broadcast satellite position (points to x_t^i)

- Propagation delay:

$$\tau^i = (r^i + Q^i + I_{L1}^i + T^i)/c$$

r^i is the geometric range between the i -th transmitting satellite and the receiver, $|x - x_t^i|$

Q^i is the satellite orbit error

I_{L1}^i is the delay due to the ionosphere, a region of ionized gas in the upper atmosphere where the time varying density of free electrons and ions introduces a dispersive (frequency dependent) delay

T^i is the delay due to the troposphere, the lowest region of the atmosphere, a non-dispersive medium consisting of dry gases and water vapor

GNSS measurements: pseudorange (cont.)

- Propagation delay:

$$\tau^i = (r^i + Q^i + I_{L1}^i + T^i)/c$$

Acquisition and tracking measure code phase, i.e., ambiguous time of transmission modulo one code period

(1 ms for GPS C/A code, or approximately 300 km): $p(t - \tau)$

The navigation message must be decoded to form a pseudorange

- Navigation message is organized into six second subframes, each beginning with an 8-bit Telemetry word (TLM) and Hand-over word (HOW), the latter of which contains the satellite time the subframe was transmitted

$svtime_of_transmission =$

$svtime_of_subframe$

$+bits_since_subframe_start*0.02$

$+whole_cacodes_since_bit_start*0.001$

$+whole_chips_into_current_cacode/1.023e6$

$+frac_code_phase_chips/1.023e6;$

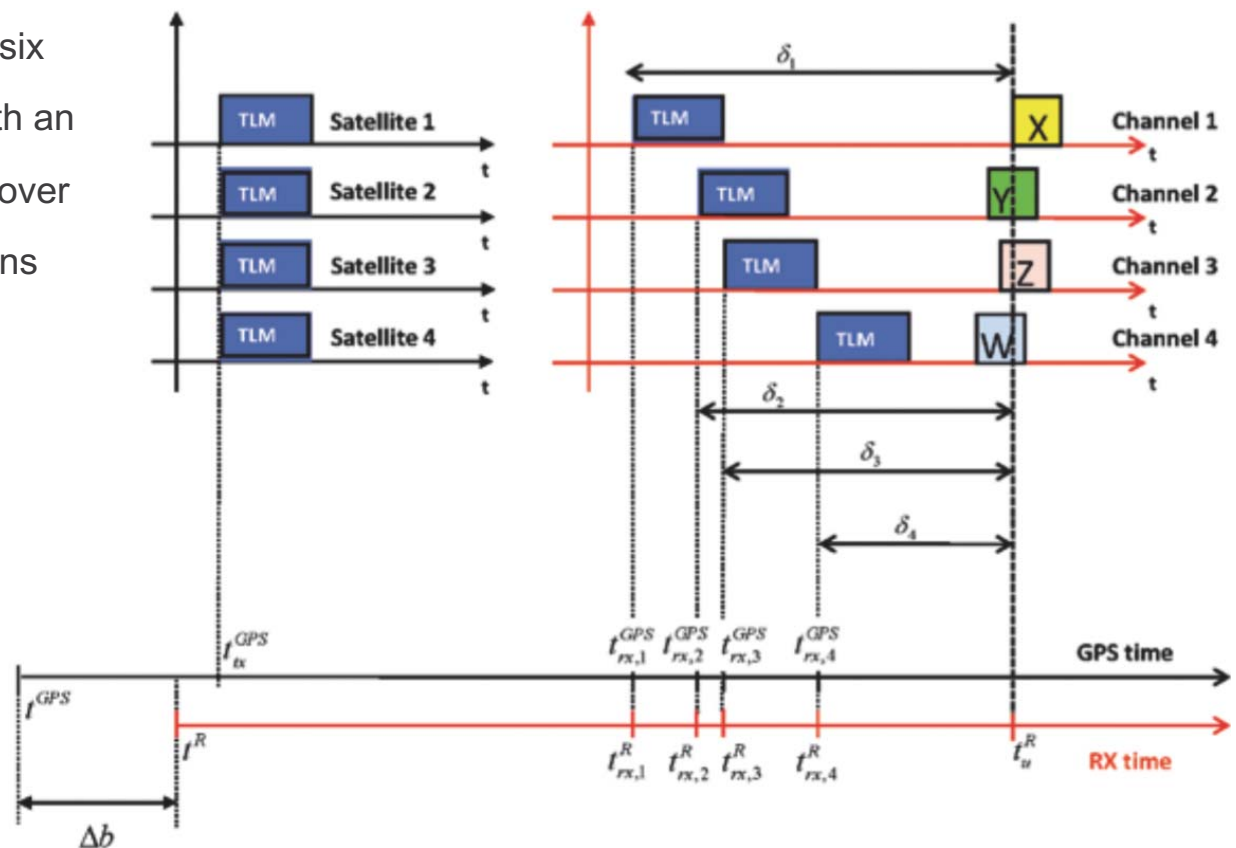

Calculation of pseudorange using four satellites [12]

GNSS measurements (cont.)

- Measured **Doppler** shift is a combination of the changing geometric line of sight and the unknown receiver clock drift. Time derivative of the pseudorange:

$$\dot{\rho}^i(t) = \dot{r}^i(t) + ct_{b,r}^i - ct_{b,s}^i$$

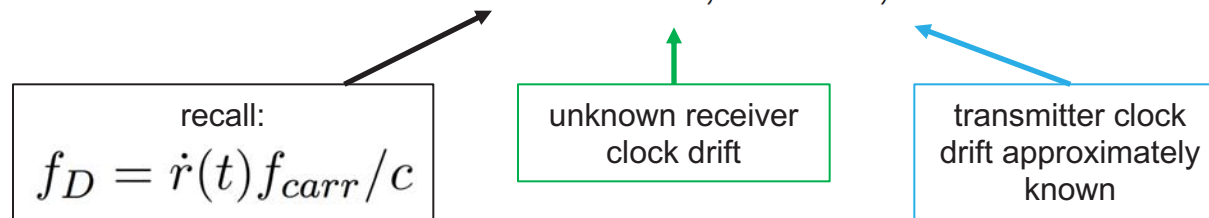

- Carrier phase**

$$\phi^i(t) = -2\pi f_{carr} \rho^i(t) / c + 2\pi M$$

Can be measured with much higher precision than code phase (i.e., pseudorange), ~cm for GPS, but ambiguous on the order of carrier cycles, 19 cm for GPS. Combine with code measurements or use for precise measurement of change (Accumulated Delta Range)

Ionosphere also induces a delay, but opposite in sign relative to pseudorange, leading to a code/carrier divergence

Navigation solution: typical GPS error budget

Error Source	Basic single frequency	Precise dual-freq, assisted
Ionosphere (< 1000 km)	~3 m (single frequency, using broadcast model)	Dual frequency <1 cm
Troposphere (< 20 km)	0.1-1 m	1 cm level using estimators, advanced models
GPS orbits	<2.0 m (broadcast ephemeris)	1 cm, Int. GNSS service (IGS)
GPS clocks	<2.0 m (broadcast clock)	1 cm (IGS)
Multipath (“clean” environment)	0.5-1 m code	0.5-1 cm carrier
Receiver Noise	0.25-0.5 m code	1-2 mm carrier
RSS range error	4 m	2 cm
Typical GDOP	2	2
RSS solution error	8 m	4 cm

- Disclaimer: for illustration purposes only

GNSS multipath

- Propagation delay:

$$\rho^i = r^i + ct_{b,r} - ct_{b,s}^i + Q^i + I_{L1}^i + T^i + \epsilon^i$$

- **Multipath**

Reflected signals are received as delayed, attenuated replicas of the direct signal

Correlation shape of the combined signal causes an error in the code tracking loop that depends on geometry, number and strength of reflections, and tracking loop design

E.g., one signal, noncoherent DLL:

$$\tau_M = \frac{\alpha^2 \delta + \alpha \delta \cos \psi}{1 + \alpha^2 + 2\alpha \cos \psi}$$

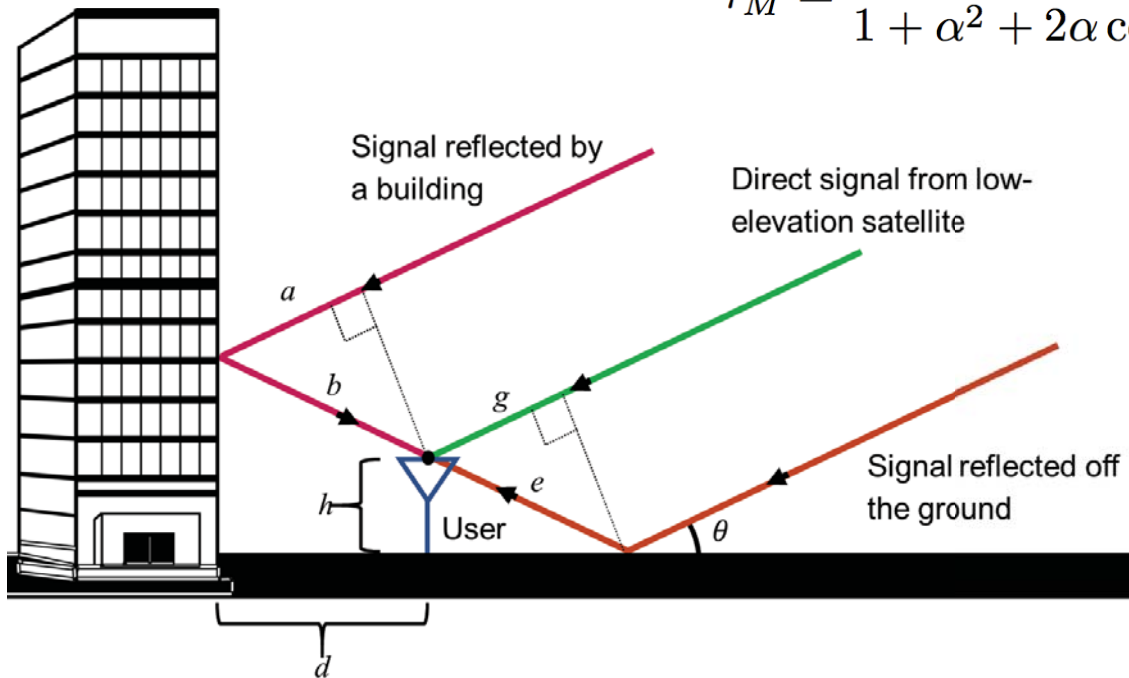

Direct, building-reflected, and ground-reflected signal paths in multipath interference scenario [19]

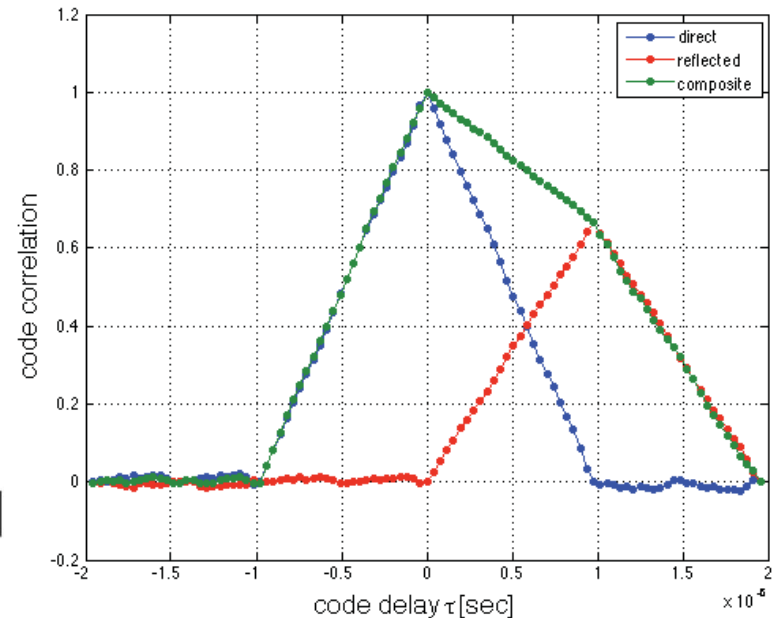

Direct, reflected, and composite correlations [10]

GNSS multipath (cont.)

- Carrier phase (cont.)

$$\phi_M^i(t) = (2\pi\Delta^i/\lambda_{carr} + \phi_R^i) \text{MOD}2\pi$$

Wall reflection

$$\Delta = a + b = 2d \cos \theta$$

$$\frac{\partial \phi_M^i}{\partial t} = - \left(\frac{4\pi d}{\lambda_{carr}} \sin \theta \right) \frac{\partial \theta}{\partial t}$$

Ground reflection

$$\Delta = e - g = 2h \sin \theta$$

$$\frac{\partial \phi_M^i}{\partial t} = \left(\frac{4\pi h}{\lambda_{carr}} \cos \theta \right) \frac{\partial \theta}{\partial t}$$

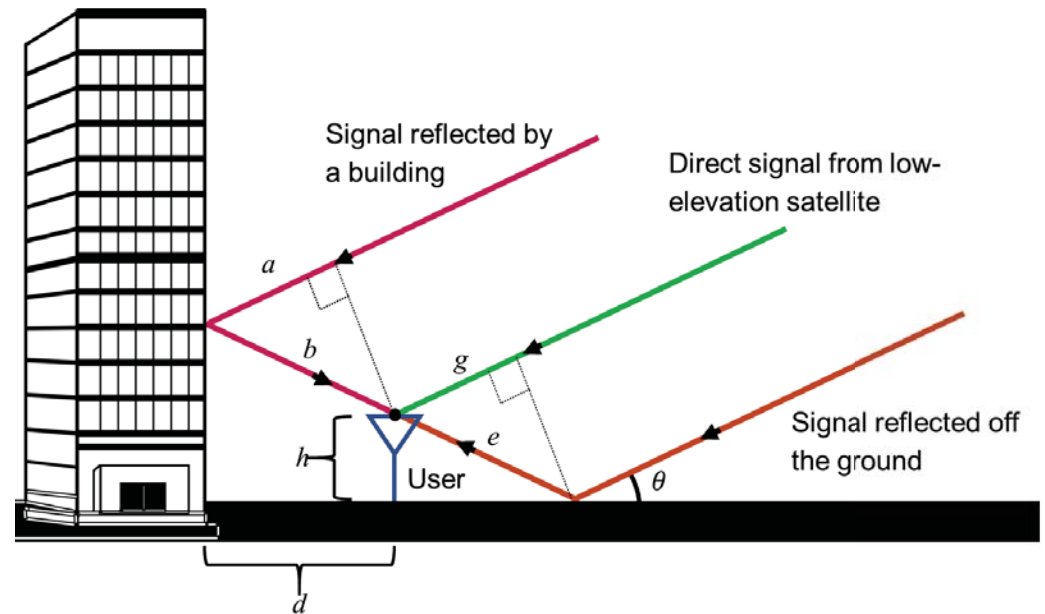

Direct, building-reflected, and ground-reflected signal paths in multipath interference scenario [19]

GNSS time reference

- GNSS requires a common time scale for computing ranges
- GPS Time (GPST) is the operational time scale of GPS
- To keep satellites on GPST adequately, atomic clocks are required

Corrections in the navigation message are used to synchronize satellites to GPST

For example, to limit clock error to 1 m over

12 hrs requires drift $< 8 \times 10^{-14}$ s/s

- GPST coarsely steered to align with Universal Consolidated Time (UTC) as maintained by the US Naval Observatory via corrections in the navigation message
- **Traceability to UTC USNO enables precise time and frequency transfer on a global scale**

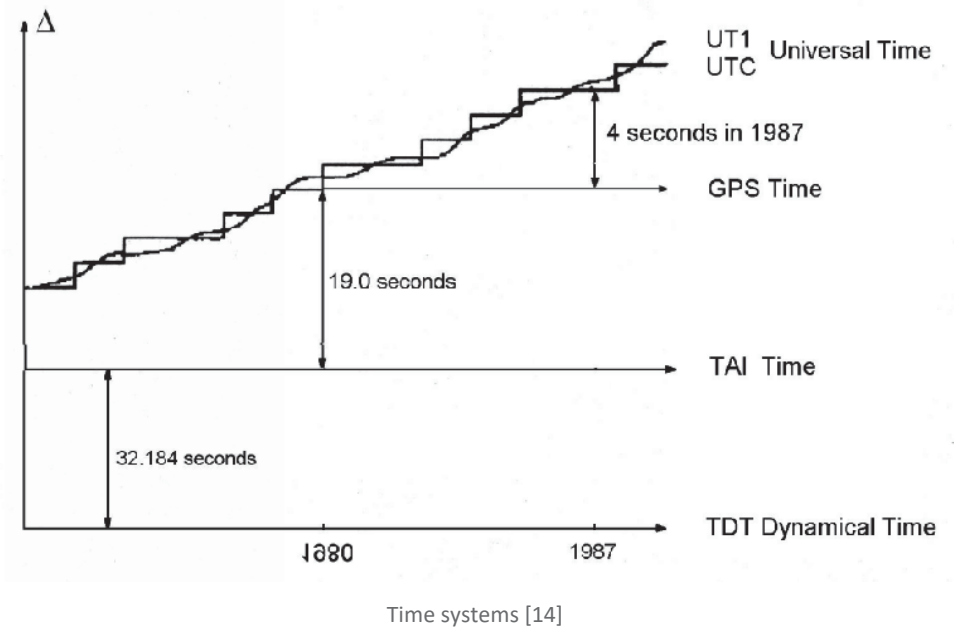

- Tidal friction and other processes that cause a significant redistribution of mass are slowing the Earth's rotation, lengthening the solar day by ~ 2 ms / century
- UTC incorporates leap seconds to maintain alignment with sidereal time (UT1), but GPST does not. This difference is a persistent challenge for receiver designers and users.

Navigation solution

- Position estimation with pseudorange

Want to estimate receiver position and clock bias at some instant in time:

$$\mathbf{x} = \begin{bmatrix} x & y & z \end{bmatrix} \text{ and } b = c\delta t_{b,r}$$

Given $N > 4$ pseudorange measurements (corrected for transmitter clock bias):

$$\rho^i = |\mathbf{x} - \mathbf{x}_t^i| + b + v^i$$

Standard approach is to solve as a non-linear least squares (NLLS) problem by Gauss-Newton method:

$$\text{minimize } J(\hat{\mathbf{x}}, \hat{b}) = \sum_{i=1}^N \left(\rho^i - (|\hat{\mathbf{x}} - \mathbf{x}_t^i| + \hat{b}) \right)^2$$

1. Linearize about initial guess $(\hat{\mathbf{x}}_0, \hat{b}_0)$
2. Solve linear least squares problem for $(d\hat{\mathbf{x}}, d\hat{b})$
3. Set $\hat{\mathbf{x}}_1 = \hat{\mathbf{x}}_0 + d\hat{\mathbf{x}}, \hat{b}_1 = \hat{b}_0 + d\hat{b}$
4. Iterate

Navigation solution: DOP

- In general, when solving the linear least squares problem

$$z = H\theta + v, \text{Cov}\{z\} = \sigma_z^2 I$$

- The covariance of the least squares solution θ^* is

$$\sigma_\theta^2 = \text{Cov}\{\theta^*\} = \sigma_z^2 (H^T H)^{-1} = \sigma_z^2 W$$

- W (the inverse Gramian matrix) transforms measurement noise into solution noise

- In GPS, the i -th row of H is

$$\mathbf{h}_i = [\mathbf{u}_i^T, 1] \text{ with } \mathbf{u}_i = \frac{\mathbf{x} - \mathbf{x}_t^i}{|\mathbf{x} - \mathbf{x}_t^i|} \text{ (unit vector from transmitter to receiver)}$$

- Thus, W is determined by the geometry of the visible transmitters. Dilution of Precision (DOP):

$$GDOP := \sqrt{\sum_{i=1}^4 W_{ii}} \quad PDOP := \sqrt{\sum_{i=1}^3 W_{ii}} \quad TDOP := \sqrt{W_{44}}$$

- Examples

If transmitters are in a plane, H is rank deficient and $GDOP = \infty$

If transmitters are located at corners of a tetrahedron $GDOP = \sqrt{3}$ (minimum for $N = 4$)

Improving performance

- Multi-frequency receivers
 - Eliminate ionosphere as an error source through “ionosphere-free combination”
- Carrier phase observables
 - Millimeter rather than meter level measurement noise and negligible multipath error
- Differential measurements: Receivers in close proximity can be used to cancel common error sources (e.g., Differential GPS, DGPS)
 - Ionosphere, troposphere, satellite orbit/clock can be cancelled by differencing measurements or solutions
 - Solution is relative
- Precision GNSS orbits and clocks
 - Available from global networks of reference receivers (e.g., International GNSS Service, ICG) for post-processing and in near real-time
- Augmentations
 - Additional transmitters and measurements enhance geometry
- Filtering
 - Incorporate dynamic constraints or additional measurement sources (e.g., inertial sensors)
- **A combination of these techniques enables cm to mm level solutions**

GPS modernization: new civilian signals

L2C

Features



1227.60 MHz

- Radio Navigation Satellite Services (RNSS) radio band
- Modern signal design (CNAV), including multiple message types and forward error correction
- Bi-Phase Shift Key (BPSK) modulation
- Includes dedicated channel for codeless tracking

L5

Features



1176.45 MHz

- Highly protected Aeronautical Radio Navigation Services (ARNS) radio band
- Higher transmitted power than L1 C/A or L2C
- Greater bandwidth for improved jam resistance
- Modern signal design (CNAV), including multiple message types and forward error correction
- Bi-Phase Shift Key (BPSK) modulation
- Includes dedicated channel for codeless tracking

L1C

Features



1575.42 MHz

- Aeronautical Radio Navigation Services (ARNS) radio band
- Designed for international GNSS interoperability
- Modern signal design (CNAV-2), including forward error correction
- Multiplexed Binary Offset Carrier (MBOC) modulation

New civilian signal specs [24]

GPS modernization: new civilian signals

L2C

Features



1227.60 MHz

Status

- Pre-operational signal with message set "healthy"
- Broadcasting from 19 GPS satellites (as of April 24, 2019)
- Began launching in 2005 with GPS Block IIR-M
- Available on 24 GPS satellites ~2021 (as of May 2017)

L5

Features



1176.45 MHz

Status

- Pre-operational signal with message set "unhealthy" until sufficient monitoring capability established
- Broadcasting from 12 GPS satellites (as of April 24, 2019)
- Began launching in 2010 with GPS Block IIF
- Available on 24 GPS satellites ~2024 (as of May 2017)

L1C

Features



1575.42 MHz

Status

- Begins launching in 2018 with GPS III (as of May 2017)
- Available on 24 GPS satellites in late 2020s

New civilian signal specs [24]

GPS documentation

- System technical docs available on www.gps.gov
- GPS IS-200:
 - Spec. of legacy C/A & P codes and NAV message
 - Rev E and beyond adds L2C and CNAV
- GPS IS-800:
 - Specification of L5, and L5 CNAV
- SPS & PPS Performance standards
 - Defines the guaranteed level of performance in terms of Signal in Space (SIS) accuracy and Constellation design
 - Current system performance surpasses minimum spec and is improving.

GNSS Applications

GNSS Science: Reflectometry

- Reflectometry material from Rashmi Shah (rashmi.shah@jpl.nasa.gov)
- Concept: **Multistatic radar system**
 - **Transmitters** are GNSS satellites (L-band suitable for all weather)
 - **Receivers** are dedicated platforms equipped with specialized GNSS receiver/processor and antenna system
 - Reflected signal is influenced by the surface type, underlying medium, and atmosphere traversed (e.g., ionosphere)
- Scattered field is cross correlated with a code replica
 - Coherency: The closer the shape to a triangle, the more coherent the scattering
 - Scatterometry: Sensitivity of shape to roughness etc.
 - Altimetry: Delay value corresponding to specular point enables measurement of range associated with reflection geometry

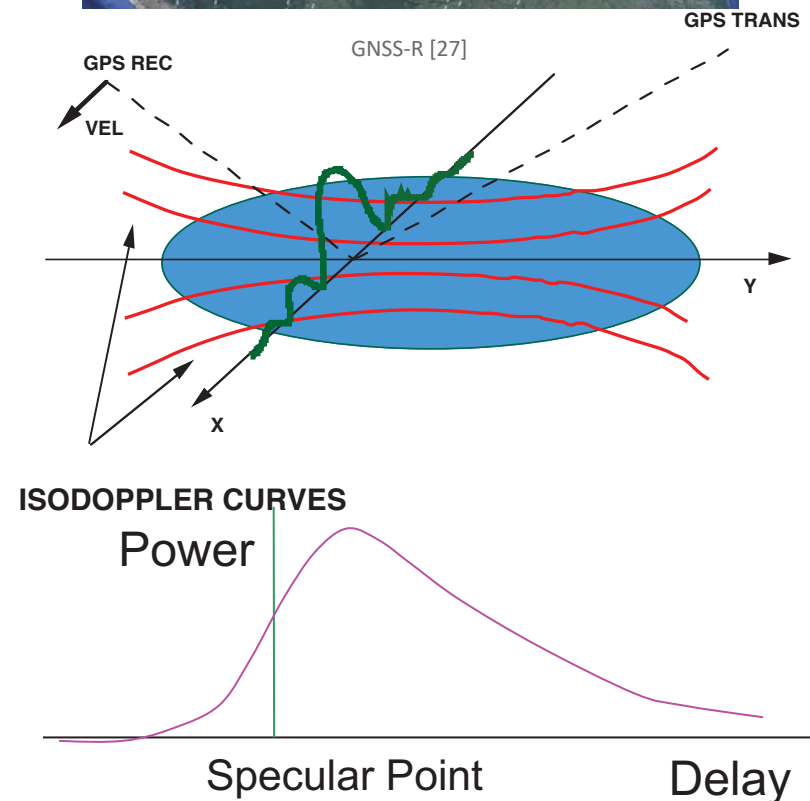
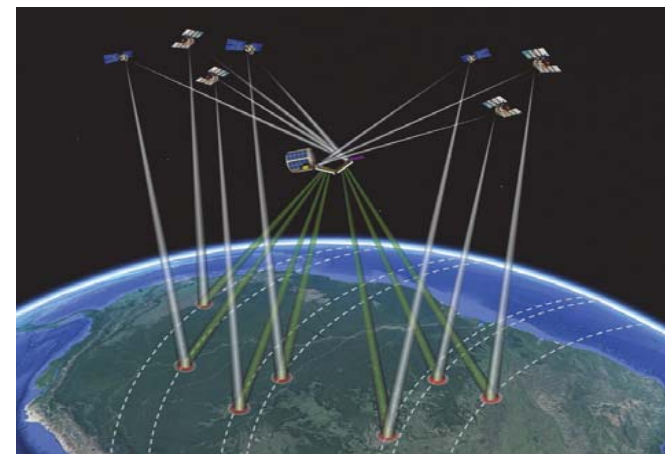

Reflected signal integrated along the Doppler coordinate: not a symmetric triangle [27]

GNSS-R: Delay Doppler Maps

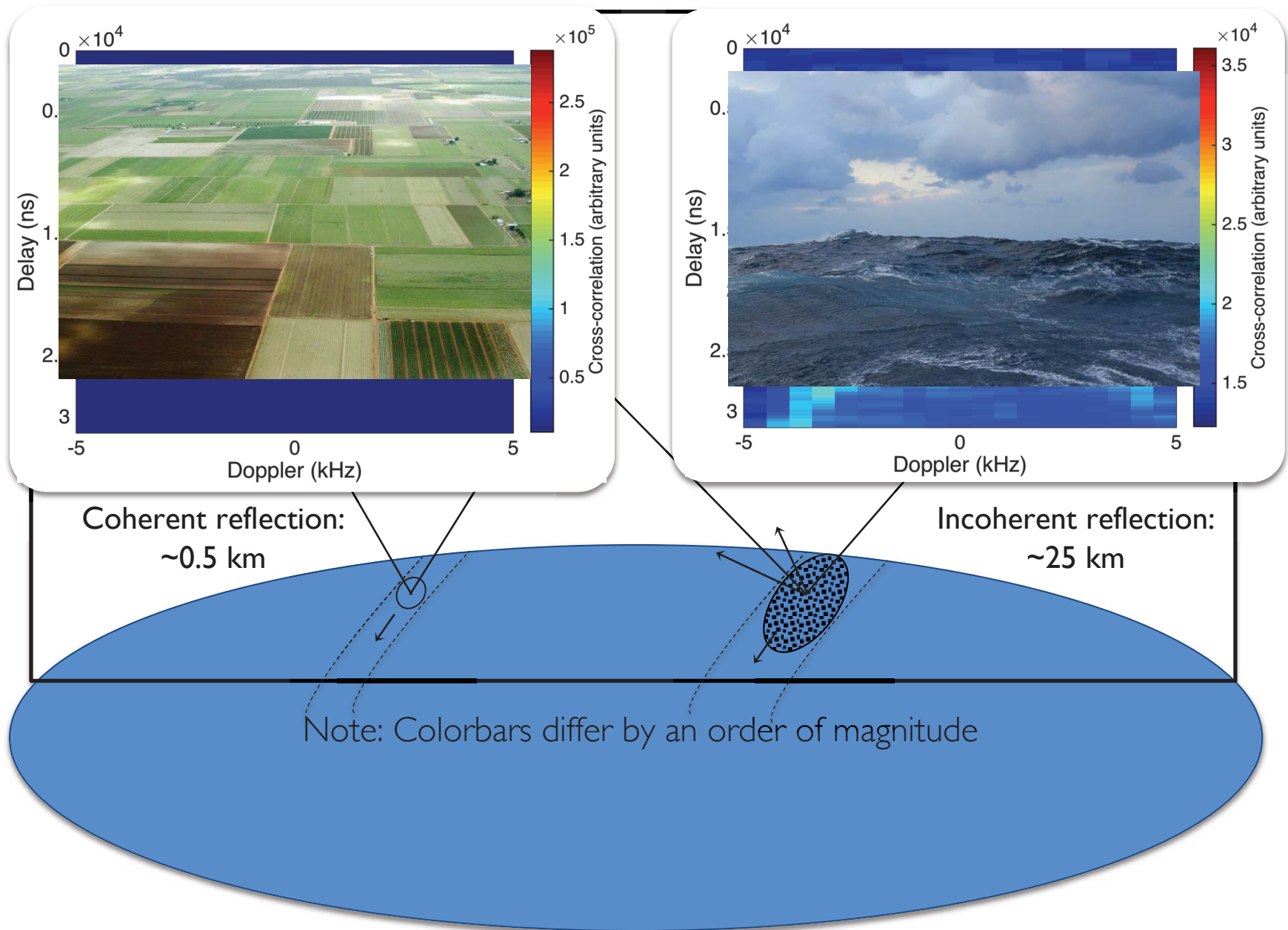

GNSS-R: CYGNSS

- Constellation of 8 nanosatellites to study the inner core of tropical cyclones
 - Selected by NASA in EVM-1 competition
 - Launched in 2016
 - 8 satellites at 500 km altitude, 35 deg inclination
- Objectives
 - Measure ocean surface wind speed in all precipitating conditions, including those experienced in the tropical cyclone eye wall
 - Measure ocean surface wind speed in the tropical cyclone inner core with sufficient frequency to resolve genesis and rapid intensification
- CYGNSS reflectivity broadly agrees with SMAP soil moisture measurements

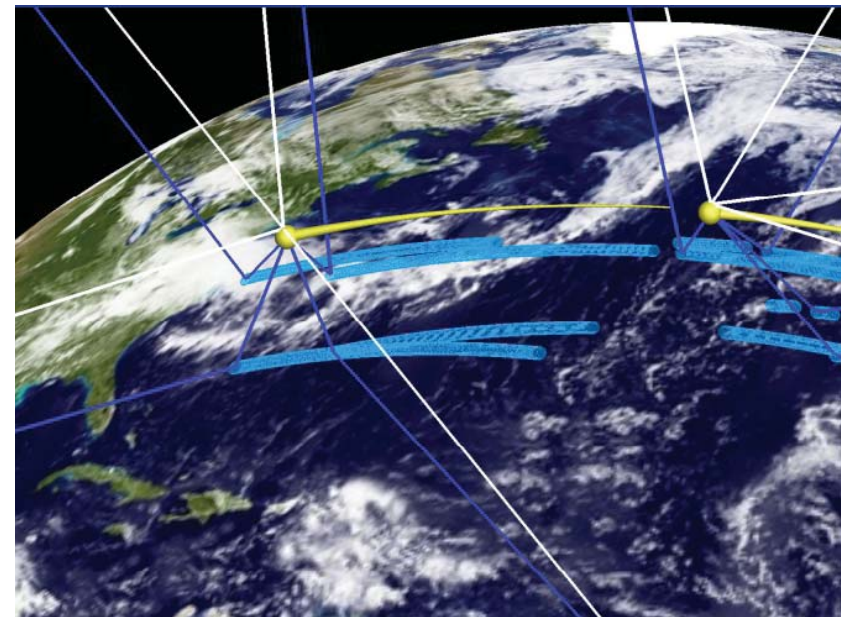
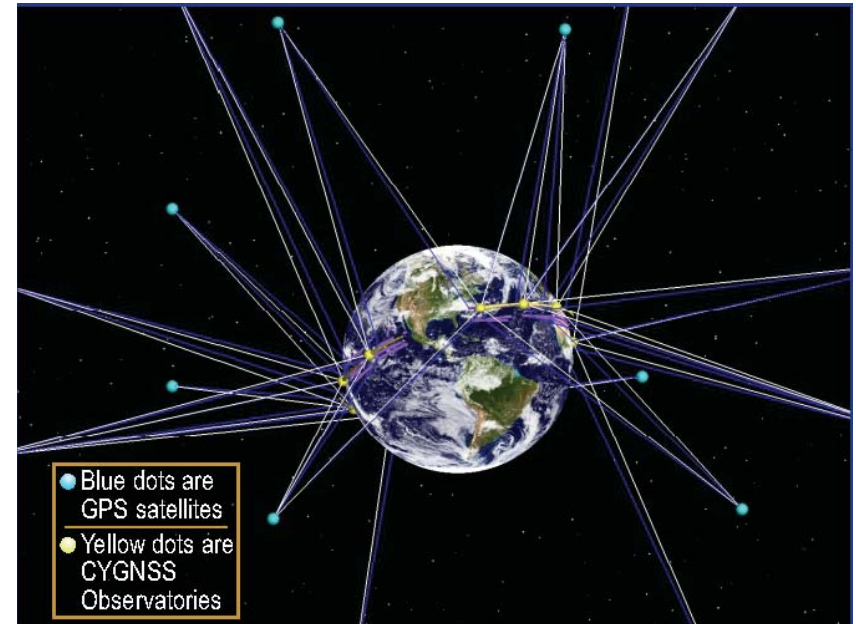

CYGNSS [27]

GNSS Signals in the Space Service Volume (SSV)

- The Terrestrial Service Volume (TSV) is defined as the volume of space including the surface of the Earth and LEO, i.e., up to 3,000 km
- The Space Service Volume (SSV) is defined as the volume of space surrounding the Earth from the edge of LEO to GEO, i.e., 3,000 km to 36,000 km altitude
- The SSV overlaps and extends beyond the GNSS constellations, so use of signals in this region often requires signal reception from satellites on the opposite side of the Earth – main lobes and sidelobes
- Use of GNSS in the SSV is increasing despite geometry, Earth occultation, and weak signal strength challenges

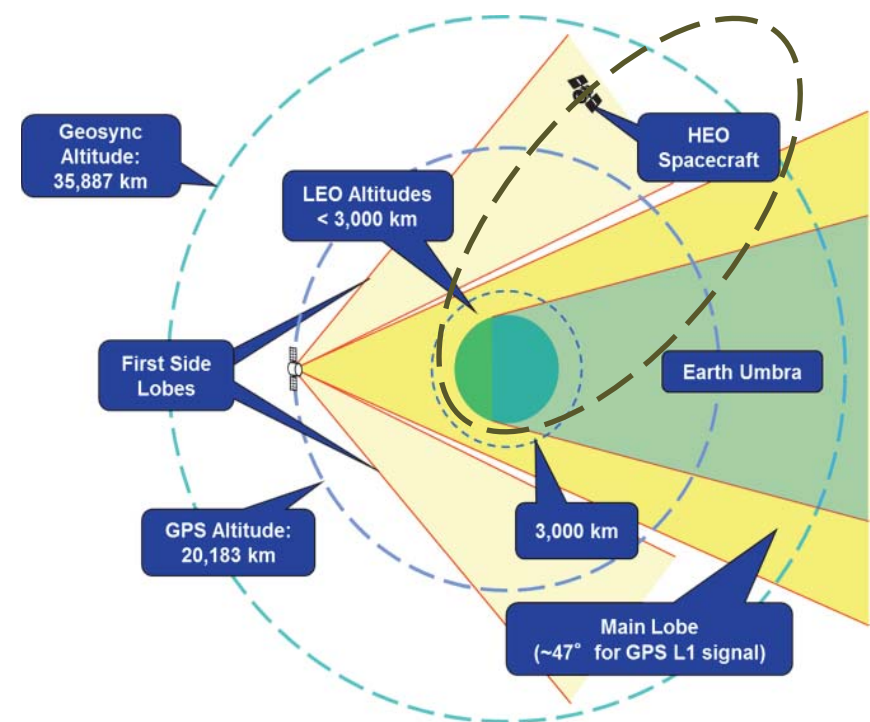

The Space Service Volume [25]

Benefits of Real-Time GNSS Navigation in the SSV

Benefits of GNSS use in the TSV and SSV:

- Supports **fast trajectory maneuver recovery** (from: 5-10 hours to: minutes)
- Significantly **improves real-time navigation performance** (from: km-class to: meter-class)
- GNSS timing **reduces need for expensive on-board clocks** (from: \$100sK-\$1M to: \$15K-\$50K)
- Supports **increased satellite autonomy**, lowering mission operations costs (savings up to \$500-750K/year)
- Enables new/enhanced capabilities and better performance for **High Earth Orbit (HEO) and Geosynchronous Earth Orbit (GEO) missions**, such as:



Earth Weather Prediction using
Advanced Weather Satellites

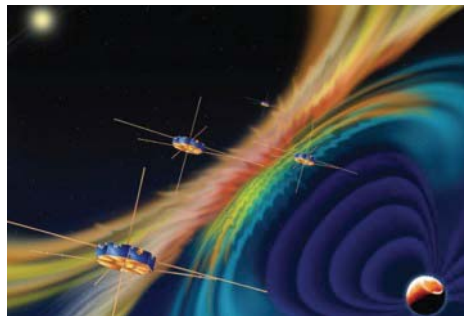

Space Weather Observations



Precise Relative Positioning



Launch Vehicle Upper Stages
and Beyond-GEO applications

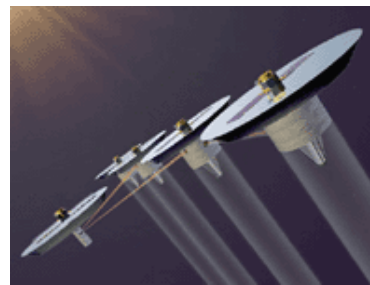

Formation Flying, Space Situational
Awareness, Proximity Operations

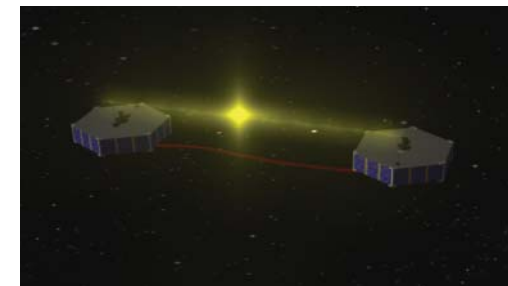

Precise Position Knowledge
and Control at GEO

High Altitude GNSS

Transition from experimentation to operational use:

- 1990s: Early flight experiments demonstrated basic feasibility – Equator-S, Falcon Gold
- 2000: Reliable GPS orbit determination demonstrated at GEO employing a bent pipe architecture and ground-based receiver (Kronman 2000)
- 2001: AMSAT OSCAR-40 mapped GPS main and sidelobe signals (Davis et al. 2001)
- 2015: MMS employed GPS operationally at 76,000 km and recently 150,000 km
- 2016: GOES-16 employed GPS operationally at GEO

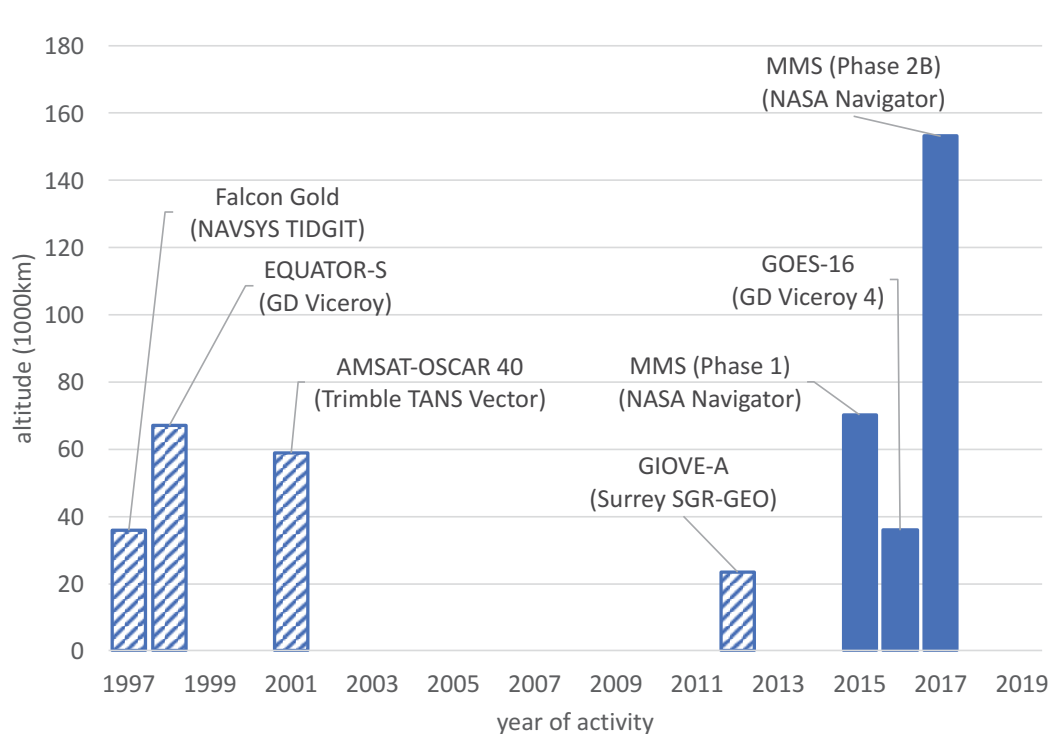

■ - Operational use of GPS
 ▨ - Experimental use of GPS

	Altitude [km]	Altitude [R_E]
GPS	20,200	3
GEO	36,000	5.6
MMS 1	76,000	12
MMS 2	153,000	24
Moon	378,000	60

Recent Activities: GPS ACE

GPS Antenna Characterization Experiment (GPS ACE)

- GPS L1 C/A signals from GEO are available at a ground station through a “bent-pipe” architecture
- Goal: Map side lobes by inserting advanced, weak-signal tracking GPS receivers at ground station to record observations from GEO
- Method: Trace path of GEO vehicle in antenna frame of each GPS vehicle and **reconstruct full gain pattern** after months of tracking
- In-flight averaged over all SVNs in block in 1 deg x 1 deg bins
- Remarkable similarity between average flight and ground measurements

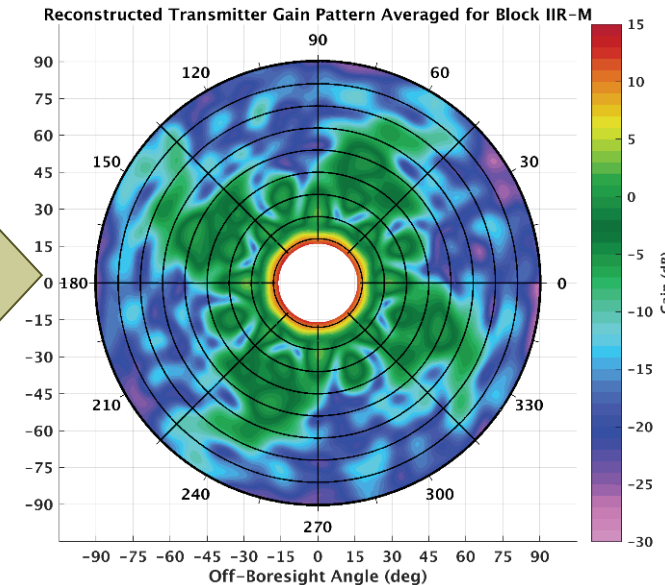
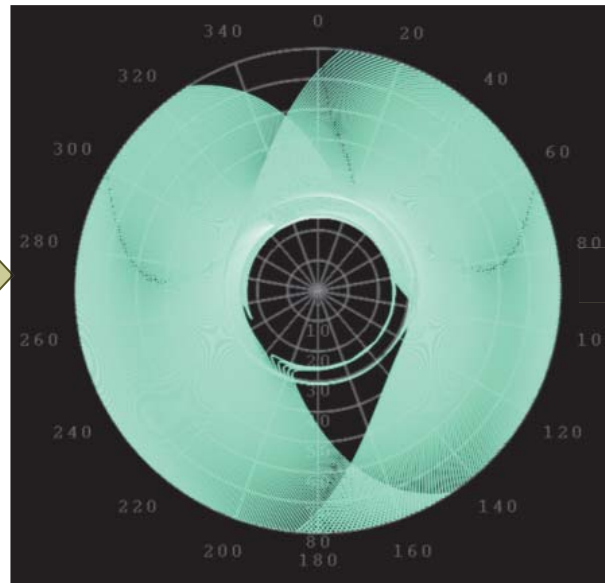
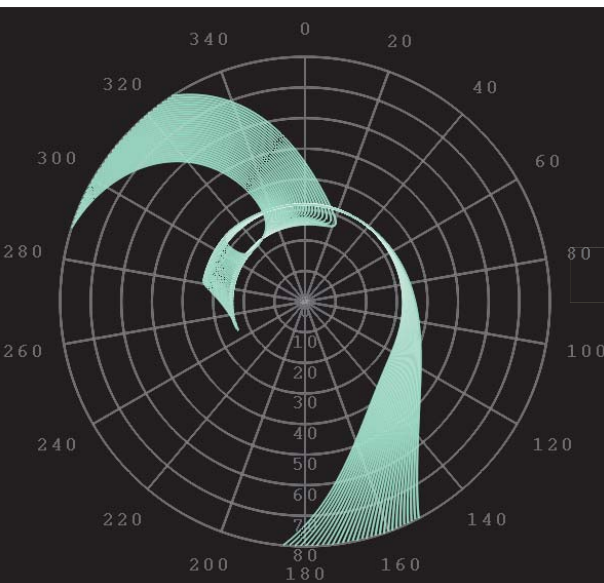
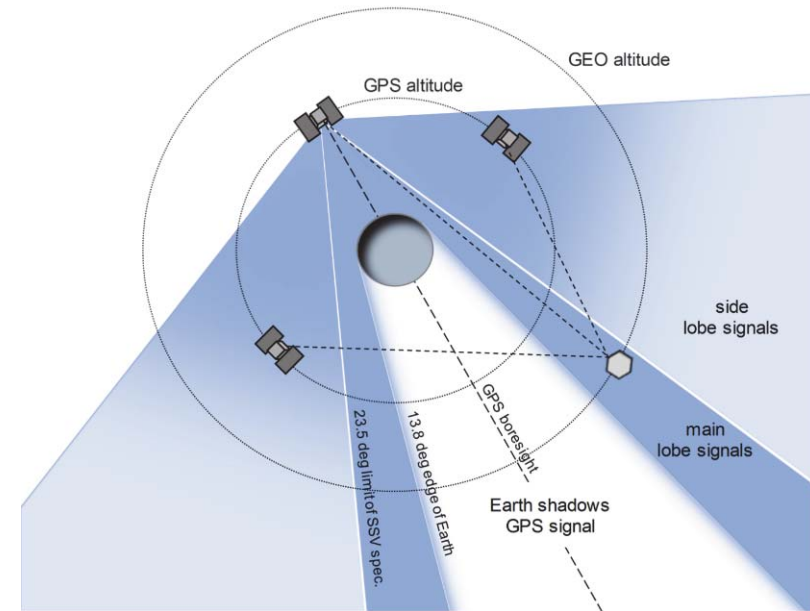

Recent Activities: GPS ACE

GPS Antenna Characterization Experiment (GPS ACE)

- GPS ACE architecture permits tracking of extremely weak signals over long duration
- Characterized full gain patterns from Blocks IIA, IIF for the first time
- Additional analysis of pseudorange deviations indicate usable measurements far into side lobes
- Dataset available at: <https://esc.gsfc.nasa.gov/navigation>

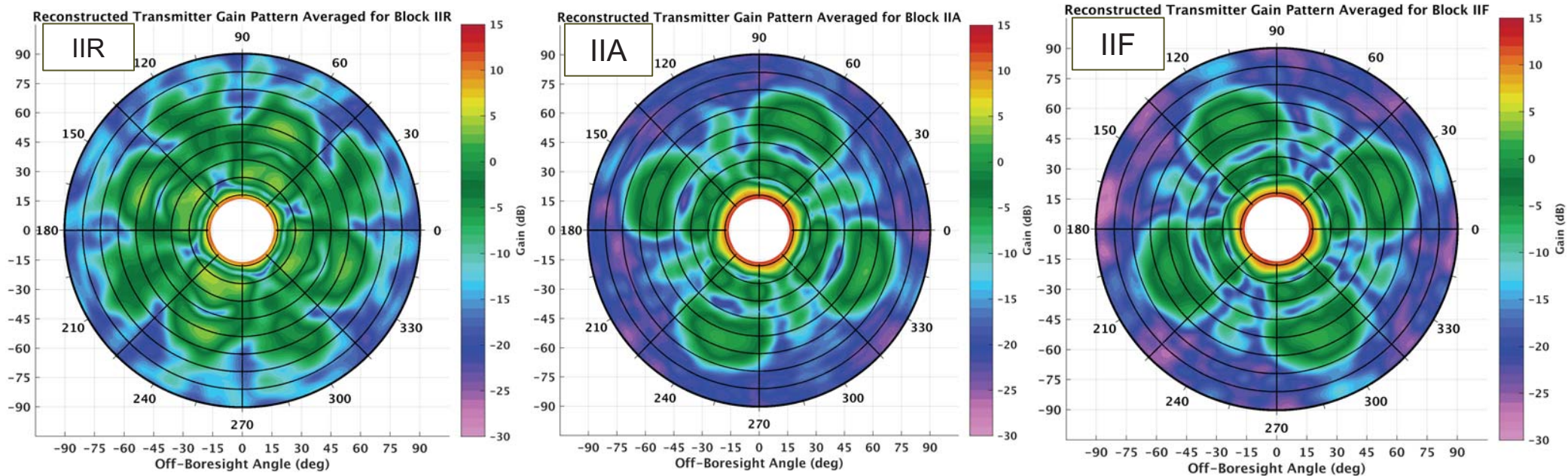

GPS Antenna Patterns from ACE [26]

Recent Activities: MMS

Magnetospheric Multi-Scale (MMS)

- Launched March 12, 2015
- Four spacecraft form a tetrahedron near apogee for performing magnetospheric science measurements (space weather)
- Four spacecraft in highly eccentric orbits
- Phase 1: 1.2 x 12 Earth Radii (R_E) Orbit (7,600 km x 76,000 km)
- Phase 2B: Extends apogee to 25 R_E (~150,000 km) (40% of way to Moon)
- 2019: Apogee raise to 1.2x29 R_E

MMS Navigator System

- GPS enables onboard (autonomous) navigation and near autonomous station-keeping
- MMS Navigator system exceeds all expectations
- Two Guinness world records:
 - highest reception of signals and onboard navigation solutions by an operational GPS receiver in space
 - fastest operational GPS receiver in space, at velocities over 35,000 km/h

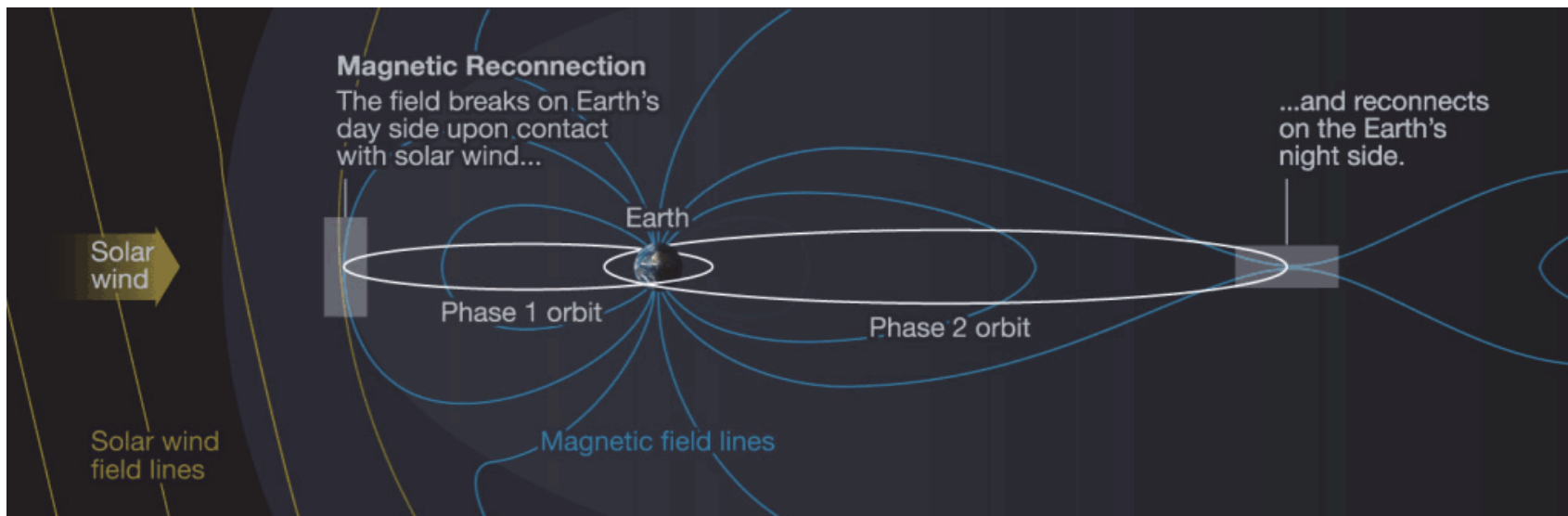

Recent Activities: MMS

- Results from 8-day period early in Phase 2B shown here
- Sidelobes dominate signals tracked above the GPS constellation
- Long term trend shows average of ~ 3 signals tracked near apogee, with up to 8 observed.
- Visibility exceeds preflight expectations significantly

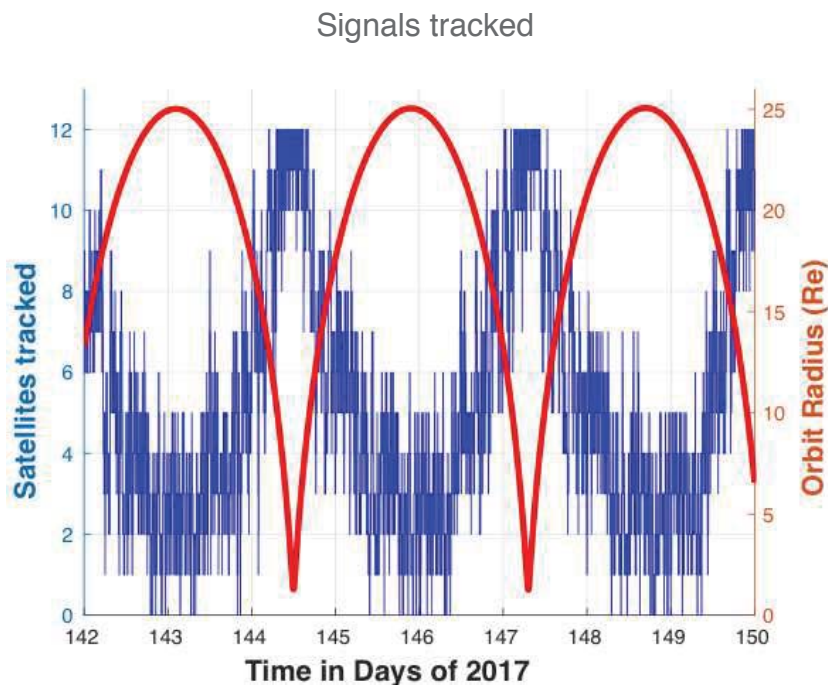

C/N₀ vs. time, near apogee

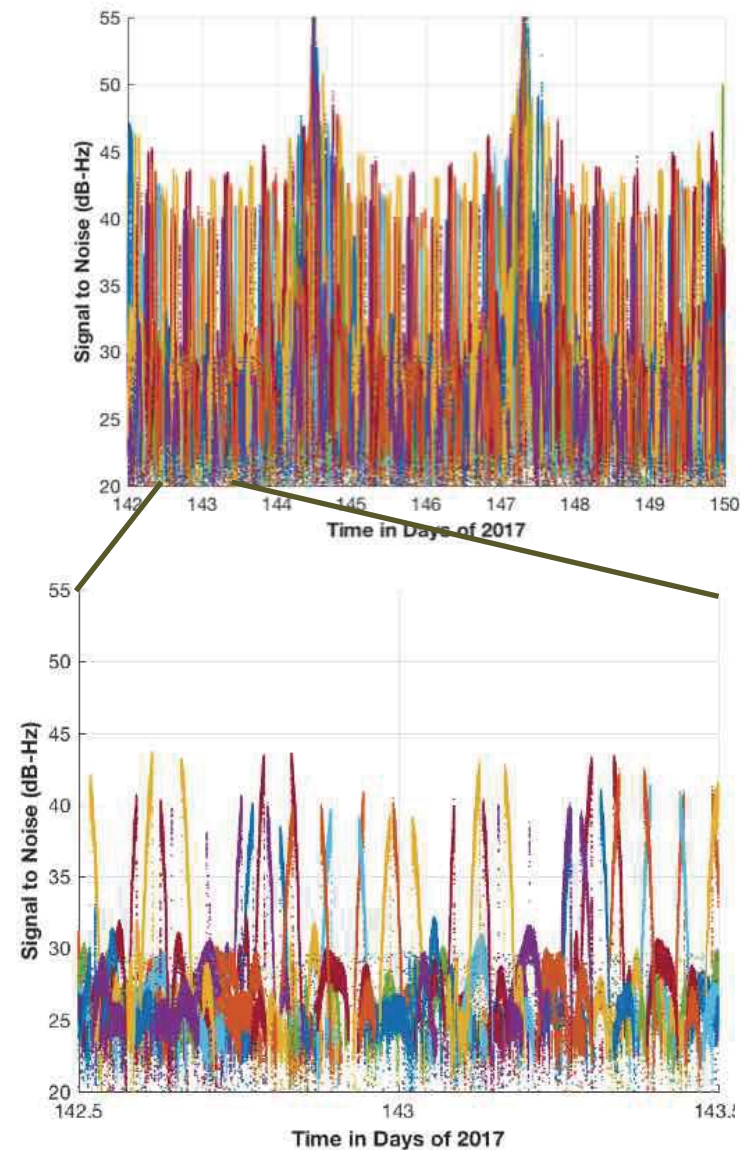

Recent Activities: GOES-R Series Weather Satellites

- GOES-R, -S, -T, -U: 4th generation NOAA operational weather satellites
- GOES-R/GOES-16 Launch: 19 Nov 2016
- GOES-S/GOES-17 Launch: 1 March 2018
- 15 year life, series operational through mid-2030s
- Features new CONOPS over previous generation:
 - Daily low-thrust station-keeping maneuvers, rather than annual high-thrust events
 - Continuous data collection through maneuvers, <120 min of outage per year
 - Tighter navigation accuracy requirements and faster cadence needed to support highly increased operational tempo
- Employs on-board GPS at GEO to meet stringent navigation requirements
- Utilizes GPS sidelobe signals to increase SSV performance and ensure continuous availability



GOES-16 Image of Hurricane Maria Making Landfall over Puerto Rico

Recent Activities: GOES-R Series Weather Satellites

GPS Visibility

- Minimum SVs visible: 7
- DOP: 5–15
- Major improvement over guaranteed performance spec (4+ SVs visible 100% of time)

Navigation Performance

- 3σ position difference from smoothed ground solution:
- Radial: 14.1 m
- In-track: 7.4 m
- Cross-track: 5.1 m
- Compare to requirement: (100, 75, 75) m

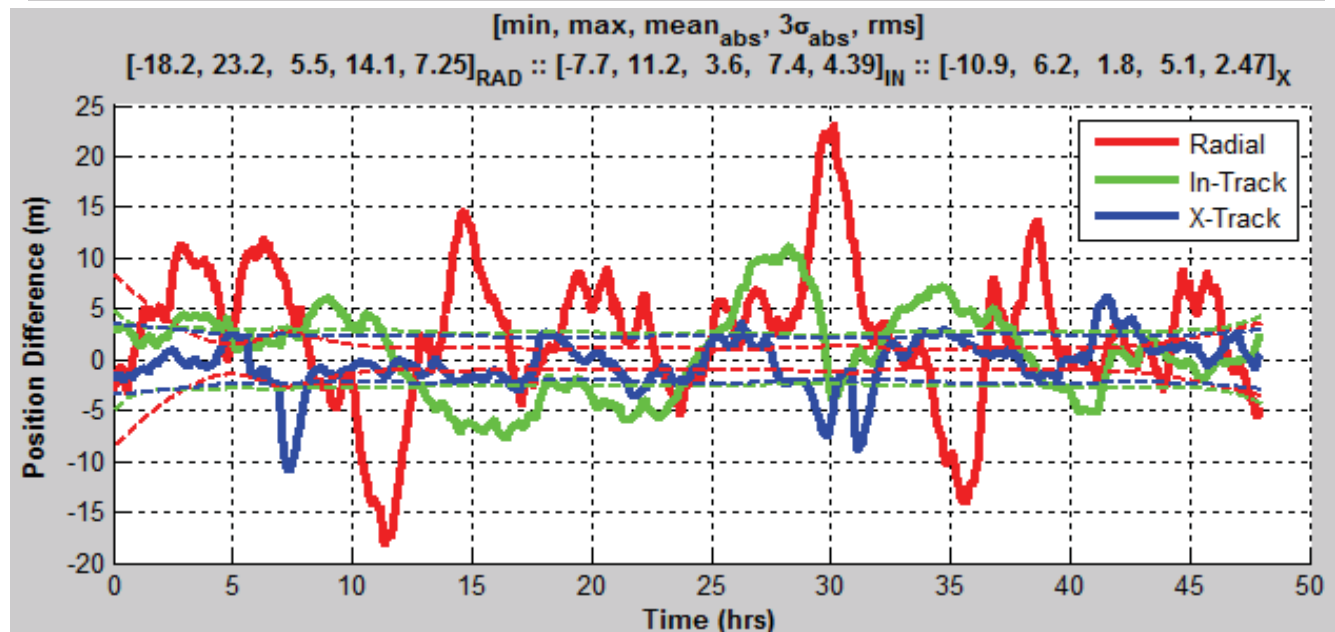
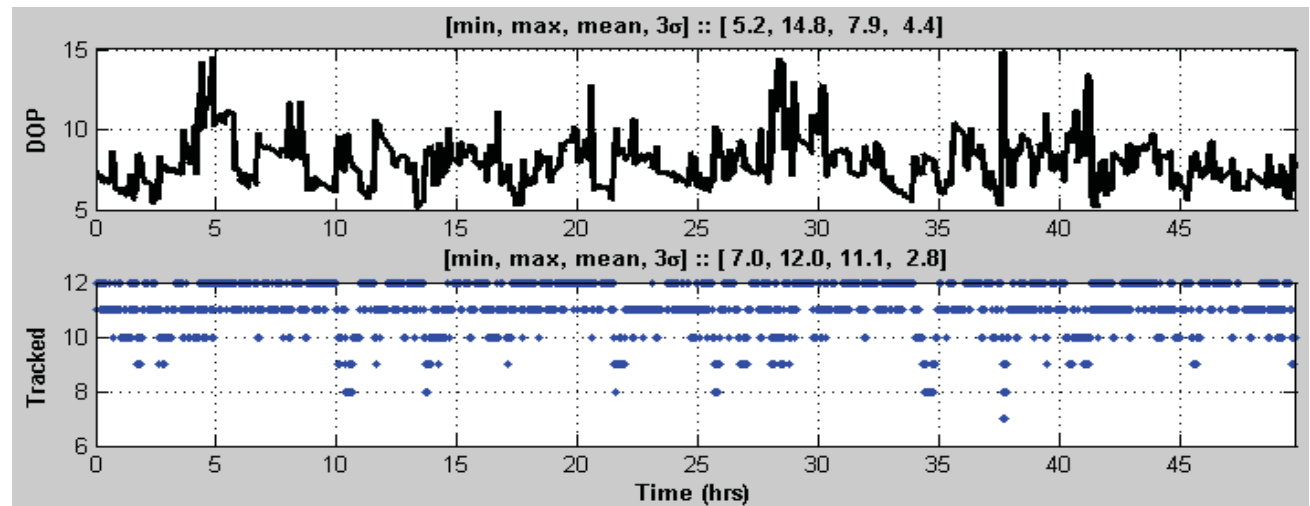

Source: Winkler, S., Ramsey, G., Frey, C., Chapel, J., Chu, D., Freesland, D., Krimchansky, A., and Concha, M., "GPS Receiver On-Orbit Performance for the GOES-R Spacecraft," ESA GNC 2017, 29 May-2 Jun 2017, Salzburg, Austria.

Future Applications: Lunar Missions

2018 Global Exploration Roadmap reaffirms intention of 14 space agencies to go to the Moon in the next decade

Increased understanding of signal performance at high altitudes has informed GNSS studies that suggest sufficient signals are available for navigation at the Moon. Recent NASA publications:

- AAS GN&C 2019: “GPS Based Autonomous Navigation Study for the Lunar Gateway,” Winternitz et al.
- AAS GN&C 2018: “Exploring the Limits of High Altitude GPS for Future Lunar Mission,” Ashman et al.
- ION GNSS+ 2017: “New High-Altitude GPS Navigation Results from the Magnetospheric Multiscale Spacecraft and Simulations at Lunar Distances,” Winternitz et al.

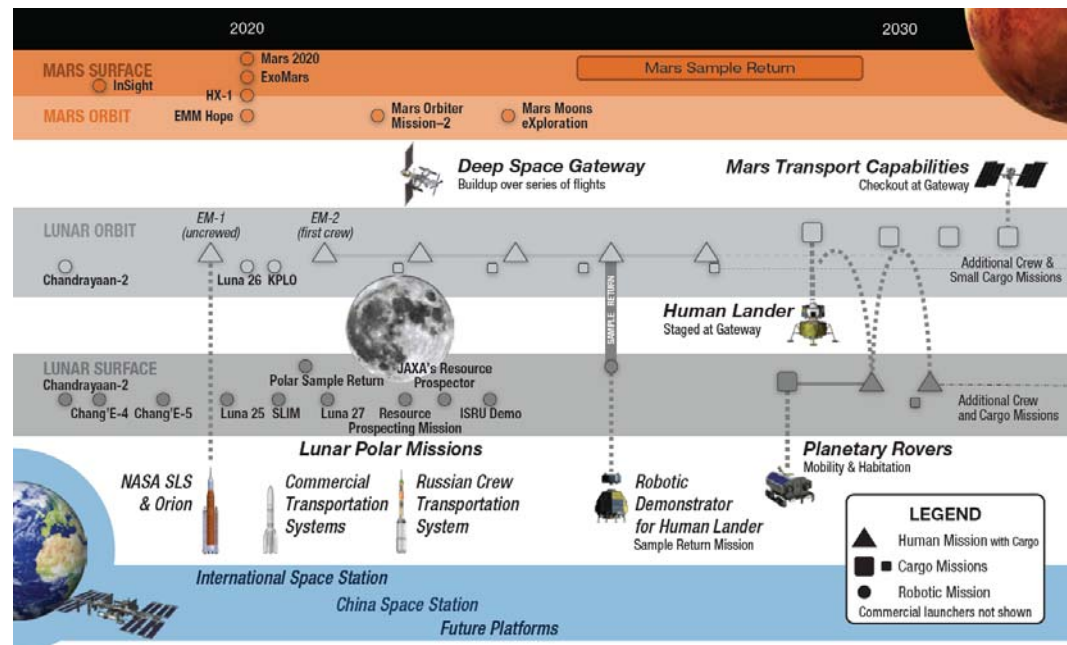

Future Applications: Lunar Missions

Ashman et al. 2018 lunar GPS study

- Near Rectilinear Halo Orbit (NRHO) is one proposed orbit for the Gateway; this is used here for the lunar simulation with only the outbound cruise
- Outbound lunar NRHO visibility with 22 dB-Hz acq/trk threshold:

Peak Antenna Gain	1+	4+	Maximum Outage
7 dB	63%	8%	140 min
10 dB	82%	17%	84 min
14 dB	99 %	65%	11 min

- A modest amount of additional antenna gain or enhanced GNSS receiver sensitivity increases coverage significantly

Winternitz et al. 2019 lunar GPS study

- MMS-like GPS navigation system with an Earth pointed high-gain antenna (~14dBi) would provide strong onboard navigation for Gateway
- Compared to using DSN: far fewer ground station tracking measurements available and much larger tracking gaps than with GPS tracking

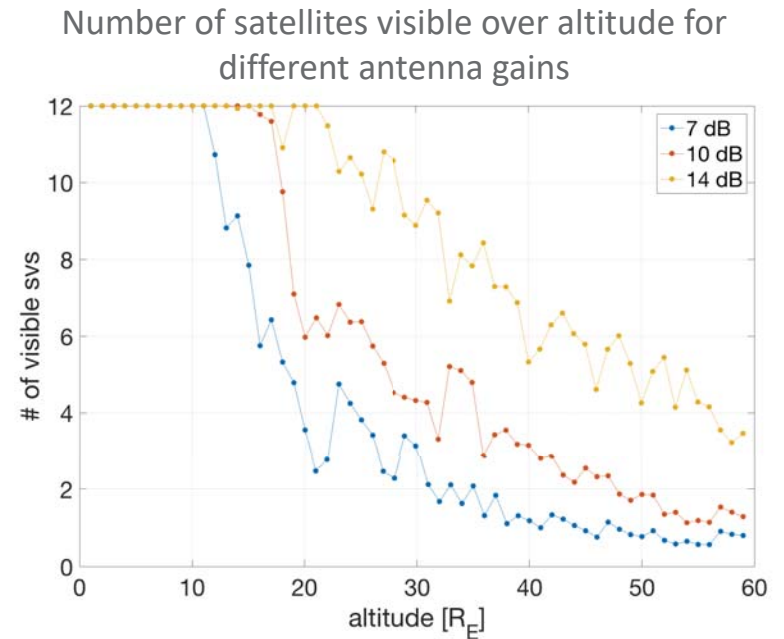

GPS signals tracked for one orbit period for one case from the simulation

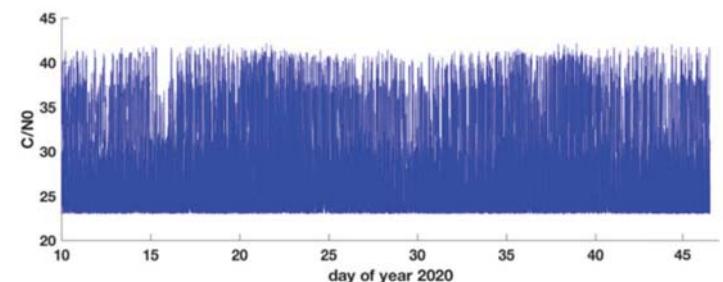
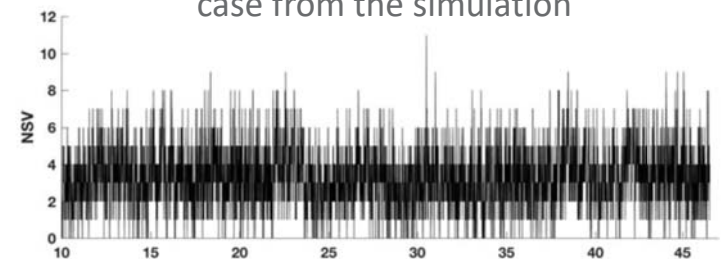

References

- Luke Winternitz, “Introduction to GPS and other Global Navigation Satellite Systems,” in *Proceedings of the 43rd Annual Time and Frequency Metrology Seminar*, Boulder, CO, 14 June 2018.
- James Garrison, *AAE575: Introduction to Satellite Navigation and Positioning*, Purdue University, Fall 2011.
- Pratap Misra and Per Enge, *Global Positioning System*, 2nd ed. Lincoln, MA: Ganga-Jamuna Press, 2005.
- Space Service Volume booklet published by the United Nations’ International Committee on GNSS:
http://www.unoosa.org/res/oosadoc/data/documents/2018/stspace/stspace75_0_html/st_space_75E.pdf

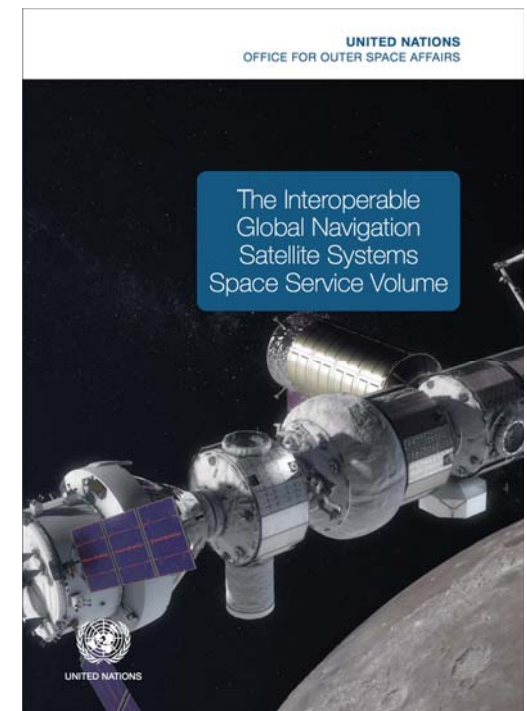
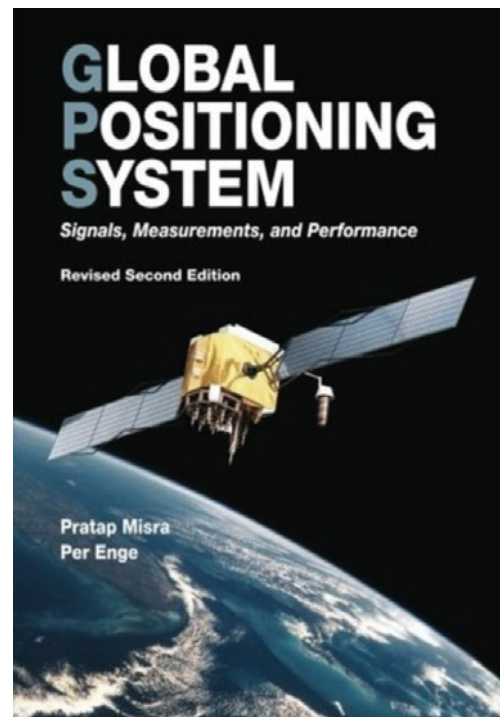



Benjamin Ashman, Ph.D.

Navigation and Mission Design Branch

Code 595, NASA Goddard Space Flight Center

Greenbelt, MD 20771

benjamin.w.ashman@nasa.gov

Image references

1. M. Pratap and P. Enge, Global Positioning System, 2nd ed. Lincoln, MA: Ganga-Jamuna Press, 2005.
2. https://mk0spaceflightnoa02a.kinstacdn.com/wp-content/uploads/2014/12/GPS_IIF.jpg
3. Luke Winternitz, "Introduction to GPS and other Global Navigation Satellite Systems," in Proceedings of the 43rd Annual Time and Frequency Metrology Seminar, Boulder, CO, 14 June 2018.
4. <https://www.gps.gov/multimedia/images/constellation.jpg>
5. <https://www.gps.gov/multimedia/images/GPS-control-segment-map.pdf>
6. <http://www8.garmin.com/aboutGPS/>
7. <http://www.elenageosystems.com/GNSS.aspx>
8. <https://natronics.github.io/blag/2014/gps-viz-1/>
9. <https://smd-prod.s3.amazonaws.com/science-blue/s3fs-public/thumbnails/image/EMS-Introduction.jpeg>
10. B. Ashman, "Incorporation of GNSS Multipath to Improve Autonomous Rendezvous, Docking, and Proximity Operations," Ph.D. dissertation, Purdue University, 2016.
11. M. Moreau, "GPS Receiver Architecture for Autonomous Navigation in High Earth Orbits," Ph.D. dissertation, University of Colorado, 2001.
12. http://insidegnss.com/wp-content/uploads/2018/01/IGM_janfeb12-Solutions.pdf
13. https://link.springer.com/chapter/10.1007/978-3-319-42928-1_6
14. http://www.navipedia.net/index.php/Transformations_between_Time_Systems
15. <https://youtu.be/DbYapFLJsPA>
16. https://en.wikipedia.org/wiki/Orbital_elements#/media/File:Orbit1.svg
17. B. Ashman, J. Parker, F. Bauer, M. Esswein, "Exploring the Limits of High Altitude GPS for Lunar Missions," AAS GN&C Conference, Breckenridge, CO, American Astronautical Society, February 2018.
18. J. Miller and J. Parker, "NASA GNSS Activities," International Committee on GNSS 12, Kyoto, Japan, December 2017.
19. G. McGraw, P. Groves, and B. Ashman, "Robust Positioning in the Presence of Multipath and NLOS GNSS Signals," Chapter 21 in 21st Century PNT, Jade Morton editor, 2018.
20. National Geographic March 2018

Image references (cont.)

21. <https://timeandnavigation.si.edu/navigating-at-sea/navigating-without-a-clock/celestial-navigation>
22. Winkler, S., Ramsey, G., Frey, C., Chapel, J., Chu, D., Freesland, D., Krimchansky, A., and Concha, M., "GPS Receiver On-Orbit Performance for the GOES-R Spacecraft," ESA GNC 2017, 29 May-2 Jun 2017, Salzburg, Austria.
23. By Persimplex - Own work, CC BY-SA 3.0, <https://commons.wikimedia.org/w/index.php?curid=18957671>
24. <https://www.gps.gov/systems/gps/modernization/civilsignals/>
25. Ashman B., Bauer F. H., Parker J., Donaldson J., "GPS Operations in High Earth Orbit: Recent Experiences and Future Opportunities," 2018 SpaceOps Conference, p. 2568, 2018.
26. Donaldson J., Parker J., Moreau M., Highsmith D., Martzen P., "Characterization of On-Orbit GPS Transmit Antenna Patterns for Space Users," 2018.
27. Shah, Rashmi, "GNSS-R," *IEEE GNSS+R 2019*
28. Yang et al., "Recent Advances in Remote Sensing of Natural Hazards-Induced Atmospheric and Ionospheric Perturbations", 2015 AGU.

GNSS science: radio occultation

- Radio occultation material from Oscar Yang (oscar.yang@jpl.nasa.gov)
- Concept: Ground-based Total Electron Content (TEC) measurements represent all perturbations along the line of sight (LOS) through the ionosphere

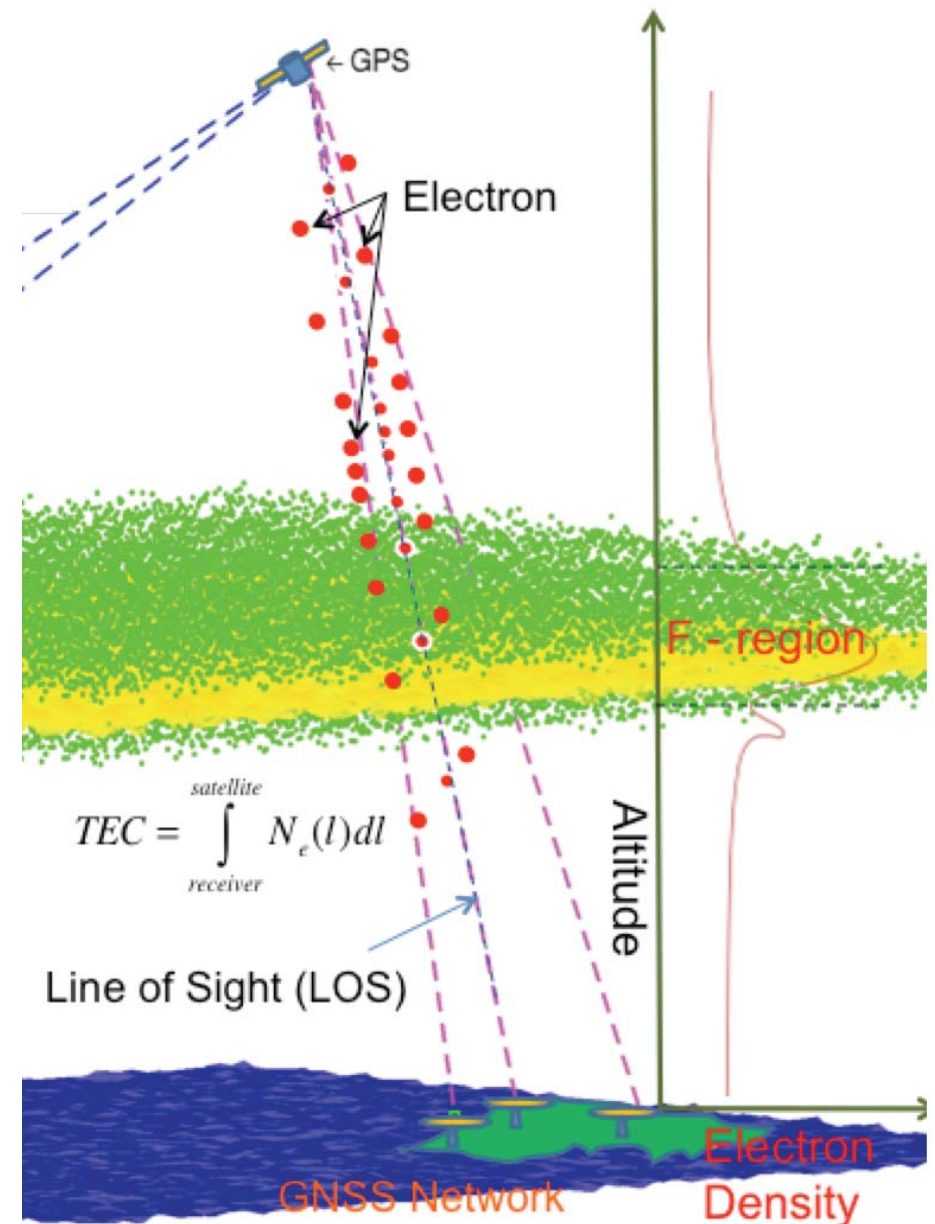

Ground-based measurement of ionospheric disturbance [28]

$TEC(t)$ & $\vec{r}_{ipp}(t)$ @ each sampling time.

$$TEC = \int_{receiver}^{satellite} N_e(l) dl$$

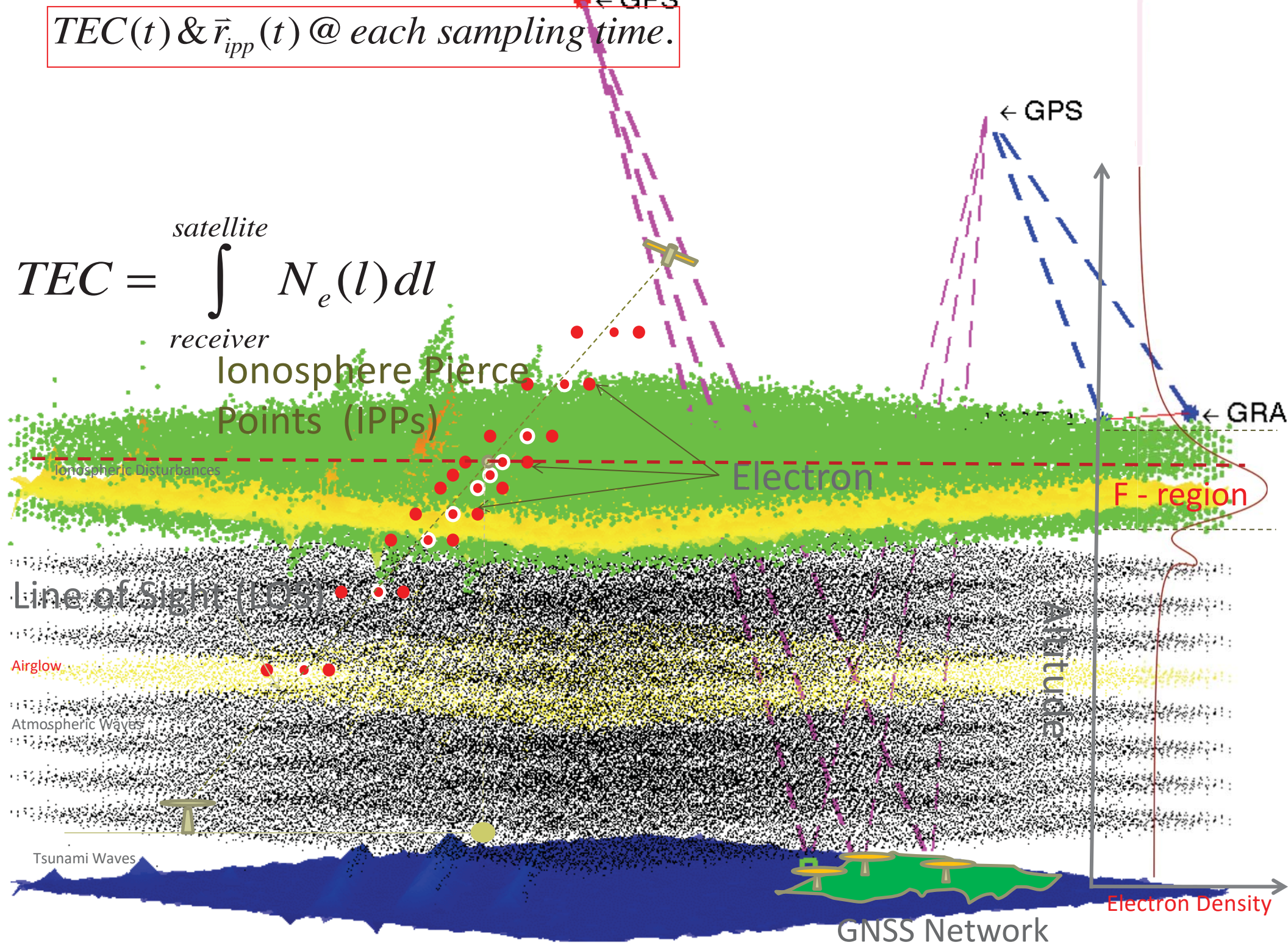

Recent Activities: GRACE

- Gravity Recovery and Climate Experiment (GRACE) measured gravity anomalies to show how Earth's mass is distributed over time, enabling study of the planet's ocean, geology, and climate
- NASA/JPL BlackJack GPS receiver modified to track gravity-sensing crosslinks, and to form star-camera solutions, while producing cm-level POD and 0.1 nanosecond relative time transfer
- Data significantly improved understanding of: the global water cycle, mass and energy exchange within and between the Earth System components, the changes in ocean mass, the changing dynamics of polar ice caps and large continental aquifers and improved the prospects for assimilation of mass change data into climate models

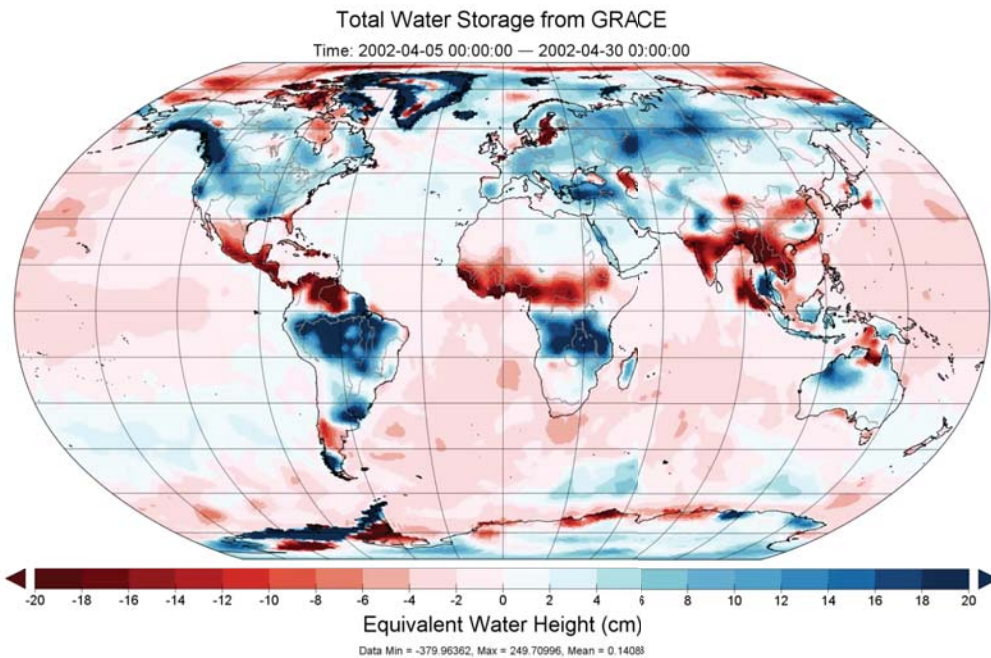

15 YEARS OF GRACE

2 satellites **137** miles apart
2,384,052,480 miles traveled

Ice loss measured

3,400 GIGATONS
GREENLAND

1,550 GIGATONS
ANTARCTICA

1 gigaton =
1 kilometer by
1 kilometer cube

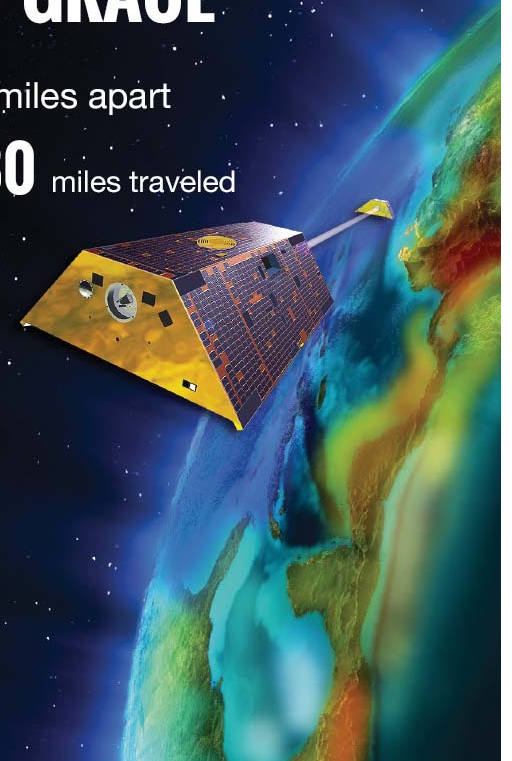

Planned Activities: Restore-L and PACE

Restore-L

- Launch date 2022, polar low Earth orbit
- Autonomous, real-time navigation system used for rendezvous
- Autonomous grasping with telerobotic refueling and relocation
- Propellant transfer system will deliver fuel to the client spacecraft at the right temperature, pressure, and rate



Plankton, Aerosol, Cloud, Ocean Ecosystem (PACE)

- Assesses ocean health through the distribution of phytoplankton and continues key measurements related to air quality and climate
- Launch readiness date: Fall 2022
- Sun-synchronous, polar orbit, 675 km orbital altitude
- Global coverage every two days

