

Free Space Optical Link Utilizing a Modulated Retro-Reflector Intended for Planetary Duplex Communication Links between an Orbiter and Surface Unit

Stephanie Booth*

NASA Glenn Research Center, Cleveland, Ohio, 44135

This paper presents simulation and experimental results that provide duplex optical-free space communication links with minimal power and pointing requirements by using a modulated retro-reflector (MRR) for planetary communications. For this design, the MRR resides on the surface of a planet or moon, where energy is scarce, while the source of the communication laser resides on an orbiter to achieve satellite-to-ground communications. Also, a simulated scenario using the Mars Reconnaissance Orbiter (MRO) is provided for real world potential results. The information sent through this communication path can range from raw scientific data to multimedia files such as videos and pictures. Bidirectional communications is established with the MRR by using a nested pulse position modulation (PPM) structure. This modulation scheme is then evaluated for its validity in a proof-of-concept experiment. Initial results indicate a promising return-link performance of at least 300 kbps in the nested arrangement.

I. Introduction

CURRENTLY, optical communications is the fastest known method of data transmission since optical bandwidth is much larger than its counterpart, radio frequency. [1] Nonetheless, optical communications face a few difficulties. First by using a narrow beam to achieve high signal to noise ratio, pointing becomes a problem. Second, optical utilizes very inefficient power sources via the laser, which is around 10% efficient. However, with today's technology, a modulated retro-reflector (MRR) can eliminate one of the inefficient power sources and resolve the pointing issue.

A MRR is a passive device that has two inputs and provides one output. It works in two basic parts. The first is the retro-reflector, which takes the laser beam and reflects the beam to return to its source at an inverse vector through an arrangement of mirrors. This has already been tested between the Earth and lunar surface, by placing retro-reflectors on the moon to test laser ranging. [2] Since the experiment was successful, it means that retro-reflectors can point accurately from far away distances with moving nodes. Earth was one of these nodes and is rotating at 400 meters per second! [3] The second part of a MRR is the modulator. This piece simply codes another message on top of the beam. Typical free space optical communications use two laser sources and modulate the data on their respective constant beam laser source. However, by utilizing an already modulated beam via MRR, duplex communications is achieved. This is beneficial because the MRR consumes only 1/10 of the power of the second laser that it replaces in a typical system. The comparison is shown in Figure 1.

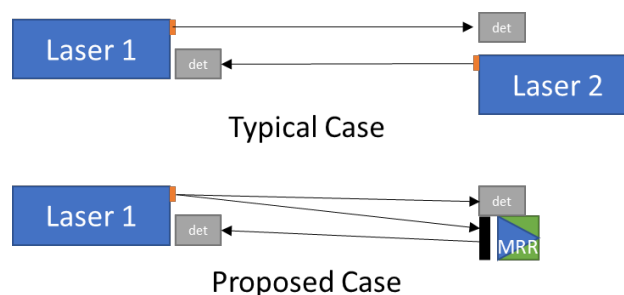

Fig. 1 Free Space Optical Communication Link Variations.

*Electronics Engineer

Reference [4] provides the calculation of a link budget system aligned with utilizing a MRR for planetary experiments. Depending on the operation, this link budget can show the data rates one can achieve. By placing values into the variables in the link budget, it shows the optical powers and atmospheric thicknesses are a few key variables that can make duplex planetary communications work. This paper summarizes results from the work performed in [5].

II. Proposed Scenario for Satellite Communications System

Using a MRR in a situation for satellite communications can be ideal in certain applications. Because the orbiter has greater capacity to replenish power quicker through its solar cells, the recommended method is to have the power source for the laser on the orbiter, which starts the communication connection. When the orbiter detects the surface unit on the planet below, a modulated beam transmits to that unit. The MRR modulates the already modulated beam and returns the signal to the original source, the orbiter. Therefore, the link going from the orbiter to the surface unit will be the downlink and the uplink is vice versa. With this design, the uplink will achieve a greater data rate than the downlink. Figure 2 shows this overview.

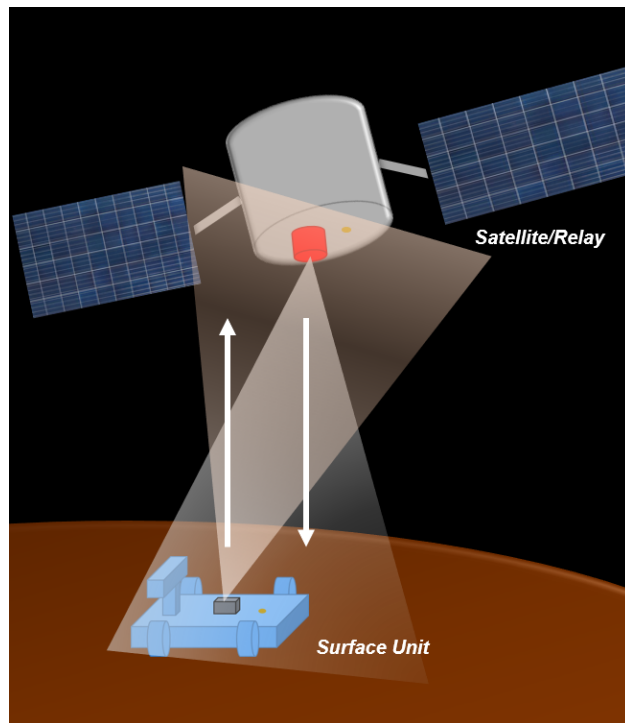

Fig. 2 Communication Scenario between an Orbiter and Surface Unit.

The left side of Figure 3 shows the orbiter's process of streaming data down or information to the surface receiver. The right side of Figure 3 is the receiver's data flow demonstrating its return path. Although the system is configured in two parts, since it uses the same channel, the system is duplex. If the data rates are high between the orbiter and surface unit, the link reaches simultaneous communication, assuming the hardware can maintain the desired data rate.

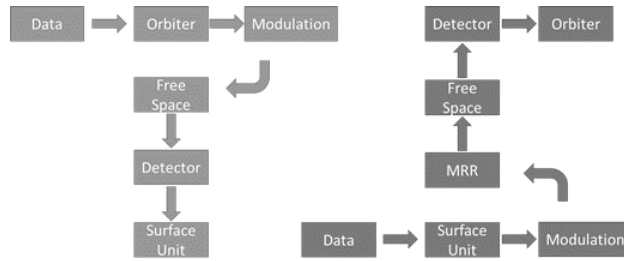

Fig. 3 Overall System.

III. The Modulation

The modulation scheme proposed for this system is a nested pulse position modulation (PPM) with a modulation index of 2 (PPM2). [6] A guard time slot is added to synchronize the two parts of the system. Due to the addition of the index and guard time, there are three slots. Arbitrarily decided, the first slot will be the guard time slot, allowing the two components the ability to synchronize with each other. The second slot is either a designated 1 or 0, with the third receiving the left over bit. When the downlink is transmitting data, it divides the data into binary and sends either a 1 or a 0. The laser is modulated with that 1 or 0 by giving the energy to the high bit in that 1 or 0 slot. When the laser is high, the detector informs the MRR that modulation can occur. Since each slot maintains a predetermined time gap, the MRR writes to transmit data only within that allowable time frame. If the MRR is unable to write, it will continue holding all of the queued information. The information can be the full set of data or a piece of the parsed data. This is shown by Figure 4, and will simulate a fractal.

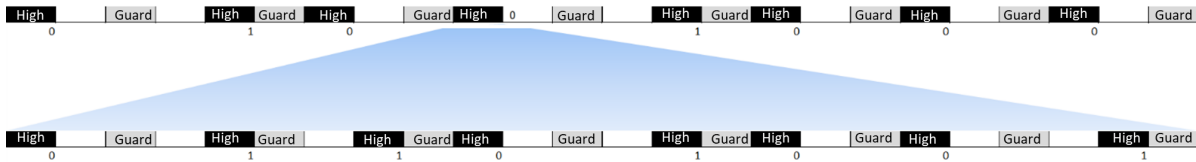

Fig. 4 PPM2 with Guard Time Example.

Due to the guard time, the detector on the ground must receive the first high pulse synchronizing the orbiter and ground unit. Once a specific amount of time has passed, the detector realizes that if the pulse remains on, it is a zero. If it turns off for a certain time and then on, meaning the high bit is in the third slot, the orbiter sends a 1. After many cycles, a binary message forms. However, since the MRR can send only on the high bits, the orbiter must send a random high value if there are no more messages queued. When the orbiter's detector gathers enough data, the message forms for the orbiter. Figure 5 shows that the downlink and the uplink are the same data rate.

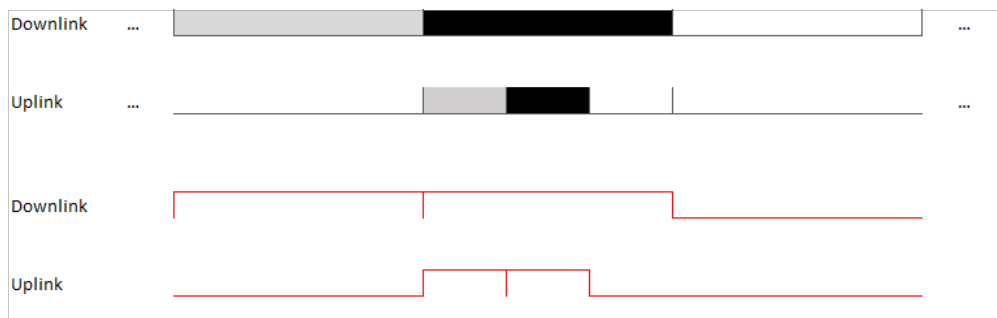

Fig. 5 PPM2 Timing.

IV. The Components for Simulation

The three main components of the scenario are as follows: the laser, the detectors, and the MRR. The laser can be any wavelength that the orbiter could be carrying but in this instance a 1550 nm laser was used. The detector is the same on the ground and on the orbiter because the detector must close the link. The type of detector selected for the system depends on the wavelength and modulation scheme. Based on the 1550 nm laser, the detectors would likely be avalanche photodiode detectors and therefore experience a gain of approximately 100. The aperture diameters on the orbiter and on the surface would be 10 cm and 2 cm, respectively. These aperture values were decided to not only narrow the beam, but to avoid pointing problems. The last key component is the MRR. It is a two input, one output device. One of the inputs is the free space optical link and the other input is the new data the MRR receives from the surface unit to be modulated. The MRR would have an aperture diameter and reflective surface roughness for the simulation of 2 cm.

The simulation has a few other mandatory inputs into the link budget calculation from [4]. The laser power for the link is 1 W meaning that the laser is a 10 W laser with 10 percent efficiency. Also, the target bit error rate (BER) will be 10^{-6} which is the average value for space communication systems. In terms of constants, the planetary irradiance and sky irradiance will be held at $0.00874 \text{ W/cm}^2/\text{sr}/\mu\text{m}$ and $0.0035 \text{ W/cm}^2/\text{sr}/\mu\text{m}$ respectively, which are the average day value for Mars. During the night they decrease to nearly zero. The calculated system has a downlink data rate of 150 kbps and an uplink data rate of double, 300 kbps.

V. Simulation

Mars Reconnaissance Orbiter (MRO) was the orbiter picked for the simulation. The simulation used Analytical Graphics Inc.'s System Tools Kit (STK) program and Jet Propulsion Laboratory's (JPL) binary space partitioning (BSP) files. The BSP files were MRO's aerobreaking values of where it was at specific times. STK took that data and created MRO's orbit. In the simulation, a facility simulated the surface unit. Figure 6 shows a picture from STK. The straight lines were due to STK connecting the data points from the BSP files.

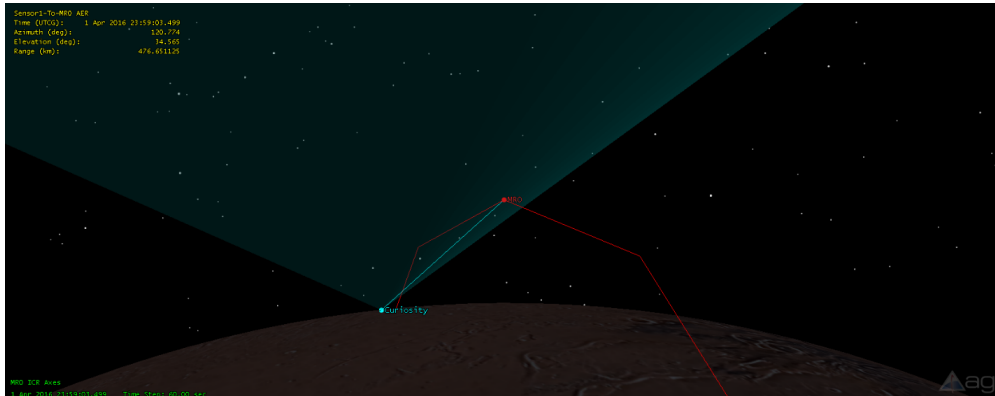

Fig. 6 STK Simulation.

The link budget verified that it is was necessary to have a 30-degree slant angle constraint. Anything below that constraint caused significant atmospheric loss. Of the simulation shown in Figure 7 of a random day, a red line shows the 30-degree angle constraint. Under a 30-degree angle from the orbiter and rover, the atmospheric absorption and scattering losses were at a -2 dB loss which means a total of -4 dB loss just through the atmosphere. This meant that on a random day, of the 45.85 minutes the two objects see one another, they could only communicate approximately 6.55 minutes, see Figure 7.

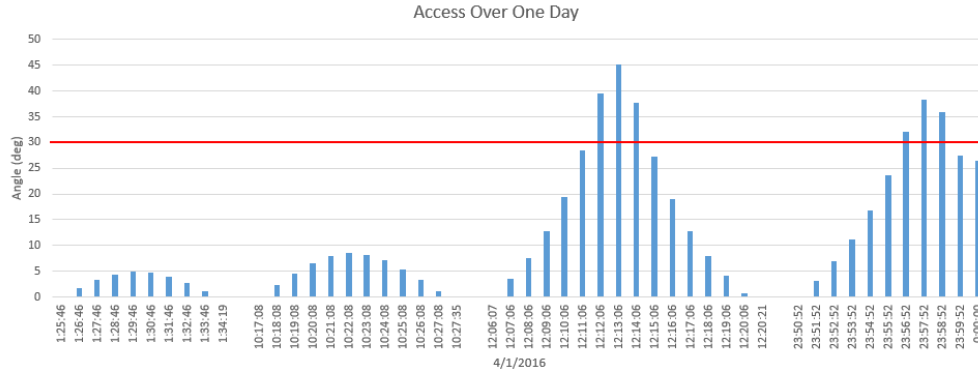

Fig. 7 Orbiter and Surface Unit Contact Times.

Taking the range values within the allotted angle frame, only about 6 minutes of a week has a BER better than the 10^{-6} constraint previously indicated. It seems like a very short time frame but the data rate could increase significantly during that time because there is enough margin to maintain 10^{-13} BER.

VI. The Components for Experiment

In the proof-of-concept experiment, a few parts needed to be changed from the simulation. First, the detector used is a high-speed photodiode detector from ThorLabs, specifically the DET10A. Second, the MRR will be changed to a liquid crystal shutter and a mirror. Since the distance is considerably short, the MRR would return a beam too narrow to reach the orbiter's detector. The beam would return to the fiber optic cable. Therefore, the shutter and mirror together will still achieve modulating on the already modulated beam. In this experiment, a 635 nm red laser was used to aid with system alignment.

There are other minor pieces of equipment for the experiment. These are: the voltage amplifiers, collimator, beam splitter, and fiber optic cable. The voltage amplifiers are important to raise the signal level to a one or a zero in the data sequence that could be sent. The full system requires a transimpedance amplifier, but here, the transimpedance amplifier is a part of the photodiode detector. The voltage amplifier is a simple noninverting amplifier with a gain for keeping the registered result in an Arduino digital pin to be only a one or a zero. The experiment also used a collimator to maintain optical power. In addition, to send the modulated beam to the detector on the surface unit and through the liquid crystal shutter to be remodulated, a beam splitter was present. A fiber optic cable is used as the last piece of hardware that is needed to make the laser more accessible.

For initializing and bit retrieval, the experiment used two Arduinos: an Arduino Uno and an Arduino Mega 2560. These Arduinos are a slightly different configuration, however, they have the same clocking crystal for fewer complications. The two Arduinos synchronize by performing a preamble code at the beginning.

VII. Experimentation

Figure 8 is the final configuration for proving that a nested pulse position modulation scheme is available for potential planetary optical communication links. The block diagram is shown in Figure 9. The left side simulates the orbiter and the right side of the picture simulates the surface unit. A beam splitter is on the surface unit side to be more realistic. Having a beam splitter on the surface unit side will allow the orbiter to change its distance and not affect alignment to the shutter and detector on the surface unit.

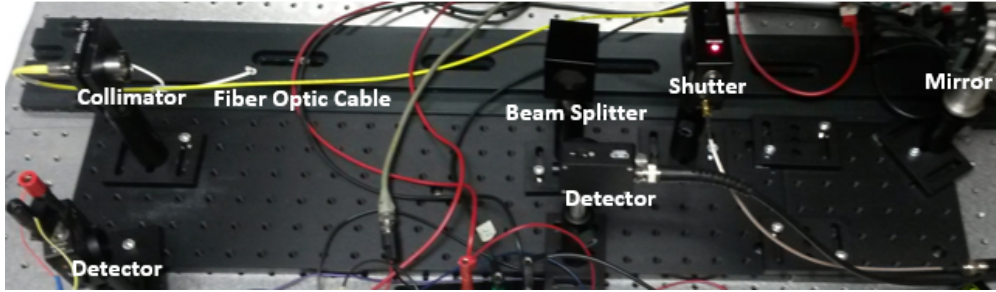

Fig. 8 Final Setup.

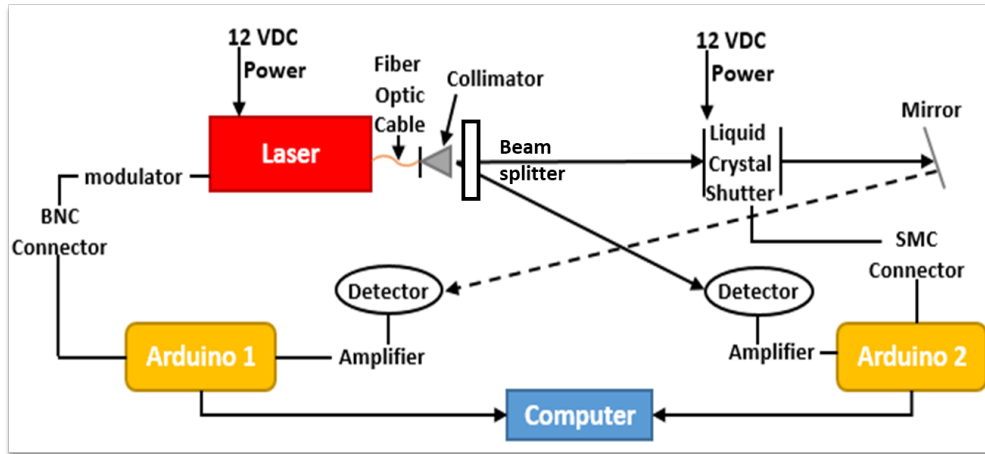

Fig. 9 Block Diagram of Experiment.

In Figure 9, both Arduinos are shown connected to the same computer. In reality the Arduinos would not because, there will be substantial distances between the two sides. However, in this small experiment all the data transfers were easier to see through the same computer as the data arrived.

The software was configured and tested by sending one bit from the orbiter and waiting for three bits received from the surface unit, as shown in Figure 10. Bit values shown in Figure 10 were arbitrary random zeros and ones to prove that the system is able to handle bit changing. This means the laser switches on and off or vice versa, and stagnate numbers for a duration without increased errors seen within the results. During initial testing, it was discovered that a preamble was necessary to synchronize the two Arduino clocks. This preamble was a send and receive data stream sequence with confirmation on both Arduinos before the code could start transmitting meaningful data. In future work, the Arduinos will go back to this function to remain synchronized.

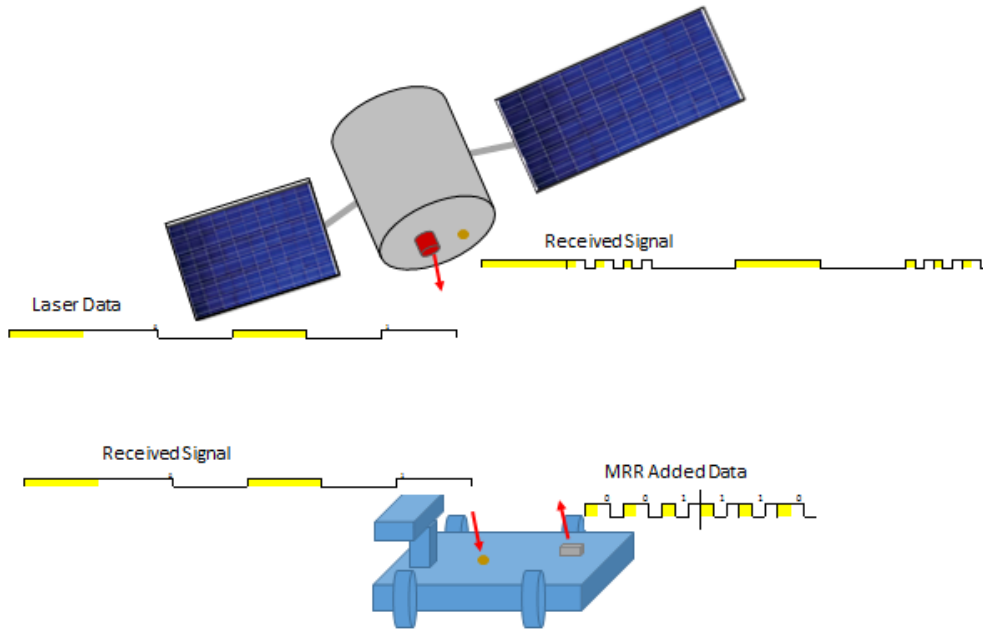

Fig. 10 Modulation Scheme with Bit Transfer.

By simulating the scenario with the experiment, the results are acceptable. In this case, looking at Figure 11, COM5 was the Arduino Uno, which represented the surface unit, and the orbiter was on COM8, with the Arduino Mega 2560. As one bit was sent, there were three bits received by the orbiter from the surface unit without an error. The beginning lines within the figure is the preamble that was set. In this figure, what was sent from the orbiter was a 1011 repetitively and the surface unit was coded to send back a 011 within each original sent bit. This proves that the nested pulse position modulation scheme does work to have communications with an orbiter and surface unit with only one source of optical power.

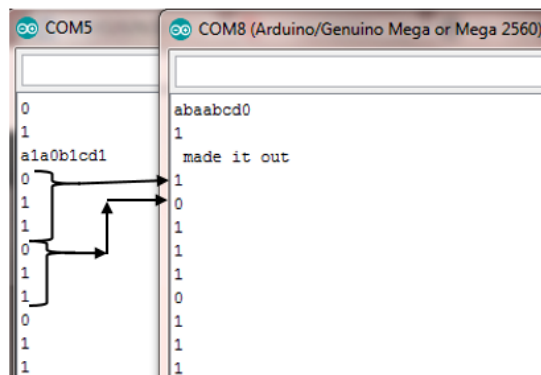

Fig. 11 Proof of Results.

VIII. Conclusions

This paper provided simulation and experimental results from a Mars scenario of an orbiter communicating to a limited power surface unit. The system achieved this by using a MRR and nested pulse position modulation. The simulation provided a promising return-link performance of at least 300kbps and the experiment was successful within the acceptable BER.

The results create the illusion that this system is possible but initially non-ideal. However, the simulation results can be improved since variables were valued as not best case to prove that even in poor conditions, there is still effective

communication that happens. Therefore, the proposed setup is feasible to work in small mobile low power situations. In truth the data rate was better than what Electra, the radio antenna for communications on MRO, does currently. [7] Future work should see how much the system would perform if the data rate was lowered to Electra and if the uplink data rate was not double that of the downlink data rate.

Acknowledgments

I would like to thank Daniel Raible for the idea, his help, and his encouragement. Also, to Alan Hylton for his extreme support throughout the project.

References

- [1] Crew, B., "Scientists Just Set The Record For The Fastest Data Transmission Rate EVER," *Science alert*, February 2016. URL <https://www.sciencealert.com/scientists-have-just-set-the-record-for-the-fastest-ever-data-transmission-rate>.
- [2] Grubbs, R., "View of the Laser Ranging Retro Reflector deployed by Apollo 14 astronauts," *NASA Image and Video Library*, , No. as14-67-09386, February 1971. URL <https://images.nasa.gov/details-as14-67-09386.html>.
- [3] Herman, R., "How fast is the earth moving?" *Scientific American*, 2019. URL <https://www.scientificamerican.com/article/how-fast-is-the-earth-mov/>.
- [4] Booth, S., and Manning, R., "Optical Communication Link Assessment Utilizing a Modulated Retro-Reflector on Mars," , No. NASA/TM-2018-219977, November 2018.
- [5] Booth, S., "Characteristics of an Optical Communication Link for Mars Utilizing a Modulated Retro-Reflector," , December 2017.
- [6] Xu, F., Khalighi, M. A., and Bourennane, S., "Pulse position modulation for FSO systems: Capacity and channel coding," *2009 10th International Conference on Telecommunications*, 2009, pp. 31–38.
- [7] "Data Rates>Returns," *Jet Propulsion Laboratory*, 2017. URL <https://mars.jpl.nasa.gov/msl/mission/communicationwithearth/data/>.