

Human Health and Performance

Presenter: Andrew Abercromby (NASA JSC)

- **Crew Health & Performance EVA Roadmap Status**
- **HH&P Technical Summary**
 - Human Physiology, Performance, Protection & Operations (H-3PO)
 - Anthropometry & Biomechanics Facility (ABF)
- **HH&P xEMU Priorities**



Crew Health & Performance EVA Roadmap



- Purpose: Multi-year roadmap of development & testing activities associated with CHP EVA Gaps
- Updated & published annually since 2016
- Program agnostic
- Most recent version published May 2019
<https://www.nasa.gov/suitup/reference>
- Initial 2020 update completed December (alignment with Artemis)
 - Full update currently underway
 - Renamed Crew Health & Performance EVA Roadmap

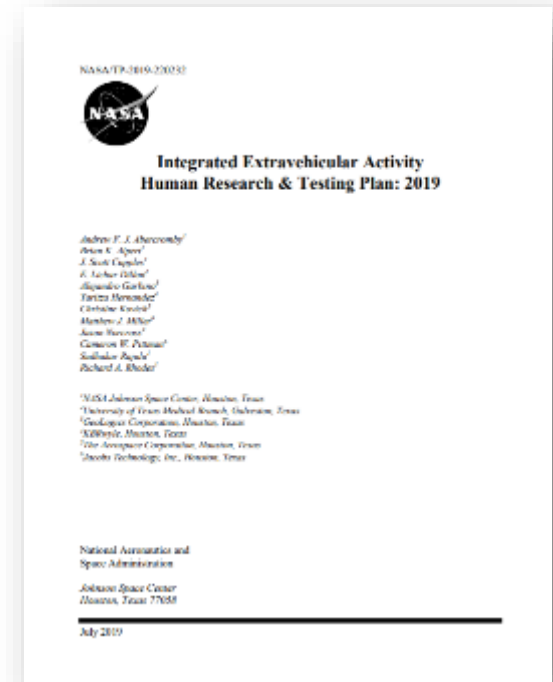



DRAFT

CHIP EVA Roadmap			2016	2017	2018	2019	2020	2021	2022	2023	2024	2025	2026
			FY16	FY17	FY18	FY19	FY20	FY21	FY22	FY23	FY24	FY25	FY26
EVA MILESTONES													
EVA SMT Gap	Human System Gap	CHIP EVA Gap											
CHIP.EVA.CREW: EVA Crew Required Capabilities													
EVA-GAP-88	EVA-6	CHIP.EVA.PHYS: EVA Physiological & Performance Capabilities	Fitness for Mission Tasks			Impaired EVA: Returning ISS Crew							
CHIP.EVA.SUIT: EVA Suit Design for Health & Performance													
EVA-GAP-89	EVA-7	CHIP.EVA.SUIT: EVA Space Suit Design Parameters & Testing	Microgravity Benchmarking		Planetary Standard Measures		Planetary Metabolic Rates 1		Planetary Met Rates 2				
			Mini-Workstation Int. & Testing					Mass & CG Sensitivity					
			Airlock Rear-Entry-Suit Testing					Suit Pressure 1		Suit Pressure 2 (if needed)			
			Z2 NBL	Z2.5 NBL	Human Loads		xEMU DVT Testing	xEMU Qual Testing					
			IIPEG				Unpublished EVA Data Archiving & Utilization						
CHIP.EVA.CONOPS: EVA Conops for Health & Performance													
EVA-GAP-92	EVA-9	CHIP.EVA.CONOPS: Exploration EVA Tasks & Concepts of Operations	<p style="text-align: center;">HHIP EVA Tasks & ConOps</p> <p style="text-align: center;">Physical And Cognitive Exploration Simulations (PACES)</p> <p style="text-align: center;">Artemis EVA Tools</p> <p style="text-align: center;">Assessments of Physiology And Cognition in Hybrid-reality Env. (APACHE)</p> <p style="text-align: center;"> Workload & Duration <i>1. Initial Lunar APACHE Suited</i> <i>2. Lunar Long-Stay APACHE Suited</i> </p> <p style="text-align: center;">BASALT</p> <p style="text-align: center;">SILYRL</p> <p style="text-align: center;">Incap. Crew Rescue</p> <p style="text-align: center;">Pilot SPOC Scientific Field Work Characterization</p>										
CHIP.EVA.PHYS: EVA Physiological Inputs & Outputs													
EVA-GAP-91	EVA-8	CHIP.EVA.MODEL: Integrated EVA HHIP Model	Inspired CO2			Integrated EVA HHIP Model							
						Metabolic Rates	CO2: DCS	Heat Storage: Hydration	Nutrition	Physical & Cognitive Fatigue			



DRAFT

CIIP EVA Roadmap			2016	2017	2018	2019	2020	2021	2022	2023	2024	2025	2026										
			FY16	FY17	FY18	FY19	FY20	FY21	FY22	FY23	FY24	FY25	FY26										
EVA MILESTONES																							
EVA SMT Gap	Human System Gap	CIIP EVA Gap																					
CHP.EVA.INFO: EVA Informatics for Health & Performance																							
EVA-GAP-93	EVA-10	CHP.EVA.EOS: EVA Informatics and Software for Cognitive Decision Support	Blomed Reqt			EVA Operations System Development																	
						EOS 1.0			EOS 2.0			EOS 3.0			EOS 4.0			EOS 5.0					
						Baseline Eval			1.0 Eval			2.0 Eval			3.0 Eval			4.0 Eval			5.0 Eval		
						EOS NBL, Analog & MCC Deployment & Testing																	
						NBL Met Rate Informatics			1.0 NBL			2.0 NBL			3.0 NBL			4.0 NBL			5.0 NBL		
						1.0 MCC			2.0 MCC			3.0 MCC			4.0 MCC								
			Field Analog Testing																				
CHP.EVA.FIT: EVA Suit Sizing & Fit																							
EVA-GAP-90	EVA-7B	CHP.EVA.FIT: Space Suit Sizing & Fit	Proteus Model: xEMU HUT			Proteus: Planetary LTA			Proteus: Arms			Proteus: In-flight Anthro Changes											
			xEMU HUT Fleet Sizing Analysis			Planetary LTA Fleet Sizing Analysis			xEMU Arms F/sizing Analysis			xEMU In-Flight Anthro Analysis											
			xEMU HUT Fleet Sizing Validation			Planetary LTA Fleet Sizing Validation			xEMU Arms Fleet Sizing Validation														
			Customized Human Shape in CAD																				
			Body Measures																				
			Anthropometry Database																				
Scanner Validation																							
			Objective Suit Fit Sensors			Human-Suit Interaction Sens.																	
CHP.EVA.INJURY: EVA Injury Risk & Mitigation																							
EVA-GAP-94	EVA-11	CHP.EVA.INJURY: EVA Injury Risk & Mitigation	Implementation			Suit Exposure Tracking: Ongoing Monitoring & Analysis																	
			Injury Data Mining																				
			NBL Ergo Evals																				
			Planetary EVA Injury Mechanisms																				
						Follow-On Planetary EVA Injury Tasks (EVA Injury Roadmap In Work)																	
			Biomechanical Model: xEMU (EVA Injury Roadmap In Work)																				
CHP.EVA.DCS: EVA Exploration Prebreathe																							
EVA-094	DCS 1-7	CIIP.EVA.DCS: Exploration Prebreathe Protocols	ExPrebreathe Trade Study			10.2 psi Prebreathe Validation			Variable Pressure Model Development & Validation														
			ExAtm Prebreathe			14.7 psi Prebreathe Validation																	

Crew Health & Performance EVA Gaps



CH&P Gap Title	CH&P SMT Gap ID	EVA SMT Gap No	CH&P Gap Wording
EVA Crew Required Capabilities	CHP.EVA.CREW	EVA-Gap-88	The physiological and cognitive performance capabilities that will be required of crewmembers during exploration EVA are not adequately understood.
EVA Suit Design for Health & Performance	CHP.EVA.SUIT	EVA-Gap-89	The effects of suit design parameters on crew health and performance (physical and cognitive) during exploration EVA are not adequately understood.
EVA Suit Sizing & Fit	CHP.EVA.FIT	EVA-Gap-90	The effects of EVA suit sizing and fit on crew health, performance, and injury risk are not adequately understood.
EVA Physiological Inputs and Outputs	CHP.EVA.PHYS	EVA-Gap-91	The physiological inputs and outputs associated with EVA operations in exploration environments are not adequately understood.
EVA ConOps for Health & Performance	CHP.EVA.CONOPS	EVA-Gap-92	The effects on crew health & performance (physical & cognitive) of variations in EVA task design and operations concepts for exploration environments are not adequately understood.

Crew Health & Performance EVA Gaps

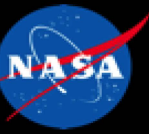

CH&P Gap Title	CH&P SMT Gap ID	EVA SMT Gap No	CH&P Gap Wording
EVA Informatics for Health & Performance	CHP.EVA.INFO	EVA-Gap-93	The knowledge and use of real-time physiological, system, and operational parameters during EVA operations to improve crew health and performance (physical & cognitive) is not adequately understood.
EVA Injury Risk & Mitigation	CHP.EVA.INJURY	EVA-Gap-94	The risk of crew injury due to exploration EVA operations and methods for mitigating that risk are not adequately understood.
EVA Exploration Prebreathe	CHP.EVA.DCS	EVA-Gap-95	The decompression sickness (DCS) mitigation strategies and associated impacts on mission timelines, consumables, and the design of EVA and habitat systems for exploration missions are not adequately understood.



Human Health and Performance Anthropometry and Biomechanics Facility

Presenter: Karen Young (Leidos)

Han Kim (Leidos)

Elizabeth Benson, Yaritza Hernandez, Eduardo Beltran, Alex Gordon (KBR)

Linh Vu, Sarah Jarvis (MEIT)

Sudhakar Rajulu (NASA JSC)

Anthropometry and Biomechanics Facility (ABF) Overview



The ABF helps to ensure that crewmembers of all sizes have hardware that fits them and allows them to work as safely and effectively as possible in an extremely challenging environment.

Classification of size and shape of *current* crew

Ergonomics analysis of suited designs and tasks

Prediction of size and shape of *future* crew

Reach envelope analysis (maximal and usable)

Virtual and physical hardware fit checks

Analysis of human-induced loads on the suit

Hardware accommodation analysis

Field of view assessment

Design recommendations to improve fit

Center of mass analysis and assessment

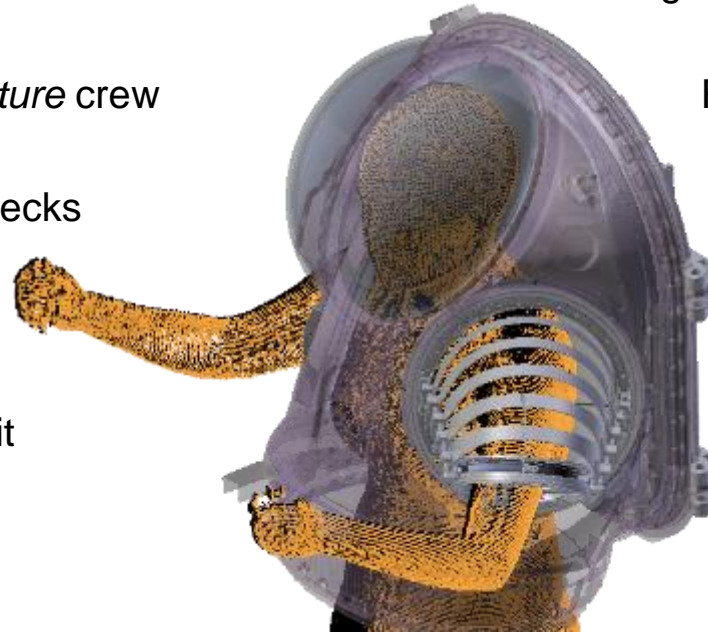



Developed computational models to predict suit fit probability and proportion of accommodation for the current and future crew population

- A virtual model was created for both the Hard Upper Torso (HUT) and the Lower Torso Assembly (LTA) brief
- The LTA brief dimensions were updated and optimized to maximize population accommodation.
- Multi-component interactions for population fit are being modeled and tested, as fit and mobility may differ when multiple components are combined.

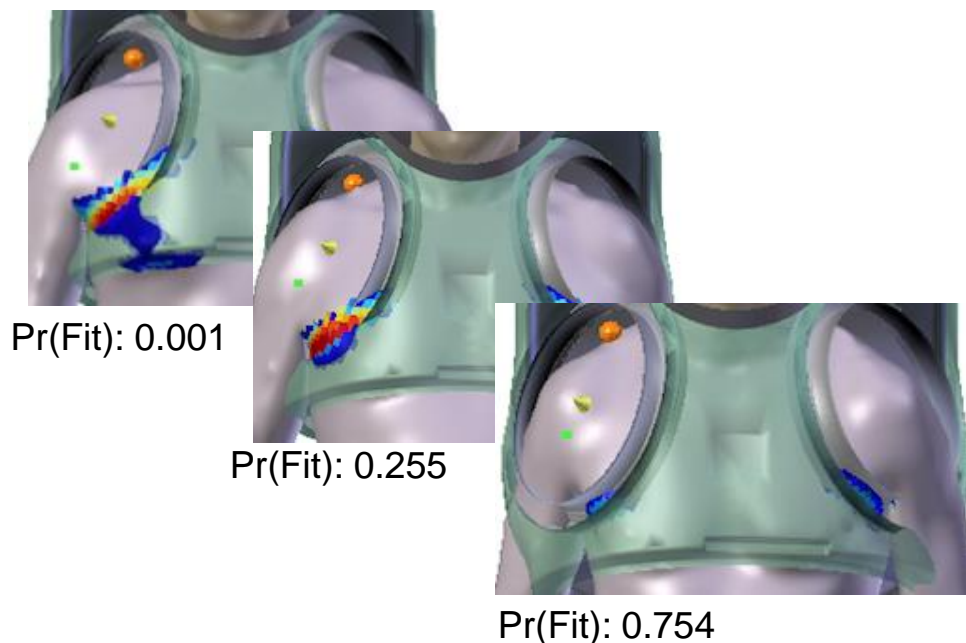

Fit Probability Prediction for HUT



Fit modeling for LTA



Multiple Component Interactions

Suit-to-Body Contacts for Sizing and Fit

CH&P Gap Title	EVA SMT Gap No
EVA Suit Sizing & Fit	EVA-Gap-90



- The maximum level of acceptable skin compression was measured for people of different anthropometry. The results were compared and incorporated with a suit-to-body overlap analysis.
- Subjective perception of suit-to-body contact was measured from the fit and sizing test subjects. The outcome can provide critical regions and magnitudes of suit-to-body contact associated with individual preference of fit.
- The influence of liquid cooling garments was assessed for fit and perception of suit-to-body contacts.

Maximum Tolerable Skin Compression

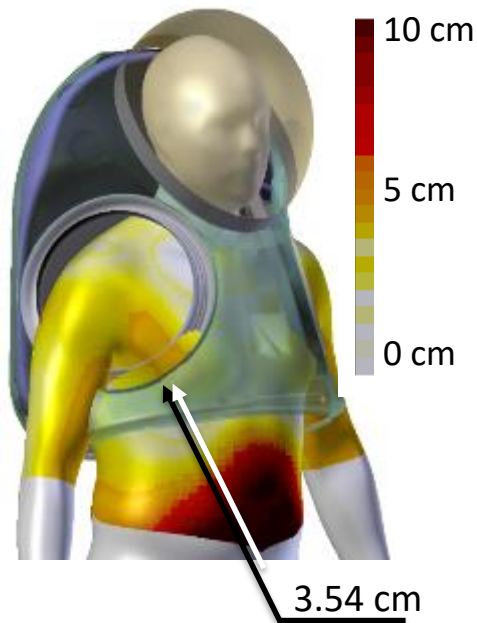

Suit-to-Body Geometry Overlap

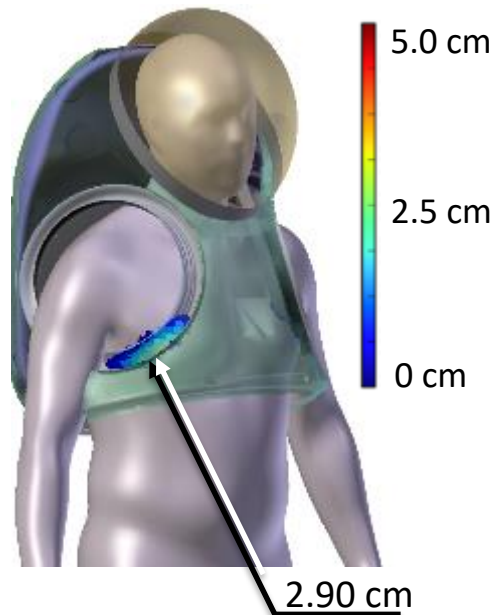

Perceived Suit Contact



Isolation of LCVG Effects

Assessment of head mobility for spacesuit field of view predictions

- Estimated the distribution of the eye positions within the helmet across a wide range of population.
- Assessed the head mobility and range of motion while wearing a HUT.
- Field of view was estimated within a helmet. The outcome can help to determine where the crewmember can or cannot see while wearing a suit.

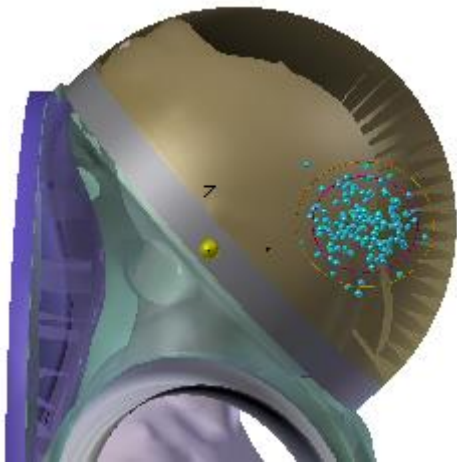

Eye Position Statistics

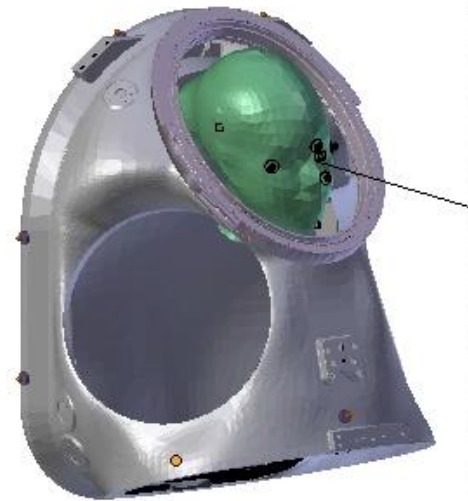

Head Mobility Testing in xEMU HUT

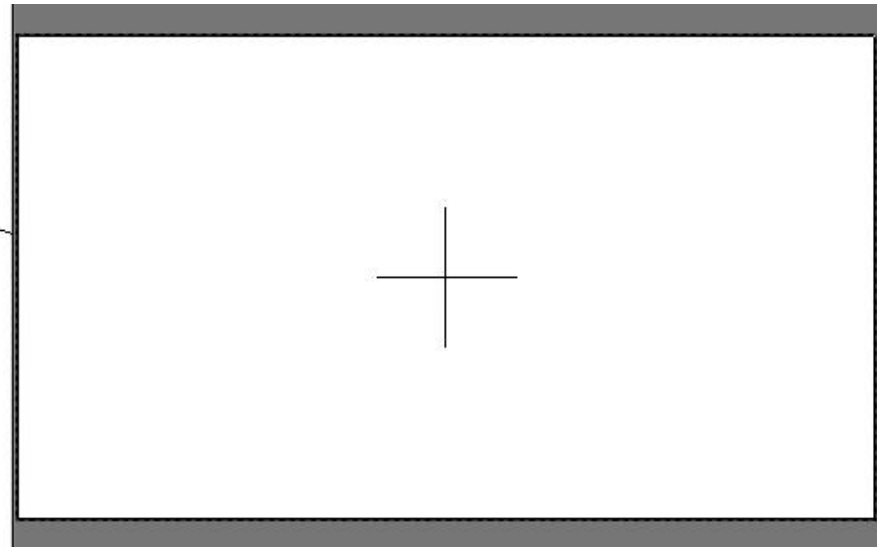

Simulated Field of View



Mid-Eye Range of Motion within Helmet

Exploration EVA Injury Risk



- Characterize, surveil, predict, mitigate and prevent EVA-related injuries in the xEMU
- A series of stakeholder meetings in December 2019 reviewed current injury mechanisms and risks, and predicted those for planetary EVA
- A draft injury prevention roadmap was briefed to a community of academia and stakeholders at a Technical Interchange Meeting January 31st
- The next stage is implementation

Hardware Design

Human Loads Mitigation

Suit Assessment and Design

Tool and Vehicle Design

Operations

Crew Selection

Task Design

Training

Communication

Tiger Team

Embedded Advisors

EIS Briefings

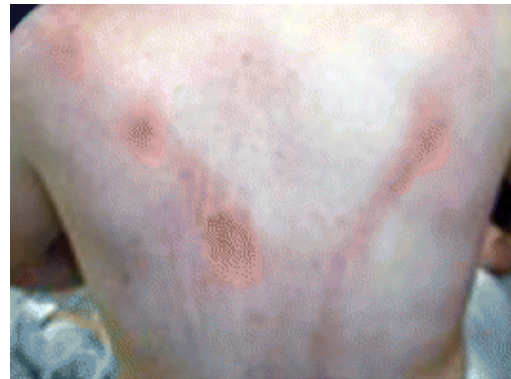
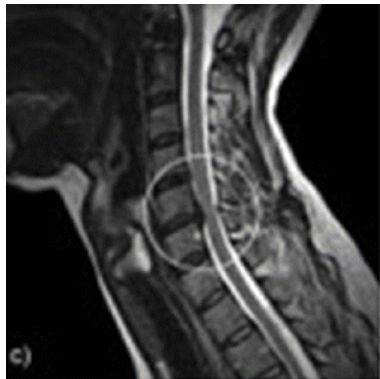

Ergonomics Stresses from Planetary EVA

CH&P Gap Title	EVA SMT Gap No
EVA Injury Risk & Mitigation	EVA-Gap-94



There are musculoskeletal loads and possible ergonomic concerns during planetary EVA, due to the suit's mobility constraints and added mass

- Information on suited loads and ergonomics challenges can be used to inform EVA training, tasks, and tool design
- Musculoskeletal loads of the body inside of the suit can be measured with different wearable sensor systems
 - Initial hardware testing has been done in a low-fidelity MKIII suit mockup
- Suit joint cycles and torques can be quantified across different movement strategies and tasks using a reusable 3-D suit model

Lumbar Torque



Sensor Garment



Low-Fidelity Mockup Suit

Estimation of EVA Posture from Photographs



A technical framework was developed to estimate 3-D posture of a spacesuit from photographs or videos

- Iteratively searches a database of suit postures which maximizes the overlap with the photographs

Applications

- Can be used during NBL and ARGOS testing to evaluate suit kinematics and ergonomics
- Retrospective analysis of the past EVA video for mobility and task assessments
 - Informs types and frequency of EVA motions

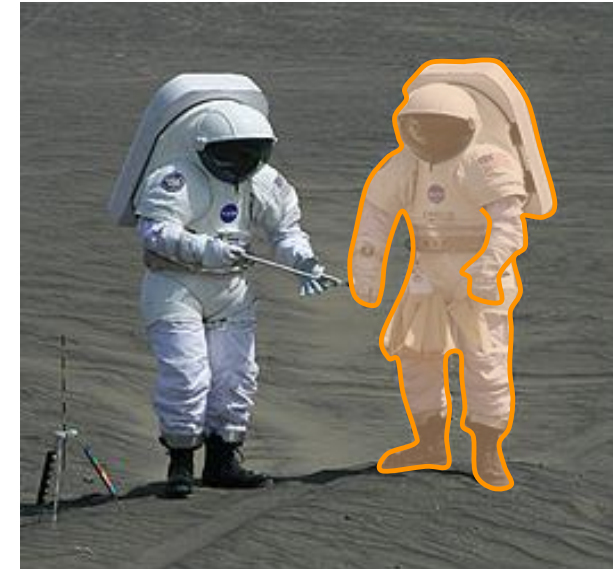

CH&P Gap Title	EVA SMT Gap No
EVA Injury Risk & Mitigation	EVA-Gap-94
CH&P Gap Title	EVA SMT Gap No
EVA Suit Design for Health & Performance	EVA-Gap-89

Suit Loading Analysis

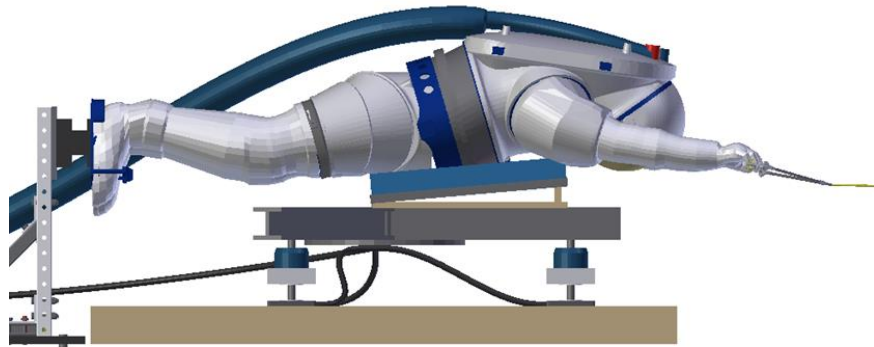

Satellite Handling Man-Loads Assessment

This task will assess the loads taken on by the suit hardware during one of the more extreme use cases: satellite deployment in microgravity



Suit Doffing Loads Analysis

This task will assess the loads imparted into the suit while a person is extracting themselves via the rear hatch

CH&P Gap Title	EVA SMT Gap No
EVA Suit Design for Health & Performance	EVA-Gap-89

Human Performance with Balance Constraints in Mockup Suit

Proof-of-concept test bed developed for balance and performance while wearing a mockup suit

- MKIII mockup suit used for testbed development
- Enabled testing with different geometric and mobility constraints of the suit and obstacles in the environment
- The implementation allows cost-and-time-effective proof-of-concept evaluations
- Methodically manipulate suit conditions (i.e., center of gravity, visual input)
- Use VR technology to assess training efficacy for visual-vestibular adaptation
- Iterative platform for Lessons Learned:
 - Suit modifications
 - VR programming

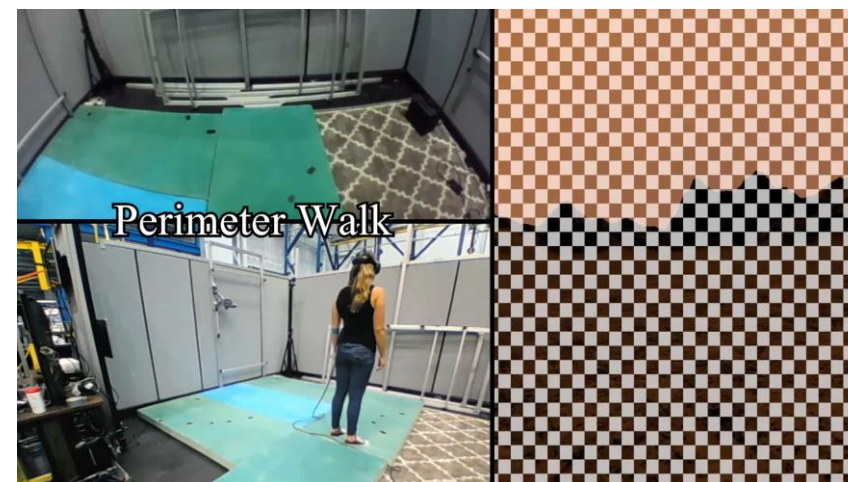

CH&P Gap Title	EVA SMT Gap No
EVA Crew Required Capabilities	EVA-Gap-88



Human Health and Performance

Human Physiology, Performance, Protection & Operations (H-3PO)

Presenter: Jocelyn Dunn (KBR)

Exploration Prebreathe Validation



- Exploration atmosphere (8.2 psia, 34% O₂) will enable high efficiency planetary EVAs by reducing prebreathe resources
- Human testing on schedule for July 2020 (first run, n=6 subjects)
- Validation of 10.2 psia, 26.5% O₂ (or similar) protocol planned for FY21



SAT	0000	0100	0200	0300	0400	0500	0600	0700	0800	0900	1000	1100	1200	1300	1400	1500	1600	1700	1800	1900	2000	2100	2200	2300	2400
8.2psia 134% O ₂	SLEEP (8.0 HRS TOTAL)						Postsleep-1.5 hrs	PMC & DPC	EVA Prep (excl. PB)	Prebreathe	EVA (8 HRS)								Post-EVA Overhead	Meal (60 mins)	PMC & DPC	Presleep - 1.5 hrs	SLEEP		
10.2psia 26.5% O ₂	SLEEP (8.0 HRS TOTAL)				Postsleep-1.5 hrs	PMC & DPC	EVA Prep (excl. PB)	Prebreathe (3.5 HRS)		EVA (8 HRS)								Post-EVA Overhead	Meal	PMC & DPC	Presleep - 1.5 hrs	SLEEP			
14.7psia 121% O ₂	Postsleep-1.5 hrs	PMC & DPC	EVA Prep (excl. PB)	Prebreathe (7 HRS)						EVA (8 HRS)								Post-EVA Overhead	Meal	PMC & DPC	Presleep - 1.5 hrs	SLEEP (2.5 HRS TOTAL)			

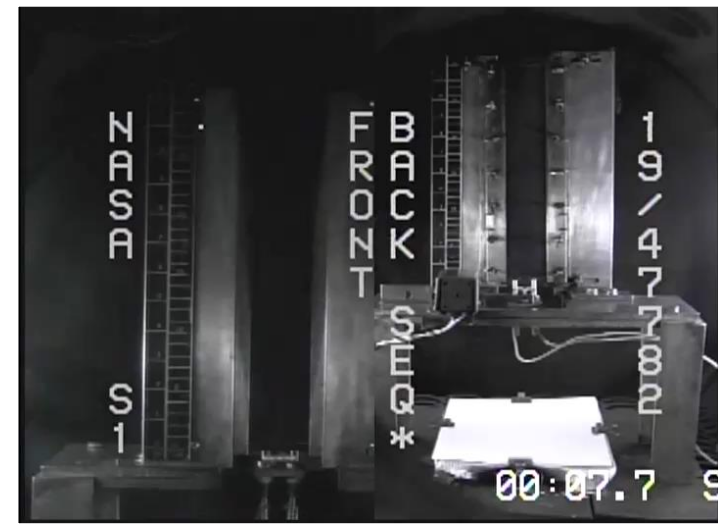
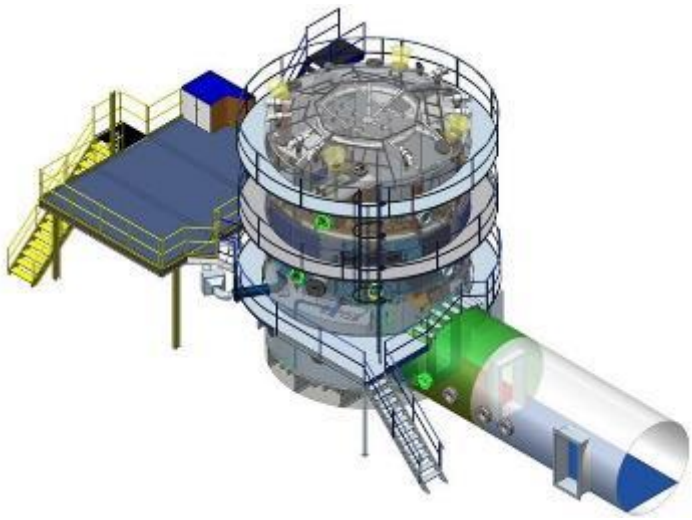

- 6 Subjects + 2 Doppler Technicians
- Planetary EVA Simulation

Day 1	3hr @ 100% O ₂ , 14.7 psia; Ascend to
Day 2	8.2psia / 34% O ₂ ; Equilibrate
Day 3	Prebreathe; 6hr EVA @ 4.3 psia, 85% O ₂
Day 4	Rest & Hypoxia Characterization
Day 5	Prebreathe; 6hr EVA @ 4.3 psia, 85% O ₂
Day 6	Rest & Hypoxia Characterization
Day 7	Prebreathe; 6hr EVA @ 4.3 psia, 85% O ₂
Day 8	Rest & Hypoxia Characterization
Day 9	Prebreathe; 6hr EVA @ 4.3 psia, 85% O ₂
Day 10	Rest & Hypoxia Characterization
Day 11	Prebreathe; 6hr EVA @ 4.3 psia, 85% O ₂



- Collecting metabolic rate data for all suited NBL runs this fiscal year (3-4 NBL runs per week)
- Standardizing timeline tracking / task categorization for NBL EVAs to add value to this data archive
- Developed a new metabolic rate data collection system for the NBL to automate this process

Physical Workload --> Metabolic Rate

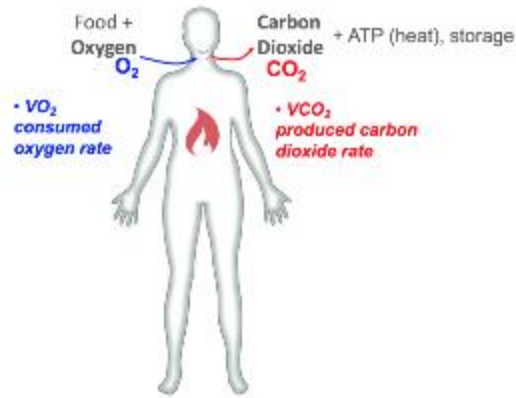

Training Feedback and EVA Planning:

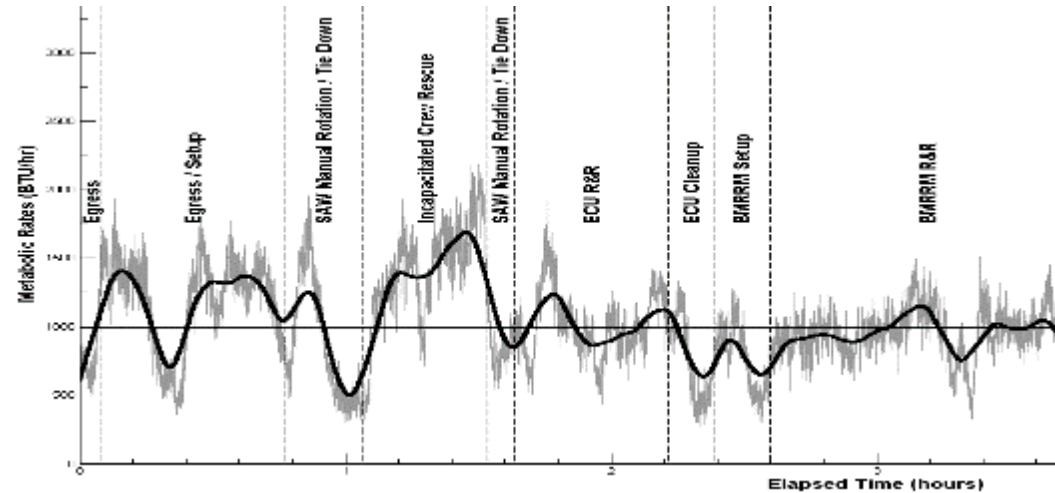

Task Timeline Tracking:

Color key:	POA LEE	POA CLA	Degraded LEE B	SSRMS Setup/Cleanup	FMS Grounding Strap
PET	0:00	1:00	2:00	3:00	4:00
EV1	Egress / Setup (0:20)	SSRMS Setup (0:30)	Remove POA LEE (1:00)	[4]	Retrieve Degraded LEE from Temp Stow Ring (1:00) / Install Degraded LEE onto POA (0:50)
EV2	Egress / Setup (0:20)	CLA Removal (0:30)	Remove POA LEE (1:00)	[4]	Retrieve Degraded LEE from Temp Stow Ring (1:00) / Install Degraded LEE onto POA (0:50)

Task Analysis:

Task	Category			
EVA setup/cleanup	EVA Setup (Free-Float)	EVA Cleanup (Free-Float)		
Worksite setup/cleanup	Worksite Setup (Free-Float)	Worksite Cleanup (Free-Float)		
Other work	Miscellaneous Work (Free-Float)	Cable routing (Free-Float)		
Bolts	Bolts (Free-Float)	Bolts (BRT)	Bolts (APFR)	Bolts (On SSRMS)
Fluid Connectors	Fluid Connectors (Free-Float)	Fluid Connectors (BRT)	Fluid Connectors (APFR)	Fluid Connectors (On SSRMS)
Electrical Connectors	Electrical Connectors (Free-Float)	Electrical Connectors (BRT)	Electrical Connectors (APFR)	Electrical Connectors (On SSRMS)
R&R (or install) work	R&R work (Free-Float)	R&R work (BRT)	R&R work (APFR)	R&R work (On SSRMS)



• Phase 1A: Metabolic Rate Data Collection System

– Operational Readiness: ORR completed in FY2019; awaiting final IT Security Plan approval

- Hardware installation completed and verified (via gas flow measurements on each umbilical)
- Calibration Plan for CO2 sensors approved; Procurement of Calibration Gas and Regulators in progress
- GUI for operators is developed and ready to implement along with H-3PO GovCloud data infrastructure

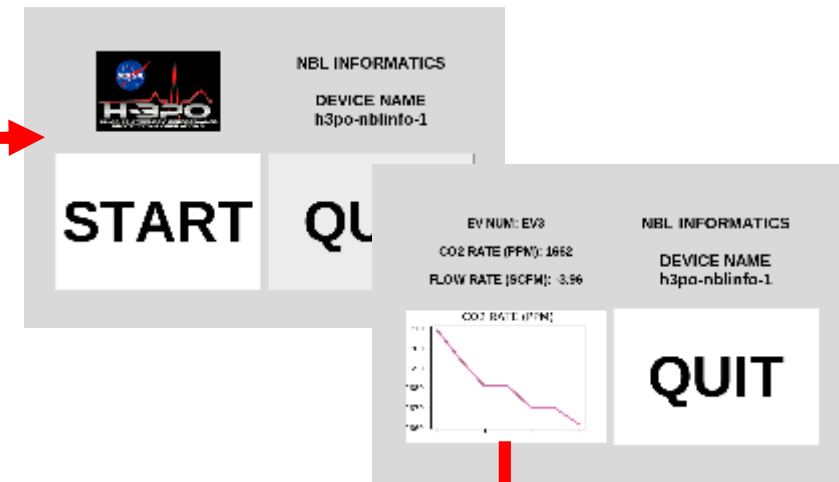
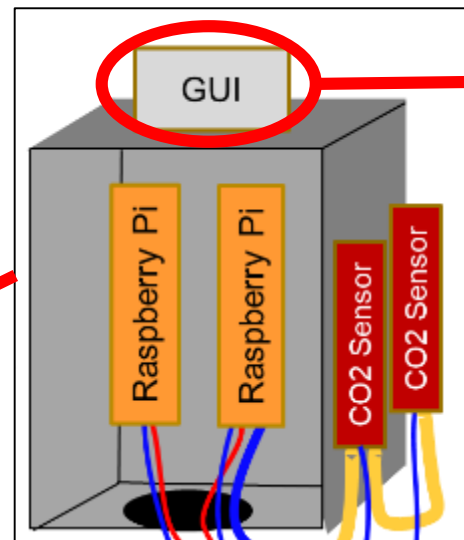
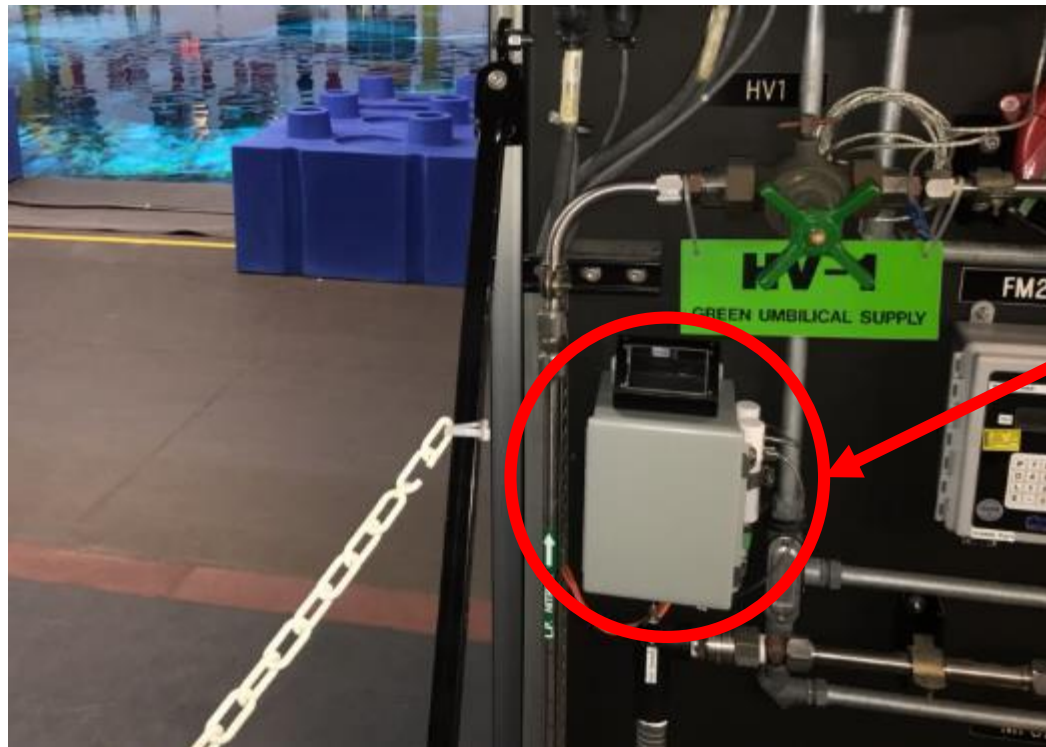



Phase 1B: Data visualization

- Extra-vehicular (EV) Capabilities

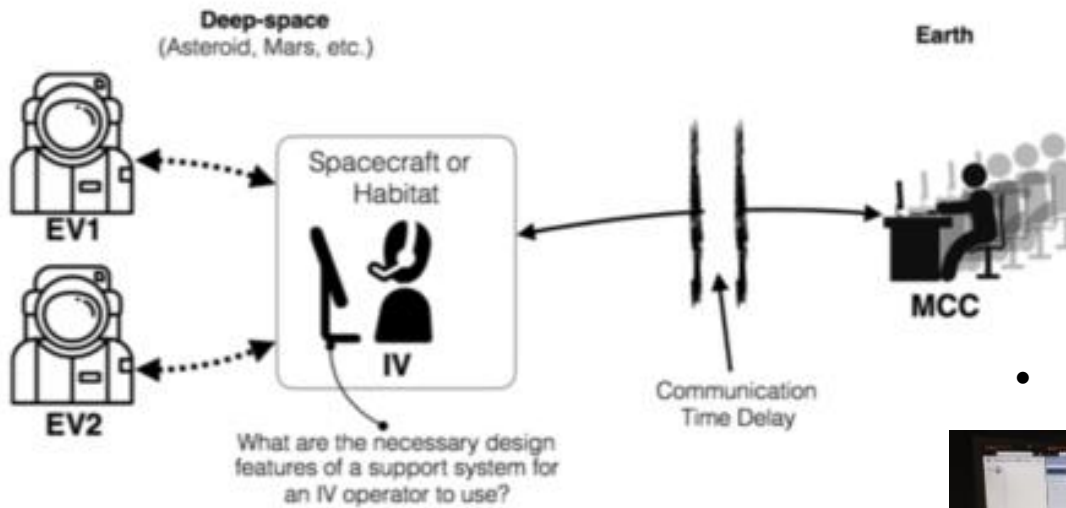

- Intra-vehicular (IV) Capabilities



NBL Lunar testing: EV and IV capabilities

- Decision Support: Communicate via audio and utilize in-water displays to provide cue cards
- Data Collection: Timeline Tracking, Biometric Data recording, and Simulation Quality Ratings

NBL EMU Helmet-Mounted Display (HMD)



- Externally-mounted display for suited crew members during NBL EVA training runs
- Initial demo in Summer 2020: display met rate data and phase elapsed time

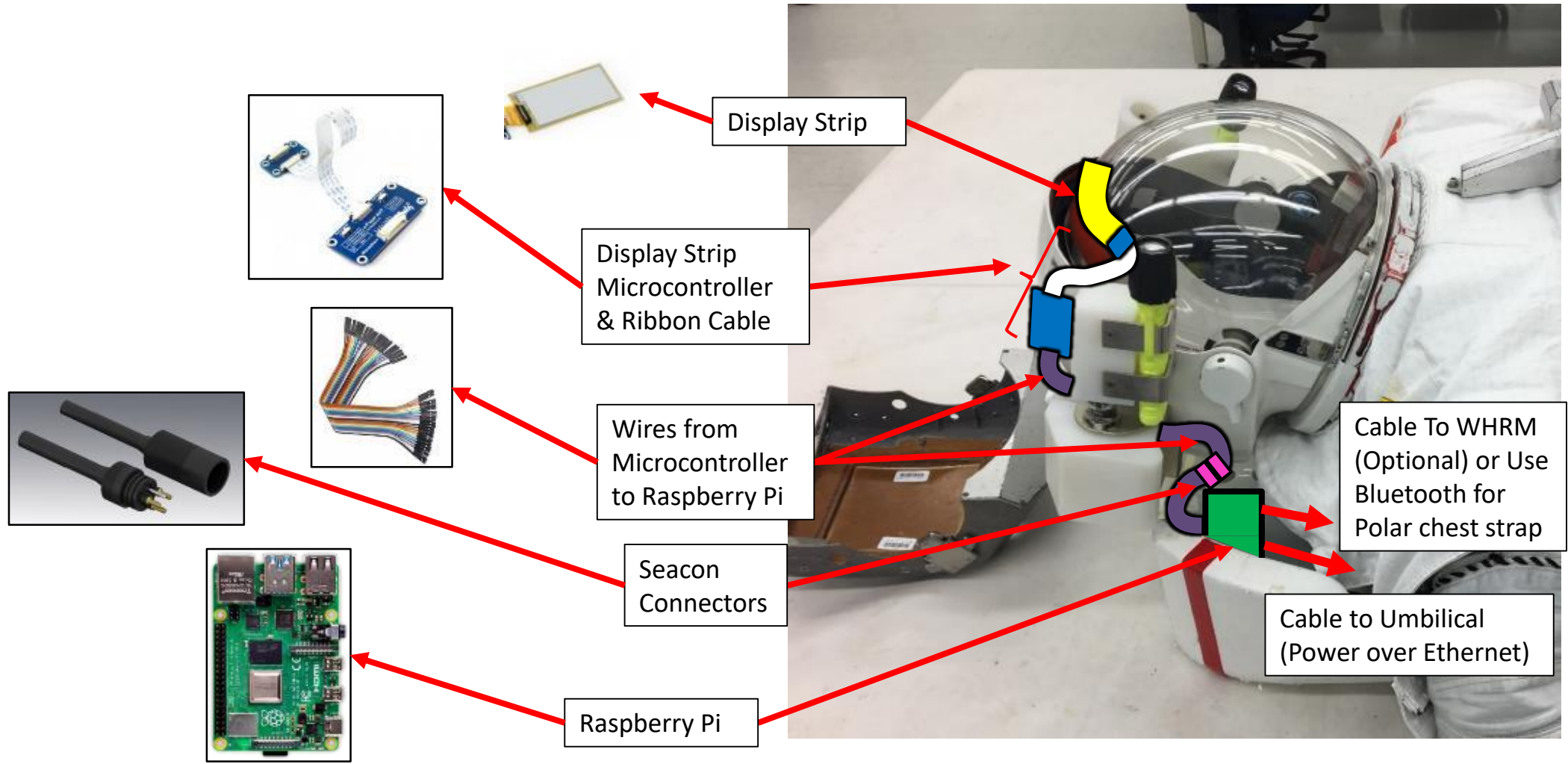



Exploration EVA Decision Support

- Building up EVA data archive in order to estimate metabolic rate profiles for a given crew & task list
- Data-driven decision support tools for training, planning, and operations
- NBL Informatics as proving ground for EVA Operations System (EOS) decision support tools

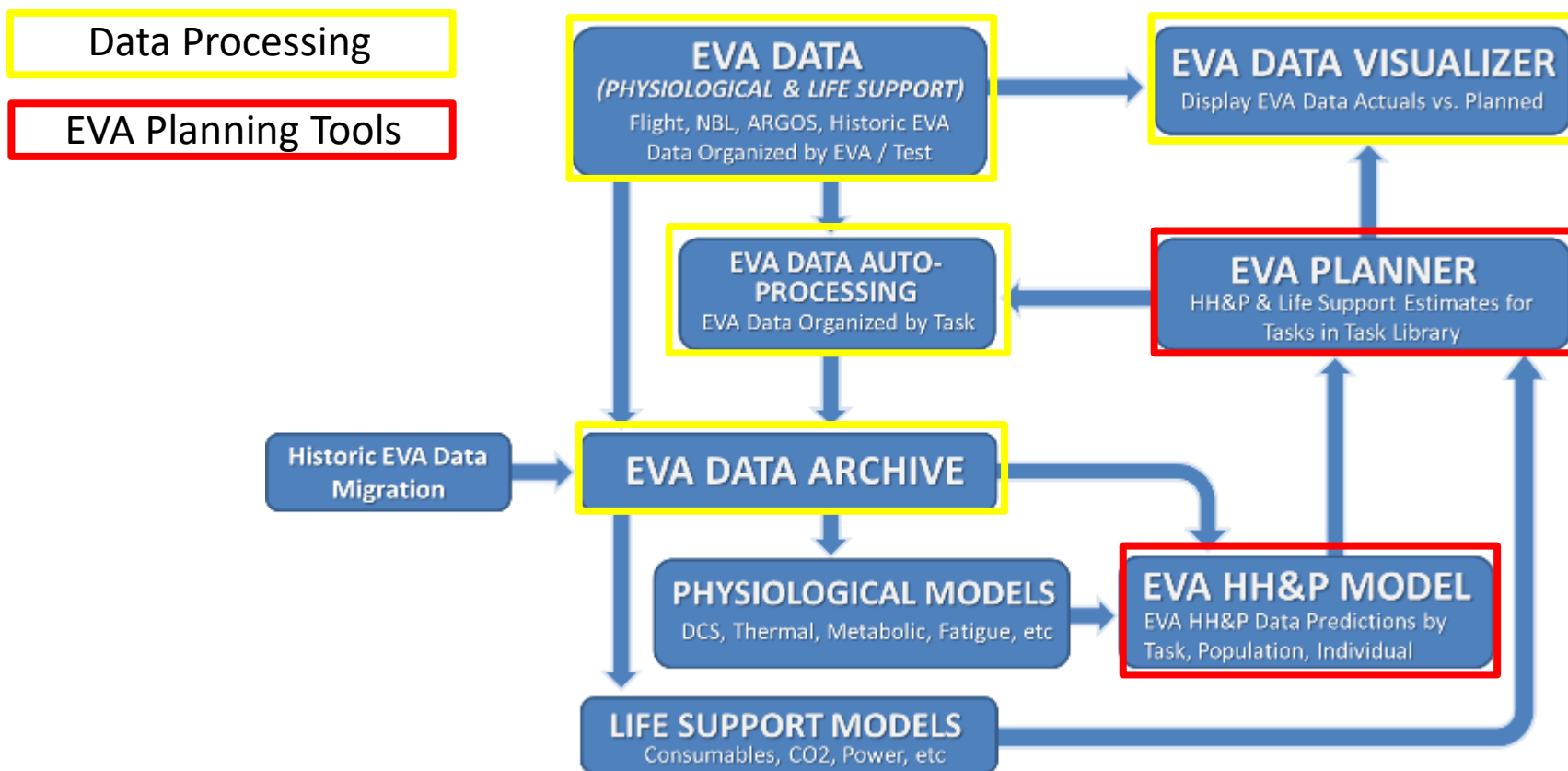

CH&P Gap Title	EVA SMT Gap No
EVA Informatics for Health & Performance	EVA-Gap-93

Planetary EVA Feasibility Testing



- **Planetary EVA feasibility testing on ARGOS**
 - Standard methods & metrics for characterizing simulation quality
 - New gimbal design & fabrication initiated (March/April)
- **End-to-end EVA simulations with suited astronaut test subjects on ARGOS**
 - PACES modules (procedures, hardware, mockups, and data streams)
 - Significant ARGOS infrastructure upgrades including metabolic rate pipeline at ARGOS (that was first developed for NBL); recorded metabolic rates and task timelines during these PACES-ARGOS development runs

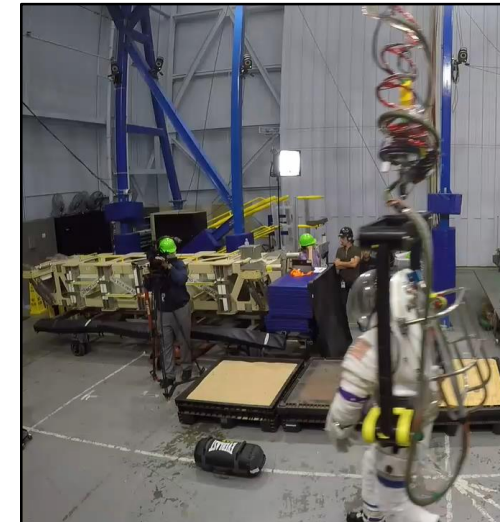

NBL Met Rate hardware @ ARGOS



CH&P Gap Title	EVA SMT Gap No
EVA Suit Design for Health & Performance	EVA-Gap-89

- Automated functional movement decomposition algorithm prototyped during PACES-ARGOS runs

All Wikis
Add an action
Wiki Cheatsheet
Tutorial 1: Welcome!
Personnel
Recent changes
Random page
Help

Forms

Person
Meeting Minutes
xEVA Component
Hardware
Test objective
Test event

Tools

Page [Discussion](#)

Activity Module: Geology Traverse

To display the output on another page, use the following template:
 Compact version: {{Summary Timeline Output | Activity Module: Geology}}
 Compact version with fixed pixel width (change *400"): {{Summary Timeline Output | Activity Module: Geology | 400}}
 Full version: {{Summary Timeline Output | Activity Module: Geology Traverse}}

PACES-ARGOS Subsite Traverse and Geology Sampling (1:00) (edit)

Color key: Traverse to Next Subsite Surveying and Site Description

PET	0:00		
EV1	O/H (0:02)	[2]	Contingency Sampling (0:05)

EV1:

- [2] Site Survey and Contextual Observations (0:05)
- [4] Panoramic Camera Setup (0:03)
- [5] Panoramic Image Capture (0:02)
- [6] Sample Marking and XRF Measurement (0:05)
- [8] Worksite Cleanup (0:02)
- [9] Translate to next subsite (0:02)
- [10] Site Survey and Contextual Observations (0:05)
- [11] Sample Marking and XRF Measurement (0:05)
- [13] Worksite Cleanup (0:02)
- [14] Translate Back to Start (0:02)

Posture Analysis Methods

- Classification of translation and functional activity periods

- Automatic detection of kneeling down posture periods

- Calculation of trunk tilt and rotation angles

Metrics

GEOPHONE DEPLOYMENT

- Translation (Treadmill walking) 25% (13.3 min)
- Functional activity with the standing posture 36% (19.3 min)
- Functional activity with the non-standing posture 39% (21.1 min)

- Translations:** Cumulative treadmill ambulation distance of ~16,000ft
- Standing postures:** Straight, with bending knee(s), with a few steps of walking, with bending trunk, etc.]
- Non-standing postures:** Kneeling down with one/both knee(s), kneeling down with bending upper body, etc.]

Planetary EVA Metabolic Task Characterization

- **Purpose:** Develop a planetary EVA task simulation environment and protocol which can be used to characterize metabolic workload and human performance while performing EVA in Lunar gravity
 - **Status:**
 - Detailed procedures for task categories including: geology, maintenance, ambulation circuits, and science instrument deploy
 - Retrospective analysis of Apollo metabolic rate estimation and measurement methods

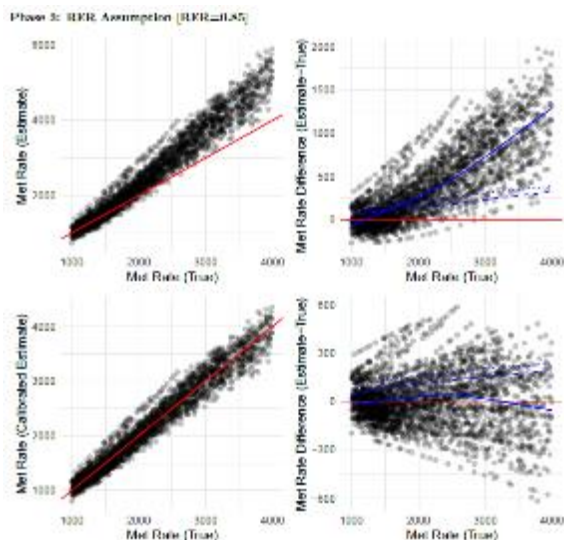

Statistical error analysis of current in-suit metabolic rate measurement methods

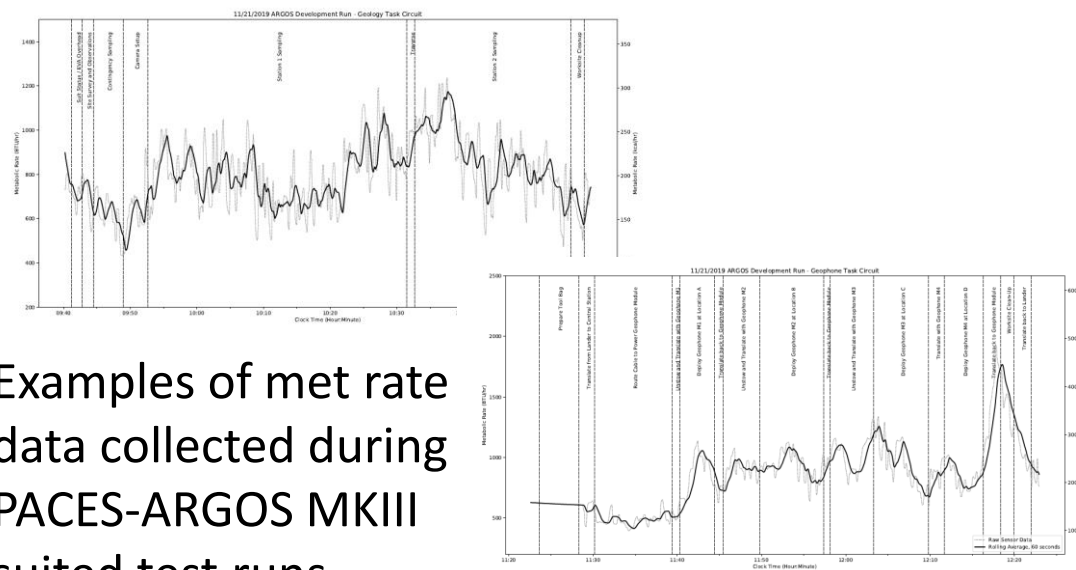

Examples of met rate data collected during PACES-ARGOS MKIII suited test runs

CH&P Gap Title	EVA SMT Gap No
EVA Suit Design for Health & Performance	EVA-Gap-89

Impaired EVA – Part I Capsule Egress



Purpose:

- **Determine if deconditioned crew can safely egress a capsule unassisted after up to a year on the ISS**
 - Crew will self-egress their capsule, walk a short distance, and doff their LEA suits unassisted.
- **Demonstrate the ability to perform a minimal EVA unassisted within 24 hours of landing**
 - Current con-ops for Mars landers include enough power for the first 24 hours.
 - Within that time, crew may have to perform an EVA to secure power.



CH&P Gap Title

EVA SMT Gap No

EVA Crew Required
Capabilities

EVA-Gap-88

Impaired EVA – Part II Early EVA



- **Tested EVA Capabilities**

- First 24 Hours

- Ingress EVA suit
 - Translate through hatch
 - Ladder descent
 - Walk & connect supply umbilicals
 - Object translation
 - Align with rear entry donning stand
 - Egress EVA suit

- Additional Tasks Done Pre and Later Post-landing

- Agility obstacle course
 - Jump down and stabilize
 - Incline/decline ambulation and instrument deploy



Status:

- IRB protocol approved.
- Suited testing methods development underway (PACES)

CH&P Gap Title

EVA SMT Gap No

EVA Crew Required
Capabilities

EVA-Gap-88

APACHE:

Assessments of Physiology And Cognition in Hybrid-reality Environments



- APACHE: First build of VR simulation of Shackleton Crater, lander, rover driving, & passive treadmill implemented (video)
- → Initial test environment for EVA ConOps, informatics & software testing; future application for xEVA training

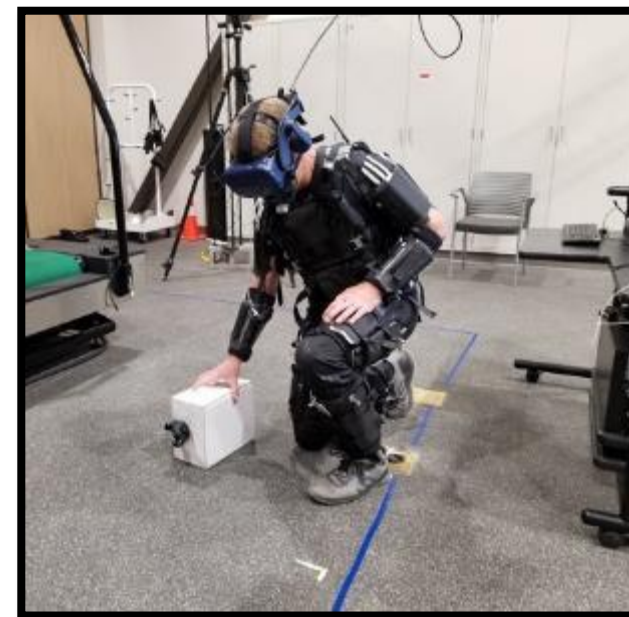

CH&P Gap Title	EVA SMT Gap No
EVA ConOps for Health & Performance	EVA-Gap-92
CH&P Gap Title	EVA SMT Gap No
EVA Informatics for Health & Performance	EVA-Gap-93

Suited Exposure and Injury Surveillance

CH&P Gap Title
EVA Injury Risk & Mitigation

EVA SMT Gap No
EVA-Gap-94



- **Suit exposure (injury and non-injury) collected before and after all suited EVA ground testing (EMU and planetary) using software tool**
 - Use data to mitigate injuries, improve human performance and comfort
 - Educate broader EVA community on risks of EVA and inform mitigations
 - Important component of EVA Injury Roadmap
 - Implementation for flight EVAs being pursued

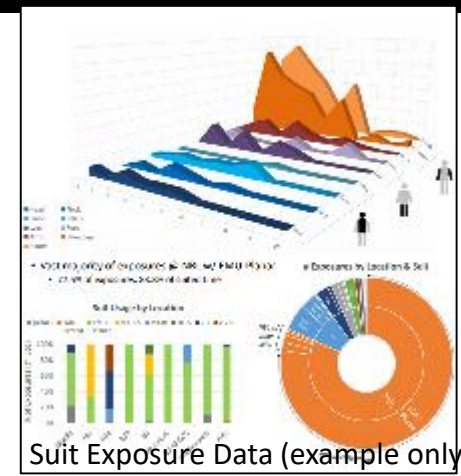

Suit Exposure Data (example only)

Subject Characteristics

- Age, Sex
- Anthropometry
- Strength
- Fitness

Spacesuit

- Type
- Sizing
 - Prime vs Secondary
- Pressure

Task Characteristics

- Training
- Flight
- Research
- Facility

Suit Related Injury

- Yes
 - Type
 - Location
 - Severity
- No

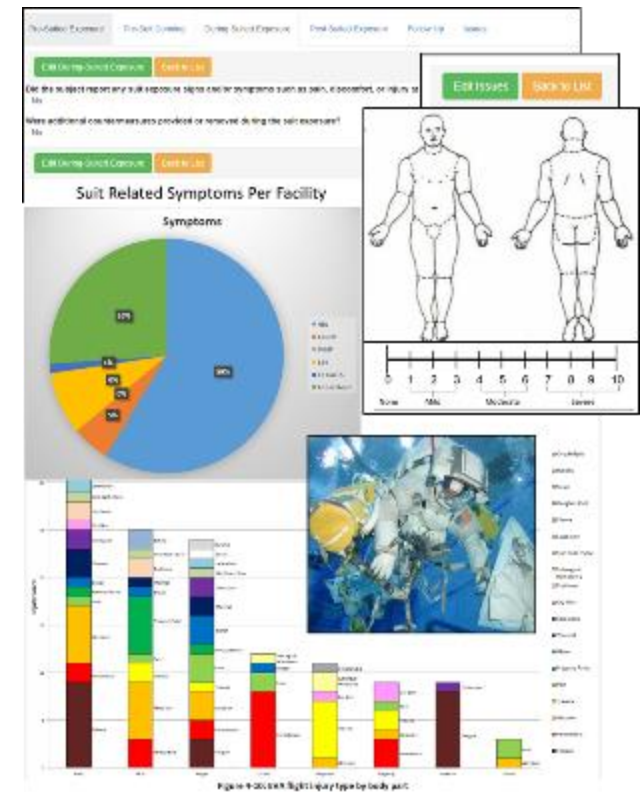

Inspired CO₂ Standard and xEMU Requirement

- Standard test protocol for space suit inspired CO₂ completed
 - To be published as NASA Technical Report
- Journal manuscript submitted for EMU Inspired CO₂ characterization study results
- Journal manuscript in work for xEMU CO₂ requirement development

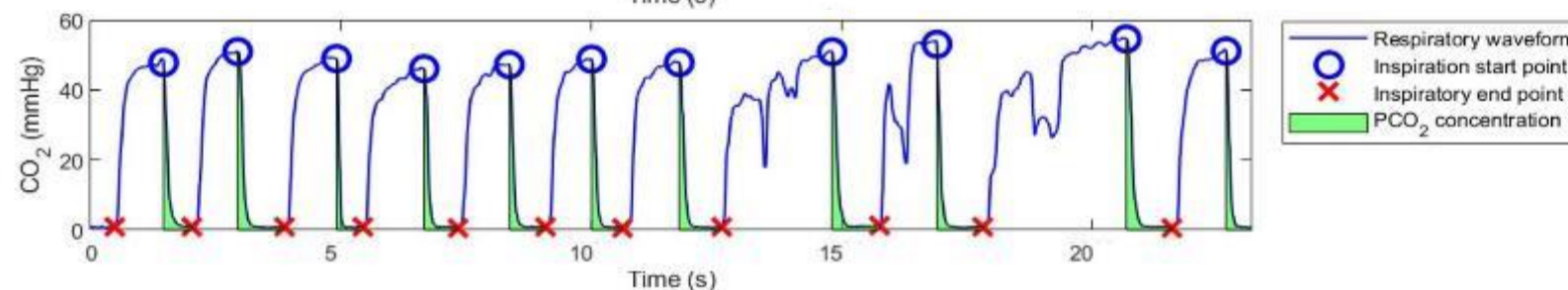
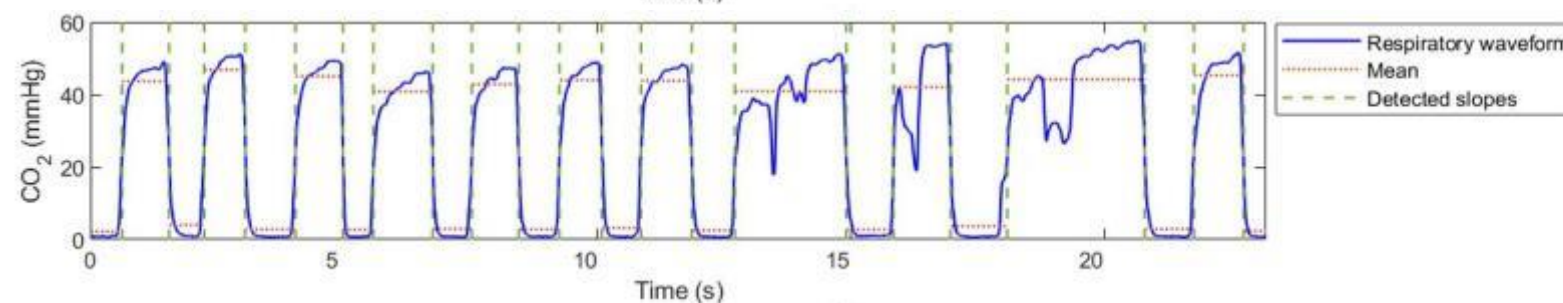
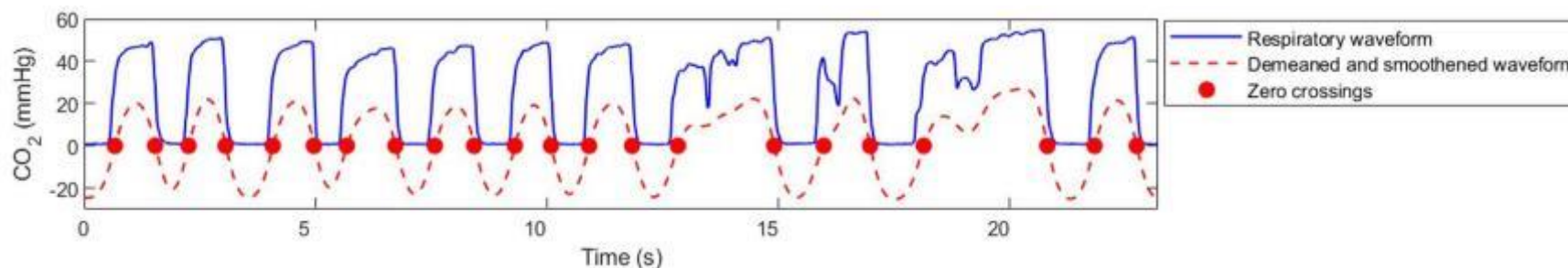

CH&P Gap Title	EVA SMT Gap No
EVA Physiological Inputs and Outputs	EVA-Gap-91

- **Mechanisms**

- Proposals (e.g., PSTAR, HRP)
- Fellowships (e.g., Office of STEM Engagement)
- Internships (intern.nasa.gov)

- **Examples**

- Operational performance measures
- PACES Modules
- VR Models
- Human physiology & performance models (e.g., metabolic, thermal, DCS, biomechanical, etc.)
- Software tools (e.g., data visualizations, timeline management, procedure)

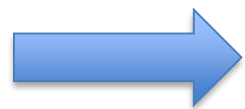

CH&P EVA Roadmap & Open EVA Research Forum

<https://www.nasa.gov/suitup/reference>



Human Health and Performance xEMU Priorities

Presenter: Jason Norcross (KBR)

Lunar Metabolic Rates Assumptions Combined Heat Storage, Humidity and Hydration Requirements

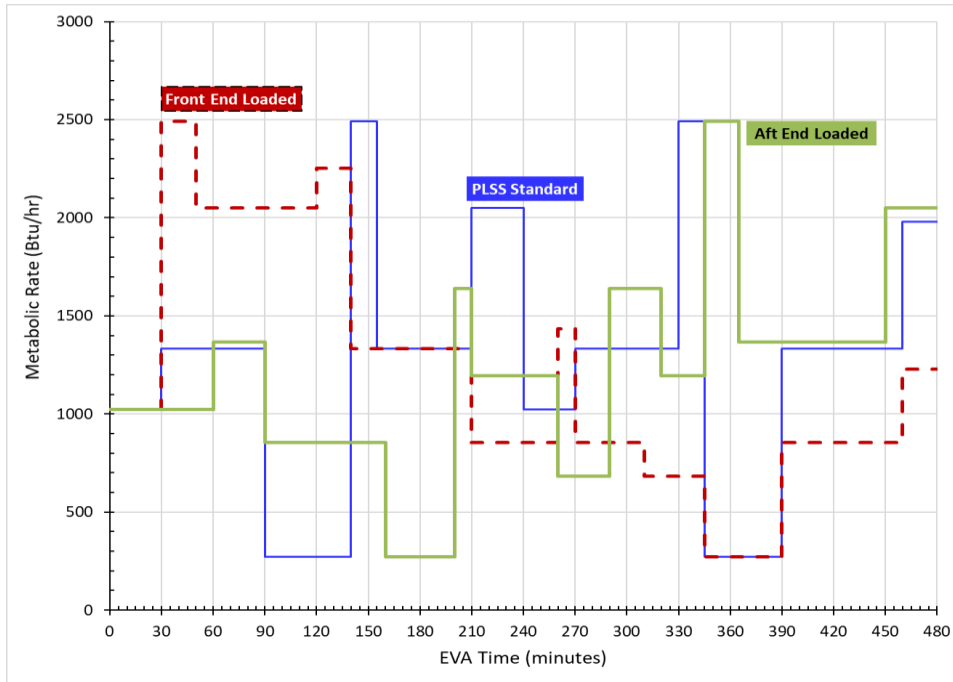

Major Concerns

- Long term – consumables & EVA time
- Short term – heat storage, fatigue & inspired CO₂
- Reasonable fitness for duty standards

Aerobic Capacity	8-hr EVA Workload	6-hr EVA Workload	Long Peak Workload	Short Peak Workload
BTU/hr Max	1200	1600	2500	3000
2000	60%	80%	125%	150%
3000	40%	53%	83%	100%
4000	30%	40%	63%	75%
5000	24%	32%	50%	60%
6000	20%	27%	42%	50%

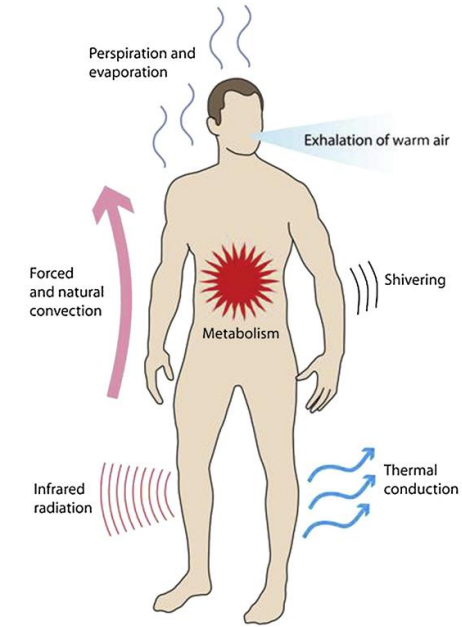

Table 23—EVA Spacesuit Inspired Partial Pressure of CO₂ (P_iCO₂) Limits †

P _i CO ₂ (mmHg)	Allowable Cumulative Duration (hours per day)
P _i CO ₂ > 15.0	Do Not Exceed
12.5 < P _i CO ₂ ≤ 15.0	≤ 0.5
10.0 < P _i CO ₂ ≤ 12.5	≤ 1.0
7.0 < P _i CO ₂ ≤ 10.0	≤ 2.5
4.0 < P _i CO ₂ ≤ 7.0	≤ 7.0
P _i CO ₂ ≤ 4.0	≤ 14.0

11.1.2.5 Suited Crewmember Heat Storage

[V2 11011] The system shall prevent the energy stored by each crewmember during nominal suited operations from exceeding the limits defined by the range 3.0 kJ/kg (1.3 Btu/lb) > ΔQ stored > -1.9 kJ/kg (-0.8 Btu/lb), where ΔQ stored is calculated using the 41 Node Man or Wissler model.



In-Suit Hydration, Nutrition, Waste Management & Contingency Durations



ISS EVA Crew Considerations

5 hr. Pre-EVA Prep + 6-7 hr. Nominal EVA + 1 hr. Post-EVA
Total Nominal Time to Consider 12-13 hours



**NO FOOD
ALLOWED**

MAG – 32 oz.
absorbency

Nutrition – none

DIDB – 32 oz.



Exploration EVA Crew Considerations

2 hr. Pre-EVA Prep + 6-8 hr. Nominal EVA + 1 hr. Post-EVA
Total Nominal Time to Consider 9-11 hours



What if we have to stay in the suit longer than 12 hours?

MAG – TBD

Nutrition – TBD

DIDB – 64 oz.
(8 oz. x 8 hr.)



Vehicle Loop Mode Integration (HLS and xEMU)

Crew Restraints and Orthostatic Support for Launch & Landing G-Loads

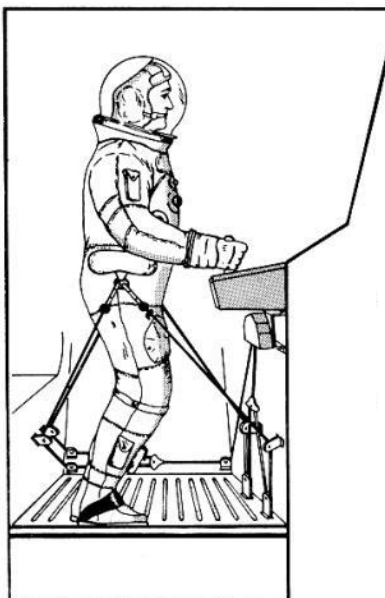

Suit Don/Doff Speed and Duration Reqs



Do we need heart rate?



Nutrition, Hydration & Waste Management



Breathing Mixtures O₂ vs Cabin Air vs Nitrox Mix



Protection for Cabin Depress



Beyond 8.2/34 for Exploration Prebreathe



Saturation Atmosphere	Microgravity Prebreathe* (h:mm)	Estimated Planetary Prebreathe*
14.7 psi, 21% O2	4:00	6:30-7:00 ²
10.2 psi, 26.5% O2	0:40-1:10	3:00-3:30 ³
8.2 psi, 34% O2	0:00-0:15	0:00-0:30 ⁴
5.0 psi, 100% O2 (Apollo, Gemini)	0:00	0:00

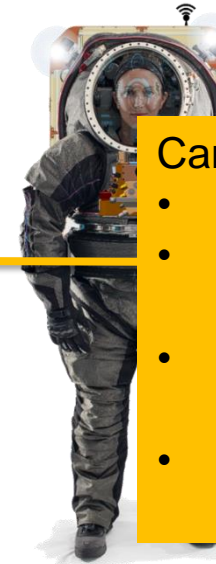

Can we reduce this time?

- Adjust 10.2/26.5 atmosphere
- Exercise enhanced prebreathe
- Utilize xEMU variable pressure capabilities
- Intermittent Recompressions

*Assume 6hr EVA @ 4.3 psia

Un-validated (i.e., not yet available for flight use)

SAT	0000	0100	0200	0300	0400	0500	0600	0700	0800	0900	1000	1100	1200	1300	1400	1500	1600	1700	1800	1900	2000	2100	2200	2300	2400
8.2psi /34% O2	SLEEP (8.0 HRS TOTAL)					Postsleep-1.5 hrs	PMC & DPC	EVA Prep (excl. PB)	Prebreathe	EVA (8 HRS)								Post-EVA Overhead	Meal	MARGIN (60 mins)	PMC & DPC	Presleep - 1.5 hrs	SLEEP		
10.2psi /26.5% O2	SLEEP (6.0 HRS TOTAL)			Postsleep-1.5 hrs	PMC & DPC	EVA Prep (excl. PB)	Prebreathe (3.5 HRS)			EVA (8 HRS)								Post-EVA Overhead	Meal	PMC & DPC	Presleep - 1.5 hrs	SLEEP			
14.7psi /21% O2	Postsleep-1.5 hrs	PMC & DPC	EVA Prep (excl. PB)	Prebreathe (7 HRS)						EVA (8 HRS)								Post-EVA Overhead	Meal	PMC & DPC	Presleep - 1.5 hrs	SLEEP (2.5 HRS TOTAL)			

- Assumptions**
- 1 DPCs are for system status checks and any general Q&A for crew
 - 2 PMCs are for pre/post EVA medical status checks
 - 3 Sleep period = 8 hrs, immediately following Presleep activity (no sleep shifting for crew during surface ops)
 - 4 Post/presleep include routine system/HAB cks, hygiene and meal
 - 5 EVA Prep includes pre-EVA conference with MCC



² Abercromby et al. "Suited Ground Vacuum Chamber Testing Decompression Sickness Tiger Team Report", 2018 NASA Technical Report
³ Abercromby, et al. "Using the Shuttle Staged Prebreathe Atmosphere and Variable Pressure Spacesuits for Exploration Extravehicular Activity", 2018 AsMA.
⁴ Abercromby et al. "Modeling Oxygen Prebreathe Protocols for Exploration EVA Using Variable Pressure Suits", 2017 AsMA.