

NASA/TP—2018–220027

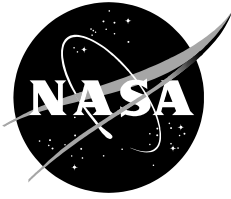

State of the Art Small Spacecraft Technology

Small Spacecraft Systems Virtual Institute

Ames Research Center, Moffett Field, California

December 2018

NASA STI Program ... in Profile

Since its founding, NASA has been dedicated to the advancement of aeronautics and space science. The NASA scientific and technical information (STI) program plays a key part in helping NASA maintain this important role.

The NASA STI program operates under the auspices of the Agency Chief Information Officer. It collects, organizes, provides for archiving, and disseminates NASA's STI. The NASA STI program provides access to the NASA Aeronautics and Space Database and its public interface, the NASA Technical Reports Server, thus providing one of the largest collections of aeronautical and space science STI in the world. Results are published in both non-NASA channels and by NASA in the NASA STI Report Series, which includes the following report types:

- **TECHNICAL PUBLICATION.** Reports of completed research or a major significant phase of research that present the results of NASA Programs and include extensive data or theoretical analysis. Includes compilations of significant scientific and technical data and information deemed to be of continuing reference value. NASA counterpart of peer-reviewed formal professional papers but has less stringent limitations on manuscript length and extent of graphic presentations.
- **TECHNICAL MEMORANDUM.** Scientific and technical findings that are preliminary or of specialized interest, e.g., quick release reports, working papers, and bibliographies that contain minimal annotation. Does not contain extensive analysis.
- **CONTRACTOR REPORT.** Scientific and technical findings by NASA-sponsored contractors and grantees.
- **CONFERENCE PUBLICATION.** Collected papers from scientific and technical conferences, symposia, seminars, or other meetings sponsored or co-sponsored by NASA.
- **SPECIAL PUBLICATION.** Scientific, technical, or historical information from NASA programs, projects, and missions, often concerned with subjects having substantial public interest.
- **TECHNICAL TRANSLATION.** English-language translations of foreign scientific and technical material pertinent to NASA's mission.

Specialized services also include organizing and publishing research results, distributing specialized research announcements and feeds, providing information desk and personal search support, and enabling data exchange services.

For more information about the NASA STI program, see the following:

- Access the NASA STI program home page at <http://www.sti.nasa.gov>
- E-mail your question to help@sti.nasa.gov
- Fax your question to the NASA STI Information Desk at 443-757-5803
- Phone the NASA STI Information Desk at 443-757-5802
- Write to:
STI Information Desk
NASA Center for Aerospace Information
7115 Standard Drive
Hanover, MD 21076-1320

NASA/TP—2018–220027

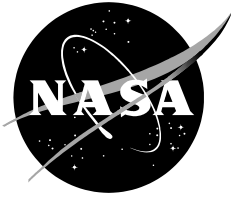

State of the Art Small Spacecraft Technology

Small Spacecraft Systems Virtual Institute

Ames Research Center, Moffett Field, California

National Aeronautics and
Space Administration

*Ames Research Center
Moffett Field, CA 94035-1000*

December 2018

The use of trademarks or names of manufacturers in this report is for accurate reporting and does not constitute an official endorsement, either expressed or implied, of such products or manufacturers by the National Aeronautics and Space Administration.

Available from:

NASA Center for AeroSpace Information
7115 Standard Drive
Hanover, MD 21076-1320
443-757-5802

This report is also available in electronic form at
[http://](http://sst-soa.arc.nasa.gov/) <https://sst-soa.arc.nasa.gov/>

NASA STI Support Services
Mail Stop 148
NASA Langley Research Center
Hampton, VA 23681-2199
757-864-9658

National Technical Information Service
5301 Shawnee Rd.
Alexandria, VA 22312
webmail@ntis.gov
703-605-6000

National Aeronautics and Space Administration



Small Spacecraft Technology State of the Art



www.nasa.gov



Abstract

This report provides an overview of the current state-of-the-art of small spacecraft technology, with particular emphasis placed on the state-of-the-art of CubeSat-related technology. It was first commissioned by NASA's Small Spacecraft Technology Program (SSTP) in mid-2013 in response to the rapid growth in interest in using small spacecraft for many types of missions in Earth orbit and beyond, and was revised in mid-2015 and 2018. This work was funded by the Space Technology Mission Directorate (STMD). For the sake of this assessment, small spacecraft are defined to be spacecraft with a mass less than 180 kg. This report provides a summary of the state-of-the-art for each of the following small spacecraft technology domains: Complete Spacecraft, Power, Propulsion, Guidance Navigation and Control, Structures, Materials and Mechanisms, Thermal Control, Command and Data Handling, Communications, Integration, Launch and Deployment, Ground Data Systems and Operations, and Passive Deorbit Devices.



Disclaimer

This document lists or describes many specific products and technologies as examples and references but their inclusion does not imply any endorsement by NASA. Failure to include any specific products or technologies that might be considered relevant under a particular topic was unintentional. At time of publication, this report accepted contents from October 2018.

Acknowledgments

This report has been based largely on desktop research and published documents on small spacecraft technology, industry consultation and participation at conferences. Helpful suggestions and contributions were also received from numerous people at NASA Ames Research Center, and in particular the authors wish to acknowledge the reviewers James Bell, Josh Benton, Matt D'Ortenzio, Josh Forgione, Shang Wu, Han Ling, Vanessa Kuroda, Dawn McIntosh, Marc Murbach, Matt Nehrenz, Hugo Sanchez, Matt Sorgenfrei, Sarah Thompson, Brittany Wickizer, Timothy Snyder, Sarah Hobart, Craig Pires, Eddie Uribe, Aaron Cohen, Anh Nguyen, and Mission Design Center, and Senior Technical Editor, Teague Soderman at NASA Ames Research Center.

From NASA Glenn Research Center the authors would like to thank the reviewers Matt Deans, Fred Elliot, Josh Freeh, David Jacobson, Gabriel Benavides, Thomas Liu, William Marshall, Felix A. Miranda, Tim Smith and Brandon White.

From Aerospace Corporation the authors would like to thank reviewers Andrea Hsu, Jim Breckheimer, Brian Brady, Rostislav Spektor, and Thomas Curtiss.

The authors would like to also thank all of the companies, universities and organizations who provided information for this report. Finally, thanks to the Small Spacecraft Systems Virtual Institute (S3VI) Summer 2018 interns, Josh Ingersoll and Cameron Miller.



NASA Ames Research Center, Small Spacecraft Systems Virtual Institute
December, 2018

Division Chief:
Bruce Yost

Editor:
Sasha Weston

Contributing Authors:
Elwood Agasid, Roland Burton, Roberto Carlino, Gregory Defouw, Andres
Dono Perez, Arif Göktuğ Karacalıoğlu, Benjamin Klamm, Abraham Rademacher, James
Schalkwyck, Rogan Shimmin, Julia Tilles, Sasha Weston



Table of Contents

1.0	Introduction	15
1.1	Objective	15
1.2	Scope	15
1.3	Assessment	16
1.4	Overview	17
2.0	Complete Spacecraft Platforms	18
2.1	Introduction	18
2.2	State of the Art.....	18
2.2.1	Minisatellites.....	18
2.2.2	CubeSats.....	23
2.2.3	Picosatellites	28
2.3	On the Horizon	30
2.4	Summary	30
	References	31
3.0	Power	34
3.1	Introduction	34
3.2	State of the Art.....	34
3.2.1	Power Generation.....	34
3.2.2	Power Storage.....	39
3.2.3	Power Management and Distribution	43
3.3	On the Horizon	46
3.3.1	Power Generation	46
3.3.2	Power Storage.....	48
3.3.3	Power Management and Distribution	48
3.4	Summary	49
	References	49
4.0	Propulsion	53
4.1	Introduction	53
4.2	State of the Art.....	54
4.2.1	Chemical Propulsion Systems	54



4.2.2	Electric Propulsion Systems	61
4.3	On the Horizon	71
4.3.1	Future Small Spacecraft Missions with Propulsion	73
4.4	Summary	73
	References	74
5.	Guidance, Navigation & Control	80
5.1	Introduction	80
5.2	State of the Art.....	81
5.2.1	Integrated Units	81
5.2.2	Reaction Wheels	82
5.2.3	Magnetorquers	84
5.2.4	Thrusters	85
5.2.5	Star Trackers	85
5.2.6	Magnetometers	86
5.2.7	Sun Sensors	87
5.2.8	Horizon Sensors	88
5.2.9	Gyros	88
5.2.10	GPS Receivers.....	89
5.2.11	Deep Space Navigation	89
5.2.12	Atomic Clocks.....	90
5.3	On the Horizon	91
5.4	Summary	92
	References	92
6.0	Structure, Mechanisms, and Materials.....	94
6.1	Introduction	94
6.2	State of the Art.....	94
6.2.1	Primary Structure	95
6.2.2	Mechanisms	98
6.2.3	Additive Manufacturing Materials	101
6.3	On the Horizon	103
6.3.1	Radiation Effects and Mitigation Strategies.....	104



References	105
7.0 Thermal	107
7.1 Introduction	107
7.2 State of the Art.....	108
7.2.1 Passive Systems.....	108
7.2.2 Active Systems	112
7.3 On the Horizon.....	116
7.3.1 Deployable Radiators.....	116
7.3.2 Fluid Loops	116
7.4 Summary	117
References	117
8. Command and Data Handling.....	119
8.1 Introduction	119
8.2 State of the Art.....	119
8.2.1 Form Factor.....	119
8.2.2 On-Board Computing	119
8.2.3 Memory and Electronic Components	121
8.2.4 Bus Electrical Interfaces and I/O	123
8.2.5 Electronic Power Supplies.....	123
8.3 On the Horizon.....	123
8.3.1 Radiation Mitigation and Tolerance Schemes	124
8.3.2 Component Selection.....	124
8.3.3 Protection Circuits.....	125
8.3.4 Memory Protection.....	125
8.3.5 Communication Protection	125
8.3.6 Parallel Processing and Voting.....	126
8.3.7 Open Source Spacecraft Software	126
8.4 Summary	127
References	127
9.0 Communications	129
9.1 Introduction	129



9.2	State of the Art.....	131
9.2.1	VHF and UHF	131
9.2.2	L-Band	133
9.2.3	S-Band	133
9.2.4	X-band	135
9.2.5	Lasercom	136
9.2.6	Ku- to Ka-band.....	137
9.3	On the Horizon.....	138
9.3.1	Asymmetric Laser Communications.....	138
9.3.2	New Antennas.....	138
9.3.3	InterCubeSat Communications and Operations	138
9.4	Summary	139
	References	139
10.0	Integration, Launch, and Deployment	143
10.1	Introduction	143
10.2	State of the Art.....	143
10.2.1	Launch Integration Services.....	143
10.2.2	Dedicated Launchers of Small Spacecraft	146
10.2.3	Launchers Which Offer Ride-Sharing Opportunities for Small Spacecraft	150
10.2.4	Dedicated Ride-Share.....	156
10.2.5	Orbital Maneuvering Systems.....	157
10.2.6	Orbital and Suborbital Rides	157
10.2.7	Dispensers for CubeSats	159
10.2.8	Other Adapters for Small Spacecraft	164
10.2.9	Separation Systems.....	165
10.3	On The Horizon	166
10.3.1	Dedicated Launchers for Small Spacecraft	166
10.3.2	Payload Adaptors and Orbital Maneuvering Systems	172
10.4	Summary	173
	References	173
11.0	Ground Data Systems.....	178



- 11.1 Introduction 178
 - 11.1.1 Small Spacecraft Ground Data Systems 178
 - 11.1.2 Amateur and Non-Amateur Communications Bands 179
 - 11.1.3 Delay/Disruption Tolerant Networking..... 181
- 11.2 State of the Art..... 181
 - 11.2.1 Turnkey Solutions..... 181
 - 11.2.2 Ground Data Systems Hardware and Software 184
 - 11.2.3 Alternative Solutions..... 186
- 11.3 On the Horizon 187
- 11.4 Summary 188
- References 189
- 12.0 Passive Deorbit Systems 191
 - 12.1 Introduction 191
 - 12.2 State of the Art..... 192
 - 12.3 Summary 194
- References 195
- Summary 196
- Appendix E. Technology Readiness Levels 197



Preface

At the time the *Small Spacecraft Technology State-of-the-art* report was first published in 2013, 247 CubeSats and 105 other small spacecraft (non-CubeSats under 50 kg) had launched. Since then, over 290 CubeSats have launched, with nearly 350¹ small spacecraft in 2017 alone (Bok et al., 2017). Since 2013, flight heritage has nearly doubled. With such a wealth of new information available from launch data and other sources, NASA saw the value of releasing an updated 2018 report.

To help identify new technologies suitable for inclusion in this report, a request for information (RFI): *SmallSat Parts on Orbit Now (SPOON)* Database, was released in the Federal Business Opportunities (FBO) and NASA Acquisition Internet Sites (NAIS). In addition to reviewing responses to the RFI, desk research continued using journal and conference papers, web resources and a public solicitation at the annual American Institute of Aeronautics and Astronautics at the Utah State University Conference on Small Satellites in Logan, Utah, held August 4-10, 2018.

The report structure is consistent with previous editions, and each chapter has been updated with new and maturing technologies, such as the Exo-Brake used on TechEdSat missions. A table in each section provides a convenient summary of the technologies discussed, with explanations and references in the body text. We have attempted to isolate trends in the small spacecraft industry to point out which technology missions have been adopted.

A central element of the report is to list state-of-the-art technologies by NASA Standard Technology Readiness Level (TRL) as defined by the 2018 NASA Engineering Handbook, found in NASA NPR 7123.1B. The reviewers have endeavored to independently verify TRL by citing published test results. Where these test results disagree with vendors' own advertised TRL, the authors have engaged the vendors to discuss the discrepancy. It is important to note that this report takes a broad system-level view; to attain a high TRL, the subsystem must be in a flight-ready configuration with all supporting infrastructure--such as mounting points, power conversion and control algorithms--in an integrated unit.

In the cases where multiple companies are developing similar products, the company with the leading TRL has been identified in the tables. The TRL is based purely on NASA TRL guidelines unless otherwise noted, regardless of specific mission requirements. Changes to the TRL value will vary depending on the design factors for a specific technology. For example, a very important design factor for solar electric propulsion is the duration of operation, and the applicability of passive deorbit devices can vary drastically at different altitudes. For the purposes of this document, simply having functioned in the relevant environment is sufficient to achieve a given TRL. Furthermore, if a technology has flown on a mission without success, or without providing valid confirmation to the operator, that "flight heritage" has been discounted.

Small spacecraft have matured since the prior version of this report, and the platform is now being seriously considered for deep space missions. This has led to intense scrutiny over the radiation protection in small spacecraft, especially given their tendency to use low-cost, commercial off-the-shelf (COTS) components. Consequently, this report also includes radiation mitigation strategies for small spacecraft missions.

It is important to note that future editions of this report may include the rapidly growing fields of flight software; assembly integration and testing services; and mission modeling and simulation--all of which are now extensively represented at small spacecraft conferences. These fields are

¹ Including 17 small satellite launch failures in 2017.



still in their infancy, and as these subsystems evolve and reliable conventions and standards emerge, the next iteration of this report may also evolve to include new chapters.

References

C. B. Bok, A. Comeau, A. Dolgoplov, T. Halt, C. Juang, P. Smith. "Smallsats by the Numbers." 2018. Bryce and Space Technology (https://brycetek.com/downloads/Bryce_Smallsats_2018.pdf).



Executive Summary

Integrated Spacecraft Platforms

Since the last edition of this report, some vendors have compiled the subsystems represented in the later chapters into complete, integrated spacecraft platforms, available commercially off-the-shelf (COTS) for rapid integration and delivery. Thus, the state-of-the-art performance is commensurate with the subsystem performance listed below. A variety of small spacecraft buses available from various vendors have enabled integrated small spacecraft buses, including 12 and 27U CubeSat platforms. Recently, PocketQubes for Earth science missions have become more available, and many other vendors are providing engineering services to design turnkey small spacecraft platforms customized to specific mission requirements.

Power

Each year small spacecraft power subsystems benefit from improvements in solar cell efficiency, battery chemistry, and the trend of electronics miniaturization. State-of-the-art solar cells are reaching between 29-33% efficiency and advanced lithium-ion and lithium polymer batteries are reaching 250 Whkg₁. Power management and distribution (PMAD) systems are still often customized per mission, but there are increasing numbers of lightweight, robust, commercially available PMAD systems from a variety of producers. Trends in consumer electronics and improvements in solar technology driven by a new focus on renewable energy are largely to thank for these advances, as the market for small spacecraft is still too small to drive large-scale research and development (R&D).

There are many promising photovoltaic technologies in development that will increase the efficiency and/or reduce the cost and weight of solar cells. These include 46% four-junction cells, lightweight flexible solar cells at 20% efficiency, and cells that make use of cheap organic electronics. While there continue to be advances in the thermo-nuclear and fuel cell power-generation areas, more development needs to be done (largely in miniaturization) before some of these promising technologies become available for use on small spacecraft.

Propulsion

Propulsion systems for small spacecraft have consistently increased their maturity and robustness with respect to the previous report. Several institutions have made a significant effort to design, develop and test of miniaturized thrusters. Versions of larger spacecraft systems have been adapted to satisfy the power, mass and volume constraints required in small buses. Fundamental components such as regulators, valves, feed systems or tanks have also been re-designed and currently several systems have higher TRLs.

Regarding chemical propulsion systems, low complexity technologies such as cold gas systems have already flown in small spacecraft and even CubeSats. Other options such as non-toxic propellant systems or solid motors have been incorporated into existing 50-150 kg class spacecraft or are ready to be flown in the next year. Electric propulsion systems have evolved by a series of continuous testing campaigns for a wide range of technologies. Electrospays, Hall-Effect Thrusters, Pulsed Plasma Thrusters and ion engines are now ready to become fully integrated subsystems in small spacecraft missions (50 – 150 kg). This technology for CubeSats has matured since 2015, however further development is needed to improve these modules for such small platforms. Longer lead times have been associated with CubeSat propulsion systems even though several of these systems have been demonstrated in space. In regards to solar sails, recent successful demonstrations and tests have indicated a path towards the use of this propellant-less technology for both Low-Earth Orbit (LEO) and interplanetary missions.



Guidance, Navigation and Control

The current state-of-the-art for small spacecraft guidance, navigation and control (GNC) performance is 1.5 m onboard orbital position accuracy (using GPS) and pointing to better than 0.1° using reaction wheels, MEMS gyros and a star tracker. Component technology for Earth orbiting missions is mature and all key GNC components are available at TRL~9 from a variety of vendors for all small spacecraft classifications. Components for deep space small spacecraft missions have matured to reach high TRLs. Innovation in GNC is focused on miniaturization of existing technology, technology that can be sourced from a single vendor, and integrated, modular attitude determination and control units.

Structures, Materials and Mechanisms

The state-of-the-art for primary structures used for small spacecraft larger than 12U continues to be in custom in-house designs, or for tailored solutions offered by the industry to meet specific mission requirements. There have been recent attempts to establish a standard extensible bus and standard chassis in the 12U class of spacecraft. However, the benefits of this effort have yet to be realized. In the class of spacecraft smaller than 12U, there have been several unique solutions offered by a growing industry for COTS spacecraft structures and structural components. These COTS components complement the standard approach of custom designed frames (typically fabricated using milled aluminum) and have enabled a larger set of solutions for spacecraft designers. Most of the recent additions to the COTS market have been in the 3U class of CubeSats. However, there are now at least a few mature (TRL 9) COTS 6U chassis being offered. This is a class of spacecraft that has just recently begun to show signs of rapid acceleration in being adopted for flight missions. There are even 12U solutions being provided by many vendors, a sign of the industry's desire to be ready for the next thing. 3D printed primary structures have just recently reached TRL 9 status with the launch of a few missions.

Thermal Control

Thermal control management regulates the functional temperature range required throughout all spacecraft components. As small spacecraft design matures, the techniques that control the defined thermal environment must be able to meet these smaller volume and power constraints. Traditional thermal management may need additional testing and fabrication for small spacecraft applications.

Technologies such as passive louvers, non-metallic thermal straps, sunshades and cryocoolers are being designed for smaller spacecraft platforms. Better thermal management will expand small spacecraft design. Several thermal control mechanisms are currently being proposed, tested and fabricated for small spacecraft applications: thermal storage units for energy storage; stowed and deployable passive radiators; and miniaturized circulator pumps requiring minimal power input.

Command and Data Handling

Avionics solutions for small spacecraft and in particular, CubeSats, are abundant. Ongoing advances in the embedded systems industry have provided highly capable platforms and components that allow for rapid and low-cost development of command and data handling (C&DH) systems. Embedded systems have paved the way for the development of highly integrated, low mass and low power processing and control systems. A lot of COTS hardware has successfully flown in the LEO environment over short mission durations. A number of commercial vendors are providing complete, integrated avionics systems on PC/104 boards,



incorporating computer processor, memory, input/output (I/O) and electric power systems (EPS). A number of vendors source systems and components from a variety of manufacturers, which allows spacecraft developers to pick and choose components that will meet their design requirements. There are open source solutions available to those who are interested in investigating an entry-level means of developing spacecraft avionics.

As the CubeSat class of small spacecraft evolve into deep space and extended duration missions, there will be a need to address the impact of the space radiation environment. It will be necessary to develop radiation tolerant system designs to ensure mission reliability and success. Radiation hardened (rad-hard) hardware is available for a majority of the electronic components used in C&DH systems. However rad-hard devices can be significantly more costly when compared to standard COTS components. To keep development costs as low as possible, developers will undoubtedly use a combination of rad-hard components, COTS devices, shielding and mitigation techniques such as watchdog timers and memory scrubbing to reduce radiation environment impacts and improve system reliability.

Communications

Communication systems for CubeSats have largely used the VHF and UHF bands (primarily using whip antennas), or L- and S-bands (primarily using patch antennas), which have been adequate for lower-data-rate missions operating in LEO. CubeSat missions have also taken advantage of Iridium and Globalstar transponders to relay data to Earth via commercial constellations. COTS radios such as Bluetooth- and ZigBee-compatible radios also show promise for CubeSat missions.

X-band through Ka-band communication is gaining more traction as CubeSat missions become more sophisticated and require higher data throughput, with missions successfully operating beyond LEO. The higher frequencies offer more bandwidth and are less crowded, and the corresponding antennas can offer similar gain but with a smaller aperture. The drawback, however, is that the higher frequencies are more heavily attenuated by Earth's atmosphere, requiring either more power to drive the signal or a higher number of ground stations. The development of CubeSat-compatible deployable dish antennas and other higher-gain antennas are also adding to the solution.

The advent of software-defined radio (SDR) has not totally replaced hardware-defined radio. Though an SDR can operate at various frequencies and various modulation schemes with a simple change in software, and generally has a smaller footprint than hardware-defined radio, it tends to consume more power, which is a large drawback on power-constrained CubeSats. However, a counter to this drawback is that a single SDR unit can function as multiple radios at multiple wavelengths, and it can be reprogrammed in-flight.

Laser communication (lasercom) for CubeSats is a TRL 8 technology that has been demonstrated in space. While lasers onboard CubeSats have a relatively high TRL status, asymmetric laser communication is a lower TRL concept whereby the laser is hosted by a ground station, and the laser signal is modulated and passively reflected by the CubeSat back to Earth. The development of X-band and Ka-band transmitters, arrayed and deployable high-gain antennas and lasercom systems represent the new frontier of CubeSat communication systems.

Integration, Launch and Deployment

More and more small spacecraft are launched every year. Technologies in launch vehicles, integration, and deployment systems are responding to the changing small spacecraft market.



The traditional ride-share method where the small spacecraft hitches a ride in the leftover mass, volume, and other performance margins is still the primary way of putting small spacecraft into orbit. But new technological advancements show that the popularity of classical ride-sharing might decrease slowly in the upcoming years. Dedicated ride-sharing, where an integrator books a complete launch mission and sells the available capacity to multiple spacecraft operators without the need of a primary customer, is becoming more popular in the sector. Using an orbital maneuvering system which acts as an inter-stage on a launch vehicle and then propels itself after separation is another new approach.

Furthermore, ISS cargo vehicles are gaining additional capabilities to deliver secondary payloads to orbits higher than ISS altitude once their primary mission is complete. Beside any ride-share approach, more than twenty orbital launch vehicles are under development to carry payloads ranging from 5 kg to 500 kg to orbit. Some of these new systems propose to launch orbital payloads from airborne vehicles, suborbital systems, or even high-altitude balloons. A wide variety of integration services and deployment systems are also under development to keep up with the increasing launch and deployment demand of small spacecraft.

Ground Data Systems and Mission Operations

Transmitting telemetry and scientific data back to Earth in the specified quality and quantity, and tracking and commanding the spacecraft to take certain actions depend on reliable telecommunications with ground stations. Although amateur ground stations have been essential for CubeSat missions in the past, small spacecraft and ground systems are rapidly shifting to non-amateur communications, as power systems become more effective, attitude control systems more accurate, and as higher data rates are needed for science or new technology missions. In the scenario of small spacecraft missions, many companies are developing new state-of-the-art systems for ground stations. While some of them focus more on single products (such as antennas, transceiver, and simulation software) that are the cutting-edge technology yet to be validated in space missions, others consolidate and extend their services with turnkey solutions, which add more capability and availability to their already developed ground systems. Alternatives to common ground systems are inter-satellite communications, which relay data to the ground through constellations of satellites (such as Iridium or Globalstar). Still, there are a lot of new promising areas and technologies that ground data systems can explore and develop for future Small Spacecraft missions.

Passive Deorbit Systems

To constrain the amount of space debris orbiting Earth, a deorbit capability is often required. If a small spacecraft is unable to be parked in a graveyard orbit or naturally reenter Earth's atmosphere in under 25 years, a deorbit system must be integrated. In the past decade, there have only been a few advancements on passive deorbit technologies, such as drag sails and electromagnetic tethers. NanoSail-D2, CanX-7, and several TechedSat CubeSats are all CubeSat platforms that have successfully demonstrated the use of drag sails for deorbiting in LEO within the 25-year post mission requirement. Terminator Tape is another deorbit option that uses electromagnetic tethers and is currently being flown on the Aerocube-V CubeSat. Additionally, both solid rocket and electric propulsion systems have been used to increase orbit decay rates.

1.0 Introduction

1.1 Objective

The objective of this report is to assess and give an overview of the state-of-the-art in small spacecraft technologies with a particular emphasis on CubeSat platforms. It was first commissioned by NASA's Small Spacecraft Technology Program (SSTP) in mid-2013 in response to the rapid growth in interest in using small spacecraft for missions beyond LEO, and revised in mid-2015 and 2018. In addition to reporting on what is currently available, a prognosis is provided describing technologies on the horizon. This work was funded by Space Technology Mission Directorate (STMD).

1.2 Scope

A spacecraft is hereafter called a "small spacecraft" when its wet mass is below 180 kg. This definition adopts the terminology set out by NASA's Small Spacecraft Technology Program (SSTP) (National Aeronautics and Space Administration 2015). Spacecraft are generally grouped according to their mass, where small spacecraft include minisatellites with a mass of 100-500 kg, microsatellites with a mass of 10-100 kg, nanosatellites with a mass of 1-10 kg, and picosatellites with a mass below 1 kg. Figure 1.1 gives an example of the variety of spacecraft that fall into the small spacecraft category.

CubeSats are a standard for small spacecraft that weigh only a few kilograms and are based on a form factor of a 100 x 100 x 100 mm cube. CubeSats can be composed of a single cube (a "1U" CubeSat) or several cubes combined forming, for instance, 3U or 6U units. Due to their high market penetration and their increased usage in recent times, particular emphasis is put on the state-of-the-art CubeSat technology in this report. The technology tables shown in subsequent sections are not meant to be comprehensive. Their goal is to illustrate the current state-of-the-art based on desk research in a limited amount of time.

At the upper mass limit there are minisatellites like FASTSAT (Fast, Affordable, Science and Technology Satellite), NASA's first minisatellite mission launched in 2010, which had a mass slightly below 180 kg. On the lower mass end, there are projects such as KickSat-2, which aimed

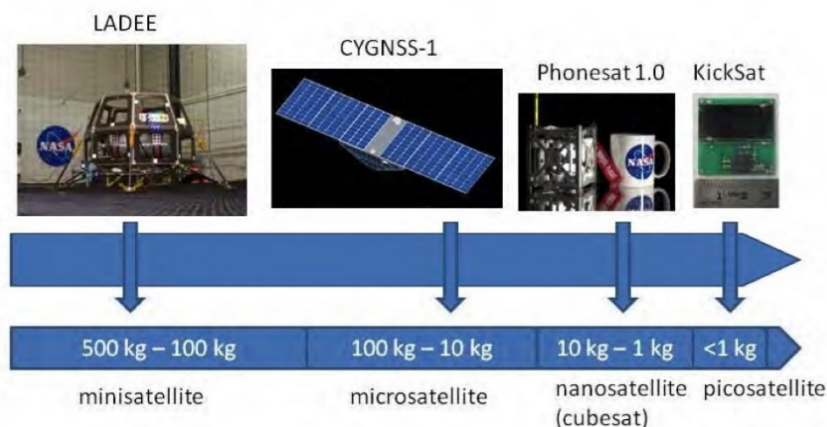

Figure 1.1: Overview of the variety of spacecraft that fall into the small spacecraft category



to deploy 100 cm scale “ChipSat” spacecraft from a 2U femtosatellite deployer. These femtosatellite ChipSats are the size of a large postage stamp and have a mass below 10 g.

1.3 Assessment

The state-of-the-art assessment of a technology is performed using NASA’s TRL scale (Figure 1.2). For this report, a technology is deemed state-of-the-art whenever its TRL is larger than or equal to 5. A TRL of 5 indicates that the component and/or breadboard has been validated in a relevant environment with documented test performance, demonstrated agreement with analytical predictions, and documented definition of scaling requirements. A relevant environment can be a simulated operational environment with realistic support elements that demonstrate overall performance in critical areas (National Aeronautics and Space Administration 2018).

A technology is considered not state-of-the-art whenever its TRL is lower than or equal to 4. In this category, the technology is considered to be “on the horizon.” A TRL of 4 is defined as a component and/or breadboard validated in a laboratory environment with documented test performance demonstrating agreement with analytical predictions and a documented definition of the relevant environment. This definition of “state-of-the-art” has been chosen because of its inherent simplicity. Clearly, old and possibly obsolete technology has a TRL larger than 5 but cannot be considered state-of-the-art. The bias in the definition has been recognized and care has been taken in the report to exclude obsolete technology from the study.

NASA standard TRL requirements for this report version are stated in the NASA NPR 7132.1B, and their processes are described in the NASA Systems Engineering Handbook 6105 Rev 2 Appendix G. Please refer to the NASA Nodis website for NASA NPR documentation. The following paragraphs have been taken from the NASA Engineering Handbook 6105 Rev 2 to highlight important aspects of NASA TRL guidelines in hopes to eliminate confusion on terminology and heritage systems.

Terminology

“At first glance, the TRL descriptions in Figure [1.3] appear to be straightforward. It is in the process of trying to assign levels that problems arise. A primary cause of difficulty is in terminology; e.g., everyone knows what a breadboard is, but not everyone has the same definition. Also, what is a “relevant environment?” What is relevant to one application may or may not be relevant to another. Many of these terms originated in various branches of engineering and had, at the time, very specific meanings to that particular field. They have since become commonly used throughout the engineering field and often acquire differences in meaning from discipline to discipline, some differences subtle, some not so subtle. “Breadboard,” for example, comes from electrical engineering where the original use referred to checking out the functional

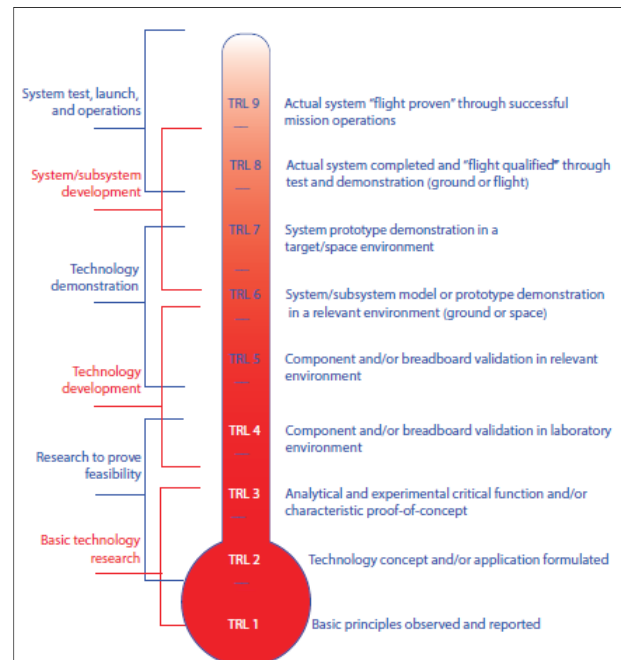

Figure.1.2: NASA’s Standard TRL Scale



design of an electrical circuit by populating a “breadboard” with components to verify that the design operated as anticipated. Other terms come from mechanical engineering, referring primarily to units that are subjected to different levels of stress under testing, e.g., qualification, protoflight, and flight units. The first step in developing a uniform TRL assessment is to define the terms used. It is extremely important to develop and use a consistent set of definitions over the course of the program/project.”

Heritage Systems

“Note the second box particularly refers to heritage systems. If the architecture and the environment have changed, then the TRL drops to TRL 5—at least initially. Per NASA Systems Engineering Handbook Rev 2253, additional testing may be required for a new use or new environment, even for heritage systems. If in subsequent analysis the new environment is sufficiently close to the old environment or the new architecture sufficiently close to the old architecture, then the resulting evaluation could be TRL 6 or 7, but the most important thing to realize is that it is no longer at TRL 9. Applying this process at the system level and then proceeding to lower levels of subsystem and component identifies those elements that require development and sets the stage for the subsequent phase, determining the Advancement Degree of Difficulty Assessment.”

1.4 Overview

This report is structured as follows: in the spacecraft section the state-of-the-art of small spacecraft technology is addressed by focusing on the spacecraft system as a whole and the current best practices of integration are presented; then, the state-of-the-art of the spacecraft subsystems are presented in turn:

1. Complete Spacecraft Platforms
2. Power
3. Propulsion
4. Guidance, Navigation and Control
5. Structures, Materials and Mechanisms
6. Thermal Control
7. Command and Data Handling
8. Communications
9. Integration, Launch and Deployment
10. Ground Data Systems and Mission Operations
11. Passive Deorbit Systems

References

1. National Aeronautics and Space Administration. "NASA's Small Satellite Missions." 2018.
2. NASA Systems Engineering Handbook. NASA/SP-2016 6105 Rev. 2.



2.0 Complete Spacecraft Platforms

2.1 Introduction

The capability of combining subsystems in a compact spacecraft platform has advanced considerably since the last edition of this report. Commercial-off-the-shelf (COTS) assembled spacecraft buses enable secondary payloads on larger launch vehicles or via dedicated rideshare opportunities on a small spacecraft launcher, thus expanding the small spacecraft market. These buses provide modular platforms upon which a payload can be hosted and ready to fly in a very short amount of time. As the platform may be purchased for any of a wide variety of missions, the subsystems are sized to be as diverse and capable as possible.

Two trends have emerged in the nanosat bus market: CubeSat component developers with a sufficiently diverse portfolio of subsystems offering package deals, and companies traditionally offering engineering services for larger bespoke platforms miniaturizing their subsystems. This chapter is divided into micro-minisatellite (wet mass 25 kg – 180 kg), nanosatellite (<24 kg) and picosatellite (<1 kg) classifications, differentiated by manufacturer. The information described is listed in alphabetical order.

The author would like to highlight that the presented tables are not intended to be exhaustive but to provide an overview of current state-of-the-art technologies and their development status for a particular small spacecraft subsystem. There was no intention of mentioning certain companies and omitting others based on their technologies.

2.2 State of the Art

2.2.1 Minisatellites

Table 2-1 is a list of the integrated platforms currently available for small spacecraft and Table 2-2 lists the small spacecraft platform specifications.

ÅAC Microtec

In collaboration between ÅAC Microtec and OHB Clyde Space, the InnoSat platform (Figure 2.1) offers around 25 kg per payload, with a total mass of ~50 kg, and dimensions of 600 x 650 x 850 mm (AAC Microtec 2018). The first mission for InnoSat will be on Mesospheric Airglow/Aerosol Tomography and Spectroscopy (MATS) developed in collaboration with OHB Sweden, ÅAC Microtec, Department of Meteorology (MISU) at Stockholm University, Department of Earth and Space Sciences at Chalmers, Space and Plasma Physics Group at KTH and Omnisys Instruments, and is funded by the Swedish National Space Board (SNSB) (Department of Meteorology, Stockholm University 2018). MATS is scheduled to launch as a secondary payload in 2019, and will be put into a 600 km dawn/dusk, circular, sun-synchronous orbit.

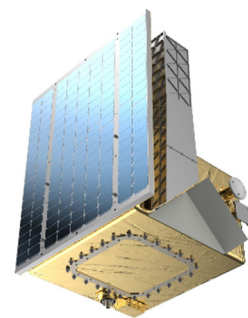

Figure 2.1: InnoSat platform by AAC Microtec and OHB Clyde Space. Image courtesy of AAC Microtec.

Adcole Maryland Aerospace (AMA)

AMA has developed a low-cost integrated platform called the MagicBus. This minisatellite is equipped with accurate attitude control (see Table 2-2), communications encryption, propulsive orbit maintenance capability (650 m/s from hydrazine and 16 m/s from Nitrogen cold gas), and an electro-optical imaging configuration featuring a 25 cm aperture telescope (Adcole MARYland Aerospace 2018). The scalable dimensions are 38.1 x 96.5 cm to 45.7 x 45.7 x 106.7 cm with a



total system mass of 50 – 100 kg. Kestrel Eye is a collaborative project between the U.S. Army Space and Missile Defense Command and the U.S. Army Forces Strategic Command. The two Kestrel Eye-2M spacecraft are based on the MagicBus platform (Kestrel Eye 2018). The minisatellites were launched from the International Space Station (ISS) in the fall of 2017, and have operated nominally.

Berlin Space Technologies

Berlin Space Technologies manufactures a series of small spacecraft platforms named the LEOS-30 TRLX, LEOS-50 TRLX, and LEOS-100. The LEOS platforms are based on designs flown for multiple TUBSAT and LAPAN missions (European Space Agency 2015). A LEOS-50 platform was launched as a secondary payload in December 2015 as part of the Kent Ridge 1 (80 kg) mission, and Berlin Space Technologies are in the early stages of delivering 10 LEOS-100 platforms for their new India-based satellite factory for a constellation contract (Buhl, Danziger and Segert 2015); (Segert 2015).

The LEOS-30 is a 20 kg spacecraft, with a 5-8 kg payload capacity. UHF and S-band communications are provided, and the system is designed for a 2-year operational lifetime. The LEOS-50 (Figure 2.3) is a 50 kg spacecraft with a 15-25 kg payload capacity (Berlin Space Technologies GmbH 2015). UHF communications are provided for telemetry and control, while a 100 Mbps X-band link is available for data downlink. The Attitude Determination and Control System (ADCS) provides 1 arcmin pointing accuracy and 10 arcsec pointing knowledge with a $10^\circ/\text{s}$ slew rate and less than 15 arcsec/s jitter. The vehicle is 600 x 600 x 300 mm, provides an average of 20 W payload power within a payload volume of 400 x 400 x 200 mm and is designed for an operational lifetime of 5 years (Blue Canyon Technologies 2015).

The LEOS-100 is a larger structure reusing the LEOS-50 avionics. Due to the larger mass it provides 1 arcmin pointing accuracy and 2.5 arcsec pointing knowledge with a $5^\circ/\text{s}$ slew rate and less than 5 arcsec/s jitter. The vehicle is 600 x 600 x 800 mm with a mass of 65 kg, and the payload volume is 500 x 500 x 500 mm with an allowance of 30-50 kg. The larger vehicle generates more solar power and can provide 60 W average power to the payload, while the X-band communications have also been upgraded to 400 Mbps. The LEOS-100 also has options for 2 Gbps optical data downlink and cold gas or electrical propulsion (Blue Canyon Technologies 2015).

SITAEL

Italian space company SITAEL has developed two minisatellite platforms: S-50 and S-75. The S-50 is the smaller platform, measuring 340 x 340 x 660 mm with a launch mass of 50 kg including 20 kg allocated for the payload. The S-50 is the first spacecraft bus developed by SITAEL (SITAEL 2018). The S-75 platform, Figure 2.2, measures 320 x 320 x 400 mm with a maximum launch mass of 75 kg maximum, allowing for a 20 kg payload. This platform has the added capability for Hall Effect electric propulsion, deployable solar arrays, and fine attitude control (SITAEL 2018). On both S-50 and S-75, the integrated subsystems are stored in aluminum trays to allow for easier payload integration.



Figure 2.2: S-75 platform. Image courtesy of Sitael S.p.A.



While the S-50 platform was selected for the European Student Orbiter mission by ESA in 2012, the program has since been cancelled. With all lab testing and verification having been performed, the TRL for this bus is 7. The TRL for the S-75 will soon reach 9 once the upcoming μ HETSat mission launches from Virgin Orbit's LauncherOne early 2019 (SITAEL 2018). The μ HETSat mission, a collaborative project between ESA and ISA, will validate in-space the S-75 platform as well as the new electric propulsion system (Hall Effect Thrusters). Additionally, the S-75 platform will be used for the Maiden mission for the STRIVING project, which is an In-Orbit Demonstration/Validation (IoD/IoV) service with the Vega's Small Spacecraft Mission Service (SSMS) Proof Of Concept (POC) flight program that will launch small satellites from a Vega rocket in 2019 (Misuri, Stanzone and Mele 2017).

Spaceflight Industries

Spaceflight Industries have established a joint venture with Thales Alenia Space called LeoStella. LeoStella will be taking over the development and production of the Spaceflight satellite products, with a focus of satellites ranging from 10 - 300 Kg in size. The "Global" microsatellite for imaging missions is a 55 kg electro-optical platform that will be used for the BlackSky constellation. As of Spring 2018, Global-1, the first of four spacecraft of the Earth observation mission, completed tests and qualification. These spacecraft are based on the SENTRY platform developed at Spaceflight Industries. BlackSky-1 pathfinder (44 kg), launched September 2016, was also based on the SENTRY bus (European Space Agency 2018). Specifics on this platform are unknown.

Surrey Satellite Technology Limited (SSTL)

Surrey Satellite Technology Limited (SSTL) has a long legacy of small spacecraft in orbit. There are more than eight of the SSTL-100 in orbit, and more than ten of the SSTL-150, along with a version modified to fit the ESPA ring called the SSTL-150 ESPA. A variant with reduced capabilities from the SSTL-150 is the SSTL-X50. This platform has a baseline envelope of 650 x 650 x 720 mm; satellites using the platform weigh around 100 kg at launch (Surrey Satellite Technology Ltd. 2015). The SSTL-X50 Precision platform is a compact next-generation satellite capable of high resolution in panchromatic and multispectral wavebands. There are four of the X50 platforms available: EarthMapper, TrueColor, Precision, and Platform.

KazSTSAT (50 kg) and Carbonite 2 (100kg) have been in orbit since 2017 and are based on the EarthMapper platform (Surrey Satellite Technologies, Ltd. 2018). The RemoveSat spacecraft, from the RemoveDebris mission, is based on the X50 series and was launched from NanoRacks in June of 2018.

University of Toronto Institute for Aerospace Studies Space Flight Laboratory (UTIAS SFL)

The Space Flight Laboratory (SFL) at the University of Toronto Institute for Aerospace Studies has extensive experience on building integrated small spacecraft platforms and collecting on-orbit data for their various smallsat missions. In their microsatellite classifications, SFL provides the Defiant and Nautilus platforms.

The scalable Defiant platform can accommodate a variety of mission requirements, and provides a core structure and avionics with the same heritage as the NEMO platform but without the need for the XPOD. With a prime form factor of 300 x 300 x 400 mm (27U), there is a 10 kg maximum payload allocation and a full suite of modular power electronics (University of Toronto Institute for Aerospace Studies Space Flight Laboratory 2018). This platform will be flown on a classified mission, Gray Jay, in LEO. Currently, the platform is concluding environmental tests before launch, and is at TRL 7.



The Nautilus (Nemo-150) bus offers up to 70 kg in payload mass with 50 W payload power, up to 50 Mbps downlink capability, and has an envelope of 600 x 600 x 600 mm (typical specifications). There is also a separation service that provides propulsive capabilities of cold gas, resistojet, monopropulsion, and Hall Effect thrusters (University of Toronto Institute for Aerospace Studies Space Flight Laboratory 2018). This platform will be demonstrated on the Nanosatellite for Earth Monitoring and Observation–High Definition (NEMO-HD) mission that underwent environmental tests in September 2017 (University of Toronto Institute for Aerospace Studies Space Flight Laboratory 2018). With a launch contract currently in progress, the TRL for this bus is at 7.

Table 2-1: Integrated Minisatellite Platforms			
Product	Manufacturer	TRL Status	Radiation Testing (krad)
InnoSat Platform	ÅAC Microtec and OHB Sweden	7	*Contact vendor
MagicBus	Adcole Maryland Aerospace	9	*Contact vendor
TET-1	Astro-und Feinwerktechnik Adlershof	9	13
BST LEOS-30/50/100	Berlin Space Technologies	8	LEO parts heritage
Global-1	LeoStella	8	*Contact vendor
MAC-100	Magellan Aerospace	9	*Contact vendor
S-50/S-75	SITAEL	7/8	*Contact vendor
SSTL-100/150/X-50	Surrey Satellite Technology Ltd.	9	5
DEFIANT/ NEMO-150	UTIAS SFL	9	*Contact vendor

**Table 2-2: Integrated Small Spacecraft Platform Specifications**

Product	Vehicle Size (mm)	Payload Mass (kg)	Payload Power (W)	Point Control (arcsec)	Pointing Knowledge (arcsec)
AF Adlershof TET-1	670 x 580 x 880	50	Unkn.	2	10
BST LEOS-30	Unkn.	20	Unkn.	Unkn.	Unkn.
BST LEOS-50	600 x 600 x 300	50	20	1	10
BST LEOS-100	600 x 600 x 800	65	60	1	2.5
DEFIANT	300 x 300 x 400	5-10	Up to 65	Unkn.	Unkn.
InnoSat	600 x 650 x 850	25	40	Unkn.	Max 0.01 deg pointing knowledge error
Nemo-150	600 x 600 x 600	Up to 70	>50	Unkn.	Unkn.
MAC-100	Unkn.	50	65	$\pm 2^\circ (3\sigma)$	$\pm 1^\circ (3\sigma, \text{ in each axis})$
MagicBus	450 x 450 x 960	Unkn	Up to 200	$\pm 0.15^\circ 3\sigma$	$0.01^\circ 3\sigma$
S-50	340 x 340 x 660	20	26	Up to 0.1°	Up to 0.01°
S-75	320 x 320 x 400	Unkn.	30	Up to 0.1°	Up to 0.006°
SLI SCOUT	400 x 460 x 840	55	95	3	18
SSTL-100	Unkn.	20	40	Unkn.	Unkn.
SSTL-150	600 x 600 x 300	50	20	1	10
SSTL-150 ESPA	600 x 600 x 800	65	60	1	2.5
SSTL-X50	600 x 600 x 800	75	60	1	2.5



2.2.2 CubeSats

Table 2-3 and Table 2-4 list the overall current available integrated nanosatellite platforms.

AAC – Clyde

The high performance nanosatellite platforms offered at AAC - Clyde range from 1U to 12U, with a respectable payload volume ranging from 0.2U – 8U. Each of these platforms, with the exception of the 1U form factor, offers propulsive capability from 25 m/s to 500 m/s delta V (AAC Microtech and Clyde Space 2018). The 3U is currently on orbit for Kepler Communications and a second 3U platform is planned to launch later this year (Karlsson 2018). Figure 2.3 shows the 6U platform that the NSLSat1 mission will be based upon to demonstrate technology providing Ka-band communications from space (SpaceTech Expo 2018).

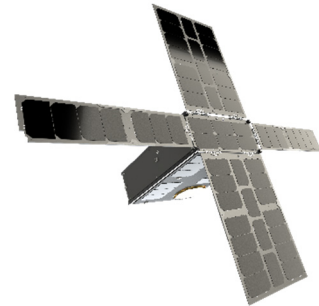

Figure 2.3: 6U Platform. Image courtesy of AAC-Clyde.

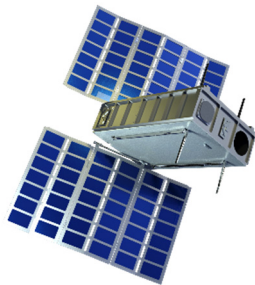

Figure 2.4: MAI-6000 platform. Image courtesy of Adcole Maryland Aerospace.

Adcole Maryland Aerospace (AMA)

The nanosatellite platforms offered by Adcole Maryland Aerospace are the MAI-3000 and -6000, which is the 3U and 6U form factor, respectively. See Figure 2.4 for the 6U variant. Besides the allocated payload volume and power consumption, there are similar systems in the 3U and 6U platforms: both form factors can incorporate MMA HaWK solar arrays in either gimbaled or fixed configuration, are equipped with the MAI-500 ADCS system which provides 0.01 deg pointing control with use of the MAI star tracker; and have the SCR-100 CubeSat Flight Transceiver developed by Innoflight, Inc (Adcole Maryland Aerospace 2018) which can be configured for downlink rates of 2.0 Mbps or more in S-band using either AES-256 or NSA approved Type 1 encryption. The MAI-3000 3U CubeSat bus provides on-orbit

average power of 12 W and 4 kg of payload mass; the MAI-6000 bus provides on-orbit average power of 20 W and 12 kg of payload mass (Adcole Maryland Aerospace 2018).

Blue Canyon Technologies, Inc.

Blue Canyon Technologies Inc. is a small business specializing in micro-sized spacecraft ranging from 3U to ESPA class. They offer several nanosatellite integrated buses: XB3 (3U), XB6 (6U), and XB12 (12U). (Note: The XB1 platform has been removed from BCT, however the tested XB1 avionics are used in both XB3 and XB6).

The XB3 and XB6 spacecraft specialize in high accuracy pointing with 0.002°, 1 arc-sec/ 1-sec pointing stability, and a slew rate of 10°/s for a typical 3U CubeSat. The BCT XB3 platform (and integration services) were first demonstrated on APL's RAVAN mission in 2016 (Figure 2.5). The XB6 was used for the following missions, launched in May 2018: OSU/NASA Goddard/JPL CubeRRT mission (CubeSat Radiometer Radio Frequency Interference Technology [CubeRRT] Validation Mission 2018), the University of Iowa/NASA Goddard HaloSat mission, and the CSU/JPL TEMPEST-D mission.

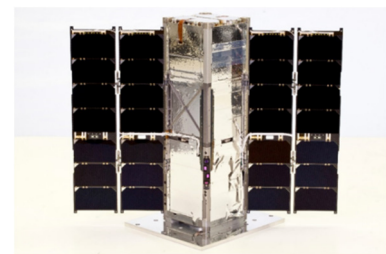

Figure 2.5: BCT XB3 Spacecraft Bus for the APL RAVAN Mission. Image courtesy of NASA.



GomSpace ApS

The GOMX bus in Figure 2.6 from GomSpace of Denmark produces a series of CubeSat under the moniker GOMX. The avionics provide 5° pointing knowledge and 10° pointing control, and include a UHF/VHF radio link. There are 1U, 2U, 3U, and 6U variants available, directly affecting the payload volume and mass, and the variation in surface area affects available power from the solar panels (GomSpace ApS 2015).

The GOMX-1 mission flown by Aalborg University launched a 2U configuration on a Dnepr in 2013, hosting an automatic dependent surveillance-broadcast (ADSB) receiver. The GOMX-2 reflight was destroyed in the CRS-3 launch. In August 2015, GOMX-3 delivered a 3U configuration to ISS via a Japanese H-IIB rocket that was launched April 2017 (GomSpace 2015). GomSpace recently launched their fourth demonstration mission in February 2018; the GOMX-4 mission consisted of two 6U platforms that include Earth observation and inter-satellite communication payloads (GomSpace 2018).



Figure 2.6: GomSpace GOMX bus. Image courtesy of GomSpace.

Innovative Solutions in Space

There are several preconfigured CubeSat platforms that are available at Innovative Solutions in Space: 2U, 3U, and 12U. The 2U bus can accommodate a payload of 1 kg with 1.5 W average power, and <math><10^\circ</math> pointing accuracy. The 3U platform offers a scalable payload volume (1.5 – 2U), and has a payload mass of up to 2 kg. The average payload power varies from 2 – 3.5 W and has a pointing accuracy down to 1°. Their 12U platform offers 5-10 kg payload mass, 10 W average payload power and pointing accuracy of <math><0.2^\circ</math>. This bus is also equipped with the option for a propulsion module (Innovations Solutions in Space 2015).

Millennium Space Systems (MSS)

Millennium Space Systems has completed a demonstration of the Altair1, or Altair Pathfinder, a 6U CubeSat that scales-down the original Altair 27U small spacecraft avionics and architecture (Millennium Space Systems, Inc. 2015). The Altair 1 CubeSat (14 kg) was deployed May 2017 from the NanoRacks CubeSat Deployer (NRCSD) commercial launch service, and has operated nominally. The 27U Altair spacecraft bus concept from the Airborne Launch Assist Space Access (ALASA) DARPA program was cancelled in 2015. Additionally, the Altair spacecraft line has evolved for a 6U, 12U, 27U, and ESPA class low-cost spacecraft. There are multiple programs flying different versions of the Altair line in 2018 and 2019 (Scardera 2018).

NanoAvionics

There are three integrated nanosatellite form factors developed at NanoAvionics: 6U (M6P), 3U (PLT3), and 2U (PLT2). The standard configuration of the multifunctional 6U platform M6P was the first preconfigured bus designed to support mission requirements for Internet of Things (IoT) communications, Earth observation and commercial applications (NanoAvionics 2018). This bus (Figure 2.7) has a 7.5 kg payload allocation and includes an in-house, green enabling propulsion system for small satellites (EPSS). In April 2018, NanoAvionics signed a contract with Lacuna Space to support a demonstration of an Internet of Things (IoT) communications network



Figure 2.7: M6P Platform. Image courtesy of NanoAvionics.

comprised of 32 spacecraft using the M6P bus; it is planned to launch near the end of 2018 (Karaliunaite 2018).

Figure 2.8 shows the PLT3, a 3U platform that has an optional propulsion system in addition to a 4 kg payload mass allocation. Of similar design is the 2U PLT2 which provides a 2 kg payload allocation. All platforms are pre-integrated mechanically, electrically and functionally tested, and are pre-qualified for easy payload integration (NanoAvionics 2018). They all use NanoAvionics ADCS sensors and actuators (sun sensors, reaction wheels, and magnetorquers), and are 3-axis stabilized; the M6P has $\pm 0.5^\circ - \pm 2.5$ attitude control accuracy; the PLT3 and PLT2 have ± 5 deg attitude control accuracy.



Figure 2.8: PLT3 Platform. Image courtesy of NanoAvionics.

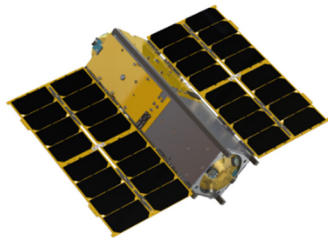

Figure 2.9: MISC 3U. Image courtesy of Pumpkin, Inc.

Pumpkin, Inc.

Since 2000, Pumpkin Inc. has provided smallsat subsystem solutions and thousands of hardware elements to space missions. Complete pre-configured small spacecraft platforms include the 3U MISC 2 Mk II and MISC3. The MISC2 Mk II is a 3U structure allowing for 100 x 100 x 165 mm payload volume, with pointing provided by the MAI-100 ADCS from Maryland Aerospace Inc. The MISC 3 (Figure 2.9) also provides a 3U structure allowing for a 100 x 100 x 340 mm payload volume. ADCS solutions are optionally the MAI-400 from Maryland Aerospace Inc. or a BCT XACT from Blue

Canyon Technologies (Pumpkin, Inc. 2015). The MISC 3 has been space-proven several times, with a recent Nov 2017 launch with the Australian Defense Science and Technology (DST) Group's Buccaneer Risk Mitigation Mission (BRMM) on a Delta II from Vandenberg AFB (Pumpkin, Inc. 2018).

Surrey Satellite Technology Ltd

Surrey Satellite Technology Ltd. from the UK is focusing on their larger form factors (50+ kg) (Eisele 2015), but they also offer two CubeSat platforms. The Cube-X and Nano-X platforms are available in 3U, 6U, 12U and 24U, resulting in a total launch mass of 5 to 20 kg.

Tyvak NanoSatellite Technology, Inc.

Tyvak NanoSatellite Technology Inc. introduced their Endeavour platform product line in 2014, which is available in a variety of form factors from 3U to 12U (Tyvak NanoSatellite Systems Inc. 2012). The 3U variant weighs 5.99 kg with payload, allows 2U payload volume, and offers 15 W payload average power. The ADCS provides 0.06° pointing control and 25 arcsec pointing knowledge, and $3^\circ/s$ slew rate using reaction wheels and torque coils. Endeavour generates up to 70 W power and provides S-band communications of 10 Mbps in addition to the UHF offering. Figure 2.10 shows a tailored version of the Endeavour bus used for NASA's CubeSat Proximity Operations Demonstration (CPOD) mission, where two 3U Endeavour spacecraft are scheduled to fly in mid-2018 (Tyvak NanoSatellite Systems Inc. 2015). This platform was also used in JPL's RainCube mission, launched May, 2018 (JPL 2018).



Figure 2.10: Endeavour spacecraft for CPOD mission. Image courtesy of Tyvak.



UTIAS SFL

The Space Flight Laboratory (SFL) at the University of Toronto Institute for Aerospace Studies has a variety of integrated nanosatellite platform buses from 3.5 kg to 15 kg total mass that have flown in LEO on several missions. The smallest is called Thunder, a 3U bus that offers up to 2 W payload power, 1 Mbps downlink capability, and a cold gas propulsion system (University of Toronto Institute for Aerospace Studies Space Flight Laboratory, 2018). It has been space-proven on CanX-2 and CanX-7 missions (launched in 2009 and 2016 respectively). The Gryphon Bus (GNB) provides a 7 kg platform that offers up to 4 W of payload power, 2 Mbps downlink capability, and a cold gas propulsion system. This bus has smallsat mission heritage on the AISat Constellation (launched in 2010). SFL's Next-generation Earth Monitoring and Observation (NEMO) platform is 15 kg and provides up to 45 W payload power and 6 kg of payload mass, with a variety of propulsion systems available including cold gas, resistojet and monopropulsion.

The NEMO bus has flight heritage on Norsat-1 and -2 (launched July 2017). In January 2018, SFL announced that NorSat-3 will be constructed for the Norwegian Space Center; that satellite will use the NEMO platform (University of Toronto Institute for Aerospace Studies Space Flight Laboratory 2014). This platform will also fly on the Nanosatellite for Earth Monitoring and Observation-Aerosol Monitoring (NEMO-AM), which is a collaboration between UTIAS SFL and Indian Space Research Organization (ISRO) (due to launch in 2019), and for the HawkEye Pathfinder CubeSat missions which launched December, 2018 (University of Toronto Institute for Aerospace Studies Space Flight Laboratory 2014).

Product	Manufacturer	Status	Radiation Testing (krad)
1U, 3U, 6U	AAC – Clyde	TRL 9	Unkn.
3000 3U CubeSat Bus	Adcole Maryland Aerospace	*Contact	20 - 30
6000 6U CubeSat Bus	Adcole Maryland Aerospace	*Contact	20 - 30
3U CubeSat Bus	Innovative Solutions in Space	TRL 9	Unkn.
Complete CubeSat Kits	Pumpkin Inc.	TRL 9	Unkn.
GOMX	GomSpace	TRL 9	10
GRYPHON	UTIAS SFL	TRL 9	Unkn.
Altair 1	MSS	TRL 9	Unkn.
M6P	NanoAvionics	TRL 8	20
NEMO	UTIAS SFL	TRL 9	Unkn.
PLT3	NanoAvionics	TRL 9	20
Nukak	Sequoia Space	Unkn.	Unkn.
THUNDER	UTIAS SFL	TRL 9	Unkn.
XB3, XB6, XB12	Blue Canyon Technologies LLC.	TRL 9	> 5 years design life

*Contact vendor for more information



Table 2-4: Integrated Nanosatellite Platform Specifications					
Product	Vehicle Size (mm)	Payload Mass (kg)	Payload Power (W)	Point Control	Pointing Knowledge
2U Bus (ISIS)	100 x 100 x 227	1	1.5	Unkn.	<5°
3U Bus (ISIS)	100 x 100 x 341	1-2	10	Unkn.	< 0.1°
12U Bus (ISIS)	226 x 226 x 341	5-10	10	Unkn.	< 0.05°
3U Platform "PLT3"	114 x 114 x 340	4	Unkn.	1°-2.5°	0.8°-2.3°
AAC-Clyde 1U	113 x 100 x 100	0.2U	2	<5°	0.020°/s
AAC-Clyde 3U	227 x 100 x 100	1.5U	60	<0.1°	0.005°/s
AAC-Clyde 6U	340 x 226 x 100	4U	100	<0.05°	0.002°/s
3000 3U CubeSat Bus	100 x 100 x 300	8 (total) 4 (payload)	12	0.1°(star tracker) 1.1° (Earth limb sensor)	0.01° (star tracker) 1° (Earth limb sensor)
6000 6U CubeSat Bus	100 x 200 x 300	16.9 (total) 12 (payload)	20	0.1° (star tracker) 1.1° (Earth limb sensor)	0.01° (star tracker) 1° (Earth limb sensor)
3U CubeSat Bus	100 x 100 x 300	2	2	10deg	Unkn.
GRYPHON	200 x 200 x 200	2 (payload), 7 total	4	Unkn.	Unkn.
MSS Altair1	100 x 100 x 600	14 (total)	Unkn.	Unkn.	Unkn.
Multifunctional 6U platform "M6P"	380.1 x 18.87 x 236	7.5	Unkn.	1°-2.5°	0.8°-2.3°
NEMO platform	200 x 200 x 400	15 (total) and 6 (payload)	45	1 arcmin	Unkn.
THUNDER	100 x 100 x 340	1 (payload) 3.5 (total)	2	Unkn.	Unkn.
XB3	100 x 100 x 300	*1.5	*<6.3	±0.002° or 7.2arcsec	±0.002° or 7.2arcsec
XB6	100 x 200 x 300	*1.5	*<6.3	±0.002° or 7.2arcsec	±0.002° or 7.2arcsec
XACT	100 x 100 x 500	*0.91	<2.6 orbit avg	±0.003 deg (10.8arcsec) (1-sigma) for 2 axes; ±0.007 deg (25.2 arcsec)(1-sigma) for 3rd axis	±0.003 deg (10.8arcsec) (1-sigma) for 2 axes; ±0.007 deg (25.2 arcsec)(1-sigma) for 3rd axis

* Same avionics, but the payload mass is extremely variable with solar array config, attitude control maneuvers, and onboard experiments

2.2.3 Picosatellites

As described in the Introduction, picosatellites, or PicoSats and femtosats, are defined as spacecraft with a total mass of 0.1 – 1 kg. In this classification, the PocketQube has been defined as half the size of a 1U CubeSat in 5 cm cubed dimensions, or 1P, where P = 1 PocketQube unit, one-eighth the volume of a CubeSat (The PocketQube Standard 2018). The mass of these spacecraft vary from 0.15 – 0.28 kg and have been categorized as “1P,” “2P,” and “3P.” Table 2-5 describes the current specifications for PocketQube platforms (according to 1st Issue of The PocketQube Standard).

Units (P)	Dimensions (mm)	Mass (kg)	Payload Mass (kg)	Power (W)	Payload Power (W)	Pointing Control (deg)
1P	50 x 50 x 50	0.15 – 0.28	0.1	0.25	Unkn.	NA
2P	50 x 50 x 114	<0.5	0.3	1	0.5	NA
3P	50 x 50 x 178	<0.75	Unkn.	5	<5	5

The first PocketQube was proposed in 2009 for an academic evaluation of a cost-effective method for engaging students in space sciences. Four PocketQubes were launched in November, 2013, on a Dnepr rocket via the Morehead Rome Femto Orbital Deployer attached to the UniSat-5 microsatellite (Wikipedia 2018). As 1P equates to 1/8 CubeSat volume, that means the cost for a single PocketQube unit is roughly 1/8th the cost of a 1U CubeSat, which is around \$20k (R J Twiggs 2014). Due to their reduced cost, they have become popular for kick-starter companies, and amateur radio satellite designers. Since 2013, several companies and universities have shown an interest in PocketQube design as there are more than twenty PocketQubes currently in development.

Besides educational purposes, there is a desire to develop these small form factors for Earth observation and telecommunications missions. As these types of missions require high power for heavy data transmission and a fine ADCS for strict pointing requirements, there is a clear obstacle for this class of spacecraft to fully overcome. However, a 2P picosatellite is estimated to be 50% the cost of a 3U CubeSat mission with launch (Alba Orbital 2018), and with the immensely reduced cost, these constrained MEMS components can be customized and tested, all within the budget of a typical CubeSat mission.

Alba Orbital

Alba Orbital provides COTS PocketQube platforms. Unicorn-1 (Figure 2.11) is based on Alba Orbital's modular 2P platform and is planned to launch on UniSat-7 from GAUSS Srl. This platform has a payload volume of 1P (50 x 50 x 50 mm, approximately 0.1 kg, with 0.49

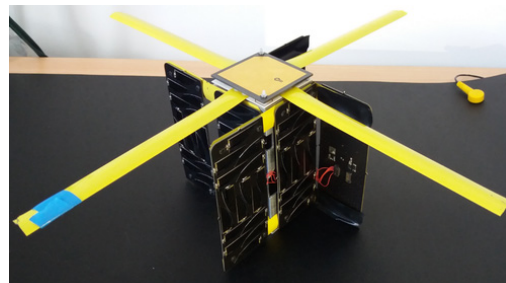

Figure 2.11: Unicorn-1 PocketQube. Image courtesy of Alba Orbital.

kg total mass); the payload of Unicorn-1 is an S-band InterSatellite Link radio, designed at Alba Orbital.

The Unicorn-2 platform is based on the 3P integrated platform (Figure 2.12), and is also planned to launch on UniSat-7 on an Albapod. The EPS consists of Li-ion batteries and in-house quadruple deployable solar panels for an average orbit power of around 15 W. This spacecraft will demonstrate the first PocketQube ADCS: 2-axis sunsensors, four light dependent resistors, three brushless motors with reaction wheels and three axis magnetometer and magnetorquers, all designed at Alba Orbital. Their UHF and S-band modules can downlink up to 200 kbps.

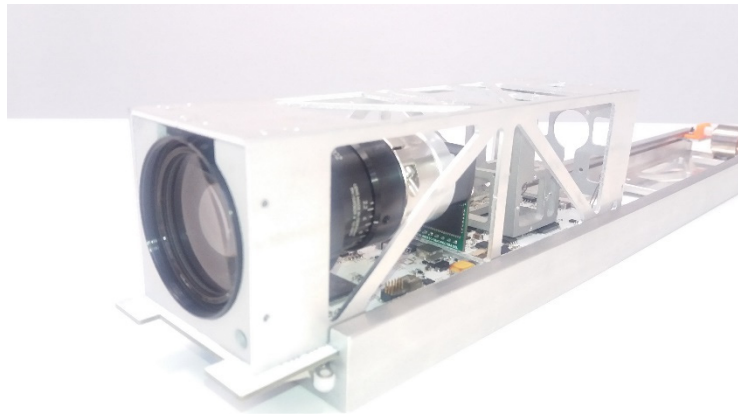

Figure 2.12: P3 PocketQube with Camera. Image courtesy of Alba Orbital.

Delft University of Technology

Delft University of Technology has developed several small spacecraft missions, and has recently established a PocketQube bus called the Delfi PocketQube (Delfi-PQ). The purpose of the Delfi-PQ mission is to demonstrate the PocketQube platform as a matured PocketQube bus. Development of both the core platform (consisting of EPS, on-board computer (OBC), structure, radio, and thermal control) and the ground segment started in January, 2016. TU Delft will start developing a PocketQube sized propulsion system as well as an ADCS soon, so one or both of these are likely technology demonstration candidates for the first Delfi-PQ (Delft University of Technology 2016).

Airbus Defense and Space Netherlands is a cooperative partner in Delfi-PQ. Airbus provides support for mechanical and thermal analysis and design and Delfi-PQ will host an Airbus payload related to thermal control (Delft University of Technology 2016).

Picosat Systems

Picosat Systems provides small spacecraft solutions and has developed the OzQube-1 bus that is based on a 1P modular platform with separate subsystems connected together via a common backplane of a PocketQube (PQ-60 'standard'). This bus went through a trial deployment from a hand-held deployer on a zero-G flight above France, but has not undergone radiation testing. The power supply for the payload allows up to 1.32 W, however the actual payload will draw <1.25 W during image capturing. The onboard battery supplements the generated power by the solar panels, and the AOP has a range of 0.225 – 0.25 W for the sun synchronous orbit (McAndrew, 2018).



Product	Manufacturer	TRL Status
2P (modular) Unicorn-1	Alba Orbital	5
3P (integrated) Unicorn-2	Alba Orbital	5
Delfi-PG	Delft University of Technology	5
OzQube-1 platform	Picosat Systems	4

2.3 On the Horizon

As spacecraft buses are combinations of the subsystems described in later chapters, it is unlikely there will be any revolutionary changes in this chapter that are not preceded by revolutionary changes in some other chapter. As launch services become cheaper and more commonplace the market will expand, allowing universities and researchers interested in science missions to purchase an entire spacecraft platform as an alternative to developing and integrating it themselves. As subsystems mature they will be included in future platforms offered by vendors, which will continue to gain flight heritage and improve their platforms to increase performance as newer vendors emerge into the market. This is demonstrated in the use of PocketQubes and their requirement to satisfy ultra-low mass and volume constraints, while simultaneously enabling high performance capabilities. Currently, these smaller form factors still need to perform relevant environment and radiation testing, which is planned for late 2018 to early 2019.

As the industry matures, we will likely see key advancements in radiation tolerance and radiation hardening, especially as small spacecraft start venturing into deep space. Subsystems described later in this report include details on radiation testing, but a subsystems' mean time between failures (MTBF) and overall system reliability will become key design criterion as the sample groups become large enough to be statistically significant.

2.4 Summary

A number of vendors have pre-designed, fully integrated small spacecraft buses that are space rated and available for purchase. Due to the small market they will of course cooperate with customers to customize the platform. This archetype is continued in the CubeSat form factor, but a new design concept has also emerged: due to the CubeSat standard interfaces, many interchangeable standardized components are available, leveraging consumer electronics standards to approach the plug and play philosophy available for terrestrial PCs and computer servers. In particular, CubeSat communications and guidance, navigation and control subsystems have matured significantly. Small spacecraft vendors are building preconfigured platforms with smaller and larger variants to meet the majority of potential smallsat needs. Since the last edition of this report there are more available buses that offer scalability, propulsion integration, and proven avionics.

While there have been developments in smaller form factors such as Pico/Femtosats, they have not been widely accepted as conventional spacecraft due to their volume, power and data constraints. There is a small collection of flight heritage for PocketQubes, which all demonstrated



their technology capability, but the desire to have these ultra-small spacecraft perform Earth observation and telecommunications missions is a little daunting. By 2020, there will have been a great leap towards exposing these <1 kg form factors in low Earth to Geosynchronous orbit.

References

AAC Microtech and Clyde Space. 2018. "Nanosatellite Platform Range."

AAC Microtech. 2018. "*Small Satellite Platforms.*" <http://aacmicrotec.com/products/small-innosat-platform/>.

Adcole Maryland Aerospace. 2018. "*MAGICBus 50 kg - 180 kg Satellite Platform, Express Class Satellite - Low Mission Cost, Accelerated Production.*" <https://www.adcolemai.com/magicbus-smallsat-1>.

Adcole Maryland Aerospace. 2018. "MAI-3000."

—. 2018. "MAI-6000."

Alba Orbital. 2018. "*Unicorn-2 Platform.*" July. Accessed August 2018. <http://www.albaorbital.com/unicorn2/>.

Berlin Space Technologies GmbH. 2015. "*Berlin Space Tech.*" http://www.berlin-space-tech.com/index.php_id=33.html.

Blue Canyon Technologies. 2015. "*Space Missions: Space Buses.*" <http://bluecanyontech.com/space-missions/#spacebuses>}.

Buhl, Matthais, BJ Danziger, and Tom Segert. 2015. "Small Satellites Made in Berlin." Berlin.

2018. "*CubeRRT (CubeSat Radiometer Radio Frequency Interference Technology) Validation Mission.*" 2016 IEEE Aerospace Conference.

Delft University of Technology. 2016. "*Delfi-PQ Mission.*" Accessed 2018. <http://delfispace.nl/delfi-pq>.

Department of Meteorology, Stockholm University. 2018. "*MATS – the Next Swedish Research Satellite.*" <https://www.misu.su.se/research/mats>.

Eisele, S. 2015. "Personal Correspondence."

European Space Agency. 2018. "*BlackSky Global Commercial Imaging Constellation.*" May. Accessed July 31, 2018. <https://directory.eoportal.org/web/eoportal/satellite-missions/b/blacksky-constellation>.

—. 2015. "*LAPAN-A2 - eoPortal Directory - Satellite Missions.*" <https://directory.eoportal.org/web/eoportal/satellite-missions/l/lapan-a2>.

Gomspace ApS. 2015. "*Platforms.*" <http://gomspace.com/index.php?p=products-platforms>}.



- GomSpace. 2018. "GomSpace's Fourth Demonstration Mission is Successfully Launched – Intended to Pioneer the Advanced." <https://gomspace.com/news/gomspaces-fourth-demonstration-mission-is-suc.aspx>.
- . 2015. "GOMX-3 (GomSpace Express-3)." <https://directory.eoportal.org/web/eoportal/satellite-missions/g/gomx-3>.
- Innovations Solutions in Space. 2015. "Company Presentation." July. Accessed July 31, 2018. https://www.mzv.sk/documents/10182/1692552/141126_ISIS_Innovative_Solutions_In_Space_Slovakia.pdf.
- JPL. 2018. "Radar in a CubeSat (RainCube)." <https://www.jpl.nasa.gov/CubeSat/missions/raincube.php>.
- Karaliunaite, Vaida. 2018. "Lacuna Space has Contracted NanoAvionics to Integrate and Launch its IoT Communications System On-board the M6P Nano-satellite Bus." <https://nanoavionics.com/press-release/nanoavionics-lacuna-space-launch-contract/>.
- Karlsson, Åsa. 2018. "Personal Correspondence."
2018. *Kestrel Eye*. <https://directory.eoportal.org/web/eoportal/satellite-missions/k/kestrel-eye>.
- Millenium Space Systems, Inc. 2015. "Altair." <http://www.millennium-space.com/platforms.html#altair>.
- Misuri, Tommaso, Vincenzo Stanzione, and Nicola Mele. 2017. "HT100 In-Orbit Validation: uHETSat Mission." *35th International Electric Propulsion Conference*. Georgia.
- NanoAvionics. 2018. "6U CubeSat Platform "M6P" CubeSat Platforms." <https://nanoavionics.com/CubeSat-components/platforms/CubeSat-6u-platform-m6p/>.
- Pumpkin, Inc. 2018. "Another Pumpkin MISC3 on Orbit." <http://www.pumpkinspace.com/blog/archives/11-2017>.
- Pumpkin, Inc. 2015. "CubeSat Kit." <http://www.CubeSatkit.com>.
- R J Twiggs, J G Jernigan, L R Cominsky, B K Malphrus, BS Silverman, K Zack, S McNeil, W Roach-Barrett, and T-LogoQube Team. 2014. "The PocketQube Concept." *CubeSat Workshop*. California State Polytechnic University. http://mstl.atl.calpoly.edu/~bklofas/Presentations/DevelopersWorkshop2014/Twiggs_PocketQube.pdf.
- Scardera, Mike. 2018. "Personal Correspondence."
- Segert, Tom. 2015. "Personal Correspondence."
- SITAEL. 2018. "S-50 Platform Datasheet." <http://www.sitael-hellas.com/wp-content/uploads/2015/10/S-50.pdf>.
- . 2018. "S-75 Platform Datasheet." <http://www.sitael-hellas.com/wp-content/uploads/2015/10/S-75.pdf>.



- SpaceTech Expo. 2018. "AAC – Clyde Wins Strategic Launch Contract." May. <http://www.spacetechempo.com/resources/news-and-editorial/news-container/2018/05/11/%C3%A5ac-%E2%80%93-clyde-wins-strategic-launch-contract/>.
- Surrey Satellite Technologies, Ltd. 2018. "SSTI-x50 Datasheet." <http://www.sst-us.com/downloads/datasheets/sstl-x50.pdf>.
- Surrey Satellite Technology Ltd. 2015. "Science Platforms." <http://www.sstl.co.uk/Products/EO---Science-Platforms>.
2018. "The PocketQube Standard." July.
- Tyvak NanoSatellite Systems Inc. 2015. "CubeSat Proximity Operations Demonstration (CPOD) Overview." http://www.nasa.gov/sites/default/files/files/A_Williams-A_Tsuda-CPOD_Overview.pdf.
- . 2012. "Endeavour: The Product Suite for Next Generation CubeSat Mission." http://mstl.atl.calpoly.edu/~bklofas/Presentations/SummerWorkshop2012/MacGillivray_Endavour.pdf.
- University of Toronto Institute for Aerospace Studies Space Flight Laboratory. 2018. "Products & Services: Satellite Platforms." https://www.utias-sfl.net/?page_id=89.
- University of Toronto Institute for Aerospace Studies Space Flight Laboratory. 2014. "Microsatellites: HawkEye 360 Pathfinder." https://www.utias-sfl.net/?page_id=2566.
- . 2014. "Microsatellites: NORSAT-1." https://www.utias-sfl.net/?page_id=1260.
- Wikipedia. 2018. "PocketQubue." July 24. Accessed August 28, 2018. <https://en.wikipedia.org/wiki/PocketQube>.



3.0 Power

3.1 Introduction

The electrical power system (EPS) encompasses electrical power generation, storage, and distribution. The EPS is a major, fundamental subsystem, and commonly comprises up to one-third of total spacecraft mass. Power generation technologies include photovoltaic cells, panels and arrays, and radioisotope or other thermonuclear power generators. Power storage typically occurs in batteries; either single-use primary batteries, or rechargeable secondary batteries. Power management and distribution (PMAD) systems facilitate power control to spacecraft loads. PMAD takes a variety of forms and is often custom-designed to meet specific mission requirements. EPS engineers often target a high specific power or power-to-mass ratio ($W\ h\ kg^{-1}$) when selecting power generation and storage technologies to minimize system mass impact.

The author would like to highlight that the presented tables are not intended to be exhaustive but to provide an overview of current state-of-the-art technologies and their development status for this small spacecraft subsystem. There was no intention of mentioning certain companies and omitting others based on their technologies.

3.2 State of the Art

3.2.1 Power Generation

Solar Cells

Solar power generation is the predominant method of power generation on small spacecraft. As of 2010, approximately 85% of all nanosatellite form factor spacecraft were equipped with solar panels and rechargeable batteries. Limitations to solar cell use include diminished efficacy in deep-space applications, no generation during eclipse periods, degradation over mission lifetime, high surface area, mass, and cost. Photovoltaic cells, or solar cells, are made from thin semiconductor wafers that produce electric current when exposed to light. The light available to a spacecraft solar array, also called solar intensity, varies as the inverse square of the distance from the Sun. The projected surface area of the panels exposed to the Sun also affects

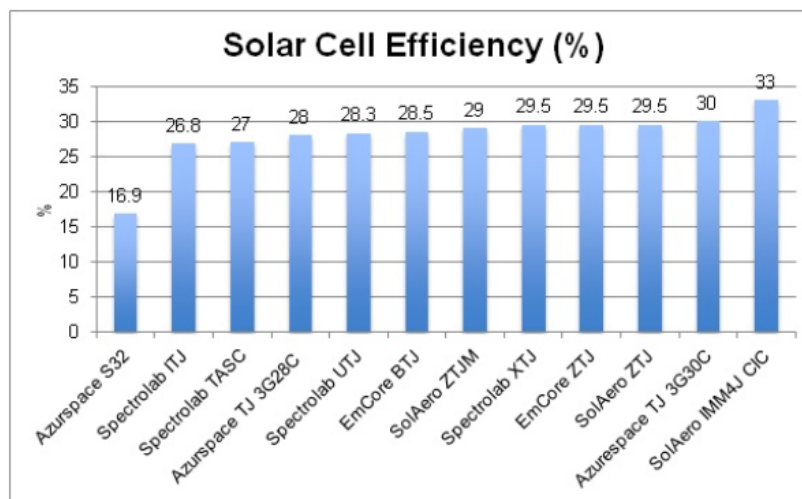

Figure 3.1: Solar Cell Efficiency.



generation, and varies as a cosine of the angle between said panel and the Sun. Most cells manufactured today for terrestrial applications are single junction cells, using a single material that is responsive to a particular portion of solar radiation spectrum, where the photon's energy is higher than the band gap of the cell material.

While single junction cells are cheap to manufacture, they carry a relatively low efficiency, usually less than 20%, and are not included in this report. Modern spacecraft designers favor multi-junction solar cells made from multiple layers of light-absorbing materials that efficiently convert specific wavelength regions of the solar spectrum into energy, thereby using a wider spectrum of solar radiation (Alia-Novobilski 2018).

The theoretical efficiency limit for an infinite-junction cell is 86.6% in concentrated sunlight (Green 2003). However, in the aerospace industry, triple-junction cells are commonly used due to their high efficiency-to-cost ratio compared to other cells. Figure 3.1 illustrates the available technologies plotted by energy efficiency. This section individually covers small-spacecraft targeted cells, fully-integrated panels, and arrays. Table 3-1 itemizes small-spacecraft solar panel efficiency per the available manufacturers.

Product	Manufacturer	Efficiency	Solar Cells Used	TRL Status
Solar Panel (0.5-12U); Deployable Solar Panel (1U, 3U)	Clyde Space	28.3%	SpectroLab UTJ	9
Solar Panel (0.5-12U); Deployable Solar Panel (1U, 3U)	Clyde Space	29.5%	SpectroLab XTJ	9
Solar Panel (0.5-12U); Deployable Solar Panel (1U, 3U)	Clyde Space	29.6%	AzurSpace 3G30A	9
Solar Panel (5 x 5 cm, 1U, 3U, custom)	DHV	29.6%	AzureSpace 3G30C Advanced	8
Solar Panel	Endurosat	29.5%	CESI Solar cells CTJ30	9
NanoPower (CubeSat and custom)	GomSpace	29.6%	AzurSpace 3G30A	9
HAWK	MMA	29.5-30.7%	SolAero XTJ & Prime	7



eHAWK	MMA	29.5-30.7%	SolAero XTJ & Prime	9
COBRA	SolAero	29.5%	SolAero ZTJ	Unkn.
COBRA-1U	SolAero	29.5%	SolAero ZTJ	Unkn.
Space Solar Panel	SpectroLab	26.8%	SolAero ITJ	9
Space Solar Panel	SpectroLab	28.3%	SolAero UTJ	9
Space Solar Panel	SpectroLab	29.5%	SolAero XTJ	9
Space Solar Panel	SpectroLab	30.7%	SolAero XTJ Prime	6

AZURSPACE

AzurSpace offers multi-junction solar cells with efficiencies ranging from 28 – 30%. Cells are built from layered GaInP/GaAs/Ge materials, and several dimensional options exist. These cells are used quite often with other solar arrays for space applications. Their 30% efficiency-class, triple-junction cells have a thickness of 80µm and measure 40 x 80 mm ± 0.1 mm with an average voltage of 2350 mV (AzurSpace 2018).

EMCORE CORPORATION

Emcore produces two triple-junction solar cells with 28.5% and 29.5% average efficiency that are available in standard and custom sizes. These second and third generation cells have rich flight heritage; ZTJ cells were flown on NASA's CYGNUS mission (EMCORE 2015). The 27.7% triple-junction solar cells with a 0.9 W maximum power point were selected for the 3U Phoenix CubeSat, part of the QB50 mission initiative launched in Spring 2017 (Yeh, et al. 2017).

SPECTROLAB

SpectroLab offers several solar cells in the 26-30% average efficiency range (XJT Prime, XTJ, and UTJ). The most efficient cells are 29.3% and are available in 26.62 cm², 59.65 cm² and customizable sizes. All SpectroLabs' triple-junction cells have been performance validated in orbit to within ±1.5% of ground test results (Spectrolab 2015). The XTJ Prime cell energy conversion efficiency is 30.7% and can be delivered in scalable sizes (27cm² through 84 cm²). The XTJ Prime is built on a heritage upright lattice matched XTJ structure (Spectrolab 2018). The 29.5% XJT solar cells have been GEO qualified; wafers are 140 µm thick. The Ultra Triple Junction cells are LEO and GEO qualified, range from of 27.7 - 28.3% efficient, and are performance validated in orbit to 1% of ground test results. The UTJ devices are rated at TRL 9 for small spacecraft applications (SpectroLab 2018).

SOLAERO TECHNOLOGIES

Solar cells manufactured by SolAero range from 28 – 30% average efficiency and have extensive flight heritage on both large and small spacecraft. Their latest Z4J cells produce more end-of-life power than the ZTJ cells for GEO missions and are currently being tested to meet AIAA S-111 2014 Standards, making these cells TRL 5. SolAero also manufactures 27% - 29.5% efficiency

solar cells (BJT, ATJ, and ATJM) that are fully space qualified for small spacecraft missions (SolAero Technologies 2015).

A collaboration between the Air Force Research Laboratory (AFRL) and SolAero has developed Metamorphic Multi-Junction (IMM) solar cells that have been shown to be less costly with increased power efficiency for military space applications (Alia-Novobilski 2018). The process for developing IMM cells involves growing them upside down, where reversing the growth substrate and the semiconductor materials allows the materials to bond to the mechanical handle, resulting in more effective use of the solar spectrum (Alia-Novobilski 2018). This also results in a lighter, more flexible product. While further testing and qualification are underway, initial tests show a single IMM cell can leverage up to 32% of captured sunlight into available energy. These IMM cells are expected to reach space by the end of 2018; they are currently TRL 6 (Alia-Novobilski 2018).

Solar Panels & Arrays

NANOAVIONICS

This manufacturer provides 1U/2U/3U and custom size GaAs (Triple junction GaInP/GaInAs/Ge epitaxial structure) solar arrays rated to 28.7 % efficiency. These solar arrays have 36.85 mW/cm² power-generation capacity in LEO and a PCB thickness of <1.7 mm (NanoAvionics 2018). Figure 3.2 shows their CubeSat GaAs solar panel.



Figure 3.2: CubeSat GaAs Solar Panel. Image courtesy of NanoAvionics.

INNOVATIVE SOLUTIONS IN SPACE (ISIS)

ISIS provides high-performance, CubeSat compatible solar panels that come in 1 – 6U sizes, for use on applications up to 24U. Panel mass ranges from 0.05 – 0.3 kg. These solar arrays are compatible with Pumpkin structures and the GomSpace NanoPower EPS. The 3U CubeSat MIST will fly with two ISIS 3U solar panels, expected to launch in 2018 (CHANDRASHEKAR 2017).

AAC-CLYDE

Clyde Space solar panels use 28.3% efficient, Spectrolab Ultra Triple Junction (UTJ) cells, mounted to a printed circuit boards (PCB) of Carbon fiber-reinforced plastic (CFRP) substrate, nominally fitting a 7S1P and 9S2P cell configuration per 3U and 6U panel face, respectively (Figure 3.3). Their spring-loaded hinges and hold-down/release mechanism have been proven on numerous missions (AAC-Clyde 2018).

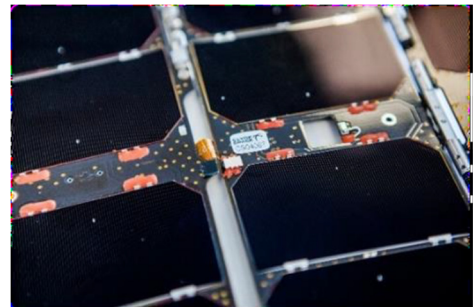

Figure 3.3: AAC-Clyde Solar arrays. Image courtesy of AAC-Clyde.



Figure 3.4: COBRA Solar Panels. Image courtesy of SolAero Technologies, (2015a).

SOLAERO

SolAero manufactures several triple-junction solar cells. Their COBRA and COBRA-1U are designed for small spacecraft applications and use the aforementioned SolAero advanced-triple-junction 29.5% efficiency cells. The COBRA's stowed power density for launch is upwards of 30 kWm⁻³ and claims to be the "lowest mass (>7 gW⁻¹) available in a self-contained, plug-and-play design suitable for all orbital environments" (SolAero Technologies

2015). The CubeSat-specific COBRA-1U can be used on CubeSats 1U-3U in size or larger, see Figure 3.4.

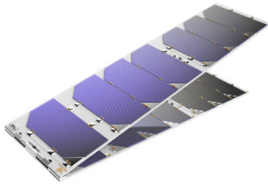

Figure 3.5: Endurosat 3U deployable Solar Array. Image courtesy of Endurosat.

ENDUROSAT

EnduroSat sells a variety of space-qualified solar panels with triple-junction (InGaP/GaAs/Ge) cells rated to 29.8% efficiency. Cell thickness is $150 \mu\text{m} \pm 20 \mu\text{m}$. They offer 1U/1.5U/3U/6U and customized 3U and 6U solar panels, as well as deployable arrays (Figure 3.5). The 1U and 3U overall panel masses are 0.04 kg and 0.155 kg, respectively. Maximum cell voltages are 2.33 V per cell. (Endurosat 2017). They also offer 5 configurations (X/Y, X/Y with Magnetorquer, Z, Z with Magnetorquer, X/Y with RBF) that have a mass range of 0.058 – 0.043 kg. The 1U configuration flew on EnduroSat-1 launched in May of 2018.

DHV

DHV Technology fabricates 100 x 100 mm 1U solar panels that weigh 39 g and produce 2.24 W (Figure 3.6). Assemblies with coverglass can reach up to 30% efficiency. DHV also produces 3U (132 g) and 3U-deployable panels producing 8.48 W. In addition to customizable panels, DHV manufactures a 50 x 50 mm “qubesat” panel which weighs 0.023 kg and produces 272 mW (DHV Technology 2018).

DHV Technology and Spire Global have announced a joint partnership to offer Spire’s double-deployable panels, built and sold through DHV Technology (DHV Technology 2018).

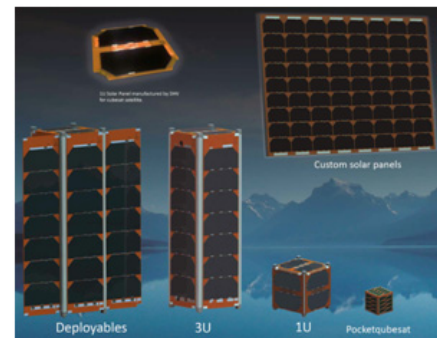

Figure 3.6: DHV’s range of small satellite solar panels. Image courtesy of DHV (2015).

GOMSPACE

GomSpace produces two NanoPower power systems for CubeSats, both use 30% efficient cells and include Sun sensors and gyroscopes. The customizable panels have a maximum output of 6.2 W and 7.1 W and include a magnetorquer. The CubeSat panel weighs 26-29 g without an integrated magnetorquer, or 56-65 g with one, and produces 2.3-2.4 W (GomSpace 2018).

SPECTROLAB

SpectroLab’s space solar panels have flown on multiple spacecraft in LEO and GEO. They are available in small sizes (30 cm²) and use SpectroLab’s Improved Triple Junction (ITJ), Ultra Triple Junction (UTJ) or NeXt Triple Junction (XTJ) cells (SpectroLab, 2010). Their solar panels were also used on the Juno spacecraft, which reached Jupiter in the Summer of 2016.

MMA DESIGN, LLC

MMA Design’s HaWK (High Watts per Kilogram) solar array is designed for 3U-12U platform spacecraft and is deployable and gimballed. The HaWK peak power is 36 W with a voltage of 14.2 V (MMA 2015). The eHaWK solar array is a modular, scalable system designed for 6U CubeSats and larger buses. The eHaWK starts at 72 W, uses Spectrolab UTJ 28.3% cells and weighs approximately 600 g (MMA 2015). The HaWK is scheduled to launch on NASA’s

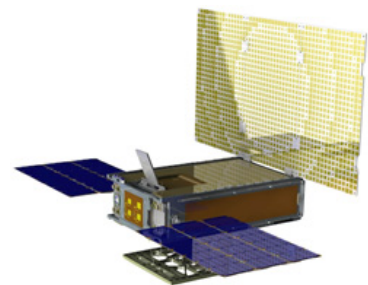

Figure 3.7: MMA’s eHaWK solar array on the Mars Cube One (MarCO) CubeSat. Image courtesy of MMA (2015b).

BioSentinel mission in 2020, and eHaWK (Figure 3.7) is already in deep space onboard the MarCO mission, launched May, 2018.

MMA also has zHaWK solar arrays that are based on HaWK series. The zHaWK consists of two array wings that are mounted on opposite 1U x 3U faces that consist of 6 panels (42 cells total), similarly to the HaWK configuration. The estimated mass of this array is 0.35 kg.

ASTRO- UND FEINWERKTECHNIK

Astro- und Feinwerktechnik have developed an adaptable solar array for minisatellites that is approximately 120 W with a mass of 4.19 kg. The startup-configuration dimensions are 546 x 548 x 620mm. These arrays have successfully flew on the 120 kg microsatellite TET-1 in 2012.

3.2.2 Power Storage

Solar energy is not always available during spacecraft operations; the orbit, mission duration, distance from the Sun, or peak loads may necessitate stored, on-board energy. Primary and secondary batteries are used for power storage and are classified according to their different electrochemistries. As primary-type batteries are not rechargeable, they are used only for short mission durations (around 1 day, up to 1 week). Silver-zinc are typically used as they are easier to handle and discharge at a higher rate, however there is also a variety of lithium-based primary batteries that have a higher energy density including: lithium sulphur dioxide (LiSO_2), lithium carbon monofluoride (LiCF_x) and lithium thionyl chloride (LiSOCl_2) (Nelson 1999).

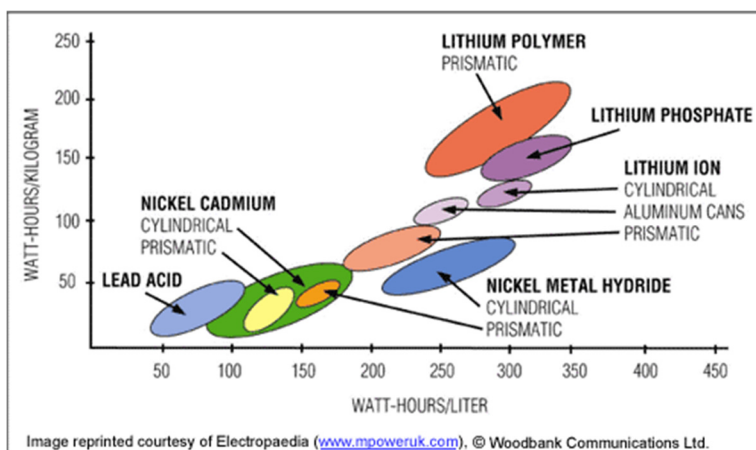

Figure 3.8: The energy densities of various battery types. Image courtesy of Wagner (2006).

Secondary-type batteries include nickel-cadmium (NiCd), nickel-hydrogen (NiH_2), lithium-ion (Li-ion) and lithium polymer (LiPo), which have been used extensively in the past on small spacecraft. Lithium-based secondary batteries are commonly used in portable electronic devices because of their rechargeability, low weight, and high energy, and have become ubiquitous on spacecraft missions. They are generally connected to a primary energy source (e.g. a solar array) and are able to provide rechargeable power on-demand. Each battery type is associated with certain applications that depend on performance parameters, including energy density, cycle life and reliability (Nelson 1999). A comparison of energy densities can be seen in Figure 3.8 (Wagner 2006) and Figure 3.9, and a list of battery energy densities per manufacturer is given in Table 3-2.

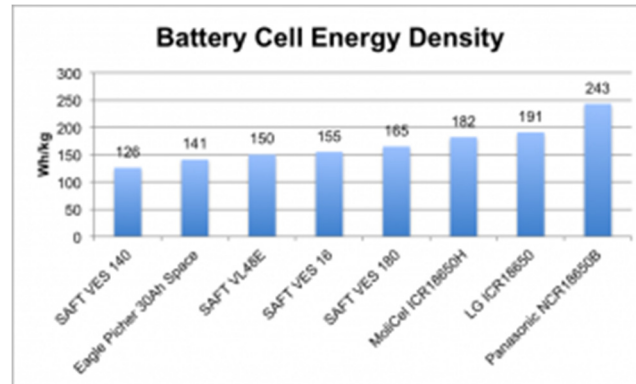

Figure 3.9: Battery Cell Energy Density.

This section will discuss the individual chemical cells as well as pre-assembled batteries of multiple connected cells offered from multiple manufacturers. Due to small spacecraft mass and volume requirements, the batteries and cells in this section will be arranged according to specific energy, or energy per unit mass. There are, however, a number of other factors worth considering, some of which will be discussed below (Jung and Manzo 2010).

Due to the extremely short mission durations with primary cells, the current state-of-the-art energy storage systems use lithium ion (Li-ion) or lithium polymer (LiPo) secondary cells, so this subsection will focus only on these electrochemical compositions with some exceptions.



Table 3-2: Battery Energy Density				
Product	Manufacturer	Specific Energy (Whkg ⁻¹)	Cells Used	TRL Status
40Whr CubeSat Battery	AAC-Clyde	119	Clyde Space Li-Polymer	9
BAT-100	Berlin Space Technologies	58.1	Lithium-Ferrite (Li-Fe)	9
BCT Battery	Blue Canyon Technologies	Unkn.	Li-ion or LiFePo4	9
BP-930s	Canon	132	Four 18650 Li-ion cells	9
COTS 18650 Li-ion Battery	ABSL	90 – 243	Sony, MoliCell, LG, Sanyo, Samsung	8
Li-ion Battery Block VLB-X	Vectronic	Unkn.	SAFT Li-ion	Unkn.
NanoPower BP4	GomSpace	143	GomSpace NanoPower Li-ion	9
NanoPower BPX	GomSpace	154	GomSpace NanoPower Li-ion	9
Rechargeable Space Battery (NPD-002271)	EaglePicher	153.5	EaglePicher Li-ion	7

Secondary Li-ion and Li-po batteries

Typically, Li-ion cells deliver an average voltage of 3.6 V while the highest specific energy obtained is well in excess of 150 Whkg⁻¹ (Jung and Manzo 2010).

AAC-CLYDE

AAC-Clyde has designed Li-polymer batteries specifically for small spacecraft and CubeSats, leveraging a vast investment in Li-polymer technology. The model featured in the table has a specific energy of 119 Whkg⁻¹ and voltage of 6.0-8.4 V (Figure 3.10). Battery temperature, voltage, current and telemetry can be monitored via an integrated digital interface. The use of Li-polymer cells allows the Clyde Space flat-packed batteries to be mass and volume efficient. Their third generation CubeSat battery line provides 10 – 80 Wh standalone batteries that



Figure 3.10: AAC-Clyde battery pack. Image courtesy of AAC-Clyde.

interface with their Electrical Power System (EPS) offerings built on a standard PC104 interface (AAC-Clyde 2017).

ABSL

ABSL's Li-ion 18650 cells have an energy density range of 90-243 Whkg⁻¹. ABSL's top of the line military and space grade cells (Figure 3.11) have proven long-term reliability and charge life, with safety & protection circuitry built into the battery cells (ABSL, 2007). ABSL provides small-spacecraft batteries featuring 4.8-12 Ah capacity, at 23-54W per cell, with a mass of 2-4 kg.



Figure 3.11: ABSL COTS Li-ion Battery. Image courtesy of ABSL (2007).

ABSL's industry-leading, Large-Format Li-Ion, 72 Ah Space cell has recently completed space qualification.

EAGLE PICHER

Eagle Picher produces a number of cells for military and aerospace applications including two advanced Li-ion cells and a rechargeable space battery. Both cells have a high energy density and a TRL of 9. Their integrated space battery has a specific energy of 153.5 Whkg⁻¹ and produces a nominal voltage of 28.8 V but has a slightly lower TRL of 7.

GOMSPACE

GomSpace offers a range of CubeSat subsystems, including Li-ion batteries. Their NanoPower BP4 Quad-Battery-Pack is designed to integrate seamlessly with their P-series PMADs. It is stackable and available in an International Space Station compliant version. NanoPower BP4 has a TRL of 9, having flown on board the GOMX-1 mission. The BPX series allows a wide range of parallel/series combinations and connections of up to sixteen cells (GomSpace 2015). The NanoPower P31u, developed for nanosatellite platforms, is optimal for 1 and 2U platforms. The P31u, rated at 20Wh capacity, can provide up to 30W at 8V (GomSpace 2018).

SAFT

SAFT is another battery manufacturer with a long history of supplying the aerospace industry. Their Li-ion range includes cells ranging from 126-165 Whkg⁻¹ (SAFT, 2013).

ULTRALIFE CORPORATION

There are two battery cells from Ultralife made for small spacecraft applications where primary batteries are an option. The Li-MnO₂ and Li-CFx provide an energy density ranging from 350 to 450 Whkg⁻¹. Lithium manganese dioxide cells offer excellent temperature characteristics, a flat discharge curve, and a hermetically sealed, nickel-plated steel container for long-term shelf life. Lithium Carbon Monofluoride cells have the highest energy density and performance characteristics of all lithium based battery chemistries with a strong passivation layer, which allows for long storage periods with minimal loss in cell capacity (Ultralife Corporation 2018).



Figure 3.12: Vectronic's VLB-4, -8, -16 Li-ion Battery Pack. Image courtesy of Vectronic Aerospace (2014).

VECTRONIC AEROSPACE

The VLB-16 Li-ion battery pack (Figure 3.12) offered from Vectronic Aerospace is specifically designed for use on small spacecraft and uses small spacecraft-qualified SAFT cells. This battery pack integrates current, voltage and temperature

measurement functions and includes dynamic balancing that can be determined through a digital control interface (Vectronic Aerospace 2014).

Ultralife's newest hybrid primary cell technology improves upon lithium manganese dioxide chemistry by providing almost a 50% increase in both capacity and shelf-life, whilst also reducing initial suppression of cell voltage that is typical of pure CFX chemistries due to passivation during storage. The Ultralife Hybrid cells come in a variety of sizes (19650, 26500, 26650 and 34610) and are TRL 9 (Ultralife Corporation 2018).

OTHER 18650 SOLUTIONS

LG's ICR18650 B3 Li-ion cells have a specific energy of 191 Whkg^{-1} and have flown on NASA's PhoneSat spacecraft, housed in a 2S2P battery holder from BatterySpace (LG Chem 2007). Panasonic produces the 18650B (3400 mAh) Li-ion cells, which have a high energy density of 243 Whkg^{-1} , and flight heritage on small spacecraft missions including NASA's GeneSat, SporeSat, O/OREOS, and PharmaSat (Panasonic 2015). A Molicel offers several different 18650 battery pack modules that are space proven. They manufacture the ICR18650H Li-ion cell with a high specific energy of 182 Whkg^{-1} which requires pack control circuitry (Molicel 2012). A Li-Ion 18650 Battery Holder (2S2P) flew on NASA's EDSN mission, in conjunction with LG ICR18650 B3 Li-ion cells. Canon's BP-930s battery pack (Figure 3.13) is an affordable, flight-proven option for power storage (Canon 2011). The pack contains four 18650 Li-cells and has flown successfully on NASA's TechEdSat missions.



Figure 3.13: Canon BP-930 Li-ion battery pack. Image courtesy of Canon (2011).

Two new 18650-sized products promise improved performance over heritage devices. The Panasonic NCR18650GA, at 3450mAh, provides a specific energy of 258 Whkg^{-1} . The LG MJ1, currently under evaluation at NASA Johnson Space Center (JSC), is rated to 3500mAh and 264 Whkg^{-1} .

3.2.3 Power Management and Distribution

PMAD systems control the flow of power to spacecraft subsystems and instruments and are often custom designed by mission engineers for specific spacecraft power requirements. However, several manufacturers have begun to provide a variety of PMAD devices for inclusion in small spacecraft missions. Several manufacturers supply EPS which typically have a main battery bus voltage of 8.2 V, but can distribute a regulated 5.0 V and 3.3 V to various subsystems. The EPS also protects the electronics and batteries from off-nominal current and voltage conditions. As the community settles on standard bus voltages, PMAD standardization may follow. Well-known producers of PMAD systems that focus on the small spacecraft market include Pumpkin, GomSpace, Stras Space and Clyde Space. However, a number of new producers have begun to enter the PMAD market with a variety of products, some of which are listed below. Table 3-3 lists PMAD system manufacturers; it should be noted that this list is not exhaustive.



Table 3-3: Power Management and Distribution Systems			
Product	Manufacturer	Technology Type	TRL Status
BCT CubeSat Electrical Power System	Blue Canyon Tech	EPS	*
CubeSat Kit EPS 1	Pumpkin, Inc.	EPS	9
CubeSat EPS Type I, II and I Plus	Endurosat	EPS	5-7
EPSL	NanoAvionics	EPS	9
LEO PCDU	Surrey	PMAD	9
Nanosatellite EPS	Clyde Space	EPS	8
NanoPower P31U	GomSpace	PMAD	*
P1U "Vasik"	Crystalspace	EPS	*
PCDU-2100, -2200, -2300	ÅAC Microtec	PMAD	*
Power Storage and Distribution	Tyvak	PMAD	*
Small Satellite PCDU	Clyde Space	PMAD	9
Vectronic PCDU	Vectronic	PMAD	*
3u cPCI Power Supply	SEAKR	EPS	9
Power and Control Unit	Magellan Aerospace	PMAD	9

*Contact vendor for more information

ÅAC - Clyde

ÅAC – Clyde provides three Power Conditioning and Distribution Units (PCDU) equipped with different user interfaces (Micro, Mini and Nano) for small spacecraft. They are designed for easy integration of payloads, sensors and sub-systems on advanced small satellites, with a mission lifetime of up to 5 years in LEO (AAC Microtech and Clyde Space 2018). The Nano interface has a mass of 0.22 kg, 12 V nominal bus and battery voltage, and an average system power of 20 W (Nano PCDU datasheet). There is a PMAD and an EPS targeted specifically at small satellites (The PMAD includes a range of topologies and architectures including DET and PPT, COTS, hybrid, and rad-hard components and has a TRL of 9. Their third-generation (3G FlexU) EPS for 1U-12U CubeSats has a TRL of 9 after having flown on the Picasso nanosatellite (launched in January

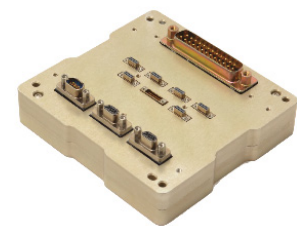

Figure 3.14: Clyde Space Small Satellite 3G FlexU EPS. Image courtesy of Clyde Space.

2018). The 3G FleXU (Figure 3.14) EPS is also planned to fly on the SERB nanosatellite mission (proposed launch in 2020).

Endurosat

Three CubeSat EPS modules are provided by Endurosat. CubeSat Power Module Type 1, 1 Plus, and Type 2 are most suitable for 1U, 1.5U and 2U CubeSat Satellites, and are integrated with one or two Li-Po battery packs. The CubeSat Power Module Type 1 has a 4.2 V battery pack voltage, a total mass of 0.198 kg (one battery pack), and 10.4Wh capacity (Endurosat 2018). This EPS has undergone space qualification testing. The CubeSat Power Module I Plus includes two battery packs with a total mass of 0.278 kg, 20.8 Wh battery-pack power, and 4.2 V pack voltage. Qualification tests are pending for this EPS. Finally, the Type II CubeSat EPS can be configured with either one or two battery packs; total mass is 0.28 – 0.42 kg, with 20.7 – 41.1 Wh of battery peak power and 12.6 – 16.8 V maximum pack voltage (Endurosat 2018).

Crystalspace

The Vasik P1U power supply is optimized for 1U and 2U CubeSats. The battery output traverses through redundant converters that can provide 3.3 V, 5 V and 12 V. The supply's energy rating is 3 Ah (11 Wh), with a mass of 0.08 kg (Crystal Space 2015). Unregulated 3.7V and regulated buses are also available. This architecture was successfully flight-tested on the ESTCube-1 satellite; this EPS is TRL 9.

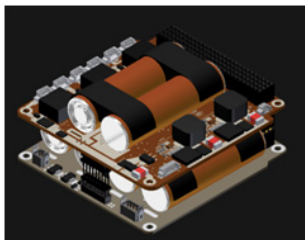

Figure 3.15: GomSpace NanoPower P31u. Image courtesy of GomSpace (2015).

GomSpace

GomSpace's NanoPower P31u PMAD system (Figure 3.15) is designed for small spacecraft requiring power up to 30 W (GomSpace 2015).

Surrey Satellite Technology

Surrey Satellite Technology sells a full PMAD system in the form of their LEO PCDU (Figure 3.16). It is based on a modular design that is intended to be scalable and customizable. The PCDU system is made up of a battery conditioning module and a power distribution module and has flown on over 30 missions (Surrey Satellite Technology Ltd 2015).



Figure 3.16: Surrey LEO PCDU. Image courtesy of Surrey Satellite Technology Ltd. (2015).

Vectronic

Vectronic's PCDU is one of a range of space power systems designed for small spacecraft. The PCDU monitors output from battery and solar power sources, and switches individual subsystems in response to a telecommand or automatically in the event of an overload or short-circuit condition. There are currently at least eight Vectronic PCDUs on orbit.

Pumpkin, Inc.

The Electrical Power System 1 (Figure 3.17) is an efficient, high power option for all nanosatellite platforms developed at Pumpkin. Shown in, this low-mass system has a total mass of <0.3 kg, features up to 3 W, and a 60 V power ring topology that has been space proven on multiple missions (Pumpkin, Inc. 2018). This board has flown on several small spacecraft and CubeSat form factors.

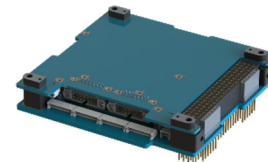

Figure 3.17: EPS1. Image courtesy of Pumpkin, Inc.

NanoAvionics

The Power Supply System EPSL is a low-power, 23 Wh configuration containing two 7.4V, 3200mAh cells. The EPSH high-power (46 Wh) configuration measures 92.9 x 89.3 x 25 mm, contains four 7.4 V cells (6400 mAh total), and weighs 0.3 kg (NanoAvionics 2017). This system is TRL 9.

3.3 On the Horizon

3.3.1 Power Generation

New technologies continue to be developed for space qualified power generation. Promising technologies applicable to small spacecraft include advanced multi-junction, flexible and organic solar cells, hydrogen fuel cells and a variety of thermo-nuclear and atomic battery power sources.

Multi-junction Solar Cells

Fraunhofer Institute for Solar Energy Systems have developed different four-junction solar cell architectures that currently reach up to 38% efficiency under laboratory conditions, although some designs have only been analyzed in terrestrial applications and have not yet been optimized (Lackner). Fraunhofer ISE and EV have achieved 33.3% efficiency of a 0.002 mm thin silicon based multi-junction solar cell, and future investigations are needed to solve current challenges of the complex inner structure of the subcells (Seeger 2018). Additionally, Boeing Spectrolabs has been experimenting with 5- and 6-junction cells with a theoretical efficiency as high as 70% (King 2015).

Flexible Solar Cells

Flexible and thin-film solar cells have an extremely thin layer of photovoltaic material placed on a substrate of glass or plastic. Traditional photovoltaic layers are around 350 microns thick, while thin-film solar cells use layers just one micron thick. This allows the cells to be flexible and lightweight and, because they use less raw material, are cheap to manufacture. In 2014, FirstSolar announced a flexible solar cell design (Figure 3.18) with an efficiency of 20.4%, closing the gap on single-junction solar cells (Casey 2014). Flexible solar cells designed specifically for space applications are available from United Solar and have an efficiency of 8% on 1 mil polymer giving them a specific power of 750-1100 Wkg⁻¹ (K. B. al. 2007).

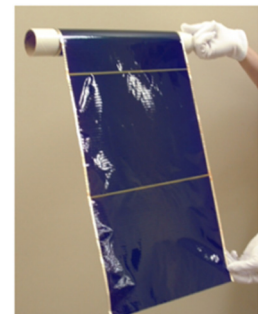

Figure 3.18: A series-connected string of production-sized cells on 1 mil polymer partially rolled onto a tube. Image courtesy of Casey (2014).

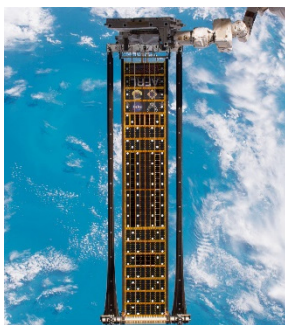

Figure 3.19: Roll-Out Solar Array. Image courtesy of NASA.

Additionally, MIT researchers have developed a solar cell material that can be printed onto paper and folded multiple times without loss of function. While still in its infancy, this technology has the ability to massively reduce the cost of solar cell production while increasing the durability of cells (Chandler 2011); (M. C. et al. 2011).

A June 2017 International Space Station (ISS) demonstration mission rolled up a solar array to form a compact cylinder for launch (NASA 2017). Roll-Out Solar Array (ROSA), is made of a center wing with flexible material containing photovoltaics (Figure 3.19).



Organic Solar Cells

Another on-the-horizon photovoltaic technology uses organic or “plastic” solar cells. These use organic electronics or organic polymers and molecules that absorb light and create a corresponding charge. A small quantity of these materials can absorb a large amount of light making them cheap, flexible and lightweight. Currently they are limited by an efficiency of less than 4% (Scharber and Sariciftci 2013).

In October 2016, the Optical Sensors based on CARbon materials (OSCAR) stratospheric-balloon flight test demonstrated organic-based solar cells for the first time in a stratospheric environment. While more analysis is needed for terrestrial or space applications, it was concluded that organic solar energy has the potential to disrupt “conventional” photovoltaic technology (Cardinaletti, et al. 2018). Since then, studies have shown that ex-situ climate chamber testing is a viable method for simulating aerospace environments (J. Mater. 2018. “Methodology of the First Combined In-flight and Ex-situ Stability.” Res. Vol. 33, No. 13, Jul 14.). While no standardized stability tests are yet available for organic-based solar cell technology and challenges remain on creating simultaneous environmental influences that would permit in-depth understanding of organic photovoltaic behavior, these achievements are enabling progress in organic-based solar cell use.

In 2018, Chinese researchers in organic photovoltaics were able to reach 17% power conversion energy using a tandem cell strategy. This method uses different layers of material that can absorb different wavelengths of sunlight, which enable the cells to use more of the sunlight spectrum, which has limited the performance of organic cells (Meng et al. 2018. “Organic and Solution-processed Tandem Solar Cells with 17.3% Efficiency.” Science. 361; 1094-1098).

Fuel Cells

Hydrogen fuel cells are appealing due to their small, light and reliable qualities and have a high energy conversion efficiency. They also allow missions to launch with a safe, storable, low pressure and non-toxic fuel source. An experimental fuel cell from the University of Illinois that is based on hydrogen peroxide rather than water has demonstrated an energy density of over 1000 Whkg⁻¹ with a theoretical limit of over 2580 Whkg⁻¹ (N. L. al. 2008). This makes them more appealing for interplanetary missions and during eclipse periods, however unlike chemical cells, they cannot be recharged on orbit. Regenerative fuel cells are currently being researched for spacecraft application. Today, fuel cells are primarily being proposed for small spacecraft propulsion systems rather than for power sub-systems (Ethier, et al. 2013).

Nuclear Power

Another source of spacecraft power comes from harnessing the energy released during radioactive decay. Radioisotope Thermoelectric Generators (RTGs) are associated with longer lifetimes, high reliability and predictable power production, and are more appealing than relying on batteries and solar panels beyond Mars orbit (>3 AU). A full-sized RTG, such as on New Horizons, has a mass of 56 kg and can supply 300 W (6.3% efficiency) at the beginning of its life (National Aeronautics and Space Administration 2015).

Although a radioisotope power system has not yet been integrated on a small spacecraft, they might be considered for small spacecraft missions that traverse interplanetary space. This concept would require substantial testing and modified fabrication techniques to facilitate use on smaller platforms.

TPV

A thermo-photovoltaic (TPV) battery consists of a heat source or thermal emitter and a photovoltaic cell which transforms photons into electrical energy. Thermophotovoltaic power converters are similar to high TRL thermoelectric converters, with the difference that the latter uses thermocouples and the former uses infrared-tuned photovoltaic cells.

In a paper given at the Photovoltaic Specialists Conference in 2011, entitled “Soda-can sized thermophotovoltaic battery replacement”, a TPV with a conversion efficiency of 10% was described that would have a specific energy of approximately 1000 Whkg^{-1} . This is approximately 6.5 times higher than the specific energy for a Li-ion battery, making it a very exciting alternative power source (Figure 3.20). The authors have not produced a physical prototype (Fraas, et al.

2011). Thermophotovoltaics are technically challenging as they require radioisotope fuel to have a temperature of more than 1273 K for high infrared emission, while also maintaining temperature suitable for photovoltaic cells (less than 323 K) for efficient electrical conversion.

Alpha- and Beta-voltaics

Alpha- and beta-voltaic power conversion systems use a secondary material to absorb the energetic particles and re-emit them via luminescence. These photons can then be absorbed by photovoltaic cells. Methods for retrieving electrical energy from radioactive sources include beta-voltaic, alpha-voltaic, thermophotovoltaic, piezoelectric and mechanical conversions. This technology is currently in the testing/research phase.

3.3.2 Power Storage

In the area of power storage there are several efforts at improving storage capability. For example, the Rochester Institute of Technology is prepared to demonstrate a nano-enabled power system on a CubeSat platform. The power system integrates carbon nanotubes into lithium-ion batteries that significantly increases available energy density. The energy density has exceeded 300 watt hours per kilogram during testing, a roughly two-fold increase from the current state-of-the-art (Raffaello 2018). A collaborative project between the University of Miami and NASA is aiming to develop a multifunctional structural battery system that will use an electrolytic carbon fiber material that acts as both a load bearing structure and a battery system. This project is still in the initial phases at the time of this report, but if successful, this novel battery system will extend mission life, support larger payloads, and significantly reduce mass (Karkkainen 2018).

3.3.3 Power Management and Distribution

For small spacecraft, traditional EPS architecture is centralized (each subsystem is connected to a single circuit board). This approach provides simplicity, volume efficiency, and inexpensive component cost. However, a centralized EPS is rarely reused for a new mission, as most of the subsystems need to be altered based on new mission requirements. A modular, scalable EPS for small spacecraft was detailed by Timothy Lim and colleagues, where the distributed power system separated into three modules: solar, battery and payload. This allows scalability and reusability

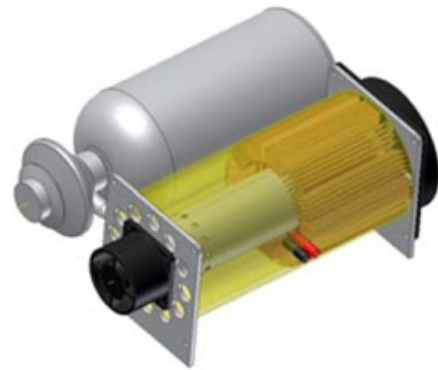

Figure 3.20: Small portable TPV battery with adjacent fuel cylinder. Image courtesy of Fraas et al. (2011).



from the distributed bus, which provides the required energy to the (interfaced) subsystem (Lim, et al. 2017).

University of Toronto's Space Flight Laboratory (SFL) has developed an in house, scalable and reusable Modular Power System (MPS) and have flown systems derived from this architecture on several missions: Norsat-1 & 2, and CanX-7 (Johnston-Lemke, et al. 2013).

3.4 Summary

Driven largely by weight and size limitations, small spacecraft are using advanced power generation and storage technology such as >29% efficient solar cells and lithium-ion batteries. The higher risk tolerance of the small spacecraft community has allowed both the early adoption of technologies like flat lithium-polymer cells as well as COTS products not specifically designed for spaceflight. This can dramatically reduce cost and increase mission-design flexibility. In this way, power subsystems are benefiting from the current trend of miniaturization in the commercial electronics market as well as from improvements in photovoltaic and battery technology.

Despite these developments, the small spacecraft community has been unable to use other, more complex technologies. This is largely because the small spacecraft market is not yet large enough to encourage the research and development of technologies like miniaturized nuclear energy sources. Small spacecraft power subsystems would also benefit from greater availability of flexible, standardized power management and distribution systems so that every mission need not be designed from scratch. In short, today's power systems engineers are eagerly adopting certain innovative Earth-based technology — like lithium polymer batteries — while, at the same time, patiently waiting for important heritage space technology — like fuel cells and RTGs — to be adapted and miniaturized.

References

AAC Microtech and Clyde Space. 2018. "Nanosatellite Platform Range."

AAC-Clyde. 2018. "Nanosatellite Platform Range."

—. 2017. "PS-NS01 NANO PCDU."

—. 2018. "Solutions for a New Age in Space Capability Overview."

—. 2017. "User Manual: 3rd Generation CubeSat." April 17.

ABSL. 2007. "ABSL's COTS Li-Ion Cell Suite Development."

al., K. Beernink et. 2007. "Lightweight, Flexible Solar Cells On Stainless Steel Foil And Polymer For Space And Stratospheric Applications." NASA/CP—2007-214494. *19th Space Photovoltaic Research and Technology Conference*.

al., M. C. Barr et. 2011. "Direct Monolithic Integration of Organic Photovoltaic Circuits on Unmodified Paper." Vol. 23.

al., N. Luo et. 2008. "Hydrogen-Peroxide-Based Fuel Cells for Space Power Systems." Vol. 24, no. 3.



- Alia-Novobilski, M. 2018. "Advanced Multi-junction Solar Cells Deliver High Efficiency, Reduced Costs for Space." Jan 4. Accessed July 15, 2018. <https://phys.org/news/2018-01-advanced-multi-junction-solar-cells-high.html#jCp>.
- AzurSpace. 2018. "30% Triple Junction GaAs Solar Cell Type: TJ Solar Cell 3G30C." Accessed July 15, 2018. http://www.azurspace.com/images/products/0004148-00-01_DB_GBK_80%C2%B5m.pdf.
- Canon. 2011. "BP-930 Material Safety Data Sheet."
- Cardinaletti, I., T Vangerven, S Nagels, R Cornelissen, D Schreurs, J Hruby, J Vodnik, et al. 2018. "Organic and perovskite solar cells for space applications." *Solar Energy Materials and Solar Cells* 182 (2018) 121.
- Casey, T. 2014. "First Solar Knocks It Out Of The Park With New Solar Cell Efficiency Record."
- Chandler, D. L. 2011. "While You're Up, Print Me a Solar Cell."
- Chandrashekar, S. 2017. "Thermal Analysis and Control of MIST CubeSat." Feb. Accessed July 2018. <http://www.diva-portal.org/smash/get/diva2:1071655/FULLTEXT02>.
- Crystal Space. 2015. "Crystalspace P1U Vasik Power Supply."
- EMCORE. 2015. "BTJ Space Solar Cells."
- Endurosat. 2017. *CubeSat 3U Solar Panel X/Y MTQ*. Accessed July 2018. <https://www.endurosat.com/products/CubeSat-3u-solar-panel-x-y-mtq/>.
- . 2018. *Electrical Power System Manual*. Accessed 2018. https://cdn4.endurosat.com/modules-datasheets/EPS_User_Manual_Rev1.2.pdf.
- Ethier, V, L Paritsky, T Moser, and J Slostad. 2013. "Development of a CubeSat Water-Electrolysis Propulsion System."
- Fraas, L M, j E Avery, L Minkin, and H X Hua. 2011. "Soda-can Sized Thermophotovoltaic Battery Replacement." 37th IEEE Photovoltaic Specialists Conference (PVSC).
- GomSpace. 2015. "NanoPower Modules."
- . 2018. "NanoPower P31u." Accessed July 16, 2018. <https://gomspace.com/Shop/subsystems/power-supplies/nanopower-p31u.aspx>.
- . 2018. "Solar Panels for Aerospace Applications."
- Green, M. A. 2003. "Third Generation Photovoltaics: Advanced Solar Energy Conversion." Vol. 12. Springer.
- Johnston-Lemke, B, N G Orr, G Bonin, and R E Zee. 2013. "Modular Power System: Enabling Scalable Missions for the 1W to 1kW Range." *27th Annual AIAA/USU Conference on Small Satellites*. <https://utias-sfl.net/wp-content/uploads/Small-Satellite-Conference-2013-SSC13-I-6.pdf>.



- Jung, D. S., and M. A. Manzo. 2010. "NASA Aerospace Flight Battery Program." NASA/TM-2010-216728; Vol. I.
- Karkkainen, Ryan L. 2018. "*Development of Lightweight CubeSat with Multi-Functional Structural Battery Systems.*" <https://ntrs.nasa.gov/archive/nasa/casi.ntrs.nasa.gov/20170011078.pdf>.
- King, R. 2015. "*Raising the Efficiency Ceiling in Multijunction Solar Cells.*" *Stanford Photonics Research Center Symposium, 2009.*
- LG Chem. 2007. "Product Specification: Rechargeable Lithium Ion Battery Model ICR18650 B3 2600mAh."
- Lim, T M, A M Cramer, S A Rawashdeh, and J E Lumpp. 2017. "A Modular Electrical Power System." *IEEE*.
- MMA. 2015. "E-Hawk (Pat.) Nanosat Solar Arrays."
- . 2015. "Hawk (Pat.) CubeSat Solar Arrays."
- Molicel. 2012. "Panasonic Lithium Ion NCR18650B."
- NanoAvionics. 2017. "CubeSat Electrical Power System "EPS" CubeSat Solar Panels & Power Systems." *Electrical Power System "EPS"*. Accessed July 15, 2018. <https://n-avionics.com/CubeSat-components/solar-panels-and-power-systems/CubeSat-electrical-power-system-eps/>.
- . 2018. *Solar-panels-and-power-systems: CubeSat-gaas-solar-panel*. Accessed July 15, 2018. <https://n-avionics.com/CubeSat-components/solar-panels-and-power-systems/CubeSat-gaas-solar-panel/>.
- NASA. 2017. *Changing How Solar Power Rolls*. https://www.nasa.gov/mission_pages/station/research/news/changing-how-solar-power-rolls.
- National Aeronautics and Space Administration. 2015. "Radioisotope Power Systems (RPS) Program."
- Nelson, R. A. 1999. "Spacecraft Battery Technology."
- Panasonic. 2015. "Panasonic Lithium Ion NCR18650B."
- Pumpkin, Inc. 2018. "CubeSat Kit Electrical Power System 1 (EPS1)."
- Raffaelle, Ryne. 2018. "*Demonstration of a Nano-Enabled Space.*" <https://ntrs.nasa.gov/archive/nasa/casi.ntrs.nasa.gov/20170011060.pdf>.
- Russell, Kendall. 2018. "DHV Technology to Bring Spire's Solar Panels to the Space Industry." *Via Satellite*. March 22. Accessed Aug 01, 2018. <https://www.satellitetoday.com/innovation/2018/03/22/dhv-technology-to-bring-spires-solar-panels-to-the-space-industry/>.



SAFT. 2013. "Market Solutions: Space."

Scharber, M C, and N S Sariciftci. 2013. "Efficiency of Bulk-heterojunction Organic Solar Cells." Vol. 38.

Seeger, Daniel. 2018. "*Fraunhofer ISE Announces 33% Efficiency for Multi-junction Solar Cell.*" <https://www.pv-magazine.com/2018/04/04/fraunhofer-ise-announces-33-efficiency-for-multi-junction-solar-cell/>.

SolAero Technologies. 2015. "Integrated Solar Products."

—. 2015. "Space Solar Cells / Coverglass Interconnected Cells (CIC)."

Spectrolab. 2018. "*30.7% Triple Junction Space Grade Solar Cell.*" Accessed July 15, 2018. https://www.spectrolab.com/DataSheets/cells/XTJ_Prime_Data_Sheet_7-28-2016.pdf.

—. 2015. "Spectrolab Space Products: Cells."

SpectroLab. 2018. "*Ultra Triple Junction (UTJ) Cells.*" Accessed July 16, 2018. <http://www.spectrolab.com/DataSheets/cells/2015%20UTJ%20CIC%20Datsheet.pdf>.

SpectroLab. 2010. "SpectroLab Space Solar Panels."

Surrey Satellite Technology Ltd. 2015. "LEO PCD."

Ultralife Corporation. 2018. "SPOON Submission, Li-MnO₂ and Li-CFx."

Vectronic Aerospace. 2014. "Li-Ion Battery Block VLB-4/ -8 /-16."

Wagner, R. 2006. "Battery Fuel Gauges: Accurately Measuring Charge Level."

Yeh, C Heng, J C Liu, C T Wu, K C Wu, and J C Juang. 2017. "*Estimation of Online Power Behavior of Phoenix's Electrical Power System.*" http://ir.lib.ncku.edu.tw/bitstream/987654321/173170/1/4010104000-000024_1.pdf.



4.0 Propulsion

4.1 Introduction

There is currently a wide range of technologies for propulsion systems, however the miniaturization of these systems for small spacecraft has been particularly challenging. The purpose of this chapter is to identify and analyze the current developmental status of propulsion technologies for small spacecraft and to present an overview of the available systems. Performance tests and technology demonstrations were considered in order to assess the maturity and robustness of each system. Some of the current systems are adaptable to a large variety of smaller buses. Since the last edition of this report in 2015, there have been several small satellite propulsion flight demonstrations. Due to the continuous redesign of smallsat propulsion systems post flight demonstration, their associated TRL will be reflected to match the NASA Standard guidelines (found on NASA Nodis website). A system is only TRL 9 when the actual system is flight proven through successful mission operations with documented mission operation results on a small spacecraft. A redesign or change in the component architecture or environment drops the TRL to 5 until a proven demonstration takes place in a high-fidelity environment (NASA NPR 7123.1B). Additionally, it should be noted that flight proven systems on a small spacecraft that is larger than a nanosatellite may still require testing for a smaller (nanosatellite) platform.

Cold gas or pulsed plasma systems for small delta-V maneuvers are fairly well established. However, higher delta-V applications require propulsion systems that are still in development. Small spacecraft buses other than CubeSats have more flexibility to accommodate systems with several thruster units to provide more attitude control and also large single axis maneuvers. Missions have demonstrated these technologies successfully, and the performance data gathered has paved the way for future modifications of the existing hardware in order to re-adapt the designs to satisfy demanding constraints.

Electric and chemical systems have experienced a significant maturation process with respect to the previous 2015 report. Thrust stand measurements in vacuum and lifetime tests have been performed for an extensive variety of devices and a serious effort has been made by several companies, agencies and institutions to satisfy small spacecraft requirements. Fundamental components, such as Power Processing Units (PPUs) and particular mass, power and volume constraints, have been adjusted to smaller buses. Electric propulsion devices that have been miniaturized to successfully adapt to small buses and low thrust options for CubeSats, such as electrospays or Pulsed Plasma Thrusters (PPT), enable easy integration due to their low degree of complexity. For more ambitious mission concepts that require higher delta-V, technologies such as Hall Effect and ion systems, are still being developed.

New alternative (green) propellants offer advantages in safety and handling over traditional hazardous propellants, such as hydrazine. Finally, in regards to propellant-less systems, the launch of LightSail has advanced the state-of-the-art of solar sails for small spacecraft.

This section considers systems that have flown, or have been actively in development over the last few years, to account for the most recent technological advances. The chapter is divided in three main categories in the "State of the Art" and "On the Horizon" sections: chemical, electric and propellant-less systems, which are divided into smaller subsections depending on the type of thrust generation. The "State of the Art" section is defined as technology assessed at TRL 5 and higher, while the "On the Horizon section" describes technology assessed at TRL 4 and below. Whenever pertinent, this report considers complete propulsion systems to be composed of



thrusters, feed systems, propellant storage and power processing units, but not the electrical power supply. In addition, for some subsections, single thruster heads are also introduced. Development on propulsive modules used for deorbit maneuvers, like solar sails, will be addressed. Table 4-1 shows a summary of the current state-of-the-art for different propulsion methods.

The author would like to highlight that the presented tables are not intended to be exhaustive but to provide an overview of current state-of-the-art technologies and their development status for this small spacecraft subsystem. There was no intention of mentioning certain companies and omitting others based on their technologies.

Product	Thrust	Specific Impulse (s)	TRL Status
Hydrazine	0.5 – 30.7 N	200-235	9
Cold Gas	10 mN – 10 N	65 – 70	GN2/Butane 9
Alternative (Green) Propulsion	0.1 – 27 N	220 – 250	HAN 6, ADN 9
Pulsed Plasma and Vacuum Arc Thrusters	1 – 1300 μ N	500 – 3000	Teflon 7, Titanium 7
Electrospray Propulsion	10 – 120 μ N	500 – 5000	7
Hall Effect Thrusters	10 – 50 mN	1000 – 2000	Xenon 7, Iodine 3
Ion Engines	1 – 10 mN	1000 – 3500	Xenon7, Iodine 4
Solar Sails	0.25 – 0.6 mN	N/A	6 (85 m ²), 7 (35 m ²)

4.2 State of the Art

4.2.1 Chemical Propulsion Systems

Chemical propulsion systems are designed to satisfy high thrust impulsive maneuvers. They are associated with lower specific impulse compared to their electric counterparts, but have significantly higher thrust to power ratios.

Hydrazine Propellant

There are a significant number of mature hydrazine propulsion systems used in large spacecraft that present a generally reliable option as mass and volume of these compact systems allow them to be a suitable fit for some small spacecraft buses. Thrusters that perform small corrective maneuvers and attitude control in large spacecraft may be large enough to perform high thrust maneuvers for small spacecraft and can act as the main propulsion system. Hydrazine propulsion systems typically incorporate a double stage flow control valve that regulates the propellant supply and a catalyst bed heater with thermal insulation. Typically, they have the advantage of being qualified for multiple cold starts which may be beneficial for power-limited buses if the lifespan of the mission is short. Hydrazine specific impulses are achievable in the 150-250 s range. Because



hydrazine systems are so widely used for large satellites, a robust ecosystem of components exist, and hydrazine propulsion systems are custom-designed for specific applications using available components.

Airbus Defense and Space has developed a 1-N class hydrazine thruster that has extensive flight heritage, including use on the small spacecraft, ALSAT-2. Aerojet Rocketdyne has leveraged existing designs with flight heritage from large spacecraft that may be applicable to small buses, such as the MR-103 thruster used on New Horizons for attitude control application (Stratton 2004). Other Aerojet Rocketdyne thrusters potentially applicable to small spacecraft include the MR-111 and the MR-106 (Aerojet Rocketdyne 2015).

The CubeSat High-Impulse Adaptable Modular Propulsion System (CHAMPS) project leverages the miniaturization effort performed for previous small hydrazine thrusters to develop CubeSat monopropellant propulsion systems. These modules satisfy a wide range of maneuvers from station-keeping and orbit transfers to momentum management. There are various configurations, such as the MPS-120, that support up to four 1-N hydrazine thrusters configured to provide pitch, yaw, and roll control as well as single-axis thrusting vectors. The MPS-120 was selected and funded by NASA to go through extensive testing. The 3D printed titanium isolation and tank systems were demonstrated in mid-2014 and one engine performed a hot fire test in late 2014 (Carpenter, et al. 2014). Currently, this system has some final development tasks remaining and depending on the level of qualification required, a first system could be delivered in the next year. The TRL is assessed at 5.

Additional versions of the MPS series are under development that use various thruster technologies such as cold gas (MPS-110), non-toxic AF-M315E propellant (MPS-130) or electric propulsion devices (MPS-160) (Aerojet Rocketdyne 2015). Aerojet Rocketdyne is also developing integrated modular propulsion systems for larger small spacecraft. The MPS-220 consists of two 22-N primary engines and eight 1-N auxiliary hydrazine thrusters (Aerojet Rocketdyne 2015).

Moog ISP has extensive experience in the design and testing of propulsion systems and components for large spacecraft. These may also apply for smaller platforms as some of their flight-proven thrusters are light-weight and have moderate power requirements. The MONARC-5 thrusters flew on NASA JPL's Soil Moisture Active Passive (SMAP) spacecraft in 2015 and provided 4.5 N of steady state thrust. Other thrusters potentially applicable to small spacecraft buses include the MONARC-1 and the MONARC-22 series (Moog ISP 2014). While all of these MONARC thrusters have extensive flight heritage on larger spacecraft, there is no evidence they have a flown on a small spacecraft, making the TRL for small spacecraft application 5.

Alternative (Green) Propellants

Alternative, 'green fuel' propellants have a reduced toxicity due to the lower danger of component chemicals and significantly reduced vapor pressure as compared to hydrazine. The 'green' affiliation results in the propellant being less flammable which in turn requires fewer safety requirements for handling, and potentially removes Self-Contained Atmospheric Protective Ensemble (SCAPE) suit requirements. This reduces operational oversight by safety and emergency personnel.

Range Safety AFSPCMAN91-710 requirements state that if a propellant is less prone to external leakage, which is seen with the alternative "green" systems due to higher viscosity of the propellant, the hazardous classification is reduced. External hydrazine leakage is considered "catastrophic," whereas using alternative "green" propellants reduces the hazard severity classification to "critical" and possibly "marginal" per MIL-STD-882E (Standard Practice for System Safety) (R. M. Spores 2013). A classification of "critical" or less only requires two-seals



to inhibit external leakage, meaning no additional latch valves other isolation devices are required in the feed system (R. M. Spores 2013). While these propellants are not safe for consumption, they have been shown to be less toxic compared to hydrazine. This is primarily due to alternative propellants being less flammable; nontoxic gasses (such as water vapor, hydrogen and carbon dioxide) are released when combusted.

Fueling spacecraft with green fuels, a parallel operation, may require a smaller exclusionary zone, allowing for accelerated launch readiness operations. These alternative propellants are generally less likely to exothermically decompose at room temperature due to higher ignition thresholds. Therefore they require fewer inhibit requirements, fewer valve seats for power, less stringent temperature requirements, and lower power requirements for system heaters.

Alternative propellants also provide higher performance than the current state-of-the-art fuel and have higher density-specific impulse achieving improved mass fractions. As a majority of these non-toxic propellants are in development, systems using these propellants present technical challenges including increased power consumption and a smaller selection of materials due to higher combustion temperatures. The primary ionic liquid propellants with flight heritage or upcoming spaceflight plans are Ammonium DiNitramide (ADN)-based LMP-103S and AF-M215E, and AF-M315E, a Hydroxyl Ammonium Nitrate (HAN)-based monopropellant. Table 4-2 lists the current state-of-the-art in green propellants. It should be noted that are two variations of the LMP-103S.

Product	AND or HAN based Propellant	Manufacturer	Thrust (N)	Specific Impulse (s)	TRL Status
GR-1	HAN	Aerojet Rocketdyne	0.26 – 1.42	231	6
GR-22	HAN	Aerojet Rocketdyne	5.7 – 26.9	248	5
1 N HPGP	ADN	Bradford Engineering	0.25 – 1.00	204 – 235	9
HYDROS-C	Other	Tethers Unlimited, Inc.	1.2	310	6
AMAC	Other	Busek	0.425	225	5
MiPS	ADN	VACCO	0.4	250	6
BGT-X5	HAN	Busek	0.5	220	5
EPSS C1K	ADN	NanoAvionics	0.3	252	7
Green Hybrid	Other	Utah State	8	215	6

The Ecological Advanced Propulsion Systems, Inc. (ECAPS) High Performance Green Propulsion (HPGP) system (Figure 4.1), uses ammonium dinitramide-based LMP-103S as propellant. Its density is slightly higher than hydrazine (1.24 gcm⁻³ vs 1.02 gcm⁻³). HPGP 1-N systems are being implemented in SkySat missions such as SkySat-3 (120 kg mass, launched June 2016), and SkySat block-I, and as of October, 2017, 13 SkySat small spacecraft were launched and are fully operational, making the system TRL 9. The HPGP systems are designed

for three different thrust magnitudes: 5-N and 22-N, with higher thrust systems in development (Persson 2015).

VACCO partnered with Bradford Engineering (formerly ECAPS) to design a self-contained unit that can deliver up to 3320 N-s of total impulse and can be adapted for different sizes, from 0.5U to 1U. The Micro Propulsion System (MiPS) is designed to meet the specific CubeSat standards and has four 100-mN ADN-propellant thrusters. This unit also has an ArgoMoon Prolusion thruster that incorporates one 100-mN ADN thruster and four 10-mN cold gas thrusters for attitude control, providing up to 783 N-s of total impulse for main delta-V applications and 72 N-s for Reaction Control Systems (RCS) (VACCO Industries 2015). There are several upcoming opportunities for this module to be flight-proven: a hybrid MiPS system is being developed for the ArgoMoon nanosatellite program that is planned to launch in 2020 with EM-1, as well as four MiPS thrusters that will be flown on Lunar Flashlight, a 3U spacecraft. The thrusters for this mission underwent qualification testing in June, 2018.



Figure 4.1: ECAPS HPGP thruster. Image courtesy of SSC ECAPS.

Another non-toxic propellant in development is the U.S. Air Force's AF-M315E (HAN-based). Aerojet Rocketdyne is currently developing propulsion systems using this propellant. The AF-M315E has a density of 1.47 gcm^{-3} (about 45% more than hydrazine) and a specific impulse of 230 – 250 s. While some components have heritage from previous hydrazine systems, others that are compatible with AF-M315E propellant, such as valves and filters, are at TRL 6 (Spores, et al. 2014). The propulsion system will be flown as a technology demonstration on the NASA Green Propellant Infusion Mission (GPIM), scheduled to launch 2018-2019. This small spacecraft is designed to test the performance of this propulsion technology in space by using five 1 N class thrusters (GR-1) for small attitude control maneuvers (McLean, et al. 2015). Aerojet completed a hot-fire test of the GR-1 version in 2014 and further tests in 2015. Initial plans to incorporate the GR-22 thruster (22-N class) on the GPIM mission were deferred in mid-2015 in order to allow for more development and testing of the GR-22. As a result, the GPIM mission will only carry 1 GR-1 unit when launched (Masse, et al. 2016). The TRL is currently 6 for the GR-1 (Figure 4.2), and 5 for the larger GR-22 (Figure 4.3).



Figure 4.2: GR1 thruster. Image courtesy of Masse et al. (2015).



Figure 4.3: GR22 thruster. Image courtesy of Masse et al. (2015).

The AF-M315E propellant is used by a 0.5 N thruster that is being developed by Busek. Three performance profiles were demonstrated: steady state, long and short duration pulses. For operating the thruster, there is a catalyst pre-heat requirement of 12 W for about eight minutes. In addition, the thruster is combined with a piezo-actuated micro-valve that is suitable for long-term propellant compatibility. While integrated system testing of the thruster and microvalve have occurred, further development is required before raising the TRL of the integrated system. The integrated testing demonstrated minimum impulse bits of 36 mNs. A full duty cycle test of the whole system will be included in future activities (Tsay, Frongillo and Lafko, et al. 2014), but the current status is unknown.



Figure 4.4: HYDROS engineering unit. Image courtesy of James et al. (2015).

Tethers Unlimited, Inc. is developing a water electrolysis propulsion system called HYDROS-C (Figure 4.4), which fits into a 1U volume and uses water as propellant. On-orbit, water is electrolyzed into oxygen and hydrogen and these propellants are combusted as in a traditional bi-propellant thruster. This thruster provides an average thrust of 1.2-N with 310 s Isp. This system has been selected for NASA's first Pathfinder Demonstration CubeSat Mission planned for launch early 2019 (D. Messier 2018). The current TRL for this unit is 6 as it has not yet flown.

NanoAvionics has developed a non-toxic mono-propellant propulsion system called Enabling Propulsion System for Small Satellites (EPSS) which was demonstrated on LituanicaSAT-2, a 3U CubeSat, to correct orientation and attitude, avoid collisions, and extend orbital lifetime (European Space Agency 2017). It uses ADN as propellant and gives 252 s of specific impulse that is designed to provide 0.3 N thrust and up to 200 m/s delta-V. LituanicaSAT-2 was launched June 2017 and successfully separated from the primary payload (Cartosat-2) as part of the European QB50 initiative. The current TRL is 7.

A novel arc-ignition "green" CubeSat hybrid thruster system prototype is currently under development at Utah State University. This system is fueled by 3-D printed acrylonitrile butadiene styrene (ABS) plastic for its unique electrical breakdown properties. Initially, high-pressure gaseous oxygen (GOX) was to be used as the oxidizer, however after safety considerations by NASA Wallops High Pressure Safety Management Team, it was concluded the oxidizer needed to contain 60% nitrogen and only 40% oxygen. On March 25th 2018, the system was successfully tested aboard a sounding rocket launched from NASA WFF into space and the motor was successfully re-fired 5 times. During the tests, 8-N of thrust and a specific impulse of 215 s were achieved as predicted (Whitmore 2018). For small spacecraft applications, the TRL is currently 6.

Cold Gas

Cold gas systems are relatively simple systems that provide limited spacecraft propulsion and are one of the most mature technologies for small spacecraft. Thrust is produced by the expulsion of an inert, non-toxic propellant which can be stored in high pressure gas or saturated liquid forms. Warm gas systems have been used in several missions for pressurization, and use the same basic principle, yielding more specific impulse performance than cold gas.

Cold gases are suitable for small buses due to their very low grade of complexity and are inexpensive and robust. They can be used when a small total impulse is required. Primary



advantages include a small impulse bit for attitude control applications and the association of small volume and low weight. Recently, new designs have improved the capability of these systems for nanosatellite buses such as 3U CubeSats. Table 4-3 shows the current state-of-the-art for cold and warm gas propulsion systems for small spacecraft.

Table 4-3: Cold Gas Propulsion Systems					
Product	Manufacturer	Thrust	Specific Impulse (s)	Propellant	TRL Status
MicroThruster	Marotta	0.05 – 2.36 N	65	Nitrogen	9
Butane Propulsion System	SSTL	0.5 N	80	Butane	9
Nanoprop 3U	GomSpace/NanoSpace	0.01 – 1 mN	*60 – 110	Butane	9
Nanoprop 6U	GomSpace/NanoSpace	4 – 40 mN	*60 – 110	Butane	9
MiPS Cold Gas	VACCO	53 mN	23	Butane	9
MarCO MiPS	VACCO	10 mN	40	R236FA	9
POPSAT-HIP1	Micro Space	0.083 – 1.1 mN	32 – 43	Argon	8
CNAPS	UTIAS/SFL	12.5 – 40 mN	40	Sulfur Hexafluoride	9
CPOD	VACCO	25 mN	40	R134A/R236FA	6

*Information was taken from brochure and may need to be updated by vendor

A cold gas thruster developed by Marotta flew on the NASA ST-5 mission (launch mass 55 kg) for fine attitude adjustment maneuvers. It incorporates electronic drivers that can operate the thruster at a power of less than 1 W. It has less than 5 ms of response time and it uses gaseous nitrogen as propellant (Schappell, et al. 2005).

Surrey Satellite Technology Ltd. (SSTL) has included a butane propulsion system in several small spacecraft missions for a wide range of applications in Low Earth Orbit (LEO) and Medium Earth Orbit (MEO). In this system, propellant tanks are combined with a resistojet thruster and operation is controlled by a series of solenoid valves (Figure 4.5). It uses electrical power to heat the thruster and improve the specific impulse performance with



Figure 4.5: SSTL butane propulsion system. Image courtesy of Gibbon (2010).

respect to the cold gas mode. It has been in design for more than five years and uses a RS-422 electrical interface (Gibbon 2010).

In June 2014, Space Flight Laboratory at University of Toronto Institute for Aerospace Research (UTIAS) launched two 15 kg small spacecraft to demonstrate formation flying. The Canadian Nanosatellite Advanced Propulsion System (CNAPS), shown in Figure 4.6, consisted of four thrusters fueled with liquid sulfur hexafluoride. This non-toxic propellant was selected since it has high vapor pressure and density which is important for making a self-pressurizing system (Pauliukonis 2017). This propulsion module is a novel version of the previous NanoPS that flew in the CanX-2 mission in 2008 (Bonin, et al. 2015).

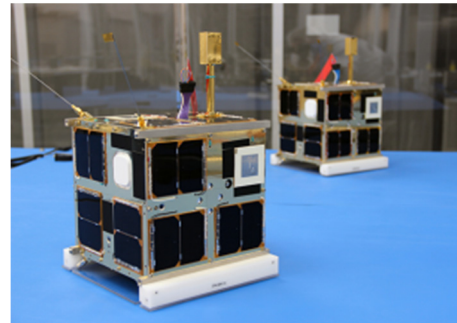

Figure 4.6: CNAPS spacecraft with UTIAS propulsion modules. Image courtesy of UTIAS SFL.

Another flight-demonstrated propulsion system was flown in the POPSAT-HIP1 CubeSat mission (launched June 2014), which was developed by Microspace Rapid Pte Ltd in Singapore. It consisted of a total of eight micro-nozzles that provided control for three rotation axes with a single-axis thrust for translational applications. The total delta-V has been estimated from laboratory data to be between 2.25 and 3.05 ms^{-1} . Each thruster has 1 mN of nominal thrust by using argon propellant. An electromagnetic microvalve with a very short opening time of 1 μs operates each thruster (Manzoni and Brama 2015).



Figure 4.7: NanoSpace MEMS cold gas system. Image courtesy of NanoSpace.

A complete cold gas propulsion system has been developed for CubeSats with a Microelectromechanical system (MEMS) (Figure 4.7) that provides accurate thrust control with four butane propellant thrusters. While thrust is controlled in a closed loop system with magnitude readings, each thruster can provide a thrust magnitude from zero to full capacity (1 mN) with 5 μN resolution. The dry mass of the system is 0.220 kg and average power consumption is 2 W during operation (Kvell, et al. 2014). This system is based on flight-proven technology flown on larger spacecraft (PRISMA mission, launched in 2010). The MEMS cold gas system was included on the bus of the TW-1 CubeSat, launched in September 2015 (NASA STMD 2013).

The CubeSat Proximity Operations Demonstration (CPOD) is a mission led by Tyvak Nano-Satellite Systems. It incorporates a cold gas propulsion system built by VACCO Industries that provides up to 186 N-s of total impulse. This module operates at a steady state power of 5 W and delivers 40 s of specific impulse while the nominal thrust is 25 mN (VACCO Industries 2015). It uses self-pressurizing refrigerant R134a propellant to fire a total of eight thrusters distributed in pairs at the four corners of the module. It has gone through extensive testing at the US Air Force Research Lab. Endurance tests consisted of more than 70,000 firings (Bowen, Villa and Williams 2015).

Solid Motors

Solid rocket technology is typically used for impulsive maneuvers such as orbit insertion or quick de-orbiting. Due to the solid propellant, they achieve moderate specific impulses and high thrust magnitudes that are compact and suitable for small buses. There are some electrically controlled solid thrusters that operate in the mN range. These are restartable, have steering capabilities and

are suitable for small spacecraft applications, unlike larger spacecraft systems that provided too much acceleration. Table 4-4 shows the current state-of-the-art in solid motors for small spacecraft. These thrust vector control systems can be coupled with existing solid rocket motors to provide controllable high delta-V in relatively short time. A flight campaign tested the ability of these systems to effectively control the attitude of small rocket vehicles. Some of these tests were performed by using state-of-the-art solid rocket motors such as the ISP 30 s developed by Industrial Solid Propulsion (Zondervan, et al. 2014).

Table 4-4: Solid Rocket Motors					
Product	Manufacturer	Total Mass (kg)	Average Thrust (N)	Specific Impulse (s)	TRL Status
ISP 30 sec motor	Industrial Solid Propulsion	0.95	37	187	6
STAR 4G	Northrop Grumman Innovation Systems	1.5	258	277	6
CAPS-3	DSSP	2.33	0.3	<300	8
MAP	PacSci EMC	Customized	N/A	210	9



Figure 4.8: Module of DSSP thrusters. Image courtesy of Nicholas et al. (2013).

SPINSAT, a 57 kg spacecraft, was deployed from ISS in 2014 and incorporated a set of first-generation solid motors, the CubeSat Agile Propulsion System (Figure 4.8) which was part of the attitude control system developed by Digital Solid State Propulsion LLC (DSSP). The system was based on a set of Electrically-controlled Solid Propellant (ESP) thrusters that consist of two coaxial electrodes separated by a thin layer of electric solid propellant. This material is highly energetic but non-pyrotechnic and is only ignited if an electric current is applied. The thrust duration can be better controlled, and allows for better burn control, and the lack of moving parts make the system suitable for small spacecraft.

The STAR motor was initially developed and tested for deploying constellations of small spacecraft in early 2000 under a NASA Goddard Space Flight Center program. The 4G motor was first tested in late 2000 (Northrop Grumman Innovation Systems 2018), but the current status of this motor is unknown.

4.2.2 Electric Propulsion Systems

Electric propulsion has experienced significant improvement in terms of systems available and component maturity. For many small spacecraft concepts, high specific impulses are necessary to comply with delta-V budgets. Depending on thruster technology, specific impulses for electric propulsion can range between 700-3000 s. However, thrust is low meaning long maneuver times.

Some thrusters are more suitable for small correction maneuvers and attitude control applications due to low impulse bits while others are designed to achieve high accelerations for interplanetary spiral trajectories. A wide spectrum of propellants is offered with electric propulsion. Iodine is proposed for some technologies due to its very high density that allows for higher delta-V maneuvers for necessary transfer trajectories. For smaller delta-V applications, solid-state materials such as polytetrafluoroethylene (PTFE)--or Teflon--are used in most Pulsed Plasma Thrusters (PPTs), while electrospays use various forms of ionic liquid.

Resistojets

Resistojets are the simplest form of electric propulsion. Thrust is produced by electrically heating the propellant so that the resulting gas can be expanded and expelled at high velocity out of the nozzle. Table 4-5 lists the current state-of-the-art for Resistojet designs that are applicable to small spacecraft.

Product	Manufacturer	Thrust	Power (W)	Specific Impulse (s)	TRL Status
Micro Resistojet	Busek	10 mN	15	150	5
CHIPS	CU Aerospace and VACCO	30 mN	30	82	5
PUC	CU Aerospace and VACCO	0.45 N	15	70	6
Resistojet Propulsion System	SSTL	100 mN	30 - 50	48 - 99	9

The Micro Resistojet offered by Busek is still in development for small spacecraft, but current specs list a max of 10 mN thrust at 150 s Isp at 15 W of power. The delta-V capability for a 4 kg spacecraft was projected at 60 m/s, and the total system mass is 1.25 kg when using ammonia as the propellant. The current status of this thruster is unknown.

Surrey Satellite Technology Ltd. (SSTL) has developed a resistojet propulsion system that has flown in several missions. It can work with different types of propellant such as xenon, butane or nitrogen. Thrust can be up to 100 mN and the specific impulse varies with the selected propellant ranging from 48 s for xenon to 99 s for nitrogen. The system uses power from 30 to 50 W and does not require a PPU since it works directly from the bus voltage input. There is heritage on small spacecraft, so is not scalable on a CubeSat without redesign.

CU Aerospace and VACCO have built a Propulsion Unit for CubeSats (PUC) (Figure 4.9). It consists of a fully integrated system that includes a controller, PPU, valves, sensors and a Micro-Cavity Discharge (MCD) thruster. High density and self-pressurizing liquids are used as

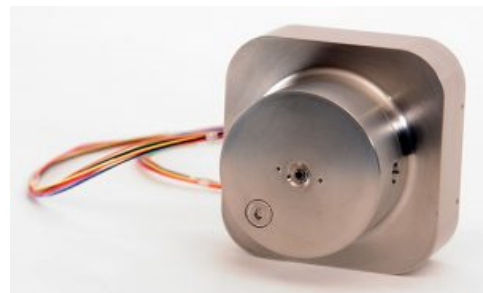

Figure 4.9: PUC module. Image courtesy of CU Aerospace and VACCO.



propellants by using the MCD heating technology together with an optimized low mass flow nozzle (Carroll, et al. 2015).

CU Aerospace and VACCO Industries have also developed a CubeSat High Impulse Propulsion System (CHIPS). This module incorporates a main micro-resistojet plus four equally distributed cold gas thrusters acting as a 3-axis attitude control system. By leveraging VACCO's compact friction-less valve technology and using an inert, non-toxic R-134a propellant, this system achieves a high total impulse to volume ratio. It occupies a 1U+ space in order to target 2U and 6U spacecraft buses. A fully integrated system with flow and power control has been demonstrated at the Electric Propulsion Laboratory at the University of Urbana-Champaign, Illinois. Tests included thrust and specific impulse measurements that estimated 82 s for the warm fire mode and 47 s for the cold fire mode. It can provide up to 563 N-s of total impulse, and a throttleable thrust of 30 mN in warm fire mode for primary propulsion. The cold gas mode is used for three axis attitude control and provides 323 N-s of total impulse and 19 mN of thrust. The TRL of the integrated system is 5, with a second phase currently in development (Hejmanowski, et al. 2015).

Busek Co, Inc. has leveraged previous flight and design efforts to miniaturize fundamental components such as valves and PPU's for a micro-resistojet. This system uses non-toxic ammonia propellant and delivers a total impulse of 404 N-s for main delta-V applications and 23 N-s for the ACS (Busek Co. Inc. 2015).

The University of Toronto Institute for Aerospace Studies has also developed a warm gas resistojet system that has been assessed at TRL 6. This propulsion system was supposed to fly on the LEO 2 spacecraft to achieve flight heritage on November 28, 2017, but failed due to a launch vehicle anomaly (UTIAS-SFL 2018). Additionally, UTIAS-SFL developed a nitrous oxide (N_2O) fueled monopropulsion system that provided 100 mN thrust at 131 s Isp during environmental tests performed in 2016 (Tarantini, et al. 2016). N_2O is a common oxidizer for hybrid systems that can be safely stored and readily decomposes into breathable air. Current status is unknown.

Electrosprays

Electrospray propulsion systems use the principle of electrostatic extraction and acceleration of ions from a propellant consisting of a negligible vapor pressure conductive salt. One of the biggest advantages of this technology with respect to other traditional electric propulsion systems is that no gas-phase ionization is required. The propellant does not need to be pressurized for storage since it flows via capillary action due to the ion evaporation process. The emission can be controlled by modulation of the voltage input in a closed loop feedback system with current measurements. In some cases, both species of negative and positive ions can be used, avoiding the need for a neutralizer which may be key to the design and operation of the system. Expelled ions achieve very high velocities, which translates into high specific impulses. Typically, the most widely used propellant in electrosprays is the ionic liquid 1-Ethyl-3-Methyl-Imidazolium Tetrafluoroborate (EMI-BF₄). NASA's Advanced In-Space Propulsion (AISP) project has created a portfolio that includes the development of Microfluidic Electrospray Propulsion (MEP). Table 4-6 displays the current state-of-the-art for small spacecraft applicable electrospray thrusters.

Table 4-6: Electro Spray Propulsion Systems					
Product	Manufacturer	Thrust	Power (W)	Specific Impulse (s)	TRL Status
S-iEPS	MIT	74 μ N	1.5	1160	6
TILE-5000	Accion Systems Inc.	1.5	8-25	1250	5
1 mN Electro spray	Busek	0.7 mN	15	800	7
100 μ	Busek	0.1 mN	5	2300	5

Electrospray technology has significantly advanced at Massachusetts Institute of Technology (MIT) Space Propulsion Laboratory (SPL), and some companies have started to commercialize systems based on this effort (Figure 4.10). Voltage versus current curves, and time of flight spectroscopy, among other tests, have helped to understand the ionic and electrical characteristics of the thruster. MIT has demonstrated a total of 315 hours of continuous electro spray operation, where a magnetically levitated thrust balance was used to measure thrust (Mier-Hicks and Lozano 2015). Each thruster has a total of 480 emitters, a passive propellant management system that includes a 1.2 cm³ tank, and an acceleration chamber. At the system level, MIT has developed the Scalable ion Electro spray Propulsion System (S-iEPS, Figure 4.11), that features a total of eight thrusters that fire along a single axis. This module is able to provide 74 μ N and more than 1160 s of specific impulse with a power draw of less than 1.5 W. It is lightweight, about 0.095 kg including PPU, and fits in a 0.2U volume (Krejci, et al. 2015). The S-iEPS thruster was going to be integrated on the Aerocube 8 CubeSat mission launched November, 2016, from Vandenberg on an Atlas V (Akpan 2018), however because there is no documentation indicating that this thruster operated successfully, the TRL was assessed at 6.

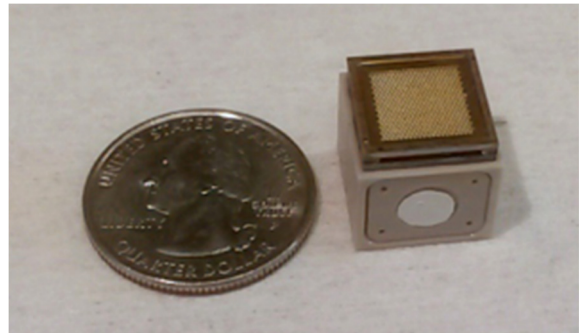

Figure 4.10: Electro spray thruster. Image courtesy of MIT SPL.

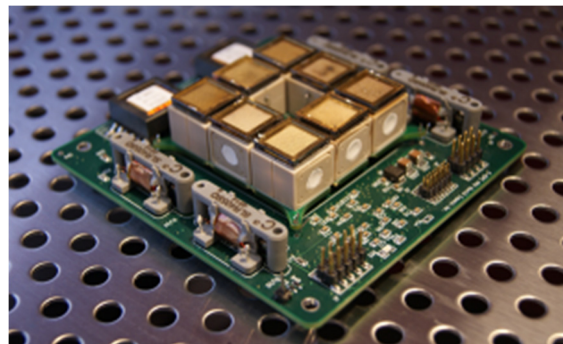

Figure 4.11: S-iEPS propulsion system. Image courtesy of MIT SPL.



Busek Inc. has developed fully integrated electro-spray propulsion systems in the mN range, the 100 micro-Newton BET 100 μ N and the one milli-Newton BET-1mN. These modules include a propellant-less cathode neutralizer and a low pressure customizable tank that were leveraged from the module incorporated into the NASA ST-7/ESA LISA Pathfinder spacecraft that launched in December, 2015, where all eight electric propulsion systems successfully fired (Busek 2016). The 1mN system uses 15 W of power and provides 675 N-s with 50 mL of propellant and has a mass of 1.15 kg, whereas the 100 μ N class thruster provides a specific impulse of 2300 s and consumes 5 W. The 100 μ N can deliver 85 ms^{-1} to a 4 kg CubeSat with a wet mass of 0.320 kg, using 10 mL of an ionic liquid propellant that has been fully characterized during the ST-7 flight program (Busek Co. Inc. 2015). The BET-100 systems was selected in March, 2016, to fly on a NASA Ames Pathfinder Technology Demonstration mission that is scheduled for launch in 2019 and underwent quality testing in late 2017. However this flight has been cancelled and there is no current information on this system.

The Micro Devices Laboratory (MDL) at the Jet Propulsion Laboratory (JPL) has developed a highly integrated and scalable indium MEP system (Figure 4.12) that has a dry mass of less than 0.010 kg and provides thrust in the 20-100 μ N range. Indium metal is stored in solid form and heated afterwards to be used as propellant. Over 10 hours of continuous operation tested an initial prototype assembly (JPL 2013), but the current TRL for this system is unknown.

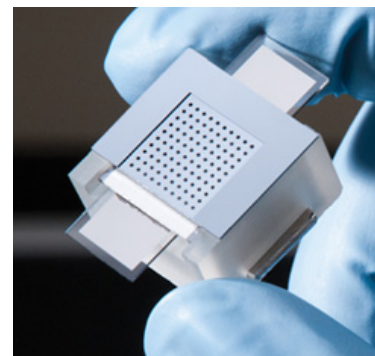

Figure 4.12: Indium MEP. Image courtesy of Jet Propulsion Laboratory.

Ion Engines

In ion thrusters, propellant is ionized using various plasma generation techniques. Radio Frequency (RF) engines achieve thrust by producing ions with electrode-less inductive discharges that are typically achieved using a helical coil at frequencies in the range of 1 MHz. The particles are then accelerated at very high exhaust velocities by electrostatic grids. These devices have a high efficiency when compared to other electric propulsion systems at lower thrust. In addition, the absence of electrodes avoids potential threats to thruster lifetime, which is only limited by grid erosion. Table 4-7 displays the current state-of-the-art in ion engines for small spacecraft.

Table 4-7: Ion Propulsion Systems and Thrusters						
Product	Manufacturer	Thrust	Power (W)	Specific Impulse (s)	Propellant	TRL Status
BIT-3	Busek	1.4 mN	60	3500	Iodine	5
1-COUPS	University of Tokyo	0.3 mN	N/A	1000	Xenon	7
RIT- μ X	Airbus	50 – 500 μ N	50	300 – 3000	Xenon	5
IFM Nano Thruster	Enpulsion	10 μ N – 0.4 mN	40	2000- 6000	Indium	7

Busek is developing a RF ion thruster that can operate with both xenon and iodine propellants, achieving similar performances (Tsay, Frongillo and Hohman, Iodine-Fueled Mini RF Ion Thruster for CubeSat Applications 2015). The BIT-3 engine has 3 cm diameter grids and is capable of providing variable specific impulse and thrust. At 60 W of operating power, it can achieve an efficiency of 35%. In 2015, it was shown that the test performance results on the iodine version have shown that thrust-to-power ratios are similar to the ones achieved with xenon as propellant. Complementary technologies associated with the thruster (such as propellant tanks and feed systems), have also been demonstrated for this propellant. The thrusters are compatible with iodine since the plasma-generation chambers in RF engines are generally built with ceramic materials that are resistant to corrosion. In July, 2017, the BIT-3 completed two critical design reviews for upcoming small spacecraft missions IceCube and LunaH-Map, which are scheduled to be launched with EM-1 in 2020 (Busek 2017).

Recently, the Japanese Proximate Object Close flyby with Optical Navigation (PROCYON) mission has shown successful operation of a propulsion system in space. The Ion thruster and Cold-gas thruster Unified Propulsion System (I-COUPS) was designed at the University of Tokyo and is an integrated system comprised of two sets of ion and cold gas thrusters. Both technologies share the same gas feed system that provides xenon propellant. This combines high thrust and large delta-V capabilities. Cold gas thrusters are used for reaction wheel de-saturation and small correction burns, while ion engines are kept for deep space maneuvers. In total, the mass of the propulsion system is less than 10 kg, including propellant. The ion engines in the I-COUPS unit are an evolution of the Miniature Ion Propulsion System (MIPS), which was previously launched on board the Hodoyoshi-3/4 mission in October, 2014. This spacecraft was placed on a Sun synchronous orbit and had a mass of 65 kg. The MIPS had a wet mass of 8.1 kg with 1 kg of propellant mass. Ion thruster operation was proven by providing continuous acceleration (Takegahara, et al. 2015).

Airbus offers a family of RF ion thrusters and their smallest is the RIT- μ X (Figure 4.13). This thruster is designed for small spacecraft buses and high precision maneuvers. Various thrust configurations were proposed and tested. It uses xenon as propellant and it has a dry mass of 0.440 kg. In 2013, a system in the 50-500 μ N range was demonstrated and thrust resolution, linearity, response and noise met LISA Pathfinder mission requirements, increasing the TRL to 5. The nominal power to open rate is less than 50 W and the specific impulse is between 300 and 3000 s, depending on the configuration. The maximum demonstrated specific impulse was 3500 s and high thrust levels of 50-2500 μ N were established in 2015 (Leiter, et al. 2015). Current status is unknown.

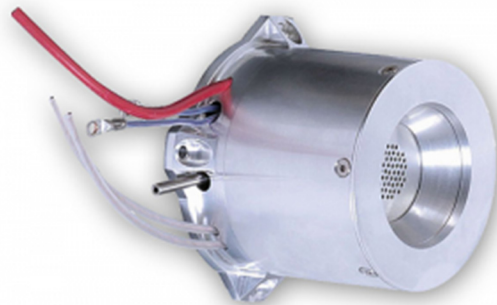

Figure 4.13: RIT- μ X. Image courtesy of Airbus.

The field-emission electric propulsion (FEEP) device is a type of ion thruster that uses liquid metal rather than gases like xenon as propellant. Currently Enpulsion is the only commercial manufacturer in the world offering an FEEP thruster. The instantaneous frequency measurement (IFM) Nano Thruster fits in a 1U volume and can produce 220 mN of thrust with a specific impulse of 4,000 seconds, and has already been flown on a 3U nanosatellite, deployed in January, 2018 (Foust 2018).



Pulsed Plasma and Vacuum Arc Thrusters

In Pulsed Plasma Thrusters (PPTs), thrust is produced by triggering a high voltage discharge between two electrodes that results in an electric arc that typically ablates a solid-state material like PTFE (Teflon). A self-generated magnetic field is produced which accelerates and expels particles from the thruster head, while the propellant is typically pushed forward by a spring as it is consumed. This technology has significant heritage from larger spacecraft, and due to its simplicity, miniaturization was easier than other electric propulsion systems. Major problems such as short circuits or non-uniform propellant ablation are under active research.

These systems are suitable for attitude control and fine pointing applications since the trigger pulse of the discharge can be adjusted, small impulse bits allow for high precision. Typically, the propulsion system consists of just a PPU that controls the discharge to operate the thrusters. The energy is stored in a capacitor bank which accounts for a significant portion of the system mass. Various materials have been tested for PPT use, however PTFE is the industry standard. Table 4-8 lists the current state-of-the-art for small spacecraft PPT thrusters.

Table 4-8: Pulsed Plasma and Vacuum Arc Propulsion Systems						
Product	Manufacturer	Thrust	Power (W)	Specific Impulse (s)	Propellant	TRL Status
PPTCUP	Mars Space and Clyde Space	40 μ N	2	655	PTFE	6
NanoSat PPT	Mars Space and Clyde Space	90 μ N	5	640	PTFE	5
μ -CAT	GWU and USNA	1 – 50 μ N	2 – 14	2500 – 3000	Titanium	7
BmP-220	Busek	20 μ N-s Impulse bit	1.5	536	PTFE	5
MPACS	Busek	80 μ N-s Impulse bit	10	827	PTFE	7
Metal Plasma Thruster	Applied Sciences Corp.	15 μ N/W	100	826 s (Pt) up to 2400 s (Al)	Any solid metal, Mo/Nb	5

Mars Space Ltd. and Clyde Space Ltd. have developed a compact propulsion module (Figure 4.14) specifically designed to provide maneuvering capabilities to CubeSats. At the University of Southampton, thermal cycling, vibration, Electro Magnetic Compatibility (EMC) and lifetime tests were performed. Vibration test results showed that the module sustains the mechanical vibrations during launch and the Electro-Magnetic (EM) noise levels during discharge were mostly compliant with guidelines. The system has a total mass of 0.270 kg and is characterized by an average specific impulse of 655 s and a total impulse of 48.2 Ns. It has a single thruster that uses PTFE propellant and is side-fed to maximize discharge length, with an electrode design that minimizes carbonization (Ciaralli, Coletti and Gabriel 2015).

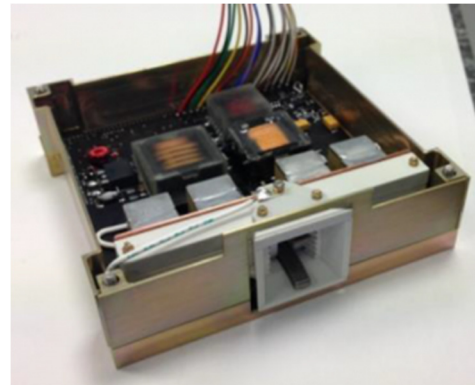

Figure 4.14: PPTCUP propulsion system. Image courtesy of Ciaralli et.al (2015).

Busek has extensive experience in developing PPT systems. Their Micro Pulsed Plasma Altitude Control System (MPCAS) flew on the FalconSat-3 mission in 2007. This module consisted of eight thrusters and provided attitude control with precise impulse bits of 80 μ N-s at a moderate power of less than 10 W (France, Anthony and Hart 2011) by using PTFE propellant. The system had heritage from previous investigations conducted at the Air Force Research Laboratory (AFRL) and has been evolving since this first approach, making it TRL 7. The BmP-220 is the latest version of the Busek PPT family (Figure 4.15). It has a volume of 0.7U and can provide up to 220 N-s of total impulse with 0.040 kg of propellant. An innovative solid-state switching technology enables the implementation of several emitters in a single unit. The specific impulse is 536 s and the minimum impulse bit is 0.02 mN-s (Busek Co. Inc. 2015). The system TRL is estimated to be 5.

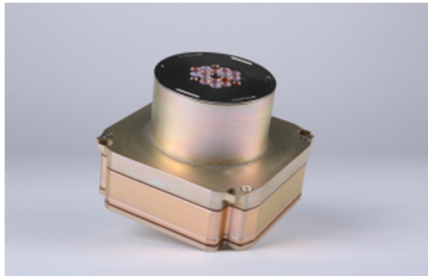

Figure 4.15: The BmP-220. Image courtesy of Busek.

Dr. Patrick Neumann is developing a Pulsed Cathodic Arc Thruster (PCAT), or Neumann Drive, that boasts a specific impulse as high as 14,000 seconds. It has broken the record for specific impulse previously held by NASA's HiPEP thruster. This thruster operates like an arc welder, where metal is heated as arcing current jumps between a cathode and an anode. As electrons jump, they carry some atoms with them in the form of plasma and these atoms are propelled into space, creating thrust. This ion drive will be installed on the Airbus Defense and Space Bartolomeo platform as part of the FAST (Facility for Australian Space Testing) mission in mid-2019 (Science Alert 2016).

Vacuum arc thrusters are another type of plasma-based propulsion device that produces thrust by propellant ionization. This technology consists of two metallic electrodes separated by a dielectric insulator. One of them is used as solid metallic propellant and is consumed as the thruster operates. Advantages of using a metallic solid propellant over the more traditional option of PTFE are a lower energy consumption per ionized mass, high pulse stability, and higher repetition rates due to the thermal properties of metals.

The Micro-Cathode Arc Thruster (μ CAT) developed by George Washington University (GWU), uses vacuum discharges to ablate the cathode material. It consists of a 5 mm thruster head that contains a concentrically-aligned and cylindrically-shaped anode, cathode and insulator. By



sending a pulse created by the PPU to the electrode interface, a high voltage arc is produced across it (Keidar, Zhuang and Shashurin, Electric propulsion for small satellites. 2015). The μ CAT offers a quasi-perfect ionization degree of the plasma particles in the exhaust plume, giving a near zero back flux. This propulsion technology generates thrust by consuming cathode material made of titanium with a high voltage vacuum arc, producing highly ionized plasma jets with high exhaust velocities. In addition, the incorporation of an external magnetic coil improves significantly the capabilities of the thruster (Keidar, Haque, et al. 2013).

An autonomous and modular micro electric propulsion system based on this technology has been designed and built at NASA Ames Research Center in partnership with GWU. This module fits into a 0.2U volume and consists of one Printed Circuit Board (PCB) that commands and operates up to four vacuum arc thrusters. Two PPUs, implemented in the main PCB, create the necessary discharges to operate the thruster. An average thrust in the μ N range is controlled by selecting different thrusting frequencies. This system was tested and measured in relevant vacuum conditions at NASA Glenn Research Center on a high-accuracy torsional thrust stand.

Furthermore, a partnership between GWU and the United States Naval Academy resulted in the integration of a μ CAT propulsion system into the Ballistically Reinforced Communication Satellite (BRICSAT). This mission was launched in May of 2015 and consisted of four PPUs operating four thrusters in total. Preliminary retrieved data has shown that the system successfully accomplished the objective of detumbling the spacecraft. After two days, the propulsion system was able to reduce the initial tumbling from 30°s^{-1} to nearly 1.5°s^{-1} , increasing the TRL of this system from 6 to 7 (Hurley, et al. 2015).

Hall Effect Thrusters

Hall Effect propulsion is a mature technology for large spacecraft systems (Figure 4.16). Miniaturization of some of the components, such as neutralizers, is complicated to achieve, and power consumption is relatively high compared to other electric propulsion technologies. However, improvements in integrating complete Hall Effect propulsion systems can potentially support large transfers for interplanetary missions. See Table 4-9 for current state-of-the-art technology in Hall Effect Thrusters for small spacecraft.

Product	Manufacturer	Thrust (mN)	Power (W)	Specific Impulse (s)	Status
BHT-200	Busek	13	200	1390	Xenon TRL 8, Iodine TRL 4
HT100	SITAEL	5 – 15	175	<1350	Xenon TRL 6
CHT	UTIAS SFL	6.2	200	1139	Xenon TRL 6

Busek has developed a complete Hall Effect thruster propulsion system for small spacecraft. The BHT-200 (Figure 4.16) is best suited for small spacecraft buses of relatively high mass and power supply since it needs 100-300 W to operate. This system has flight heritage from the 2006 TacSat-2 mission, and was part of the payload in the FalconSat-5 mission in 2010. Additionally, it was launched with the FalconSat-6 (150 kg) mission on a Falcon Heavy in 2018. This model can

operate with multiple propellants (Busek Co. Inc. 2015). The use of iodine will advance the technology due to its increased density over xenon and its lower operating pressure, which reduces cost and risk. More details can be found in the "On the Horizon" section.

The HT100, developed by Sitael Aerospace, has been extensively tested through campaigns that include characterization under thermal-vacuum conditions and structural analysis under heavy loads. Cathode erosion has been observed in an endurance test that lasted for 1650 hours where no thermal problems or important performance reduction was observed. The nominal operating power at 175 W gives a thrust range of 5-15 mN. The thruster mass is 0.440 kg, it uses xenon as propellant, and it can achieve a peak total efficiency of up to 35% and a maximum specific impulse of 1350 s. The HT100 has been selected for an in-orbit validation program by the European and Italian space agencies, where accelerated reentry and orbital maintenance will be tested. A larger version, the HT400, operates at a nominal power of 400 W and is at TRL 5 (Misuri, et al. 2015).

The Space Flight Laboratory (SFL) at the University of Toronto is developing a low power cylindrical Hall thruster (Figure 4.17) that operates below 200 W and has a 26 mm diameter ionization chamber. The cylindrical geometry of the ionization chamber was chosen in order to overcome the challenges of the annular chamber of traditional Hall thrusters. With this configuration, better efficiencies can be achieved while maintaining a sufficient thrust magnitude between 2.5-12 mN. Annular ionization chambers are mechanically simpler and produce high thrust to power ratios that are beneficial for small spacecraft applications. However, the efficiency still gets reduced when the chamber is redesigned to optimize low power operation.

Excluding the cathode, the weight of the first prototype was 1.6 kg. This device went under magnetic characterization and performance tests in vacuum. It uses xenon as a baseline propellant due to its improved performance over other gases such as argon. Further testing and design modifications were done in order to raise the TRL from 5 to 6 in 2016 (Pigeon and Zee. 2015). Current status is unknown.

Radio Frequency (RF) Thrusters

The Phase Four RF Thrusters (RFT) leverage ambipolar technology developed from the CubeSat Ambipolar Thruster (CAT), and have been tested at The Aerospace Corporation and Phase Four laboratories. Similar to its predecessor, the RFT has a ceramic plasma liner which is wrapped in an inductive RF antenna coil that is itself located inside a magnetic field generated by a permanent magnet. Inside the liner, xenon is ionized and the subsequent plasma is heated by induced oscillating magnetic fields. Electrons get accelerated at very high energies and this quick flux produces a charge imbalance in the system. Then, propellant ions are expelled out of the nozzle due to the momentary imbalance, becoming the main source of thrust.

There are several notable advantages of the RFT: the size reduction and power density improvements in the RF switching electronics have allowed the PPU to weigh less than 500 g for

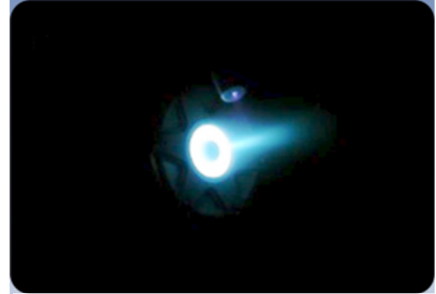

Figure 4.16: BHT-200 during operation. Image courtesy of Busek Co Inc.

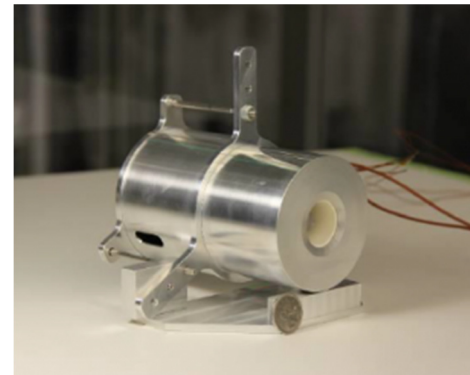

Figure 4.17: Cylindrical Hall Effect Thruster. Image courtesy of UTIAS SFL.



LEO CubeSat applications; second, the ambipolar nature of the technology obviates the need for a cathode neutralizer, which implies that no high voltage electronics are required; finally, since the thruster does not have electrodes, more propellants can be used, since they are no longer corrosive to cathodes or anodes in their plasma state.

There have been proof of concept Phase Four RF thrusters, RFT-0 RFT-2 and RFT-X, that showed comparable performance on a direct thrust stand to other RF thrusters that operate at much higher powers or have higher dimensions and mass (U. M. Siddiqui 2017). Despite the differences in the electrical, mechanical and magnetic characteristics, the specific impulse performance results scaled to the same linear trend, and are in the same order of magnitude as equivalent low power Hall Effect thrusters, within 50% of the thrust output at similar power levels, and with the advantage of being electrodeless (Siddiqui and Cretel 2018). Based on these technologies, the Maxwell RF Thruster propulsion system corresponds to a 400 W class engine, and it is operated at a power range of 342-480 W, achieving 4.3-9 mN at specific impulses of 1463-918 s (Phase Four Inc. 2018). The TRL on the Maxwell thruster is currently 5.

Propellant-less Systems

Systems that do not carry propellant for thrust generation are ideal candidates for small spacecraft. Such systems avoid complexity and reduce mass limitations, and can achieve high accelerations that can potentially propel an object for interplanetary travel.

Solar sails are the most popular method of propellant-less propulsion. They take advantage of solar radiation pressure by reflecting photons on a large sail made of a highly reflective material. Several missions have been conducted to demonstrate this technology for large buses such as the Japanese IKAROS, launched in 2010. Regarding small spacecraft, NASA has been conducting extensive research that resulted in the launch in 2010 of NanoSail-D2, a technology demonstration mission managed and designed by NASA Ames Research Center and NASA Marshall Space Flight Center. The sail had a deployed surface area of 10 m², was made of a thin highly reflective material called CP-1, and weighed 4.2 kg (Alhorn, et al. 2011).

One of the most recent solar sail missions for small spacecraft was performed by the Planetary Society in 2015. The 3U LightSail-1 spacecraft completed its technology demonstration test in Space by fully deploying a solar sail in LEO. The dimensions were 5.6 m on a side and 32 m² of total area once deployed. In 2018, a follow up mission called LightSail-2 that will be housed on 3U Prox-1, will demonstrate orbit raising maneuvers using the same 32 m² of mylar sail at a circular 720 km orbit as part of the Space Test Program (SPT-2). This spacecraft will fly on a Falcon heavy rocket to an approximately 720 km LEO orbit, where an orbital change in altitude or inclination will be performed (Ridenoure , et al. 2015).

4.3 On the Horizon

More small spacecraft missions will incorporate propulsion systems as propulsion technology matures, allowing for more complex mission architectures. This section will cover near-term spacecraft with propulsion, as well as promising technologies that will become important propulsion assets for future missions.

A smaller thruster version of just 1 cm grids, called the BIT-1, is also under development by Busek. This system has a mass of 0.053 kg, provides 100 μ N thrust and 2150 s Isp with 10W of power; thrust can exceed 180 μ N and 3200 s Isp when more power is available (Busek 2014). As of 2015 the TRL was assessed at 4, however current status is unknown.



There are several other propulsion technologies currently being developed: Ventions LLC is working on an integrated 3U CubeSat propulsion system using non-toxic propellant; hybrid non-toxic/cold gas propulsion system for 6U and 12U spacecraft by Planetary Resources Development Corporation; and a non-toxic solid rocket for CubeSats that allows for second ignition and uses an aluminized version of an Electric Solid Propellant (ESP) from Digital Solid State Propulsion (DSSP). Because ESPs are electrically ignited, they are safer than traditional solid energetic propellants (NASA 2018).

Orbital Technologies Corporation (ORBITEC) is developing the Miniature Nontoxic Oxide-Propane (MINNOP) propulsion system for small spacecraft which uses nitrous oxide as the oxidizer. It consists of a bipropellant system that provides a significant increase in specific impulse performance with respect to hydrazine systems when used in bi-propellant mode, with small levels of minimum impulse bit when used in cold gas mode. In 2014, a demonstration of the bipropellant thrust chamber and ignition system was performed within suitable weight constraints to fit into a 1U form factor (NASA 2018), although the current development status is unknown.

The Inductively Coupled Electromagnetic (ICE) thruster is a novel technology that is being developed by MSNW LLC. This system uses a small integrated RF oscillator to generate plasma. One of the main advantages of this system is that it can use virtually any liquid propellant. The total volume of the thruster and the PPU was expected to be less than 0.125U, and anticipated operating power was 10-50 W. In 2015, the goal was to achieve TRL 4, however the current status is unknown.

In 2015, an experimental characterization of a low power helicon thruster was performed at Stanford University's Plasma Physics Laboratory. Tests were conducted using water and argon propellants, and thrust was observed at various performance levels with magnitudes of 2-5 μ N. Future development efforts include optimization for greater performance and thrust stand measurements (Biggs, et al. 2015). Power has been a significant hurdle in advancing this technology, so current efforts have been focused on developing a dc-RF power supply with substantial improvements in weight to power density (Liang, et al. 2017).

Princeton Plasma Physics Laboratory, with The Aerospace Corporation, have tested the performance of a small cylindrical Hall thruster with permanent magnets. The measured thrust was in the 3-6.5 mN range with a specific impulse of 1000-1900 s. Efficiency studies at a discharge voltage of 300 V achieved a maximum thruster efficiency of over 20%. This version demonstrated superior performance than another version that uses electromagnets coils (Spektor, et al. 2011). There is still ongoing research for potential solutions for this design and this thruster has a TRL of 3.

D-Orbit is designing a modular micro-propulsion system called FENIX to raise or lower CubeSats into different orbits (Figure 4.18). This system consists of four small solid rocket motors that can be configured to any size CubeSat. The capabilities of this system can boost CubeSats into a higher orbit after deployment or be used for decommissioning maneuvers. The assessed TRL of this system is currently 4 (Yost 2018).



Figure 4.18: FENIX. Image courtesy of D-Orbit.

The B125 Propulsion System is a prototype being studied at Benchmark Space Systems. The bipropellant is hydrogen peroxide (H_2O_2) as the oxidizer and is fueled by 2-propanol (an alcohol blend). Studies published in 2018 identified a benefit when using a homogenous catalysis process



in that it provides the ability to operate in two modes: pseudo-monopropellant and bipropellant. The different modes are achieved by varying the flow rates of the catalyst solution and hydrogen peroxide, however developing an effective and reliable catalytic bed is still a technology challenge (Gagne, McDevitt and Hitt 2018). This system provides 1.25 N of thrust at 260 s specific impulse, and with a total mass of 1.5 kg it can provide an 8 kg nanosatellite 145 m/s of delta-V (Benchmark Systems 2017).

4.3.1 Future Small Spacecraft Missions with Propulsion

Due to significant improvements in propulsion technologies, mission concepts that were previously limited to large spacecraft are now possible with small buses. Interplanetary missions are becoming less costly, and therefore several institutions are assuming more risks to perform science missions with higher payoffs. As an example, NASA's Exploration Mission-1 (EM-1) will provide secondary payload opportunities for up to eleven 6U CubeSats, with a mission trajectory that will provide access to deep space or lunar orbit.

NASA Ames and Glenn Research Centers are working on the Pathfinder Technology Demonstration (PTD) project which consists of a series of 6U CubeSats that will be launched to test the performance of new subsystem technologies in orbit. For the first flight version, PDT-1, the HYDROS-C water-based propellant thruster, will be demonstrated to change the spacecraft's velocity and altitude (D. Messier 2018).

JPL is supporting the InSight mission, launched in March, 2018, which incorporated two identical CubeSats as part of the Mars Cube One (MarCO) technology demonstration. These spacecraft performed five Trajectory Correction Maneuvers (TCMs) during the mission to Mars. The CubeSats included an integrated propulsion system developed by VACCO Industries, which contained four thrusters for attitude control and another four for TCMs. The module uses cold gas refrigerant R-236FA as propellant, produces 755 N-s of total impulse, and weighs 3.49 kg (Klesh and Krajewski, MarCO: CubeSats to Mars in 2016. 2015).

A team at Purdue University and NASA Goddard Space Flight Center is developing the Film Evaporation MEMS Tunable Array (FEMTA). This Microelectromechanical systems (MEMS) thruster uses deionized liquid water as propellant with nozzles that produce thrust by applying local heat to a propellant capillary interface. Not having any mechanisms that require power is advantageous, allowing the system to operate with a low power consumption on the order of a mW. This technology will achieve TRL 6 by the end of fiscal year 2019 if technology maturation activities can achieve payload requirements for a Pathfinder Technology Demonstration 6U mission (Fowee, et al. 2017).

NEA Scout and Lunar Flashlight are two NASA MSFC missions that are going to be launched as part of EM-1, scheduled for 2020. For its main propulsion system, NEA Scout will deploy a sail of 80 m² of area with 0.0601 mms⁻² of characteristic acceleration, and will be steered by active mass translation via a VACCO cold gas MiPS (R236FA propellant). This module is approximately 2U in volume and will use six 23 mN thrusters to provide 30 m/s of delta-V (VACCO 2016). The propulsion system on Lunar Flashlight is a VACCO green mono propellant MiPS (AND propellant), that will be used for station keeping and attitude control. The VACCO Lunar Flashlight MiPS is approximately 3U in volume and uses four Bradford/ECAPS 100 mN thrusters which provide 3,320 N-sec of total impulse and 237 m/s delta-V (VACCO 2016).

4.4 Summary

A variety of propulsion technologies are currently available for small spacecraft. While cold gas and pulsed plasma thrusters present an ideal option for attitude control applications, they have



limitations for more ambitious maneuvers such as large orbital transfers. Other alternatives such as hydrazine, non-toxic propellants, and solid motors provide a high capability and are suitable for medium size buses and missions that require higher delta-V budgets. Some spacecraft have already flown with these systems or are scheduled to fly in the next year. For the near future, the focus is placed on non-toxic propellants that avoid safety and operational complications, and provide sufficient density and specific impulse despite high cost per kg. The application of this technology in CubeSats is still in development, as some of the components need to be scaled down to comply with volume, power, and mass constraints.

Electrosprays, Hall Effect thrusters and ion engines are in development, and active testing and technology demonstrations are expected for different bus sizes. These propulsion technologies will allow spacecraft to achieve very high delta-V and, therefore, to perform interplanetary transfers with low thrust.

Several other technologies, as well as new versions of existing systems with improved capabilities, are being proposed and a wide range of mature options in the following years are forecasted. As the industry progresses and more launches are scheduled, more propulsion systems will be included on board small spacecraft, increasing the average TRL for this important subsystem.

References

- UTIAS-SFL. 2014. "Microsatellites: LEO 2." January 25.
- Accion Systems Inc. 2015. "MAX-1 Scalable Electric Propulsion System for Small Satellites."
- Aerojet Rocketdyne. 2015. "Aerojet Rocketdyne Official Website."
- Akpan, N. 2018. "These Tiny Satellites, Equipped with Ion Thrusters, Could Change How We Explore Space." January 1. <https://www.pbs.org/newshour/science/these-tiny-satellites-equipped-with-ion-thrusters-could-change-how-we-explore-space>.
- Alhorn, D. C., J. P. Casas, E. F. Agasid, et al. 2011. "Nanosail-D: The Small Satellite That Could!" *25th Annual AIAA/USU Conference on Small Satellites*.
- Benchmark Systems. 2017. "B125 Propulsion System." Accessed July 25, 2018. https://static1.squarespace.com/static/5977e71e7131a5e3ee8e08fb/t/5aa927e8652dea049843bfe3/1521035241106/BSS_Datasheet_B125.pdf.
- Biggs, D., S. Avery, L. Raymond, and et al. 2015. "A Compact Helicon Thruster for CubeSat Applications." *34th International Electric Propulsion Conference and 6th Nano-satellite Symposium*.
- Bonin, G., N. Roth, S. Armitage, J. Newman, R. risi, and Zee. 2015. "CanX-4 and CanX-5 Precision Formation Flight: Mission Accomplished!" *29th Annual AIAA/USU Conference on Small Satellites*.
- Bowen, J., M. Villa, and A. Williams. 2015. "CubeSat-based Rendezvous, Proximity Operations, and Docking in the CPOD Mission." *29th Annual AIAA/USU Conference on Small Satellites*.



- Busek. 2014. "1cm RF Ion Thruster: BIT-1: World's Smallest Ion Thruster." Accessed July 2018. http://www.busek.com/index_htm_files/70011950%20RevA%20Data%20Sheet%20for%20BIT-1%20Ion%20Thruster.pdf.
- . 2017. "All Electric Propulsion Technologies." May. <https://iCubeSat.files.wordpress.com/2017/06/2017-b-3-3-20170530183026-all-electric.pdf>.
- . 2016. "Busek Electro Spray Thrusters Launch Aboard ESA's LISA Pathfinder on December 03, 2015." http://www.busek.com/index_htm_files/70000704%20LISA%20Pathfinder%20Release%20Rev-.pdf.
- Busek Co. Inc. 2015. "BmP-220 Micro-Pulsed Plasma Thruster."
- Busek. 2017. "First Iodine Fueled Ion Engine Pass Major Milestone." May 31. http://www.busek.com/index_htm_files/IonThrusterMilestone31JUL2017.pdf.
- Carpenter, C., D. Schmuland, J. Overly, and R. Masse. 2014. "Test Results for the MPS-120 and MPS-130 CubeSat Propulsion Systems." *28th Annual AIAA/USU Conference on Small Satellites*. Logan.
- Carroll, D., J. M. Cardin, R. L. Burton, et al. 2015. "Propulsion Unit for CubeSats (PUC)." *62nd JANNAF Propulsion Meeting*.
- Ciaralli, S., M. Coletti, and S. B. Gabriel. 2015. "Qualification of a Pulsed Plasma Thruster for CubeSat Propulsion (PPTCUP)." *Presented at the: 34th International Electric Propulsion Conference and 6th Nano-satellite Symposium*.
- Collard, T., and J. Sheehan. 2016. "Preliminary Measurements of an Integrated Prototype of the CubeSat."
- Dinardi, A., S. Beckel, and J. Dyer. 2013. "Implementation and Continued Development of High Performance Green Propulsion in the United States." *AIAA 2013-5441*.
- Dyer, J., A. Dinardi, and K. Anflo. 2013. "First Implementation of High Performance Green Propulsion in a Constellation of Small Satellites." *27th Annual Small Satellite Conference*. Logan.
- European Space Agency. 2017. "LituaniaSAT-2." <https://directory.eoportal.org/web/eoportal/satellite-missions/content/-/article/lituanicasat-2#foot4%29>.
- Foust, J. 2018. "More Startups are Pursuing CubeSats with Electric Thrusters." July 23. Accessed July 27, 2018.
- Fowee, K., S. Pugia, R. Clay, M. Fuehne, M. Linker, T. Cofer, and A. Alexeenko. 2017. "Quad-Thruster FEMTA Micropropulsion System for CubeSat 1-Axis Control." Accessed July 23, 2018. http://mstl.atl.calpoly.edu/~bklofas/Presentations/SummerWorkshop2017/SSC17-WK-48_presentation.pdf.



- France, M. E. B., J. F. Anthony, and S. Hart. 2011. "USFAA Astronautics Capstone Program— Proving Ground for Future Operationally Responsive Space Leaders." *AIAA Reinventing Space Conference, AIAA-RS-2011-1002*.
- Gagne, K. R., M. R. McDevitt, and D. L. Hitt. 2018. "A Dual Mode Propulsion System for Small Satellite Applications."
- Gibbon, D. 2010. "A Review of the Use of Butane as a Low Cost Propellant." *Space Propulsion Conference*.
- Gunter's Space Page. 2017. "iSAT." November. http://space.skyrocket.de/doc_sdat/isat_CubeSat.htm.
- Hejmanowski, N. J., C. A. Woodruff, R. L. Burton, D. L. Carroll, and J. M. Cardin. 2015. "CubeSat High Impulse Propulsion System (CHIPS)." *62nd JANNAF Propulsion Meeting*.
- Hurley, S., G. Teel, J. Lukas, et al. 2015. "Thruster Subsystem for the United States Naval Academy's (USNA) Ballistically Reinforced Communication Satellite (BRICSat-P)." *34th International Electric Propulsion Conference and 6th Nano-satellite Symposium*.
- JPL. 2013. "Microfluidic Electro spray Propulsion May Allow Microspacecraft to Fly to Mars or the Asteroid Belt."
- Keidar, M., S. Haque, T. Zhuang, et al. 2013. "Micro-Cathode Arc Thruster for PhoneSat Propulsion." *27th Annual AIAA/USU Conference on Small Satellites*.
- Keidar, M., T. Zhuang, and A. Shashurin. 2015. "Electric Propulsion for Small Satellites."
- Klesh, A., and J. Krajewski. 2015. "MarCO: CubeSats to Mars in 2016." *29th Annual AIAA/USU Conference on Small Satellites*.
- Krejci, D., F. Mier-Hicks, C. Fucetola, P. Lozano, A. H. Schouten, and F. Martel. 2015. "Design and Characterization of a Scalable Ion Electro spray Propulsion System." *34th International Electric Propulsion Conference and 6th Nano-satellite Symposium*.
- Kvell, U., M. Puusepp, F. Kaminski, et al. 2014. "Nanosatellite Orbit Control Using MEMS Cold Gas Thrusters." *Proceedings of the Estonian Academy of Sciences, 63, 2S, 279–285*.
- Leiter, H. J., C. Altmann, R. Kukies, et al. 2015. "Evolution of the AIRBUS DS GmbH Radio Frequency Ion Thruster Family." *34th International Electric Propulsion Conference and 6th Nano-satellite Symposium*.
- Liang, W., L. Raymond, M. Praglin, D. Biggs, F. Righetti, M. Cappelli, B. Holman, and J. R. Davila. 2017. "Low-Mass RF Power Inverter for CubeSat Applications Using 3-D Printed Inductors." *Journal of Emerging and Selected Topics in Power Electronics*. Vol. 5, No. 2, 880.
- Manzoni, G., and Y. L. Brama. 2015. "CubeSat Micropropulsion Characterization in LEO." *29th Annual AIAA/USU Conference on Small Satellites*.



- Masse, R. K., R. A. Spores, M. Allen, and E. Driscoll. 2016. "AF-M315E Propulsion System Advances & Improvements." Accessed 2018. <https://ntrs.nasa.gov/archive/nasa/casi.ntrs.nasa.gov/20170001286.pdf>.
- McLean, C. H., W. D. Deininger, B. M. Marotta, et al. 2015. "Green Propellant Infusion Mission Program Overview, Status, and Flight Operations." *51st AIAA/ASME/SAE/ASEE Joint Propulsion Conference*.
- Messier, D. 2018. *NASA Selects Tethers Unlimited's HYDROS-C Thruster for First PTD CubeSat Mission*. June 30. Accessed July 10, 2018. <http://www.parabolicarc.com/2018/06/30/nasa-selects-tuis-hydrosc-thruster-ptd-CubeSat-mission/>.
- Mier-Hicks, F., and P. C. Lozano. 2015. "Thrust Measurements of Ion Electro spray Thrusters Using a CubeSat Compatible Magnetically Levitated Thrust Balance." *34th International Electric Propulsion Conference and 6th Nano-satellite Symposium*.
- Misuri, T., C. Ducci, R. Albertoni, M. Andrenucci, and D. Pedrini. 2015. "SITAEL Low Power Hall Effect Thrusters for Small Satellites." *34th International Electric Propulsion Conference and 6th Nano-satellite Symposium*.
- Moog ISP. 2014. "Moog Monopropellant Thrusters Brochure."
- Morring, F. 2014. "Storable Propellant: Busek Test-fires Tiny RF Gridded-ion Thruster for CubeSat Apps, Using 'Solid' Iodine as Fuel." Accessed 2018. http://www.busek.com/index_htm_files/Busek%20Test-Fires%20Tiny%20Gridded%20RF-Ion.pdf.
- NASA. 2018. "SBIR: Miniature Nontoxic Nitrous Oxide-Propane (MINNOP) Propulsion, Phase I." <https://data.nasa.gov/dataset/Miniature-Nontoxic-Nitrous-Oxide-Propane-MINNOP-Pr/4sxx-s8gu>.
- NASA STMD. 2013. "Micro-Electro spray Thrusters by NASA's Space Technology Mission Directorate."
- Nicholas, A., T. Finne, I. Galysh, A. Mai, and J. Yen. 2013. "CubeSat Solid Rocket Motor Propulsion Systems Providing Delta-Vs Greater than 500 m/s." *27th Annual AIAA/USU Conference on Small Satellites*.
- Nothrup Grumman Innovation Systems. 2018. "Propulsion Products Catalog." *Propulsion Systems*. June. Accessed Nov 2018. http://www.northropgrumman.com/Capabilities/PropulsionSystems/Documents/NGIS_MotorCatalog.pdf.
- Pauliukonis, R. S. 2017. "Fuel System Comprising Sulfur Hexafluoride and Lithium Containing Fuel." <https://patents.google.com/patent/US3325318>.
- Persson, M. 2015. "Commercial Breakthrough for ECAPS HPGP Replacing Hydrazine." *Rymdforum*.



- Phase Four Inc. 2018. "*Maxwell Radio Frequency Thruster.*" Accessed October 31, 2018. www.phasefour.io .
- Pigeon, C., and R. Zee. 2015. "A Low Power Cylindrical Hall Thruster for Next Generation Microsatellites." *29th Annual AIAA/USU Conference on Small Satellites.*
- Ridenoure, R., R. Munakata, A. Diaz, et al. 2015. "LightSail Program Status: One Down, One to Go." *29th Annual AIAA/USU Conference on Small Satellites.*
- Schappell, D. T., E. Scarduffa, P. Smith, and N. Solway. 2005. "Advances in Marotta Electric and Satellite Propulsion Fluid Control Activities." *41st AIAA/ASME/SAE/ASEE Joint Propulsion Conference.*
- Sheehan, J., T. Collard, F. Ebersohn, and B. Longmier. 2015. "Initial Operation of the CubeSat Ambipolar Thruster."
- Siddiqui, U. M., and C. Cretel. 2018. "Updated Performance Measurements of the Phase Four RF Thruster." *American Institute of Aeronautics (AIAA) Propulsion and Energy Forum.*
- Spaceflight Insider. 2015. "*Aerojet Rocketdyne to Develop 'Greener' Next Generation Propellants.* February 28. Accessed July 22, 2018. <http://www.spaceflightinsider.com/missions/commercial/aerojet-rocketdyne-develop-greener-next-generation-propellants/>.
- Spektor, R., K. D. Diamant, E. J. Beiting, et al. 2011. "Characterization of a Cylindrical Hall Thruster with Permanent Magnets." *32nd International Electric Propulsion Conference and 6th Nano-satellite Symposium.*
- Spoes, R., R. Masse, S. Kimbrel, and C. McLean. 2014. "GPIM AF-M315E Propulsion System." *50th Joint Propulsion Conference.*
- Spoes, R., R. Masse, S. Kimbrel, and C. McLean. 2013. "GPIM AF-M315E Propulsion System." *49th AIAA/ASME/SAE/ASEE Joint Propulsion Conference & Exhibit.* San Jose.
- Stratton, J. 2004. "The Use of the Aerojet MR-103H Thruster on the New Horizons Mission to Pluto." *55th International Astronautical Congress.*
- Takegahara, H., H. Kuninaka, I. Funaki, et al. 2015. "Overview of Electric Propulsion Research Activities in Japan." *34th International Electric Propulsion Conference and 6th Nano-satellite Symposium.*
- Tarantini, V., B. Risi, R. Spina, N. Orr, and R. Zee. 2016. "*Development of a Nitrous Oxide Monopropellant Thruster.*" Accessed July 2018. http://mstl.atl.calpoly.edu/~bklofas/Presentations/SummerWorkshop2016/1_StephenMauthe.pdf.
- Tsay, M., J. Frongillo, and K. Hohman. 2015. "Iodine-Fueled Mini RF Ion Thruster for CubeSat Applications." *34th International Electric Propulsion Conference and 6th Nano-satellite Symposium.*



- Tsay, M., J. Frongillo, D. Lafko, and J. Zwahlen. 2014. "Development Status and 1U CubeSat Application of Busek's 0.5N Green Monopropellant Thruster." *28th Annual AIAA/USU Conference on Small Satellite*.
- U. M. Siddiqui, C. Cretel, J. Synowiec, A. Hsu, J. Young, and R. Spektor. 2017. "First Performance Measurements of the Phase Four RF Thruster." *35th International Electric Propulsion Conference*. Atlanta. 413.
- UTIAS-SFL. 2018. "Microsatellites: LEO 2." January 25.
- VACCO Industries. 2015. "CubeSat Propulsion Systems from VACCO."
- VACCO. 2016. "*Lunar Flashlight Propulsion System*." Accessed July 10, 2018. <http://www.CubeSat-propulsion.com/lunar-flashlight-propulsion-system/>.
- . 2016. "*NEA Scout Propulsion System*." Accessed July 10, 2018. <http://www.CubeSat-propulsion.com/nea-scout-propulsion-system/>.
- Whitmore, S A. 2018. "USTAR University Technology Acceleration Grant (UTAG) Award." Bi-annual Report, April 19, 2018.
- Yost, Bruce. 2018. "In Orbit Now: D-Orbit Products." January 28.
- Zondervan, K L, J Fuller, D Rowen, and et al. 2014. "CubeSat Solid Rocket Motor Propulsion Systems Providing Delta-Vs Greater than 500 m/s." *28th Annual AIAA/USU Conference on Small Satellites*.



5. Guidance, Navigation & Control

5.1 Introduction

The Guidance, Navigation & Control (GNC) subsystem includes both the components used for position determination and the components used by the Attitude Determination and Control System (ADCS).

In Earth orbit, onboard position determination can be provided by a GPS receiver. Alternatively, ground based radar tracking systems can also be used. If onboard knowledge is required, then these radar observations can be uploaded and paired with a suitable propagator. Commonly, the USAF publishes two line element (TLE) sets (Shepherd and Shepherd 2006), which are paired with a SGP4 propagator (Vallado, et al. 2006). In deep space, position determination is performed using the Deep Space Network (DSN) and an onboard radio transponder (Thornton and Border 2003).

ADCS includes sensors used to determine attitude and attitude rate, such as star trackers, sun sensors, horizon sensors, magnetometers, and gyros. Actuators are designed to change a spacecraft's attitude. Common spacecraft actuators include magnetorquers, reaction wheels, and thrusters. There are many attitude determination and control architectures and algorithms suitable for use in small spacecraft (Wertz 2012).

The continuing trend in small spacecraft GNC is the miniaturization of existing technologies. While 3-axis stabilized, GPS-equipped, 100 kg class spacecraft have been flown for decades, it has only been in the past few years that such technologies have become available for micro- and nano-class spacecraft. Table 5-1 summarizes the current state-of-the-art of performance for GNC subsystems in small spacecraft. Performance greatly depends on the size of the spacecraft and values will range for nano- to micro-class spacecraft.

The author would like to highlight that the presented tables are not intended to be exhaustive but to provide an overview of current state-of-the-art technologies and their development status for this small spacecraft subsystem. There is no intention of mentioning certain companies and omitting others based on their technologies.

Component	Performance	TRL Status
Reaction Wheels	0.001 - 0.3 Nm peak torque, 0.015 - 8 Nms storage	9
Magnetorquers	0.1 Nm peak torque, 1.5 Nms storage	9
Star Trackers	25 arcsec pointing knowledge	9
Sun Sensors	0.1° accuracy	9
Earth Sensors	0.25° accuracy	9
Gyroscopes	1°h ⁻¹ bias stability, 0.1°h ^{-1/2} random walk	9
GPS Receivers	1.5 m position accuracy	9



Integrated Units	1 - 0.002° pointing capability	9
Atomic Clocks	10 – 100 Frequency Range (MHz)	5/6
Deep Space Navigation	Bands: X, Ka, S, and UHF	9

5.2 State of the Art

5.2.1 Integrated Units

Integrated units combine multiple different attitude and navigation components into a single part to provide a simple, single-component solution to a spacecraft's GNC requirements. Typical components included are reaction wheels, magnetometers, magnetorquers, and star trackers. The units often include built-in attitude determination and momentum management algorithms. Table 5-2 describes some of the integrated units currently available. Blue Canyon Technologies' XACT (Figure 5.1) is currently flying on the NASA-led missions MarCO and ASTERIA, both of which are 6U platforms, and have also flown on 3U missions (MinXSS was deployed from NanoRacks in February, 2016).

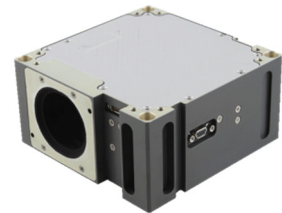

Figure 5.1: BCT XACT Integrated ADCS Unit. Image courtesy of Blue Canyon Technologies.

Product	Manufacturer	Mass (kg)	Components	Pointing Accuracy	TRL Status
High-Precision Attitude Determination and Control System	AAC-Clyde	Unkn.	Unkn.	0.5°	7
Inertial Reference Module (IRM)	Tyvak	0.61	2 Orthogonal Star Trackers, 3-Axis MEMS Gyro, Reaction Wheels (x3), Torque Coils (x3), C&DH processor, ADCS processor	0.057° 1- σ	9
MAI-400	Adcole Maryland Aerospace	0.694	3 reaction wheels, 3-axis magnetometer, 2 IREHSs, 3 torque rods	1°	9
MAI-401	Adcole Maryland Aerospace	0.56	3 reaction wheels, 3-axis magnetometer, star tracker, 3 torque rods	<0.1°	7

MAI-500	Adcole Maryland Aerospace	0.694	3 reaction wheels, 3-axis magnetometer, 2 star trackers, 3 torque rods	<0.1°	~7
XACT	Blue Canyon Technologies	0.91	3 reaction wheels, 3-axis magnetometer, star tracker, 3 torque rods	0.007°	9
XACT-50	Blue Canyon Technologies	1.23	3 reaction wheels, 3-axis magnetometer, star tracker, 3 torque rods	0.007°	9
iADCS-100	Berlin Space Technologies	0.345	Star tracker, 3 gyro modules, 3 reaction wheels, 3 magnetorquers, optional sensors	<<1°	9

5.2.2 Reaction Wheels

Miniaturized reaction wheels provide small spacecraft with precision pointing capability. Reaction wheels can provide arbitrary torques limited by the wheel's peak torque, momentum capacity, and wheel dead-band. Table 5.3 lists a selection of high-heritage miniature reaction wheels, and Figure 5.2 depicts one of the wheels offered by Sinclair Interplanetary. With the exception of three units, all of the reaction wheels listed in Table 5-3 have spaceflight heritage. For example, Blue Canyon's RWp500 has been flying on NASA's CYGNSS mission since 2015, and Millennium Space Systems has 20 RWA1000s in orbit. For full three-axis control, a spacecraft requires three wheels. However, a four wheel configuration is often used to provide fault tolerance (Jin, Ko and Ryoo, 2008). Due to parasitic external torques, reaction wheels need to be periodically desaturated using an actuator that provides an external torque, such as thrusters or magnetorquers (Kulczycki and Wisniewski 2005).



Figure 5.2: Sinclair Interplanetary RW-0.03 Reaction Wheel. Image courtesy of Sinclair Interplanetary.



Table 5-3: Reaction Wheels						
Product	Manufacturer	Mass (kg)	Peak Torque (mNm)	Momentum Capacity (Nms)	Radiation Tolerance (krad)	TRL Status
10SP-M	Surrey Satellite Technology	0.96	11	0.42	5	9
100SP-O	Surrey Satellite Technology	2.6	110	1.5	5	9
RW-0.03	Sinclair Interplanetary	0.185	0.5	0.04	20	9
RW-0.003	Sinclair Interplanetary	<0.05	1	0.005	10	6
RW-0.01	Sinclair Interplanetary	0.12	1	0.018	20	9
RW3-0.06	Sinclair Interplanetary	0.226	20	0.18	20	9
MAI-400 Reaction Wheel	Adcole Maryland Aerospace	0.11	0.635	.0111	Unkn.	9
MicroWheel	Blue Canyon Technologies	0.13	4	0.015	Unkn.	9
RWp500	Blue Canyon Technologies	0.75	25	0.5	Unkn.	9
RWp050	Blue Canyon Technologies	0.24	7	0.05	Unkn.	6
RWp100	Blue Canyon Technologies	0.35	7	0.1	Unkn.	6
SmallSat Reaction Wheel	ClydeSpace	1.5	40	Unkn.	10	9
RWA1000	Millenium Space Systems	Unkn.	1000	0.1	Unkn.	9
VRW-02	Vectronic Aerospace	1	20	0.2	>20	9



5.2.3 Magnetorquers

Magnetorquers are an established technology used in small spacecraft and can provide control torques perpendicular to the local external magnetic field. Table 5-4 lists a selection of high heritage magnetorquers and Figure 5.3 illustrates some of ZARM Technik's product offerings. Magnetorquers are often used in combination with wheels to remove excess momentum. As control torques can only be provided in the plane perpendicular to the local magnetic field, full 3-axis stabilization is not possible at any given time.



Figure 5.3: ZARM Technik Magnetorquers for Micro-Satellites. Image Courtesy of ZARM.

Product	Manufacturer	Mass (kg)	Peak Dipole (A m ²)	Radiation Tolerance (krad)	TRL Status
MTR-5	Surrey Satellite Technology	0.5	5	5	9
MT0.1-1	ZARM	0.003	0.1	Unkn.	9
MT1-1	ZARM	0.060	1	Unkn.	9
0-1-1	Spaceflight Industries	0.727	15	Unkn.	9
Electromagnet (Type A)	Adcole Maryland Aerospace	0.018	0.15	Unkn.	9
TQ-40	Sinclair Interplanetary	0.825	48	Unkn.	9
TQ-15	Sinclair Interplanetary	0.4	19	Unkn.	9
SatBus MTQ	NanoAvionics	<0.2	0.2	Unkn.	9



5.2.4 Thrusters

Thrusters used for attitude control are described in the Chapter 4. Pointing accuracy is determined by minimum impulse bit, and control authority by thruster force.

5.2.5 Star Trackers

A star tracker can provide an accurate, standalone estimate of the spacecraft's attitude by comparing a digital image captured with a CCD or CMOS sensor to an onboard star catalog (Spratling and Mortari 2009). Table 5-5 lists some models suitable for use on a small spacecraft, one of which is depicted in Figure 5.4. Sinclair Interplanetary has flown about 38 ST-16RT2 units, Blue Canyon Technologies has flown the Extended NST onboard the DARPA High Frequency Receiver Experiment, and many other star trackers also have notable flight heritage.



Figure 5.4: SSSL Procyon Star Tracker. Image courtesy Surrey Satellite Technology Ltd.

Product	Manufacturer	Mass Incl. Baffle (kg)	Accuracy (arcsec)	Radiation Tolerance (krad)	TRL Status
Rigel-L	Surrey Satellite Technology	2.2	25	5	9
Procyon	Surrey Satellite Technology	1.7	30	5	9
ST-16	Sinclair Interplanetary	0.12	74	9	9
ST-16RT2	Sinclair Interplanetary	0.185	55	Unkn.	9
MAI-SS Space Sextant	Adcole Maryland Aerospace	0.282	27	75	9
Standard NST	Blue Canyon Technologies	0.35	40	Unkn.	9
Extended NST	Blue Canyon Technologies	1.3	40	Unkn.	9
ST200	Berlin Space Technologies	0.04	10	11	9



5.2.6 Magnetometers

Magnetometers provide a measurement of the local magnetic field, and this measurement can be used to provide both estimates of attitude (Psiaki, Martel and Pal 1990) and also orbital position. The vast majority of CubeSats use COTS magnetometers and improve their performance with software. Table 5-6 provides a summary of some 3-axis magnetometers available for small spacecraft, one of which is illustrated in Figure 5.5.



Figure 5.5: NSS Magnetometer. Image courtesy of NewSpace Systems.

Table 5-6: Magnetometers						
Product	Manufacturer	Mass (kg)	Resolution (nT)	Orthogonality (°)	Radiation Tolerance (krad)	TRL Status
Magnetometer	New Space Systems	0.085	10	<1	10	9
Magnetometer	Surrey Satellite Technology	0.14	10	<1	10 (Si)	9
3-axis Magnetometer	Adcole Maryland Aerospace	Unkn.	Unkn.	Unkn.	Unkn.	9
MAG-3	SpaceQuest	0.1	Unkn.	<1	10	9
MicroMag3	PNI Corp	0.2	15	<1	Unkn.	9
MAG-3 Three-Axis Magnetometer	SpaceQuest	0.1	Unkn.	<1	10	9



5.2.7 Sun Sensors

Sun sensors (Figure 5.6) are used to provide an estimate of the location of the Sun in the spacecraft body frame, which in turn can be used to estimate attitude. A digital two-axis sun sensor can provide perfectly fine sun vector solutions, but multiple sensors are typically used in case a spacecraft is “lost in space.” Fine sun sensors provide a full 2-axis estimate of Sun location (Chang, Yun and Lee 2007) and a minimum of four are required. Examples of small spacecraft sun sensors are described in Table 5-7.



Figure 5.6: Adcole Coarse Sun Sensor Detector (Cosine Type). Image courtesy of Adcole Corporation.

Table 5-7: Sun Sensors					
Product	Manufacturer	Mass (kg)	Accuracy (°)	Radiation Tolerance (krad)	TRL Status
Fine (digital) Sun Sensor	New Space Systems	0.035	0.1	10	9
Analog Sun Detector	Adcole Maryland Aerospace	0.068	0.75	Unkn.	9
CSS-01	Space Micro	0.0141	5	Unkn.	9
BiSon64	Lens Research & Development	0.0217	0.5	1100	8
BiSon64-B	Lens Research & Development	0.0217	0.5	1100	8
BiSon74-ET-RH	Lens Research & Development	0.0245	0.7	1100	~6
SS-411	Sinclair Interplanetary	0.034	0.1	20	9
DSS1	NanoAvionics	0.015	0.5	Unkn.	9



5.2.8 Horizon Sensors

Horizon sensors can be simple infrared horizon crossing indicators (HCI) or more advanced thermopile sensors can be used to detect the temperature differences between the poles and the equator. For terrestrial applications, these sensors are referred to as Earth Sensors, but can be used for other planets. Examples of such technologies are described in Table 5-8 and illustrated in Figure 5.7.

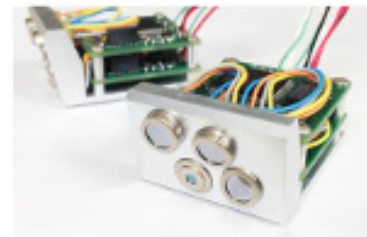

Figure 5.7: MAI-SES. Image courtesy of Maryland Aerospace Inc.

Product	Manufacturer	Mass (kg)	Accuracy (°)	TRL Status
MAI-SES Static Earth Sensor	Adcole Maryland Aerospace	0.033	0.25	9
Mini Digital HCI	Servo	0.050	0.75	9

5.2.9 Gyros

Gyroscopes provide a measurement of angular velocity. The main gyro types used in small spacecraft are fiber optic gyros (FOGs) and MEMS gyros, with FOGs offering better performance at a mass and cost penalty (Greenheck, et al. 2014). Table 5-9 lists a sample of gyros available for small spacecraft.

Product	Manufacturer	Type	Mass (kg)	Bias Stability ($^{\circ}\text{h}^{-1}$)	Random Walk ($^{\circ}\text{h}^{-1/2}$)	Radiation Tolerance (krad)	TRL Status
MIRAS-01	Surrey Satellite Technology	3-axis MEMS	2.8	10	0.6	5	9
LN-200S	Northrop Grumman	3-axis FOG	0.75	1	0.07	10	9
ADIS16405	Analog Devices	3-axis MEMS	0.016	25	2.0	Unkn.	9
MASIMU04	Micro Aerospace Solutions	3-axis MEMS	0.03	0.6	Unkn.	Unkn.	Unkn.

5.2.10 GPS Receivers

For LEO spacecraft, GPS receivers are now the primary method for performing orbit determination, replacing ground-based tracking methods. Onboard GPS receivers are now considered a mature technology for small spacecraft, and some examples are described in Table 5-10. There is a new generation of chip-size COTS GPS solutions, for example the NovaTel OEM 719 board has replaced the ubiquitous OEMV1.

GPS accuracy is limited by propagation variance through the exosphere and the underlying precision of the civilian use C/A code (Montenbruck, et al. 2014). GPS units are controlled under the Export Administration Regulations (EAR) and must be licensed to remove COCOM limits (Office of the Federal Register 2015).

Product	Manufacturer	Mass (kg)	Accuracy (m)	Radiation Tolerance (krad)	TRL Status
SGR-05U	Surrey Satellite Technology	0.04	10	5	9
SGR-10	Surrey Satellite Technology	0.95	10	10	9
OEM615	Novatel	0.021	1.5	Unkn.	9
piNAV-NG	SkyFox Labs	0.024	10	Unkn.	9

5.2.11 Deep Space Navigation

In deep space, navigation is performed using radio transponders in conjunction with the Deep Space Network (DSN). As of 2018, the only deep space transponder with flight heritage that is suitable for small spacecraft is the JPL-designed and General Dynamics-manufactured Small Deep Space Transponder (SDST). JPL has also designed IRIS V2, which is a deep space transponder that is more suitable for the CubeSat form factor. Table 5-11 details these two radios, and the SDST is illustrated in Figure 5.8. IRIS V2, derived from the Low Mass Radio Science Transponder (LMRST), is currently flying on the MarCO CubeSats and is scheduled to fly on INSPIRE (Aguirre 2015).



Figure 5.8: General Dynamics SDST. Image courtesy of General Dynamics.



Table 5-11: Deep Space Transponders				
Product	Manufacturer	Mass (kg)	Bands	TRL Status
SDST	General Dynamics	3.2	X, Ka	9
IRIS V2	JPL	0.4	X, Ka, S, UHF	9

5.2.12 Atomic Clocks

Atomic clocks have been used on larger spacecraft in LEO for several years now, however integrating them on small spacecraft is relatively new. The conventional method for spacecraft navigation is a two-way tracking system of ground-based antennas and atomic clocks. The time difference from a ground station sending a signal and the spacecraft receiving the response can be used to determine the spacecraft's location, velocity, and path. This is not a very efficient process, as the spacecraft must wait for navigation commands from the ground station instead of making real time decisions, and the ground station can only track one spacecraft at a time, as it must wait for the spacecraft to return a signal (Baird 2018). In deep space navigation, the distances are much greater from the ground station to spacecraft, and the accuracy of the radio signals needs to be measured within a few nanoseconds.

JPL's Deep Space Atomic Clock (DSAC) project plans to launch a prototype of a small, low mass (16 kg) atomic clock based on mercury-ion trap technology, which underwent demonstration testing in the fall of 2017. The project aims to produce a <10 kg configuration in the second generation. The DSAC is slated for will launch in 2019 as a hosted payload on General Atomic's Orbital Test Bed spacecraft aboard the U.S. Air Force Space Technology Program (STP-2) mission (Cornwell 2016).

More designers of small spacecraft technology are developing their own version of atomic clocks and oscillators to be used in space and need to ensure they are properly synchronized. They are designed to fit small spacecraft, missions that are power and volume limited, and those that require multiple radios. Table 5-12 lists the atomic clocks and oscillators available for small spacecraft missions.



Figure 5.9: Iris series 1x1 OCXO for LEO. Image courtesy of Bliley Technologies.

Bliley Technologies

Bliley Technologies has developed a miniature Half-DIP package low power Oven-Controlled Crystal Oscillation (OCXO) and an Iris series 1"x1" OCXO for LEO (Figure 5.9) that is desirable for power constrained missions. The Half-DIP package has 135 mW power consumption, and superior close in phase noise of -125 dBc/Hz at 10 Hz (Bliley Technologies, Inc. 2017). This part is characterized at TRL 6, however the components have not been radiation tested. The Iris series can range from 10-100 MHz in frequency and has a stability vs temperature performance of +/-25ppb with a sine output and a radiation tolerance of 38 kRAD TID (Bliley Technologies, Inc. 2017).

Table 5-12: Atomic Clocks					
Product	Manufacturer	Dimensions (mm)	Power Consumption	Frequency Range (MHz)	TRL Status
Miniature Half-DIP Package Low Power OCXO	Bliley Technologies, Inc.	Up to 12 x 12 x 10	135 - 180 mW at steady state	10 – 60	6
Iris Series 1"x1" OCXO for LEO	Bliley Technologies, Inc.	19 x 11 x 19	1.5 W at steady state	10 - 100	6
Ultra Stable Oscillator	AccuBeat, Ltd.	120 x 120 x 120	3.8 W	Unkn.	6
9635QT	Microsemi	33 x 33 x 33	Unkn.	Unkn.	6
Miniature Atomic Clock (MAC) SA.3Xm	Microsemi	50.8 x 50.8 x 18	5 – 8 W	10	Unkn.
Space Chip Scale Atomic Clock (CSAC)	Microsemi	40 x 35 x 11	<120 mW	10	9

5.3 On the Horizon

Technological progress in the area of guidance, navigation, and control is slow. Given the high maturity of existing GNC components, future developments in GNC are mostly focused on incremental or evolutionary improvements, such as decreases in mass and power, increases in longevity and/or accuracy. This is especially true for GNC components designed for deep space missions, where small spacecraft-focused missions have only very recently been proposed. However, in a collaborative effort between the Swiss Federal Institute of Technology and Celeroton, there is progress being made on a high-speed magnetically levitated reaction wheel for small satellites (Figure 5.10)**Error! Reference source not found..** The idea is to eliminate mechanical wear and stiction by using magnetic bearings rather than ball bearings. The reaction wheel implements a dual hetero/homopolar, slotless, self-bearing, permanent-magnet synchronous motor (PMSM). The fully active, Lorentz-type magnetic bearing consists of a heteropolar self-bearing motor that applies motor torque and radial forces on one side of the rotor's axis, and a homopolar machine that



Figure 5.10: High-speed magnetically levitated reaction wheel. Image courtesy of Borque Gallego Guzman.



exerts axial and radial forces to allow active control of all six degrees of freedom. It is capable of storing 0.01 Nm of momentum at a maximum 30,000 rpm, applying a maximum torque of 0.01 Nm (Kolar, et al. 2016).

5.4 Summary

Small spacecraft GNC is a mature area, with many previously flown, high TRL components offered by several different vendors. Progress in developing integrated units will offer simple, single vendor, modular devices for ADCS which will simplify GNC subsystem design. Other areas of GNC have potential for improvements as more research is being conducted. For example, a team at the University of Michigan is developing a multi-algorithmic hybrid ADCS system for CubeSats that can implement multiple estimation and control algorithms (Lee, Kuevor and Culter 2016). Another team from Johns Hopkins University is conducting ground simulations of docking, charging, relative navigation, and deorbiting for a fully robotic CubeSat (Mishra, Basescu and Kobilarov 2016). The RANGE mission from Georgia Institute of Technology is a pair of 1.5U CubeSats that will improve the relative and absolute positioning capabilities of nanosatellites (Gunter, et al. 2016).

The rising popularity of smallsats in general, and CubeSats in particular, means there is a high demand for components, and engineers are often faced with prohibitive prices. The Space Systems Design Studio at Cornell University is tackling this issue for GNC with their PAN nanosatellites. A paper by Choueiri, et al. outlines an inexpensive and easy-to-assemble solution for keeping the ADC system below \$2,500 (Choueiri, Bell and Peck 2018). Lowering the cost of components holds exciting implications for the future, and will likely lead to a burgeoning of the smallsat industry.

References

- Bliley Technologies, Inc. 2017. "LP102 Low Power OCXO Datasheet."
- Aguirre, F. H. 2015. "X-Band Electronics for the INSPIRE CubeSat Deep Space Radio." *IEEE Aerospace Conference*.
- Baird, D. 2018. "NASA Tests Atomic Clock for Deep Space Navigation." <https://www.jpl.nasa.gov/news/news.php?feature=7053>.
- Bliley Technologies, Inc. 2017. "Iris Series – 1x1 OCXO for LEO orbits datasheet." Accessed June 19, 2018. https://cdn2.hubspot.net/hubfs/2222150/Assets/Datasheets/05_OCXOs/Iris_LEO_OCXO_v3.pdf.
- Chang, Y. K., M. Y. Yun, and B. H. Lee. 2007. "A New Modeling and Validation of Two-axis Miniature Fine Sun Sensor." Vol. 134, no. 2, pp. 357-365.
- Choueiri, M. N., M. Bell, and M. A. Peck. 2018. "Cost-Effective and Readily Manufactured Attitude Determination and Control System for NanoSatellites." *AIAA/ASCE/AHS/ASC Structures, Structural Dynamics, and Materials Conference, AIAA SciTech Forum*.
- Cornwell, D. 2016. "NASA's Deep Space Atomic Clock and Optical Communications Program for PNT Applications." Accessed June 19, 2018. <https://www.gps.gov/governance/advisory/meetings/2016-12/cornwell.pdf>.



- Greenheck, D., R. Bishop, E. Jonardi, and J. Christanson. 2014. "Design and Testing of a Low-Cost MEMS IMU Cluster for SmallSat Applications." *28th Annual AIAA/USU Conference on Small Satellites*.
- Gunter, B. C., B. Davis, G. Lightsey, and R. Braun. 2016. "*The Ranging and Nanosatellite Guidance Experiment (RANGE)*." <https://digitalcommons.usu.edu/smallsat/2016/S5GuidCont/3/>.
- Jin, J., S. Ko, and C. K. Ryoo. 2008. "Fault Tolerant Control for Satellites with Four Reaction Wheels." Vol. 16, no. 10, pp. 1250-1258.
- Kolar, J. W., C. Zwysig, M. Kaufmann, and A. Tüysüz. 2016. "High-speed Magnetically Levitated Reaction Wheels for Small Satellites." *2016 International Symposium on Power Electronics, Electrical Drives, Automation and Motion (SPEEDAM)*.
- Kulczycki, R., and P. Wisniewski. 2005. "Slew Maneuver Control for Spacecraft Equipped with Star Camera and Reaction Wheels." Vol. 13, no. 3, pp. 349-356.
- Lee, D. Y., P. Kuevor, and J. Culter. 2016. "*Multi-algorithmic Hybrid Attitude Determination and Control System of the CubeSat 'CADRE'*." <https://digitalcommons.usu.edu/smallsat/2016/S2CDH/2/>.
- Mishra, S., M. Basescu, and M. Kobilarov. 2016. "*Laboratory Validation of Vision Based Grasping, Guidance and Control with Two Nanosatellite Models*." <https://digitalcommons.usu.edu/smallsat/2016/S5GuidCont/6/>.
- Montenbruck, O., P. Swatschina, M. Markgraf, S. Santandrea, J. Naudet, and E. Tilmans. 2014. "Precision Spacecraft Navigation Using a Low-cost GPS Receiver." Vol. 16, no. 4, pp. 519-529.
- Office of the Federal Register. 2015. "Foreign Availability Determination Procedures and Criteria." Vol. 15; Part 768.7.
- Psiaki, M. L., F. Martel, and P. K. Pal. 1990. "Three-axis Attitude Determination via Kalman Filtering of Magnetometer Data." Vol. 13, no. 3, pp. 506-514.
- Shepherd, L. C. G., and A. F. S. C. Shepherd. 2006. "Space Surveillance Network." *Shared Space Situational Awareness Conference*. Olorado Springs.
- Spratling, B. B., and D. Mortari. 2009. "A Survey on Star Identification Algorithms." Vol. 2, no. 1, pp. 93-107.
- Thornton, C. L., and J. S. Border. 2003. "*Radiometric Tracking Techniques for Deep-space Navigation*. John Wiley & Sons.
- Vallado, D. A., P. Crawford, R. Hujsak, and T. S. Kelso. 2006. "*Revisiting Spacetrack Report 3*." Vol. 6753, pp. 2006-2006.
- Wertz, J. R. 2012. "Spacecraft Attitude Determination and Control." Vol. 73. *Springer Science & Business Media*.



6.0 Structure, Mechanisms, and Materials

6.1 Introduction

Since the last edition of this report there has been further expansion of offerings for commercial-off-the-shelf structures, and likewise an expansion of custom machined, composite, and even printed structures used, or proposed for use, on small spacecraft missions. This chapter will refer to small spacecraft structures with a focus on 1U – 12U platforms, and specifically those components designed to transmit loads through the spacecraft to the interface of the launch and deployment system, and provide attachment points for payloads and associated components. These structures are typically classified as the primary structure. For contrast, secondary structures are all other structures (like solar panels, thermal blankets etc.), that only need to support themselves. When a primary structure fails it is almost always catastrophic, while failure of a secondary structure typically does not affect the integrity of the spacecraft, but can have a significant impact on the overall mission. These structural categories serve as a good reference but the lines between them can be hard to distinguish for small spacecraft since they are particularly constrained by volume. This is especially true for CubeSats, as the capabilities of these spacecraft have expanded but the volume afforded by the standard dispensers (by definition) have not. Therefore, it is often essential that the structural components be as volume-efficient as possible. To achieve this volume efficiency, the primary structural components must not only carry mechanical loads, but may also serve as the primary component for thermal management, provide the primary means for radiation shielding, serve as a pressure containment vessel, and even behave as a strain actuation component-features that are often assigned to secondary structural components in larger spacecraft.

Important to any discussion of small spacecraft structure is the material of the structure itself. Typically a spacecraft's structure is made up of both metallic and non-metallic materials. Metals are commonly homogeneous and isotropic, meaning they have the same properties at every point and in every direction. Non-metals, such as composites, are normally neither homogeneous nor isotropic. Material choice is driven by the operational environment of the spacecraft and must ensure adequate margin for launch and operational loads, thermal balance and thermal stress management, and by the sensitivities of the instrumentation and payload to outgassing and thermal displacements.

The design of the structure is not only affected by the different subsystems and launch environments, but also the application and operations of the spacecraft, such as the configuration differences for a spin versus a 3-axis stabilized system. Instrumentation also places requirements on the structure and can require mechanisms, such as a deployable boom to create some distance between a magnetometer and the spacecraft to minimize its effect on the measurement.

Also included in this chapter is an overview of radiation effects and some mitigation strategies as radiation impacts structural design considerations for small spacecraft.

The author would like to highlight that the presented tables are not intended to be exhaustive but to provide an overview of current state-of-the-art technologies and their development status for this small spacecraft subsystem. There is no intention of mentioning certain companies and omitting others based on their technologies.

6.2 State of the Art

Two general approaches are common for primary structures in the small spacecraft market: COTS structures and custom machined or printed components. Maybe unsurprisingly, most



COTS offerings are for the CubeSat market. Often the COTS structures can simplify the development of a small spacecraft, but only as the complexity of the mission, subsystems, and payload requirements fall within the design intent of the COTS structure offered.

6.2.1 Primary Structure

There are now several companies that provide CubeSat primary structures (often called frames or chassis). Most are machined from 6061-T6 or 7075 aluminum and are designed with several mounting locations for components in an attempt to offer configuration flexibility for spacecraft designers. This section will highlight several approaches taken by various vendors in the CubeSat market. Of the offerings included in the survey, 1U, 3U and 6U frames are more prevalent, however 12U frames are becoming more available as well. As there are now dispensers for the 12U CubeSat structure, it is a new standard for CubeSat configuration. This trend has been similar to the development of the 6U and is typical until a dispenser is space-qualified, which tends to set the standard for the exact dimensional constraints of the spacecraft within.

Monocoque Construction

PUMPKIN, INC.

The structural approach taken by Pumpkin for their 1U – 3U spacecraft is of a monocoque approach, where loads are carried by the external skin in an attempt to maximize internal volume. Pumpkin, Inc. provides several COTS CubeSat structures intended as components of their CubeSat Kit solutions, ranging in size from sub-1U to the larger 6U – 12U SUPERNOVA structures (Pumpkin, Inc. 2017). Pumpkin offerings are machined from Al 5052-H32 and can be either solid-wall or skeletonized; see Figure 6.1 for their skeletonized 1U construction.



Figure 6.1: 1U Skeletonized CubeSat Kit. Image courtesy of Pumpkin, Inc. (2015).

Pumpkin has developed the SUPERNOVA, a 6U and 12U structure that features a machined aluminum modular architecture. The 6U structure (Figure 6.2), is designed to integrate with the Planetary Systems Corporation (PSC) Canisterized Satellite Dispenser, and accommodates the PSC Separation Connector for power and data during integration (Pumpkin, Inc., 2017).

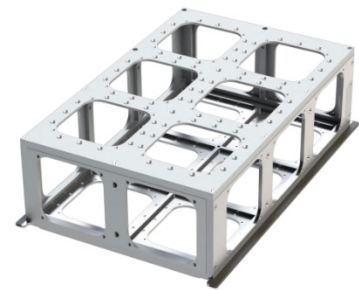

Figure 6.2: The 6U Supernova Structure Kit. Image courtesy of Pumpkin, Inc. (2015).

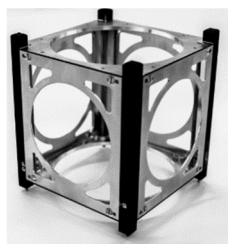

Figure 6.3: 1U CS Structure. Image courtesy of Clyde Space.

CLYDE SPACE CS CUBESAT STRUCTURE

Clyde Space also offers a monocoque CubeSat structure from 1U – 3U. The 1U chassis (Figure 6.3) has a total mass of 0.155 kg and dimensions of 100 x 100 x 113.5 mm. The 2U structure has a mass of 0.275 kg and dimensions of 100 x 100 x 227 mm. The 3U structure has a mass of 0.155 kg and dimensions of 100 x 100 x 113.5 mm. Clyde Space design sought to standardize their components to make the spacecraft easier to reconfigure than other COTS structures as both 1U and 3U structures interface with all standard deployment PODs, including NanoRacks (Clyde Space, 2018).



Modular Frame Designs

NANOAVIONICS MODULAR FRAME

NanoAvionics has developed what it calls “standardized frames and structural element” that, when assembled, form the primary structure for 1U to 12U spacecraft. The 1 – 3U form factors have masses from 0.090 kg, 0.172 kg, and 0.254 kg for 1U, 2U and 3U respectively. A modular 3U structure from NanoAvionics is shown in Figure 6.4. These components are intended to be modular, made from 7075 aluminum, and like many COTS CubeSat structures, compliant with the PC/104 form factor (NanoAvionics 2018).

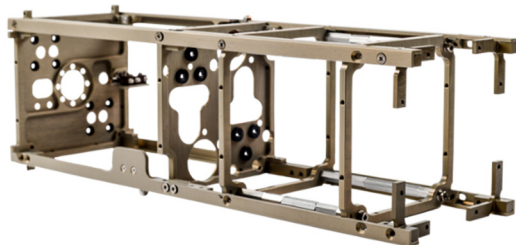

Figure 6.4: NanoAvionics Small Satellite Structures.
Image courtesy of NanoAvionics.

RADIUS CUBESAT STRUCTURES

Radius Space has also chosen a highly modular approach to developing a family of CubeSat structures that range from the 1U to 12U sizes. Figure 6.5 shows this modular approach for 1U to 3U sizes. PCB integration is typically accomplished through a stacked configuration, although Radius Space asserts the structures allow for different PCB orientations for all but the 1U frame (Radius Space 2018).



Figure 6.5: The Radius Space Modular Structures.
Image Courtesy of Radius Space (2015).

INNOVATIVE SOLUTIONS IN SPACE (ISIS) STRUCTURES

ISIS offers a wide array of CubeSat structures, with the largest being a 16U structure coming in 2018. Several of their 1U, 2U, 3U and 6U structures have been flown in LEO, see Table 6-1 for more information on these structures.



Table 6.0-1: ISIS CubeSat Structures				
Structure	Dimensions (mm)	Primary Structure Mass (kg)	Primary + Secondary Structure Mass (kg)	TRL Status
1U	100 x 100 x 114	0.1	0.2	9
2U	100 x 100 x 227	0.16	0.2	9
3U	100 x 100 x 341	0.24	0.3	9
6U	100 x 226 x 340.5	0.9	1.1	9
8U	226 x 226 x 227	1.3	1.9	Unkn.
12U	226.3 x 226 x 341	1.5	2.0	7

With the ISIS design, multiple mounting configurations can be considered, allowing a high degree of creative flexibility. Detachable shear panels allow for access to all of the spacecraft's electronics and avionics, even after final integration (ISIS, 2018).

GOMSPACE NANOSATELLITE STRUCTURE

GOMspace provides full turn-key solutions for small satellite systems. They offer modular nanosatellite structures from 1 – 6U with strong flight heritage. The 6U (Figure 6.6) has a 4U payload allocation, mass of 8 kg, and propulsive configuration capabilities. The 3U structure was first deployed from the ISS in 2015, and two 6U systems were deployed in early 2018. The 7075 aluminum structure weighs 1.06 kg (GomSpace 2018).

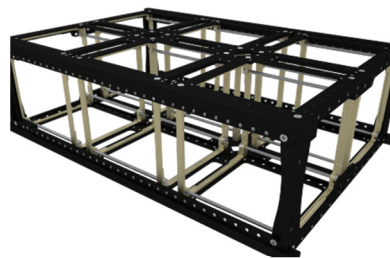

Figure 6.6: The GOMspace 6U nanosatellite structure. Image courtesy of GOMspace ApS (2018).

ENDUROSAT

EnduroSat provides 1U/1.5U/3U/6U CubeSat structures that range in dimension: 100 x 100 x 113.5 mm to 100 x 226.3 x 366 mm (1U – 6U); material for all Endurosat structures is made of Aluminum 6061-T651 (see Table 6-2 for complete list). While the 1U structure (TRL 9) has gone through all the qualified testing and was deployed as EnduroSat-1 in July, 2018, the 3U and 6U structures still must undergo thermal cycling and vacuum testing, as well as radiation analysis (Endurosat 2017).

Table 6-2: Endurosat CubeSat Structures				
Structure	Dimensions (mm)	Primary Structure Mass (kg)	Material	TRL Status
1U	100 x 100 x 114	<0.1	Al 6061 or 7075	9
1.5U	100 x 100 x 170.2	0.11	Al 6061 or 7075	Unkn.
3U	100 x 100 x 340	<0.29	Al 6061	6
6U	100 x 226 x 366	<1	Al 6061	5

Card Slot System

COMPLEX SYSTEMS & SMALL SATELLITES (C3S)

C3S has developed a 3U CubeSat structure that uses a card slot system, as shown in Figure 6.7, which is intended to provide several benefits over the more common PC/104 stack solution. These benefits include access to individual cards during integration and testing (PC/104 solutions require de-integration of an entire stack to isolate a single card), improved stack-up tolerance, and better thermal management of individual cards compared to a traditional PC/104 stack, where all cards are connected in series and are thermally interdependent (Complex Systems & Small Satellites 2018).



Figure 6.7: C3S 3U CubeSat Structure. Image courtesy of Complex Systems & Small Satellites (2015).

6.2.2 Mechanisms

There are several companies offering mechanisms for small spacecraft and smaller markets. Although not exhaustive, this section will highlight a few devices for release actuation, component pointing, and boom extension, which represent the state-of-the-art for the CubeSat market. For deployable mechanisms used for deorbit devices, please refer to the "Deorbit" chapter.

CTD: Deployable Booms

Composite Technology Development (CTD) has developed a composite boom called the Stable Tubular Extendable Lock-Out Composite (STELOC), that is rolled up or folded for stowage and deploys using stored strain energy. The slit-tube boom, shown in Figure 6.8 employs an innovative interlocking edge feature along the tube slit that greatly enhances stability. The boom can be fabricated in many custom diameters and lengths, offers a small stowed volume, and has a near-zero coefficient of thermal expansion (CTE) (Composite Technology Development 2018).

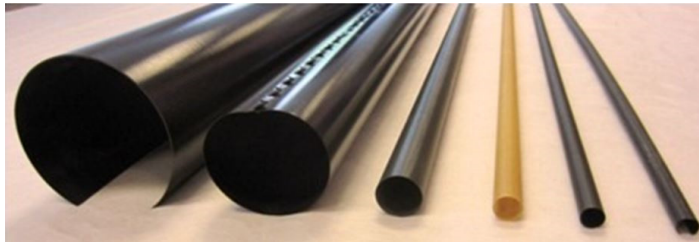

Figure 6.8: CTD's Deployable Composite Booms. Image courtesy of Composite Technology Development (2015).

AlSat-1N: AstroTube Deployable Boom

Oxford Space Systems collaborated with Algeria to develop the AstroTube deployable boom (Figure 6.9) that was recently demonstrated in LEO on a 3U CubeSat called AlSat-1N. It is the longest retractable boom that has been deployed and retracted on the 3U CubeSat platform. It incorporates a flexible, composite structure for the 1.5 m-long boom element, and a novel deployment mechanism for actuation. When retracted, the boom is housed within a 1U volume and has a total mass of 0.61 kg (Revels, et al. 2017).

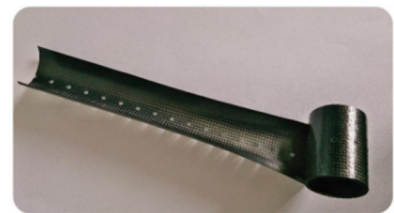

Figure 6.9: The flexible composite member that is employed on the AstroTube. Courtesy of Reveles, et al.

ROCCOR: Deployable Booms

ROCCOR has developed several different deployable booms that have a wide range of applications on small spacecraft. The ROC (Roll Out Composite) Boom can be deployed with antennas and instruments. This boom is 1- 5 m in length and is made out of carbon fiber composite shells that use a passive spring to unroll the device.

The TRAC (Triangle Rollable and Collapsible) Boom, originally developed for AFRL, can be as long as 7 m. The CubeSat ROC Boom Deployer is awaiting launch at the end of 2018 to reach TRL 7. The volume of this deployer is 1 x 1 x 1.5U, has a length up to 1.5 m, and a total mass of <1 kg.



Tethers Unlimited: 3 DOF Gimbal Mechanism

Tethers Unlimited offers a 3 degrees of freedom gimbal mechanism called the Compact On-Board Robotic Articulator (COBRA). This mechanism provides accurate pointing for sensors and thrusters. The COBRA (Figure 6.10) packages down to 100 x 100 x 33.25 mm and weighs 155 grams (Tethers Unlimited, Inc. 2018).

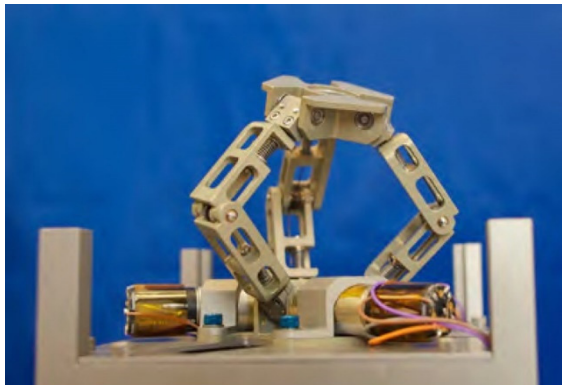

Figure 6.10: Tethers Unlimited Compact On-Board Robotic Articulator. Image Courtesy of Tethers Unlimited, Inc. (2015).

The KRACKEN Robotic Arm is modular, with high-dexterity (up to 11 degrees of freedom [DOF]) and will enable CubeSats to perform challenging missions, such as on-orbit assembly, satellite servicing, and debris capture. The arm has a mass of 4.2 kg and can be stowed in a 3U volume with a 2 m diameter hemispherical workspace per arm (Tethers Unlimited 2018). The TRL for this system is 5, assuming a LEO environment.

Honeybee: Solar Panel Drive Actuator

Honeybee in cooperation with MMA has developed a CubeSat Solar Array Drive Actuator (SADA) that accommodates $\pm 180^\circ$ single-axis rotation for solar array pointing, can transfer 100 W of power from a pair of deployed panels, and features an auto sun-tracking capability (Honeybee Robotics 2018). Honeybee also offers the unit in a slip-ring configuration for continuous rotation. Table 6-3 highlights a few key specifications for this actuator.

Table 6-3: Honeybee CubeSat SADA	
Mass (slip ring option)	0.18 kg
Backlash	< 3°
Operating Temperature Range	-30 to +85°C
Size	100 x 100 x 6.5 mm
Radiation Tolerance	10 krad
Wire Wrap7 channels per wing	@ 1.4 A per channel
Slip Ring10 channels per wing	@ 0.5 A per channel

TiNi Aerospace

TiNi Aerospace has several release mechanisms available for the small spacecraft market, but perhaps the most relevant to the CubeSat market is the Frangibolt Actuator (particularly the FD04 model), due to its small size and power specifications. The Frangibolt operates by applying power to a Copper-Aluminum-Nickel memory shape alloy cylinder which generates force to fracture a custom notched fastener in tension. The Frangibolt is intended to be reusable by re-compressing the actuator using a custom tool and replacing the notched fastener (TiNi Aerospace, 2018). Figure 6.11 shows a model of the FD04 Frangibolt actuator and Table 6-4 describes a few key specifications.

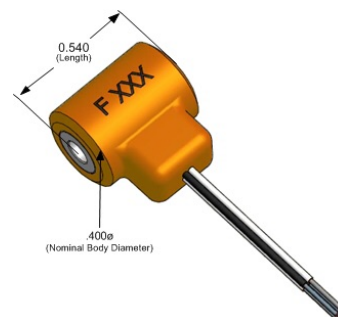

Figure 6.11: TiNi Aerospace Frangibolt Actuator. Image courtesy of TiNi Aerospace (2015).

Mass	7 g
Power C	15 W @ 9 VD
Operating Temperature Range	-50 to +80°C
Size	13.72 x 10.16 mm
Holding Capacity	667 N
Function Time Typically	20 sec @ 9 VDC
Life	50 cycles MIN

Other offerings from TiNi Aerospace include the Ejector Release Mechanism (ERM), a device capable of holding high loads with fast actuation time; the Micro Latch, which was developed specifically for new space applications and can release preloads up to 50 lbf; the Pinpuller, a trigger mechanism that retracts with a force of 5-1000 lbf; and the Optical Shutter, a simple and effective solution to an actuating aperture for light sensitive instruments.

6.2.3 Additive Manufacturing Materials

The use of additive manufacturing for spacecraft primary structures has been proposed for several years, but only now has this process been adopted by flight missions (it is important to note, however, that additive manufacturing has been quite common for small spacecraft secondary structural elements for many years). Typically, the advantage of additive manufacturing is to free the designer from manufacturing constraints imposed by standard manufacturing processes, and allow for monolithic structural elements with complex geometry. In practice however, additive manufacturing has its own set of geometric constraints, but when

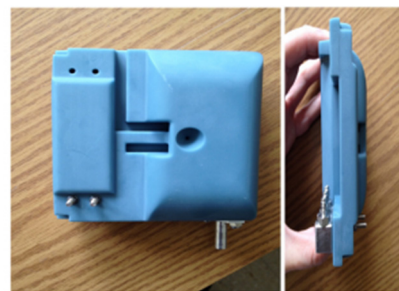

Figure 6.12: Cold Gas Propulsion Module fabricated using Accura Bluestone. Image courtesy of Steven Arestie, E. Glenn Lightsey, Brian Hudson (2012).



these constraints are understood and respected, the designer can approach a design challenge with a larger tool set that has not been available in the recent past.

Density	1.78 gcm ⁻³
Color	Blue
Glass Transition (T _g)	78-81°C
Tensile Strength	66-68 MPa
Tensile Modulus	7600-11700 MPa
Flexural Strength	124-154 MPa
Outgassing, TML	low

Accura Bluestone

3D Systems Corporation has developed a stereolithographically fabricated composite material that shows promise for spacecraft structures. This material is currently being used as the main structural component for nozzles, tubing, and storage of the cold-gas propulsion system shown in Figure 6.12, originally developed at the University of Texas Austin and now being developed for several missions at Georgia Institute of Technology. Table 6-5 shows a summary of material properties published by 3D Systems (3D Systems Inc., 2015). The 3D printed attitude thruster designed for BioSentinel, a 6U interplanetary spacecraft that will be launched with EM-1 in 2019, is made from Accura Bluestone (Stevenson & Lightsey, 2016)

Windform Materials

CRP Technology is using selective laser sintering (SLS) technology for their carbon filled polyamide-based material, called Windform XT 2.0. The Windform material has been tested under VUV radiation exposure and did not show any signs of degradation (CRP Technology, 2018). Table 6-6 shows a summary of material properties published by CRP.

Density	1.097 gcm ⁻³
Color	Black
Melting Point	179.3°C
Tensile Strength	83.84 MPa
Tensile Modulus	8928.20 MPa
Resistivity, Surface	< 10 ⁸ Ohm
Outgassing, TML	0.57%

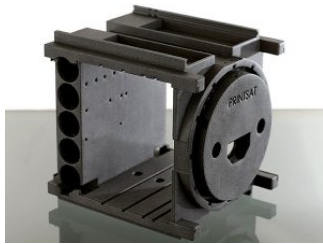

Figure 6.13: Windform PrintSat Structure. Image courtesy of CRP Technology (2015).

TuPOD is a nanosatellite that was launched in September 2016 and was constructed using the Windform XT 2.0 from CRP. The successful operation of TuPOD is exciting to the small satellite world because its innovative 3D structure is one of few structures of its kind.

The Montana State PrintSat mission is a technology demonstrator spacecraft for the effectiveness of additive manufacturing using the Windform XT material. Figure 6.13 shows the complete spacecraft (K.M. Dr. David Klumpar 2015) and Figure 6.14 shows the primary printed structure. The spacecraft is equipped with several sensors to investigate the properties of the material during its mission (CRP Technology 2015). PrintSat was unfortunately lost during launch failure in November 2015

and it is unknown whether or not the mission will return.

The Morehead State University's Rapid Prototyped MEMS Propulsion and Radiation Test (RAMPART) spacecraft will also demonstrate the rapidly prototyped Windform material during its mission. The entire structure is made of high phosphorus, electroless nickel-plated material to provide radar reflectivity for tracking purposes. Benefits of the RAMPART propulsion system are the lightweight and specialized cell structures of the propellant tank made from Windform XT. The spacecraft was scheduled for launch in June 2013, but was delayed.

Made in Space

In 2016, Made in Space introduced a permanent manufacturing facility, the Additive Manufacturing Facility (AMF), which provides hardware manufacturing services to NASA and the U.S. National Laboratory onboard the ISS. The AMF is the first commercially available manufacturing service in space, enabling several on-orbit manufacturing capabilities and providing research opportunities for terrestrial and space-based 3D printing applications, such as CubeSats (Made In Space, 2018). The MakerSat mission is a proof-of-concept that will use the AMF to demonstrate additive manufacturing in microgravity, by assembling and deploying a CubeSat from the ISS. MakerSat-0 will monitor characteristics of different plastics in the vacuum of space in preparation for MakerSat-1—a CubeSat to be manufactured entirely on the ISS (Grim, et al., 2016).

6.3 On the Horizon

Tethers Unlimited

In 2017, Tethers Unlimited was awarded a grant through the SBIR (Small Business Innovation Research) to develop the COBRA-Bee carpal-wrist mechanism for NASA'S Astrobee robot. The Astrobee is a small, free-flying robot that will assist astronauts aboard the ISS, and the COBRA-Bee gimbal will enable Astrobee to precisely point and position sensors, grippers, and other tools (NASA 2017). COBRA-Bee will provide this precise multi-purpose pointing and positioning capability in a small-scale, tightly integrated COTS product, with an interface to support third-party sensors, end-effectors, and tools. The Phase I effort will define requirements for a detailed design, based upon a crew safety analysis and a survey of candidate Astrobee end-effectors. A demonstration will be performed with existing COBRA hardware, maturing the COBRA-Bee to TRL 4 (NASA 2017).

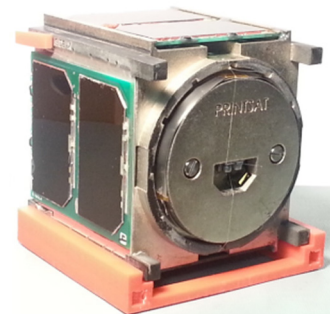

Figure 6.14: Flight configuration of PrintSat. Image Courtesy of Dr. David Klumpar (2015).



RSat-P: Robotic Arms

RSat-P (Repair Satellite-Prototype) is a 3U CubeSat that is part of the Autonomous On-orbit Diagnostic System (AMODS) built by the US Naval Academy Satellite lab to demonstrate capabilities for in-orbit repair systems. RSat-P uses two 60 cm extendable robotic arms with the ability to maneuver around a satellite to provide images and other diagnostic information to a ground team. The first robotic arm prototype was scheduled for a launch in early 2017, but has since been postponed for some time in 2018 (Wenberg, Keegan, Lange, Hanlon, & Kang, 2016).

6.3.1 Radiation Effects and Mitigation Strategies

Shielding from the Space Environment

Shielding the spacecraft is often the simplest method to reduce both a spacecraft's ratio of total ionizing dose to displacement damage dose (TID/DDD) accumulation, and the rate at which SEEs occur if used appropriately. Shielding involves two basic methods: shielding with the spacecraft's pre-existing mass (including the external skin or chassis, which exists in every case whether desired or not), and spot/sector shielding. This type of shielding, known as passive shielding, is only very effective against lower energy radiation, and is best used against high particle flux environments, including the densest portions of the Van Allen belts, the Jovian magnetosphere, and short-lived solar particle events. In some cases, increased shielding is more detrimental than if none was used, owing to the secondary particles generated by highly penetrating energetic particles; therefore it is important to analyze both the thickness and type of materials used, to shield all critical parts of the spacecraft. The final design consideration is due to the strong omnidirectionality of most forms of particle radiation, where spacecraft need to be shielded from the full 4π steradian celestial sphere. This brings the notion of "shielding-per-unit-solid-angle" into the design space, where small holes or gaps in shielding are often only detrimental proportionally to the hole's solid angle as viewed by the concerned EEE component. Essentially, completely enclosing critical components should not be considered a firm design constraint when other structural considerations exist.

Inherent Mass Shielding

Inherent mass shielding consists of using the entirety of the pre-existing spacecraft's mass to shield sensitive electronic components that are not heavily dependent on their location within the spacecraft. This often includes the main spacecraft bus processors, power switches, etc. Again, the notion of "shielding-per-unit-solid-angle" is invoked here, where a component could be well shielded from its "backside" (2π steradian hemisphere) and weakly shielded from the "front" due to its location near the spacecraft surface. It would only then require additional shielding from its front to meet operational requirements. The classic method employed here is to increase the spacecraft's structural skin thickness to account for this additional shielding required. This is the classic method largely due to its simplicity, where merely a thicker extrusion of material is used for construction. The disadvantage to this method is the material used, very often aluminum, is mass optimized for structural and surface charging concerns and not for shielding either protons/ions or electrons. Recent research has gone into optimizing structural materials for both structural and shielding concerns and is currently an active area of NASA's small business innovation research and small business technology transfer investment.

The process to determine exactly how much inherent shielding exists involves using a reverse ray tracing program on the spacecraft solid model from the specific point(s) of interest. After generating the "shielding-per-unit-solid-angle" map of the critical area(s) of the spacecraft, a trade study can be performed on what and where best to involve further additional shielding.



Ad Hoc Shielding

There are two types of ad hoc shielding used on spacecraft: spot shielding, where a single board or component is covered in shield material (often conformally), and sector shielding, where only critical areas of the spacecraft have shielding enhancement. These two methods are often used in concert as necessary to further insulate particularly sensitive components without unnecessarily increasing the overall shield mass and/or volume. Ad hoc shielding is more efficient per unit mass than inherent mass shielding because it can be optimized for the spacecraft's intended radiation environment while loosening the structural constraints. The most recent methods include: multiple layer shields with layer-unique elemental atomic numbers which are layered advantageously (often in a low-high-low Z scheme), known as "graded-Z" shielding, and advanced low-Z polymer or composite mixtures doped with high-Z metallic microparticle powders. Low-Z elements are particularly capable at shielding protons and ions while generating little secondary radiation, where high Z elements scatter electrons and photons much more efficiently. Neutron shielding is a unique problem, where optimal shield materials often depend on the particle energies involved. Commercial options include most notably Tethers Unlimited's VSRS system for small spacecraft, which was specifically designed to be manufactured under a 3D printed fused filament fabrication process for conformal coating applications (a method which optimizes volume and minimizes shield gaps).

References

- 3D Systems Inc. 2015. "*Accura Bluestone Technical Data.*"
- Clyde Space. 2018. "*CS 3U CubeSat Structure.*"
- Complex Systems & Small Satellites. 2018. "*C3S CubeSat Structure.*"
- Composite Technology Development. 2018. "*STELOC Composite Booms.*"
- CRP Technology. 2018. "Vacuum Ultraviolet Light Exposure of Windform SP and Windform LX 3.0." *CRP Technology.*
- . 2015. "Windform XT 2.0 for the PrintSat Mission." *CRP Technology.*
- Endurosat. 2017. "*CubeSat-3u-structure.*" Accessed July 15, 2018. <https://www.endurosat.com/products/CubeSat-3u-structure/>.
- GomSpace. 2018. "*GomSpace's fourth Demonstration Mission is Successfully Launched – intended to Pioneer the Advanced.*" <https://gomspace.com/news/gomspaces-fourth-demonstration-mission-is-suc.aspx>.
- Grim, B., M. Kamstra, A. Ewing, C. Nogales, J. Griffin, and S. Parke. 2016. "MakerSat: A CubeSat Designed for In-Space Assembly." *30th Annual AIAA/USU Conference on Small Satellites*. Logan, UT.
- Honeybee Robotics. 2018. "*CubeSat Solar Array Drive Assembly.*"
- Klumpar, D. 2015. "*PrintSat Spacecraft.*"
- Made In Space. 2018. "*Additive Manufacturing Facility.*"



NanoAvionics. 2018. "*NanoAvionics Structural Components.*"

NASA. 2017. "*COBRA-Bee Carpal-Wrist Gimbal for Astrobee.*" February. Accessed July 18, 2018. <https://www.sbir.gov/sbirsearch/detail/1426639>.

Pumpkin, Inc. 2017. "*CubeSat Kit Structures.*"

Radius Space. 2018. "*Radius Space 1U-3U Structure.*"

Revels, J., M. Lawton, V. Fraux, V. Gurusamy, and V. Parry. 2017. "In-Orbit Performance of AstroTube: AISat Nano's Low Mass Deployable Composite Boom Payload." *31st Annual AIAA/USU Conference of Small Satellites*. Logan, UT.

Stevenson, T., and G. Lightsey. 2016. "Design and Characterization of a 3D Printed Attitude Control Thruster for an Interplanetary 6U CubeSat." *30th Annual AIAA/USU Conference on Small Satellites*.

Tethers Unlimited. 2018. "*KRAKEN Robotic Arm.*" Accessed July 2018. http://www.tethers.com/SpecSheets/Brochure_KRAKEN.pdf.

Tethers Unlimited, Inc. 2018. "*Cobra Gimbal.*"

TiNi Aerospace. 2018. "*Frangibolt Actuator FD04.*"

Wenberg, D. L., B. P. Keegan, M. E. Lange, E. A. S. Hanlon, and J. S. Kang. 2016. "RSat Flight Qualification and Test Results for Manipulable Robotic Appendages Installed on 3U CubeSat Platform." *30th Annual AIAA/USU Conference on Small Satellites*. Logan, UT.



7.0 Thermal

7.1 Introduction

Most spacecraft components have a range of allowable temperatures that must be met for optimal function as well as survival, and these temperatures are regulated throughout a spacecraft by a variety of thermal management techniques. Following the high demand for small spacecraft in the last decade, miniaturized thermal management systems were required to ensure thermal control requirements are met. While traditional thermal control techniques have been demonstrated on larger spacecraft, these existing techniques may require additional development for miniaturization and testing for small spacecraft applications. Larger-scale technologies will still be considered state-of-the-art for the purposes of this review, but may be less than TRL 9 for small spacecraft applications. Table 7-1 is a list of the current state-of-the-art passive thermal techniques applicable for small spacecraft.

The author would like to highlight that the presented tables are not intended to be exhaustive but to provide an overview of current state-of-the-art technologies and their development status for this small spacecraft subsystem. There was no intention of mentioning certain companies and omitting others based on their technologies.

Product	Manufacturer	TRL Status
MLI Materials	Sheldahl, Dunmore, Aerospace, Fabrication and Materials, MLI Concepts Inc.	9
Paint	AZ Technology, MAP, Astral Technology Unlimited, Inc., Dunmore Aerospace	9
Selective Surface and Metallized Tape Coatings	Sheldahl, Dunmore	9
Thermal Gap Fillers and Conductive Gaskets	Bergquist, Parker Chomerics	9
Sun Shields	Sierra Lobo	7
Flexible Thermal Straps	Thermal Management Technologies, Thermacore, Technology Applications, Inc., Thermotive Technology	9 for metal straps, 7 for composite straps
Storage Units	Thermal Management Technologies, Active Space Technologies	8
Thermal Louvers	NASA Goddard Space Flight Center	9
Deployable Radiators	Thermal Management Technologies, Kaneka Corporation/JAXA collaboration	6
Passive Heat Pipe	Thermacore, Inc. and Advanced Cooling Technology, Inc.	7



7.2 State of the Art

7.2.1 Passive Systems

Passive thermal control requires no input power for thermal regulation within a spacecraft. This can be achieved using several methods and is highly advantageous to spacecraft designers, especially for the CubeSat form factor, as passive thermal control systems are associated with low cost, volume, weight and risk, and have been shown to be reliable. The integration of Multi-Layer Insulation (MLI), thermal coatings, heat pipes, sunshades, and louvers are some examples of passive methods to achieve thermal balance in a spacecraft.

Thermally isolated structural joints are often used for thermal management in small spacecraft, where multiple washers with low thermal conductivity are stacked between fasteners and joined surfaces to limit heat transfer via conduction in specific places.

Thermal Insulation and Coating (Films and Coatings)

In vacuum, heat is transferred by two means: radiation and conduction. The internal environment of a fully-enclosed small satellite is usually dominated by conductive heat transfer, while the overall energy balance and outside environment is driven purely via thermal radiation. The thermal radiation environment is manipulated by using materials that have certain specific radiative properties, commonly referred to as solar absorptivity (implying wavelengths in the range of approximately 0.3 to 3 μm), and IR emissivity (approximately 3 to 50 μm). Solar absorptivity governs how much of the impinging solar flux a spacecraft absorbs, while IR emissivity determines how well a spacecraft emits its thermal energy to space, relative to a perfect blackbody emitter. These properties are almost entirely surface properties of a material, and can be modified simply by adding specialized coatings, platings, polishings, or even adhesive tapes of specific materials.

Thermal insulation acts as a thermal radiation barrier from incoming solar flux and also to prevent excessive heat dissipation. Typically used to maintain a temperature range for the electronics and batteries during orbit, or more recently, for biological payloads, thermal insulation is often in the form of MLI blankets, but metallized tapes are becoming increasingly common for small spacecraft applications. MLI is fairly delicate and drops drastically in performance if compressed, so it should be used with caution or avoided altogether on the exterior of small satellites that fit into a deployer (e.g., P-POD, NLAS). MLI blankets can also pose a potential snagging hazard in these tight-fitting pusher-spring style deployers. Additionally, MLI blankets tend to drop efficiency as their size decreases and the specific way they are attached has a large impact on their performance. Due to this, MLI generally does not perform as well for small spacecraft (CubeSat form factor) as on larger spacecraft. Surface coatings are typically less delicate and are more appropriate for the exterior of a small spacecraft that will be deployed from a dispenser. Lastly, internal MLI blankets that do not receive direct solar thermal radiation can often be replaced by a variety of low emissivity tapes or coatings that perform equally well in that context, using less volume and at potentially lower cost. Second-surface silvered FEP tapes offer excellent performance as radiator coatings, rejecting solar heating while simultaneously emitting spacecraft thermal energy efficiently, but the tapes must be handled carefully to maintain optical properties and they don't always bond well to curved surfaces.

Dunmore Aerospace Corporation has produced MLI blankets for small spacecraft missions, and have recent developments on STARcrest SATKIT Spacecraft Materials consisting of DE330, DE076, DM116, and DM100 MLI blankets for CubeSat applications. These materials are constructed from previously flown MLI, but the actual KIT is TRL 6. Dunmore also offers polyimide

film tape and MLI tape designed to insulate wires and cables on a spacecraft or aircraft and has a TRL of 7 for small spacecraft.

The alteration of the solar absorptance and IR emittance of a surface material by applying matte paint is another passive method of thermal control. While black paint will absorb the majority of incident thermal radiation in the solar and IR spectrums, white paint limits how much heat is absorbed from the surrounding solar environment due to its low solar absorption/IR emittance ratio (A. Anvari). Tape is another known useful thermal coating resource; it is easy to both apply and remove, is relatively inexpensive, and has a longer usable lifetime than paint (Soulage).

AZ Technology, MAP, Astral Technology Unlimited, Inc., Lord Techmark, Inc., Sheldahl, and Akzo Nobel Aerospace Coatings manufacture thermal coatings (paint and tape) for aerospace use that has been demonstrated on multiple small spacecraft missions. Some examples of small spacecraft using thermal coatings include Picard (150 kg) which used white SG12FD paint on the Sun pointing face and CubeSat YamSat which had black paint applied inside the spacecraft for temperature maintenance. BioSentinel, a 6U spacecraft in development at NASA Ames Research Center, makes extensive use of metallized tape coatings and second-surface silvered FEP tapes from Sheldahl to control its external thermal radiative environment and overall energy balance (Benton).

Sunshields

The application of a sunshield, or sunshade, is common for spacecraft thermal control, although only recently has this been implemented on small spacecraft to improve thermal performance. Sierra Lobo has developed a deployable sunshield that will be flown on CryoCube-1, estimated to launch in 2019. This sunshield can support a multiple month-long duration lifetime and can provide temperatures below 100 K and below 30 K with additional active cooling (Sierra Lobo). Figure 7.1 displays the design of the sunshield used on CryoCube-1.

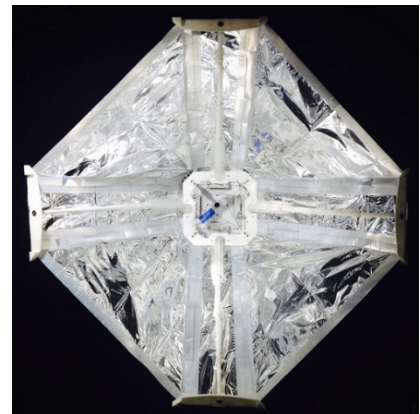

Figure 7.1: End view of Sunshield on CryoCube-1 developed at Sierra Lobo. Image courtesy of Sierra Lobo (2014).

MLI Concepts, Inc. also has extensive expertise in designing and developing stainless steel and titanium heat shields that will not break down due to heat or other stress (MLI Concepts, LLC. 2010), although this technology has only been demonstrated on larger spacecraft.

Thermal Straps

Recently, flexible thermal straps have become a convenient way to control temperature on small spacecraft, as the required mass for the strap is limited with reduced stiffness between components. Flexible thermal straps can be applied to allow for passive heat transfer to a thermal sink and can be fitted to any particular length for design.

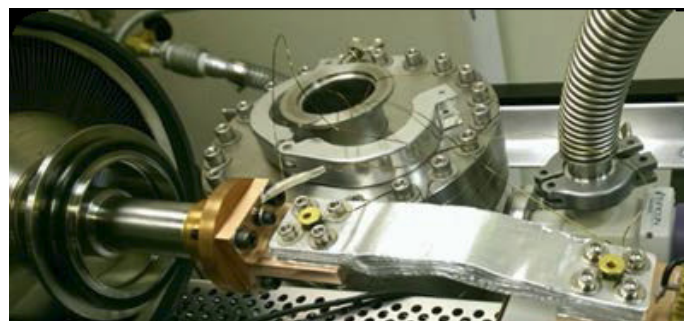

Figure 7.2: Thermal Management Technologies Aluminum thermal strap test. Image Courtesy of Thermal Management Technologies (2015).

Thermal Management Technologies (TMT) has developed standard flexible thermal straps available in thin aluminum

or copper foil layers or a copper braid; custom accommodations can be fabricated and tested for service (Thermal Management Technologies), see Figure 7.2. While these straps have been tested, the status for small spacecraft application is unknown.

Thermal straps are also being manufactured in materials other than the traditional aluminum and copper. Thermacore has designed lightweight thermal k-Core straps use k-Technology in solid conduction to supply a natural conductive path without including structural loads to the system. These have greater conduction efficiency compared to traditional aluminum straps (Thermacore), as the k-Core encapsulated graphite facilitates heat dissipation in high-power electronics. This technology has been fully designed and tested, but the application for small spacecraft is unknown. Therefore, they are TRL 5.

Technology Applications, Inc. has specialized in testing and developing Graphite Fiber Thermal Straps (GFTS), with flight heritage on larger spacecraft missions (Orion and Spice). GFTS (Figure 7.3) are known to be extremely lightweight and highly efficient and thermally conductive with unmatched vibration attenuation (Technology Applications Inc.). While this technology has not been demonstrated or tested on small spacecraft platforms, the capability for small spacecraft applications is still applicable. The TRL for this system is 5.

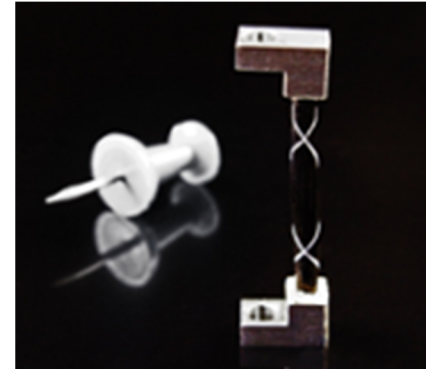

Figure 7.3: Graphite Fiber Thermal Straps (GFTS). Image courtesy of Thermal Management Technologies (2015).

Thermotive Technology developed the Two Arm Flexible Thermal Strap (TAFTS) that is currently flying on JPL's Portable Remote Imaging Spectrometer (PRISM) instrument. Space infrared cameras require extremely flexible direct cooling of mechanically-sensitive focal planes. The design of TAFTS uses three "swaged terminals and a twisted section" that allows for significant enhanced elastic movement and elastic displacements in three planes, while a more conventional strap of the same conductance offers less flexibility and asymmetrical elasticity (E. Urquiza). Infrared cameras have flown on small spacecraft missions, although the TAFTS design has not.

Thermal Louvers

Full-sized louvers for larger spacecraft have high efficacy for thermal control; however, their integration on small spacecraft has been challenging. Typical spacecraft louvers are associated with a larger mass and input power, which are both limited on small spacecraft. Goddard Space Flight Center has developed a passive thermal louver for 6U CubeSats, Dellinger, with a demonstrated thermal dissipation of 14W. This louver design uses bimetallic springs to control the position of the flaps: when temperature of the spacecraft rises, the bimetallic properties of the springs create expansion, opening the louvers and modifying the average emissivity of the exterior surface. Similarly, when the spacecraft cools and the flaps close, the exterior surface returns to the previous emissivity (NASA Goddard Space Flight Center 2014). Figure 7.4 is a representation of the thermal louvers on Dellinger.



Figure 7.4: Passive Thermal Louver on 6U CubeSat Dellinger. Image Courtesy NASA Goddard (2015).

Dellinger was released from the NanoRacks CubeSat Deployer aboard the International Space Station into LEO in 2017, and has operated nominally, making these louvers TRL 9 (NASA, 2017).

Deployable Radiators

Similar to thermal louvers, using deployable radiators on small spacecraft is challenging due to volumetric constraints. Paint has been widely used to create efficient radiator surfaces on larger spacecraft, but the relatively limited available external surface area (particularly on small satellites with body-mounted solar cells) reduces the potential for creating radiative surfaces on small satellites. For a system that requires a large amount of heat dissipation, a passive deployable radiator that is lightweight and simple in design would greatly enhance thermal performance by increasing the available radiative surface area.

Thermal Management Technologies is developing thermally efficient deployable radiators for small spacecraft that integrate an isothermal radiator surface with a high-conductance hinge for higher thermal efficiency (Thermal Management Technologies, 2015). This thermally conductive hinge (Figure 7.5) allows for minimal temperature gradients between the radiator and spacecraft. An illustration of the deployable radiator can be seen in Figure 7.6. The radiating surface uses graphite composite material for mass reduction and increased stiffness, where the typical radiator uniformity is less than $0.1^{\circ}\text{C W}^{-1}\text{m}^{-1}$. This technology is currently in the development and testing phase (Thermal Management Technologies, 2015).

The design of a flexible deployable radiator for small spacecraft was proposed, developed and tested by Shoya Ono and Hosei Nagano and colleagues from Kaneka Corporation and JAXA. This design can deploy or stow the radiation area to control heat dissipation depending on environmental temperatures. It has an overall volume of $0.5 \times 360 \times 560$ mm and 0.287 kg total mass (Figure 7.7). The fin is passively stowed and deployed by an actuator that consists of a shape memory alloy and bias spring.

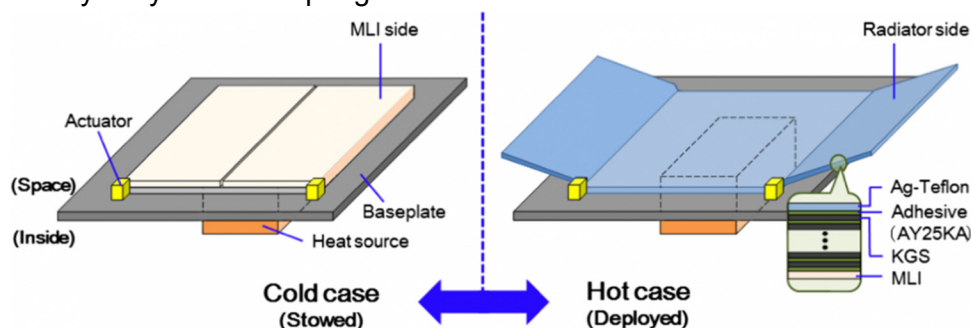

Figure 7.7: Conceptual flexible radiator diagram. Image Courtesy of Ono et al. (2015).



Figure 7.5: TMT Conductive Hinge for Small Satellite Mode. Image Courtesy of Thermal Management Technologies (2015).

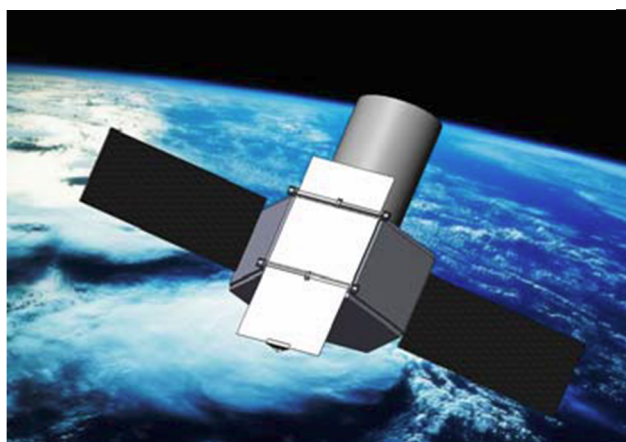

Figure 7.6: TMT Deployable Radiator for Small Satellites. Image Courtesy of Thermal Management Technologies (2015).

To increase radiator size and thermal conductivity, multiple layers of Kaneka Graphite Sheets (KGS) are used for the fin material. The rear surface of the fin is insulated with MLI to reduce the amount of heat dissipation under cold conditions. Deployment and stowage tests were conducted in a thermostatic chamber, and the thermal performance test was conducted under vacuum conditions, where it was shown that the half-scaled radiator dissipated 54 W at 60°C (S. Ono, 2015).

Heat Pipes

Heat pipes are an efficient passive thermal transfer technology, where a closed-loop system transports excess heat via temperature gradients, typically from electrical devices to a colder surface, which is often either a radiator itself, or a heat sink that is thermally coupled to a radiator. Traditional heat pipes are cylindrical in shape, like those used on BIRD (92 kg), but there are also flat plates made of rectangular stainless steel tubing sandwiched between two aluminum plates and charged with a working fluid inside (Nakamura, 2013). SDS-4, a 50 kg small spacecraft, successfully incorporated this flat plate design developed at JAXA (Figure 7.8). Although this technology has been applied on a 50 kg small spacecraft, additional fabrication and testing may be required for CubeSat platform applications. For CubeSat design, the TRL for passive heat pipes are TRL 6.

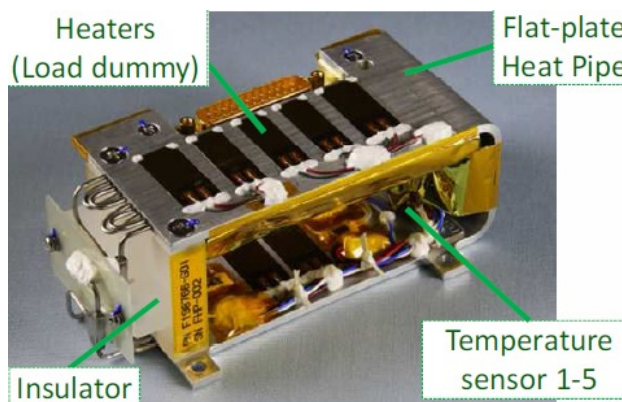

Figure 7.8: FOX flight model heat pipe developed at JAXA. Image courtesy of Nakamura et al (2013).

Storage Units

Thermal storage units can be used in various applications for passively storing thermal energy for component protection or for future energy use. Thermal Management Technologies is developing a phase-changing thermal storage unit (TSU) that considers desired phaseshades-change temperatures, interfaces, temperature stability, stored energy, and heat removal methodologies (Figure 7.9). A complete fabrication of this device will allow the user to control temperature peaks, stable temperatures and/or energy storage (Thermal Management Technologies, 2015). Active Space Technologies also has storage units under development that integrate online design support and high cryogenic enthalpy. The first TMT storage units flew in 2018. The current TRL for these systems is 7.



Figure 7.9: CubeSat Thermal Storage Unit. Image courtesy of Thermal Management Technologies (2015).

7.2.2 Active Systems

Active thermal control methods rely on input power for operation, are associated with higher precision and have been shown to be more effective (Hogstrom, 2013). Typical active thermal devices include electrical resistance heaters, coolers, or the use of cryogenic materials. Until spacecraft designers are able to miniaturize existing actively controlled thermal techniques, the use of active thermal systems in small spacecraft will be limited. Small spacecraft designers are keen to use active thermal systems for temperature sensitive devices (such as batteries, cameras



and electronics). In such cases where a complete passive system is not sufficient for thermal management, electrical resistance heaters and coolers are attached to specific equipment to maintain operational temperatures. For the current state-of-the-art in active thermal technologies applicable on small spacecraft, see Table 7-2.

Products	Manufacturer	TRL Status
Electrical Heaters	Minco Products, Inc., Birk Mfg., and All Flex Flexible Circuits, LLC.	9
Mini Cryocoolers	Ricor-USA, Inc., Creare, Sunpower Inc., Northrop Grumman, NASA Jet Propulsion Lab and Lockheed Martin Space Systems Company	6
Flexible and Enhanced Active Thermal Straps (FEATS)	LoadPath	6

Thermal Straps

Active thermal straps have been shown to increase thermal performance, especially in designs associated with high concentrated heat fluxes on the electronics. The advanced thermally conductive path on the strap supplies a reliable mitigation method for reducing hot spots, while also limiting integration overhead and space. Load Path Aerospace Structures currently have Flexible and Enhanced Active Thermal Straps (FEATS) that are capable of heat dissipation up to 50 Wcm⁻² and a cooling capacity of 35 W (Aerospace Structures Load Path 2015). While these have not yet flown on small spacecraft missions, they have been developed and tested for small spacecraft.

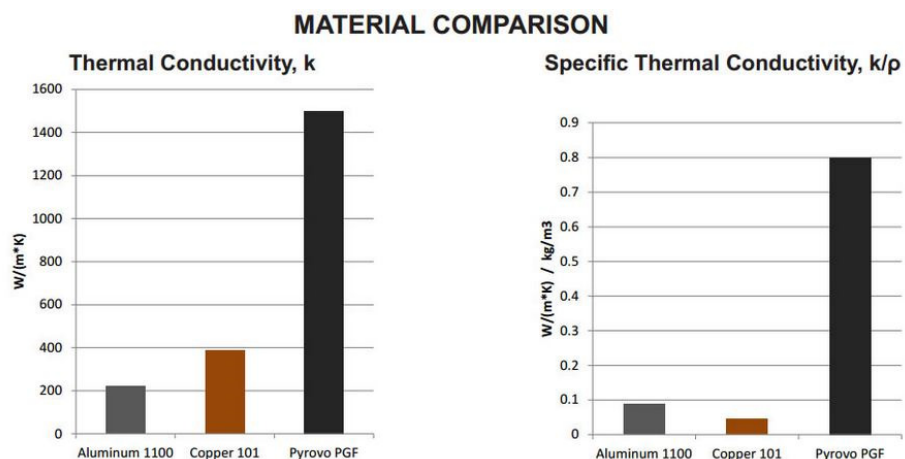

Figure 7.10: Thermotive Pyrovo PGF Material Comparison. Image courtesy of Thermotive (2014).

Thermotive has developed Pyrovo Pyrolytic Graphite Film (Pyrovo PGF) thermal straps that have already flown in optical cooling applications for high altitude cameras and avionics. Pyrovo PGF straps use pyrolytic graphite wrapped in a HEPA filter-vented 4m thick aluminized mylar blanket, and have no exposed graphite. The specific thermal conductivity of this material has been shown to be 10x better than aluminum and 20x better than copper, as seen in Figure 7.10 (Thermotive, 2014). These straps flew on JPL's ASTERIA CubeSat in 2017, and as such their TRL is 9 (Olson, 2016).

Heaters

On small spacecraft, electrical resistance heaters are typically used to maintain battery temperature during cold cycles of the orbit, and are controlled by a thermostat or temperature sensor. 1U CubeSats Compass-1, MASAT-1 and OUTFI-1 required an electrical heater attached to the battery in addition to passive control for the entire spacecraft system to maintain thermal regulation in eclipses (D. Hengeveld, 2010). As biological payloads are becoming more common on small spacecraft, the biology have their own specified temperature maintenance requirements. NASA Ames biological nanosats (GeneSat, PharmaSat, O/OREOS, SporeSat, EcAMSat and BioSentinel) all use actively-controlled resistance heaters for precise temperature maintenance for their biological payloads, with closed-loop temperature feedback to maintain temperatures. Minco Products, Inc., Birk Mfg., and All Flex Flexible Circuits, LLC. manufactures flexible strip heaters equipped with polyimide insulation. These heaters are TRL 9 for small spacecraft missions.

Cryocoolers

There have been recent improvements in cooling technologies for small spacecraft. Cryogenic coolers, or cryocoolers, are used on instruments or subsystems requiring cryogenic cooling, such as high precision IR sensors. The low temperature improves the dynamic range and extends the wavelength coverage. Further, the use of cryocoolers is associated with longer instrument lifetimes, low vibration, high thermodynamic efficiency, low mass, and supply cooling temperatures less than 50 K (R. Hon, 2009). Instruments such as imaging spectrometers, interferometers and MWIR sensors require cryocoolers to function at extremely low temperatures. Cryocube-1 will be the first CubeSat mission to perform cryogenic management tests (fluid location sensing, slosh characterization, and cryogenic fluid transfer) on orbit in 2019. The 3U will carry gas onboard and will be passively cooled and liquefied using a cryotank developed at Sierra Lobo, Inc (Sunpower Inc., 2015).

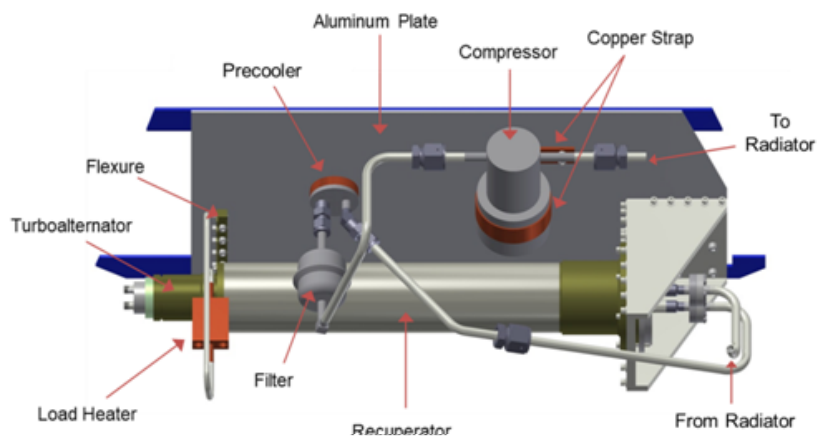

Figure 7.11: Configuration of primary mechanical UPL cryocooler components from Creare. Image courtesy of Creare, Inc. (2015).

Creare developed an Ultra-Low Power (ULP) single-stage, turbo-Brayton cryocooler (Figure 7.11) that operates between a cryogenic heat rejection temperature and the primary load temperature. Components include a cryogenic compressor, a recuperative heat exchanger, and a turboalternator, where the continuous flow nature of the cycle allows the cycle gas to be transported from the compressor outlet to a heat rejection radiator at the warm end of the cryocooler, and from the turboalternator outlet to the object to be cooled at the cold end of the cryocooler (M. V. Zagarola, 2012). This cryocooler is designed to operate at cold end

temperatures of 30 to 70 K, with loads of up to 3 W, and heat rejection temperatures of up to 210 K by changing only the charge pressure and turbo machine operating speeds. This technology has competed testing and fabrication and is TRL 6.

A unique type of cryocooler, a reverse turbo-Brayton cryocooler that produces negligible vibration, is currently being developed at Creare. This technology uses a continuous flow of gas to transport heat from the active elements of the cryocooler to the objects to be cooled and to heat rejection surfaces. Current units that have been demonstrated at a TRL of 5 or higher are: 7 W at 70 K (TRL 9); 5 W at 65 K; 4 W at 35 K; 300 mW at 35 K with a 150 K heat rejection temperature; 2 W at 70 K plus 20 W at 120 K; 300 mW at 10 K plus 2 W at 70 K; and 20 W at 90 K (CREARE 2018).

Ricor-USA, Inc. developed the K562S, a rotary Stirling mini micro-cooler. It has a cooling capacity of 200 mW at 95 K and 300 mW at 110 K and has been used in several small gimbals designed for military applications. Ricor also developed K508N a Stirling ½ W micro cooler that has cooling capacity 500 mW at 77 K and 700 mW at 77 K that is suitable for use on a small spacecraft, see Figure 7.12 and Figure 7.13 for both mini coolers (Ricor-USA Cryogenic and Vacuum Systems, 2015). These coolers are TRL 6 for small spacecraft applications.



Figure 7.12: Ricor-USA K508N 1/2 W Micro Cooler. Image courtesy of Ricor-USA (2015).



Figure 7.13: Ricor-USA K562S Mini-cooler. Image courtesy of Ricor-USA (2015).

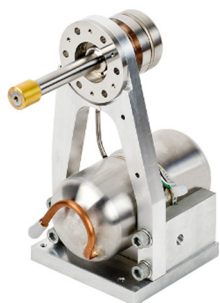

Figure 7.14: CryoTel DS1.5 1.4 W Cryocooler. Image courtesy of Sunpower, Inc. (2015).

Sunpower, Inc. developed the CryoTel DS1.5 Stirling Cryocooler (Figure 7.14) featuring a dual-opposed-piston pressure wave generator and a separate cold head to minimize exported vibration and acoustic noise and has a nominal heat lift of 1.4 W at 77 K using 30 W power with a 1.2 kg mass (Sunpower Inc., 2015). Sunpower also offers MT-F (Figure 7.15), a mini-cooler that has a nominal heat lift of 5 W at 77 K, using 80 W power with a total mass of 2.1 kg. While the MT-F technology has been successfully demonstrated in applications such as High Temperature Superconductivity (HTS) filters, high altitude balloons, refrigeration, germanium detectors, IR detectors, radio telescopes and laser diode cooling, it has not been applied to a small spacecraft mission.



Figure 7.15: CryoTel MT-F 5 W Cryocooler. Image courtesy of Sunpower, Inc. (2015).

Northrop Grumman designed a Micro Pulse Tube cooler which is a split configuration cooler that incorporates a coaxial cold head connected via a transfer line to a vibrationally balanced linear compressor (Figure 7.16). This micro compressor has been scaled from a flight proven TRL 9 high efficiency cooler (HEC) compressor. The cooler has an operational range of 35 to 40 K and a heat rejection temperature of 300 K, using 80 W of input power, has 750 mW refrigeration at 40 K, and a total mass of 7.4 kg (D. Durand, 2014).

Lockheed Martin Space Systems Company engineered a pulse tube micro-cryocooler (Figure 7.17), a simplified version of a Stirling cryocooler, consisting of a compressor driving a coaxial pulse tube coldhead. The unit has a mass of 0.345 kg for the entire thermal mechanical unit, and is compact enough to be packaged in a ½U CubeSat (Nast, 2013). The microcooler design underwent qualification testing at TRL 6 and is compatible for small spacecraft missions.

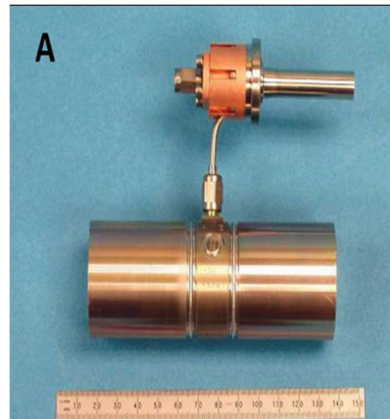

Figure 7.16: Flight design PT microcooler and its flight configuration with attached reservoir tank. Image Courtesy of Northrop Grumman (2015).



Figure 7.17: Lockheed Martin TRL6 Microcryocooler. Cryocooler photograph provided courtesy of Lockheed Martin Corporation.

Thales Cryogenics has also developed a Linear Pulse Tube (LPT) cryocooler that has gone through extensive testing by NASA JPL. The Thales LPT9510 cryocooler has an operating temperature range of -40/71 °C, an input power of <85 watts and a total unit mass of 2.1 kg. The unit has no flight heritage but has gone through extensive testing and has a TRL of 6 (Thales Cryogenics, 2018).

7.3 On the Horizon

Traditional thermal control technologies are not always able to be integrated immediately into small spacecraft platforms. As mentioned in the introduction of this chapter, the technology that is demonstrated on larger spacecraft may need to be altered slightly for small spacecraft compatibility, and will not automatically be assessed at TRL 9. This section discusses some technology being proposed and developed for small spacecraft thermal control which is not ready for space flight.

7.3.1 Deployable Radiators

Thermotive is researching the Folding Elastic Thermal Surface (FETS), a deployable passive radiator for hosted payload instruments and CubeSats. Originally conceived as a thermal shield and cover for a passive cooler (cryogenic radiator) on JPL's MATMOS mission, this proposed concept is being modified as a deployable radiator for small spacecraft and has TRL 4/5 (Thermotive, 2014).

7.3.2 Fluid Loops

A pumped fluid loop is capable of achieving heat transfer between multiple locations via forced fluid convective cooling. Mechanically pumped fluid loops are not of interest to small spacecraft engineers as they are associated with high power consumption and mass. Lockheed Martin Corporation is developing a circulator pump for a closed cycle Joule Thomson cryocooler (Figure 7.18). With an overall mass of 0.2 kg, it can circulate gas as part of a single-phase or two-phase thermal management system using 1.2 W of electrical power and can manage around 40 W of spacecraft power as a single-phase loop, or several hundred Watts of spacecraft power as part

of a 2-phase loop (Champagne, 2015). The compressor went through applicable testing with a compression efficiency of 20-30% in a 2016 study (Thermal Management Technologies, 2015). This design is TRL 4.

7.4 Summary

As thermal management on small spacecraft is limited by mass, volume and power constraints, traditional passive technologies, such as MLI, paints, coatings and metallic thermal straps, still dominate thermal design. Active technologies, such as thin flexible resistance heaters have also seen significant use in small spacecraft, including some with advanced closed-loop control. Technologies that have to date only been integrated on larger spacecraft are being examined, designed and tested for small spacecraft. Passive louvers that have successfully flown on 6U Dillenger are paving the way for thermal deployable components, while deployable radiators and various types of composite thermal straps are still undergoing testing for small spacecraft.

Technology in active thermal control systems has started expanding to accommodate volume and power restrictions of a smaller spacecraft; cryocoolers are being designed to fit within 0.5U volume that will allow small spacecraft to use optical sensors and imaging spectrometers. Thermal storage units are being developed that will better control heat dissipation, in addition to storing energy for future use.

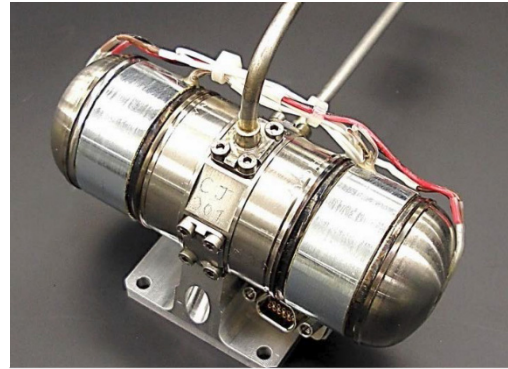

Figure 7.18: JT Compressor. Compressor photograph provided courtesy of Lockheed Martin Corporation.

References

- Aerospace Structures Load Path. 2015. *"Flexible and Enhanced Active Thermal Straps (FEATS)."*
- L. L. C. MLI Concepts. 2010. *"Products: Multi-Layer Insulation (MLI)."*
- A. Anvari, F. F. 2009. *"Comparative Study on Space Qualified Paints Used for Thermal Control of a Small Satellite."*
- Benton, J. 2018. Personal Correspondence.
- Champagne, P. 2015. *"Development of a J-T Micro Compressor."*
- D. Durand, E. T. 2014. *"Efficient High Capacity Space Microcooler."*
- D. Hengeveld, J. B. 2010. *"Review of Modern Spacecraft Thermal Control Technologies and Their Application to Next-Generation Buildings."*
- Dunmore Aerospace Corporation. 2015. *"Multi Layer Insulation Films."* Retrieved from Dunmore.com.
- E. Urquiza, C. V. 2012. *"Development and Testing of an Innovative Two-arm Focal-plane Thermal Strap (TAFTS)."*



- Hogstrom, K. 2013. *"State-of-the-Art Thermal Analysis Methods and Validations for Small Spacecraft."*
- M. V. Zagarola, R. W. 2012. *"Ultra Low Power Cryo-refrigerator for Space Applications."*
- Nakamura, Y. 2013. *"Small Demonstration Satellite-4 (SDS-4): Development, Flight Results, and Lessons Learned in JAXA's Microsatellite Project."*
- NASA. 2017. *"NASA Begins Checkout of Dellingr Spacecraft Designed to Improve Robustness of CubeSat Platforms."*
- NASA Goddard Space Flight Center. 2014. *Dellingr.*
- Nast, J. O. 2013. *"Lockheed Martin Microcryocooler."*
- Olson, J. 2016. *"JT Micro Compressor Test Results."*
- R. Hon, C. K. 2009. *"Integrated Testing of a Complete Low Cost Space Cryocooler System."*
- Ricor-USA Cryogenic and Vacuum Systems. 2015. *"K562S Integral Stirling Low Power Mini Microcooler and K508N Highly Reliable Integral Stirling 1/2W Micro Cooler."*
- S. Ono, H. N. 2015. *"Thermophysical Properties of a High-thermal-conductive Graphite Sheet and Application to a Deployable/Stowable Radiator."*
- Sierra Lobo. 2014. *"CryoCube-1."*
- Soulage, M. 2013. Personal Correspondence.
- Sunpower Inc. 2015. *"CryoTel® DS 1.5."*
- Technology Applications Inc. 2015. *"Graphite Fiber Thermal Straps (GFTS)."*
- Thales Cryogenics. 2018. *"LPT9510 1400 mW / 18 mm slip-on."*
- Thermacore. 2015. *"Thermal Straps: Efficient Cooling without Structural Loading."*
- Thermal Management Technologies. 2015. *"Flexible Thermal Straps."*
- Thermal Management Technologies. 2015. *"Isothermal, Compact, Energy Dense Phasechange Thermal Storage Units for Thermal Management."*
- Thermal Management Technologies. 2015. *"Thermally Efficient Deployable Radiators."*
- Thermotive. 2014. *"Products."*



8. Command and Data Handling

8.1 Introduction

There are two primary trends in small spacecraft command and data handling (C&DH). Incorporating small spacecraft, especially CubeSats, into more complex science and technology applications in LEO and deep space or interplanetary missions, requires increased system reliability and performance. In the case of the smaller spacecraft, these objectives are complicated by the use of highly integrated systems and the need for power and mass efficiency.

At the other end of the spectrum, low-cost, easy-to-develop systems that take advantage of open source software and hardware are providing an easy entry into space systems development, especially for hobbyists or those who lack specific spacecraft expertise.

The author would like to highlight that the presented tables are not intended to be exhaustive but to provide an overview of current state-of-the-art technologies and their development status for this small spacecraft subsystem. There was no intention of mentioning certain companies and omitting others based on their technologies.

8.2 State of the Art

Since the publication of the first edition of this report, several CubeSats using commercial-off-the-shelf (COTS) components and integrated systems have successfully flown in the LEO environment, over short mission durations of typically less than one year.

A variety of C&DH developments for CubeSats have resulted from in-house development, from new companies that specialize in CubeSat avionics, and from established companies who provide spacecraft avionics for the space industry in general. Presently there are a number of commercial vendors who offer highly integrated systems that contain the on-board computer, memory, electrical power system (EPS), and the ability to support a variety of input & output (I/O) for the CubeSat class of small spacecraft.

In anticipation of extended durations in LEO and deep space missions, vendors are incorporating radiation hardened or radiation tolerant designs in their CubeSat avionics packages.

8.2.1 Form Factor

The CompactPCI and PC/104 form factors continue to be the industry standard electronics bus systems with multiple vendors offering components that can be readily integrated into space rated systems. Overall form factors should fit within the standard CubeSat dimension of less than 10 x 10 cm.

The PC/104 board dimension continues to be the baseline for CubeSat configurations. Many vendors have adopted the use of stackable “daughter” or “mezzanine” boards in order to simplify connections between subsystem elements and payloads, as well as to accommodate advances in technologies that maintain compatibility with existing designs. A few vendors provide a modular package which allows users to select from a variety of computational processors.

8.2.2 On-Board Computing

Microcontrollers and FPGAs

Small spacecraft, and especially CubeSat developers, continue to use microcontrollers and field programmable gate arrays (FPGAs) to support a variety of different processor cores. FPGAs have space heritage and integrate easily with peripherals, on-chip memories and improved power



performance--all factors that influence the choice of on-board computing at present. See Table 8-1 for the current state-of-the-art for highly integrated on-board computing systems for small spacecraft.

Table 8-1: Sample of Highly Integrated On-board Computing Systems			
Product	Manufacturer	Processor	TRL Status
Nanomind A712D	GomSpace	ARM7	9
ISIS OBC	ISIS	ARM9	9
Pluggable Socketed Processor Module	Pumpkin	C8051F120, PIC24F256110, PIC24F256GB210, MSP430F1612, MSP430F1611, MSP4302618	9
MODAS	Utah State University	TI320C6713DSP	9
RAD750	BAE		9
Intrepid	Tyvak	ATMEL AT91SAM9G20	9
Q5, Q6, Q7	Xiphos	PowerPC 405, Xilinx Spartan-6, Actel ProASIC3 Control FPGA , Xilinx Zynq 7020 ARM dual core Cortex A9, Actel ProASIC3 Control FPGA	9
ArduSat	NanoSatisfi	ATMEL ATmega328P	9
Medusa, HPD, RCC5, Athena-2 SBC, FMC Gen2/3, AIP	SEAKR	2450 DMIPS, PowerPC e500 core, Xilinx Virtex 5 FPGA, Virtex-5 FX-130T FPGAs, CCSDS, Leon Processor card, RCC4-LX160 & RCC4-LX200	9

Many power efficient microcontrollers used in CubeSats feature ARM processors and a variety of on-chip peripherals, such as universal serial buses (USB), controller area networks (CAN), as well as I2C interfaces and serial peripheral interfaces (SPI). There has also been an increase in the number of microcontrollers that use programmable flash memory.

System developers are gravitating towards ready-to-use hardware and software development platforms that can provide seamless migration to higher performance architectures. As with non-space applications, there is a reluctance to change controller architectures due to the cost of retraining and code migration. Following the lead of microcontrollers and FPGA vendors, CubeSat avionics providers are working towards providing simplified tool sets and cost effective basic evaluation boards.



Smartphone-based Processing

NASA's PhoneSat-1.0 and SSTL's STRAND-1 flew CubeSats that used Google Nexus One smartphones as the central processor, further demonstrating COTS hardware. Smartphones exploit a large market with a fast design cycle, and incorporate several key features that are used in spacecraft, such as cameras, radio links, accelerometers and high-performance computer processors. The smartphone cores used on those early spacecraft were based upon the Qualcomm Snapdragon system on chip (SoC) with a 1 GHz Scorpion processor running the Android operating system. Phonesat-1.0 simply flew the phone in a CubeSat chassis along with a battery pack for power and a UHF beacon radio.

The hobbyist market that has subsequently emerged from smartphone app development experienced the same I/O bottlenecks and mounting problems observed by these smartphone spacecraft. Consequently, a range of low-power microprocessors are now available, although these are still based on ARM and often run Android, but provide better modularity. No smartphone-based CubeSat avionics kits are commercially available at this time.

Open Source Platforms

A number of open source hardware platforms hold promise for small spacecraft systems. Arduino boards consist of a microcontroller with complementary hardware circuits, called shields. The Arduino platform uses Atmel microcontrollers, therefore developers can exploit Atmel's development environment to write software. The ArduSat spacecraft used the Arduino platform and successfully engaged the public to raise funding on Kickstarter. BeagleBone has also emerged as a popular open source hardware platform. BeagleBone contains an ARM processor and supports OpenCV, a powerful open source machine vision software tool that could be used for imaging applications. BeagleSat is an open source CubeSat platform based on the BeagleBone embedded development board. It provides a framework and tool set for designing a CubeSat from the ground up, while expanding the CubeSat community and bringing space to a broader audience. Raspberry Pi is another high-performance open source hardware platform capable of handling imaging, and potentially, high-speed communication applications (Wooster, Boswell, Stakem, & Cowan-Sharp, 2007).

Finally, Intel has entered the market with their Edison system. The dual-core x86-64 SoC was targeted at "Internet of Things" applications, but the Edison has proven to be very well suited for advanced CubeSat development--a novel use that Intel has embraced.

Arduino has become known for being beginner friendly, and making the world of microcontrollers more approachable for software designers. Though it presents a relatively familiar set of API to developers, it does not run its own operating system. On the other hand, the BeagleBone Black, Raspberry Pi, and Intel Edison are full-featured embedded Linux systems running Angstrom, Raspbian, and Yocto Linux kernels out of the box respectively. This broadens the range of developer tool options, from web-based interfaces to Android and Python environments. Not only does this further ease the learning curve for novice developers, but it allows the full power of a Linux system to be harnessed in computation tasks.

8.2.3 Memory and Electronic Components

The range of on-board memory for small spacecraft is wide, typically starting around 32 kB and increasing with available technology. For C&DH functions, on board memory requires high reliability. A variety of different memory technologies have been developed for specific traits, including static random access memory (SRAM), dynamic RAM (DRAM), flash memory (a type of electrically erasable, programmable, read-only memory), magnetoresistive RAM (MRAM),



ferro-electric RAM (FERAM), chalcogenide RAM (CRAM) and phase change memory (PCM). SRAM is typically used due to price and availability. A chart comparing the various memory types and their performance is shown in Table 8-2.

Feature	SRAM	DRAM	Flash	MRAM	FERAM	CRAM/ PCM
Non-volatile	No	No	Yes	Yes	Yes	Yes
Operating Voltage, $\pm 10\%$	3.3 – 5 V	3.3 V	3.3 & 5 V	3.3 V	3.3 V	3.3 V
Organization (bits/die)	512k x 8	16M x 8	16M x 8; 32M x 8	128k x 8	16k x 8	
Data Retention (@ 70°C)	N/A	N/A	10 years	10 years	10 years	10 years
Endurance (Erase/Write cycles)	Unlimited	Unlimited	10 ⁶	1013	1013	1013
Access Time	10 ns	25 ns	50 ns after page ready; 200 s write; 2 ms erase	300 ns	300 ns	100 ns
Radiation (TID)	1 Mrad	50 krad	30 krad	1 Mrad	1 Mrad	1 Mrad
SEU rate (relative)	Low-nil	High	Nil (cells); Low (device electronics)	Nil	Nil	Nil
Temperature Range	Mil-std	Industrial	Commercial	Mil-std	Mil-std	Mil-std
Power	500 mW	300 mW	30 mW	900 mW	270 mW	
Package	4 MB	128 MB	128 – 256 MB	1 MB	1.5 MB (12 chip package)	

There are many manufacturers that provide a variety of electronic components that have high reliability and are space rated (see Table 8-3). A visit to any of their respective websites will show their range of components and subsystems including processors, FPGAs, SRAM, MRAM, bus interfaces, application specific integrated circuits (ASICs), and low voltage differential signaling (LVDS).

ATMEL	Honeywell	STMicroelectronics
BAE Systems	Intel	Texas Instruments
Broadreach	Intersil	3D Plus



C-MAC Microtechnology	Maxwell Technologies	Xilinx
Cobham (Aeroflex)	Microsemi (Actel)	Arduino
Freescale	Space Micro, Inc.	BeagleBone
ÅAC Microtech	SEAKR	VORAGO Technologies

8.2.4 Bus Electrical Interfaces and I/O

CubeSat class spacecraft continue to use interfaces that are common in the microcontroller or embedded systems world. Highly integrated systems, especially SoC, FPGA and ASICs, will typically provide several interfaces to accommodate a wide range of users and to ease the task of interfacing with peripheral devices and other controllers. Some of the most common interfaces are listed below with a brief description:

- Serial Communication Interfaces (SCI): RS-232, RS-422, RS-485 etc.
- Synchronous Serial Communication Interface: I2C, SPI, SSC and ESSI (Enhanced Synchronous Serial Interface).
- Universal Serial Bus (USB).
- Multi Media Cards (SD Cards, Compact Flash etc.).
- Networks: Ethernet, LonWorks, etc.
- Fieldbuses: CAN-Bus, LIN-Bus, PROFIBUS, etc.
- Timers: PLL(s), Capture/Compare and Time Processing Units.
- Discrete IO: General Purpose Input/Output (GPIO).
- Analog to Digital/Digital to Analog (ADC/DAC).
- Debugging: JTAG, ISP, ICSP, BDM Port, BITP, and DB9 ports.
- SpaceWire: a standard for high-speed serial links and networks.

8.2.5 Electronic Power Supplies

A number of developers still design their EPS in-house. This is usually the case when the payload has power control needs and requirements that cannot be met by commercially available suppliers. As the EPS is a critical system for the spacecraft, developers will typically use high reliability or space rated components.

There are several commercially available EPS for the CubeSat platform. These systems provide voltages and regulation typically used in embedded systems such as 3.3 V and 5 V.

These systems also provide an array of features to address end user needs, such as short circuit protection, over current and over/under voltage protection, telemetry, battery charging and monitoring, reset capability and more depending upon the vendor. Many of these systems have flight heritage and are therefore greater than TRL 6. Please refer to the "Power" section for power supplies for small spacecraft.

8.3 On the Horizon

Many C&DH systems will continue to follow trends set for embedded systems. Short duration missions in LEO will continue to take advantage of advances made by industry leaders who provide embedded systems, technologies, and components. In keeping with the low-cost, rapid



development theme of the CubeSat-based missions, many COTS solutions are available for spacecraft developers.

Radiation mitigation solutions are being implemented by developers who need to address those concerns for deep space and long duration LEO missions. A brief discussion about those techniques is provided in the "Radiation" subsection below.

Also trending in the CubeSat development arena is the use of open source solutions. A number of C&DH systems being developed are using Linux as their OS. This allows them to take advantage of open source software that has already been developed and tested (Wooster, Boswell, Stakem, & Cowan-Sharp, 2007). NASA has developed open source software to support a number of missions. Others developers are using the open source in its truest sense, providing software libraries and on-line tools to aid in the development of their space systems. A brief discussion on open source is provided in Fitzsimmons, 2012.

8.3.1 Radiation Mitigation and Tolerance Schemes

Deep space and long duration LEO missions will require developers to incorporate radiation mitigation strategies into their respective designs. The CubeSat platform has traditionally used readily available COTS components. Use of COTS parts has allowed for low-cost C&DH development, while also allowing developers to take advantage of state-of-the-art technologies in their designs. Many of the component and system vendors also provide radiation hardened (rad-hard) equivalent devices as well. While there are many commercially available rad-hard components, using these components impacts the overall cost of spacecraft development. In order to keep costs as reasonable as possible, C&DH developers will need to address appropriate use of rad-hard components, along with other radiation mitigation techniques for developing an overall radiation tolerant design as discussed in the following section.

For space applications, radiation can damage electronics in two ways. Total ionizing dose (TID) is the amount of cumulative radiation received. Single event effects (SEE) is the disturbance created by single particles hitting the electronics (Nguyen, 2015). Total dose is measured in krad and can affect transistor performance. Single event upsets (SEU) can affect the logic state of memory. A single event latchup (SEL) can affect the output transistors on CMOS logic, potentially causing a high-current state. This section summarizes techniques used to mitigate system failures caused by radiation effects.

8.3.2 Component Selection

MEMORY

FRAM (Ferroelectric RAM) is a non-volatile random access memory that is persistent like Flash memory. FRAM memory cells are latched using a PZT film structure which is more likely to maintain state during a single event effect than traditional capacitive latches found in RAM (Ball Aerospace & Technologies Corp, 2015), (Henkel, 1996).

IMAGING

Charge couple devices (CCD) and complementary metal oxide semiconductors (CMOS) are image sensors that are useful in radiation environments. However, CCD's are preferred in space applications, while the CMOS detectors are a newer technology for rad hardened image sensors (NASA Goddard Space Flight Center, 2015; Bardoux, Penquer, Gilard, Ecoffet, & Auvergne, 2012; Chapman, 2015; Holbert, 2015).



8.3.3 Protection Circuits

WATCHDOG TIMERS

Watchdog timers are often used to monitor the state of a processor. A watchdog timer is a hardware circuit, external or internal to the processor, which resets the processor when it expires unless refreshed by the processor. If the processor jumps to an erroneous memory location through a single-event upset or a software exception, the watchdog timer resets the processor to restore operations (Mauere, Fraeman, Martin, & D. Roth, 2008).

COMMUNICATION WATCHDOG TIMER

A dedicated communication watchdog timer circuit can monitor command and responses to determine if the system is locked up. Such a circuit resets power after a specific number of failed transmissions.

OVERCURRENT PROTECTION

Single event latchup (SEL) can cause device failure due to an elevated current state. Hardware and software overcurrent protection can be implemented to watch for elevated current levels and then issue a power reset to the offending circuit. The sampling frequency for software overcurrent protection must be sufficient to detect and reset the subsystem before the elevated current causes permanent damage. For hardware protection, a shunt resistor and bypass diode can be used in conjunction to filter voltage and current spikes for rad hardened devices.

POWER CONTROL

Since many components are more prone to radiation effects when powered on, a candidate mitigation strategy is to power off devices when they are not operationally needed.

8.3.4 Memory Protection

ECC MEMORY

Error-correcting code memory is capable of detecting and correcting bit errors in RAM and FLASH memory. In general, ECC works by storing a checksum for a portion of the memory. This checksum can be used to simply mark a portion of memory unusable and/or correct single-bit errors. The memory controller is responsible for managing the ECC memory during read and write operations (LaBel & al., 1996).

SOFTWARE EDAC

Bit errors can be detected and corrected using software. In general, EDAC algorithms use three copies of the memory to detect and correct bit discrepancies. Software routinely “scrubs” the memory, compares each of the three stored memory values, selects the majority value, and corrects the erroneous memory location. Software EDAC can be performed at the bit or byte level. Memory lifetime needs to be considered for software EDAC implementations, since every correction increases the write count to a memory location.

8.3.5 Communication Protection

SHARED BUS SWITCHING

Another option is to decouple the clock and data lines so that each peripheral has its own pair. Additional data lines can be used on the master controller. Alternatively, an external FPGA could be used to assign a unique clock/data pair to each peripheral and, optionally, include a method as a way to reconfigure those assignments in flight.



CRC

Cyclic redundancy check (CRC) is a common method for detecting memory or communication errors. Parity is a single-bit implementation of a CRC where the bit of summary information is calculated by the XOR of the data to be communicated or stored to memory. For communication channels, a CRC is calculated prior to sending the message, and is appended to the message stream in a known location. When the message is received the CRC is calculated again and compared to the previously-generated CRC appended to the data stream. For memory, the CRC is calculated prior to writing the data to memory. When the data is read out, a new CRC is calculated and compared to the previously generated CRC. CRC's help detect data corruption but cannot be used to correct the defective data.

FORWARD ERROR CORRECTION

Forward Error Correction (FEC) transmits redundant data to help the receiver recover corrupted data. In its simplest form, FEC could transmit three bits for every bit of data and then vote to restore the original data. More efficient algorithms balance the data overhead with the correction accuracy (Mauere, Fraeman, Martin, & D. Roth, 2008).

8.3.6 Parallel Processing and Voting

TRIPLE MODULAR REDUNDANCY

Single-event upsets can interrupt discrete logic, including processing. Triple modular redundancy (TMR) is a fault mitigation technique where logic is replicated three times, and the output of the logic is determined by a majority-vote.

FIRMWARE PROTECTION

Many spacecraft subsystems include a processor to handle and optimize operations. These processors require firmware which is written into onboard program memory. Like data memory, program memory is also susceptible to single-event upsets and device failure. To counter this issue, a bootloader may be used to check the validity of the firmware and provide a mechanism for uploading new versions. Additionally, multiple copies of the firmware may be stored in memory in case the primary version is corrupt.

8.3.7 Open Source Spacecraft Software

Open Source software offers spacecraft developers a way to accelerate software development, improve quality, and leverage lessons learned from prior missions.

cFS/cFE

The core Flight System (cFS) and core Executive (cFE) is a set of applications, application framework and runtime environment developed by Goddard Space Flight Center. cFE includes core services like messaging, timekeeping, events, and table-driven commanding and configuration (Fitzsimmons, 2012; NASA Goddard Space Flight Center, 2015).

COSMOS

COSMOS is a tool developed by Ball Aerospace that provides a framework for operating and testing an embedded system. The tool includes modules for telemetry display, plotting, scripting, logging, and configuration table management (Ball Aerospace & Technologies Corp, 2015).

Linux

Linux is currently supported by several spacecraft avionics providers including Space Micro and Tyvak. Additional software modules are needed for space applications. Such modules may



include memory scrubbing, a safe mode controller, watchdog functionality, and other reliability services (NASA Goddard Space Flight Center, 2015).

8.4 Summary

System level solutions are in demand and a majority of the small spacecraft bus developers use hardware typically employed in the embedded systems and control world. As a result, there are many sources for CubeSat systems, subsystems and components from vendors who provide complete spacecraft bus avionics solutions, which include on-board computing, memory, electronic power supply, and engineering development systems. As CubeSat development and application continues to evolve, there are a wide range of avionics systems and components available to address the needs of the wide range of professional and amateur small spacecraft developers.

Designing and fabricating avionics systems for harsh radiation environments is mitigated by a combination of shielding, derating and controlling operating conditions for cumulative ionization and displacement damage effects that cause gradual degradation in electronic devices. Small spacecraft, especially in the CubeSat class, will need to address impacts of radiation in deep space missions and extended duration missions in LEO. Several processor manufacturers and board level integrators are addressing the need for radiation hardened and radiation tolerant designs. Some board level integrators have also undertaken radiation testing of their integrated systems. Many integrated systems providers, are using radiation hardened processors or FPGAs from manufacturers such as XILINX, ATMEL, Aeroflex.

Open source software and hardware hold a lot of promise for commercial and government spacecraft developers. Making a project open source is the first step. The next step is to socialize the software and encourage developers to not only use, but to contribute back with flight-proven algorithms, software modules, and hardware components.

CubeSats are playing a large role in rapidly developed low-cost missions in space, as they are establishing technology demonstrations and short duration science missions in LEO. NASA and other space agencies are now exploring their application in deep space missions. The CubeSat community will provide innovative solutions to address the reliability requirements necessary for those missions, while attempting to maintain the low-cost approach associated with the platform. Complete avionics packages are available to those who seek an integrated solution. At the other extreme, open source DIY kits are available to those who seek a low-cost way to explore developing their own C&DH system and spacecraft.

References

- Ball Aerospace & Technologies Corp. 2015. "The User Interface for Command and Control of Embedded Systems."
- Bardoux, A., Penquer, A., Gilard, O., Ecoffet, R., & Auvergne, M. 2012. "Radiation Effects on Image Sensors." *International Conference on Space Optics*.
- Chapman, T. 2015. "Radiation Tolerances."
- Fitzsimmons, S. 2012. "Open-source Software for CubeSat Satellites." *AIAA/USU Conference on Small Satellites*.
- Henkel, H. 1996. "Total Dose Radiation Tests at FRAM Non-Volatile Memories."



Holbert, K. E. 2015. "Single Effect Events."

LaBel, K. A., et. al. 1996. "Commercial Microelectronics Technologies for Applications in the Satellite radiation Environment." *Aerospace Applications Conference*.

Mauere, R., Fraeman, M., Martin, M., & D. Roth. 2008. "Harsh Environments: Space Radiation Environment, Effects, and Migitation." Vol. 28, no. 1.

NASA Goddard Space Flight Center. 2015. "Core Flight Software System."

NASA Goddard Space Flight Center. 2015. "GSFC Open Source Software."

Nguyen, M. 2015. "FPGA Advances Improve Radiation Mitigation for Remote-Sensing Satellites." Vol. 17, no. 8.

Wooster, P., Boswell, D., Stakem, P., & Cowan-Sharp, J. 2007. "Open Source Software for Small Satellites." In Proceedings of the *AIAA/USU Conference on Small Satellites*; no. SSC07-XII-3.



9.0 Communications

9.1 Introduction

The communication system is an essential part of a spacecraft, enabling spacecraft to transmit data and telemetry to Earth, receive commands from Earth, and relay information to one another. A device that both receives and transmits is called a transceiver. In contrast, a transponder essentially uses the same technology as a transceiver, but is also capable of providing ranging information, either between spacecraft or with respect to Earth. Spacecraft-to-spacecraft communications is sometimes referred to as an InterSatellite Link (ISL). Traditionally, communication between Earth and spacecraft is based in the radio spectrum (from about 30 MHz to 40 GHz). The different communication bands that are typically used for spacecraft include (IEEE, 2009):

- Very High Frequency (VHF): 30 to 300 MHz
- Ultra High Frequency (UHF): 300 MHz to 3 GHz
- L band: 1 to 2 GHz
- S band: 2 to 4 GHz
- C band: 4 to 8 GHz
- X band: 8 to 12 GHz
- Ku band: 12 to 18 GHz
- K band: 18 to 27 GHz
- Ka band: 27 to 40 GHz
- Optical (Laser Communication): 100 to 800 THz

The radio spectrum used for spacecraft communications is also shown graphically in Figure 9.1.

ITU (International Telecommunication Union) radio bands:

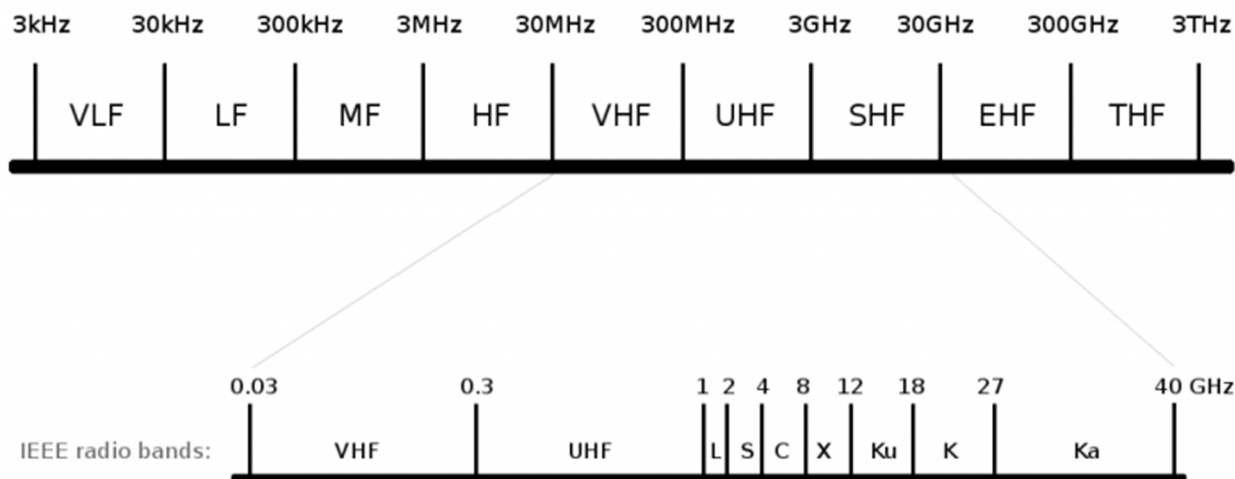

Figure 9.1: Radio spectrum used for spacecraft communication.

While the use of radio frequency (RF) for communications is still the state-of-the-art at the time of this publication, advances have been made in recent years towards using higher carrier frequencies (which generally results in higher data rates), up into the X- through Ka-bands. Higher

data rates are more readily achievable with higher frequencies because data rate is proportional to bandwidth used for communication, and bandwidth is more readily available in the higher frequencies. There is currently significant crowding of the lower RF frequencies, especially in S-band from cell phones (Wertz, Everett, & Puschell, 2015).

Received signal power will decrease as the transmission distance gets larger, thus larger spacecraft on deep space missions almost always use dish antennas because of their ability to focus radio transmissions into a precise directional beam. Thus spacecraft must be able to point accurately. The large physical size and high pointing requirements of a parabolic dish antenna make such an antenna difficult to integrate with a CubeSat. Developers have sought alternatives, especially as the attitude determination and control of CubeSats gets better (refer to GNC Chapter). For example, an inflatable dish antenna is one proposed solution (Alessanda Babuscia, 2013).

Thus far, CubeSats have not operated beyond LEO, and this has allowed them to take advantage of (lower gain) whip or patch antennas in their communication systems. Due to their low directionality, these antennas can generally maintain a communication link even when the spacecraft is tumbling, which is advantageous for CubeSats lacking accurate pointing control. Monopole antennas are easily deployable from a CubeSat and are generally used for VHF and UHF communications (Figure 9.2). Patch antennas, such as the one shown in Figure 9.3, are small and robust and do not require deployment. They are generally used from UHF through S-band on CubeSats, and are being explored for use in X-band arrays on CubeSats (Altunc, et al.), and beyond. A key advantage of higher frequency (especially for CubeSats) is that antenna aperture decreases but gain remains similar. This is advantageous for ground systems too. One major disadvantage is that higher frequencies get readily absorbed by the atmosphere. In the Ka-band, water droplets heavily attenuate the signal, resulting in “rain fade,” so greater transmitting power is required to close the link. However, this does not present a problem for intersatellite links, which do not pass through the atmosphere.

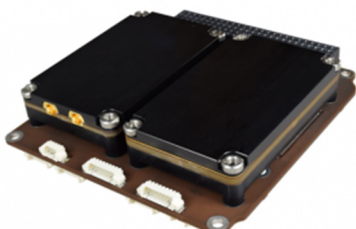

Figure 9.4: Example of software defined radio, tunable in the range 70 MHz to 6 GHz. Image courtesy of GOMSpace.

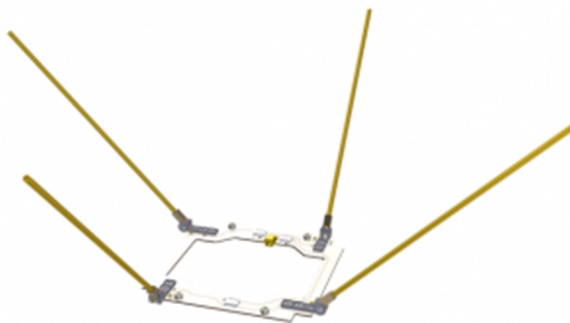

Figure 9.2 UHF deployable (4) monopole antennas for use on CubeSats. Image courtesy of GOMSpace.



Figure 9.3: CubeSat-compatible S-band patch antenna. Image courtesy of IQ Wireless.

Another trend that aids in the improvement of RF based communication systems is the development of software defined radio (SDR). By using Field Programmable Gate Arrays (FPGAs), SDRs (Figure 9.4) have great flexibility that allows them to be used with multiple bands, filtering and modulation schemes, without much (if any) change to hardware (Wertz, Everett, & Puschell, 2015). Furthermore, such characteristics can be changed in-flight



by uploading new settings from the ground. SDRs are especially attractive for use on CubeSats as they can be made increasingly small and efficient as electronics become smaller and require less power. Since 2012, NASA has been operating the Space Communications and Navigation (SCaN) Testbed on the International Space Station, which was created for the purpose of SDR TRL advancement, among other things (Johnson, Reinhart, & Kacpura, 2012).

Laser based communication (“lasercom”) has already been demonstrated with larger spacecraft such as LADEE (Buck & Washington, 2013). Optical communications for small spacecraft have also been demonstrated, such as the Optical Communications and Sensor Demonstration (OCSD) mission that was launched in 2017 and successfully transmitted data, the era for lasercom on CubeSats is just beginning.

The following sections discuss CubeSat technology that is TRL 6+, as listed below in tables organized by operating frequency.

The author would like to highlight that the presented tables are not intended to be exhaustive but to provide an overview of current state-of-the-art technologies and their development status for this small spacecraft subsystem. There was no intention of mentioning certain companies and omitting others based on their technologies.

9.2 State of the Art

9.2.1 VHF and UHF

VHF and UHF frequencies are mature bands used for CubeSat communication, with several radio developers to choose from. TRL~7 and higher technologies are listed in Table 9-1. Note that Clyde Space’s VUTRX transceiver was developed by the French South African Institute of Technology (F’SATI) at Cape Peninsula University of Technology (CPUT) (Products, 2015). More information on L3 Communications’ Cadet Radio can be found in (Kneller & Hyer, 2012).

Table 9-1: Developers and Products for Use in VHF/UHF		
Product	Manufacturer	TRL Status
Lithium-1	Astronautical Development LLC	9
CSK Phasing Board	Astronautical Development LLC	9
VUTRX	Clyde Space Ltd.	9
UHF Antenna	Endurosat	9
UHF Transceiver Type II	Endurosat	9
ETT-01EBA102-00	Emhiser Research, Inc.	9
NanoCom AX100	GOMSpace ApS	8
NanoCom ANT430	GOMSpace ApS	9

NanoCom SDR	GOMSpace ApS	7
P/N 17100	Haigh-Farr, Inc.	9
Helios Deployable Antenna	Helical Communications Technologies	6
TRXUV	ISIS B.V.	9
TRXVU	ISIS B.V.	8
Deployable Antenna System for CubeSats	ISIS B.V.	9
Cadet	L3 Communications, Inc.	9
SatCOM TP0	LY3H	9
SatCOM UHF	NanoAvionics	9
UHF Antenna	NanoAvionics	9

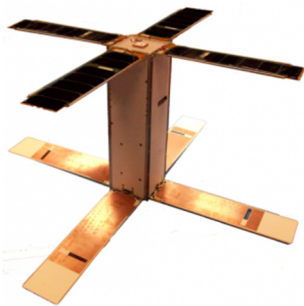

Figure 9.5: SNaP spacecraft with Haigh-Farr's deployable UHF Crossed Dipole antenna. Image courtesy of Haigh.

Typically, a small patch antenna (Figure 9.6) or whip antenna is used to transmit VHF and UHF. Aside from the TRL 9 antennas listed in Table 9-1, other deployable, higher gain antennas (Figure 9.5) are being developed, including a TRL 6 deployable quadrifilar helical UHF through S-band antenna by Helical Communication Technologies (HCT), and a deployable helical UHF antenna by Northrop Grumman Aerospace System (Ochoa, Hummer, & Ciffone, 2014).

Endurosat has developed a UHF antenna at 435-438 MHz that is compatible with Endurosat Z solar panels (Figure 9.7). This antenna has a total mass of 0.105 kg and was flown on Edurosat-1 (launched May, 2018).

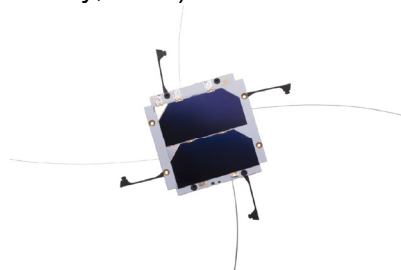

Figure 9.7: Endurosat UHF antenna with Endurosat solar panels. Image courtesy of Endurosat.

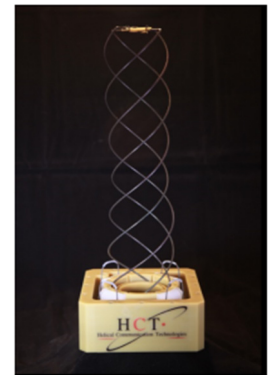

Figure 9.6: Example of deployable quadrifilar helical antenna. Image courtesy of Helical Communication Technologies.



9.2.2 L-Band

In L-band, CubeSats can take advantage of legacy space communications networks such as GlobalStar and Iridium by using network specific transponders to relay information to and from Earth. An additional advantage is that these networks remove dependence on dedicated ground station equipment, as discussed further in the ground support equipment (GSE) section.

Examples of network-specific transponders are shown in Table 9-2. NearSpace Launch's EyeStar-D2 Satellite Duplex radio has flight heritage from 2015, but no large file transfer was possible during the flight due to an unplanned 2~rpm spin rate (Voss, Dailey, Crowley, Bennett, & White, 2014). Since then, NearSpace Launch has successfully operated EyeStar-D2 on AFRL's SHARC. Also, sci_Zone, Inc. is developing its next generation of simplex radio, STX3, as well as a duplex radio, and both will use the Globalstar constellation (Santangelo & Skentzos, 2016). The multiband HCT quadrifilar helical antenna mentioned earlier can also operate in L-band.

Product	Manufacturer	TRL Status
Helios Deployable Antenna	Helical Communications Technologies	6
9602 SBD	Iridium Communications, Inc.	9
EyeStar-S2	NearSpace Launch, Inc. (NSL)	9
EyeStar-D2	NearSpace Launch, Inc. (NSL)	9
Antenna SYN7391-B (Iridium)	NAL Research Corporation	Unkn.
STX2 Simplex	sci_Zone, Inc.	9

9.2.3 S-Band

Examples of TRL 7+ S-band communication technology are shown in Table 9-3. A CubeSat-compatible S-band transmitter is shown in Figure 9.8. Note that the Clyde Space products SANT and STX were developed by F'SATI at CPUT. Haigh-Farr's S-band antennas are scheduled to fly on the CPOD 3U CubeSat mission, which launched in mid-2018.

Regarding lower TRL technology, L3 Communications' Cadet Nanosat Radio (see Table 9-1) can also be configured for S-band, although this has not been demonstrated at the time of publication. LJT & Associates have developed the LCT2-b, an S-band transponder to work with the Tracking and Data Relay Satellite System (TDRSS). The LCT2-b S-band BPSK TDRSS transmitter has already flown on the SOAREX-VI flight experiment (White, Morgan, & Murbach, 2007). Similarly, Surrey Satellite Technology US LLC developed an S-band quadrifilar antenna, S-band downlink transmitter, and S-band receiver with flight heritage on spacecraft that are less than 180 kg in mass, though to the knowledge of the author they have not flown on a CubeSat mission. Haigh-Farr also offers high-TRL technology for S-band communications.

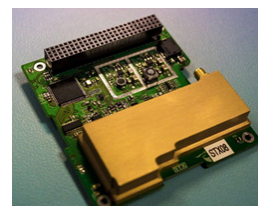

Figure 9.8: CubeSat-compatible S-band transmitter, to be used with either amateur or commercial bands. Image courtesy of Clyde Space Ltd.



Table 9-3: Manufacturers and Products for Use in S-band		
Product	Manufacturer	TRL Status
Beryllium 2	Astronautical Development LLC	9
SANT	Clyde Space Ltd.	9
STX	Clyde Space Ltd.	9
S-band Patch Antenna	Endurosat	9
S-band Transmitter	Endurosat	9
Helios Deployable Antenna	Helical Communications Technologies	6
SCR-100	Innoflight, Inc.	9
HISPICO	IQ Wireless GmbH	9
SLINK-PHY	IQ Wireless GmbH	8
TXS	ISIS B. V.	8
S-Band Patch Antenna	Surrey Satellite Technology	9
EWC31	Syrlinks	9
SPAN-S-T3	Syrlinks	9
SWIFT-SLX	Tethers Unlimited	6
SWIFT-XTS	Tethers Unlimited	6
CSR-SDR-S/S	Vulcan Wireless, Inc.	9

Many antennas are available in S-band, including a stacked patch S-band antenna being developed by NewSpace Systems and the HCT quadrifilar helical antenna mentioned in the VHF and UHF section. AntDevCo, IQ Wireless, Surrey Satellite Technology and many others make S-band patch antennas that could be compatible with CubeSats. ISIS B.V. resells the S-band patch antenna, and transmitter and receiver for IQ Wireless' HISPICO communication system. Syrlinks is a strong competitor in the European market and also offers patch antennas in the S- and X-bands, among many other high-TRL products.

The unlicensed ISM (Industrial, Scientific, and Medical) bands have been used for CubeSat communications as well. Notably, a group at Singapore's Nanyang Technological University used a 2.4-GHz ZigBee radio on its VELOX-I mission to demonstrate that COTS land-based wireless systems can be used for inter-CubeSat communication (Xie, Xiong Lee, Low, & Gunawan,



2014). Similarly, current investigations are looking at using wireless COTS products, such as Bluetooth-compatible hardware, for *intra*-satellite communications (Schoemaker & Bouwmeester, 2014).

Furthermore, companies that traditionally design communications for larger spacecraft are now modifying some of their products for use on smaller spacecraft. One example is the COM DEV S-band transceiver (Hatzithanasiou & McLaren, 2014). COM DEV was acquired by Honeywell in 2016, but many legacy COM DEV products are still available in their Honeywell incarnation.



Figure 9.9: X-band high-gain antenna and pointing mechanism. Image courtesy of Surrey Space Ltd.

9.2.4 X-band

X-band transmitters (Figure 9.9) have recently become a reality for CubeSats because of the advent of commercially available Monolithic Microwave Integrated Circuits (MMICs). Industry, universities and government centers alike are trying to develop communications systems at this wavelength (Palo, et al., 2014).

Table 9-4 displays TRL 9 CubeSat-compatible X-band communication hardware. Note that AntDevCo's "evolved" wire antennas were designed using X5 Systems' AntSyn (Antenna Synthesis) software. The corresponding flight heritage (ST5 mission) is not of the CubeSat form factor, but each of the five spacecraft still fit into the small satellite category with a mass of 25 kg. AntDevCo also develops X-band patch antennas. It should also be noted that Planet Labs uses a proprietary X-band radio (Bshuizen, Mason, Klupar, & Spanhake, 2014).

Product	Manufacturer	TRL Status
Evolved X-band wire antennas	Antenna Development Corporation, Inc. (AnyDevCo)	9
Quadrifilar Helix Antenna	Antenna Development Corporation, Inc. (AnyDevCo)	9
XTX	Clyde Space	9
XANT	Clyde Space	9
X-band Patch Antenna	Endurosat	9
X-band Transmitter	Endurosat	9
XLINK	IQ Wireless GmbH	9
IRIS V2	JPL	9
SPAN-X-T2	Syrlinks	9

SPAN-X-T3	Syrlinks	9
HDR-TM	Syrlinks	9
EWC27	Syrlinks	9

Surrey Satellite Technology developed a high-gain X-band antenna and corresponding pointing mechanism (see Figure 9.9), and an X-band transmitter that have flight heritage on spacecraft less than 180 kg in mass, but have not flown on a CubeSat mission to the best knowledge of the author.

JPL has also developed a CubeSat compatible transponder, IRIS V2 (Figure 9.10), suitable for deep space communications in X-, Ka-, S-bands, and UHF (Duncan, Smith, & Aguirre, 2014). IRIS radios have been licensed to Space Dynamics Laboratory, and future iterations will be delivered by SDL. CU Boulder and Goddard Space Flight Center jointly developed an X-band SDR that is now being sold by Blue Canyon Technologies (Altunc, et al.). Lower TRL technologies include an X-band transmitter from NewSpace Systems. A team from Utah State University is working on an X-band antenna array that is integrated with solar panels, a novel idea that could greatly save space (Yekan, Baktur, Swenson, Shaw, & Kegege, 2016).

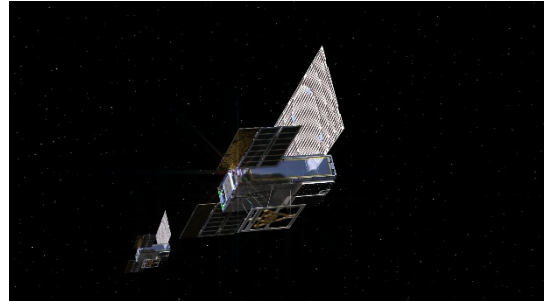

Figure 9.10: Artist's rendition of JPL's MarCO CubeSats which use the IRIS V2 deep space transponder. Image courtesy of JPL.

9.2.5 Lasercom

Laser communication for CubeSats has only recently been demonstrated in space, but it is quickly maturing and has been successfully demonstrated. Aerospace Corporation, in cooperation with NASA Ames, launched three CubeSats in its AeroCube Optical Communication and Sensor Demonstration (Figure 9.11). In March, 2018, a systems checkout was completed and the mission entered the operational phase. AeroCube's optical communication technology successfully transmitted data in mid-2018 and has matured to TRL 7.

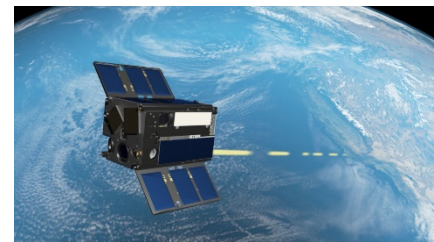

Figure 9.11: An artist's rendering of laser communications for the OCSD. Image courtesy of NASA.

Fibertek launched a 6U lasercom system in 2018 as part of the NASA Ames Small Business Innovation Research program (SBIR), and continue to make substantial progress in lasercom and lidar technologies. Sinclair Interplanetary is developing the DCL-17 (TRL 5), a self-contained optical communications terminal that incorporates a built-in star tracker and 1 Gbps laser downlink. Future lasercom endeavors include the NASA-sponsored Miniature Optical Communication Transmitter (Serra, Barnwell, Ritz, & Conklin, 2016).

Many other international entities are advancing in the area of CubeSat laser communications as well. The German Aerospace Center (DLR) is currently flying two lasercom terminals as part of its OSIRIS program. The Small Optical Transponder (SOTA) developed by the National Institute of Information and Communications Technology in Japan (NICT) has successfully demonstrated a laser space-ground link from a 50 kg microsatellite (National Institute of Information and



Communications Technology, 2017). The CubeL, a laser communication terminal for CubeSats designed by Tesat-Spacecom, is on track for implementation after passing the Critical Design Review in April 2018.

All of these ventures, had lasers onboard, but another lower TRL lasercom concept involves an asymmetric optical link, whereby the laser hardware is on Earth and a modulating retroreflector is on the spacecraft (refer to the Asymmetric Lasercom section).

9.2.6 Ku- to Ka-band

Ku-, K-, and Ka-band communication systems are the state-of-the-art for large spacecraft, especially in spacecraft-to-spacecraft communications, but they are still young technologies in the CubeSat world. Developers working on CubeSat compatible Ka-band communication systems include Astro Digital, Micro Aerospace Solutions, NewSpace Systems and Tethers Unlimited.

Astro Digital, formerly known as Aquila Space, has already launched Landmapper-HD 1, a 20 kg 16U microsatellite that's the first in a constellation of 20 imaging satellites. It has a 300 Mbps Ka-band downlink transmitter shown in Figure 9.12. The Landmapper-BC is the predecessor to the Landmapper-HD constellation, but it unfortunately lost four satellites to launch damage. Landmapper-BC 3 v2 was launched in January 2018, weighs 1 kg, and boasts a 320 Mbps Ka-band data rate. The next generation of Ka-band transmitters from Astro Digital will increase the data rate to 800 Mbps. A Ka-band transmitter is shown in Figure 9-11. Micro Aerospace Solutions has a TRL~5 Ku/Ka-band transceiver with deployable 60 cm CubeSat dish antenna (Lyons, Platt, Reeve, Rockeberger, & Tamir, 2015) and Tethers Unlimited has a TRL 6 K-band SDR called SWIFT-KTX. Table 9-5 lists some current state-of-the-art communications equipment in this category.

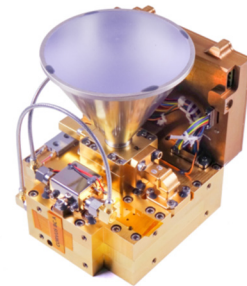

Figure 9.12: Ka-band transmitter with a horn antenna. Image courtesy of Astro Digital.

Table 9-5: Manufacturers and Products for Use in Ka- to Ku-band		
Product	Manufacturer	TRL Status
AS-10075	Astro Digital	9
Ku-band Transceiver	NewSpace Systems	6
1 Gbit Transponder	NewSpace Systems	6
SDR Transceiver	NewSpace Systems	6
SWIFT-KTX	Tethers Unlimited	6

At the higher frequencies, rain fade becomes a significant problem for communications between a spacecraft and Earth (Pelton, 2006). Nonetheless, the benefits of operating at higher frequencies have justified further research by both industry and government alike. At the Jet Propulsion Laboratory (JPL), the Integrated Solar Array and Reflectarray Antenna (ISARA) mission demonstrated high bandwidth Ka-band CubeSat communications with over 100 Mbps downlink rate (National Aeronautics and Space Administration, 2016). Essentially, the back of the 3U CubeSat is fitted with a high gain reflectarray antenna that is integrated into an existing solar array. The ISARA technology is currently in orbit and has recently completed a systems checkout. It will be TRL 7 following successful demonstration.

9.3 On the Horizon

9.3.1 Asymmetric Laser Communications

Spacecraft parameters like power, mass, and volume are constrained by cost and current capability. Ground operations, on the other hand, are not subject to the same limitations. Asymmetric laser communications leverage this imbalance. Asymmetric laser communication uses a remotely generated laser (i.e. does not require an on-board signal carrier) and modulating retroreflector (MRR) to reflect and modulate a laser beam (encoding it with spacecraft data) back to Earth (Figure 9.13). The laser is located on Earth, where power and volume constraints are not as tight, while the communications payload on the spacecraft is limited to only a few Watts for operation. SPAWAR is developing this technology using a MEMS-based MRR (Wayne, et al., 2015), while NASA Ames Research Center is developing a similar capability using a modulating quantum well (MQW) device as the MRR (Salas, Stupl, & Mason, 2012).



Figure 9.13: Scheme for using land-based laser to transmit data from CubeSat using on-board MRR. Image courtesy of Salas (2012).

9.3.2 New Antennas

When deployable solar panels are not an option, a CubeSat's surface is prime real estate for solar cells. One way to maximize exposed surface area on a CubeSat is to create communications antennas that are optically transparent. Groups at the University of Houston (Montano, et al., 2014) and Utah State University (Genc, Turpin, Yasin, & Baktur, 2012) have developed prototypes of these small, optically transparent antennas. Owing to progress from MMA Design, deployable antennas may become common in the CubeSat world. They are developing a revolutionary deployable antenna providing extremely high areal compaction and combining the positive attributes of currently available CubeSat antennas. They predict that the deployable antenna will enable performance for smallsats consistent with today's large spacecraft (Kelly, 2016). A similar design is seen at NASA's Marshall Space Flight Center. The Lightweight Integrated Solar Array and Transceiver (LISA-T) is a deployable array on which thin-film photovoltaic and antenna elements are embedded (Carr, et al., 2016).

9.3.3 InterCubeSat Communications and Operations

There are multiple advantages to communicating between spacecraft. As CubeSat missions become more automated, constellations could exchange information to maintain precise positions without input from the ground. Data can be relayed between spacecraft to increase the coverage from limited ground stations. Finally, inter-CubeSat transponders may very well become a vital element of eventual deep space missions, since CubeSats are typically limited in broadcasting power due to their small size and may be better suited to relay information to Earth via a larger, more powerful mothership.

Though transponders are well established in the spacecraft world, networked swarms of CubeSats that pass information amongst each other and then eventually to ground, have yet to be demonstrated. Developing networked swarms is less of a hardware engineering problem than a systems and software engineering problem, as demonstrated by NASA Ames Research Center's Edison Demonstration of Smallsat Networks (EDSN) mission (Hanson, Chartres, Sanchez, & Oyadomari, 2014), Figure 9.14. Unfortunately, the eight small satellites that comprise the EDSN mission were lost due to launch failure. Ames' follow up, the two 1.5 U Network &

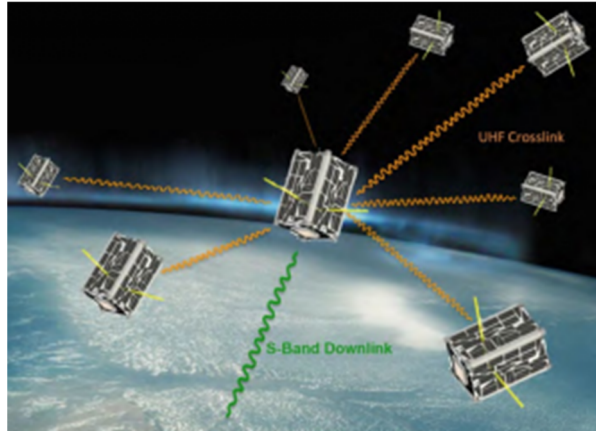

Figure 9.14: Scheme for inter-CubeSat communication for EDSN mission. Image courtesy of NASA.

Operations Demonstration Satellites (Nodes), deployed from the ISS in 2016. The Nodes mission will be an opportunity to complete some of the tasks set forth in the EDSN mission. Similarly, the CubeSat Proximity Operations Demonstration (CPOD) mission, led by Tyvak NanoSatellite Systems, Inc., “will demonstrate rendezvous, proximity operations and docking using two 3U CubeSats” (National Aeronautics and Space Administration, 2013).

Engineers from NASA Marshall Space Flight Center are also developing inter-CubeSat communication using a peer-to-peer topology. The mesh network architecture is designed to allow for the exchange of telemetry and other data between spacecraft with no central router (Becker, 2017). Clyde Space is in the early stages of its ambitious project called the Outernet, a low-cost, mass-producible constellation of 1U CubeSats that will provide a near continuous broadcast of humanitarian data to those in need (Anderson & Karim, 2016).

9.4 Summary

There is already strong flight heritage for many UHF/VHF and S-band communication systems for CubeSats. Less common, but with growing flight heritage, are X-band systems. Higher RF frequencies and laser communication already have CubeSats flight heritage, but with limited (or yet to be demonstrated) performance. Ka-band systems for CubeSats are currently in development, but TRL status is still relatively low. On the other hand, laser communication is a spaceflight ready technology that should see future onboard laser systems with increased performance. Alternatively, a few groups are working on asymmetric laser communication, but this is still a relatively low TRL technology.

References

- Alessanda Babuscia, B. C. 2013. "Inflatable Antenna for CubeSats: Motivation for Development and Antenna Design." *Acta Astronautica*, 322-332.
- Altunc, S., Kegege, O., Bundick, S., Shaw, H., Schaire, S., Bussey, G., Burke, J. 2015. "X-band CubeSat Communication System Demonstration." *29th Annual AIAA/USU Conference on Small Satellites*. Logan, UT.



- Anderson, P., & Karim, S. 2016. "Outernet: the Development of 1U CubeSat Platforms to Enable Low-Cost Global Data Provision." *30th Annual AIAA/USU Conference on Small Satellites*. Logan, UT.
- Becker, C. 2017. "Mesh Network Architecture for Enabling Inter-Spacecraft Communication." *31st Annual AIAA/USU Conference on Small Satellites*. Logan, UT.
- Bshuizen, C., Mason, J., Klupar, P., & Spanhake, S. 2014. "Results from the Planet Labs Flock Constellation." *28th Annual AIAA/USU Conference on Small Satellites*. Logan, UT.
- Buck, J., & Washington, D. 2013. "NASA Laser Communication System Sets Record with Data Transmissions to and from Moon." Retrieved from [nasa.gov: https://www.nasa.gov/press/2013/october/nasa-laser-communication-system-sets-record-with-data-transmissions-to-and-from/#.WzusFvIKiUk](https://www.nasa.gov/press/2013/october/nasa-laser-communication-system-sets-record-with-data-transmissions-to-and-from/#.WzusFvIKiUk)
- Carr, J., Boyd, D., Martinez, A., SanSoucie, M., Johnson, L., Laue, G., Johnson, M. 2016. "The Lightweight Integrated Solar Array and Transceiver (LISA-T): Second Generation Advancements and the Future of SmallSat Power Generation." *30th Annual AIAA/USU Conference on Small Satellites*. Logan, UT.
- Duncan, C., Smith, A., & Aguirre, F. 2014. "Iris Transponder-Communications and Navigation for Deep Space." *28th Annual AIAA/USU Conference on Small Satellites*. Logan, UT.
- Foust, J. 2015. "JPL Studies Missions, Tech for Future Interplanetary CubeSats." Retrieved from SpaceNews.
- Genc, A., Turpin, T., Yasin, T., Baktur, R. 2012. "Active Integrated Meshed Patch Antennas for Small Satellites." *Microwave and Optical Technology Letters; Vol. 54*, 1593-1595.
- Hanson, J., Chartres, J., Sanchez, H., & Oyadomari, K. 2014. "The EDSN Intersatellite Communications Architecture." *28th Annual AIAA/USU Conference on Small Satellites*. Logan, UT.
- Hatziathanasiou, I., & McLaren, C. 2014. "Flexible S-Band TTC (Telemetry, Tracking, and Command) for Small Spacecraft in LEO." *28th Annual AIAA/USU Conference on Small Satellites*. Logan, UT.
- IEEE. 2009. "IEEE Standard Letter Designations for Radar-Frequency Bands."
- Johnson, S., Reinhart, R., & Kacpura, T. 2012. "CoNNeCT's Approach for the Development of Three Software Defined Radios for Space Application." *2012 IEEE Aerospace Conference*; pg. 1-13. Big Sky, MT.
- Kelly, P. 2016. "A Scalable Deployable High Gain Antenna - DaHGR." *30th Annual AIAA/USU Conference on Small Satellites*. Logan, UT.
- Kneller, E., Hyer, K. 2012. "Cadet: a High Data Rate Software Defined Radio for SmallSat Applications." *26th Annual AIAA/USU Conference on Small Satellites*. Logan, UT.



- Lyons, R., Platt, D., Reeve, J., Rockeberger, D., Tamir, R. 2015. "Enhanced Small Satellite Communication System for Remote Planetary Exploration." *66th International Astronautical Congress*.
- Montano, R., Neveu, N., Palacio, S., Martinez, E., Jackson, D., Chen, J., Provence, R. 2014. "Development of Low-profile Antennas for CubeSats." *28th Annual AIAA/USU Conference on Small Satellites*.
- National Aeronautics and Space Administration. 2013. "*CubeSat Proximity Operations Demonstration*." Retrieved from NASA.
- National Aeronautics and Space Administration. 2013. "*Edison Demonstration of Smallsat Networks Mission: a Swarm of Advanced, Affordable, COTS-based Nanosatellites that Enable Cross-Link Communication and Multipoint Physics*." Retrieved from NASA.
- National Aeronautics and Space Administration. 2016. "*Integrated Solar Array and Reflectarray Antenna (ISARA) for High Bandwidth CubeSats*." Retrieved from NASA.
- National Institute of Information and Communications Technology. 2017. "*World's First Demonstration of Space Quantum Communication Using a Microsatellite*." Retrieved from NICT.
- Ochoa, D., Hummer, K., Ciffone, M. 2014. "Deployable Helical Antenna for Nano-Satellites." *28th Annual AIAA/USU Conference on Small Satellites*. Logan, UT.
- Optical Communications and Sensor Demonstration (OCSD)*. 2015. Retrieved from NASA.
- Palo, S., O'Connor, D., DeVito, E., Kohnert, R., Crum, G., Altunc, S. 2014. "Expanding CubeSat Capabilities with a Low Cost Transceiver." *28th Annual AIAA/USU Conference on Small Satellites*. Logan, UT.
- Pelton, J. 2006. "*The Basics of Satellite Communications*." Professional Education International, Inc.
- Products*. 2015. Retrieved from French South African Institute of Technology.
- Salas, A., Stupl, J., Mason, J. 2012. "Modulating Retro-reflectors: Technology, Link Budgets and Applications." *63rd International Astronautical Congress*.
- Santangelo, A., Skentzos, P. 2016. "Linkstar, a Globalstar Based Duplex Radio for Satellites In LEO - Architecture and Test Results." *30th Annual AIAA/USU Conference on Small Satellites*. Logan, UT.
- Schoemaker, R., Bouwmeester, J. 2014. "Evaluation of Bluetooth Low Energy Wireless Internal Data Communication for Nanosatellites." *Small Satellites Systems and Services Symposium*; pg. 1-15.
- Serra, P., Barnwell, N., Ritz, T., Conklin, J. 2016. "Deep Space Laser Communication Transmitter and High Precision Timing System for Small Satellites." *30th Annual AIAA/USU Conference on Small Satellites*. Logan, UT.



- Voss, H., Dailey, J., Crowley, J., Bennett, B., White, A. 2014. "TSAT Globalstar ELaNa-5 Extremely Low-Earth (ELEO) Satellite." *28th Annual AIAA/USU Conference on Small Satellites*.
- Wayne, D., Obukhov, D., Phipps, A., Tran, M., Book, K., Lovern, M. 2015. "Design and Testing of a CubeSat-Sized Retroreflector Payload." *29th Annual AIAA/USU Conference of Small Satellites*.
- Welle, R., Janson, S., Rowen, D., Rose, T. 2015. "CubeSat-scale Laser Communications." *31st Space Symposium, Technical Track*.
- Wertz, J., Everett, D., Puschell, J. 2015. "*Space Mission Engineering: the New SMAD*." Hawthorne, CA: Microcosm Press.
- White, B., Morgan, H., Murbach, M. 2007. "SOAREX-VI Re-entry Flight Test Experiment - Electronic Systems of the Slotted Compression Ramp (SCRAMP) Probe." *International Planetary Probe Workshop - IPPW-5*.
- Xie, S., Xiong Lee, G., Low, K.-S., Gunawan, E. 2014. "Wireless Sensor Network for Satellite Applications: a Survey and Case Study." *Unmanned Systems. Vol. 2, 261-277*.
- Yekan, T., Baktur, R., Swenson, C., Shaw, H., Kegege, O. 2011. "Integrated Solar-Panel Antenna Array for CubeSats (ISAAC)." *30th Annual AIAA/USU Conference on Small Satellites*. Logan, UT.



10.0 Integration, Launch, and Deployment

10.1 Introduction

Of the 464 total spacecraft launched in 2017, 289 (62%) fell under the “nanosat” category and 175 were larger spacecraft (Todd 2017). Forecasts show that the balance will shift even more towards small spacecraft in the near future. State-of-the-art technologies in launch vehicles, integration, and deployment systems are responding to the changing small spacecraft market to support new, advanced missions with diverse technologies that will take future small spacecraft further into space.

Since launch vehicles usually exceed requirements of the primary customer, there is usually enough residual mass, volume, and other performance margins to include a secondary small spacecraft payload. Small spacecraft can exploit this surplus capacity for an inexpensive ride to space. A large market of adapters and deployers has been created to compactly house multiple small spacecraft on existing launchers. These technologies provide a secure attachment to the launcher as well as deployment mechanisms. This ride-share method is still the primary way of putting small spacecraft into orbit, but the new technological advancements show that the popularity of classical ride-sharing might slowly decrease in the upcoming years. Dedicated ride-sharing, where an integrator books a complete launch and sells the available capacity to multiple spacecraft operators without the presence of a primary customer, is a new and interesting approach in the sector. Additionally, nanosatellite form factors are increasing in dimension, which requires larger deployers to accommodate these larger CubeSat sizes.

Although not a new idea, using orbital maneuvering systems to deliver small spacecraft to intended orbits is another growing technology. Several commercial companies are developing orbital tugs to be launched with state-of-the-art launch vehicles to an approximate orbit, which then propel themselves with their on-board propulsion system to another orbit where they will deploy their hosted small spacecraft.

In the future, the expanding capabilities of small payloads will also demand dedicated launchers. For missions that need a very specific orbit, interplanetary trajectories, precisely timed rendezvous, or special environmental considerations, flying the spacecraft as a primary payload may be the best method of ascent. Technology developers and hard sciences can take advantage of the quick iteration time and low capital cost of small spacecraft, to yield new and exciting advances in space capabilities and scientific understanding.

The author would like to highlight that the presented tables are not intended to be exhaustive but to provide an overview of current state-of-the-art technologies and their development status for this small spacecraft subsystem. There was no intention of mentioning certain companies and omitting others based on their technologies.

10.2 State of the Art

10.2.1 Launch Integration Services

Generally, the launch vehicle customer decides whether secondary payloads will share a ride with a primary payload and if so, how these secondary payloads are dispensed. In most cases, the launch vehicle (LV) customer is the primary payload. However, there are cases where a program or integration company can determine ride-share possibilities. More flexibility may be available to secondary payloads that are funded through such a program, although the mission schedule is generally decided by the primary payload. Typical ride-share integration services are general



services provided by these integration companies that focus on LV integrations and do not vary due to mission requirements of the primary payload. Standardized services include system testing, engineering development support, hardware of the dispenser, and requisite spacecraft-to-dispenser and dispenser-to-LV integration. Ride-share integration services may depend heavily on the primary payload and can include de-integration (e.g., executing a separation maneuver), mission and science-specific services, special analyses related to hardware and integration services, and isolated venting, shock, vibration, and thermal environmental control.

Examples of launch integration companies are given below. These companies purchase the excess capacity on existing rockets and integrate as many small payloads as possible into this capacity, to make the most efficient use of the launch vehicle.

Adaptive Launch Solutions (ALS)

Adaptive Launch Solutions provides launch integration services for small spacecraft on Atlas and Delta launch vehicles. The company is responsible for mission integration, thermal, coupled load, contamination, vibration, acoustic, shock, circuit, power, and venting models, analysis and test. ALS develops Auxiliary Payload Support Unit mission software providing sequenced power switching and separation validation to each auxiliary payload separation system (Adaptive Launch Solutions 2015).

Commercial Space Technologies (CST)

Commercial Space Technologies Ltd. is a consultancy company registered and based in London, with a representative office in Moscow. CST has negotiated and procured LVs for small spacecraft customers, and has managed the interaction between launch provider and customer for 33 successful missions using five different LVs from three different launch sites (Commercial Space Technologie 2015).

ISIS

Innovative Solutions in Space (ISIS) is a spacecraft company based in the Netherlands and established in 2006. The company is focused on supplying components and launch services for spacecraft in the range of 1 to 20 kg. In June, 2014, the company sent 23 CubeSats into orbit on a Dnepr rocket and deployed them from their QuadPack dispenser. ISIS was in charge of the QB50 launch campaign, which launched 2017, an initiative to send fifty university-built CubeSats to conduct research in Earth's lower thermosphere (Innovative Solutions in Space B.V 2015).

Qinetiq

QinetiQ North America (QNA) located in Waltham, MA, is a company with expertise in launch vehicle procurement, design, analysis, manufacturing oversight, integration, testing, mission management and launch. The company supports over twenty manifested Falcon 9 missions (Qinetiq 2015).

Moog CSA Engineering

Moog CSA, located in Mountain View, CA, has been assisting commercial and military aerospace customers for more than thirty years to provide vibration isolation systems, tuned mass dampers for vibration control, softride spacecraft isolation systems, shock test services, and spacecraft transport shipping containers. The company also provides integration support for its customers (Moog CSA Engineering 2015).



Nanoracks

Nanoracks, founded in 2009, is a company located in Houston, Texas, which hosts accommodation and an array of equipment for experiments on ISS. The company has offered ISS-deployment services to its customers since 2014. In 2015, NanoRacks teamed up with Blue Origin to offer services for the New Shepard Suborbital Vehicle (NanoRacks LLC 2015).

Spaceflight Services

Spaceflight Services, founded in 2010 and based in Seattle, provides routine access to space for deployed and hosted small payloads by using published commercial pricing, standard interfaces, and frequent flight opportunities. Specific integration services include engineering analysis, spacecraft-to-dispenser and LV integration, flight service, and standard interface options for payloads. Spaceflight has launched 81 spacecraft since it put its first payload into orbit in 2013, and has deployed over 135 spacecraft through 2018 (Spaceflight Services, 2015). The company's SSPS (Spaceflight Secondary Payload System) is designed to transport secondary and hosted payloads to space using the excess capacity on commercial launch vehicles. The SSPS can accommodate up to five 300 kg spacecraft, or many smaller spacecraft, on each of its five ports and operates independently from the primary launch vehicle to simplify payload and mission integration (European Space Agency 2015). The company is also developing a space tug (SHERPA), which builds upon the capabilities of the SSPS by incorporating propulsion and power generation subsystems, which can maneuver its secondary payloads to higher LEO altitudes, GEO, or even interplanetary trajectories. The first SHERPA mission was manifested on a SpaceX Falcon 9 in early 2016, with 89 payloads on board (European Space Agency 2015).

UTIAS/SFL

The University of Toronto Institute for Aerospace Studies Space Flight Laboratory (UTIAS/SFL) provides launch services for small spacecraft. Since 2002, the laboratory has arranged launches for more than ten spacecraft from different countries, including Indian (PSLV) and Russian (Rockot, COSMOS-3M, Dnepr, Soyuz) vehicles. The laboratory has a dispenser system called the XPOD which can be used for spacecraft up to 16 kg (UTIAS/SFL 2015).

TriSept Corporation

TriSept Corporation located in Milwaukee, WI, has been integrating spacecraft ranging from the size of a school bus to CubeSats for over 21 years. The company has physically integrated over 74 small spacecraft payloads on both suborbital, LEO, and GEO launches on multiple spacecraft missions. TriSept provides a total mission integration service, from concept development, interface requirements definition, launch vehicle selection and contracting, mission analyses, integration hardware provisions, fitchecks and pathfinders, integration, testing, and payload certification, to launch and spacecraft deployment. The company currently serves as the lead integrator for the Operationally Responsive Space (ORS) Office, managing the Office's complex multiple spacecraft ride-share missions, such as the ORS-3 mission, which consisted of 31 distinct payloads in 2013, and the ORS-4 mission, which is set to launch thirteen payloads on the first launch of the Super Strypi small launch vehicle. TriSept Corporation is also developing the FANTM-RiDE family of dispenser systems and manifesting several traditional and dedicated ride-share launch missions to serve the small spacecraft industry (Lim 2015).

SSTL

Surrey Satellite Technology Ltd (SSTL), based in the UK and now majority-owned by EADS Astrium, builds and operates small spacecraft. On the launcher side, the company negotiates with



launch providers to procure cost effective launch opportunities (Surrey Satellite Technology Ltd 2015).

Tyvak Nano-Satellite Systems LLC

Tyvak Nano-Satellite Systems LLC located in Irvine, CA, provides launch services for small spacecraft and has launch experience with payloads ranging from 1 kg to 100 kg. To date over 120 spacecraft have been successfully launched and 40 additional spacecraft are currently manifested. The integration services for NASA's first inter-planetary CubeSat (MarCO) mission to Mars is handled by the company. Tyvak provides a complete launch support solution, including development of launch vehicle payload interfaces and associated documentation, spacecraft testing and qualification, development of spacecraft accommodations (including standardized deployment systems), and launch manifest documentation (including frequency allocation and ODAR analysis). To support its launch activities, the company offers a number of standardized deployers, including systems compatible with 1U, 3U, 6U and 12U spacecraft (Puig-Suari 2015).

10.2.2 Dedicated Launchers of Small Spacecraft

In the context of this report, launch vehicles with total LEO capacity of 500 kg or less are considered to be dedicated launchers for small payloads. Small spacecraft have been in orbit for more than fifteen years. However, the annual number of small spacecraft launches did not rise significantly until 2013, therefore a robust market of small launchers has still not yet developed. As the capabilities of small spacecraft are increasing, they are starting to drive demand in the market. This section summarizes the current launch vehicles that have operated since 2000 (or plan to operate in the near future) as dedicated launchers for small spacecraft. Table 10-1 summarizes primary launchers.

Product	Manufacturer	LEO Capacity	Number of Secondary Payloads Launched to Date	Description	Launch Method	TRL Status
ACE Micro LV	Gloyer-Taylor Laboratories	150 kg	0	1-stage, all liquid	Land	5
Bloostar	Zero2Infinity	140 kg	0	5-stage, 1 Balloon, 4 Liquid	Air	6
Demi-Sprite	Scorpius Space Launch Company	160 kg	0	3-stage, all liquid	Land	5
Electron	Rocket Lab	225 kg	4	2-stage, all liquid	Land	9



Minotaur 1	Northrup Grumman Innovation Systems	580 kg	>62	4-stage, all solid	Land	9
Minotaur 5	Northrup Grumman Innovation Systems	630 kg (to GEO)	0	5-stage, all solid	Land	9
Pegasus	Northrup Grumman Innovation Systems	450 kg	8	3-stage, all solid	Air	9
Super Strypi	University of Hawaii, Sandia National Laboratories, Aerojet	275 kg to 400 km SSO, 320 kg to 400 km equatorial	0	3-stage, all solid	Land	6
Vector-R	Vector Launch Inc.	61 kg to 250 km, 26 kg to 450 km	0	2-stage, all liquid	Land	5

ACE Micro LV

The Advanced Cryogenic Expendable (ACE) launch vehicle is a high-performance expendable rocket stage from Gloyer-Taylor Laboratories (GTL) that is capable of delivering small payloads to orbit. The ACE vehicle achieves its performance advantage through the use of a suite of breakthrough technologies that have achieved TRL 6+ from a decade of research that included support from DARPA, NASA and the Air Force. ACE achieves its cost advantage by leveraging the performance advantage to reduce parts count, simplify system design and streamline launch operations.

GTL has completed the ACE preliminary design and is beginning detailed component development and testing. Integrated stage ground testing is scheduled for 2020 with first flight scheduled for 2021. GTL is also developing a small version of ACE to deliver 500-1000 kg payloads to LEO and a medium version of ACE to carry 5,000 kg payloads to LEO. The Ace design uses LOX/CH₄ propellant to deliver 150 kg to a 750 km circular LEO.

Bloostar

Zero2Infinity's Bloostar launch vehicle (Figure 10.1) uses a balloon as a first-stage. A helium balloon will be launched from a ship and will carry the system to over 20 km altitude, where the rocket is ignited. The system will be able to insert a 75 kg payload into a 600 km polar orbit. Payload accommodation can host a single spacecraft or multiple payloads. The company states that in the event of a launch abort, the high-altitude balloon will be detached from the platform and the platform will descend with a parachute (Zero2Infinity 2015). The system will use liquid oxygen and liquid methane as propellants. The first stage will carry the system to 250 km altitude and an inertial speed of 3.7 kms⁻¹. After the second stage operation, the system will achieve an altitude of 530 km with velocity of 5.4 kms⁻¹. The third and final stage will fire at least twice with a coast period to achieve the final orbit. Preliminary testing of the system has already started. In September 2013, an inflatable flexible pressurized vehicle flew to 27 km under a balloon. A test version of the pressure-fed light hydrocarbon/oxygen engine was fired in September 2014. The engine was ignited several times and the cooling system functioned well. The first small-scale prototype launch was conducted in 2017 (C. Henry 2017). The system is TRL 7. Zero2Infinity is currently focusing on their revenue-generating Elevate product line.



Figure 10.1: Bloostar Concept. Image courtesy of Zero2Infinity.

Demi-Sprite

The Scorpius Space Launch Company (SSLC), a sister company of Microcosm, is developing the Demi-Sprite (Figure 10.2) as part of its line of modular Scorpius vehicles. The Demi-Sprite is one of the smallest vehicles in the line. The launcher will be able to put a 160 kg payload into LEO. It consists of a core stage surrounded by six identical pods that compose first and second stages. Key to the vehicle's simplicity is the absence of turbo pumps for pressurizing its LOX and RP-1 propellants. The only moving parts on the vehicle are valves and gimbals. The system aims to provide true launch-on-demand service within 8 hours of arrival of the payload at the launch site (Scorpius Space Launch Company 2015). The core technologies have been validated in two successful suborbital flights with the Scorpius SR-S and SR-XM vehicles, therefore the system is TRL 5.



Figure 10.2: Demi-Sprite Mode. Image courtesy of Microcosm, Inc.

Electron

Rocket Lab Ltd. is an American launch company that originated out of New Zealand that designs and fabricates sounding rockets, small spacecraft launch systems, and propulsion systems. The company's Electron launch vehicle (Figure 10.3) is a two-stage system which uses turbo-pumped LOX/RP-1 engines. The pumps are battery-powered electric motors rather than a gas generator, expander, or preburner. The system is designed to lift 150 kg to 500 km SSO, and the company states it can be tailored to circular or elliptical orbits between 45° and 98° inclination. The company plans to provide one hundred annual launches (Rocket Lab Ltd 2015). Electron is one of the three systems which NASA's Venture Class Launch Services (VCLS) has awarded CubeSat missions to LEO. The first Electron launch occurred in 2017 but the second stage was destroyed by range safety after telemetry data was lost at 224 km. The second launch in 2018 successfully lifted 6 CubeSats to LEO (Clark 2018).

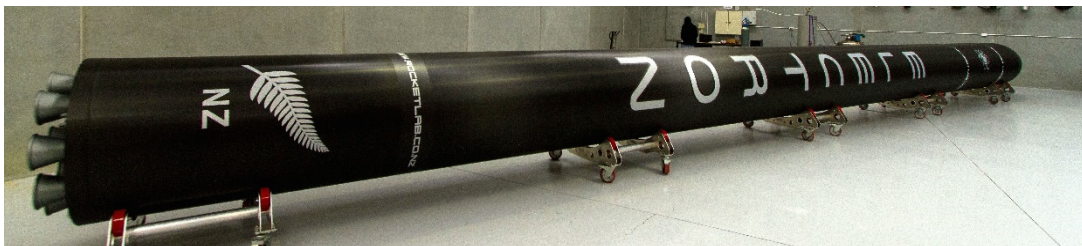

Figure 10.3: Electron. Image courtesy of Rocket Lab, Ltd.

Pegasus

The Pegasus (Figure 10.4), an air-launched vehicle built by Orbital Sciences, is a small- to medium-lift launcher that has a heritage of successful launches since 1996. The system delivers 450 kg to LEO with three solid stages. Different variants of the vehicle have a flight history of 43 missions between since 1990, 37 of which were successful. The rocket's variant carried NASA Interface Region Imaging Spectrograph (IRIS) mission (183 kg) in June 2013. The first mission for small spacecraft carried eight Cyclone Global Navigation Satellites (CYGNSS) (20 kg each) to space in December 2016. There is one Pegasus launch on the manifest dedicated for small spacecraft in 2018. This mission will inject the Ionospheric Connection Explorer (ICON) (279 kg) into orbit (Emspak 2016), (Herridge 2018).



Figure 10.4: Pegasus Launch System, mounted underneath a Lockheed-1011 jet. Image courtesy of Northrop Grumman Innovation Systems.

Minotaur

The Minotaur launcher family, also produced by Orbital Sciences, is another medium lift vehicle currently available. Out of the entire family, the Minotaur I (Figure 10.5) is more suited to small spacecraft since it has the lowest payload capacity and cost. The vehicle has conducted eleven missions with a 100% success rate, delivering 62 spacecraft into orbit. The Minotaur I is designed with four solid stages from a converted Minuteman ballistic missile. With a payload capacity of 580 kg to LEO, the vehicle can carry many small spacecraft into orbit in a single mission. On 20 November 2013, a Minotaur I placed 28 small spacecraft (all but one were CubeSats) and two experimental packages into orbit.

A larger member of the family, the Minotaur V, is a five-stage vehicle and is designed to place up to 630 kg of payload into a GTO, or 340 kg on a trans-lunar trajectory. The vehicle made its maiden flight in 2013 carrying the Lunar Atmosphere and Dust Environment Explorer (LADEE) (383 kg) spacecraft. However it has not yet carried any orbital payload (Orbital ATK 2015).



Figure 10.5: Minotaur I Launch Vehicle. Image courtesy of NASA

Super Strypi

Another dedicated small spacecraft carrier on market is the Super Strypi. This vehicle, also known as the Low Earth Orbiting Nanosatellite Integrated Defense Autonomous System (LEONIDAS), is a three-stage launcher developed jointly by the Innovative Satellite Launch Program at the University of Hawaii in cooperation with Sandia National Laboratories and Aerojet. The vehicle has a simple, rail-launched, spin-stabilized design with fixed fins and cold gas attitude control system for second- and third-stage maneuvering and orbital insertion. The system is designed to integrate payloads with the NASA Ames Nanosatellite Launch Adapter System (NLAS). Payload-to-orbit is about 275 kg to 400 km Sun synchronous orbit from the Pacific Missile Range Facility (PMRF) in Kauai, Hawaii, and about 320 kg to 400 km equatorial orbit from US east coast launch sites (Aerojet Rocketdyne 2015). The unsuccessful first flight of the system occurred in October 2015. The TRL of the system is 6.

Vector-R

Another rocket being developed primarily for small satellite payloads is the Vector-R rocket from Vector Launch Inc. The rocket consists of two liquid stages to bring 61 kg to an altitude of 250 km, or 26 kg to an altitude of 450 km. The rocket has completed a few static engine test fires, and completed its second low altitude (<3000m) test flight in August, 2017. The first orbital test flight of the Vector-R is scheduled to occur in 2018 (J. Foust 2017). The rocket is currently TRL 5.

10.2.3 Launchers Which Offer Ride-Sharing Opportunities for Small Spacecraft

As seen from the previous section, there are currently only a few launchers that allow small spacecraft to ride as primary payloads. The majority of small spacecraft are carried to orbit as secondary payloads, using the excess launch capability of larger rockets. Standard ride-sharing consists of a primary mission with surplus mass, volume, and performance margins which are used by other spacecraft. These spacecraft are also called secondary payloads, auxiliary payloads, or piggyback spacecraft. For both educational and commercial small spacecraft, several initiatives have helped provide these opportunities. NASA's CubeSat launch initiative, for



example, has provided rides to a number of schools and NASA centers. As of 2015, 37 CubeSats have been launched, and sixteen more are scheduled to go into space in the next twelve months with this program (National Aeronautics and Space Administration, 2015).

From the secondary payload designers' perspective, ride-share arrangements provide far more options for immediate launch at high TRL. Since almost any large launcher can fit a small payload within its mass and volume margins, there is no shortage of options for craft that want to fly as a secondary payload. On the other hand, there are downsides of hitching a ride. The launch date and trajectory are determined in favor of the primary payload, and the smaller craft have to take what is available. In some cases, they need to be delivered to the launch operator and be integrated on the adapter weeks before the actual launch date. Generally, the secondary payloads are given permission to be powered on and deployed once the launch vehicle has successfully completed its primary mission. This section lists the launch vehicles which have offered ride-share opportunities to small spacecraft in the last fifteen years. Table 10-2 summarizes these launch vehicles.

Product	Manufacturer	LEO Capacity	Description	Number of Secondary Payloads Launched to Date	Launch Method	TRL Status
Antares	Orbital Sciences	5000 kg	2-stage, liquid + solid	>4	Land	9
Anriane 5	European Space Agency	20000 kg	2-stage, all liquid (+solid boosters)	4	Land	9
Atlas V	United Launch Alliance	19000 kg	2-stage, all liquid (+solid boosters)	>47	Land	9
Delta II	United Launch Alliance	3470 kg	2/3-stage, all liquid	> 16	Land	9
Delta IV	United Launch Alliance	28000 kg	2-stage, all liquid (+solid boosters)	3	Land	9



Dnepr	Yuzhny Machine-Building Plant	4500 kg	3-stage, all liquid	>122	Land	9
Falcon 9	Space Exploration Technologies	13150 kg	2-stage, all liquid	>19	Land	9
H-HA/B	Mitsubishi Heavy Industries	10000 kg/16500 kg	2-stage, all liquid (+solid boosters)	>42	Land	9
Long March	China Academy of Launch Vehicle	11200 kg	3-stage, all liquid	>46	Land	9
Minotaur-C	Orbital Sciences	1320 kg	4-stage all solid	10	Land	9
PSLV	Indian Space Research Organization	3250 kg	4-stage, solid & liquid	200	Land	9
Rokot	Eurockor Launch Services	1950 kg	3-stage, all liquid	>8	Land	9
Soyuz	OKB-1, TsSKB-Progress	7800 kg	3-stage, all liquid (+liquid boosters)	>37	Land	9
Vega	European Space Agency	1500 kg	3+1 stage, solid & liquid	>15	Land	9



Figure 10.6: Antares launch. Image courtesy of Northrop Grumman Innovation Systems.

Antares

The Antares (Figure 10.6), known as Taurus II during its early development, made its inaugural flight in 2013. It carried four CubeSats (three Phonesats from NASA Ames and one Dove from Planet Labs). After this demonstration flight, the vehicle had three successful flights to ISS with its primary payload, the Cygnus Cargo Vehicle, on board. The vehicle had a catastrophic failure during its launch on, 2014, with Arkyd-3 spacecraft (Planetary Resources) and a RACE CubeSat (NASA JPL/UT-Austin CubeSat) on board. Since 2015, the Antares has been used for ISS resupply missions and crew exchanges.

Ariane 5

Ariane 5 (Figure 10.7) is a European heavy lift launch vehicle to deliver payloads into geostationary transfer orbit (GTO) or LEO. Although Ariane 5 is a workhorse for Europe, there have been very few secondary missions in the past atop this vehicle. The first example was Amsat P3D, a 400 kg amateur radio spacecraft, which was injected into a highly elliptical orbit in 2000. The SMART-1 spacecraft (367 kg) was flown as a secondary payload into geostationary transfer orbit in 2003, and then traveled to lunar orbit using its own propulsion system. In 2009, two demonstration spacecraft for the SPIRALE infrared warning system, each weighing 120 kg, hitched a ride to an elliptical equatorial orbit. The Ariane 5 is able to carry up to eight 100 kg (standard) payloads or four 180 kg (banana) payloads on its Ariane Structure for Auxiliary Payload (ASAP) platform (Leschly, Sprague and Rademacher 1999). Since the SPIRALE launch, the Ariane 5 hasn't lifted any small satellites as secondary payloads.



Figure 10.7: Ariane 5. Image courtesy of ESA/CNES/Arianespace-Photo Optique Video CSG.

Atlas & Delta

The Evolved Expendable Launch Vehicle (EELV) program's boosters, the Atlas and Delta, have been common secondary launchers for small spacecraft programs to date. The EELV Secondary Payload Adapter (ESPA ring) has flown everything from larger payloads like the NASA Lunar Crater Observation and Sensing Satellite (LCROSS) mission to several CubeSats in Poly Picosatellite Orbital Deployers (P-PODs).

The Atlas V (Figure 10.8) can deliver from 9,800 kg to almost 19,000 kg into a 200 km LEO orbit at 28.7° inclination, depending on configuration. Starting with its maiden launch in August, 2002, the vehicle has had a near-perfect success rate. The vehicle has carried more than thirty secondary payloads to orbit to date. On May 5, 2018, the Atlas V successfully launched the MarCO-A and MarCO-B 6U CubeSats on a hyperbolic orbit towards Mars (United Launch Alliance 2018).



Figure 10.8: Atlas 5. Image courtesy of NASA.



Figure 10.0.9: Delta II. Image courtesy of NASA.

The Delta II (Figure 10.9) can deliver from approximately 1,870 kg to 3,470 kg to LEO depending on configuration (United Launch Alliance LLC, 2015). In 2000 the 6 kg Munin (Swedish Institute of Space Physics), and in 2003 the 64 kg Chipsat (NASA) and the 28 kg XSS 10 (AFRL), were launched atop a Delta II. Also in 2011, the vehicle carried five CubeSats as a part of NASA's ELANA program. In 2017, a Delta II carried five CubeSats to LEO as secondary payloads (United Launch Alliance, 2017). The final Delta II launch occurred Fall 2018 and will carry an additional three CubeSats to LEO (Blumberg 2018). Another member of the family, the Delta IV, can deliver from 9,200 kg to over 28,000 kg to a 200 km LEO at 28.7° inclination depending on configuration (United Launch Alliance LLC 2015).

The vehicle carried AFRL's 70 kg ANGELS spacecraft as a secondary payload in 2014. The Delta IV Heavy is the most powerful member of the family with a 29,000 kg carrying capacity to LEO. In 2004, the vehicle allowed a ride for AFRL's two Nanosat-2 spacecraft (23 kg each).

Dnepr

The Dnepr launch vehicle had its first flight in 1999 and has had twenty successful launches since then. The baseline version can lift 3600 kg into a 300 km LEO at 50.6° inclination, or 2300 kg to a 300 km SSO at 98.0° inclination. This Russian vehicle has been used extensively by secondary payloads since its first flights. It has carried more than 120 small spacecraft (200 kg or less) to date. In 2007, the vehicle launched thirteen small spacecraft (each less than 35 kg) together with one 165 kg satellite. In November, 2013, it carried 32 spacecraft into orbit, 30 of which were satellites weighing less than 150 kg (including 23 CubeSats). In June 2014, it carried 37 spacecraft into orbit, 36 of which were satellites weighing less than 185 kg (including 26 CubeSats).

Falcon 9

The Falcon family of rockets from Space Exploration Technologies (SpaceX) is proving to be another valuable asset to the small spacecraft community. SpaceX's most used launcher is the Falcon 9 (Figure 10.10), a two-stage LOX/RP-1 vehicle capable of lifting over 13,000 kg to LEO (Space Exploration Technologies Corp 2015). SpaceX's contracts with NASA to provide cargo services, and eventually crewed missions, to the ISS means opportunities to ride-share will continue into the future. Of all the 19 launches to date, 17 have been fully successful. Although quite capable, the Falcon 9 has not carried many secondary payloads. It launched eight CubeSats together with its primary Dragon payload only during its second mission in 2010. However, aboard the Dragon module, it carried many CubeSats to the ISS, which were sent into space from deployers at the station.



Figure 10.0.10.0: Falcon 9. Image courtesy of SpaceX.

H-IIA/B

The H-IIA/B are two Japanese launch systems. The H-IIA (Figure 10.11) first flew in 2001 and has been launched 28 times since 2015, with only a single failure. HII-B performed its maiden flight in 2009, and has five successful launches since then. HII-A is able to



Figure 10.0.11: H-IIA. Image courtesy of JAXA.

carry 15000 kg to LEO whereas HII-B can carry up to 16500 kg to this orbit (Japan Aerospace Exploration Agency, 2015).

During its launches, HII-A carried more than 25 small spacecraft into orbit, seven of which were CubeSats. HII-B has not yet directly injected any payloads to orbit, but it carried fourteen CubeSats aboard the HTV in 2012, 2013, 2015, and 2016; these spacecraft were deployed by the Kibo module of the ISS. Since the system is operational, the TRL is 9.

Long March

The Chinese Long March family (Figure 10.12) has historically not been very active for flying secondary payloads, however the new members of the family, Long March

6 and Long March 11, lifted 25 small spacecraft in 2015, at weights ranging from 1.5 kg to 130 kg. Since then, the rate at which the Long March family is launching small satellite has accelerated greatly. The new Long March 5 and Long March 7 have both completed successful CubeSat launches in 2016 and 2018 (Barbosa 2018).



Figure 10.12: Long March. Image courtesy of CALT.

Minotaur-C

First launched in 1994, Minotaur-C (Figure 10.13) has had seven successful launches and three failures to date. The last successful flight of the vehicle was in 2004. The first launch to include small spacecraft occurred on October 31st, 2017, which lifted six 100kg Planet Labs SkySats and four other CubeSats (S. Clark 2017). The vehicle's TRL is 9.



Figure 10.13: Minotaur-C. Image courtesy of OSC.



Figure 10.14: PSLV. Image courtesy of ISRO.

PSLV

The Polar Satellite Launch Vehicle (PSLV) (Figure 10.14) is a launch system developed and operated by the Indian Space research Organization. The vehicle had thirty launches since its maiden flight in 1993, 28 of which were successful. To date, the vehicle has carried more than 200 small spacecraft as secondary payloads of various sizes into orbit. The most notable launch to date occurred in 2017, when 103 individual CubeSats were launched on a single PSLV (Prasanna 2017).

Rocket

Rocket (Figure 10.15) is a Russian space launch vehicle that can launch a payload of 1,950 kg into a 200 km LEO with 63° inclination. The system had its first orbital mission in 1994 followed by 25 missions, three of which fully or partially failed. The only mission on which Rocket carried secondary payloads was in 2003, when the vehicle launched six CubeSats and two 65 kg small spacecraft.



Figure 10.15: Rocket. Image courtesy of russianspaceweb.com.



Soyuz

Soyuz (Figure 10.16) is a Russian launch vehicle family with substantial mission heritage, and is currently the only man-rated launcher to the ISS. The first Soyuz had its maiden flight in 1966. With the retirement of Soyuz-U in 2015, only two variants of the family are now in use: Soyuz-FG and Soyuz-2. Dedicated to manned launches, since its first flight in 2001, Soyuz-FG has only once carried secondary payloads, delivering three small spacecraft to orbit during a mission in July, 2012. Soyuz-2, on the other hand, has lifted more than 30 secondary payloads.

Figure 10.16: Soyuz. Image courtesy of Arianespace.

Vega

The first Vega (Figure 10.17) lifted off in 2012, from French Guiana carrying eight small spacecraft (ALMASat 1, e-st@r, Goliat, MaSat-1, PW-Sat, ROBUSTA, UniCubeSat-GG, and XaTcobeo). The second mission in 2013 carried one CubeSat (ESTCUBE 1) and two other small spacecraft (Vnredsat 1 and Proba V). The vehicle has had three more successful launches, but none of them contained small spacecraft. Vega launched four Skysat payloads in 2016 (Gebhardt 2016).



Figure 10.17: Vega. Image courtesy of Arianespace.

10.2.4 Dedicated Ride-Share

A dedicated ride-share is a mission where a third-party integrator purchases an entire launch from a launch vehicle provider and then contracts, manifests, and integrates multiple small spacecraft on that mission in the absence of a primary payload. With this approach, small spacecraft providers do not have to adhere to a primary payload's mission requirements, and affords the small spacecraft more control over mission parameters. Dedicated ride-shares are expected to increase the number and frequency of launch opportunities for small spacecraft, while at the same time, provide the cost benefit of sharing the launch cost and capacity of a single mission. Until now, only two companies have announced dedicated ride-share contracts, but more missions of this type will likely follow.

Spaceflight Services

The company purchased a SpaceX Falcon 9 rocket for its first dedicated ride-share mission to SSO in late 2018. This launch was named the "Sun Synch Express." The mission manifest included more than twenty spacecraft ranging from 3U CubeSats up to 575 kg spacecraft (J. Foust, "Spaceflight Industries Buys Falcon 9 Launch," 2015).

TriSept Corporation

TriSept Corporation will be another integrator offering dedicated ride-share missions with its FANTM-RIDE system. The schedule of the first dedicated flight is not officially announced according to the main page of the FANTM-RiDE website (Xtenti 2017).

10.2.5 Orbital Maneuvering Systems

One of the main disadvantages of riding as a secondary payload (even on a dedicated ride-share mission) is the inability to launch into your desired orbit. The primary payload determines the orbital destination, so the secondary payload orbit usually does not perfectly match the customer's needs. However, by using a space tug, secondary payloads will be able to maneuver much closer to their desired orbits.

SHERPA

Shuttle Expendable Rocket for Payload Augmentation (SHERPA) (Figure 10.18), developed by Spaceflight Services, is a free-flying space tug, which is able to maneuver a 1500 kg payload. The system features five 61 cm diameter ports, each capable of carrying payloads weighing up to 300 kg.



Figure 10.18: SHERPA. Image courtesy of Spaceflight Industries.

The system includes the ESPA ring from Moog CSA Engineering, the QuadPack CubeSat deployer from Innovative Solutions in Space, LightBand from Planetary Systems Corporation as the separation system for non-containerized spacecraft, the launch vehicle separation system from RUAG, and the command and data handling subsystem from Andrews Space. The first mission that was scheduled for Q4 2018 was cancelled due to Falcon 9 delays. All of the SHERPA satellites were rebooked on different launches including Spaceflight's dedicated SSO-A which launched September, 2018. Although the SHERPA has never launched, it is fully functional and may be used in the future (J. Foust 2017).

To perform LEO altitude shifts, maneuvers to geosynchronous transfer orbits, or and trans-lunar injection orbits, the upcoming variants of the system will incorporate a propulsion system, solar arrays, and an attitude determination and control system. The propulsion system will be able to supply a maximum of $2200 \text{ ms}^{-1} \text{ dV}$ for orbit change maneuvers. The solar arrays will be able to offer 50 W of power to each of the five ports. The company is also planning to have multiple SHERPA rings on a single launch vehicle in the future (European Space Agency 2015).

EAGLE

Additionally, Moog has partnered with Orbital ATK to produce the ESPA Augmented Geostationary Laboratory Experiment (EAGLE) spacecraft. This spacecraft uses the ESPA SUM ring to carry CubeSat-sized experiments, while having its own RF communications, ADCS and power generation. The EAGLE was launched on an Atlas V rocket on April 14, 2018 with five air force payloads attached (D. K. Gunter 2018).

10.2.6 Orbital and Suborbital Rides

Besides launching or deploying payloads into orbit, there are also opportunities for customers to fly their experiment for shorter durations on suborbital flights, and for customers who want to

recover their experiment after it has been exposed to the space environment for a period of time. Various companies and systems have developed to also serve these needs.

Nanoracks Internal Payloads

NanoRacks offers an in-orbit system that provides payload opportunities on the International Space Station using the CubeSat form factor. The company has different microgravity experiment opportunities at the U.S. National Lab on the ISS, such as Nanohubs, NanoRacks Platform-3 (Figure 10.19), NanoRacks Centrifuge, NanoRacks Microscope, and NanoRacks MixStix. Each of these systems offers different test opportunities under microgravity conditions (NanoRacks LLC 2015).



Figure 10.19: NanoRacks Platform 3 image with centrifuge housing. Image courtesy of Nanoracks.

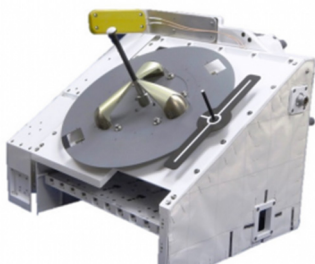

Figure 10.20: NanoRacks External Payload Platform. Image courtesy of Nanoracks.

Nanoracks External Platform (NREP)

This system is able to accommodate up to nine 4U CubeSat-size payloads outside of the International Space Station, with direct exposure to the space environment, for a standard mission duration of fifteen weeks. Attached to ISS, the system allows for high data rates, access to station power and data, payload return, risk mitigation, and frequent service for its customers. It can be used for various applications such as sensor testing, biological testing, flight qualification, and materials testing. The NREP (Figure 10.20) was launched to the ISS in 2015, was operational in 2016 (NanoRacks LLC 2016).

Terrestrial Return Vehicle (TRV)

The Terrestrial Return Vehicle (Figure 10.21) is a commercial service being developed by Intuitive Machines and NASA and return payloads from the ISS back to Earth. The system is designed to be stored in the habitable volume of the ISS until required. When loaded up with its cargo, it will be deployed from the Japanese Experiment Module (JEM) airlock and make a controlled reentry using its guidance and propulsion systems. Finally, the craft's airfoil is deployed and it touches down at its designated spaceport. The first re-entry flight of the TRV from the ISS was scheduled for 2016 (Intuitive Machines LLC, 2015), however the current status is unknown.



Figure 10.21: Terrestrial Return Vehicle Concept. Image courtesy of Intuitive Machines



10.2.7 Dispensers for CubeSats

The CubeSat form factor is a very common standard for spacecraft smaller than 10 kg and a number of well-established dispensers and adaptors exist for them. This section is focused on integration systems for the CubeSat architecture. The dispensers are summarized in Table 10-3.

Table 10-3: Small Spacecraft Dispensers		
Product	Manufacturer	TRL Status
P-POD	Spaceflight Industries	9
DPOD	D-Orbit	6
T-POD	University of Tokyo	9
X-POD	UTIAS Space Flight Laboratory	9
ISIPOD	ISIS	9
J-SSOD	Japan Aerospace Exploration Agency (JAXA)	9
Rocket POD	Ecliptic Enterprises	9
NLAS	NASA Ames Research Center	9
NPSCul	Naval Postgraduate School	9
Canisterized Satellite Dispenser (CSD)	Planetary Systems Corporation	9
AFT Bulkhead Carrier	United Launch Alliance	9
C-adapter platform	United Launch Alliance	9
Albapod	Alba Orbital	6
PSL-P Satellite Launch Pack	Astro-und Feinwerktechnik Adlershof GmbH	9

P-POD

The CubeSat form lends itself to container-based integration systems. While several systems exist, the standard deployer is the Poly Picosatellite Orbital Deployer, or P-POD.

The P-POD (Figure 10.22) is a rectangular aluminum container which can hold up to 100 x 100 x 340 mm of deployable spacecraft, either three 1U CubeSats or one 3U CubeSat, or a mix of intermediate sizes. The container acts as a Faraday cage, so hosted payloads meet electromagnetic compatibility (EMC) standards. Deployment is achieved by a pusher plate and spring ejection system. The main driver spring is aligned with the central axis of the P-POD. If more than one spacecraft is loaded, additional spring plungers placed between CubeSats are used to provide initial separation between payloads. The interior is anodized with a PTFE-impregnated solution to ensure smooth deployment. The tubular design of the P-POD prevents rotation of the CubeSat during ejection, ensuring linear trajectories. The exit velocity of the CubeSat is designed to be 1.6 ms⁻¹, though the central spring may be replaced to achieve different exit velocities. Typically, P-PODs are connected to a larger secondary payload interface, and not directly to the launch vehicle.

The P-POD, with TRL 9, has an extensive heritage on several launch vehicles (Atlas V, Delta II, TaurusXL, Minotaur I & IV, Falcon 1 & 9, Vega, Dnepr, Rokot) deploying of over one hundred CubeSats with 100% success rate (J. Puig-Suari 2015).

NanoRacks CubeSat Deployers

NanoRacks CubeSat Deployer (NRCSD) is a system to deploy CubeSats into orbit from the Japanese Experiment Module of the ISS. The NRCSD (Figure 10.23) is a rectangular tube that consists of anodized aluminum plates, base plate assembly, access panels, and deployer doors. The NRCSD deployer doors are located on the forward end, the base plate assembly is located on the aft end, and access panels are provided on the top. The CubeSats are ejected using a spring and plunger combination at the rear of the deployer. Each NRCSD is capable of holding 6U of CubeSats, and the system can deploy 48U during a full airlock cycle (NanoRacks LLC 2015); (National Aeronautics and Space Administration 2015).

Recently NanoRacks developed a new dispenser, the NanoRacks External Cygnus Deployer (ENRCSD), which is attached to the outside of the Cygnus service module and has successfully deployed 15 CubeSats (NanoRacks 2018).



Figure 10.22: P-POD. Image courtesy of California Polytechnic State University.

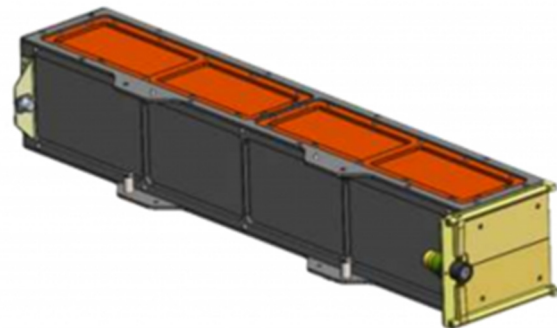

Figure 10.23: NanoRacks CubeSat Deployer. Image courtesy of Nanoracks.

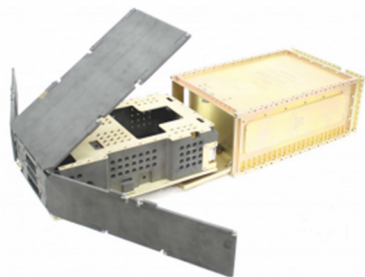

Figure 10.24: Canisterized Satellite Dispenser. Image courtesy of Planetary Systems Corporation.

Canisterized Satellite Dispenser (CSD)

The Canisterized Satellite Dispenser (Figure 10.24) is a deployment mechanism developed by Planetary Systems Corporation for small secondary or tertiary payloads. It supports 3U, 6U, 12U and 27U form factors from 1-30 kg (Planetary Systems Corporation 2015).

Nanosatellite Launch Adapter System (NLAS)

NLAS (Figure 10.25) was developed by NASA Ames Research Center and the Operationally Responsive Space Office of the United States Air Force. This is a secondary payload adapter system as well as a deployer. It is composed of a 6U deployer, an adapter structure, and a sequencer. The NLAS adapter structure is able to deploy 24U of CubeSats. The system is designed to deploy 1U, 1.5U, 2U, 3U and 6U spacecraft into orbit. Each dispenser can accommodate a total payload weight of up to 14 kg. To increase the number of secondary payloads, multiple NLAS wafers can be stacked on the launch vehicle.

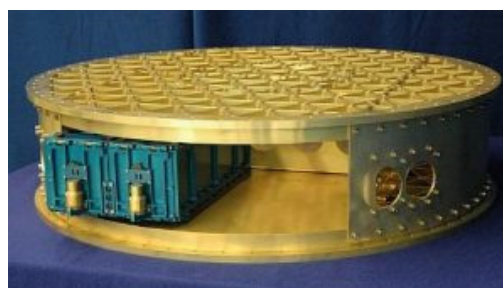

Figure 10.25: NLAS. Image courtesy of NASA Ames Research Center.

Cubestack

CubeStack, developed by Moog CSA Engineering and LoadPath LLC, is similar to the NASA Ames Nanosatellite Launch Adapter System (NLAS) to launch CubeSats in a wafer configuration. Like NLAS,



Figure 10.26: Cubestack. Image courtesy of MOOG CSA Engineering, LoadPath.

CubeStack

accommodates eight 3U dispensers, four 6U dispensers, or other combinations of 3U and 6U dispensers. CubeStack is compatible with the Minotaur, Athena, Taurus, Pegasus and Falcon launch vehicles. The dispenser (Figure 10.26) was used on the ORS-3 mission in November, 2013 (Moog Inc. 2015).

ESPA Six-U Mount (SUM)

The ESPA Six-U Mount, developed by Moog CSA Engineering, mounts a pair of 3U CubeSats or a single 6U CubeSat on an ESPA ring port (Figure 10.27). The CubeSats are tertiary payloads that share the port with a secondary spacecraft and deploy after secondary separation. One 6U or two 3Us can be deployed from each port. Up to six SUMs can be included on an ESPA ring.



Figure 10.27: ESPA SUM. Image courtesy of Moog CSA Engineering.

FANTM-RiDE

The FANTM-RiDE small spacecraft dispenser (Figure 10.28) is developed by TriSept Corporation and Moog CSA. It deploys CubeSats from an ESPA ring compatible volume (610 x 610 x 710 mm). Both 3U and 6U spacecraft can be attached along interior dispenser walls, leaving space for a central spacecraft. It is compatible with multiple vehicles and adapters, and is designed to be mass tuned, meaning that it maintains the same mass properties regardless of its contents. This property allows for late schedule additions or removals from the launch schedule without affecting coupled load analyses. The integration services of the system are provided by TriSept Corporation (Lim 2015).

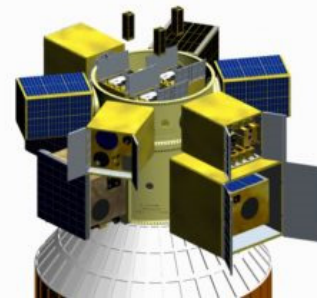

Figure 10.28: FANTM-RiDE. Image courtesy of MOOG CSA Engineering, TriSept Corporation.



Figure 10.29: Tyvak 6U Rail-POD Dispenser. Image courtesy of Tyvak Nano-Satellite Systems LLC.

Rail-POD

The Rail-POD (Figure 10.29) is a dispenser developed by Tyvak to deploy 1U, 3U and 6U spacecraft, with a smaller mass penalty. Thus it is targeted at smaller launch vehicles with tighter mass margins.

RocketPod

Ecliptic Enterprises develops on-board imaging systems for use with rockets, spacecraft, and other remote platforms. However, the company also provides cost-effective space-access solutions for small space payloads. Rocket Pod carries CubeSat secondary payloads on the exterior of rockets. The device may also be mounted on the interior of the payload fairing or on adapter rings such as ESPA or CAP. Ejection is achieved via a spring-loaded mechanism like the P-POD dispensers.

Japanese Experiment Module Small Satellite Orbital Deployer (J-SSOD)

The J-SSOD was the first dispenser to deploy small spacecraft from the International Space Station. It holds up to three 1U CubeSats per case, six in total, though other sizes up to 550 x 550 x 350 mm size may also be used. The system is able to deploy 6U during a full airlock cycle. The system was first used in 2012, deploying the RAIKO, FITSAT-1, WE WISH, NanoRacks CubeSat-1/F-1 and TechEdSat CubeSats.

Naval Postgraduate School CubeSat Launcher (NPSCuL)

The NPSCuL (Figure 10.30) is an adapter that can attach multiple P-PODs to a single ESPA slot. There are two varieties of NPSCuL, Standard and Lite. NPSCuL-Standard has ten slots for 3U or 5U dispensers. Additionally 6U dispensers can be accommodated by using two adjacent 3U slots. NPSCuL-Lite has eight slots which can similarly accommodate 3U or 6U dispensers.



Figure 10.30: NPSCuL and NPSCuL-Lite. Image courtesy of Naval Postgraduate School.



ISIPOD

ISIPOD (Figure 10.31), developed by ISIS, is a launch adapter for small spacecraft that adheres to the CubeSat interface standard. The system is able to deploy 1U, 2U, 3U and 12U CubeSats (ISISpace 2018).

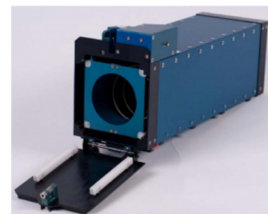
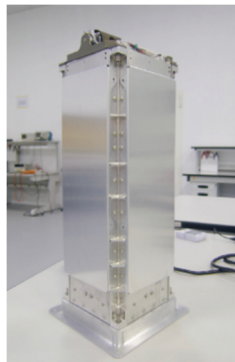

Figure 10.31: ISIPOD. Image courtesy of ISIS BV.



DPOD

DPOD (Figure 10.32) is a CubeSat launch adapter developed by D-Orbit. It can be configured in many different sizes, from 3U up to 16U satellites, and is built to deploy from the ISS. As part of their DPOD launch service, D-Orbit will provide everything from launch acquisition to payload integration and deployment. DPOD will be flown in Q3 2019 and as such is TRL 6 (D-Orbit 2018).

ION

Figure 10.32: DPOD. Image courtesy of D-Orbit.

D-Orbit has also developed an independent CubeSat carrier named ION (Figure 10.33). ION has its own power, attitude control, thermal control, and command and data handling subsystems. ION holds up to 48U of CubeSats with a density of 2 kg/U. ION also uses a “Fast Dispersion” technique to decrease the deployment time of CubeSat constellations by 85%. ION will fly in Q3 of 2019 and has a TRL of 6 (D-Orbit 2018).



Figure 10.33: ION. Image courtesy of D-Orbit.

XPOD

X-POD (Figure 10.34) was developed by University of Toronto Institute for Aerospace Studies Space Flight Laboratory and is a CubeSat deployer for 1U, 2U, and 3U CubeSats. The maiden flight of the system was in 2008 on a PSLV launch.



Figure 10.34: XPOD. Image courtesy of UTIAS/SFL.

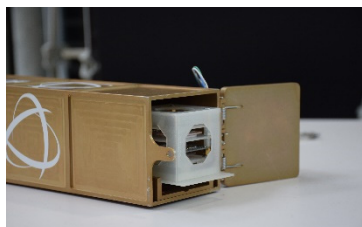

Figure 10.35: Albapod holding 2P PocketQube. Image courtesy of Alba Orbital.

Albapod

For PocketQubes, Alba Orbital has developed a 6P and a 96P deployer that is capable of holding 2 to 30 3P units respectively (see Complete Spacecraft Platforms for more about PocketQubes).

The Albapod (Figure 10.35) uses a flight proven release mechanism to ensure performance in-orbit, and will be launched in 2019 with a UniSat-7 microsatellite on a Dnepr rocket.

PSL-P Satellite Launch Pack

There are several CubeSat deployer options at Astro-und Feinwerktechnik Adlershof called the CubeSat Deployer PSL family: the single picosatellite launcher (SPL), Double Picosatellite Launcher (DPL) and Triple Picosatellite Launcher (TPL). These deployers have 1U, 2U and 3U combinations, and have all been space proven in LEO since 2013 (Astro-und Feinwerktechnik Adlershof GmbH 2018). Recently, they have developed a multi-deployment mechanism for

CubeSats, called the PSL-P Picosatellite Launch Pack that can hold a total CubeSat mass of 20 kg in various configurations from 1U, 2U, 3U to 12U. The PSL6U and PSL-16U systems are currently under development.

10.2.8 Other Adapters for Small Spacecraft

Non-CubeSat payloads have fewer available integration systems, since integration systems in this class are usually custom designed for specific missions. This section lists larger adapters available for small spacecraft.



Figure 10.36: ESPA Ring. Image courtesy of Moog CSA Engineering.



Figure 10.37: ESPA Grande Ring. Image courtesy of Moog CSA Engineering, Orbcomm.

EELV Secondary Payload Adapter (ESPA)

The ESPA ring (Figure 10.36) is a multi-payload adapter for large primary spacecraft developed by Moog CSA. Six 61 cm-diameter ports can support six auxiliary payloads up to 318 kg each. It was used for the first time on the STP-1 mission in 2007. The LRO/LCROSS (2009), OG2 Constellation 1 (2014), AFSPC-4 (2014), and OG2 Constellation 2 (2015) missions followed. The ESPA Grande (Figure 10.37) is a 38 cm version of the ESPA adapter. It can carry four 181 kg payloads.

AFT Bulkhead Carrier (ABC)

When redesigning the Atlas V Centaur upper stage pressure system, the Office of Space Launch (OSL) replaced three helium tanks with two larger tanks leaving a volume of 508 x 508 x 762 mm at the aft end of the upper stage. OSL seized the opportunity to convert this excess volume into secondary payload space. This location offers several advantages despite its proximity to the upper stage thruster. In particular, the secondary payload is completely isolated from the primary, thereby relaxing electromagnetic interference and contamination concerns of the primary payload. The adapter carries up to 80 kg using the plate and struts

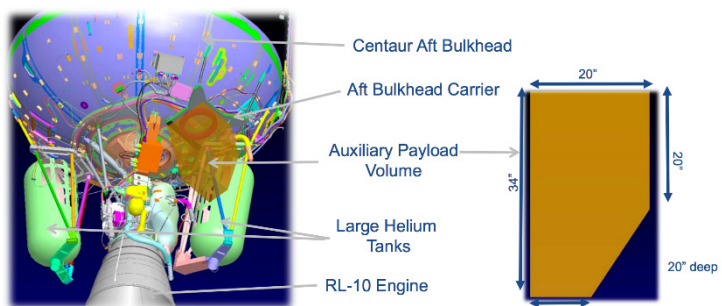

Figure 10.38: ABC. Image courtesy of National Reconnaissance Office.

previously used to house the helium tank. ABC (Figure 10.38), which made its first flight in 2010, can launch up to 24 CubeSats to orbit.

C-Adaptor Platform (CAP)

The C-Adapter Platform (Figure 10.39), developed by Adaptive Launch Solutions, is a cantilevered platform capable of carrying up to 45 kg in a volume of 230 x 310 x 330 mm. The platform is attached to a C-adapter ring via a 203 mm clampband and is compatible with Atlas V and Delta IV launch vehicles. C-rings, mounted in the forward adapter of the Centaur upper stage, are essentially large aluminum rings used as an interface between payload integration systems and ground support equipment. Four CAPs can be integrated per C-adapter. Each cap has a carrying capacity of 90 kg. The first flight of the system was in 2010.

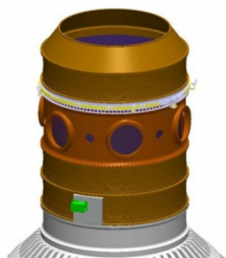

Figure 10.40: AQUILA.
Image courtesy of ULA.

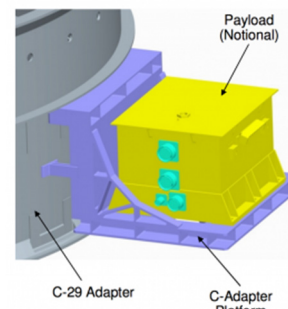

Figure 10.39: CAP. Image courtesy of ULA.

AQUILA

The Aquila adapter (Figure 10.40), developed by Adaptive Launch Systems, supports a primary payload mass of up to 6350 kg. It can be used with Atlas V and Delta IV launch vehicles.

10.2.9 Separation Systems

While many separation systems like the POD deployers make use of a compressed spring mechanism, band systems are also quite common. Lightband and Marman clamp separation systems are widely used, particularly for larger spacecraft. Lightband (Figure 10.41), is a motorized separation system that ranges from 203 mm to 965 mm in diameter. Smaller Lightband systems are used to deploy ESPA class spacecraft, while larger variations may be used to separate the entire ESPA ring itself. Lightband's motorized separation system eliminates the need for pyrotechnic separation, and thus deployment results in lower shock with no post-separation debris. Marman band separation systems use energy stored in a clamp band, often along with springs, to achieve separation. The Marman band is tensioned to hold the payload in place. Sierra Nevada produces a Marman band separation system known as Qwksep, which uses a series of separation springs to help deploy the payload after clamp band release. Depending on the launch vehicle, separation systems may already be in place and available to secondary payloads.

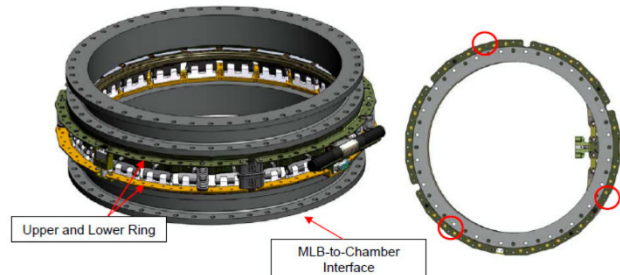

Figure 10.41: MkII Motorized Lightband. Image courtesy of Planetary Systems Corporation.

10.3 On The Horizon

10.3.1 Dedicated Launchers for Small Spacecraft

As the capabilities and numbers of small spacecraft increase, the traditional ride-share or piggyback approaches become less and less convenient. The surge in demand for launch opportunities has also stimulated the development of dedicated launchers for small spacecraft. Although many still have low TRLs, there are at least 23 new launcher projects for small spacecraft. Since 2015, two launch vehicles have moved to the state-of-the-art with Electron launching successfully and Bloostar receiving a prototype flight.

AU Launch Services

AU Launch Services, found in 2015, is an Adelaide-based Australian consulting group that works as an integrator between CubeSat manufacturers and overseas launch providers.

Austral Launch Vehicle-2

The Austral Launch Vehicle (ALV) (Figure 10.42 and Figure 10.43) is a partially reusable small spacecraft launch vehicle family. The project has been in development since 2011. The ALV project consists of four progressively more complex and expensive vehicles, starting from ALV-0 with ALV-3 being the commercial launch vehicle. The ALV is designed to launch vertically, and will deploy a swiveling, oblique wing and a nose-mounted piston engine after stage separation, flying back to the launch site as a large unmanned aerial vehicle (UAV). The ALV-2 design is modular, uses various combinations of boosters and upper stages, and can accommodate 3U (with one booster) to 27 U (with 6 boosters) payloads that conform to Planetary Systems' Canisterised Satellite Dispenser (CSD) specifications. First flight of the ALV-0 small-scale test vehicle was in 2015. The ALV-2 vehicle is currently in the conceptual design phase, with the first orbital flight expected in 2019. The company is running several other projects in parallel, including the development of LOX/Methane rocket engines.

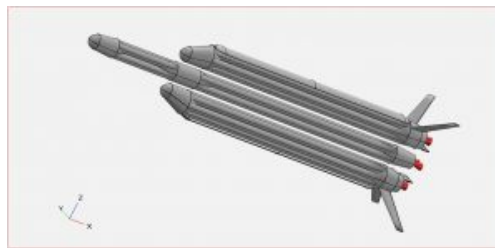

Figure 10.42: Austral Launch Vehicle Concept. Image courtesy of Heliq Advanced Engineering.

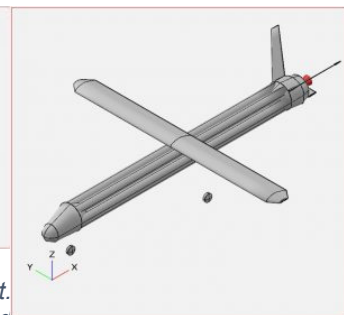

Figure 10.43: Austral Launch Vehicle Concept. Image courtesy of Heliq Advanced Engineering.

Aurora S

Aurora is a family of launch vehicles under development by Conspire Technology, an Alabama based company founded in 2013. The family will consist of three members: Aurora S, Aurora X, and Aurora Air. Aurora S is the two-stage small launch vehicle currently being developed to launch small spacecraft to orbit, whose first stage will be an air-breathing engine. The system will reach hypersonic velocities below 30 km altitude with no on-board oxidizer. Aurora S development is currently in the system-level design and development phase. Propulsion system hot-firing tests are planned between 2017 and 2019, with flight testing in 2022. The company aims to begin launch services in 2025 for a launch cost of \$4M. The technologies developed and demonstrated through Aurora S will then be scaled up for more powerful vehicles, Aurora X and Aurora Air, with greater payload capacity. The system is currently TRL 2-3 (Conspire Technology Inc., 2015).

CubeCab

CubeCab is a new company which aims to provide launches specifically for 1U and 3U CubeSats to 400 km polar orbit. The system will be released from an F-104 jet. The company aspires to launch 100 CubeSats per year by 2023, but is currently manufacturing their components, therefore the TRL of the system is 4 (Cubecab 2015).

Dedicated Nano Launch Vehicle (DNLV)

The DNLV (Figure 10.44) is a launch vehicle under consideration by Independence-X Aerospace in Malaysia. The vehicle will carry a 200 kg payload to a 500 km SSO. The first flight of the system is planned for 2019. The TRL of the system is 2 (Yamin 2015).



Figure 10.44: DNLV Concept. Image courtesy of Independence-X Aerospace.

DreamChaser

The Dream Chaser (Figure 10.45) was developed by Sierra Nevada Corporation Space Systems for both crew and cargo transportation to LEO. The vehicle will also be able to support satellite servicing and deployment missions. In 2017, the Dream Chaser completed a successful glide test. The craft was released from an altitude of 3,700m and landed at Edwards AFB (K. Chang 2017).



Figure 10.45: Dream Chaser Concept. Image courtesy of Sierra Nevada Corporation.

Firefly Alpha

FireFly Space Systems is a private aerospace firm based in Austin, Texas, that intends to launch small and medium-sized spacecraft to orbit. Their design, Firefly Alpha (Figure 10.46) is an all-composite vehicle designed to launch 400 kg payloads to LEO or 200 kg payloads to SSO. The system is propelled with two nearly-identical liquid LOX/methane stages. The first stage contains ten identical engine cores, which facilitates mass production (FireFly Space Systems 2015). The vehicle is slated for its first orbital launch in Q3 2019. The upgraded version, Firefly Beta, to be introduced at a later date, will use two strap-on boosters. Firefly Alpha is one of the three systems awarded CubeSat missions to LEO by NASA's Venture Class Launch Services (VCLS).



Figure 10.46: Firefly Alpha Concept. Image courtesy of Firefly Space Systems.

GOLauncher 2

GOLauncher 2 (Figure 10.47) was developed by Generation Orbit Launch Services and is an air launched two-stage rocket system using LOX/RP-1 as propellants. The system will be capable of placing payloads of up to 40 kg into LEO at 0° to 98.7° inclination. The system uses a Gulfstream business jet to carry its rocket up into high altitudes. A date for the first launch has not yet been set (Generation Orbit Launch Services Inc 2015); (Henry 2015).



Figure 10.47: GOLauncher System mounted underneath a Gulfstream jet. Image courtesy of Generation Orbit.

Haas 2CA

The Haas 2CA launch vehicle (Figure 10.48), currently under development by Arca Space Corporation, is a two-stage system fueled with liquid oxygen and kerosene. The company was originally established in 1999 as a non-profit organization in Romania. In 2004, as part of the Ansari X-Prize Competition, it successfully launched its first rocket. ARCA selected Spaceport America as their launch site, and launch activities are scheduled to start in 2016 (Arca Space Corporation 2015); (SpaceDaily 2015). However, in 2016, Arca received a \$3.4 million contract, changed the engine to a linear aerospike, and renamed the rocket the Haas 2CA (Haas 2CA ARCA 2018).



Figure 10.48: Haas 2CA System. Image courtesy of Arca Space Corporation.

LauncherOne

Virgin Galactic's LauncherOne development began in 2012 (Figure 10.49). The system, once released from its carrier Boeing 747 aircraft, will use two rocket engines for its orbital flights: the "NewtonThree" main stage engine, and the "NewtonFour" upper stage engine. The company has already performed a 90 second hot firing of the NewtonThree engine. Virgin Galactic recently



increased the launch capacity of the system to 400 kg to LEO and 200 kg to SSO (Virgin Galactic 2015). LauncherOne is one of the three systems awarded a CubeSat mission to LEO by NASA's Venture Class Launch Services (VCLS), and had a first test flight August, 2018 (Foust 2018).

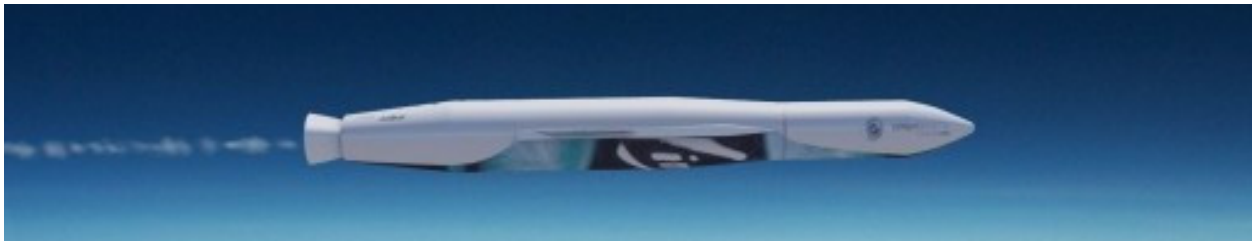

Figure 10.49: LauncherOne. Image courtesy of Virgin Galactic.

Microsat Launch Vehicle (VLM-1)

A partnership between Brazil and the German Space Agency (DLR) aims to develop a rocket for launching payloads of 150 kg into equatorial and polar orbits. The system, the VLM-1, is planned to have three stages of solid rocket motors (D. Messier 2015). The first test flight of the system is planned for 2019 which would raise the TRL to 5.

MOMO

Developed by the Japanese aerospace company Interstellar Technologies, the MOMO rocket is intended to serve as a mid-altitude sounding rocket. After reaching heights of 100 km with the payload, it will deploy a parachute to return back to Earth. Unfortunately, the first two launches of the MOMO rocket have been failures. Interstellar Technologies is continuing to develop this rocket (Nowakowski 2018). The TRL of the system is 4.

M-OV

M-OV (Figure 10.50) is an orbital launch vehicle developed by the Miami-based MISHAAL Aerospace Corporation founded in 2010. The vehicle intends to deliver spacecraft in the 363 kg to 454 kg class to LEO (MISHAAL Aerospace Corporation 2015).



Figure 10.50: M-OV. Image courtesy of MISHAAL Aerospace Corporation.

Nanosat Launch Vehicle (NLV)

The NLV (Figure 10.51) is a two-stage vehicle developed by Garvey Spacecraft Corporation. The company's initial goal is to deliver 10 kg payloads into a 250 km LEO. A larger version will then be designed to place spacecraft weighing up to 20 kg into a 450 km orbit (Garvey Spacecraft Corporation 2015); (Messie 2015). The vehicle will be launched from the Pacific Spaceport Complex Alaska (PSCA) on Kodiak Island (D. Messier, "Garvey Spacecraft to Conduct Flights Out of Alaska," 2015).



Figure 10.51: NLV concept. Image courtesy Garvey Spacecraft Corporation.

Neptune N5

The Neptune Modular Series are launch systems developed by Interorbital Systems. Different members of the family are assembled from identical Common Propulsion Modules (CPMs). A single CPM is able to lift 145 kg to a 310 km apogee on a sub-orbital trajectory. A dedicated launch will cost \$350k. The CPM test vehicle was flight-tested successfully on low-altitude flights in 2018. These flights carried several commercial payloads. The high-altitude test flights took place Fall 2018 (Interorbital Systems 2018).

The N5 (Figure 10.52) is an orbital launch vehicle with five CPMs and will lift a 30 kg payload to a circular polar orbit of 310 km. The first orbital launch was scheduled for Q4 2016 with a price tag of \$1M for a dedicated launch. The N7 is a four-stage launch vehicle assembled from seven CPMs and a solid upper stage. It has a maximum payload capacity of 60 kg to a polar, circular orbit of 310 km. Interorbital does not currently have an established launch date for the N5.



Figure 10.52: N5 Concept. Image courtesy of Interorbital Systems.

North Star Launch Vehicle (NSLV)

In January 2013, Nammo and the Andøya Rocket Range spaceport announced that they will be developing a three stage orbital CubeSat launch vehicle system called North Star (Figure 10.53) that will use a hybrid motor, clustered in different numbers and arrangements, and will be able to deliver a 20-25 kg spacecraft into a 250-350 km polar orbit. The first flight of NSLV is scheduled for 2021 from Andøya Rocket Range, Norway (Boiron, M. G. Faenza and Verberne 2015); (Nammo 2015); (Verberne, et al. 2015) (Martina G. Faenza 2017).

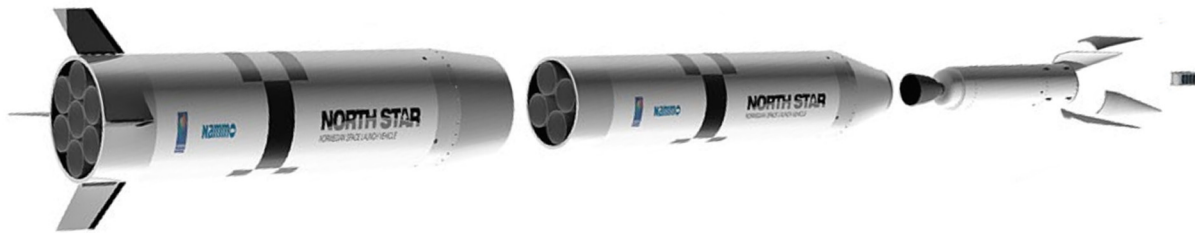

Figure 10.53: NorthStar Concept. Image courtesy of Nammo AS.

Sagittarius Airborne Launch System (SALS)

Celestia Aerospace, located in Barcelona, is developing the airborne Sagittarius Launch System. The system will be composed of the Mig-29UB jets as carrier planes, and the SpaceArrow rockets for the orbital injection phase. Each launch will be able to lift sixteen 1U sized CubeSats to space, either in a configuration of four CubeSats aboard a SpaceArrow SM rocket, or in a configuration of sixteen CubeSats aboard a single SpaceArrow CM rocket. The rocket will then deliver the payloads into orbits between 400 and 600 km altitude. Celestia originally intended to perform its maiden flight in 2016 from a Spanish airport, but was pushed back to an unannounced later date. (Celestia Aerospace 2017).

SALVO

A system is under development by Ventions LLC for DARPA's SALVO program. It will be capable of launching a single 5 kg 3U CubeSat at a time. The rocket will be carried to the required altitude with an F-15 jet.

Stratolaunch Air Launch System

The Stratolaunch Air Launch System (Figure 10.54) includes a carrier aircraft, a launch vehicle, and an integration system. The aircraft segment, which will be the largest aircraft ever built with a wingspan of 127 m, will be powered by six Boeing 747 engines to lift a multi-stage rocket up to 10 km. The production of this segment by Scaled Composites is ongoing, and the plane completed its first high speed taxi test in 2018. For the rocket segment, Vulcan Aerospace has selected Northrup Grumman Innovation systems (Baylor 2018). The TRL of the complete system is 4.



Figure 10.54: Stratolaunch Air Launch System. Image courtesy of Stratolaunch Systems.

Vector-H

Vector Launch Inc. is also developing a higher power version of their Vector-R rocket. This rocket, known as the Vector-H, has a higher payload capacity, and will lift 160 kg to 200 km and 95 kg to 450 km. The Vector-H uses 6 of the same LP-1 engines tested on Vector-R (Vector Launch Inc. 2018). The rocket as a whole has not seen the same type of flight testing as the Vector-R yet. As such, this rocket has a TRL of 4.

Vulcan

The Vulcan rocket (Figure 10.55) is a launch vehicle currently under development by United Launch Alliance (ULA). The vehicle will be powered by the BE-4 rocket engine currently under development by Blue Origin, with solid rocket boosters provided by Orbital ATK. The company plans to integrate an inflatable aerodynamic decelerator and parachutes to its first-stage boosters, which will allow midair capture and recovery of the boosters by helicopter. The system is scheduled to have its maiden flight in 2020 (Harwood 2018). According to ULA, the Vulcan will replace company's Atlas V and Delta IV launch vehicles in 2020s.

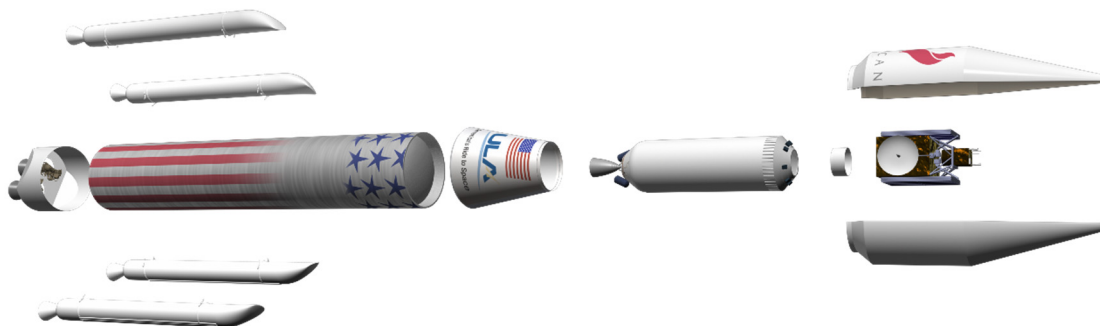

Figure 10.55: Vulcan. Image courtesy of ULA.

10.3.2 Payload Adaptors and Orbital Maneuvering Systems

Multi-payload Utility Lite Electric (MULE) Stage

The MULE Stage (Figure 10.56) was developed jointly by Busek Space Propulsion, Adaptive Launch Solutions, and Oakman Aerospace, and is an ESPA ring-based maneuvering system. The system, with onboard propulsion and power systems, will provide 10 ms^{-1} delta-V to deliver four 180 kg payloads to a variety of orbits and Earth Escape missions. The Stage is continuing development under ULA (Moses 2016). The TRL is currently 3.

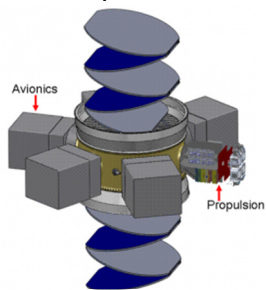

Figure 10.56: MULE Stage. Image courtesy of ULA.

HatchBasket

The HatchBasket (Figure 10.57), developed by Altius Space Machines in partnership with Nanoracks, is a concept that enables small spacecraft (up to forty 3U CubeSats from one ESPA-class spacecraft) to be launched to a higher altitude than is possible from normal ISS deployments. The HatchBasket, as the name suggests, would replace the conventional hatch. After the Cygnus cargo vehicle completes its mission at the ISS, it would maneuver to a higher altitude using propellant reserved for contingencies during the approach to the

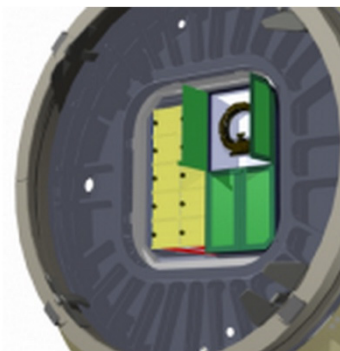

Figure 10.57: Hatchbasket. Image courtesy of Altius Space Machines.



station, then deploy the payloads. Cygnus could go up to altitudes of 500 km and still have enough propellant for deorbiting. There has been little development of HatchBasket in recent years. The TRL of the concept is currently 3.

Payload Assist Module for GSLV (PAM-G)

The PAM-G, under development by the Indian Space Research Organization, will be capable of lifting payloads to higher orbits after its separation from GSLV. It will be powered by a hypergolic liquid motor with restart capability, derived from PSLV's fourth stage.

10.4 Summary

A wide variety of integration and deployment systems exist to provide rideshare opportunities for small spacecraft on existing launch vehicles. While leveraging excess payload space will continue to be profitable into the future, dedicated launch vehicles and new integration systems for small spacecraft are becoming popular. Dedicated launch vehicles take advantage of rapid integration and mission design flexibility, enabling small spacecraft to dictate mission parameters. New integration systems will greatly increase the mission envelope of small spacecraft riding as secondary payloads. Advanced systems may be used to host secondary payloads on orbit, to increase mission lifetime, expand mission capabilities, and enable orbit maneuvering. In the future these technologies may yield exciting advances in space capabilities.

The previous few years have shown an increase in the number of available launch vehicles dedicated to small spacecraft. Additionally, there has been a trend to enlarge the nanosatellite classification to 12U, which has led to the design of deployer packs that include a various range of launch possibilities.

References

Adaptive Launch Solutions. 2015. "Launch Integration Service."

Aerjet Rocketdyne. 2015. "\Super Strypi."

Arca Space Corporation. 2015. "Haas 2C."

Astro-und Feinwerktechnik Adlershof GmbH. 2018. "*CubeSat Deployer*." Accessed 2018. <http://www.astrofein.com/astro-und-feinwerktechnik-adlershof/products/raumfahrt-eng/193/cubesat-deployer-eng/>.

Barbosa, Rui C. 2018. "Long March 11 launches multiple satellites." NASASpaceflight.com.

Baylor, M. 2018. "*Virgin Orbit Readies LauncherOne Rocket for Maiden Flight*." June 19. <https://www.nasaspaceflight.com/2018/06/virgin-orbit-launcherone-maiden-flight/>.

Blumberg, Sara. 2018. "*NASA's ICESat-2 Arrives at Launch Site*." June 13. <https://www.nasa.gov/feature/goddard/2018/nasa-s-icesat-2-arrives-at-launch-site>.

Boiron, A. J., B. Haemmerli, M. G. Faenza, O. Verberne. 2015. "Hybrid Rocket Motor Upscaling and Development Test Campaign at Nammo Raufoss." *51st AIAA/SAE/ASEE Joint Propulsion Conference*.



- Celestia Aerospace. 2017. "*Robert Lainé, Former Ariane Launcher Program Director, Joins Celestia Aerospace.*" May 15. <http://spaceref.com/news/viewpr.html?pid=50876>.
- Chang, Kenneth. 2017. "Dream Chaser Space Plane Aces Glide Test - The New York Times." November 11.
- Clark, Stephan. 2017. "Ten Commercial Earth-Observing Satellites Launched aboard Minotaur-C Rocket." Oct. <https://spaceflightnow.com/2017/10/31/ten-commercial-earth-observing-satellites-launched-aboard-minotaur-c-rocket/>.
- Clark, Stephen. 2018. "Rocket Lab Delivers Nanosatellites to Orbit on First Successful Test Launch." Spaceflight Now, January 21.
- Commercial Space Technologie. 2015. "Launch Integration Service."
- Conspire Technology Inc. 2015. "Aurora S Launch Vehicle Status – September 2015."
- Cubecab. 2015. "CubeSats to LEO."
- D-Orbit. 2018. "*D-Orbit Products - a Solution Matching Your Spacecraft Requirements.*" Accessed June 2018. www.deorbitaldevices.com/products/?slide=4.
- Emspak, Jesse. 2016. "*NASA Launches 8-Satellite Constellations to Track Hurricanes from Space.*" December 15. <https://www.space.com/35038-nasa-launches-cygnss-hurricane-satellites.html>.
- European Space Agency. 2015. "SHERPA Rideshare Mission."
- FireFly Space Systems. 2015. "FireFly Space Systems."
- Foust, J. 2015. "Spaceflight Industries Buys Falcon 9 Launch\."
- Foust, Jeff. 2017. "*SpaceX Delays Force Spaceflight to Find Alternative Launches.*" March 3. <https://spacenews.com/spacex-delays-force-spaceflight-to-find-alternative-launches/>.
- Foust, Jeff. 2018. "*Virgin Orbit performs LauncherOne aircraft flight tests.*" February 28. <https://spacenews.com/virgin-orbit-performs-launcherone-aircraft-flight-tests/>
- Garvey Spacecraft Corporation. 2015. "Nanosat Launch Vehicle (NLV)."
- Gebhardt, Chris. 2016. "*Vega Launches with Peru Sat-1 & SkySat 4, 5, 6, 7 Payload.*" September 15. <https://www.nasaspacesflight.com/2016/09/vega-launch-peru-sat-1-skysat-4-5-6-7-payload/>.
- Generation Orbit Launch Services Inc. 2015. "GOLauncher 2."
- Gunter, D K. 2018. "*EAGLE.*" *Gunter's Space Page - Information on Spaceflight, Launch Vehicles and Satellites.* space.skyrocket.de/doc_sdat/eagle.htm.
- Haas 2CA ARCA. 2018. "*Haas 2CA.*" www.arcaspace.com/en/haas2c.htm.



- Harwood, William. 2018. "ULA Touts New Vulcan Rocket in Competition with SpaceX." March 20. <https://spaceflightnow.com/2018/03/20/ula-touts-new-vulcan-rocket-in-competition-with-spacex/>.
- Henry, C. 2015. "Generation Orbit Gains GOLauncher 2 Commitments, Plans GOLauncher 3."
- Henry, Caleb. 2017. "Zero 2 Infinity Conducts First Flight Test of Boostar Balloon-assisted Launcher." March 17. <https://spacenews.com/zero-2-infinity-conducts-first-flight-test-of-boostar-balloon-assisted-launcher/>.
- Herridge, Linda. 2018. "Launch of NASA's ICON Satellite Postponed." June 8. <https://blogs.nasa.gov/icon/>.
- Innovative Solutions in Space B.V. 2015. "Launch Integration Service."
- Interorbital Systems. 2018. "NEPTUNE Liquid Upper-Stage Engine Flight Test 1." June 8. <http://www.interorbital.com/News%20Stories/NEPTUNE%20Liquid%20Upper-Stage%20Engine%20Flight%20Test%20063018>.
- Intuitive Machines LLC. 2015. "Terrestrial Return Vehicle."
- ISISpace. 2018. "ISIPOD CubeSat Deployer." <https://www.isispace.nl/product/isipod-CubeSat-deployer/>.
- Japan Aerospace Exploration Agency. 2015. "H-IIA Launch Vehicle."
- Leschly, K., G. Sprague, J. Rademacher. 1999. "Carrier Spacecraft Using Ariane-5 GTO Piggyback Launch." Vol. 45.
- Lim, D. 2015. "Trisept Response to NASA RFI for Inputs to the Small Spacecraft Technology State-of-the-Art Report."
- Martina G. Faenza, Adrien Boiron, Bastien Haemmerli, Solli Lennart, Terje Vesteras, Onno Verberne. 2017. "Getting Ready for Space: Nammo's Development of a 30 kN Hybrid Rocket Based Technology Demonstrator." *7th European Conference for Aeronautics and Space Sciences*.
- Messie, D. 2015. "Garvey Spacecraft Performs Successful Static Test at FAR."
- Messier, D. 2015. "Agreement Signed for Brazilian/German Microsat Launcher."
- . 2015. "Garvey Spacecraft to Conduct Flights Out of Alaska."
- MISHAAL Aerospace Corporation. 2015. "The M-OV Orbital Vehicle."
- Moog CSA Engineering. 2015. "Launch Integration Service."
- Moog Inc. 2015. "ESPA Ring & Payload Adapters."



- Moses, Dan. 2016. "Optimized Orbit for Secondary." March 1. https://smd-prod.s3.amazonaws.com/science-red/s3fs-public/atoms/files/Moses_Powered_ESPA_Ring.pdf.
- Nammo, AS. 2015. "The Responsive, Green, and Affordable Satellite Launch Service."
- NanoRacks LLC. 2015. "Launch Integration Service."
- . 2015. "Nonaracks – Internal Payloads."
- . 2015. "Smallsat Deployment."
- . 2016. "*NanoRacks External Platform Deployed Outside International Space Station*." August 9. <http://nanoracks.com/external-platform-deployed-outside-iss/>.
- NanoRacks. 2018. "*NanoRacks Launches 15 CubeSats, New Commercial Customers, on Latest Space Station Cargo Resupply Launch*." May 24. nanoracks.com/15-CubeSats-launched/.
- National Aeronautics and Space Administration. 2015. "NanoRacks CubeSat Deployer."
- National Aeronautics and Space Administration. 2015. "NASA Opens New CubeSat Opportunities for Low-Cost Space Exploration."
- Nowakowski, Tomasz. 2018. "*Interstellar Technologies Continues Work on Its Own Rocket Despite MOMO-2 Launch Failure*." Accessed July 23, 2018. phys.org/news/2018-07-interstellar-technologies-rocket-momo-failure.html.
- Orbital ATK. 2015. "Minotaur."
- Planetary Systems Corporation. 2015. "Planetary Systems Corporation."
- Prasanna, Laxmi Ajai. 2017. "*ISRO Centres Set for the Record Launch of 104 Satellites at One Go by February 15*." *The Times of India, India*. January 29. timesofindia.indiatimes.com/home/science/isro-centres-set-for-the-record-launch-of-104-sat.
- Puig-Suari, J. 2015. "Tyvak Nanosatellite Systems Response to NASA RFI: NNA15ZRD001L."
- Puig-Suari, Jordi. 2015. "Tyvak Nanosatellite Systems Response to NASA RFI: NNA15ZRD001L." Irvine.
- Qinetiq. 2015. "Launch Integration Service."
- Rocket Lab Ltd. 2015. "Electron."
- Scorpius Space Launch Company. 2015. "Critical Technologies for Next Generation Launch Systems and Spacecraft."
- Space Exploration Technologies Corp. 2015. "Falcon 9"



SpaceDaily. 2015. "Spaceport America and ARCA to Jointly Test Launch Vehicles and High Altitude UAVs."

Spaceflight Services. 2015. "Launch Integration Service."

Surrey Satellite Technology Ltd. 2015. "Surrey Satellite Technology Ltd."

Todd, David. 2017. "*Final Score for 2017: 466 – a New Record for the Number of Satellites Attempted to be Launched in a Single Year*" (Corrected). December, 2017. <https://www.seradata.com/final-score-for-2017-463-a-new-record-for-the-number-of-satellites-attempted-to-be-launched-in-a-single-year/>.

United Launch Alliance LLC. 2015. "Delta IV: The 21st Century Launch Solution."

United Launch Alliance LLC. 2015. "Atlas V: Maximum Flexibility and Reliability."

United Launch Alliance. 2018. "United Launch Alliance Successfully Launches West Coast's First Interplanetary Mission for NASA." May 5.

United Launch Alliance. 2017. "United Launch Alliance Successfully Launches Delta II Rocket Carrying JPSS-1 Satellite for NASA and NOAA." November 18.

UTIAS/SFL. 2015. "University of Toronto Institute for Aerospace Studies Space Flight Laboratory."

Vector Launch Inc. 2018. "Vector-H Forecasted Launch Service Guide." *Vector-Launch.com*. Accessed July 23, 2018.

Verberne, O., A. J. Boiron, M. G. Faenza, B. Haemmerl. 2015. "Development of the North Star Sounding Rocket: Getting Ready for the First Demonstration Launch." *51st AIAA/SAE/ASEE Joint Propulsion Conference*.

Virgin Galactic. 2015. "We're Building Rockets that Will Launch the Small Satellite Revolution."

Xtenti. 2017. "*Xtenti, Reaching Forward*." <http://www.xtenti.com>.

Yamin, I. 2015. "DNLV Launch Vehicle Specifications."

Zero2Infinity. 2015. "zero2infinity Will Launch Nanosatellites from the Stratosphere."

11.0 Ground Data Systems

11.1 Introduction

A ground data system consists of a network of ground stations and control centers, such as the Spacecraft Operations Control Center (SOCC), the Payload Operations Control Center (POCC) and the Mission Control Center (MCC). These networks and control centers may be located at the same geographical location depending on the type, size and complexity of the mission. However, for small spacecraft missions, there is often no distinction between MCC, SOCC and POCC, as these different networks support the overall objective of the spacecraft and the users of the data generated by the mission.

The ground segment supports the space segment (spacecraft and payload), relaying the mission data to the final users. To support the spacecraft mission, the ground data system must command and control the bus and payload, monitor their health, track the spacecraft's position, and use ADCS sensor information to report the spacecraft's attitude (Larson & Wertz, 2004).

The author would like to highlight that the presented tables are not intended to be exhaustive but to provide an overview of current state-of-the-art technologies and their development status for this small spacecraft subsystem. There was no intention of mentioning certain companies and omitting others based on their technologies.

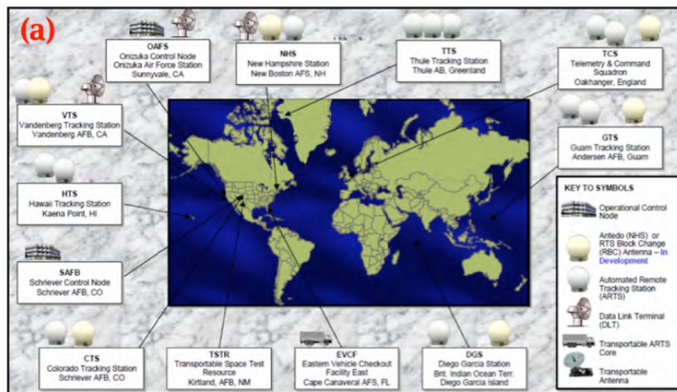

Figure 11.2: The US Air Force Satellite Control Network (AFSCN) is an example of a conventional hierarchical ground data system setup. Image courtesy of USAF.

modified lab room. The ground station is either a fixed or mobile COTS antenna connected to mission control using standard cabling. Tracking, Telemetry and Command (TT&C) for both platform and payload is managed by a single computer.

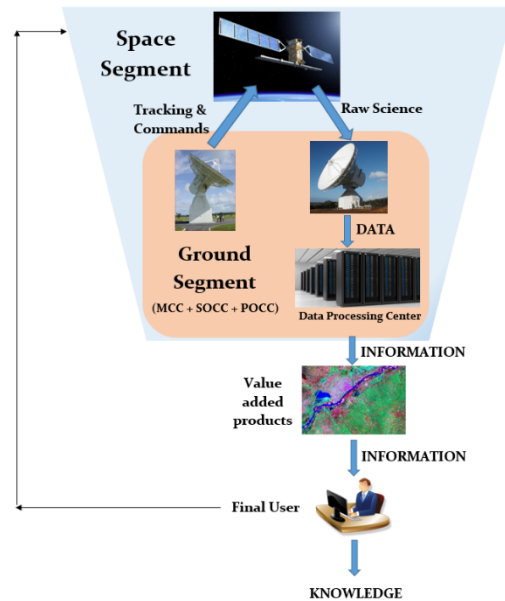

Figure 11.1: Functional relationship between space segment, ground segment and final user in a CubeSat mission.

11.1.1 Small Spacecraft Ground Data Systems

The ground data systems architecture for small spacecraft missions will often take a different form from classical architectures used for larger spacecraft missions. The low-cost paradigm shift and the accessibility of commercial off-the-shelf (COTS) technology for the space sector have not only changed how designers think about spacecraft, but also the ground data systems architecture. To lower the costs of a small spacecraft ground data system, the entire small spacecraft mission is frequently managed from a single



Figure 11.3: The 1343 nodes that participated on a voluntary basis in the distributed ground data system architecture of Phonesat. Image courtesy of <http://www.phonesat.org>.



Figure 11.4: An example of a smallsat mission managed and operated using a single ground station only. Image courtesy of Petr Dlouhý, Wikimedia Commons, Public Domain.

Figures 11.2-4 show the Air Force Satellite Control Network (AFSCN) as an example of a classical ground data system setup. The topology of the AFSCN is hierarchical, with twelve nodes organized around a central master node at Schriever AFB, CO. Figure 11.3 depicts the distributed network of ground stations used for the PhoneSat project as it was supported by 1,343 volunteer nodes organized in a distributed topology. Figure 11.4 illustrates the common small spacecraft ground segment topology, where a single node consists of a university ground station and control room.

Under stringent power and volume budget constraints, small spacecraft (primarily CubeSats) missions typically use academic or amateur ground data systems with only one antenna, limiting the ability to communicate with more than one spacecraft simultaneously. This typically restricts CubeSats to orbits below Geosynchronous (GEO) altitudes, as they are unable to carry far-ranging radio dishes or use more powerful antennae. However as of Spring 2018, CubeSats have begun to venture beyond Earth orbit with the two 6U MarCO spacecraft following advancements in transponders. Other disadvantages of using a single, small antenna include less bandwidth, lower data rate and less throughput capability for the entire mission.

Peer-to-peer topologies are also possible with a large number of ad-hoc nodes participating on a voluntary basis and, despite overcrowding of the frequency bands (typically UHF, VHF and S-band), the individual nodes in the topology can be interchangeable. For an exhaustive treatise on the characteristics of small spacecraft ground data systems, refer to Schmidt, 2011. Additionally, the services provided by CubeSats ground stations generally do not provide the same security, reliability and latency as classical ground data stations. Larger and more complex spacecraft usually use Consultative Committee for Space Data Systems (CCSDS) standards based long-haul communication protocols. On the contrary, CubeSats may use TCP/IP-based communication protocols, which provides lower data communication reliability and performance (Cola, Ernst, & Marchese, 2007).

11.1.2 Amateur and Non-Amateur Communications Bands

Traditionally, amateur radio bands have been the preferred means for CubeSats to communicate with the ground, as frequency allocations from the International Telecommunication Union (ITU) for CubeSat missions have been restricted to eliminate frequency conflicts with larger spacecraft. However, CubeSats are increasingly shifting from low-performance missions to higher-complexity science or technology missions. The larger amount of data produced by these higher-complexity missions necessitates higher communication data rates than amateur bands can provide.



From a regulatory point of view, small spacecraft missions must adhere to the same radio spectrum regulations that apply to larger spacecraft. In the U.S. for example, these regulations are governed by the Federal Communications Commission (FCC). Amateur radio frequencies for communications have licenses that are simple and quick to obtain. Since this kind of license is not available to government entities, whose missions are regulated by the National Telecommunications and Information Administration (NTIA), a number of partnerships have emerged between government entities and academia. For instance, a number of CubeSat missions developed by NASA Ames Research Center are operated from the MOC at Santa Clara University. Similar radio frequency regulations exist in other countries, and these regulatory issues can make small spacecraft partnerships increasingly difficult. It is the responsibility of the developers to ensure they follow the proper regulations as they build and operate their spacecraft.

In most administrations, unlike other RF spectrum users, radio amateurs may build or modify transmitting equipment for their own use within the amateur spectrum without the need to obtain government certification of the equipment, and this can be a big advantage in designing telecommunication systems for CubeSats. Licensed amateurs can also use any frequency in their bands (rather than being allocated fixed frequencies or channels) and can operate medium to high-powered equipment on a wide range of frequencies, as long as they meet certain technical parameters—including occupied bandwidth, power, and maintenance of spurious emissions. For example, the International Amateur Radio Union has allocated CubeSats in the spectrum between 437.100 and 437.575 MHz, with a maximum single satellite bandwidth allocation of 20 kHz. This was done to protect existing and future amateur radio voice satellites (Groenendaal, 2012).

While bands at 2.4 GHz and 5.8 GHz available for amateur spacecraft communication are increasingly crowded, higher frequency amateur bands require uncommon microwave parts to implement transceivers, and working with 10 GHz or higher frequencies requires electric power typically not available in CubeSats. Moreover, encryption is not generally permitted in the amateur radio service, except for the special purpose of spacecraft control uplinks. For these reasons, CubeSat missions are moving to higher, non-amateur frequency bands to support their data requirements. For instance, the 1.5U CubeSat Dynamic Ionosphere CubeSat Experiment (DICE), launched in 2011, used the 460-470 MHz meteorological-satellite band with L3 Cadet radios to produce a 1.5 Mbps downlink data rate to support its science mission (Klofas & Leveque 2012). As CubeSat missions abandon amateur radio bands for higher-speed frequencies, the radios and ground stations get more difficult and more expensive to build. Non-amateur radio licenses, on the other hand, prohibit autonomous beaconing of satellite data. This is a big disadvantage because the CubeSat teams can no longer rely on the existing network of amateur radio operators to downlink beacon data. Non-amateur satellite licenses are usually point-to-point, so all ground stations commanding and receiving satellite data must be on the same territory and must be licensed, which is an expensive and time-consuming process (Klofas & Leveque 2012).

CubeSat programs could use higher frequencies in either the C-band or X-band to reduce the volume and mass of both the transceiver and antenna, and to support increased power generation systems for three-axis stability requirements (Muri 2013). As this will also increase the bandwidth to support payloads that have a significant data downlink requirement, there is a need for highly precise pointing requirements. However, designers need to consider the utility of additional bandwidth with decreased size and mass against increased power requirements to close the link with the ground station, since the energy-per-bit is lowered for the same power consumption (Schroer).

As CubeSat power generation systems become more effective and three axis stability is achieved, higher operating frequencies become increasingly feasible while permitting smaller components



and increased antenna gain (Muri 2013). The user must carefully evaluate all the pros and cons that Amateur and Non-Amateur bands provide, in order to select and define the most appropriate telecommunication solution for mission requirements.

11.1.3 Delay/Disruption Tolerant Networking

As CubeSats are beginning to venture beyond Earth orbit, their networking design must be compatible with the challenging communications environments of deep space. Using Delay Tolerant Networking (DNT) protocols to enable solar system communication at low cost, could benefit CubeSat missions in multiple aspects. DNT is a communication protocol suite used for environments with long transmission delays, intermittent connectivity, and high bit error rate (Muri 2013). It is designed for environments where communication quality is not guaranteed, and for intermittent network connectivity. It works as an overlay network associated with Bundle Protocol (BP) and some convergence layer protocols like Licklider Transmission Protocol (LTP). Future space missions (swarms, constellations, spacecraft that need to communicate with a lander or orbiter) include features that cannot be accommodated by conventional link layer-based communications without intermittent connectivity and long light-time (idle) delays. Complex topology will require a network layer in the space communications protocol stack to provide reliable routing and forwarding of data, and DNT is an effort to solve this problem as TCP/IP (Transmission Control Protocol/Internet Protocol) cannot support this type of network (NASA 2014).

11.2 State of the Art

The ultimate goal for small spacecraft network ground stations is to relay all of its downlinked data as soon as it has commenced operations, and continue until all the intended data has been downlinked. Theoretically, data is downlinked to the different active ground stations during its entire pass. However, active ground stations are not always available for every pass, as there are a number of other spacecraft transmitting data to them (Klofas, "Amateur Radio and the CubeSat Community," 2006).

Ground station networks for small spacecraft have greatly improved in the last few years, as many companies are producing and developing new state-of-the-art systems. Some companies focus more on single products that have yet to be validated in space, others consolidate and extend their current services with turnkey solutions, which adds more capability and availability to their already well-developed ground data systems. This section focuses on the state-of-the-art of communication technologies of Ground Data Systems.

11.2.1 Turnkey Solutions

Turnkey solutions can be a good option for designers who want to focus more on the payload and systems engineering portions of the spacecraft. Table 11-1 lists some companies or organizations that develop and provide turnkey solutions for small spacecraft ground data systems.



Table 11.0-1: Turnkey Solutions for Ground Systems			
Product	Manufacturer	Status	Specifications
ATLAS Global Network	ASAT	TRL 9 for ground infrastructure, TRL 8 for software integration	S-band, X-band, UHF (Ka-band in 2017)
KSAT Lite	Kongsberg Satellite Services	TRL 9	X-band and S-band D/L and S-band U/L. VHF, UHF, Ka-band D/L
Surrey Ground Segment	Surrey Satellite Technology Ltd.	TRL 9	S-band for U/L and D/L and X-band for D/L
ISIS Small Satellite Ground Station	ISIS B.V.	TRL 9	Amateur and non-Amateur protocols for VHF, UHF and S-band
Endeavour TT&C	Tyvak Inc.	TRL 8+	VHF, UHF and 2.2 – 2.29 GHz (S-band)
Open System of Agile Ground Systems (OSAGS)	Espace Inc.	TRL 8	S-band for U/L and D/L. Additional HR/VHF/UHF receive capability
GAMALINK Ground Station Network	GAMALINK	TRL 7+	Provides VHF/UHF pack and S-band pack. Additional ranging and GPS support available
Satellite Tracking and Control Station	Clyde Space	TRL 8	VHF, UHF, L-band and 2.4 GHz
Planet Labs Ground Station Network	Planet Labs	TRL 9	5+ terabytes of data downlinked per day
Spaceflight Networks Global Ground Station Network	Spaceflight Networks	TRL 9	Various bands, from UHF to X-band

Assured Space Access Technologies (ASAT) is an affiliated corporation formed to develop the ATLAS global network of commercially available spacecraft ground stations, aimed at providing cloud-based solutions for space access. It provides global TT&C operations systems using the Amazon Virtual Cloud, which interfaces connectivity for the user to the ground stations. The



supported frequency bands in which ATLAS operates are mainly S, X and UHF (Assured Space Access Technologies, 2014). The figures below show how the ATLAS ground service works with the cloud service (Figure 11.5) and the locations of the antennas around the globe (Figure 11.6).

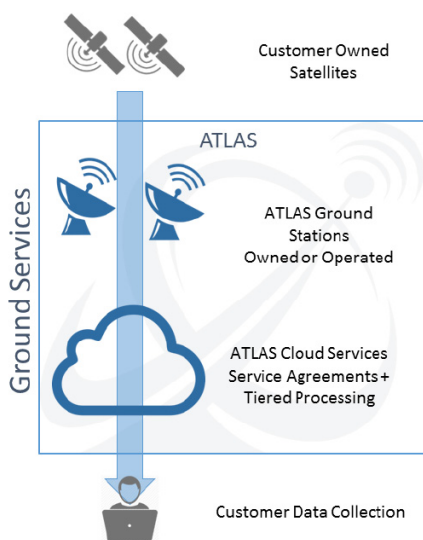

Figure 11.5: Functional diagram of ATLAS ground system. Image courtesy of Assured Space Access Technologies (2014).

KSAT Lite is a low-cost ground station antenna network designed to support different phases of small spacecraft missions. The company has launched 20 ground station sites across the globe. KSAT Lite is an extension of the existing KSAT network, but implements more flexible options and procedures in terms of priority allocation, availability and pass selection. The KSAT network has uniquely located polar stations in the Arctic and Antarctic regions (Figure 11.7), providing from 85% to 100% availability on passes for spacecraft in polar orbit. The network also operates mid-latitude ground stations, providing access for many other orbits. The baseline KSAT 3.7 m antennas provide X-band and S-band for downlink and S-band for uplink. In addition, KSAT Lite offers VHF and UHF capacities that support a variety of system configurations. Ka-band support for the small spacecraft market was integrated in 2016 (Kongsberg Satellite Services AS, 2015).



Figure 11.0.6: Locations of the owned and operated antennas of ATLAS ground systems. Image courtesy of Assured Space Access Technologies (2014).

Similar to KSAT Lite but on a smaller, university scale, the Global Educational Network for Satellite Operations (GENSO) system, by the European Space Agency (ESA), is a software networking standard for universities which allows a remote operator to communicate with their small spacecraft using participating amateur radio ground stations around the globe (European Space Agency n.d.).

Data collection for this type of network allows several hours of data collection per day for any given spacecraft, as opposed to minutes per day with a single ground station.



Figure 11.7: KSAT ground stations in the polar region (Svalbard, Norway). Image courtesy of Kongsberg Satellite Services AS (2015).

Innovative Solutions in Space B.V. (ISIS) also offers turnkey ground station solutions, supporting CubeSats and small spacecraft in the UHF, VHF and S-band for amateur and non-amateur radio bands.

Spaceflight Networks is another established ground operations provider offering cost-effective solutions in development, launch, communications, and operations. They have partnered with a number of agencies and other small satellite companies, including Kratos/RT Logic, in order to provide powerful, low-cost hardware and services (Spaceflight Networks, 2016).

The Open System of Agile Ground Stations (OSAGS) supports high-frequency communications for small spacecraft. Owned by Espace, Inc., OSAGS is a low-cost network of three equatorial S-band ground stations located in Kwajalein, Cayenne, and Singapore, that are based on software defined radio (Cahoy & al, 2012). The stations operate in S-band with a 2.025-2.0120 GHz uplink and 2.20-2.30 GHz downlink frequency. The agile system can support different spacecraft missions simultaneously and is readily available for any small spacecraft mission in need of low-cost ground segment support. Satellites are required to use dedicated software provided by Espace, Inc., and they must have the proper S-band capabilities to communicate with the system.

Government sponsored missions often use turnkey solutions offered by the Space Network (SN) (NASA 2007), Near Earth Network (NEN) (National Aeronautics and Space Administration, 2010) and Deep Space Network (DSN) (NASA 2015), collectively known as Space Communications and Navigation (SCaN). Prior to May, 2018, the DSN offered the only existing TT&C service for beyond Earth orbit, but Analytical Graphics, Inc (AGI) has announced a commercial deep space radar tracking system. The Air Force Satellite Control Network (AFSCN) is even more tightly controlled than SCaN. However, the Air Force does make the services of the Joint Space Operations Center (JSpOC) available to the public, particularly for space situational awareness in the form of two-lined element sets (TLEs) for tracking satellites, and conjunction alerts for potential collisions. AGI has developed a similar system in the commercial sector called the Commercial Space Operations Center (ComSpOC).

Some companies can also provide specific individual components to users that want to assemble their own customized ground stations. For example, Helical Communication Technologies specializes in quadrifilar helical antennas, made of four helical filars or windings that support right and left hand circularly polarized signals. These antennas receive and transmit signals from the ground station to amateur radio satellites in LEO at frequencies between 300 and 3000 MHz, and are particularly useful when receiving small spacecraft signals shortly after launch without the need for tracking or positioning equipment and associated tracking software. Due to the nearly omni-directional pattern, the quadrifilar helical antenna provides good gain at low elevation.

KSAT and ISIS are also able to provide single antenna components that can interface with many different ground data systems. For example, Bring Your Own Device (BYOD) is a solution from KSAT which provides KSAT-rugged antennas that interface with a customer's own back-end equipment.

11.2.2 Ground Data Systems Hardware and Software

Every ground station needs hardware and software components to operate and support spacecraft missions. There are a number of conceptual systems for the telemetry, tracking, and



commanding of hundreds or thousands of small spacecraft. Emulation tools also play an important role for these types of missions and systems. Table 11-2 lists some companies that provide front-end and back-end hardware and software for ground stations.

Table 11.0-2: Hardware and Software for Ground Systems			
Product	Manufacturer	TRL Status	Type of Product
quantumGND	Kratos/RT Logic	9	quantumCMD: Command and Control (C2) software; qFEP: Front-End Processors for encryption of commands and decryption of telemetry; qRadio: digital IF front-ends and IP-Modem; T4: software framework
ISIS GSKit Ground Station	ISIS B. V.	9	UV Transceiver: contains the modem and the gain blocks; Rotator Controller: used to control the azimuth and elevation rotator
Soft FEP	AMERGINT	8+	Emulation ground systems software
Distributed Simulation & Test Environment (DSTE)	Celestia Satellite Test & Simulation	9	Hardware and software elements all operating within a single reference platform and environment
Gpredict	Alexandru Csete	9	Open source software that tracks satellites and provides orbit prediction in real-time. Radio and antenna rotator control for autonomous tracking
GNU Radio	GNU Project	9	Free software development toolkit that provides signal processing blocks to implement software-defined radios and signal processing systems
COSMOS	Ball Aerospace	9	Open source command and control system. Developed in 2006, and free as of 2015, COSMOS brings functionality that has previously been proprietary and expensive
SpaceCentre	Satellite and Airborne Radar Systems Laboratory	9	A web-based ground station application that enables effective mission planning and satellite operations

QuantumGND is a turnkey ground data system solution offered by Kratos/RT Logic designed specifically for small spacecraft applications. It is a complete, turnkey small spacecraft ground data system package for Command and Control communication to Radio Frequency signal processing (C2-to-RF) that includes everything from the C2 system through the ground network, to the ground modem, giving a solution that is pre-integrated and easy-to-use. QuantumGND is comprised of quantumCMD for a small spacecraft command and control, qFEP for front-end processing, encryption and decryption, and qRADIO for network transport and RF signal processing. All these components are also available separately and independently for users who need only particular components for their customized ground data system. A block diagram on how quantumGND works is shown in Figure 11.8.

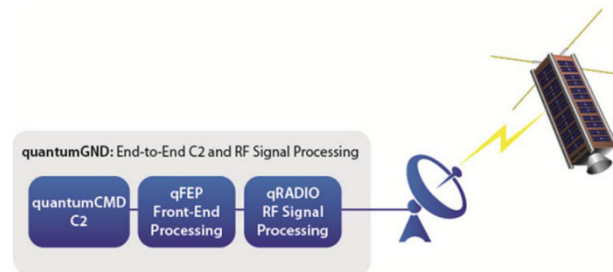

Figure 11.8: QuantumGND block diagram. Image courtesy of Kratos/RT Logic (2015).

For systems engineering and testing of a constellation of spacecraft, SoftFEP can emulate thousands of spacecraft in constellation with their ground networks. It dynamically exercises the constellation management, ground payload and TT&C software, and simulates the entire end-to-end, multi-node communication system. It has been used to model complex space-to-ground communication systems, and also to emulate thousands of data channels to test software applications that process data.

The Distributed Simulation & Test Environment (DSTE) is a family of standard products designed and developed by SSBV Space and Ground Systems to support simulation, assembly, integration and testing of spacecraft, subsystems and payloads. All the elements of DSTE are based on modular hardware and software architectures that use the latest technology to enable multi-purpose modules and components in a common, reconfigurable, spacecraft and instrument simulation and test environment.

Gpredict is a free application that offers fast and accurate real-time satellite tracking. It operates in tandem with the Ham Radio Control Libraries (hamlib), a standardized API to control any radio-oriented equipment through a computer interface. Gpredict is capable of providing information about future satellite passes along with autonomous tracking.

11.2.3 Alternative Solutions

A possible alternative to using mission-specific ground stations altogether is to communicate with satellite phone data networks such as Iridium, Orbcomm and Globalstar. This section focuses on the state-of-the-art of alternative communication technologies for Ground Data Systems.

TechEdSat-1, a 1U CubeSat launched in 2012, investigated this alternative inter-satellite communication method. The spacecraft had Quake Global Q1000 and Q9602 modems onboard to test communications with both the Iridium and Orbcomm constellations (Löfgren & al., 2013). Unfortunately, the spacecraft was forced to disable its modems before communications could occur due to a delay of the FCC license. In April, 2013, another experiment including an Iridium modem flew as an additional payload attached to the outside of the Bell PhoneSat's frame (Green, 2013). This experiment successfully communicated the spacecraft location to the Iridium constellation, which then sent the information to the mission team via email. The team saw improvements in data rate and signal quality, compared to communications with amateur radio



ground stations. The experiment was also able to transmit ten hours of data to the Iridium constellation over a 24-hour period, which is a significant improvement over typical spacecraft-to-ground transmission durations for CubeSats (Green, 2013).

Inter-satellite communication was tested again using TechEdSat-3p, a 3U CubeSat launched in 2013 (Harding, 2013). After deployment, TechEdSat-3p successfully communicated with the Iridium satellite network using two redundant Quake Global Q9602 modems. TechEdSat-4, launched in 2014, built upon the success of TES-1, -2, and -3 and continues to demonstrate satellite-to-satellite communications along with a passive reentry device called the Exo-Brake (National Aeronautics and Space Administration n.d.). TechEdSat-5 and -6, which launched in 2016 and 2017 respectively, both feature improved hardware that continues to test the communications and Exo-Brake technology (National Aeronautics and Space Administration n.d.). While TES 7, 8, and 9 will continue the TES family line, they have yet to launch. They too will test improvements to previously flown technology, along with some additions, like a CubeSat Identity Tag (CUBIT) to help identify nanosatellites.

The Transformational Satellite Communications System (TSAT) funded by the USAF successfully tested a simplex Globalstar modem, the EyeStar, from NearSpaceLaunch. This test was repeated by the Globalstar Experiment and Risk Reduction Satellite (GEARRS), and GEARRS2 flights also successfully tested the EyeStar Duplex Globalstar modem (Voss & Dailey, 2015). LinkStar is another duplex radio being developed by sci_Zone that is still in the design phase and will also take advantage of the GlobalStar network (Santangelo, 2016). A NASA sounding rocket, the LCT2-b, tested a modem from LJT & Associates in 2008, as part of Sub-Orbital Aerodynamic Re-entry EXperiments (SOAREX-VI). The modem is intended to work with the Tracking and Data Relay Satellite System (TDRSS) (White, Morgan, & Murbach, 2007). However, as the TDRSS system is administered by NASA, there might be regulatory complications for consumer spacecraft wishing to use it.

These missions are actively proving the value of using inter-satellite communications to relay data to the ground. Small spacecraft that use existing satellite phone constellations instead of ground stations may see potential cost savings and quality improvements.

11.3 On the Horizon

As the ground data systems and communication options for small spacecraft (particularly CubeSats) expand, engineers must consider the trade-off between data quality, data volume, and cost. In the past, several missions depended entirely on amateur radio ground stations to support spacecraft operation and communication, and the amateur radio community has proved to be invaluable to the CubeSat community. As mission complexity and data requirements increase, more projects are looking to non-amateur ground stations and other options like inter-satellite communications, laser optical communications, and phased array ground stations (Sheldon, Bradfield, Sanchez, & al, 2016).

These options, however, tend to present higher costs due to the need for associated radio frequency licenses and bespoke software specific to a given service provider. Further, the service itself may be priced based on data size or communication duration. Many factors can affect the cost, data quality and size of each communication method, and for some of these methods the factors are either only beginning to be understood in the context of small spacecraft operations, or they have yet to be encountered. The relationship between data quality, data size and cost for these communication methods must be studied over the coming years, as the various methods are analyzed by current and future small spacecraft missions.



Due to both the desire to speed up transmission of high-rate science data, and to the increasing demand for S-band and X-band telecommunications, the Ka-band is now considered the band of the future for NASA small spacecraft missions. Along with satellite hardware, BridgeSat Inc. is developing ground stations compatible with optical communications. They aim to create a worldwide network of stations that allow data downlink and uplink regardless of the optical terminal. They are planning a satellite-to-ground optical comm test for the near future that will demonstrate the feasibility of optical comms in consistently downlinking data from small satellites in LEO (Mitlyng, 2017).

Planning & Scheduling and Data Management are two areas of ongoing research within the field of small spacecraft ground data systems software. The future will see an increasing number of small spacecraft missions involving not only single spacecraft, but swarms, constellations, and formations of spacecraft (Raymond, Bristow, & Schoeberl, 2000). A distributed infrastructure of small spacecraft made up of dozens, if not hundreds, of units would allow low-cost, high-resolution Earth observation and science missions. However, the number of ground station networks that can accommodate constellations is restricted, as the scalability of mission operations is limited without significant automation. The number of operators typically scales linearly with the number of telemetry nodes required to monitor the spacecraft (Siewert & McClure, 1995). The Space Telecommunications, Astronomy and Radiation (STAR) laboratory from Massachusetts Institute of Technology presents a solution to scalability concerns regarding constellations. The Autonomous CubeSat Constellation Earth-observing Scheduling System (ACCESS) is designed to plan constellation operations using onboard and ground-based algorithms. This system would simplify data routing and offer better routing performance for inter-satellite data handling (Cahoy and Kennedy 2016).

Managing swarms of small spacecraft presents a unique cooperation challenge. In order to address the issue of scalable control of orbital dynamics, researchers at NASA Ames Research Center have introduced the Swarm Orbital Dynamics Advisor (SODA), a software tool that provides the orbital maneuvers needed to achieve the desired type of swarm relative motion (Conn, et al. 2017). Ploschnitznig, McLaughling, and Falco propose that a constellation of hundreds of small spacecraft would require thousands of operators and thus an excessive operations budget, assuming a best case scenario. This number is determined by scaling up operations from a single small spacecraft, which requires roughly ten operators to ensure mission success (not including payload operators). In the CubeSat realm, they point out that conventional operations require an unrealistic commitment from the academic and amateur community. A novel solution to this legacy ground station approach is offered by Riverside Research, whereby a modification of existing cellular towers allows the integration of satellite communications, thus shifting the existing paradigm (Ploschnitznig, McLaughling, & Falco, 2017). Moreover, to keep costs low and allow for the emergence of next-generation, distributed, small spacecraft platforms, it will become increasingly necessary for a spacecraft to perform certain operations autonomously in orbit or automatically from the ground. The challenges related to partially or fully autonomous operations and multi-mission operations centers for small spacecraft clusters are ongoing fields of research.

11.4 Summary

From the moment of launch, the only connection between the spacecraft and Earth is through the communication between the spacecraft and the ground data systems. The spacecraft sends scientific and engineering data through its antenna (or laser) back to Earth, and the ground data system receives that data, tracks the spacecraft, and commands the spacecraft.



Depending on the requirements and priorities of the user, different types of solutions to build and assemble a ground station are available in the market. If the user wants to focus more on the payload and the systems engineering of the spacecraft, some companies have pre-defined turnkey solutions, which provide full capability and support for the spacecraft ground communications. Other possible solutions are customizing the ground station with specific components (such as antennas, transceivers, modems and software) that can be provided by different manufacturers. The user can choose all the different pieces of hardware and software needed for this purpose, and have a customized ground station assembled. Finally, another valuable solution for small spacecraft to communicate with Earth is using an inter-satellite communications relay. Some CubeSat missions have already demonstrated these capabilities.

Whichever solution turns out to be the most reasonable and appropriate, the chosen ground system must provide cost-effective, accurate, and on-time space communications for the entire mission duration.

References

- Assured Space Access Technologies. 2014. "ATLAS."
- Beam, C. 2016. "Flying Constellations in the Cloud." *30th Annual AIAA/USU Conference on Small Satellites*. Logan, UT.
- Cahoy, K, A. K. Kennedy. 2016. "Initial Results from ACCESS: an Autonomous CubeSat Constellation Scheduling System for Earth Observation." *30th Annual AIAA/USU Conference on Small Satellites*. Logan, UT.
- Cahoy, K., et al. 2012. "S-Band CubeSat Communications with the Open System of Agile Ground Stations (OSAGS)." *CalPoly CubeSat Developers' Workshop*.
- Cola, T. de, H. Ernst, M. Marchese. 2007. "Performance Analysis of CCSDS File Delivery Protocol and Erasure Coding Techniques in Deep Space Environments."
- Conn, T., A. Perez, L. Plice, M. Ho. 2017. "Operating Small Sat Swarms as a Single Entity: Introducing SODA." *31st Annual AIAA/USU Conference on Small Satellites*. Logan, UT.
- European Space Agency. n.d. "*Global Educational Network for Satellite Operations*." Accessed July 2018.
- Green, M. 2013. "PhoneSat Flight Demonstrations: Successful PhoneSat Mission Completed."
- Groenendaal, H. van de. 2012. Personal Communication.
- Harding, P. 2013. "Japan's HTV-4 Launches Supplies and Science to the ISS."
- Klofas, B. 2006. "Amateur Radio and the CubeSat Community." *AMSAT Space Symposium*.
- Klofas, B., K. Leveque. 2012. "The Future of CubeSat Communications: Transitioning Away from Amateur Radio Frequencies for High-speed Downlinks." *AMSAT Symposium*.
- Kongsberg Satellite Services AS. 2015. "KSAT – Kongsberg Satellite Services."



- Larson, W. J., J. R. Wertz. 2004. "Space Mission Analysis and Design." *Microcosm Press*.
- Löfgren, H. et al. 2013. "TechEdSat: a Minimal and Robust 1U CubeSat Architecture Using Plug-and-play Avionics." *9th IAA Symposium on Small Satellites for Earth Observation*.
- Mitlyng, D. 2017. "Optical Communications Systems for Smallsats: a BridgeSat Perspective." *SatMagazine*. February. www.satmagazine.com.
- National Aeronautics and Space Administration. 2007. "Space Network Users' Guide (SNUG)."
- National Aeronautics and Space Administration. 2015. "DSN Telecommunications Link Design Handbook."
- . 2010. "Near Earth Network (NEN) Users' Guide."
- . n.d. "TechEdSat-4: Nano-Satellite Series." *NASA Website*.
- . n.d. "Technical Education Satellite Series: TechEdSat-5." *NASA Website*.
- Ploschnitznig, J.E., S.M. McLaughling, F. Falco. 2017. "The Small Satellite Integrated Communication Environment (I.C.E.) – An Update." *31st Annual AIAA/USU Conference on Small Satellites*.
- Raymond, C. A., J. O. Bristow, M. R. Schoeberl. 2000. "Needs for an Intelligent Distributed Spacecraft Infrastructure." *NASA Earth Science Technology Workshop*.
- Santangelo, A. 2016. "The LinkStar-STX3 Architecture, a New Generation of Simplex Based Radios for Near Global Communications."
- Schmidt, M. 2011. "Ground Station Networks for Efficient Operation of Distributed Small Satellite Systems." *Schriftenreihe Wuerzburger Forschungsberichte in Robotik und Telematik*. Universitaet Wuerzburg.
- Schroer, M. P. n.d. "NPS-Scat: a CubeSat Communications System Design, Test, and Integration."
- Sheldon, C., J. Bradfieldl, E. Sanchez et al. 2016. "UHF Phased Array Ground Stations for CubeSat Applications." *30th Annual AIAA/USU Conference on Small Satellites*.
- Siewert, S., L. H. McClure. 1995. "A System Architecture to Advance Small Satellite Mission Operations." *9th AIAA/Utah State University Conference on Small Satellites*.
2016. *Spaceflight Networks*. www.spaceflight.industries.
- Voss, H., J. Dailey. 2015. "Technology, Service, Education: Globalstar 24/7 for LEO." *12th Annual CubeSat Developers' Workshop*.
- White, B., H. Morgan, M. Murbach. 2007. "Electronic Systems of the Slotted Compression Ramp (SCRAMP) Probe." *Fifth Annual International Planetary Probe Workshop*.

12.0 Passive Deorbit Systems

12.1 Introduction

It has been estimated that as a result of increased space flight, there has been an accumulation of orbital debris consisting of more than 750,000 particles with a diameter 1-10 cm and over 29,000 pieces with diameters >10 cm in orbit between Geostationary (GEO) and LEO (LEO) altitudes (Williams 2017). As a result of all the launches into space, 94% are considered to be space debris, and 64% of those are fragments with a collective mass of 7,500 metric tons (Williams 2017). Figure 12.1 is a representation of the debris around Earth (ESA). The objective of the NASA Orbital Debris Program along with the Inter-Agency Space Debris Coordination Committee (IADC) is to limit the creation of space debris. They have mandated that all spacecraft either deorbit within a given amount of time or be placed into a graveyard orbit for safe storage. The lifetime requirement is 25 years post-mission, or 30 years after launch if unable to be stored in a graveyard orbit (NASA 2012).

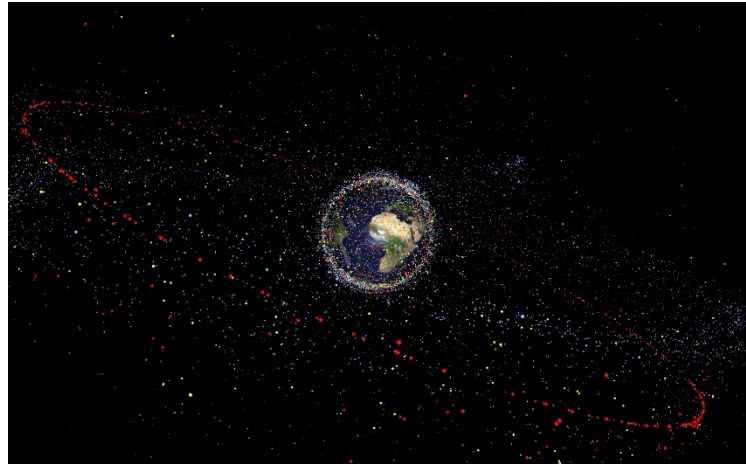

Figure 12.1: Distribution of space debris. Image courtesy of European Space Agency (2015).

Small spacecraft are typically launched into LEO as it is a more accessible and less expensive orbit to reach. There are lots of rideshare opportunities to LEO through several commercial launch providers. The close proximity to Earth can relax spacecraft mass, power and propulsive constraints. Additionally, the radiation environment in LEO is relatively benign for altitudes below 1000 km. Small spacecraft launched at or around ISS altitude (400 km) naturally decay in well under 25 years. However at orbit altitudes beyond 600 km, it can no longer be guaranteed that a small spacecraft will naturally decay in 25 years due to uncertainties in atmospheric density, as seen in Figure 12.2 (ESA, 2015), (Analytical Graphics Inc, 2015). As the majority of those spacecraft are unable to be parked in a graveyard orbit because that requires additional propellant to increase their altitude, the only option for small spacecraft in lower orbits is to deorbit.

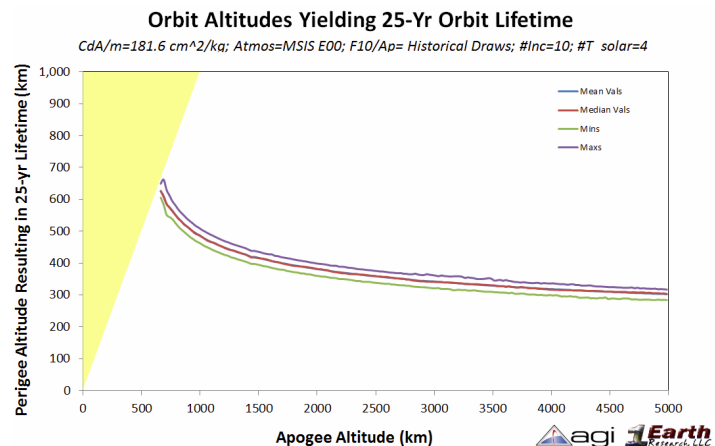

Figure 12.2: Orbit altitudes yielding 25 year lifetime. Used with permission from Analytical Graphics, Inc.

The author would like to highlight that the presented tables are not intended to be exhaustive but to provide an overview of current state-of-the-art technologies and their development status for



this small spacecraft subsystem. There is no intention of mentioning certain companies and omitting others based on their technologies.

12.2 State of the Art

Since deorbit systems are still in their infancy, there are only a few high TRL (TRL \geq 7) devices guaranteed to satisfy the 25-year requirement. Deorbit techniques can be either passive or active, although the primary focus has been on the design of passive methods. Active deorbiting requires attitude control and surplus propellant post mission, such as a steered drag sail that relies on a functioning attitude control system for pointing the sail. Propulsive devices have also been examined for deorbiting techniques (please refer to Propulsion Chapter for this capability), however this approach is still considered risky. Even if enough excess propellant was carried for an active decay approach, and adequate attitude control capability post mission was assured, this method requires continuous operation until reentry is met, making it inconvenient and costly for a small spacecraft mission (G. Bonin, 2013). Overall, active deorbiting methods are still considered challenging for small spacecraft, as this demand increases design complexity and uses valuable mass and volume.

In contrast, passive deorbit methods require no further active control after deployment. Therefore, this chapter will focus on passive deorbit mechanisms only. Table 12-1 displays current state-of-the-art technology for passive deorbit systems.

Product	Manufacturer	TRL Status
Drag-Net	MMA Design	9
RODEO	Composite Technology Development, Inc.	7
AEOLDOS	Clyde Space	7
Terminator Tape	Tethers Unlimited, Inc.	7
Drag Sail	UTIAS-SFL	9
Exo-Brake	NASA	9
Booms	ROCCOR	7

12.2.1 Solar Sails

Several small spacecraft missions have been developed and launched to demonstrate passive (uncontrolled) deorbit technologies using a drag sail or boom, such as NanoSail-D2 and CanX-7. NanoSail-D2 was deployed in 2011, from the minisatellite FASsat HSV into a 650 km altitude and 72° inclined orbit, and demonstrated the deorbit capability of a low mass, high surface area sail (G. Bonin, 2013). The 3U spacecraft, developed at NASA Marshall Space Flight Center, reentered Earth's atmosphere in September, 2011. CanX-7, still in orbit at an initial 800 km SSO, deployed a drag sail in May, 2017. The sail was developed and tested at University of Toronto Institute for Aerospace Studies Space Flight Laboratory (UTIAS-SFL) (Figure 12.3).

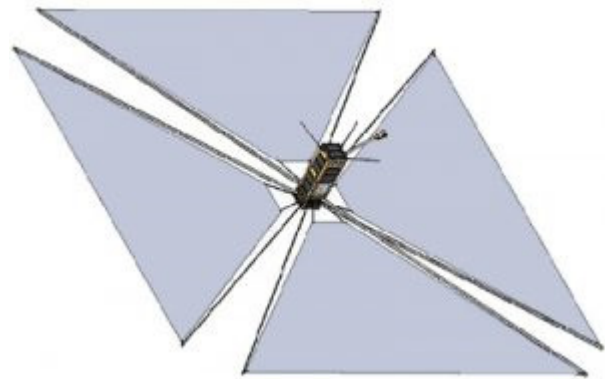

Figure 12.3: CanX-7 deployed drag sail representation. Image courtesy of Bonin et al. (2013).

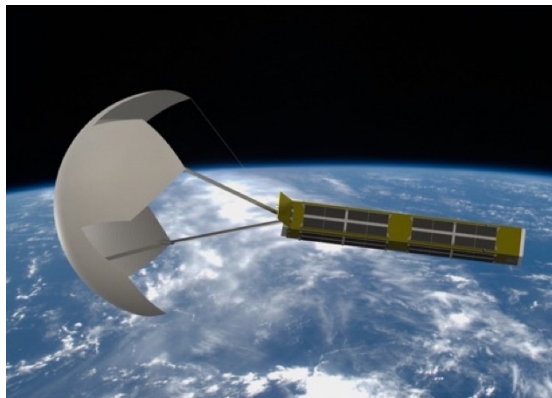

Figure 12.4: Deployment of the Exo-Brake device. Image courtesy of F.A.Tanner.

Recent CubeSats have used NASA's Exo-Brake Parachute for mission deorbiting (Figure 12.4). An Exo-Brake increases the spacecraft's drag once the tension-based, flexible braking device that resembles a cross-parachute is deployed from the rear. The Exo-Brake development is funded by the Entry Systems Modeling project within the NASA Space Technology Mission Directorate's Game Changing Development program. Four Technology Education Satellite (TechEdSat) 3U CubeSat missions have used several versions of the Exo-Brake module. The latest two of the four TechEdSat spacecraft are TechEdSat-5 and TechEdSat-6; TechEdSat-5 was deployed from the ISS March, 2017, and demonstrated this deorbiting capability

after 144 days in orbit (European Space Agency 2017). TechEdSat-5 orbited at 400 km altitude when the Exo-Brake was enabled. TechEdSat-6 and EcMASat, 3U and 6U form factors respectively, both are also equipped with the Exo-Brake module, but have not yet been activated.

12.2.2 Deployable Booms

Composite Technology Development, Inc. has developed the Roll-Out DeOrbiting device (RODEO) that consists of a lightweight film attached to a simple, ultra-lightweight, roll-out composite boom structure (Figure 12.5). It was successfully deployed on suborbital RocketSat-8 on August 13, 2013 (Turse, et al. 2013).



Figure 12.5: RODEO stowed. Image courtesy of Composite Technology Development, Inc.

AAC-Clyde collaborated with the University of Glasglow to construct the Aerodynamic End-of-Life Deorbit system for CubeSats (AEOLDOS), where a lightweight, foldable “aerobrake” made from a membrane is supported by boom-springs that open the sail to generate aerodynamic drag against the upper atmosphere (P. Harkness, 2014). There is no current update to this system.

12.2.3 Electromagnetic Tethers

In addition to drag sails, an electromagnetic tether has also been shown to be an effective deorbit method (Figure 12.6). An electromagnetic tether uses a conductive tether to generate an electromagnetic force as the tether system moves relative to Earth’s magnetic field. Tethers Unlimited developed Terminator Tape that uses a burn-wire release mechanism to actuate the ejection of the Terminator’s cover, deploying a 30 m long conductive tape (electromagnetic tether) at the conclusion of the small spacecraft mission (R. P. Hoyt, 2009). There are currently two modules: one sized for 180 kg ESPA class spacecraft, and the other sized for CubeSat form factors, called nanoTerminator Tape. Reach from Tethers Unlimited show that orbit raising and lowering is most effective in low to moderate inclinations (>70deg). Terminator tape has heritage on Aerocube-V which launched in 2015, but the CubeSat is currently still in orbit and the terminator tape has not yet been activated (Tethers Unlimited, Inc. 2014).

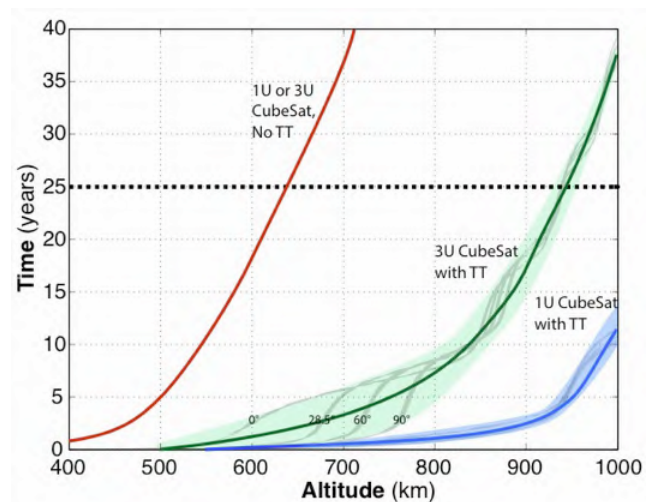

Figure 12.6: Performance curve of Terminator Tape for 1U CubeSats in orbits up to 1200 km and for 3U CubeSats up to 950 km. Image courtesy of Tethers Unlimited, Inc. (2014).

12.3 Summary

Small spacecraft deorbit systems have been shown to be quite effective in meeting mandated lifetime requirements. As most small spacecraft are unable to relocate to a graveyard orbit due to propulsion limitations, deorbit system development has focused on passive devices. NanoSail-D2, CanX-7, TechEdSat-3, TechEdSat-4, and TechEdSat-5 are all CubeSat platforms that have successfully demonstrated the use of drag sails for deorbiting in LEO within the 25-year post-mission requirement. EcAMSat and TechEdSat-6 will hopefully successfully demonstrate their



deorbiting systems soon. Terminator Tape currently being flown on Aerocube-V CubeSat is another deorbit option that uses electromagnetic tethers.

References

- Analytical Graphics Inc. 2015. "An Evaluation of CubeSat Orbital Decay."
- ESA. 2015. "*Space Debris*."
- European Space Agency. 2017. "*TechEdSat-5 (Technical Education Satellite-5)*." Accessed 13 July, 2018. <https://directory.eoportal.org/web/eoportal/satellite-missions/t/techedsat-5>.
- G. Bonin, J. Hiemstra, T. Sears, R. E. Zee. 2013. "The CanX-7 Drag Sail Demonstration Mission: Enabling Environmental Stewardship for Nano- and Microsatellites." *27th Annual AIAA/USU Conference on Small Satellites*.
- NASA. 2012. "Process for Limiting Orbital Debris." *standards.nasa.gov*.
- P. Harkness, M. McRobb, P. Lutzkendorf, R. Milligan, A. Feeney, C. Clark. 2014. "Development Status of AEOLDOS: a Deorbit Module for Small Satellites."
- R. P. Hoyt, I. M. Barnes, N. R. Voronka, J. T. Slostadin. 2009. "The Terminator Tape: a Cost-Effective De-Orbit Module for End-of-Life Disposal of LEO Satellites." *AIAA Space 2009 Conference*.
- Tethers Unlimited, Inc. 2014. "The Terminator Tape and Terminator Tether Satellite Deorbit Systems: Low-Cost, Low-Mass End-of-Mission Disposal for Space Debris Mitigation."
- Turse, D., P. Keller, R. Taylor, M. Reavis, M. Tupper, C. Koehler. 2013. "Flight Testing of a Low Cost De-Orbiting Device for Small Satellites." *Proceedings of the 42nd Aerospace Mechanisms Symposium*.
- Williams, M. 2017. "Eye-opening Numbers on Space Debris." March 21. Accessed July 12, 2018. <https://phys.org/news/2017-03-eye-opening-space-debris.html>.



Summary

This report has provided an overview and assessment of the state-of-the-art for small spacecraft technology with an emphasis on CubeSats. Since the last report many small spacecraft technologies have matured to the extent that every subsystem now offers a selection of previously flown (TRL 9) hardware. Over the next decade this selection is expected to increase dramatically as new technologies are continuously maturing, and the cost of designing, building and launching a small spacecraft continues to decrease.

This report will be regularly updated as emerging technologies mature and become state-of-the-art. Any current technologies that were inadvertently missed will be identified and included in subsequent versions. This report is also available online located at: <https://sst-soa.arc.nasa.gov>. Ongoing reader and technology inputs can be made by reaching out to the editor of this report at arc-sst-soa@mail.nasa.gov.

This report will be updated in the Fall of 2019.



Appendix E. Technology Readiness Levels

TRL	Definition	Hardware Description	Software Description	Exit Criteria
1	Basic principles observed and reported	Scientific knowledge generated underpinning hardware technology concepts/applications	Scientific knowledge generated underpinning basic properties of software architecture and mathematical formulation	Peer reviewed publication of research underlying the proposed concept/application
2	Technology concept and/or application formulated	Invention begins, practical applications are identified but is speculative, no experimental proof or detailed analysis is available to support the conjecture	Practical application is identified but is speculative; no experimental proof or detailed analysis is available to support the conjecture. Basic properties of algorithms, representations, and concepts defined. Basic principles coded. Experiments performed with synthetic data	Documented description of the application/concept that addresses feasibility and benefit
3	Analytical and experimental critical function and/or characteristic proof-of-concept	Analytical studies place the technology in an appropriate context and laboratory demonstrations, modeling and simulation validate analytical prediction	Development of limited functionality to validate critical properties and predictions using non-integrated software components	Documented analytical/experimental results validate predictions of key parameters
4	Component and/or breadboard validation in laboratory environment	A low fidelity system/component breadboard is built and operated to demonstrate basic functionality and critical test environments, and associated performance predictions are defined relative to final operating environment	Key, functionality critical software components are integrated and functionally validated to establish interoperability and begin architecture development. Relevant environments defined, and performance in the environment predicted	Documented test performance demonstrating agreement with analytical predictions. Documented definition of relevant environment
5	Component and/or	A medium fidelity system/component	End-to-end software elements implemented	Documented test performance



National Aeronautics and Space Administration

	breadboard validation in relevant environment	brassboard is built and operated to demonstrate overall performance in a simulated operational environment with realistic support elements that demonstrate overall performance in critical areas. Performance predictions are made for subsequent development phases	and interfaced with existing systems/simulations conforming to target environment. End-to-end software system is tested in relevant environment, meeting predicted performance. Operational environment performance predicted. Prototype implementations developed	demonstrating agreement with analytical predictions. Documented definition of scaling requirements
6	System/sub-system model or prototype demonstration in a relevant environment	A high fidelity system/component prototype that adequately addresses all critical scaling issues is built and operated in a relevant environment to demonstrate operations under critical environmental conditions	Prototype implementations of the software demonstrated on full-scale, realistic problems. Partially integrated with existing hardware/software systems. Limited documentation available. Engineering feasibility fully demonstrated	Documented test performance demonstrating agreement with analytical predictions
7	System prototype demonstration in an operational environment	A high fidelity engineering unit that adequately addresses all critical scaling issues is built and operated in a relevant environment to demonstrate performance in the actual operational environment and platform (ground, airborne, or space)	Prototype software exists having all key functionality available for demonstration and test. Well integrated with operational hardware/software systems demonstrating operational feasibility. Most software bugs removed. Limited documentation available	Documented test performance demonstrating agreement with analytical predictions.
8	Actual system completed and "flight qualified" through test and demonstration	The final product in its final configuration is successfully demonstrated through test and analysis for its intended operational environment and platform	All software has been thoroughly debugged and fully integrated with all operational hardware and software systems. All user documentation, training documentation, and	Documented test performance verifying analytical predictions



National Aeronautics and Space Administration

		(ground, airborne, or space)	maintenance documentation completed. All functionality successfully demonstrated in simulated operational scenarios. Verification and validation completed	
9	Actual system flight proven through successful mission operations	The final product is successfully operated in an actual mission	All software has been thoroughly debugged and fully integrated with all operational hardware and software systems. All documentation has been completed. Sustaining software support is in place. System has been successfully operated in the operational environment	Documented mission operational results

Note: In cases of conflict between NASA directives concerning TRL definitions, NPR 7123.1 will take precedence.