

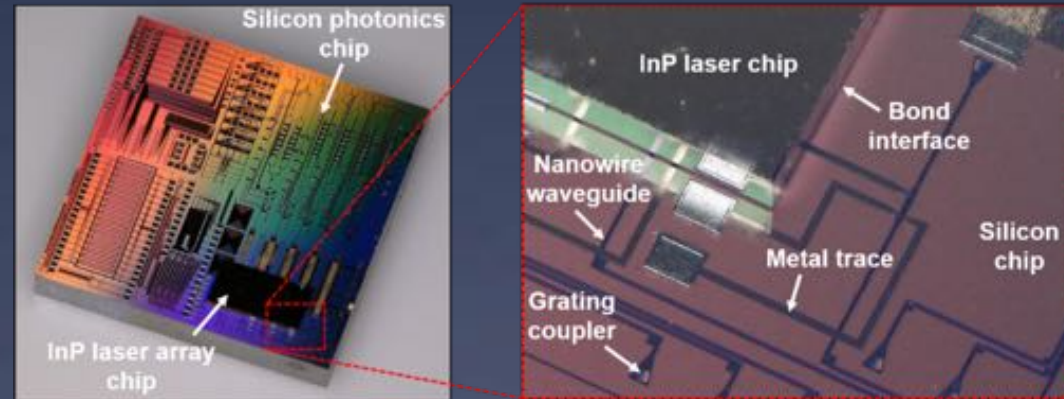

Integrated photonics for NASA applications



Michael Krainak^{*a}, Mark Stephen^a, Elisavet Troupaki^a, Sarah Tedder^b, Baraquiel Reyna^c, Jonathan Klamkin^d, Hongwei Zhao^d, Bowen Song^d, Joseph Fridlander^d, Minh Tran^d, John E. Bowers^d, Keren Bergman^e, Michal Lipson^e, Anthony Rizzo^e, Ipshita Datta^e, Nathan Abrams^e, Shayan Mookherjee^f, Seng-Tiong Ho^g, Qiang Bei^g, Yingyan Huang^h, Yongming Tu^h, Behzad Moslehiⁱ, James Harrisⁱ, Andrey Matsko^k, Anatoliy Savchenkov^k, Guangyao Liu^l, Roberto Proietti^l, S. J. B. Yoo^l, Leif Johansson^m, Christophe Dorrerⁿ, Francisco R. Arteaga-Sierraⁿ, Jie Qiao^o, Songbin Gong^p, Tingyi Gu^q, Osgar John Ohanian III^r, Xingjie Ni^s, Yimin Ding^s, Yao Duan^s, Hamed Dalir^t, Ray T. Chen^u, Volker J. Sorger^v, Tin Komljenovic^w



This work was funded by NASA.

^aNASA-Goddard Space Flight Center, ^bNASA-Glenn Research Center, ^cNASA Johnson Space Center, ^dUniversity of California Santa Barbara, ^eColumbia University, ^fUniversity of California San Diego, ^gNorthwestern University, ^hOptoNet, ⁱIFOS Inc., ^jStanford University, ^kOE Waves Inc., ^lUniversity of California-Davis, ^mFreedom Photonics Inc., ⁿAktiwave LLC, ^oRochester Institute of Technology, ^pUniversity of Illinois, ^qUniversity of Delaware, ^rLuna Innovations Incorporated, ^sPennsylvania State University, ^tOmega Optics, Inc., ^uUniversity of Texas at Austin, ^vGeorge Washington University, ^wNexus Photonics



NASA Integrated Photonics



NASA Applications:

- **Sensors – Spectrometers - Chemical/biological sensors:**
 - ◇ Lab-on-a-chip systems for landers
 - ◇ Astronaut health monitoring
 - ◇ Front-end and back-end for remote sensing instruments including trace gas lidars
 - ◇ Large telescope spectrometers for exoplanets.

- **Microwave, Sub-millimeter and Long-Wave Infra-Red photonics:**
 - ◇ Opens new methods due to Size, Weight and Power improvements, radio astronomy and THz spectroscopy

- **Telecom: inter and intra satellite communications.**
 - ◇ Can obtain large leverage from industrial efforts.



NASA Space Technology Mission Directorate (STMD)
Early Stage Innovation (ESI)
Integrated Photonics for Space Communication



- * Keren Bergman & Michal Lipson, Columbia University

Ultra-Low Power CMOS-Compatible Integrated-Photonic Platform for Terabit-Scale Communications

- * Seng-Tiong Ho, Northwestern University

Compact Robust Integrated PPM Laser Transceiver Chip Set with High Sensitivity, Efficiency, and Reconfigurability

- * Jonathan Klamkin, University of California-Santa Barbara,

PICULS: Photonic Integrated Circuits for Ultra-Low size, Weight, and Power

- * Paul Leisher, Rose-Hulman Institute of Technology

Integrated Tapered Active Modulators for High-Efficiency Gbps PPM Laser Transmitter PICs

- * Shayan Mookherjea, University of California-San Diego

Integrated Photonics for Adaptive Discrete Multi-Carrier Space-Based Optical Communication and Ranging

Program Summary

In addition to overall transceiver architecture, guided by our collaborators, we are developing a **silicon photonic interposer platform** for space optical communications.

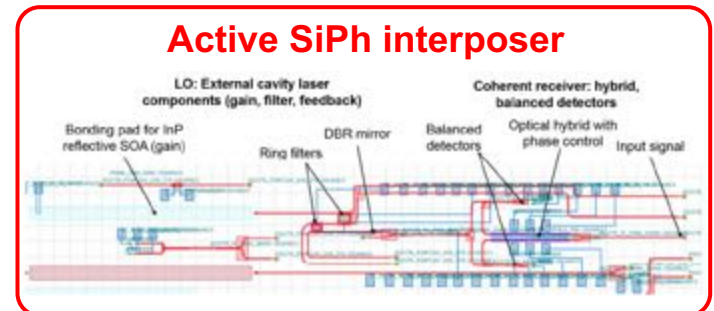
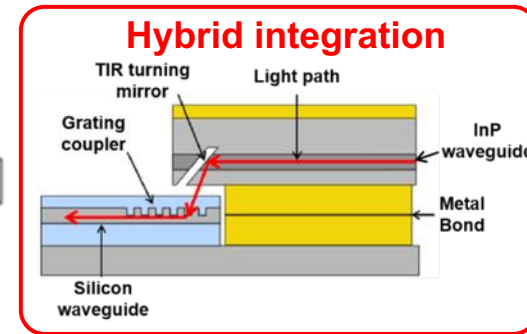
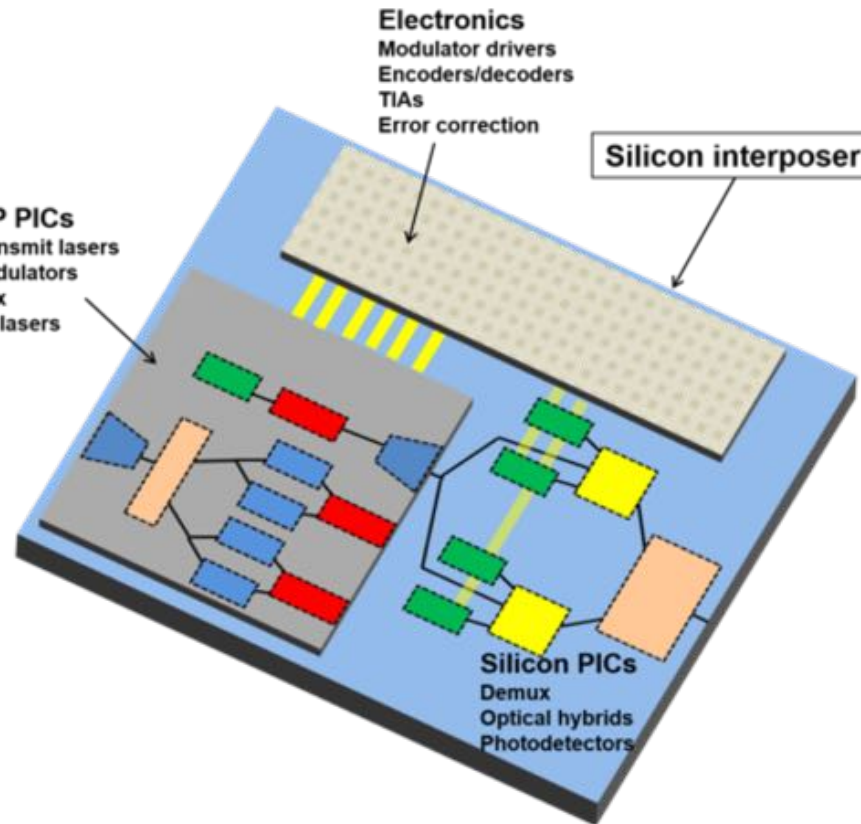
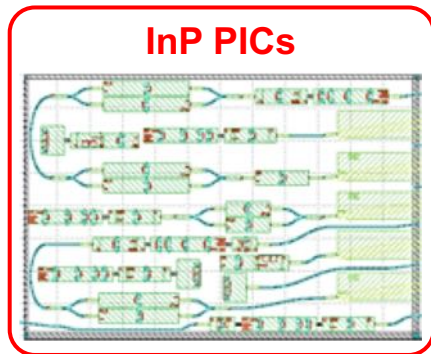

3D Hybrid Integration

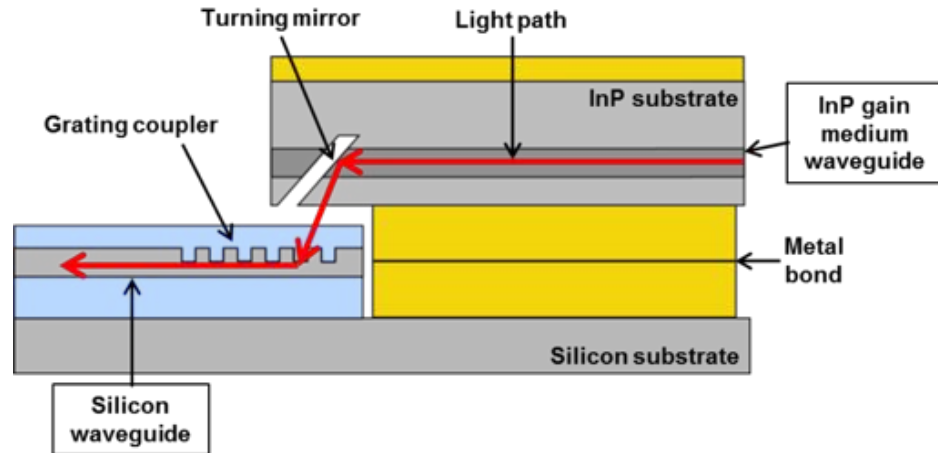

Power coupled to Si waveguide

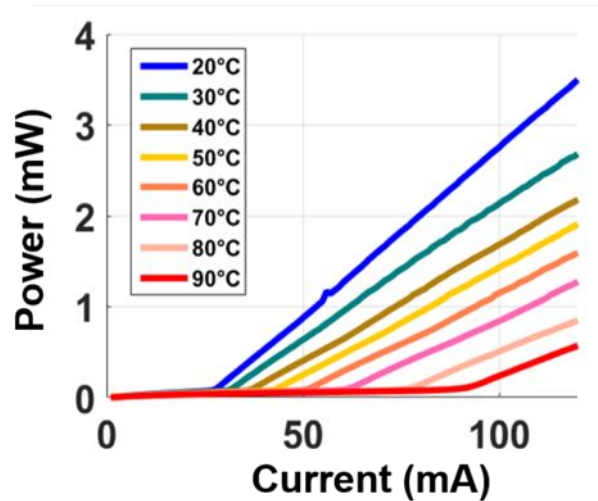

High Power Indium Phosphide PICs

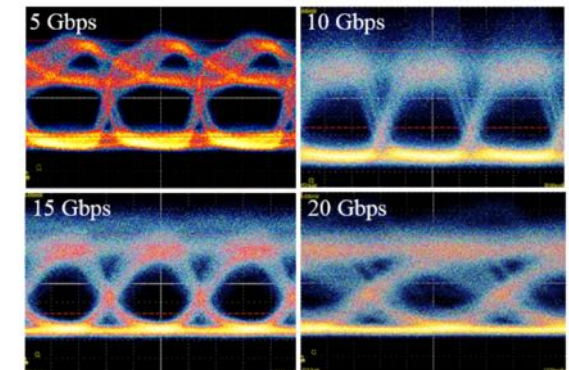
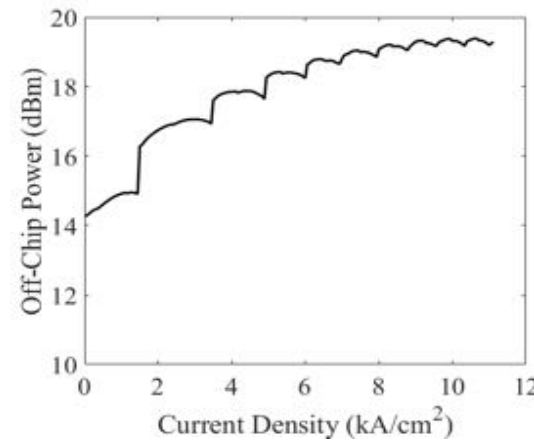
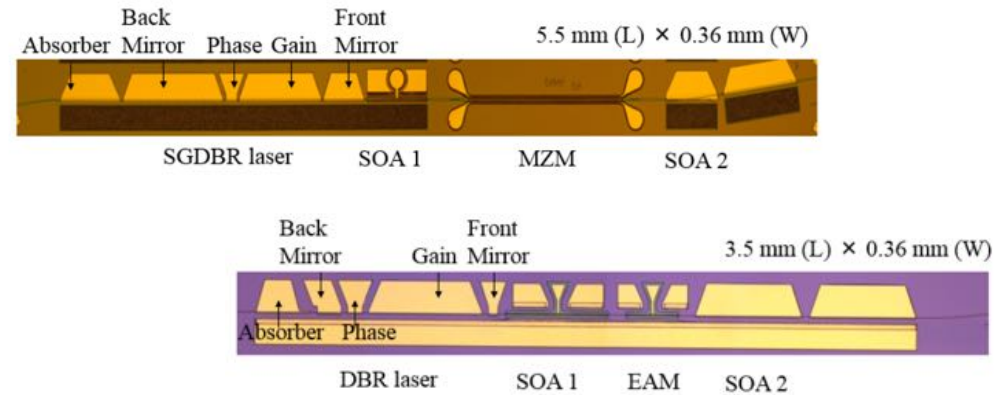



I. Generate variable # carriers from 1 seed.

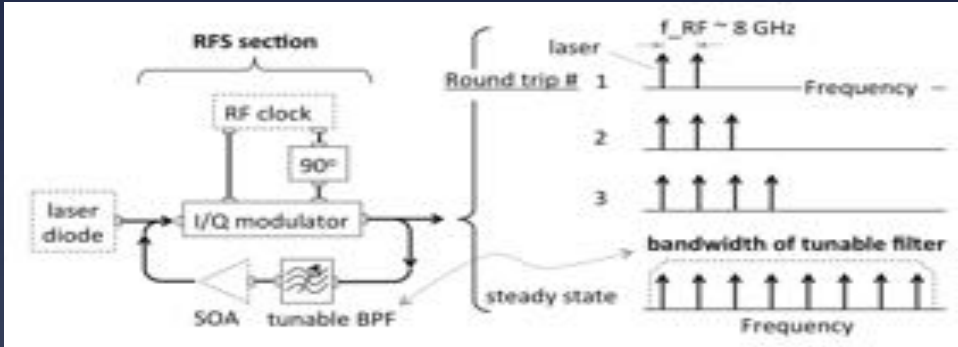
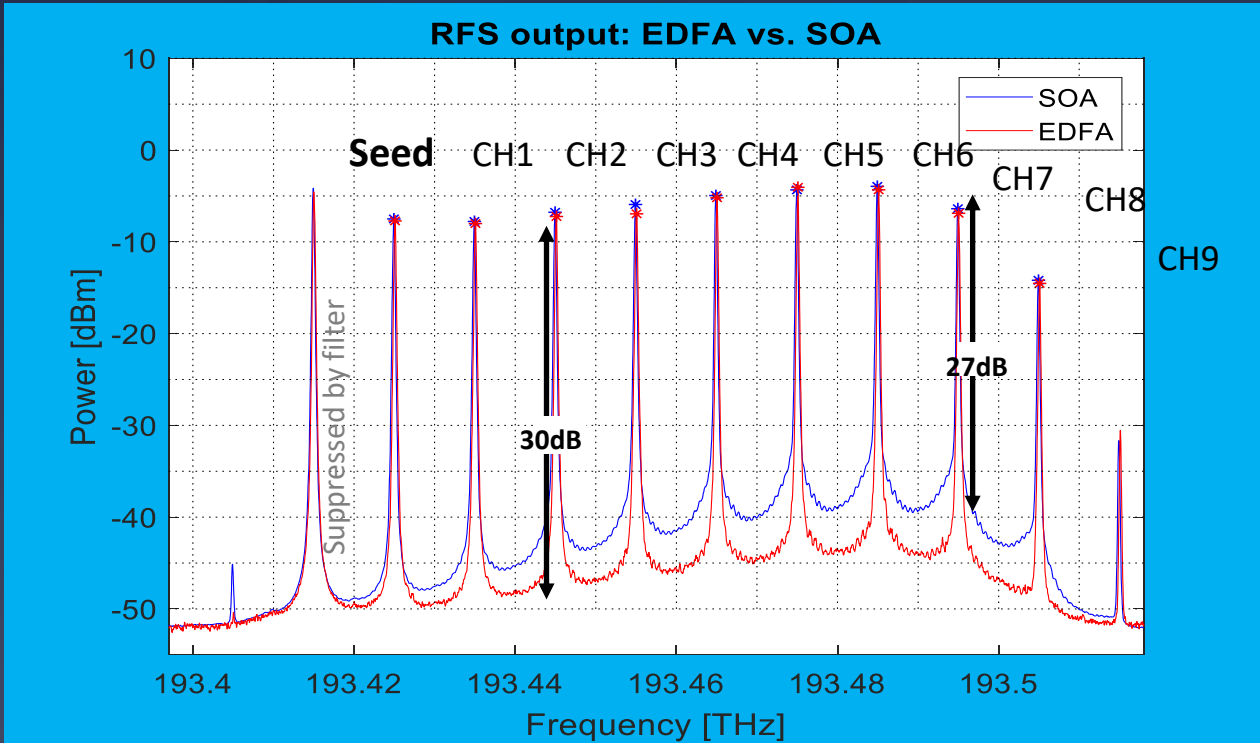

Flatness (deviation from mean power for tones 1-7 in spectral region where the filter has flat transmission):

EDFA:

Min: -1.51 dBm
Max: 1.52 dBm
Mean: 0.92 dBm

SOA:

Min: -1.76 dBm
Max: 1.88 dBm
Mean: 0.98 dBm

Penalty < 0.1 dB

X. Wang and S. Mookherjea, "Performance Comparisons between Semiconductor and Fiber Amplifier Gain Assistance in Recirculating-Frequency-Shifter" Optics Letters Vol. 43 No. 5, 1011-1014 (2018).

X. Wang and S. Mookherjea, "Optimizing Recirculating-Frequency-Shifter performance with Semiconductor Optical Amplifier gain assistance" CLEO 2018 Proceedings of the Conference on Lasers and Electro-optics, paper JW2A.63 (2018).



II. Directly achieve 100 Gbit/s NRZ, PPM etc.

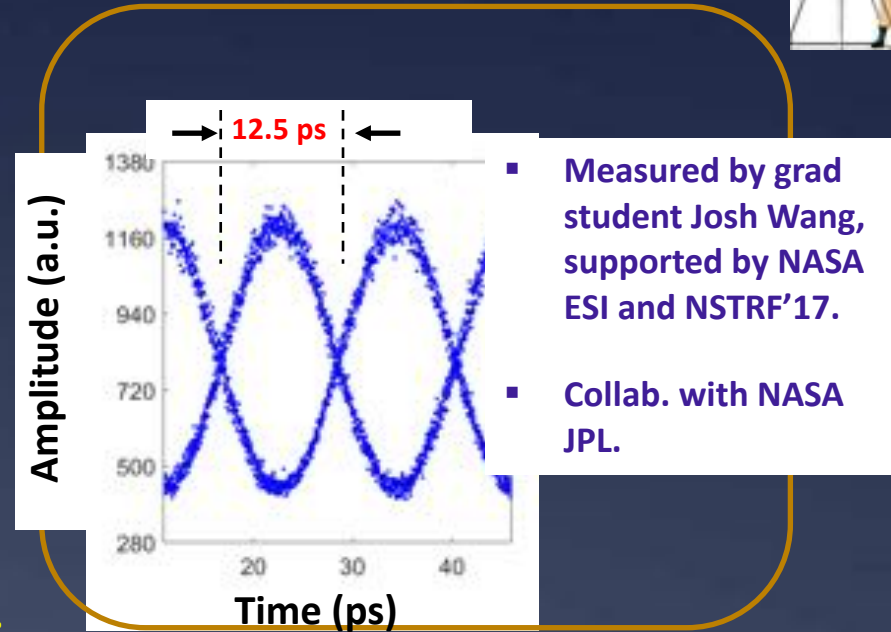
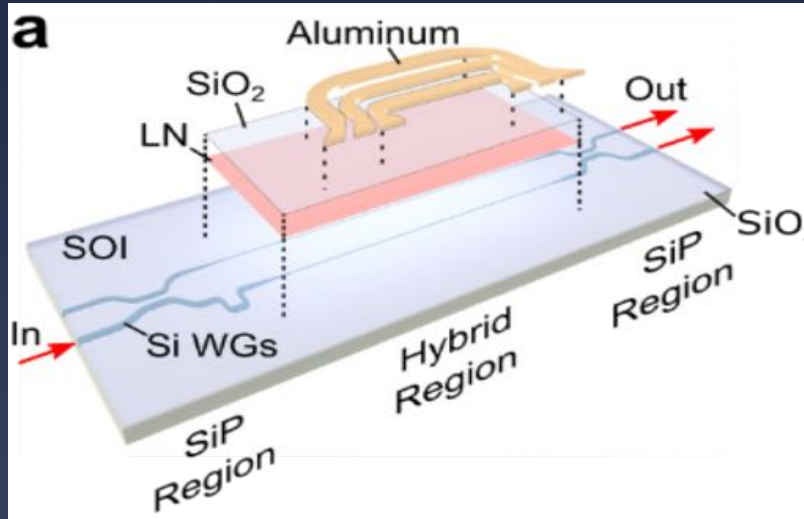

- Electro-optic BW: 1.5 dBe BW ~ 106 GHz, measured. **3 dBe BW estimated >> 200 GHz.**
- Eye SNR > 10 dB beyond 60 GHz.
- Half-wave Voltage ~ 10 V versus 4.4 Volts for Harvard-Bell Labs etched LN. We have re-design (LN thickness) underway to achieve ~5 V, without etching, achieving comparable performance eventually.

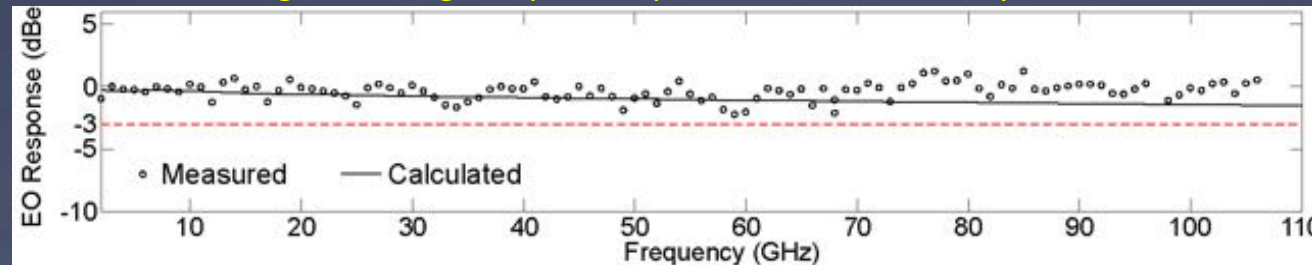

P. O. Weigel, J. Zhao, K. Fang, H. Al-Rubaye, D. Trotter, D. Hood, J. Mudrick, C. Dallo, A. Pomerene, A. Starbuck, C. DeRose, A. Lentine, G. Rebeiz and S. Mookherjea "Bonded Thin Film Lithium Niobate Modulator on a Silicon Photonics Platform Exceeding 100 GHz 3-dB Electrical Bandwidth" **Optics Express** Vol. 26, No. 18, 23728-23739 (2018) [URL]

Ultra-Low Power CMOS-Compatible Integrated Photonic Platform for Terabit-Scale Communications

Photonic Integration Platform for 2D Material Monolayers

- CMOS fabrication is mature and low cost, but suffers in optical loss and power consumption
 - Embed monolayers of 2D materials (graphene, WS₂, MOS₂) in CMOS-compatible photonic waveguides
- 2D materials enable large changes in the refractive index with minimal power consumption and provide pure dielectric response without any associated absorption

Principle of Device Operation

- Evanescent tail of confined optical mode interacts with embedded monolayer
 - Electric field must be in plane with monolayer for mode overlap (TE mode strongly interacts)
- Applied voltage leads to ion accumulation in monolayer (capacitive doping)
 - Average carrier density of $1.5 \times 10^{13} \text{ cm}^{-2}$ in WS₂

Fabrication Flow

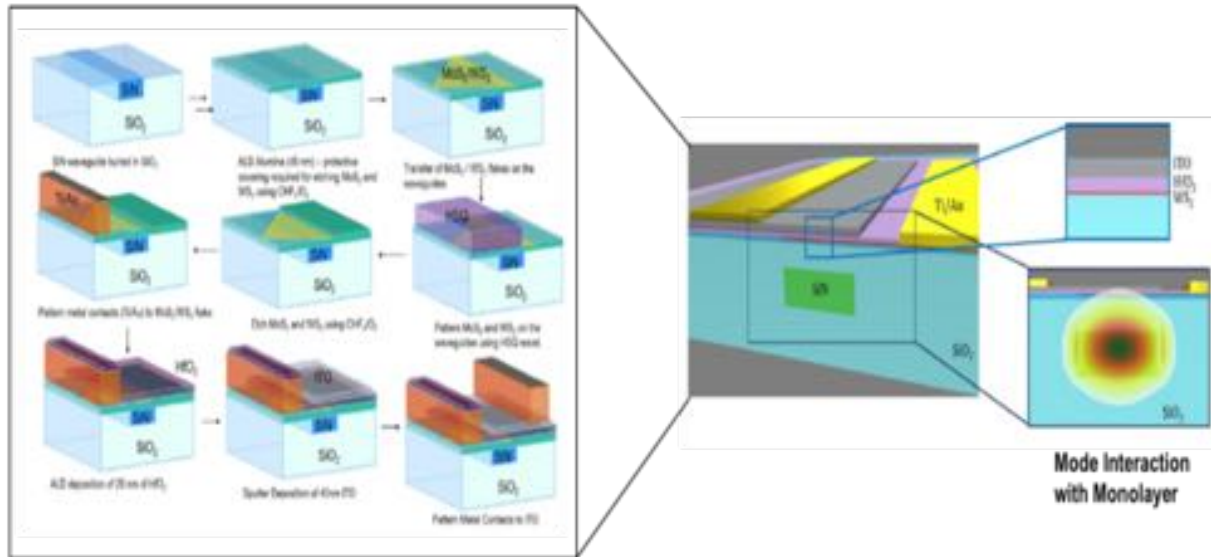

Mode Interaction with Monolayer

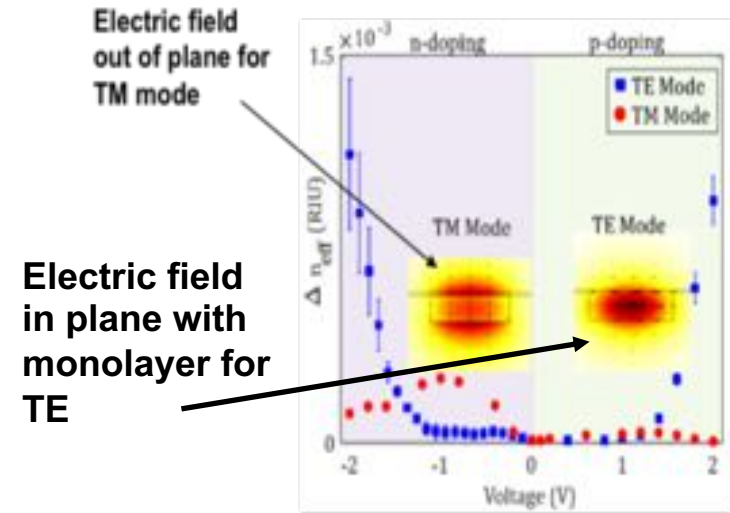
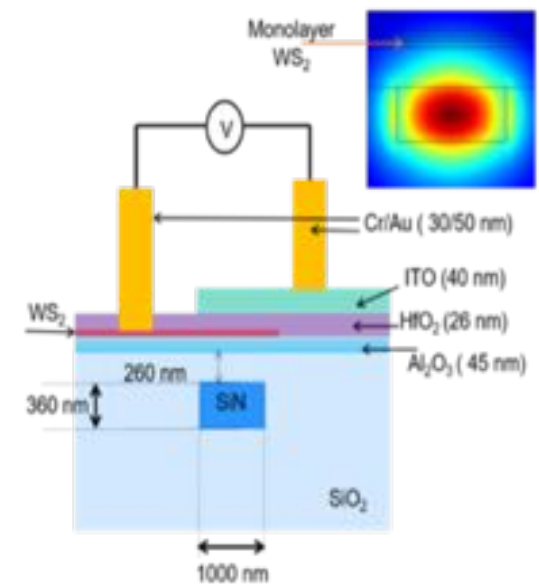

I. Datta et al., "Composite photonic platform based on 2D semiconductor monolayers," CLEO (2019)

I. Datta et al., "Giant electro-refractive modulation of monolayer WS₂ embedded in photonic structures," CLEO (2018)

Ultra-Low Power CMOS-Compatible Integrated Photonic Platform for Terabit-Scale Communications

Advantages of 2D Monolayers for Modulation and Switching

- Low electrical power consumption and low optical loss
 - Carrier injection/extraction based modulation introduces excess loss due to free carrier absorption
- Pure phase modulation (negligible absorption modulation)
 - Measured phase efficiency of $V_{\pi}L = 0.8$ V-cm in WS_2 device with induced absorption of $\alpha = 0.01$ dB/cm

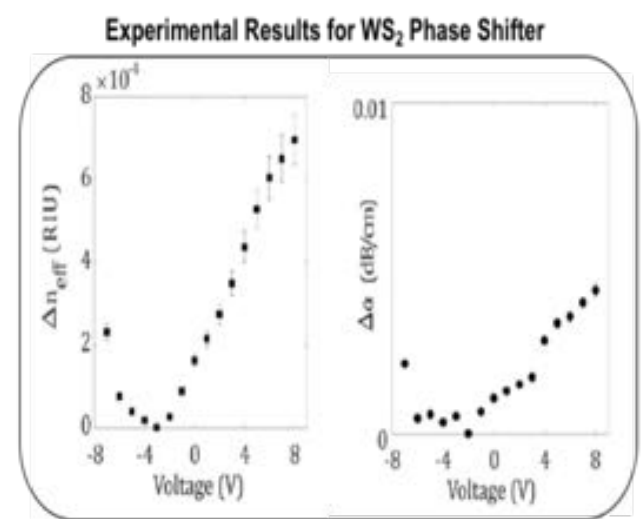
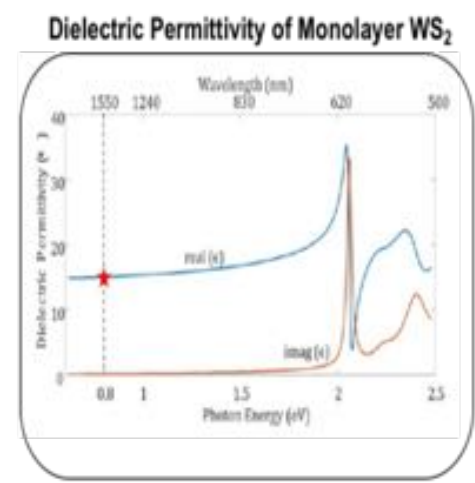

Mach Zehnder Switch Element with WS_2 Monolayer Phase Shifter

- Experimentally demonstrated MZI switching element with WS_2 monolayer embedded in single arm
 - Results verify strong phase shift with applied bias and minimal absorption modulation
- Individual switching elements can be combined in high radix switches
 - Enables scalable, reconfigurable photonic switch fabrics with low power consumption

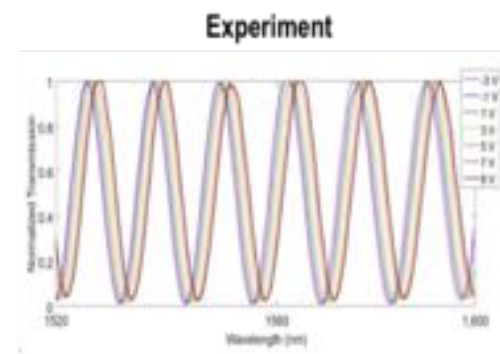
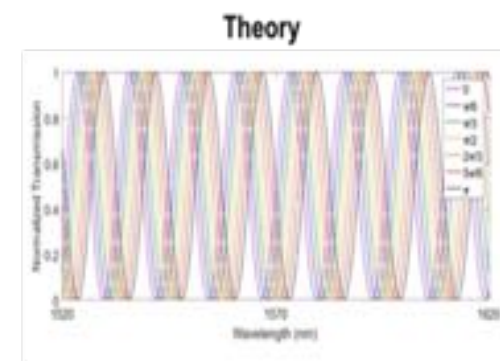
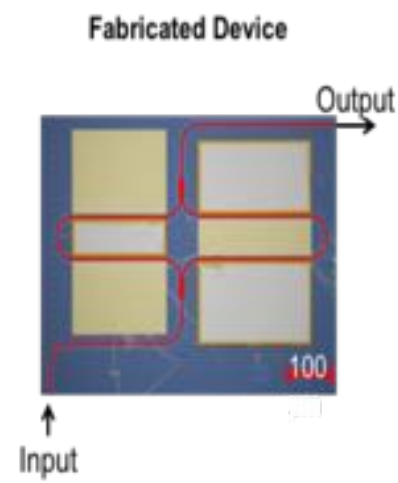

Y. Li et al., "Measurement of the optical dielectric function of monolayer transition-metal dichalcogenides," *Phys. Rev. B* **90**, 205422 (2014)



Program: Early Stage Innovation
PI: Seng Ho – Northwestern University
Compact Integrated PPM Laser Transceiver Chip Set with High Robustness and Re-Configurability



Approach: Use Silicon Photonics Passive-Active Photonic Device Integration Technology with Optical Gain Capability

Diffraction Grating based-Single-Frequency Laser

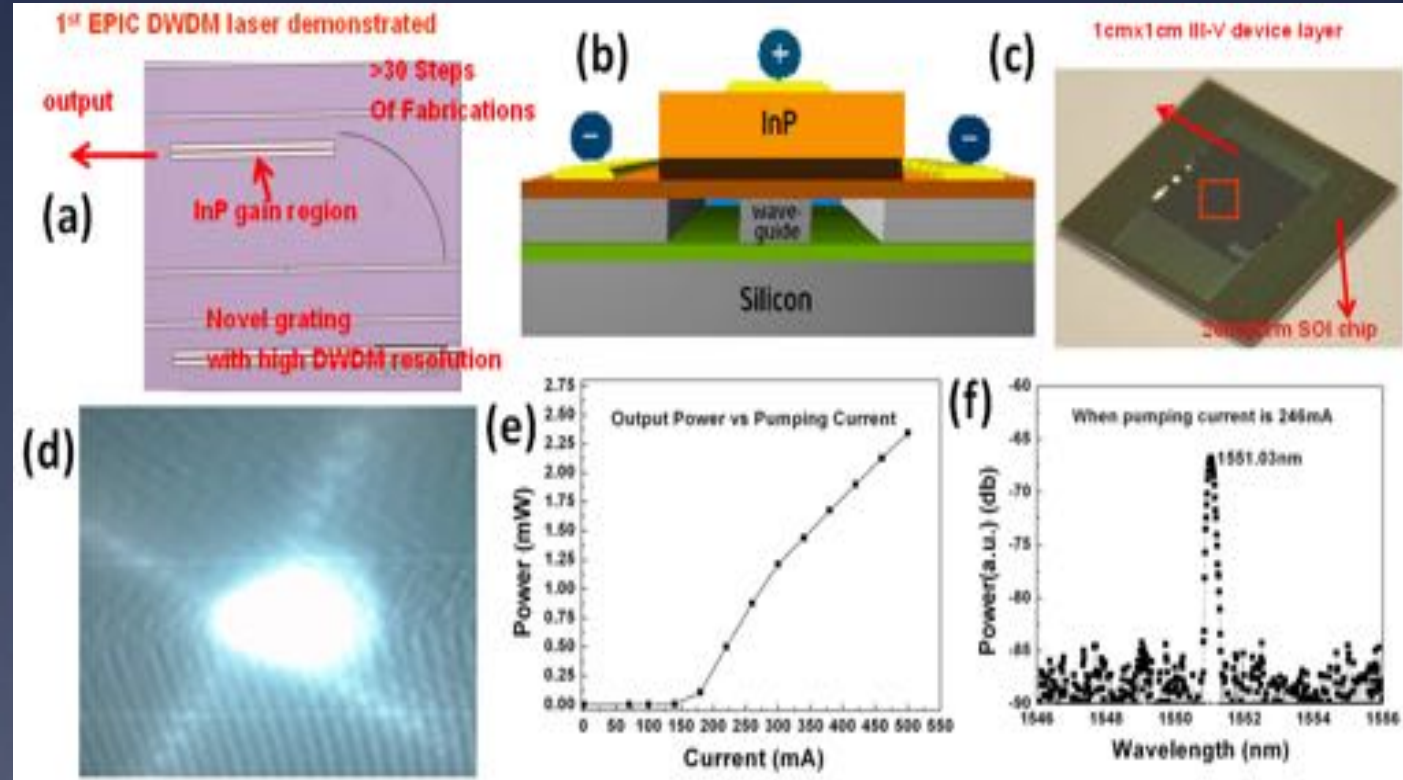
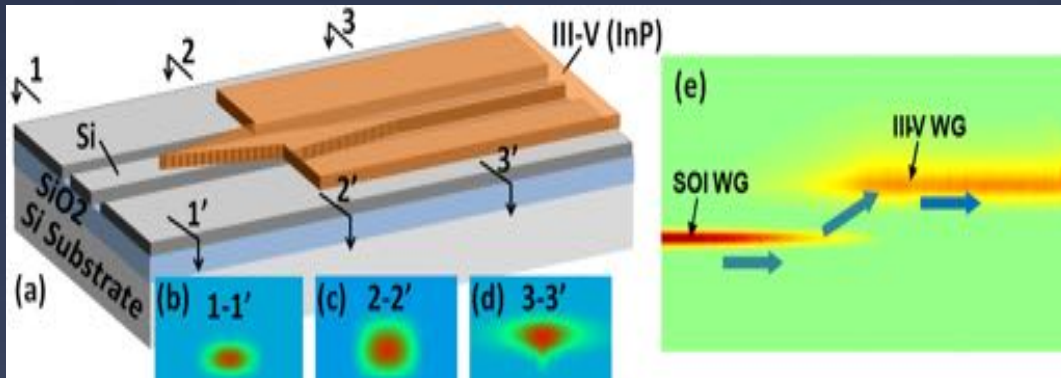

The basic processes are based on Diffraction Grating laser on Si (SOI) substrate.



Program: Early Stage Innovation

PI: Seng Ho – Northwestern University

Compact Integrated PPM Laser Transceiver Chip Set with High Robustness and Re-Configurability

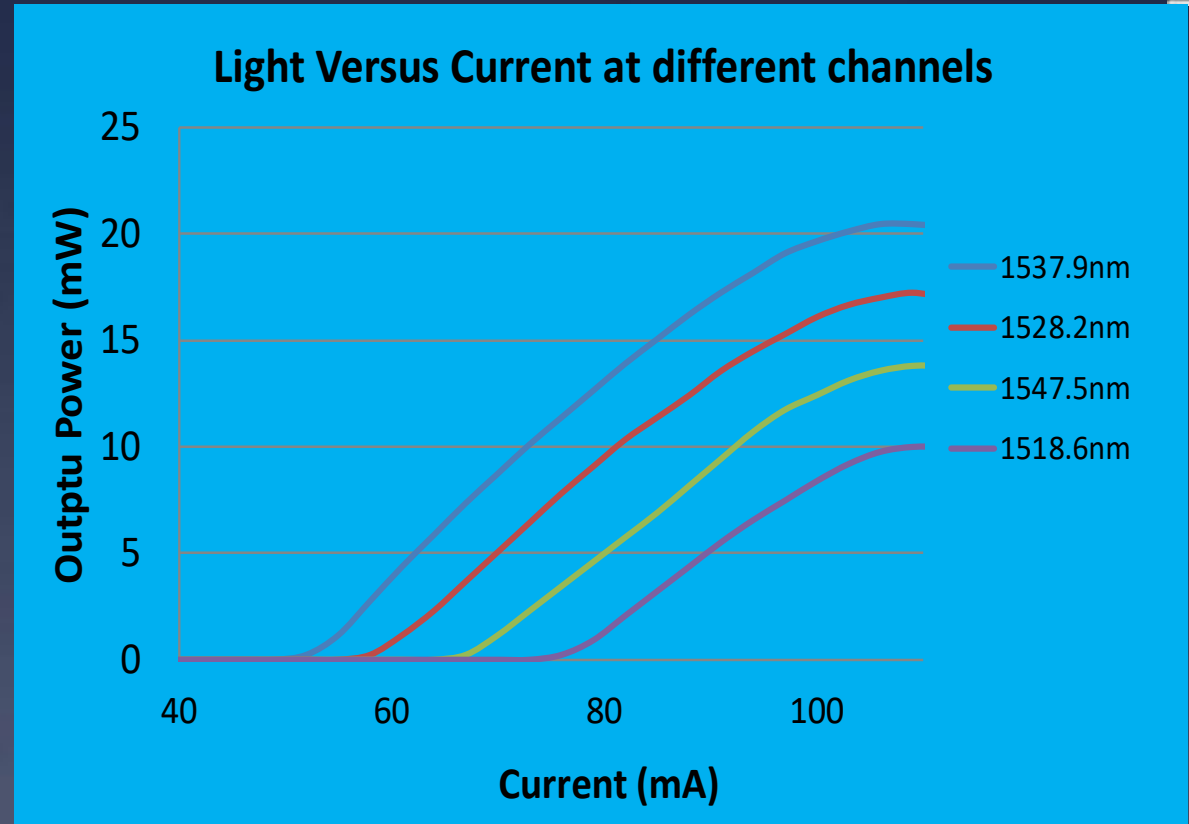
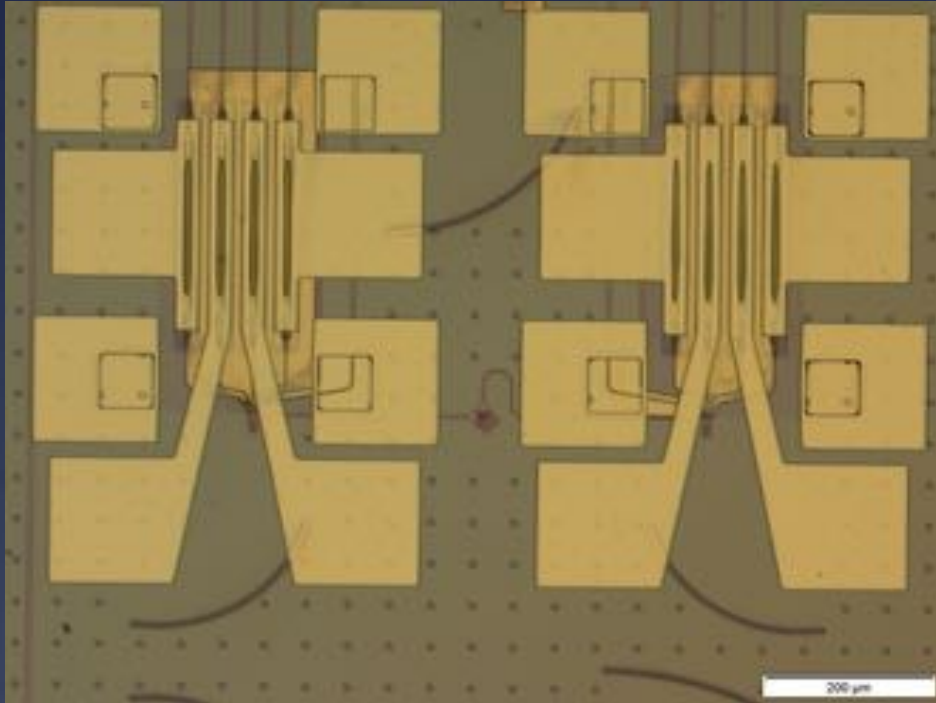

Output powers at 4 different channels for the laser chip



NASA Space Technology Mission Directorate (STMD)
Early Career Faculty (ECF)



Topic: Space Communication – M. Krainak (2014 - 3 year award)

* Jonathan Klamkin, University of California-Santa Barbara,

HELIOS: Heterogeneous Laser Transmitter Integration for Low SWaP

**Topic: Integrated Photonic Sensors and Science Instrument Subsystems – M. Stephen
(2018 - 3 year award)**

* Tingyi Gu, University of Delaware

Hybrid integration of nonlinear crystals on silicon photonics for space communication and sensing

* Xingjie Ni, The Pennsylvania State University

Ultra-compact On-chip Integrated Spectrometers based on Metasurfaces

* Songbin Gong, University of Illinois at Urbana-Champaign

Lithium Niobate Based Photonic Integrated Circuits for Reconfigurable Sensing and Signal Processing



Program: Early Career Faculty
 PI: Dr. Tingyi Gu, University of Delaware

Hybrid integration of nonlinear crystals on silicon photonics for space communication and sensing

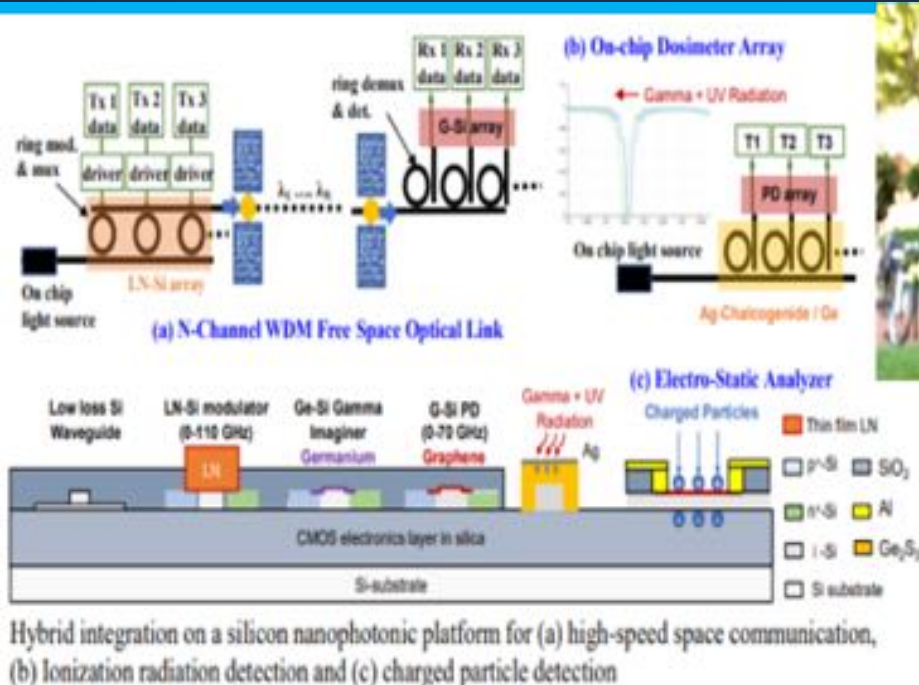

Tapeout Sep. 2018

Silicon Photonics – wireless interface

- Silicon photonics-wireless interface (PWI) ICs for millimeter-wave fiber-wireless networks
- Active components based on nonlinear crystals
 - E/O and O/E converters



The Laser Communications Relay Demonstration (LCRD) is a NASA mission that will test the use of laser light to transfer data from orbit to ground and all around the Solar System

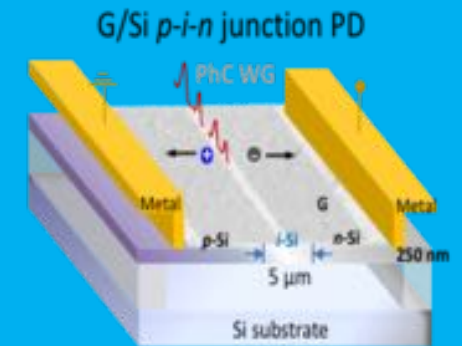

T. Li (Gu), *NPJ 2D Materials and Applications* 2, 36 (2018)

LiNbO₃ on Si modulator

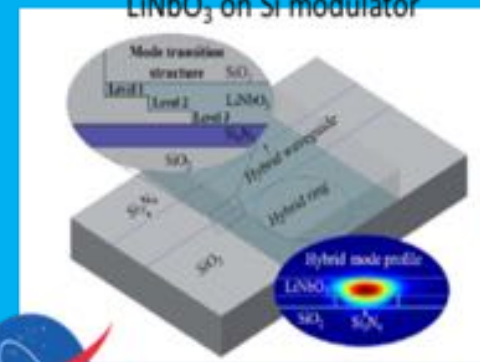

Abu Naim R. Ahmed (Prather), *Optics Letters* 43, 4140 (2018)

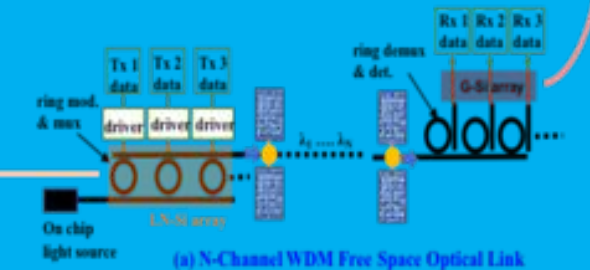

Hybrid integration on a silicon nanophotonic platform for (a) high-speed space communication, (b) Ionization radiation detection and (c) charged particle detection

- Ultrafast and low power optoelectronic link enabled by hybrid silicon photonics
- In-situ instruments and sensors to fields and particles for space weather observations

Media reports:

https://www.nasa.gov/directorates/spacetech/strg/ecf17/Hybrid_Integration_of_Nonlinear_Crystals_on_Silicon_Photonics

<https://www.udel.edu/udaily/2017/august/tingyi-gu-nasa-grant-photonic-devices/>





Broader band optical interconnect: graphene integration

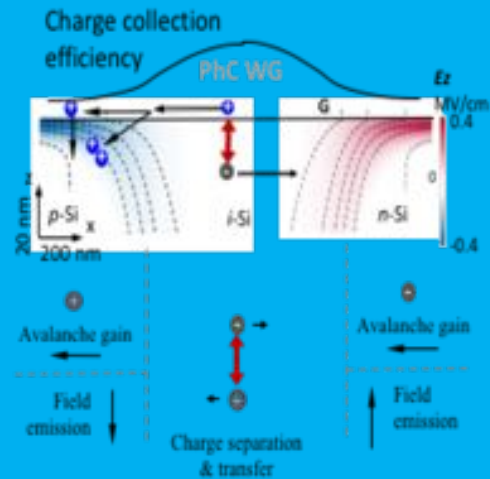

- Operation mechanism: Separate Absorption, Charge, and Multiplication (SACM) APD on the graphene-silicon two dimensional junction
- Device schematics of graphene on active silicon photonic crystal waveguide: ultrafast low noise photodetector
- SNR > 50dB @ 40 GHz (critical for single photon detection on chip)

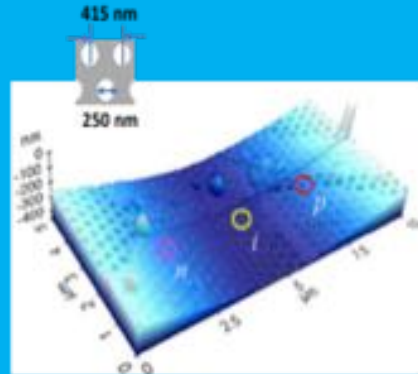
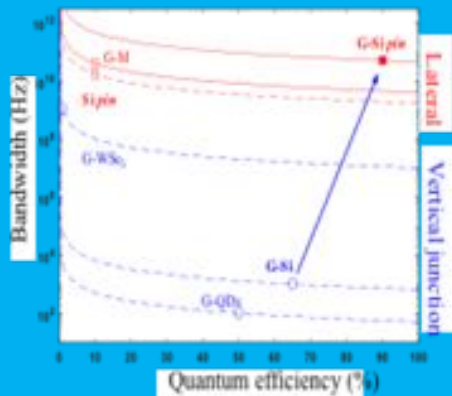

Band diagram of photo-thermionic generated hot carriers on graphene-intrinsic silicon interface

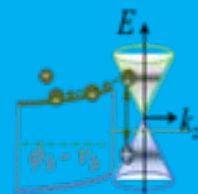

Broader band optical interconnect: graphene integration

RC constant limit of the hybrid p-i-n diode > 110 GHz

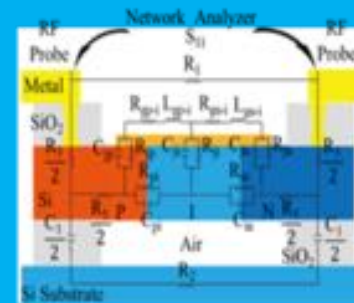

Small signal model

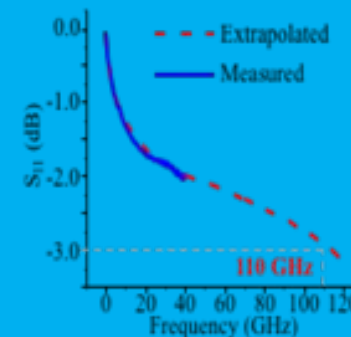

RC constant limitation

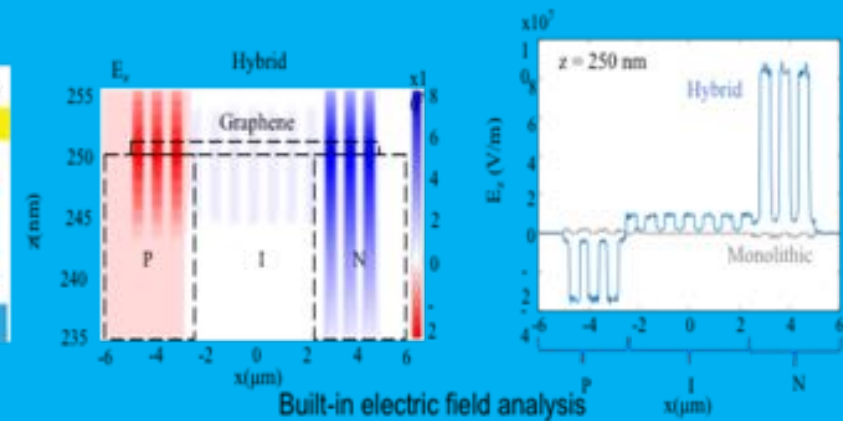

Built-in electric field analysis

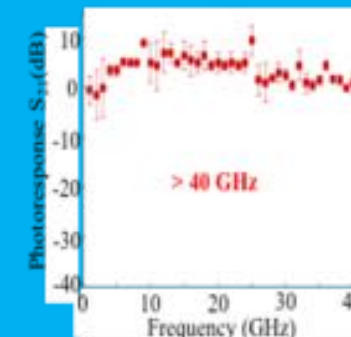

Optoelectronic response

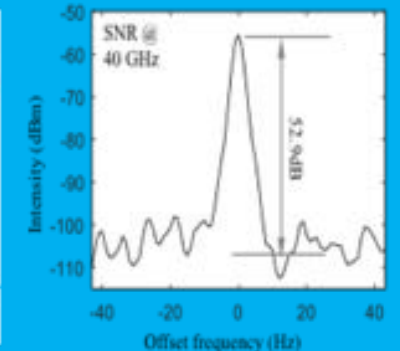



Engineered nanostructures directly change the light properties: phase, amplitude, and polarizations, etc.

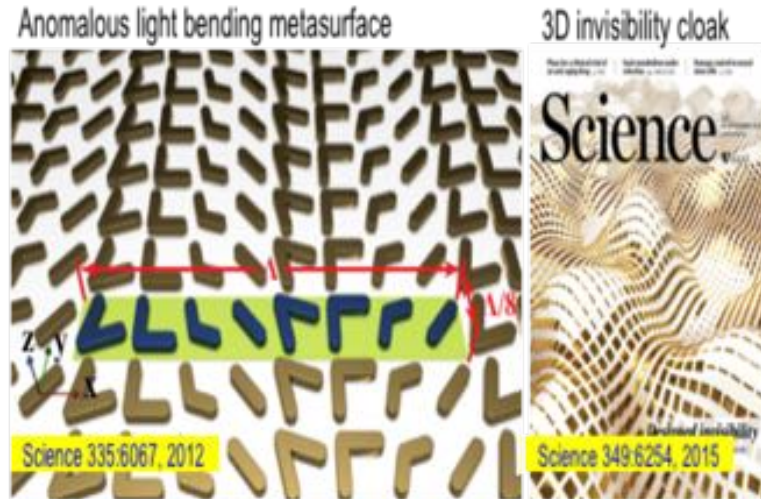
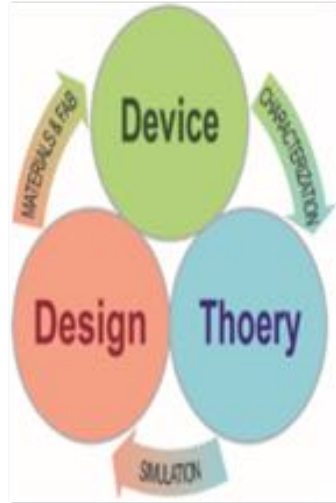

Metasurface – a 2D nanostructure *directly* manipulates light behaviors: 2D works better than 3D!

Nano-antennas – Antennas for light

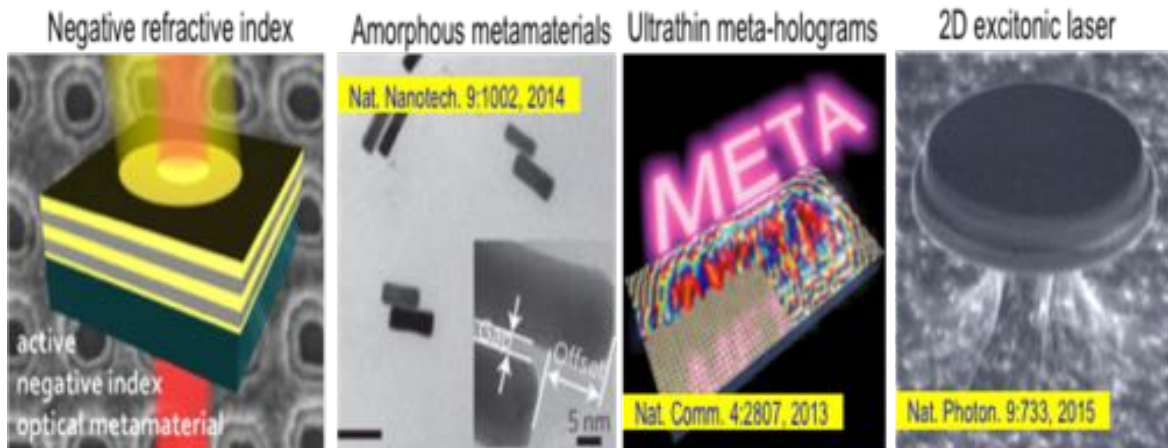
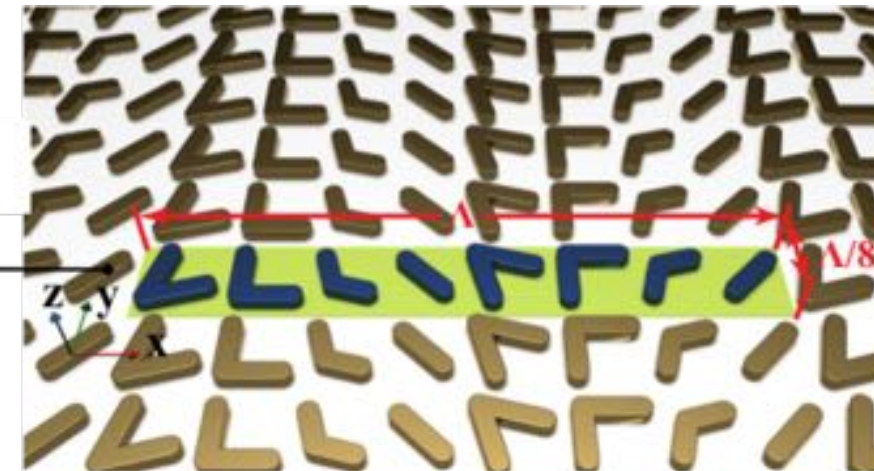

Low foot print, compact, cost efficient, easy integration, low loss, etc.

X. Ni, Science, 2012

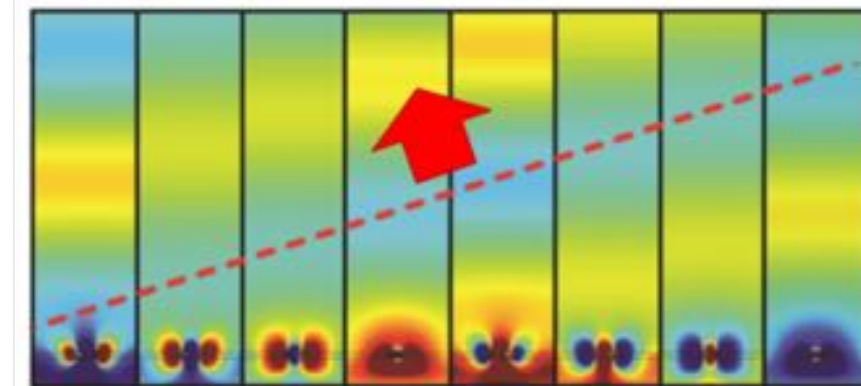

Phase control of guided wave – integrated spectrometers

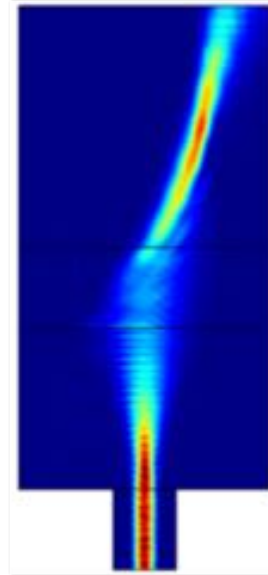
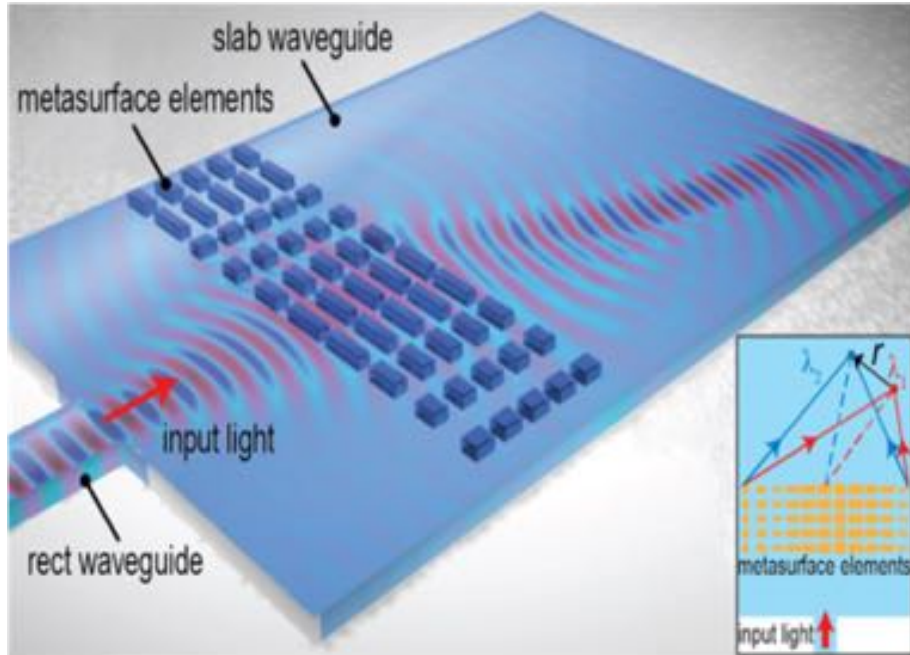

- The nanoantennas on top of a waveguide can provide phase shift to the transmitted guided wave as well.
- An off-axis lens can be formed in a dielectric slab waveguide by generating a corresponding phase profile
- Spectral information of the input can be read out by spatial location of the focus

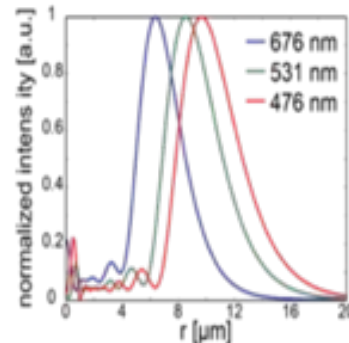

Nanofabrication and characterization of the integrated spectrometers

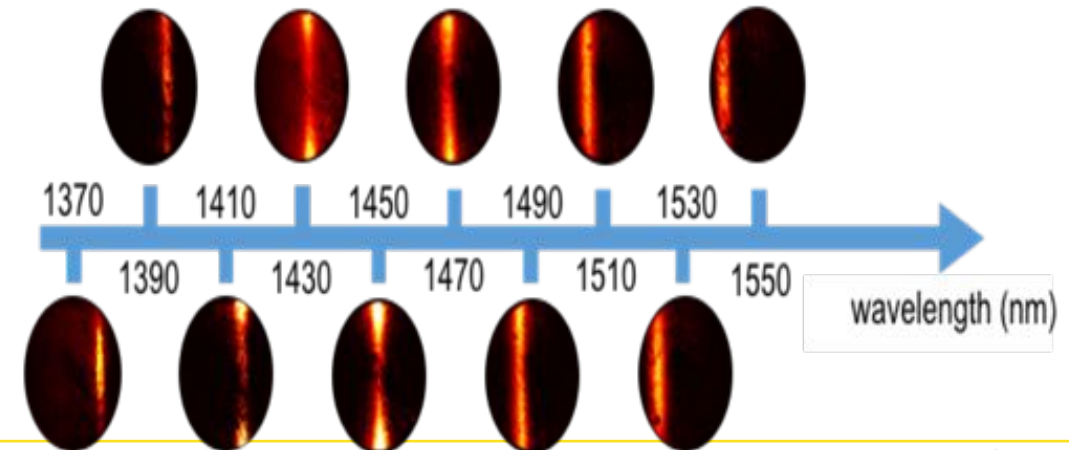
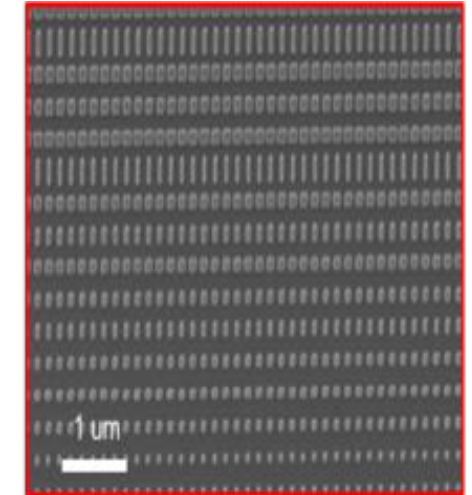



NASA STTR

Photonic Integrated Circuits

2016 awards (Completed)



Title	Company	University
Integrated Optical Transmitter for Space Based Applications	Freedom Photonics, LLC	University of California, Santa Barbara
Photonic IC Spectrometer for Spacecraft	Nanohmics, Inc.	Catholic University of America
Integrated InAs QD Laser Based Si Photonic Optical Transceiver	Zenith Optronics LLC	University of Massachusetts Lowell
Thin Film Lithium Niobate Microring Modulators for Analog Photonics	Partow Technologies LLC	University of Central Florida



NASA STTR

Photonic Integrated Circuits

2017 awards – Phase 1



Title	Company	University
Heterogeneous Silicon Photonics OFDR Sensing System	Luna Innovations, Inc.	University of California, Santa Barbara
High Performance 3D Photonic Integration for Space Applications	Freedom Photonics, LLC	University of California, Santa Barbara
Tunable Opto-electronic Oscillator Based on Photonic Integration of Ultra-High Q Resonators on a SiN Chip	OEwaves, Inc.	University of California-Davis
Multifunctional Integrated Photonic Lab-on-a-Chip for Astronaut Health Monitoring	Intelligent Fiber Optic Systems Corporation	Stanford University

Program: STTR

PI: Dr. Andrey Matsko, Oewaves Partner: ProfS. J. B. Yoo, University of California-Davis

Tunable OEO based on photonic integration of ultra-high Q resonators on a SiN chip

The team comprising OEwaves Inc. and UC Davis offers to develop and demonstrate a SiN-platform integrated photonic circuit suitable for a spectrally pure chip-scale tunable Kerr opto-electronic RF oscillator (KOEO) that can operate as a flywheel in high precision optical clock modules, as well as radio astronomy, spectroscopy, and local oscillator in radar and communications systems. The effort comprises integration of an ultra-high quality (Q) crystalline whispering gallery mode (WGM) microresonator with multiple lithographically defined photonic and electronic components and devices (including a laser, a detector and waveguides) on a single platform with nanometer-scale feature sizes.

Metric	Phase I		Phase II (tentative)	
<i>Planar waveguide insertion loss</i>	5 dB		1 dB	
<i>Planar waveguide-WGM resonator coupling efficiency</i>	30%		70%	
<i>Q-factor of the integrated monolithic resonator</i>	10 ⁹		10 ¹⁰	
<i>RF frequency*</i>	30 GHz		30 GHz	
<i>RF frequency tuning range</i>	100 kHz		1 MHz	
<i>RF frequency tuning bandwidth</i>	10 kHz		100 kHz	
<i>Output power</i>	1 mW		10 mW	
<i>Volume (physics package)</i>	3 cc		1 cc	
<i>Weight</i>	10 g		5 g	
<i>DC power consumption</i>	2.5 W		0.25W	
<i>Phase Noise</i>	<i>Offset (Hz)</i>	<i>L_f(dBc/Hz)</i>	<i>Offset (Hz)</i>	<i>L_f(dBc/Hz)</i>
	1	-30	1	-30
	10	-60	10	-60
	100	-90	100	-90
	1,000	-120	1,000	-120
	10,000	-140	10,000	-140
	>1,000,000	-160	>1,000,000	-160

*Different RF frequency (~8-120 GHz) can be generated if desired

Program: STTR

PI: Dr. Andrey Matsko, Oewaves Partner: Prof. J. B. Yoo, University of California-Davis

Tunable OEO based on photonic integration of ultra-high Q resonators on a SiN chip

Prism Waveguide Development

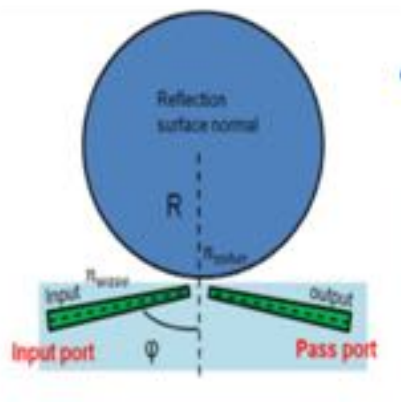

Embedded optical couplers enable mode matching of the SiN waveguides with the magnesium fluoride microresonator. The tapers are needed since the refractive index of the resonator is 1.37.

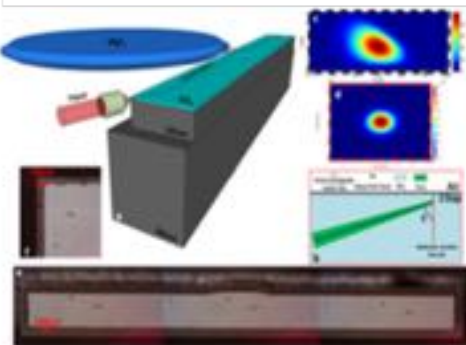

The waveguide was designed, created, and tested with the resonator. We used a well established evanescent field prism coupler to verify the coupling efficiency with the waveguide.



Supported by NASA and DARPA, see G. Liu, V. S. Ilchenko, T. Su, Y. C. Ling, S. Feng, K. Shang, Y. Zhang, W. Liang, A. A. Savchenkov, A. B. Matsko, L. Maleki, and S.J. Ben Yoo, "Low-loss prism-waveguide optical coupling for ultrahigh-Q low-index monolithic resonators," *Optica* 5 (2), 219-226 (2018).

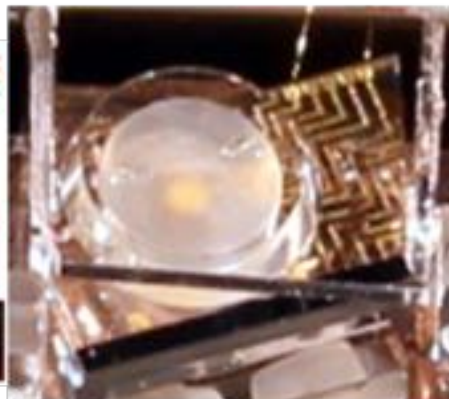

A whispering gallery mode resonator was integrated with waveguide and ~1 dB insertion loss was demonstrated. A self-injection laser was built using the configuration.

Resonator with PZT



The resonator was laminated with PZT to achieve Kerr comb actuation/period modulation.

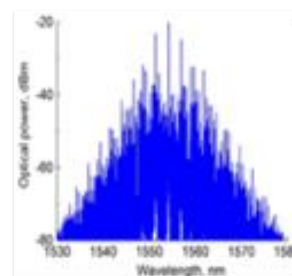

Tunable Kerr Frequency Comb NASA Demonstration



RF signal

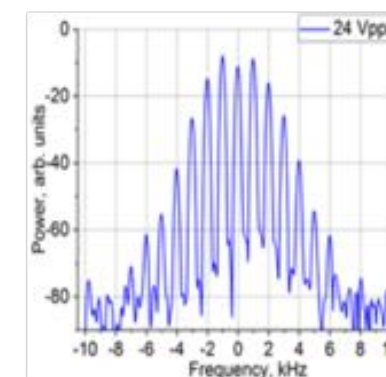

Frequency modulated RF signal

The Kerr optical frequency comb demodulated on a fast photodiode produced spectrally pure RF signal that became frequency modulated RF signal, where the RF modulation was applied by the PZT actuator.

Next step: true PIC integration of the oscillator in Phase II of the effort

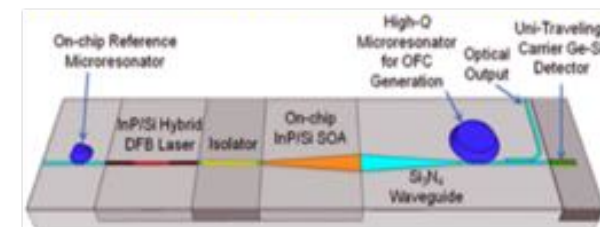



NASA STTR

Photonic Integrated Circuits

2017 awards – Phase 2

Title	Company	University
Integrated Optical Transmitter for Space Based Applications	Freedom Photonics, LLC	University of California, Santa Barbara
Multifunctional Integrated Photonic Lab-on-a-Chip for Astronaut Health Monitoring	Intelligent Fiber Optic Systems Corporation	Stanford University
Heterogeneous Silicon Photonics OFDR Sensing System	Luna Innovations, Inc.	University of California, Santa Barbara

Multifunctional Integrated Photonic Lab-on-a-Chip for Astronaut Health Monitoring

Photonic Integrated Circuit (PIC) Approach

- IFOS Bio*Sense™ is miniaturized, low-SWaP-C photonic integrated lab-on-chip biosensor
- Capable of real-time, multi-analyte detection using minimal sample
- From discrete components to platform integration
- Microfluidic channels enable continuous flow, future multiplexed detection

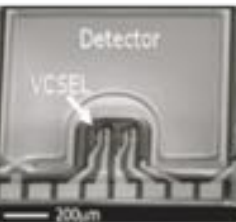
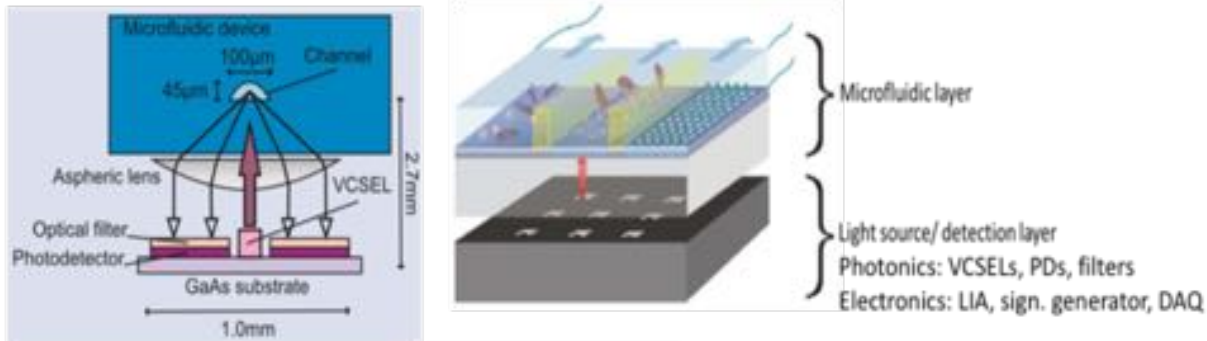

Benefits to NASA & Non-NASA Applications

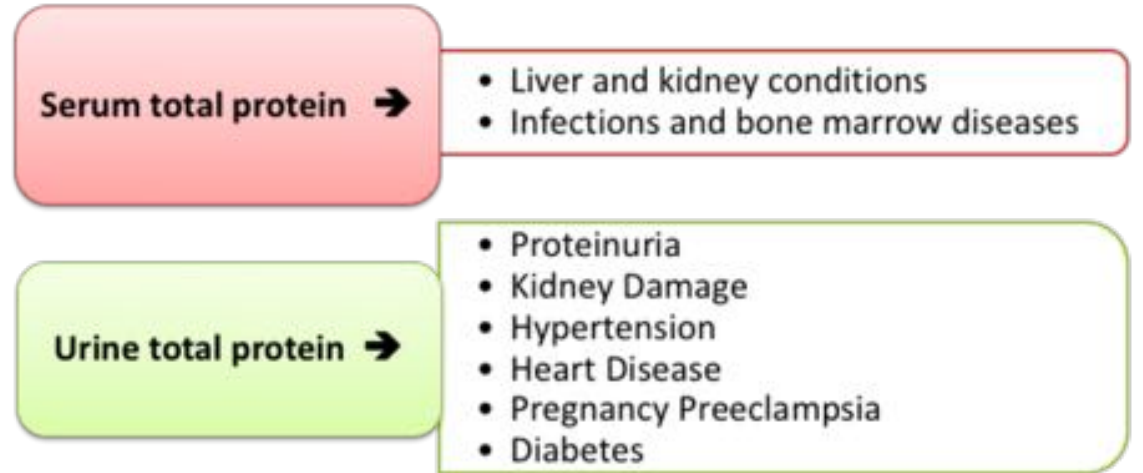

- Bio*Sense™ provides real-time, sensitive, accurate, and inexpensive portable testing
- IFOS-Stanford team envisions providing multi-analyte sensing in different body fluids (e.g. urine, saliva, sweat, tears) that will be even less invasive

IFOS Bio*Sense™ Product Concept

Bio*Sense™ offers portability with design for space reliability

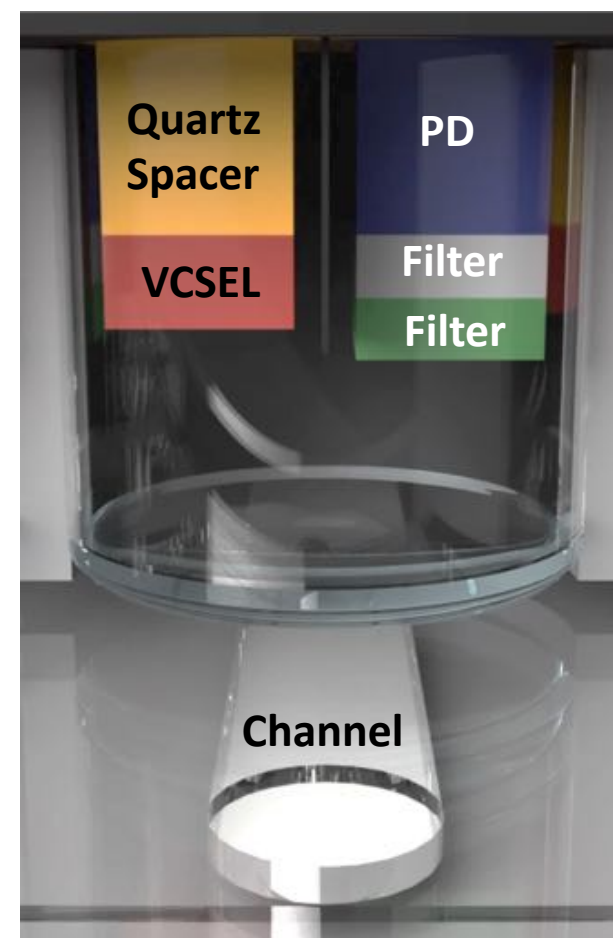
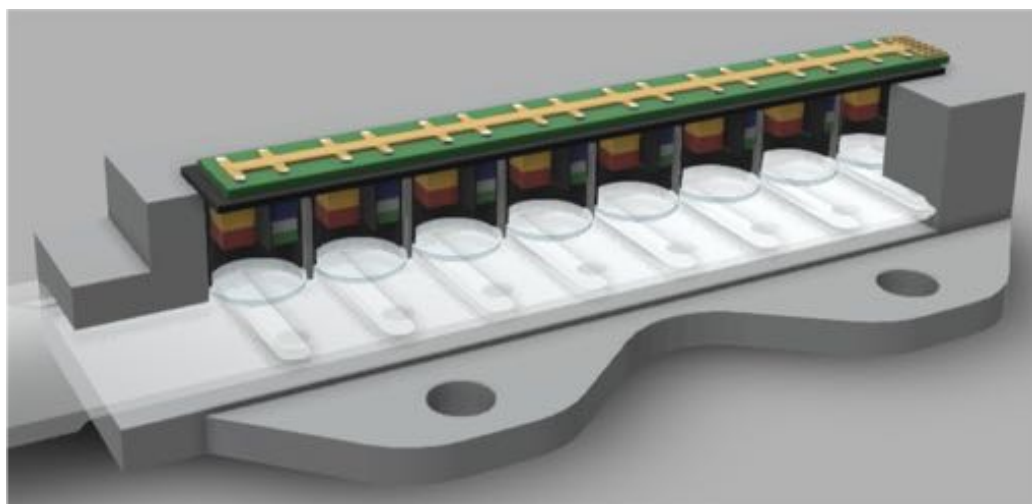
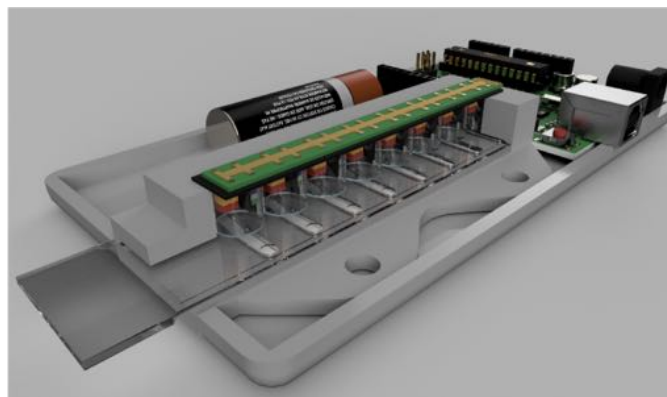

Replicating OFDR Network on PIC

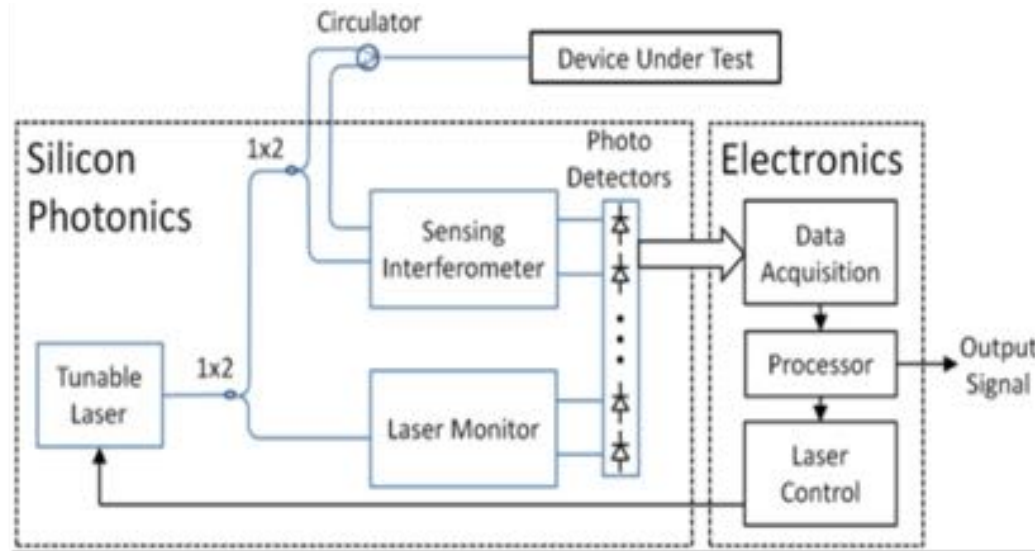

High-level system architecture for silicon photonics OFDR system.

Key components:

- Laser
- Couplers/splitters
- Delay line
- Complex receiver for laser monitor and sensing interferometers
- Sensing receiver must also be polarization diverse: polarization manipulation components required

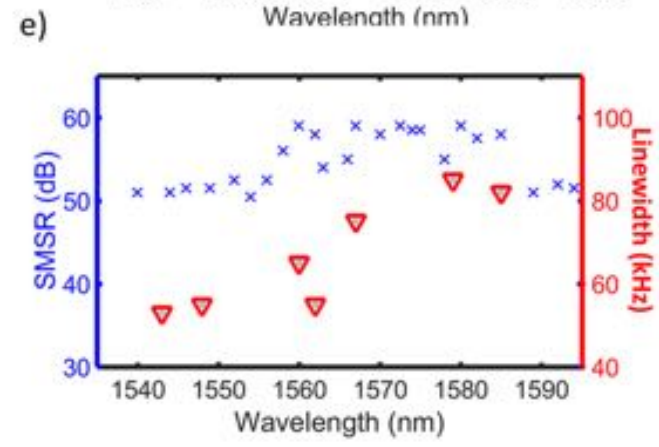
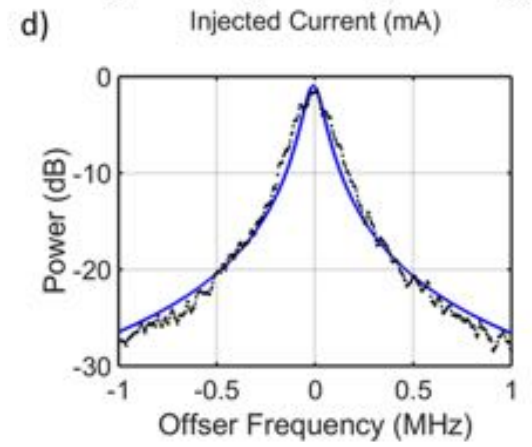
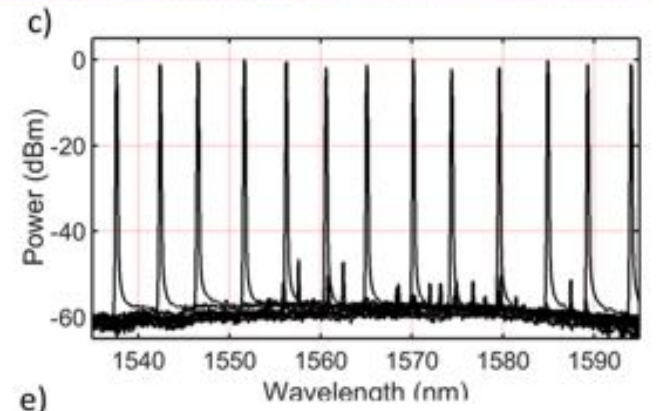
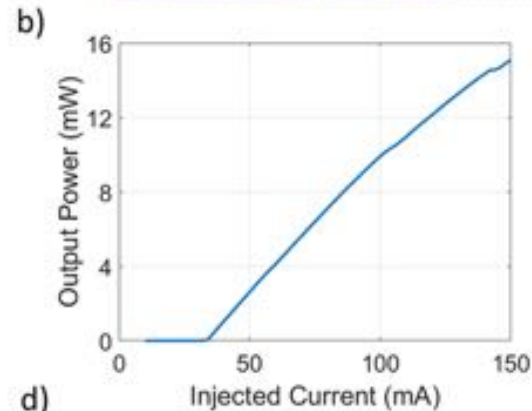
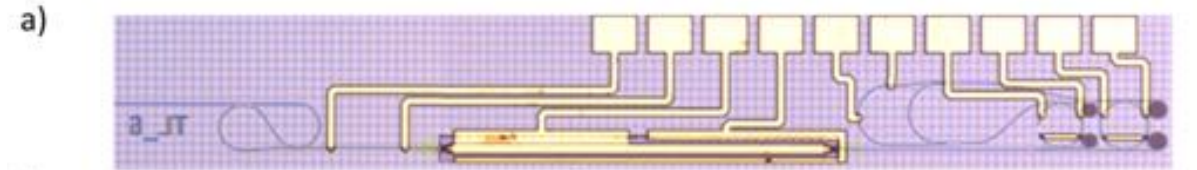

a) Image of fabricated laser b) $I_{\text{threshold}} = 34 \text{ mA}$, with $P = 15 \text{ mW}$ @ 150 mA c) Stepped tuning range of 55 nm in 3.2 nm steps d) 52.5 kHz linewidth e) $50\text{-}60 \text{ dB}$ SMSR

Delay Line Challenges

- A delay line is necessary in the laser monitor interferometer, which is used to correct for laser tuning nonlinearities
- Example: 1 m spiral Si_3N_4 waveguide on SiO_2

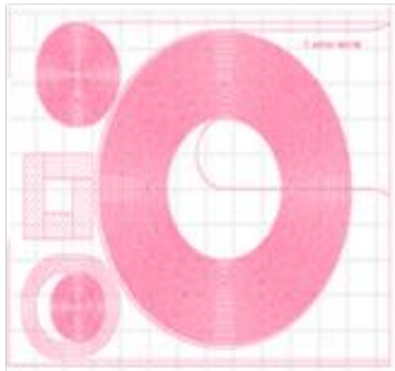

Actual size of spiral delay line on PIC - 1 cm^2

UCSB

- Delay line optical path length should ideally be appreciable fraction of max sensor length
- Si waveguides generally have higher loss than SiO_2 or Si_3N_4 but superior to InP
- Several designs in Si waveguides were prototyped; further trials needed to improve loss

- Luna has partnered with UCSB to implement an OFDR sensing system using heterogeneous Si photonics.
- We demonstrated an OFDR sensor interferometer network with coherent receiver fabricated in Si waveguide on SiO_2 with external laser
- Demonstrated a hybrid silicon laser suitable for integration with above OFDR PIC:
 - 15 mW, 55 nm tuning range, 52.5 kHz best linewidth, > 50 dB SMSR
- Future work:
 - Implement polarization diverse coherent receiver on PIC
 - Improve delay line loss
 - Integrate laser with OFDR network
 - Explore manufacturing and packaging issues via American Institute for Manufacturing Integrated Photonics (AIM Photonics)

Probe Protein Patterning and Sensing

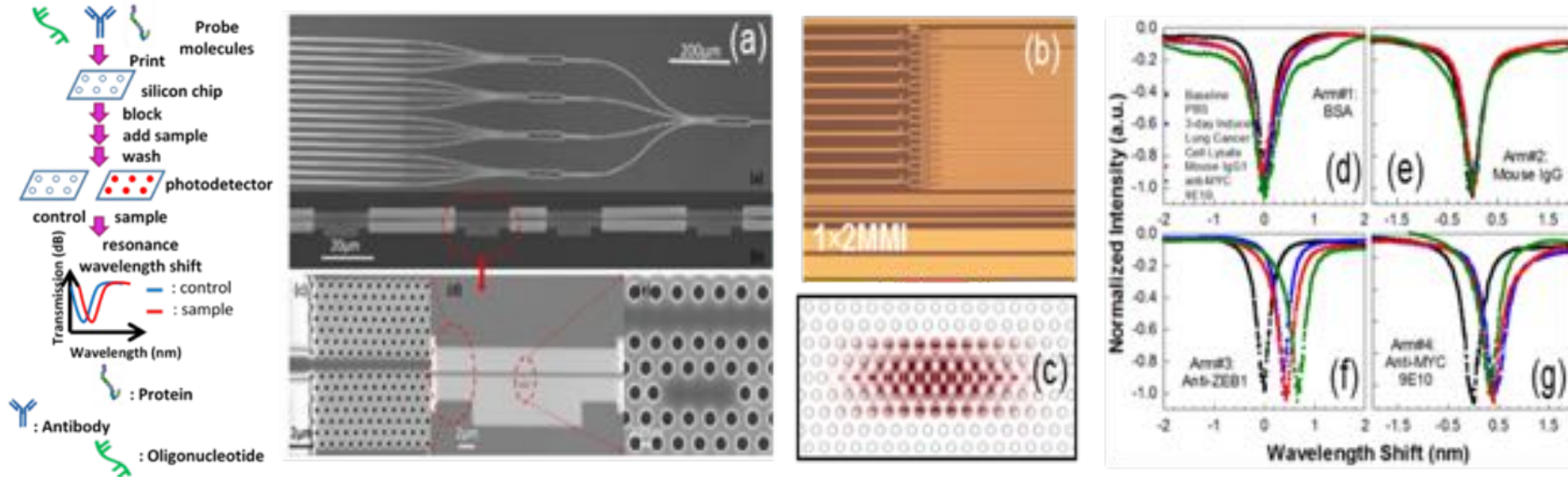

(a) Multiplexed 1×4 multimode interference (MMI) power splitter that splits an input light into 16 optical paths, each with 4 photonic crystal microcavity sensors for 64 sensors in total. Light from the TCC VCSEL will be input in this research, integrated on chip at the input to the MMI shown here. (b) Microscope image of foundry fabricated silicon photonic crystal sensor devices. (c) Highly confined electric field in a photonic crystal microcavity for enhanced analyte sensitivity. Multiplexed simultaneous specific detection of ZEB1 in lung cancer cell lysates with four arms of the MMI derivatized with (d) bovine serum albumin (e) isotype matched control mouse IgG1 (f) anti-ZEB1 antibody and (g) anti-MYC 9E10 antibody.

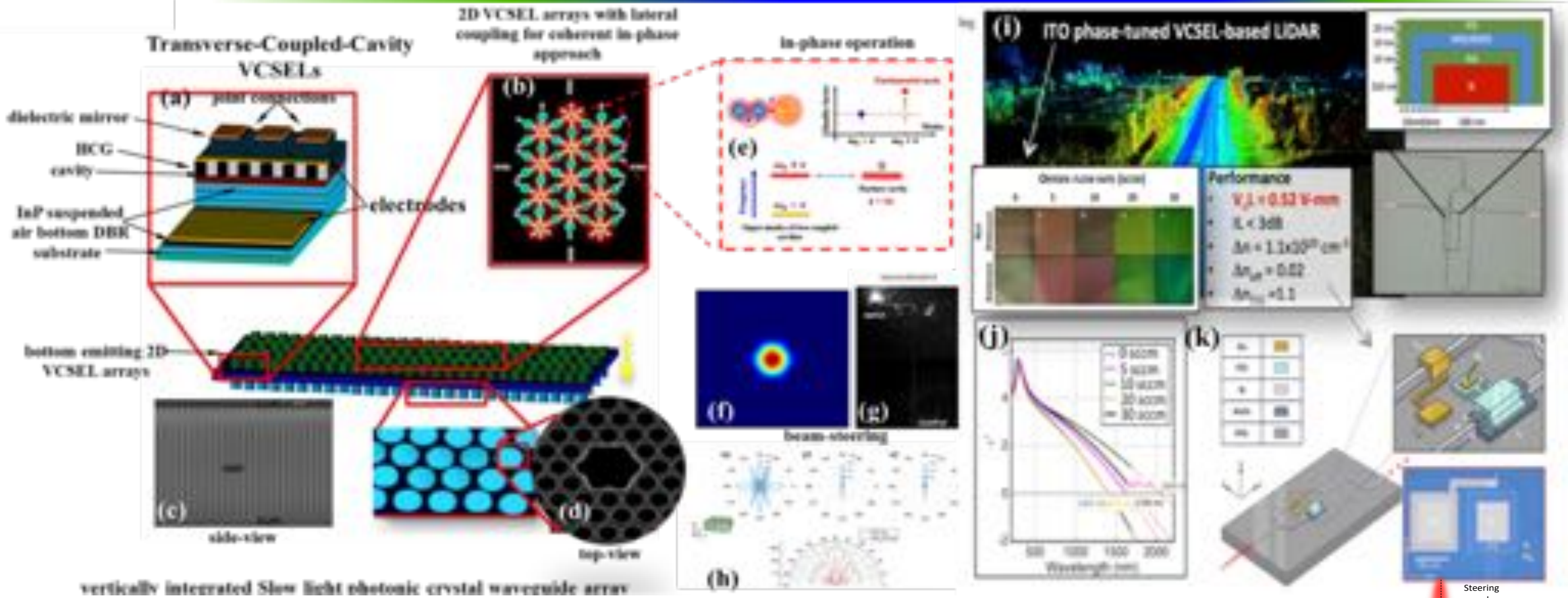

The schematic of the proposed Transverse-Coupled-Cavity (TCC) VCSEL with vertically integrated slow light photonic crystal waveguide array that is capable of providing the needed phase delay within few micron thickness. The input surface normal beams are provided through an integrated photonic circuit with 2D VCSEL arrays that is monolithically integrated to its substrate.

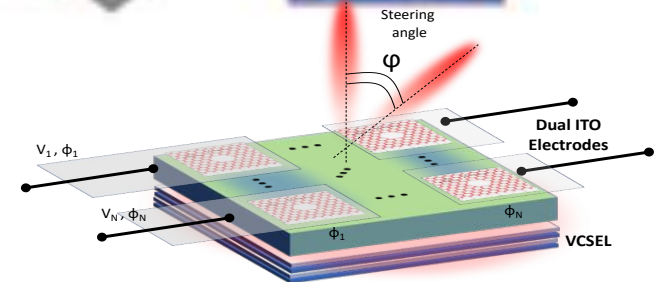

APPROACH

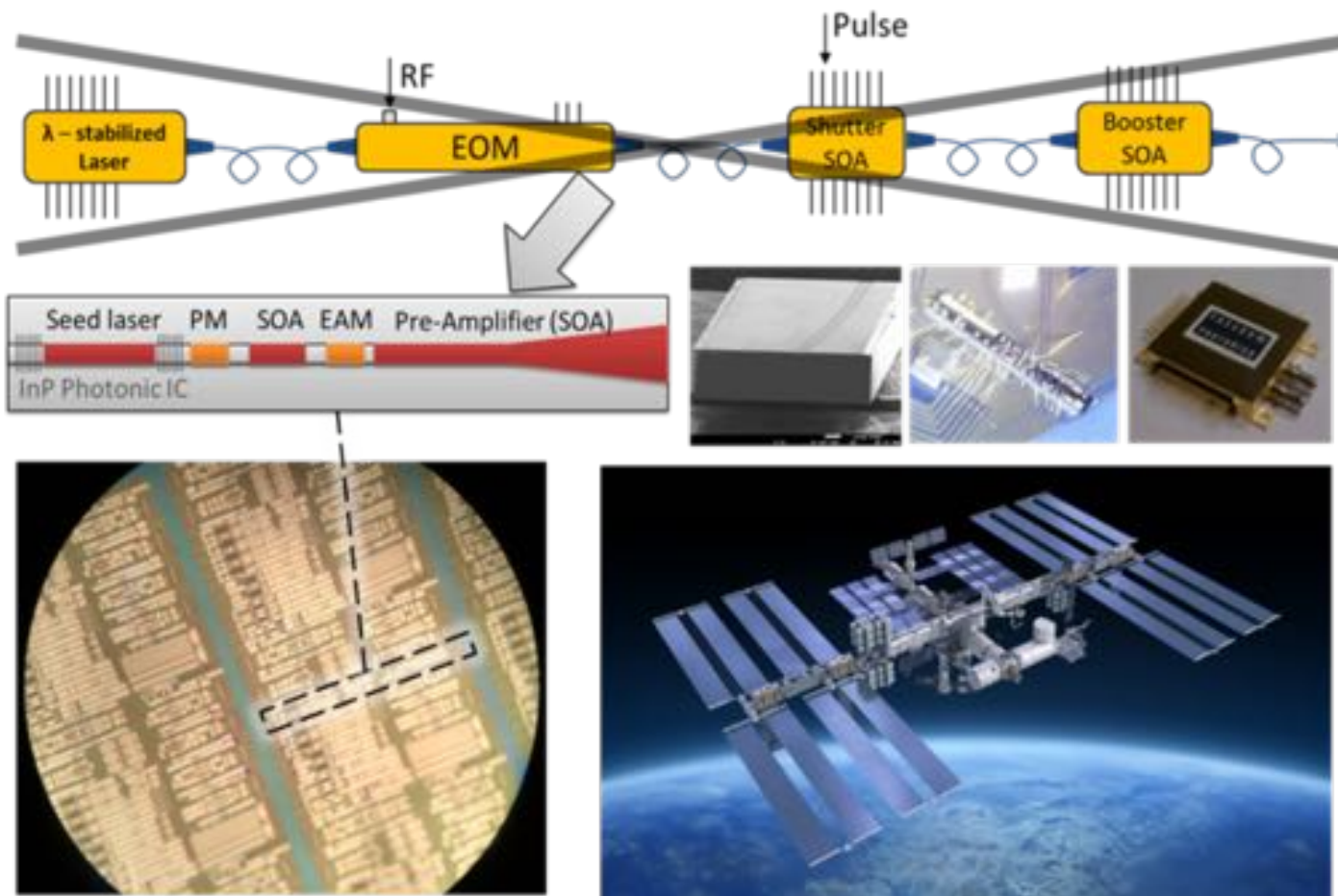

Freedom Photonics has demonstrated single Photonic Integrated circuit incorporating:

- Widely tunable SG-DBR laser
- Ns-Burst gating SOA
- PSK encoder
- Pulse carver

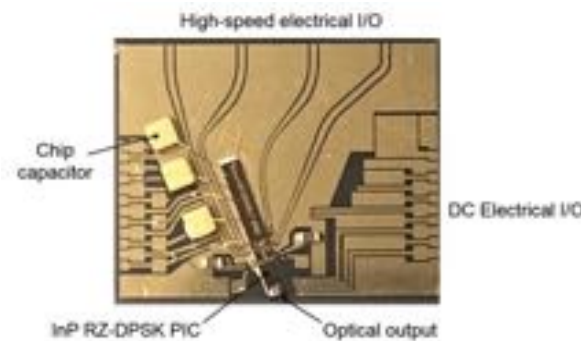
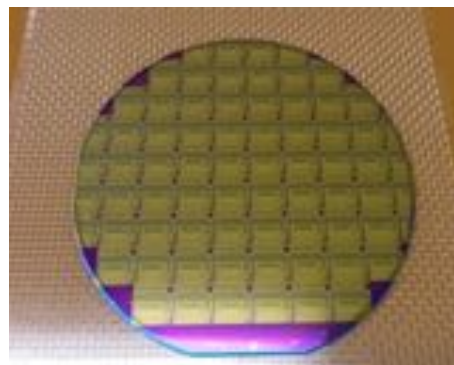

Flared Amplifier

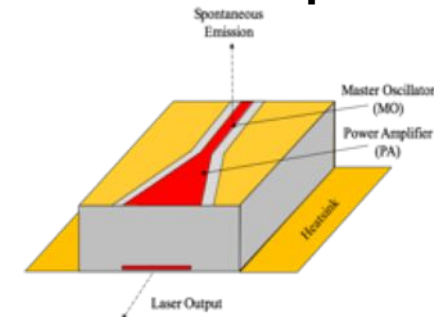

Single-mode 1.5 μm laser

- 2 W at ~40% E/O efficiency
- 1 W at ~45% E/O efficiency

Results:

- Wafer containing first prototypes of the InP RZ-DPSK transmitter
- Transmitter PIC mounted on carrier and wirebonded
- UCSB-designed driver board integrated with Freedom PIC demonstrating up to 10 Gbps

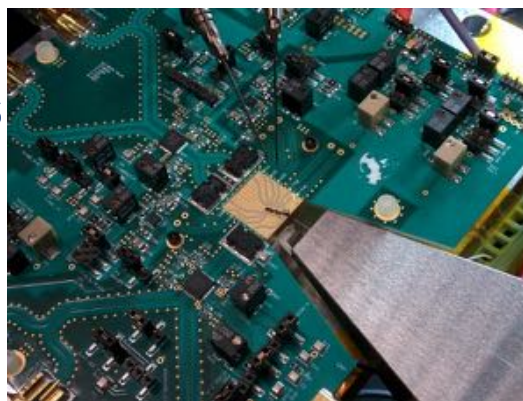

NRZ-OOK

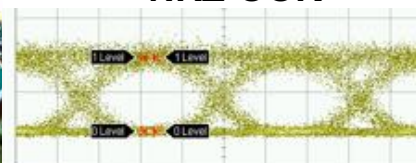

RZ-OOK

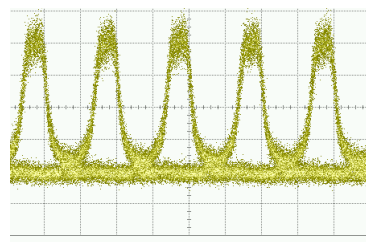

RZ-DPSK

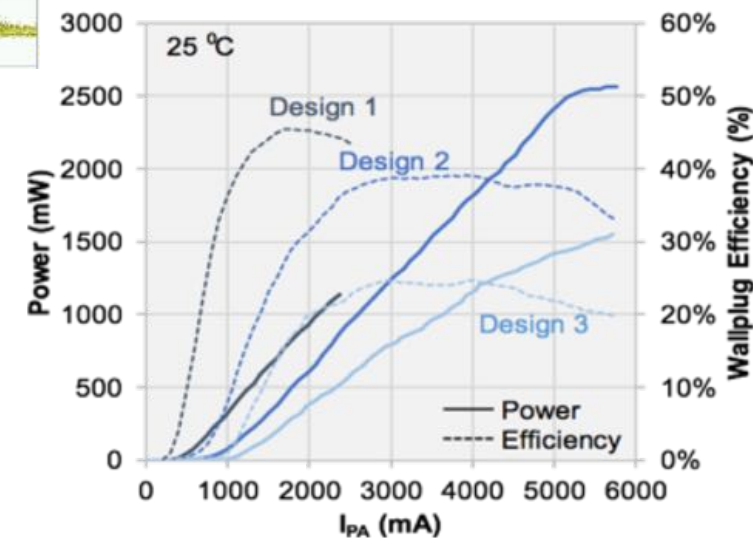
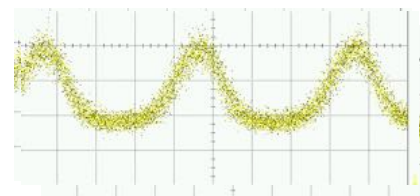



NASA STTR

Photonic Integrated Circuits

2018 awards – Phase 1

Title	Company	University
Si-Based Lab-on-A-Chip Integrated Photonic Spectrometer	Structured Materials Industries, Inc.	Arizona State University-Tempe
Flash Drive Integrated Label Free Silicon Nano-Photonic Bio-Assays for Space Station Bio-Diagnostics	Omega Optics, Inc.	The University of Texas at Austin
Chip-scale THz Spectrometer	Nexus Photonics, LLC	University of California-Santa Barbara
Integrated Photonic Filters for RF Signal Processing	OEwaves, Inc.	Georgia Institute of Technology
Femtosecond-Laser Fabrication of Waveguides in Laser Materials	Aktiwave	Rochester Institute of Technology

- Phase I: write waveguides; Phase II: demonstrate waveguide lasers in Nd:YAG crystal
- Waveguide writing with femtosecond laser:
 - Highly localized (sub-micron) and controlled irreversible index modification
 - Large change of optical index, allowing for strong guiding
 - Very flexible compared to other techniques (metal-ion diffusion, ion/proton exchange, epitaxial layer deposition, chemical vapor deposition, pulsed laser deposition, and ion-beam irradiation)
- Nd:YAG choice
 - One of the most favorable gain media for solid-state lasers owing to its excellent properties
 - Can be used at different wavelengths (946 nm, 1064 nm, 1120 nm, 1320 nm, and 1440 nm)

Writing waveguides with a femtosecond laser is a highly flexible process

$\Delta n < 0$ (severe damage): Suitable for Nd: YAG

Type II

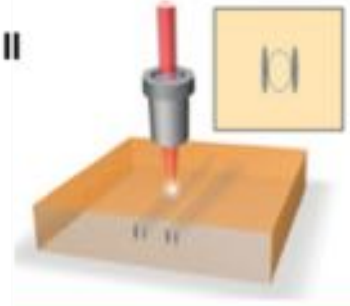

Type III

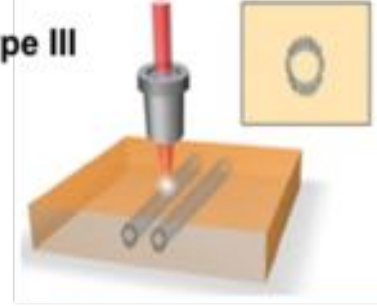

$\Delta n > 0$ (weak damage)

Type I

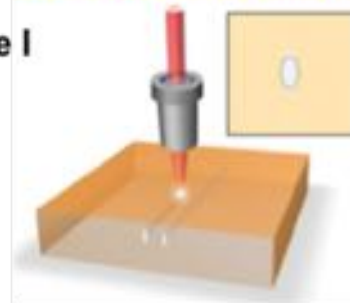

Material removal

Type IV

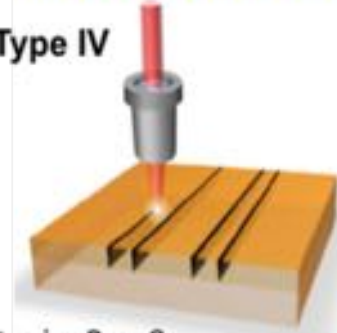

F. Chen, J. R. Vazquez de Aldana, Laser Photonics Rev. 8, 251–275 (2014).

The unidirectional Pulse Propagation Equation (UPPE)*, derived from Maxwell's equations, is used to determine the impact of linear and nonlinear effects

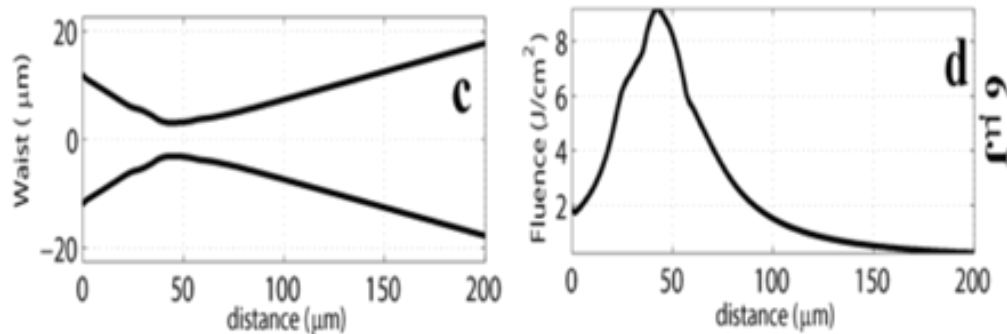

- Propagation of writing femtosecond laser in ND:YAG:
 - Linear effects (diffraction, chromatic dispersion)
 - Nonlinear optical effects (self-phase modulation, Raman)
 - Electrons generation (multi-photon ionization, avalanche ionization) leading to defocusing

*M. Kolesik and J.V. Moloney, Phys. Rev. E 70 036604 (2004)

Waveguides are being written in Nd:YAG using a femtosecond fiber laser

Parameter	Value
Pulse Width	400 fs to 10 ps
Wavelength	1030 nm and 515 nm
Repetition Rate	500 kHz – 2 MHz
Average Power	50 W



- Optimum laser parameters are being numerically and experimentally determined (energy, focusing conditions, and scanning rate)
- Optical manufacturing and metrology tools at RIT's Advanced Materials Laboratory will also be used



STTR

Chip-scale THz Spectrometer



PI: Tin Komljenovic - Nexus Photonics, LLC and University of California, Santa Barbara

Development of integrated chip-scale frequency-domain THz spectrometer with improved frequency accuracy, resolution and stability.

Goals of the project:

- > 10x weight reduction
- > 500x size reduction
- > 5x cost reduction
- > 1000x frequency accuracy improvement
- > 10x frequency resolution improvement
- Guaranteed long-term stability with built-in calibration until (EOL)



STTR

Chip-scale THz Spectrometer



Team: Nexus Photonics, LLC and University of California, Santa Barbara

Size estimate



20 mm

Frequency stability

Current devices

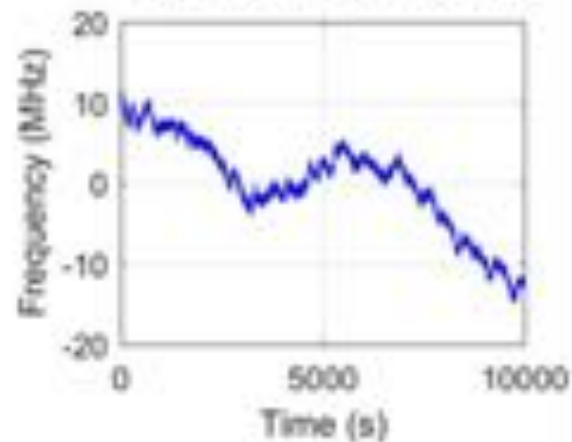

ADEV = 3 MHz@1000s

Proposed device

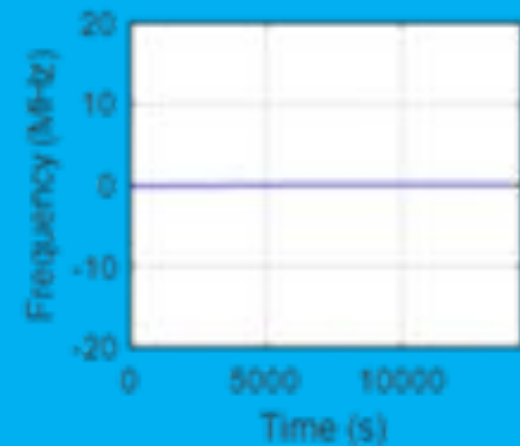

ADEV = 20 kHz@1000s



NASA Earth Science Technology Office (ESTO) Advanced Component Technology (ACT) Award



Title	University	Government
IMPRESS Lidar: Integrated Micro-Photonics for Remote Earth Science Sensing Lidar	University of California, Santa Barbara	NASA-Godard Space Flight Center

IMPRESS Lidar (UCSB and NASA Goddard)

CO₂ Lidar (NASA GSFC)

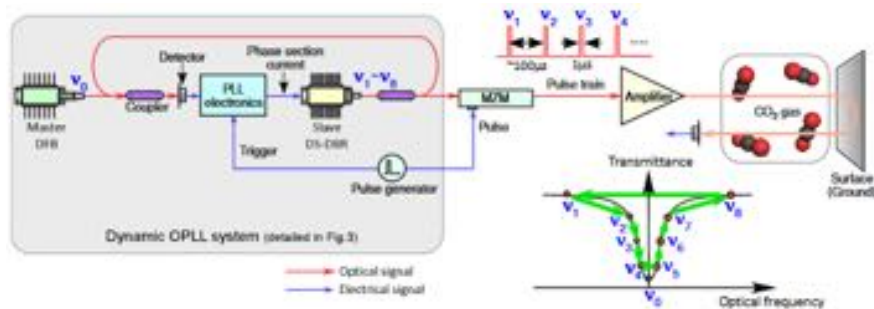

K. Numata, et al., Optics Express, 2012

Integrated OPLL (UCSB)

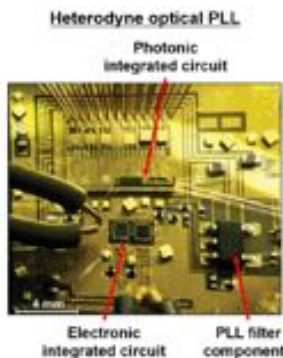

Switching across 5.6 nm and locking within 200 ns

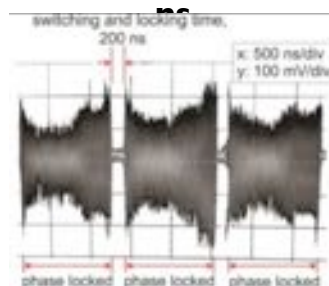

S. Arafin, et al., Optics Express, 2017

IMPRESS Lidar: Integrated Microphotonics for Remote Earth Science Sensing Lidar
Fully integrated Lidar sensor based on optical phase locked loop for fast switching/locking

Existing Technology		IMPRESS Lidar
<p>Rack of equipment</p> <ul style="list-style-type: none"> • PLL electronics • Control electronics • Electronic amplifiers <p>1 m</p>	<p>Photonic components</p> <ul style="list-style-type: none"> • Seed module • Optical amplifiers <p>0.25 m</p> <p>Herriott gas reference cell</p> <p>0.25 m</p>	<p>Fully integrated PIC-EIC</p> <ul style="list-style-type: none"> • Photonic seed module • PLL electronics • Control electronics • Electronic amplifiers <p>Footprint = 1.8 cm x 1.6 cm</p> <p>Compact all-fiber gas reference cell</p> <p>10 cm</p>
<p>~188 ft</p>	<p>~300 ft</p>	<p>~1 ft</p> <p>~36 ft</p>

Utilize **photonic integrated circuit (PIC) technology** to construct a low CSWaP, fast, and stable wavelength tunable laser system for remote earth science sensing lidar to enable **frequent deployment on small spacecraft**



NASA Established Program to Stimulate Competitive Research (EPSCoR) Award



Title	University
Noninvasive diagnostics for the radiation effects on hybrid nanomaterials and photonic devices	University of Delaware



Program: NASA's Established Program to Stimulate Competitive Research (EPSCoR) International Space Station (ISS) Flight Opportunity Cooperative.

PI: Dr. Tingyi Gu, University of Delaware

Evaluation of graphene-silicon photonic integrated circuits for high-speed, light weight and radiation hard optical communication in space



- 2018 RockSat-C Program launch on June 22, 2018 at NASA's Wallops Flight Facility of Chincoteague Island, Virginia.
- Devices survive but wire bonding broke after launching..
 - Extra capping is needed to protect the ISS flight.

RockSat-C launch of packaged Si photonic chips

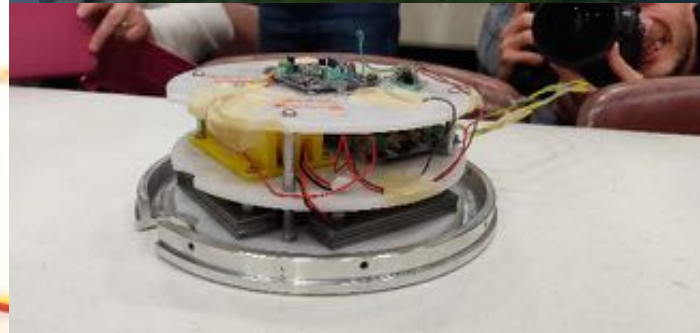
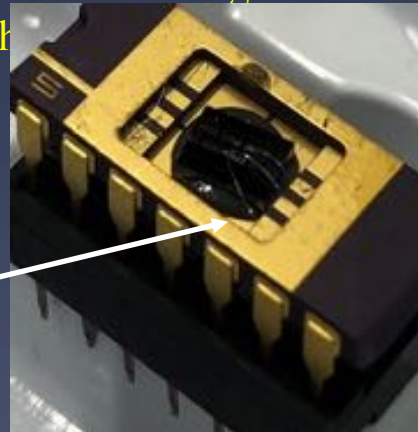
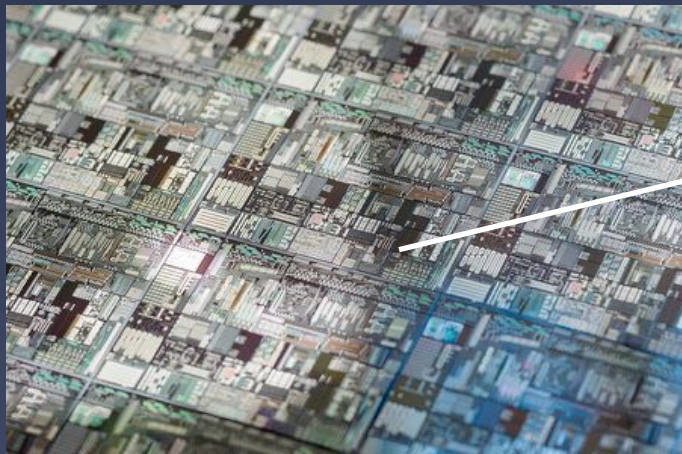



NASA Integrated Photonics



NASA Applications:

- **Sensors – Spectrometers - Chemical/biological sensors:**
 - ◇ Lab-on-a-chip systems for landers
 - ◇ Astronaut health monitoring
 - ◇ Front-end and back-end for remote sensing instruments including trace gas lidars
 - ◇ Large telescope spectrometers for exoplanets.

- **Microwave, Sub-millimeter and Long-Wave Infra-Red photonics:**
 - ◇ Opens new methods due to Size, Weight and Power improvements, radio astronomy and THz spectroscopy

- **Telecom: inter and intra satellite communications.**
 - ◇ Can obtain large leverage from industrial efforts.