

NASA/TM—2020–220557



A Review of Welding in Space and Related Technologies

N. Naden

The University of Alabama in Huntsville, Huntsville, Alabama

T.J. Prater

Marshall Space Flight Center, Huntsville, Alabama

April 2020

The NASA STI Program...in Profile

Since its founding, NASA has been dedicated to the advancement of aeronautics and space science. The NASA Scientific and Technical Information (STI) Program Office plays a key part in helping NASA maintain this important role.

The NASA STI Program Office is operated by Langley Research Center, the lead center for NASA's scientific and technical information. The NASA STI Program Office provides access to the NASA STI Database, the largest collection of aeronautical and space science STI in the world. The Program Office is also NASA's institutional mechanism for disseminating the results of its research and development activities. These results are published by NASA in the NASA STI Report Series, which includes the following report types:

- **TECHNICAL PUBLICATION.** Reports of completed research or a major significant phase of research that present the results of NASA programs and include extensive data or theoretical analysis. Includes compilations of significant scientific and technical data and information deemed to be of continuing reference value. NASA's counterpart of peer-reviewed formal professional papers but has less stringent limitations on manuscript length and extent of graphic presentations.
- **TECHNICAL MEMORANDUM.** Scientific and technical findings that are preliminary or of specialized interest, e.g., quick release reports, working papers, and bibliographies that contain minimal annotation. Does not contain extensive analysis.
- **CONTRACTOR REPORT.** Scientific and technical findings by NASA-sponsored contractors and grantees.
- **CONFERENCE PUBLICATION.** Collected papers from scientific and technical conferences, symposia, seminars, or other meetings sponsored or cosponsored by NASA.
- **SPECIAL PUBLICATION.** Scientific, technical, or historical information from NASA programs, projects, and mission, often concerned with subjects having substantial public interest.
- **TECHNICAL TRANSLATION.** English-language translations of foreign scientific and technical material pertinent to NASA's mission.

Specialized services that complement the STI Program Office's diverse offerings include creating custom thesauri, building customized databases, organizing and publishing research results...even providing videos.

For more information about the NASA STI Program Office, see the following:

- Access the NASA STI program home page at <<http://www.sti.nasa.gov>>
- E-mail your question via the Internet to <help@sti.nasa.gov>
- Phone the NASA STI Help Desk at 757-864-9658
- Write to:
NASA STI Information Desk
Mail Stop 148
NASA Langley Research Center
Hampton, VA 23681-2199, USA

NASA/TM—2020–220557



A Review of Welding in Space and Related Technologies

N. Naden

The University of Alabama in Huntsville, Huntsville, Alabama

T.J. Prater

Marshall Space Flight Center, Huntsville, Alabama

National Aeronautics and
Space Administration

Marshall Space Flight Center • Huntsville, Alabama 35812

April 2020

Acknowledgments

This work was performed under the Virtual Student Federal Service (VSFS) program. Additional thanks to Fredrick Michael, Josef Cobb, and Jeffrey Sowards of NASA Marshall Space Flight Center.

TRADEMARKS

Trade names and trademarks are used in this report for identification only. This usage does not constitute an official endorsement, either expressed or implied, by the National Aeronautics and Space Administration.

Available from:

NASA STI Information Desk
Mail Stop 148
NASA Langley Research Center
Hampton, VA 23681-2199, USA
757-864-9658

This report is also available in electronic form at
<<http://www.sti.nasa.gov>>

TABLE OF CONTENTS

1. INTRODUCTION	1
2. REVIEW OF LITERATURE	2
2.1 Solidification	2
2.2 Heat and Mass Transfer	3
2.3 Fluid Flow	4
3. CAPABILITIES AND DESIGN OF VARIOUS IN-SPACE WELDING DEVICES	5
3.1 Vulkan Facility	5
3.2 M-551	6
3.3 Universal Hand Tool	6
3.4 NASA Laser Welding Apparatus	7
3.5 International Space Welding Experiment (Modifications of the Universal Hand Tool	9
3.6 New Electron Beam Gun	10
4. SAFETY CONSIDERATIONS	11
4.1 Contamination Issues	11
4.2 Arcing Hazards for Electron Beam Welding	11
4.3 Droplet Separation	12
4.4 Laser Reflectance	13
5. APPLICATIONS OF WELDING IN SPACE	14
5.1 Sources of Spacecraft Damage	14
5.2 International Space Station External Materials	15
5.3 Benefits of Welding in Space	15
5.4 Joint Configurations	16
6. STATE OF THE ART FOR ADDITIVE MANUFACTURING DEVICES FOR IN-SPACE USE	17
6.1 Vulcan Unit	17
6.2 Ultrasonic Additive Manufacturing Process	18
6.3 Metal Advanced Manufacturing Bot-Assisted Assembly	18
6.4 Sintered Inductive Metal Printer With Laser Exposure	18
6.5 Techshot Fabrication Laboratory	19

TABLE OF CONTENTS (Continued)

7. RECENT NASA-SUPPORTED RESEARCH ON WELDING IN SPACE	21
8. SUMMARY	23
REFERENCES	24

LIST OF FIGURES

Figure 1. Simple schematic of the laser welding experiment	7
Figure 2. Weld ripples in stainless steel post-laser welding	8
Figure 3. Cross-sectional comparisons in the transverse direction of laser-based welding with varying gravitational acceleration	8
Figure 4. International space welding experimental design	9
Figure 5. Carillon apparatus	12
Figure 6. Vulcan apparatus (image from Made in Space)	17
Figure 7. UAM concept (image from Ultra Tech Machinery and Fabrisonic)	18
Figure 8. SIMPLE device (image from Techshot)	19
Figure 9. FabLab concept configuration	20
Figure 10. MELD prototype (image from Made in Space)	21
Figure 11. SOUL satellite platform for welding (image from Busek Co. Inc.)	22

LIST OF SYMBOLS AND ACRONYMS

Al	aluminum
AM	additive manufacturing
CNC	computer numerical control
Cr	chromium
Cu	copper
EBW	electron beam welding
FabLab	Fabrication Laboratory
FCC	face-centered cubic
ISS	International Space Station
ISWE	International Space Welding Experiment
MAMBA	metal advanced manufacturing bot-assisted assembly
MELD	mobile end-effector laser device
Mg	magnesium
Ni	nickel
OSAM	on-orbit servicing, assembly, and manufacturing
SBIR	Small Business Innovative Research
Si	silicone
SIMPLE	sintered inductive metal printer with laser exposure
SOUL	satellite on umbilical line
Ti	titanium
TM	Technical Memorandum
UAM	ultrasonic additive manufacturing
UHT	universal hand tool

TECHNICAL MEMORANDUM

A REVIEW OF WELDING IN SPACE AND RELATED TECHNOLOGIES

1. INTRODUCTION

Deployment of welding and additive manufacturing (AM) technologies in the space environment has the potential to revolutionize how orbiting platforms are designed, manufactured, and assembled. These technologies offer the option for repair of sustained damage to habitat structures on space missions, as astronauts would be able to manufacture new parts (using welding-derived AM processes suitable for use in the external space environment) and weld cracks. An added benefit is that required repairs can be achieved more economically, as new parts need not be shipped from Earth. With further maturation of in-space welding capabilities, astronauts could operate under given standards and weld damaged structures rather than rely on cargo resupply.

This Technical Memorandum (TM) begins by reviewing the available literature relevant to welding in space, focusing on solidification, heat and mass transfer, and fluid flows in microgravity. This survey considers research on the effects of welding in microgravity on a material system. The various in-space welding devices that have been previously designed and tested are examined to determine their capabilities and shortcomings, with a focus on the results of their individual welding experiments. Safety measures are discussed to protect the orbiting International Space Station (ISS) and crew during welding operations. Finally, the state of the art is examined by focusing on current approaches to AM and on-orbit welding that are being developed by several companies in conjunction with NASA.

2. REVIEW OF LITERATURE

2.1 Solidification

Throughout the latter half of the 20th century many solidification experiments were performed in microgravity to understand how manufacturing could be impacted by operation in a space environment compared to terrestrial manufacturing. It has been observed that surface tension effects play a more pronounced role in microgravity, as the buoyancy force becomes nearly nonexistent.

The following two quotes from the book, *Manufacturing in Space: Process Problems and Advances*,¹ aptly summarize microgravity solidification:

“Where convective currents are of low significance and the mass transfer is governed primarily by diffusion, the dendritic growth will in all probability give way to the cellular growth. It will happen because the concentration gradient ahead of the solidifying interface may grow and stability of the interface will be upset as a result of constitutional supercooling [1].”

“By its effect on the ingot’s microstructure, a decrease in intensity of convective mixing is equivalent to a decline in the growth rate under normal-gravity conditions. This implies that in space, the solidification towards ordered directional structure materials may proceed at a higher rate than on Earth.”

A simplified model for the expected morphology of the microstructure based off the growth rate and the temperature gradient can be found in reference 2.

It is suggested that supercooling is prevalent in microgravity builds.¹⁻⁵ The reduction of mixing in a molten pool creates a concentration gradient that forces supercooling, which tends to lead to higher ordered dendritic structures and cellular growth. Furthermore, this decline in growth rate of solidification indicated that heterogenous nucleation is suppressed in microgravity and homogenous nucleation occurs more easily.²

Furthermore, high segregation of the microstructure is expected in microgravity laser and electron beam welds due to decreased mixing.¹ Decreased mixing causes diffusion to become the primary mode of mass transfer.⁶ Diffusion is relatively slow in comparison to mixing, so solidification will freeze mass concentrations in their locations and segregation would be observed during metallography of the specimens. For example, aluminum (Al)-silicon (Si) (7% Si) alloy was remelted and solidified in microgravity. The resulting microstructure showed an odd macrostructure with a sphere covered in hillocks, where the silicon was between the hillocks and aluminum solidified to form the hillocks themselves.¹

It is difficult to make predictions on how the microstructure will be impacted with use of various welding methods in microgravity. In aluminum-copper (Cu) alloy casting, grains became larger in microgravity compared to Earth-based casts.⁷ In electron beam tests, the microstructures appear to be fine grained.⁸ With laser welding, larger grains have been observed.⁹ However, it is important to note that these differences in grain structure are most likely due to the material system as well as the welding method. More research is needed to be able to make generalizations about microgravity's effects on various metallic systems.

Weld ripples are also common in the solidification of space welds.⁹ These ripples are a result of surface tension effects during the weld process, with surface tension changing with temperature at a given point in the weld.

Moreover, the Gibbs-Thomson effect suggests that curvature of the melt pool due to microgravity will reduce the melting temperature of a solid particle in the pool.⁶ Additionally, it has been suggested that the presence of weld fumes in the area of the weld would alter the melting temperature as well, although there does not appear to be data in the literature relating to this phenomenon. The Gibbs-Thomson effect could be one of the causes of constitutional supercooling in microgravity. This shift in melting temperature would cause large supercooling during solidification. Supercooling is depicted graphically in reference 10. The authors indicate that increased supercooling would cause a dendritic morphology. It should be noted that this somewhat offsets the expected coarser structure caused by the reduced growth rate. Increased supercooling can be seen as a higher temperature gradient, leading to finer grains than expected.

2.2 Heat and Mass Transfer

Heat and mass transfer is significantly impacted in the microgravity environment of space. Due to the lack of the buoyancy force, natural convection does not occur; therefore, the only interactions a hot body has with the environment is radiation and conduction. This is important because heat transfer via conduction through a fluid is significantly lower than heat transfer from convection. As a result, a melt pool will take longer to cool. This could create problems, as the material is essentially annealed for a longer time with the application of a heat source such as a weld stick. This would cause larger grain growth compared to terrestrial processes.^{9,10}

As mentioned previously, diffusion becomes the driving force for mass transfer in microgravity.⁶ It was noticed that in space, the flow of solute reaches a critical value earlier and begins to diffuse earlier, allowing for more time for diffusion-controlled growth.¹

Moreover, there is a concern that may develop in metallic systems with a high vapor pressure such as those containing magnesium (Mg). In one experiment, a thermal differential was built on opposite sides of a fluid and nine bubbles were inserted into the fluid. After an hour, the center of the fluid had not reached a uniform temperature.¹ This constant temperature fluctuation may or may not cause problems in the solidification of a melt pool, but there is a need for additional research to understand this phenomenon.

2.3 Fluid Flow

In the microgravity environment, thermocapillary flows are pronounced and cause a change in the fluid flow of a molten pool.^{1,2,6,11} Convection in terrestrial molten pools tends to be dominated by the buoyancy force. The thermocapillary flow convection velocity is about an order of magnitude below the buoyancy force and causes reduced mixing in the melt pool.^{12,13}

Interestingly, g-jitter amplitude has a smaller effect on suspended particles than expected. High-frequency g-jitter is countered by surface tension effects but low-frequency jitter tends to have a greater impact on the stability of particles in a molten pool.^{14,15}

Moreover, it has been proven that the Marangoni number alone is insufficient to predict the onset of oscillatory flow within a fluid in microgravity.^{11,16} This means that more research is needed to determine what could cause oscillatory flow, a phenomenon that could become useful in weld pools to cause greater mixing.

3. CAPABILITIES AND DESIGN OF VARIOUS IN-SPACE WELDING DEVICES

3.1 Vulkan Facility

The Vulkan facility^{8,17} was the first welding apparatus in space and was designed by the Russians to perform experiments pertaining to microgravity welding. The device was equipped with a low-pressure arc welder using a consumable electrode, a low-pressure arc and hollow cathode, and an electron beam welder. To shield the crew from the possible unknown dangers of welding in space, Vulkan was an automatic system to be operated remotely by cosmonauts in a separate compartment.

Furthermore, Vulkan consisted of two sections: a low-pressure nonhermetic section and the hermetically sealed section. The nonhermetic section was able to be exposed to the environment and held three specimens to be welded along with a rotating table to facilitate the welding process. The hermetic section contained most of the operating equipment including an independent accumulator electric power source, secondary power source, control units, and measurement devices. In all, the device weighed 50 kg and had a 0.6 to 1 kW capacity.

Vulkan was first tested in 1969 aboard the Soyuz 6 spaceship within the airlock section while the cosmonauts remained in the reentry system to operate the device remotely. The airlock pressure was reduced to less than 1.33×10^{-2} Pa for the duration of the tests.

The low-pressure constricted arc and hollow cathode were tested first to weld butt joints with and without flanged edges in 1-mm-thick stainless and titanium (Ti) sheets. These experiments were determined null as the high pumping rate of the atmosphere from the living section of the Soyuz 6 made it difficult to ensure a concentration of the plasma-forming gas in the arc gap zone necessary for constricting the high-current arc. This low-current discharge made was too low to melt and weld the joints.

Next, electron beam welding (EBW) was used to weld butt joints with and without flanged edges, butt joints in a depression, and lap joints. 1Cr18Ni9Ti stainless steel, a titanium alloy, and an AlMg-6 aluminum were the materials of choice and the thicknesses of the welded specimens were between 1.5 and 2 mm. Additionally, the electron beam was used to cut 1-mm-thick sheets of titanium and aluminum. The results showed that the processes of welding, melting, and cutting with EBW were stable in the space environment. The necessary conditions for formation of welded joints and cut areas were met in this experiment. Unfortunately, long high-quality welding joints could not be produced because of the nonuniform speed of the rotating table, which was caused by a failure in the displacement mechanism.

Finally, the low-pressure arc and consumable electrode were tested on 1-mm-thick 1Cr18Ni9Ti stainless steel with a 0.5-mm-thick backing strip. As mentioned in the preceding paragraph, high-

quality welds were not obtained due to the failure in the rotating table. However, it was shown that consumable electrode welding in space is stable at a high pumping rate, as in the vacuum chambers of Earth. It is interesting to note that Boris Paton, the researcher for this work, characterized these results as ambiguous.

3.2 M-551

In response to Russia's demonstration of the Vulkan facility in 1969, NASA tested the M-551 automatic electron beam welder aboard Skylab in 1972. The M-551 was equipped with an electron beam welder for cutting and melting in microgravity with 20 kV and 80 mA operating conditions.¹⁸

The conclusion of this experiment was that puddle control techniques on Earth should be readily adapted to the space environment. Large, elongated grains in Skylab specimens indicated that there was a major difference in convection during solidification of three metals with a variety of physical properties.

3.3 Universal Hand Tool

The universal hand tool (UHT) was a manual electron beam gun developed to address automatic welding, specifically the ability to reach spots that are difficult to access such as crevices or corners.^{8,17,18}

Intended to be used by a cosmonaut, the UHT had some interesting design points. To protect the cosmonaut and prevent puncturing the space suit or the space vehicle, the electron beam would be deflected if the actions of the operator became uncontrollable. The device had the form of a single unit, whose main element was the box body held in the right hand with a special handle shaped to fit the glove of a spacesuit. Under the left hand was a control panel to toggle power of the weld gun.

On the front of the box body there were two electron beam guns covered with a heat-shielding jacket. Each gun was able to be fitted with a focusing device or a crucible attachment. With the focusing device, the gun could be used for welding, brazing, or heating with a concentrated heat source. With the crucible attachment, it can be used for evaporation to deposit coating or heat with a distributed source. The latter would be useful for homogenizing temperatures across a joint before welding to prevent cracking that may occur due to large temperature fluctuations.

Within the body there was a high-voltage power source consisting of a high-voltage transformer common to both guns, an anode rectifier, and separate filament transformers. Each of these devices were covered with epoxy to form a single body. During the development of the UHT, it was recommended that the anode voltage of the high-voltage power source should not exceed 10 kV to prevent hard x-ray radiation during operation which would endanger the user. In all, the UHT weighed about 20 kg.

The UHT was first used in space on July 25, 1984, on stainless steel and a titanium alloy 0.5-mm thick for cutting and 1-mm specimens for welding and brazing. Results of this experiment confirmed the high quality of the majority of specimens produced in space, although not much information is available about the actual microstructure of the welds.

For a more practical test, in 1986 cosmonauts were given the task to weld and braze manually in free space individual sections of girder structures, which were placed in special cassettes and manipulators. A total of 10 individual hinged sections of TiAl4Mn1.5 titanium alloy were welded. Next, the cosmonauts carried out a complex operation of welding a tubular boom girder. Each section had the form of a fragment of an open pipe made of 36NiCrTiAl steel onto which rings of Cr18Ni10Ti steel were fitted by brazing. Later investigations on Earth showed that the joints produced in space were of high quality.

In the 1990s and early 2000s, the UHT was modified in the in-space welding experiment to meet American standards for human use of a device in space.

3.4 NASA Laser Welding Apparatus

Few laser welding devices were developed for use in space; the most notable is a device designed by Workman show in figure 1,⁹ that was tested in 1989 on a KC-135. This device was built mainly for simplicity and ease of use. It included a Nd-YAG laser that produced the 1- μm wavelength used for melting, diode pumping to give high efficiency with low power consumption and reduce cooling problems to a minimum, and fiber optic delivery to simplify the welding process.

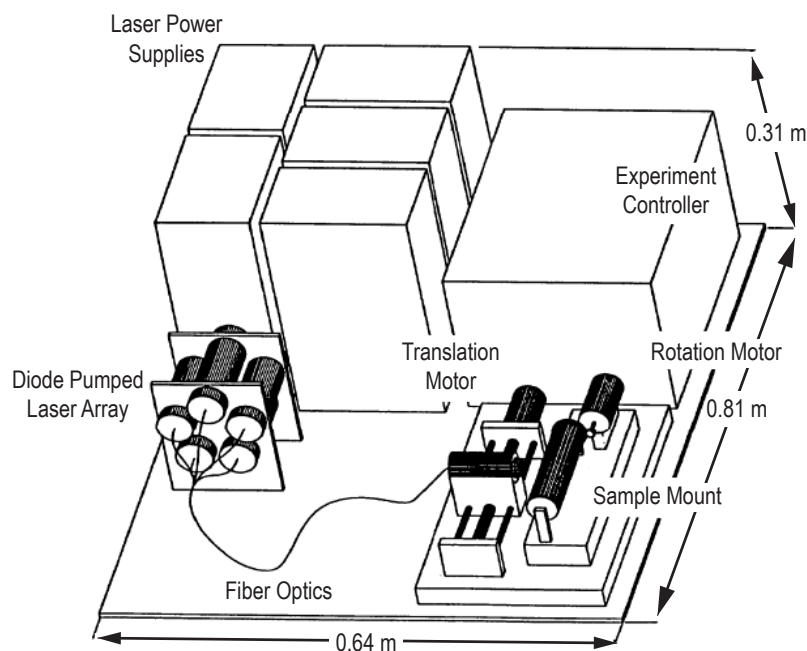

Figure 1. Simple schematic of the laser welding experiment.⁹

The device was designed for 38 W in continuous multimode with a 2-mm beam diameter. A 10-kW YAG-Drive from ALE Solutions, Inc. was used to power the system. Notice that the 38-W laser is much lower than the electron beam guns mentioned previously, thus increasing the utility of the apparatus as it requires less power to run.

During the tests on the KC-135, 0.127-mm stainless steel was welded. Rippling was observed in the space builds as can be observed in figure 2.⁹ The resulting microstructure yielded more elongated structures in microgravity compared to similar tests in high gravity, as depicted in figure 3.⁹



Figure 2. Weld ripples in stainless steel post-laser welding.⁹

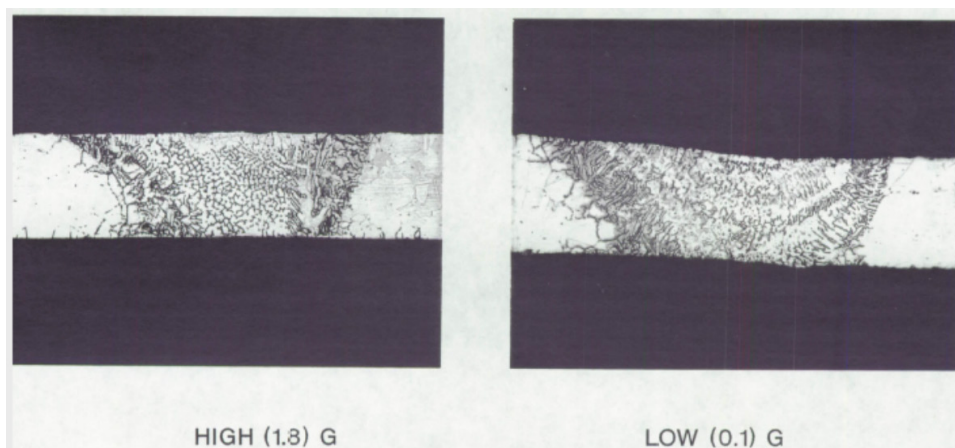

Figure 3. Cross-sectional comparisons in the transverse direction of laser-based welding with varying gravitational acceleration.⁹

3.5 International Space Welding Experiment (Modifications of the Universal Hand Tool)

By the late 1990s, the last time the United States had welded in space was on Skylab using the laser welding apparatus in 1972, leaving a gap in our understanding of welding phenomena in the space environment. Moreover, an opportunity was presented to build international collaboration with former Soviet bloc states. This made it possible for the Paton Welding Institute to collaborate with the United States. The Paton Institute previously designed the UHT and the Vulkan facility demonstrated on Soviet space missions. The International Space Welding Experiment (ISWE)¹⁹ was meant to strengthen these bonds with former Soviet nations and to maintain technology supremacy in space for the United States.

The ISWE gun shown schematically in figure 4¹⁹ was a modification on the UHT that was designed about 15 years prior. First, the device was built to be more modular and have five different attachments that can be replaced, depending on the job being performed. Initially, NASA wanted to simply have five guns fitted with different modules to decrease the risk of changing modules. To exchange the guns, the power needed to be removed, the integral power cable was disconnected from the block, the hand tool was stowed, and the power cable for the new tool connected.

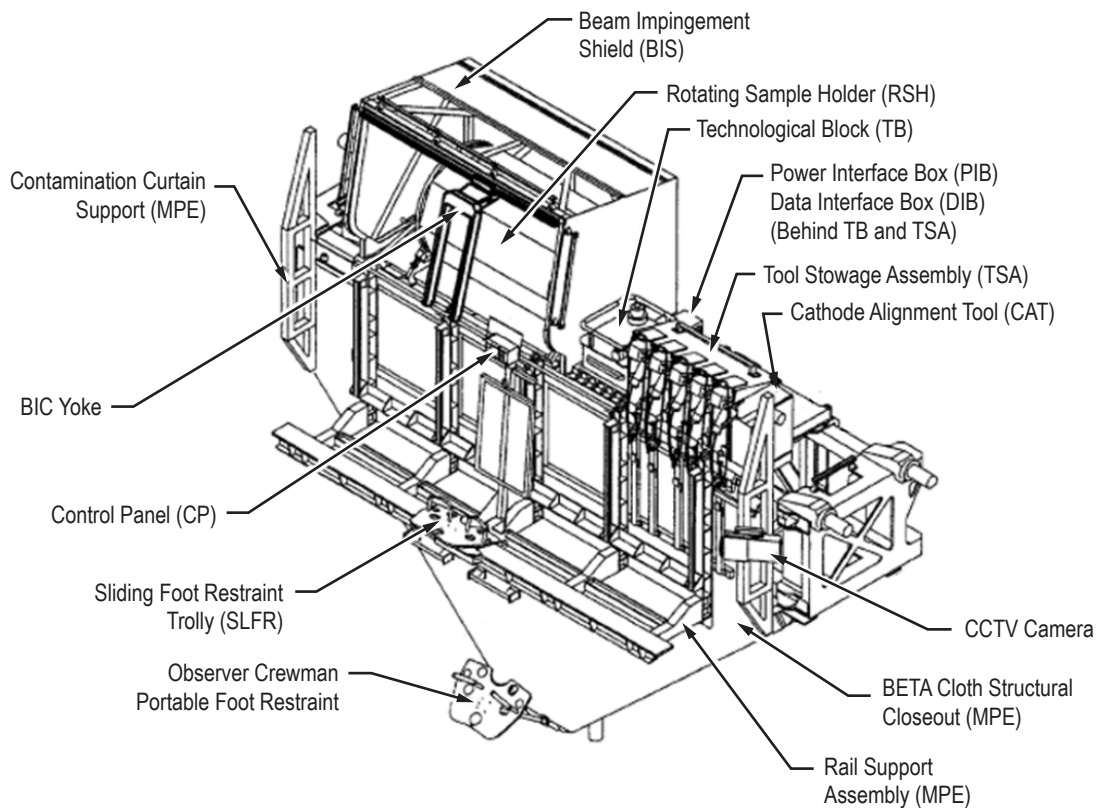

Figure 4. International space welding experimental design.¹⁷

The electron beam tool weighed between 4.5 and 6.5 kg, including the integral cable. The precise weight depended on the attached module. It was planned that the ISWE gun be tested on 2219 aluminum, 5316-T6 aluminum, 304 stainless steel, and Ti6Al-4V titanium alloy. However, the ISWE payload was cancelled prior to flight.

3.6 New Electron Beam Gun

It is important to note that the same researcher who supervised the designs of the Vulkan and the UHT, Boris Paton, published the design for the ‘new gun’ in 2018. Paton is perhaps the world’s best authority on EBW in space. With persistent platforms such as the ISS and NASA’s proposed Gateway, there is an increased interest in welding in space at the present time.

The electron beam concept was used instead of a laser method due to the decreased chance of reflectance of the beam and the fact that quality welds have previously been produced with EBW in a space environment. This new design, detailed in reference 20, was a response to the limitations that were found in the UHT, such as the inability to easily weld thicknesses greater than 1 mm thick. The ISS structure (for the Columbus module) is 2.57 mm in thickness. The power output of the electron beam was increased while improving safety, reliability, and ergonomics.

The new design featured a new small-sized gun weighing about 1.8 kg with a power of 2.5 kW. A triode emission system with inertial control of the beam was chosen in contrast to the diode system used in previous welding systems. Lanthanum hexaboride cathodes were used to reduce required wattage for the device. Accelerating voltage was capped at 10 kV as mentioned before for the same reasons, but the current was increased to 250 mA to increase the power. Higher penetrating power was further obtained by increasing the quality of beam formation. Aluminum oxide was chosen as the insulation material for its resistance to voltage breakdown and its ability to focus heat easily. Reference 20 compares the new design with previous welding gun designs. The main difference between the new gun is that it can be used manually, is 50% lighter than the UHT at 1.8 kg, and has a higher beam power. The voltage being twice the voltage of the UHT with a voltage of 250 kV and 0.25 A compared to the 5 kV and 0.1 A present in the UHT.

Subsequent Earth tests of the device were reported. The measured bending strength of brazed joints was equal to 200 MPa (material not specified). Furthermore, vacuum tightness showed that all welded-brazed joints allowed getting and keeping the vacuum at 10^{-5} Pa. High-voltage testing in a 5×10^{-5} Pa environment showed that metal-ceramic components can withstand voltage greater than 1.5 times the operating voltage.

Various joint configurations were welded using the new electron beam gun (shown in sec. 6.5, fig. 9).²⁰ The welds appear to have high quality on terrestrial builds, but it is as of yet unknown how this may change in microgravity.

4. SAFETY CONSIDERATIONS

4.1 Contamination Issues

During the ISWE, concerns were raised that particulates produced during the welding process may contaminate the weld environment. If welding is performed within the orbiting ISS, there is a concern that particulates may interact with various systems such as carbon scrubbers and payloads, causing required repairs to various systems to occur more frequently. This would reduce the time astronauts could spend on other scientific projects and repairs may present additional hazards to the astronauts that need to be assessed. Furthermore, there is the real hazard that particulates can be inhaled by the astronauts causing health problems to the crew. To mitigate these risks, it was suggested that a contamination curtain be constructed around the welding area to prevent contamination of the various systems and crew.

The concern was then raised that if welding is performed outside the orbiting Station during maintenance, particulates could accumulate on space systems (particularly optical surfaces or electronics) and cause damage. An example would be that particulates could accumulate on heat rejection units and cause a given module to burn up as a result. In actuality, this may not be as large of a concern. The chances that the particulates would happen to land in these areas and continue to accumulate until a measured change in output of the system can be detected appears to be quite low. For a new long-term system such as Gateway, this concern deserves to be addressed and quantified, as accumulation over a period of several years may be significant.

Moreover, it was suggested that the users wear an expendable secondary visor during welding so that the primary visor would not get contaminated and cloudy during the welding process. It may be possible to recycle expendable devices in coming years as recycling systems and processes for exploration missions are matured.

4.2 Arcing Hazards for Electron Beam Welding

During the ISWE,^{17,21} the possibility that the electron beam gun would cause arcing and cause damage to the system or the astronaut was investigated. At the time, it was noted that in all prior tests of the UHT, no arcing was observed, but these experiments all occurred in the vacuum of space. There was a concern that, in the shuttle bay, pressure fluctuations or leaky suits could make it more likely that arcing could occur. To test the possibility of arc discharging, tests were run for pressures between 10^{-4} and 10^{-3} Pa with argon used to pressurize the chamber. No arcing was observed during these tests. It is important to note that if arcing were to occur, it would most likely occur inside the gun between the high-voltage filament and the grounded accelerating anode.

4.3 Droplet Separation

In space welding, there is the concern that molten droplets could separate from the weld pool due to a mechanical shock in the weld region, such as the astronaut putting a hand on the weld structure with too much force. To determine the risk associated with droplet separation, James Fragomeni and Arthur Nunes²² carried out tests using the carillon apparatus (shown in fig. 5²²), where a striker was designed to fall from a preset height to impact the weld plate during the weld process. The impact energy was then calculated to determine when a droplet would most likely detach. The test was performed in a vacuum with standard gravity.

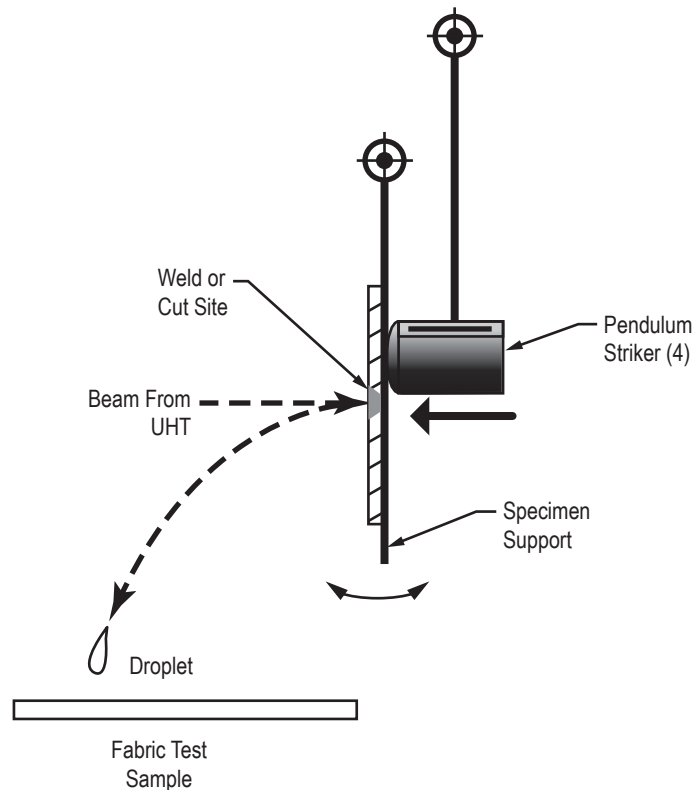

Figure 5. Carillon apparatus.²²

It was determined from this experiment that droplet detachment would most likely occur. It would require a significant shock coupled with the astronaut not conforming to proper welding procedures. In the experiment, the droplet was more likely to simply flow down the plate due to gravity. As a secondary experiment performed during the same tests, Teflon® fabric was placed below the weld plate to catch the molten droplets and determine the effectiveness of the fabric in resisting damage from the molten metal. The metallic droplets melted through the Teflon fabric. However, this complete melt-through may not occur in microgravity, as the force of gravity will not serve to accelerate the metal droplet toward the fabric. More tests are suggested to determine the risks of metallic droplets impinging on more modern space suits.

4.4 Laser Reflectance

Significant reflectance of the laser beam is expected when using a laser-based welding method due to metallic surface's reflectivity. There are three scenarios where laser reflectance could present a danger to the crew or the orbiting Station:

- (1) If the astronaut was improperly pointing the gun at an angle towards themselves, the laser could be reflected back and damage the space suit.
- (2) It is likely that this welding operation would involve at least two astronauts where one can supervise the other. It is possible that the welder could point the gun at an angle, which would reflect and damage their partner's space suit.
- (3) The laser could be reflected and damage another part of the Station, requiring additional repair in another location.

This problem will likely require a few different solutions:

- (1) The laser could be designed to scatter significantly with distance such that if the laser were to reflect back on an astronaut or another system, the power density of the beam would be low enough to cause no damage. This would limit the working distance for the welder.
- (2) The surface itself may be painted or roughened to reduce the reflectance, thereby limiting possible harm to the Station or crew.
- (3) Several low-power lasers could converge to a point at a desired distance from the welding apparatus. These low-power lasers may be designed with a power density such that a single beam could not penetrate the space suit or the Station.

5. APPLICATIONS OF WELDING IN SPACE

5.1 Sources of Spacecraft Damage

Space is harsh environment and orbiting stations have a variety of unique hazards they will face throughout their lifetimes. This section seeks to explain the various ways in which cracking/damage may occur, illustrating why welding in space is a necessity for future projects such as Gateway.

First, radiation from the Sun is a major factor that can have deleterious effects on space structures. Radiation will have two effects that are important to a space structure: the inducement of thermal cycles on the structure, and the dislodging of atoms from their lattices to interstitial locations on the structure. Thermal cycles will occur as a result of the orbit of the Space Station. The orbiting structure will go behind the Earth in relation to the Sun for a given period of time, cooling the Station, and then reemerge to be heated by the Sun. These thermal cycles will weaken the structure, causing cracking along the surface.

When electromagnetic waves of a critical range of wavelengths impinge on the surface, some atoms will be knocked from their original lattices and move to interstitial sites and create vacancies in their original locations. This tends to cause embrittlement of the metal, making the material less resistant to shock and more prone to cracking.

Second, micrometeoroids and space debris will strike an orbiting Station throughout its lifetime, as is evident on the ISS, where several solar arrays show damage caused by micrometeoroids. The hope is that the meteoroids will not hit any critical areas and cause emergency evacuation of the structure. Damage from meteoroids may include damage to habitation modules, solar array structures, pipelines, etc. An example of this form of damage appears in reference 23.

Third, vibrations within the orbiting structure may become significant. Sources of vibration may include docking of shuttles carrying crew or supplies, space junk bouncing off the surface of the Station, or a result of the Station maneuvering to maintain a desired altitude.

Fourth, hermetic seals could become ruptured during the operational lifetime, causing decompression and stress on the surrounding materials.

Sources of damage are not limited to the possibilities above. However, it is clear from the discussion presented that a space welding device is necessary for any long-term space platform. A welding device can decrease risk to the structure substantially by offering the ability to repair the Station quickly and effectively.

5.2 International Space Station External Materials

A comprehensive list of the materials present on the ISS is not publicly available, so the focus here will be on the main structural materials present externally. By surface area, aluminum 2219-T6, an age-hardened Al-Cu alloy, is by far the most ubiquitous, as it makes up the thin shell surrounding the various modules of the Space Station. Titanium and steel are used internally as large load-bearing members due to their high strengths and densities. The aluminum modules are covered with layers of Kevlar®, ceramic fabrics, and other materials to form a blanket up to 10 cm thick around the shells to reduce damage caused by micrometeoroids.

Al-2219 was chosen as the main structural material due to its high strength-to-weight ratio, face-centered cubic (FCC) structure, and isotropic properties. It may be noteworthy to perform calculations to determine if FCC materials are superior to back-centered cubic materials in radiative environments, as it may be more difficult to dislodge atoms from a lattice if they are FCC.

Each of these three metals are readily able to be welded. However, there are concerns that need to be addressed with each of these. When welding steel, the various cooling rates across the weld can cause anodic/cathodic sections that may affect the structural integrity of the welds. Based on existing literature, it is unclear if this same phenomenon may occur in aluminum and titanium.

5.3 Benefits of Welding in Space

There are several ways in which damage could occur to an orbiting Station. Currently, the best way to fix these issues is to send replacement parts to the Station with extremely detailed procedures for carrying out the repairs by the astronaut. This is costly, as space vehicle launches often run over \$100 million. The solution is to develop tools and standards astronauts may use to carry out repairs quickly and economically. Adding an in-space welding apparatus to this arsenal could cut costs significantly and improve repair capabilities at the same time.

Hermetic seals are perhaps the most important structures to an orbiting Station as they often keep astronauts alive to carry out their tasks. If a leak occurs in a seal, it will need to be fixed quickly, lest further damage occur to the structure. Welding is one of the best ways to create hermetic seals. The ability to weld these structures without waiting for new equipment may limit the risks to astronauts in the event of damage.

This ability for rapid repair may also become more significant as orbiting Stations such as Gateway move further from Earth and the associated cost of shipping parts increases. It is important to develop these technologies now so that they will be ready for future exploration missions.

At the same time, designers should maintain awareness of the various metal AM devices that may be tested aboard the ISS in the next few years; these are discussed in a later section. Assuming that these devices are successfully demonstrated on the ISS, they will greatly aid repair operations in the future by enabling broken parts to be rapidly manufactured and replaced aboard the Station. This creates an opportunity that furthers the utility of an in-space welding apparatus. For example, suppose a large crack develops on the outside structure of the ISS and a simple weld

will not work. These AM devices could produce a plate of the desired size and an astronaut can weld the plate to the outside structure as a quick repair. As technology improves, it is the right time to develop repair methods for space vehicles to increase cost effectiveness and therefore increase opportunities for sustained and safer human space exploration.

Currently, many spacecraft structures are designed to withstand high launch loads. Structures built in the space environment can be designed only for their operational use scenario. Removing launch load requirements means material can be used only where it is needed to ensure survival of their structure, resulting in more optimized and efficient designs. However, fusion welding processes operated in the space environment may result in greater porosity due to a lack of buoyancy-driven convection. On-orbit welding experiments will be necessary to derive knockdown factors to facilitate welded joint design.

One challenge to implementation of on-orbit assembly, repair, and manufacturing technologies is the current design of systems based on orbital replacement units. If a system is not designed for servicing, the utility of these techniques to extend a system's life or provide an on-demand repair will be limited.

5.4 Joint Configurations

There appears to be no limit to the types of joints that may be welded in space, but an issue would arise if an older gun, such as the UHT, were chosen as the standard device. The penetration depth for this machine is low at about 1 to 2 mm. Any joint configuration that would require a section behind the surface material, such as a finger-flanged weld, would not work well as a result. The 'new' electron beam gun solves this problem by increasing the power. By designing a weld gun with a higher power, there does not appear to be a reason why a specific joint configuration would be unweldable.

6. STATE OF THE ART FOR ADDITIVE MANUFACTURING DEVICES FOR IN-SPACE USE

There are several processes currently being considered for manufacture of metallic parts in the microgravity, crewed environment. A summary of these technologies is provided for completeness. Due to the upper limit on component size imposed by the build chamber, it may become necessary to weld parts together to form an assembly or to integrate a component into an existing system. Several of the technologies use welding-based processes to additively manufacture metallics. Welding-derived AM processes could also be used in the external space environment, including on planetary surfaces, to produce large structures.

6.1 Vulcan Unit

Vulcan^{23,24} is a metal AM device currently being developed by Made in Space for use aboard the ISS. The project is currently in a Small Business Innovative Research (SBIR) contract SBIR phase II-E development effort. The Vulcan system will include a metal AM unit for metals and polymers, a computer numerical control (CNC) mill, an environmental control unit, and a robotic arm to assist in removing the part from the build plate and fixturing the part for machining. The Vulcan uses a hybrid additive process incorporating wire feed and arc deposition. In ground-based trials, Vulcan has successfully printed aluminum alloys and titanium. A concept design for the Vulcan is given in figure 6, along with a part printed using the system.²⁵



Figure 6. Vulcan apparatus²⁵ (image from Made in Space).

6.2 Ultrasonic Additive Manufacturing Process

The ultrasonic additive manufacturing (UAM) process^{23,24} is currently under an SBIR phase II initiative by UltraTech Machinery and Fabrisonic, Inc. A prototype design is pictured in figure 7.²⁵ The process operates by vibrating adjoining foils to remove an oxide layer and create a metallurgical bond. Under phase II, the companies are implementing a new sonotrode to scale down the process and CNC mill to finish the parts. The advantage with this method is its low power usage and that it can occur at room temperature.



Figure 7. UAM concept²⁵ (image from Ultra Tech Machinery and Fabrisonic).

6.3 Metal Advanced Manufacturing Bot-Assisted Assembly

The metal advanced manufacturing bot-assisted assembly (MAMBA)^{23,24} is a project by Tethers Unlimited and is currently funded under an SBIR phase II. It is made up of three systems: a press that processes virgin or scrap metal into a metal ingot, a CNC mill designed for microgravity to shape a part from the ingot, and a robotic assistant to facilitate automated processing of materials/parts through the system.

6.4 Sintered Inductive Metal Printer With Laser Exposure

Sintered inductive metal printer with laser exposure (SIMPLE)^{23,24} is a 3D metal printer in which a ferromagnetic wire metal filament is heated to its Curie temperature through induction and the metal is deposited on a build platform where a low-power laser completes the melt. SIMPLE is currently being developed by Techshot, Inc. A rendering of the system is shown in figure 8.²⁵

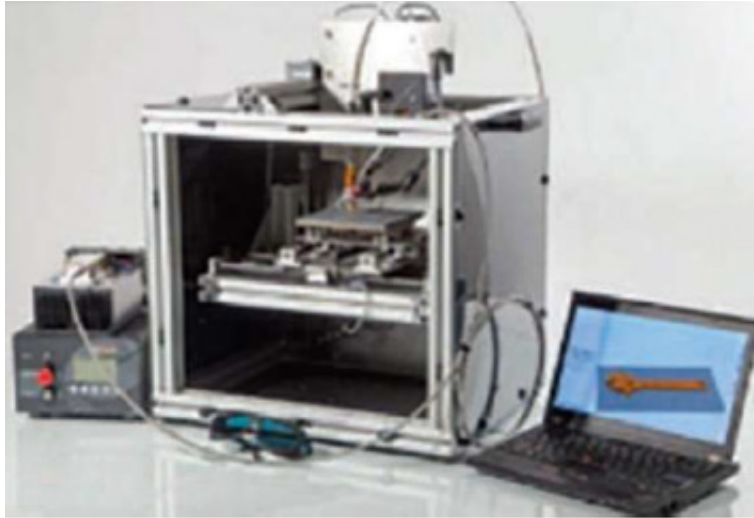

Figure 8. SIMPLE device²⁴ (image from Techshot).

6.5 Techshot Fabrication Laboratory

The Fabrication Laboratory (FabLab)^{23,24} is a fully integrated multimaterial fabrication apparatus currently being developed by Techshot in a phase A program. The system is intended to be used aboard the ISS. Phase A focuses on a demonstration of a metal manufacturing capability and development of a ground-based prototype compatible with ISS constraints. These constraints include a 2-kW maximum power draw, 260-kg weight limit, and dimensions compatible with an EXPRESS (Expedite the Processing of Experiments to Space Station) rack. The system must also include an in-process monitoring capability. Crew time requirements need to be minimized since it is not anticipated that astronauts will be able to tend to manufacturing systems on long-duration space missions. The configuration for the Techshot FabLab is shown to the left in figure 9.²⁵

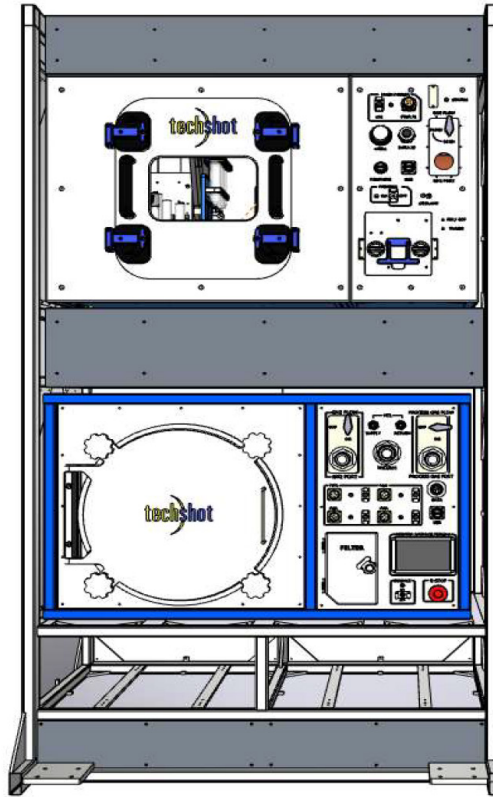

Figure 9. FabLab concept configuration.²⁵

The FabLab seeks to increase astronaut efficiency by providing autonomous process and verification and validation services in a system designed for microgravity operation. A related technology to support in-space manufacturing, the Emyrean FabLab, is in development by Tethers Unlimited. This unit will incorporate a post-process dimensional inspection and a robotic arm for manipulating manufactured parts.

7. RECENT NASA-SUPPORTED RESEARCH ON WELDING IN SPACE

NASA also has recently funded work on development of in-space welding capabilities through the SBIR program. Two of the projects are highlighted in this section. These development efforts represent work under the on-orbit servicing, assembly, and manufacturing (OSAM) initiative.

Under a phase I SBIR, Made in Space is developing a mobile end-effector laser device (MELD) capable of on-site, on-demand joining and repair of space structures. MELD is a self-sufficient end-effector that interfaces with a robotic arm and uses the arm for mobility. Key subsystems are directly contained in the end-effector such as a power supply, laser system, cooling system, vision system, and avionics. This system is programmed to be autonomous and relies on minimal human interaction. Joining of metal alloys, ceramics, and other natural resources are possible. The MELD system provides a tool that applies to many use cases and repair functions that are vital to future long-duration exploration missions. The MELD prototype is shown in figure 10.

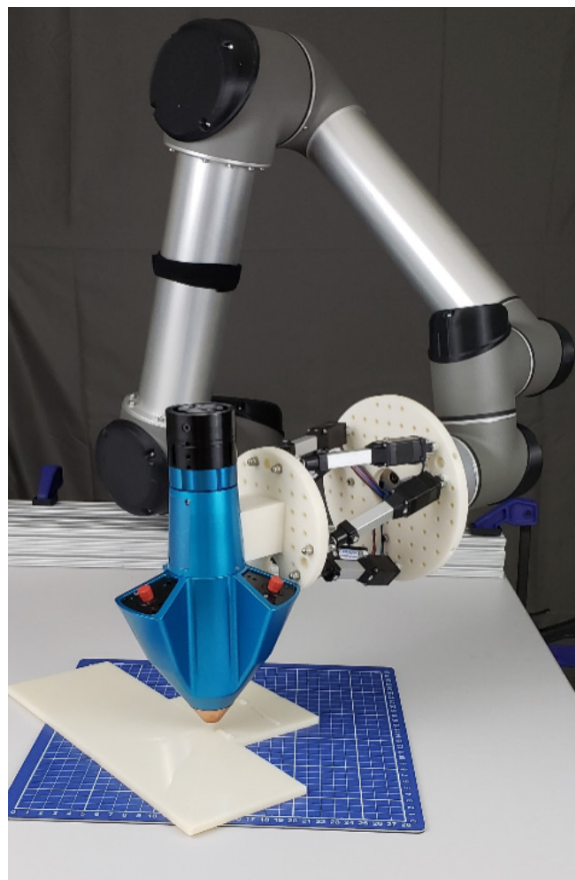

Figure 10. MELD prototype (image from Made in Space).

Also under a phase I SBIR, Busek Co. Inc. is developing a semiautonomous, teleoperated welding robot for joining metals in space. The welding robot will be an adaptation of a Busek-developed system called SOUL (satellite on umbilical line) with a suitable weld head attached to it. The SOUL welding platform is illustrated in figure 11.

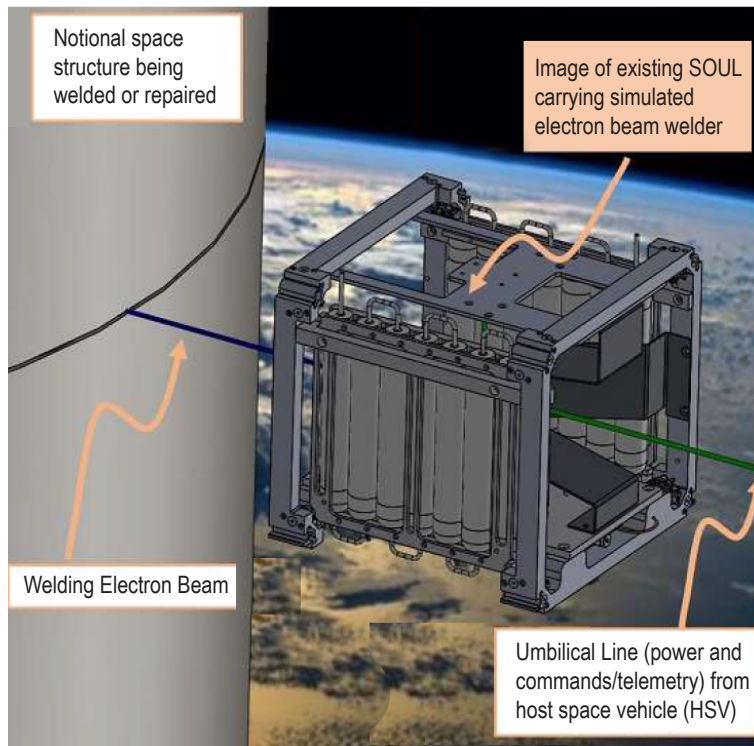

Figure 11. SOUL satellite platform for welding (image from Busek Co. Inc.).

8. SUMMARY

An in-space welding capability is an important supporting technology for long-duration, long-endurance space missions NASA will undertake beyond ISS. Designs for large structures, such as habitats and space telescopes, are primarily driven by launch considerations, including payload fairing constraints and launch loads. An in-space material joining capability can potentially eliminate constraints on the system imposed by launch, enabling the construction of larger, more complex and more optimized structures. Welding is a complementary capability to AM technologies being developed by NASA and commercial partners to facilitate in-space, on-demand production of spares and fabrication of larger than launch payload fairing structures. Welding is also a critical capability for repair scenarios (e.g., repair of damage to a structure from micrometeoroid impacts).

REFERENCES

1. Avduyevsky, V.S.: *Manufacturing in Space: Processing Problems and Advances*, MIR Publishers, Moscow, USSR, 248 pp., 1985.
2. Avduyevsky, V.S.; Grishin, S.D.; Leskov, L.V.; et al.: *Scientific Foundations of Space Manufacturing. Advances in Science and Technology in the USSR Technology Series*, V.S. Avduyevsky (Ed.), MIR Publishers, Moscow, USSR, 1984.
3. Barta, C.; Triska, A.; Fendrych, F.; and Krcova, E.: "Directional Solidification of the PbCl₂-AgCl Eutectic System Under Various Gravitational Conditions," *Microgravity Sci. Technol.*, Vol. 4, No. 1, pp. 26–32, 1991.
4. Ishikawa, M.; Nakamura, H.; and Yoda, S.: "Self-similarity of Later-stage Dendrite Growth Under Low Gravity," *Microgravity Sci. Technol.*, Vol. 7, No. 3, pp. 214–218, 1994.
5. Minagawa, H.; Suzuki, Y.; Shimokawa, K.; et al.: "Structure and Compositional Analysis of In-Sb Alloys Produced by Directional Solidification in Microgravity and Normal Gravity Conditions," *Microgravity Sci. Technol.*, Vol. 9, No. 2, pp. 58–61, 1996.
6. National Research Council, *Microgravity Research Opportunities for the 1990s*, The National Academies Press, Washington, DC, <<https://doi.org/10.17226/12284>>, 1995.
7. Tandon, K.N.; Saadat, F.; Chaturvedi, M.C.; and Cahoon, J.R.: "Microgravity Effects on Directionally Solidified Castings (Ground Based Experiments on Al-4% Cu Alloys)," *Microgravity Sci. Technol.*, Vol. 4, No. 1, pp. 19–25, 1991.
8. Paton, B.E.; and Lapchinskii, V.F.: *Welding in Space and Related Technologies*, 1st ed., Cambridge International Science Publishing, Limited, Kiev, Ukrain, 121 pp., 1997.
9. Workman, G.L.; and Kaukler, W.F.: "Laser Welding in Space," Houston, TX, <<https://ntrs.nasa.gov/search.jsp?R=19910018227> 2020-03-10T11:31:42+00:00Z>, 1989.
10. Askeland, D.R.; Fulay, P.P.; and Wright, W.J.: *The Science and Engineering of Materials*, SI Edition (6th ed.), CL-Engineering, p. 313, 2011.
11. Wang, G.; and Tandon, K.N.: "The Microstructural Changes During Laser Welding of Stainless Steel under Reduced Gravity Environment," *Microgravity Sci. Technol.*, Vol. 6, No. 2, pp. 96–100, 1993.
12. Kassemi, S.A.; and Ostrach, S.: "Nature of buoyancy-driven flows in a reduced-gravity environment," *AIAAJ*, Vol. 30, No. 7, pp. 1815–1818, doi.org/10.2514/3.11141, July 1992.

13. Kou, S.: *Welding Metallurgy*, 2nd ed., Wiley-Interscience, 2003.
14. Kamotani, Y.; Ostrach, S.; and Pline, A.: “Analysis of velocity data taken in Surface Tension Driven Convection Experiment in microgravity,” *Phys. Fluids*, Vol. 6, No. 11, pp. 3601–3609, doi.org/10.1063/1.868432, 1994.
15. Tang, H.; Tang, Z.M.; Hu, W.R.; et al.: “Numerical Simulation of g-jitter Effects on Half Floating Zone Convection Under Microgravity Environment,” *Microgravity Sci. Technol.*, Vol. 9, No. 1, pp. 28–34, 1996.
16. Ellison, J.; Ahmadi, G.; Regel, L.; and Wilcox, W.: “Particle motion in a liquid under g-jitter excitation,” *Microgravity Sci. Technol.*, Vol. 8, No. 3, pp. 140–147, November 1995.
17. Yasuhiro, S.; Sato, T.; and Ismaishi, N.: “Three Dimensional Oscillatory Marangoni Flow in Half-zone of Pr=1.02 Fluid,” *Microgravity Sci. Technol.*, Vol. 10, No. 3, pp. 144–153, 1997.
18. Poorman, R.M.: “Skylab M551 Metals Melting Experiment,” NASA-TM-X-64960, NASA Marshall Space Flight Center, Huntsville, AL, May 1975.
19. Benfield, M.P.J.; and Landrum, D.B.: “The International Space Welding Experiment,” *J. Technol. Transfer*, Vol. 23, No. 3, pp. 25–38, September 1988.
20. Paton, B.E.; Lobanov, L.M.; Naidich, Y.V.; and Asnis, Y.A.: “New electron beam gun for welding in space,” *Sci. Technol. Weld. Join*, Vol. 24, No. 4, pp. 1–7, October 2018.
21. Nunes, Jr., A.C.; Russell, C.; Vaughn, J.; et al.: “Assessment of Corona/Arcing Hazard for Electron Beam Welding in Space Shuttle Bay at LEO for ISWE: Test Results,” NASA-TM-108525, NASA Marshall Space Flight Center, Huntsville, AL, November 1996.
22. Fragomeni, J.M.; and Nunes, Jr., A.C.: “Dynamics of space welding impact and corresponding safety welding study,” *Acta Astronaut.*, Vol. 54, No. 6, pp. 399–412, doi: 10.1016/s0094-5765(03)00160-7, 2004.
23. Svemirac, “Space Debris - What is it? Problems and Solutions,” *Steemit*, <<https://steemit.com/steemstem/@svemirac/space-debris-how-it-s-made-problems-and-solutions>>, 2017.
24. Prater, T.; Werkheiser, N.; Ledbetter, F.; and Morgan, K.: “In-Space Manufacturing at NASA Marshall Space Flight Center: A Portfolio of Fabrication and Recycling Technology Development for the International Space Station,” NASA Marshall Space Flight Center, Huntsville, AL, <<https://ntrs.nasa.gov/archive/nasa/casi.ntrs.nasa.gov/20180006401.pdf>>, 2018.
25. Prater, T.; Risdon, D.; Edmunson, J.; et al.: “Overview of the In-Space Manufacturing Technology Portfolio,” NASA & ISS National Lab Microgravity Materials Science Workshop, Atlanta, GA, <https://www.issnationallab.org/wp-content/uploads/09_Tracie-Prater_NASA.pdf>, July 29, 2019.

REPORT DOCUMENTATION PAGE			Form Approved OMB No. 0704-0188		
<p>The public reporting burden for this collection of information is estimated to average 1 hour per response, including the time for reviewing instructions, searching existing data sources, gathering and maintaining the data needed, and completing and reviewing the collection of information. Send comments regarding this burden estimate or any other aspect of this collection of information, including suggestions for reducing this burden, to Department of Defense, Washington Headquarters Services, Directorate for Information Operation and Reports (0704-0188), 1215 Jefferson Davis Highway, Suite 1204, Arlington, VA 22202-4302. Respondents should be aware that notwithstanding any other provision of law, no person shall be subject to any penalty for failing to comply with a collection of information if it does not display a currently valid OMB control number.</p> <p>PLEASE DO NOT RETURN YOUR FORM TO THE ABOVE ADDRESS.</p>					
1. REPORT DATE (DD-MM-YYYY) 01-04-2020		2. REPORT TYPE Technical Memorandum		3. DATES COVERED (From - To)	
4. TITLE AND SUBTITLE A Review of Welding in Space and Related Technologies			5a. CONTRACT NUMBER		
			5b. GRANT NUMBER		
			5c. PROGRAM ELEMENT NUMBER		
6. AUTHOR(S) N. Naden* and T.J. Prater			5d. PROJECT NUMBER		
			5e. TASK NUMBER		
			5f. WORK UNIT NUMBER		
7. PERFORMING ORGANIZATION NAME(S) AND ADDRESS(ES) George C. Marshall Space Flight Center Huntsville, AL 35812			8. PERFORMING ORGANIZATION REPORT NUMBER M-1505		
9. SPONSORING/MONITORING AGENCY NAME(S) AND ADDRESS(ES) National Aeronautics and Space Administration Washington, DC 20546-0001			10. SPONSORING/MONITOR'S ACRONYM(S) NASA		
			11. SPONSORING/MONITORING REPORT NUMBER NASA/TM-2020-220557		
12. DISTRIBUTION/AVAILABILITY STATEMENT Unclassified-Unlimited Subject Category 29 Availability: NASA STI Information Desk (757-864-9658)					
13. SUPPLEMENTARY NOTES Prepared by the Materials and Processes Laboratory, Engineering Directorate *The University of Alabama in Huntsville					
14. ABSTRACT This Technical Memorandum (TM) provides a high-level summary of the history of on-orbit welding experiments, modeling efforts, and relevant microgravity materials science research. The TM also includes a survey of recently funded work on the in-space welding process and hardware development. This work was completed under the Virtual Student Federal Service (VSFS) program.					
15. SUBJECT TERMS welding, in-space welding, microgravity materials science, materials, on-orbit manufacturing					
16. SECURITY CLASSIFICATION OF:			17. LIMITATION OF ABSTRACT	18. NUMBER OF PAGES	19a. NAME OF RESPONSIBLE PERSON
a. REPORT	b. ABSTRACT	c. THIS PAGE			STI Help Desk at email: help@sti.nasa.gov
U	U	U	UU	36	19b. TELEPHONE NUMBER (Include area code) STI Help Desk at: 757-864-9658

National Aeronautics and
Space Administration
IS02
George C. Marshall Space Flight Center
Huntsville, Alabama 35812