

A CubeSat-Payload Radiation-Reliability Assurance Case Using Goal Structuring Notation

Rebekah A. Austin, Nagabhushan Mahadevan, Dr. Brian D. Sierawski, Dr. Gabor Karsai, Dr. Arthur F. Witulski

Vanderbilt University

Dr. John Evans

NASA

Sponsored by NASA Grant #NNX15AV48G

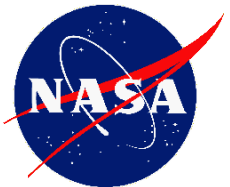

RAMS 2017 03E: R&M in Space Applications
Monday, January 23rd, 4:15 PM



Acronyms and Abbreviations

- **AMSAT: Radio Amateur Satellite Corporation**
- **BN: Bayesian Network**
- **COTS: Commercial Off-the-Shelf**
- **GSN: Goal Structuring Notation**
- **JWST: James Webb Space Telescope**
- **LEO: Low Earth Orbit**
- **MBSE: Model-Based Systems Engineering**
- **NASA: National Aeronautics and Space Administration**
- **R&M: Reliability and Maintainability**
- **RAMS: Reliability and Maintainability Symposium**
- **REM: Experiment Board**
- **RHA: Radiation Hardness Assurance**
- **SEE: Single-Event Effects**
- **SEFI: Single-Event Functional Interrupt**
- **SEL: Single Event Latch-up**
- **SEU: Single-Event Upset**
- **SRAM: Static Random Access Memory**
- **SysML: System Modeling Language**
- **TID: Total Ionizing Dose**
- **VUC: Controller Board**
- **WDT: Watchdog Timer**
- **WDI: WDT Input**
- **WDO: WDT Output**
- **WebGME: Web-based Generic Modeling Environment**

Introduction

- **CubeSats: Platform for affordable, quick-turn spaceflight**
 - Volume, mass, and power constraints
 - Use of rad-hard parts prohibitive
- **Traditional Radiation Hardness Assurance (RHA)**
 - System reliability based on parts reliability
- **Commercial off-the-shelf (COTS) RHA**
 - System reliability based on system mitigation of part faults and failures

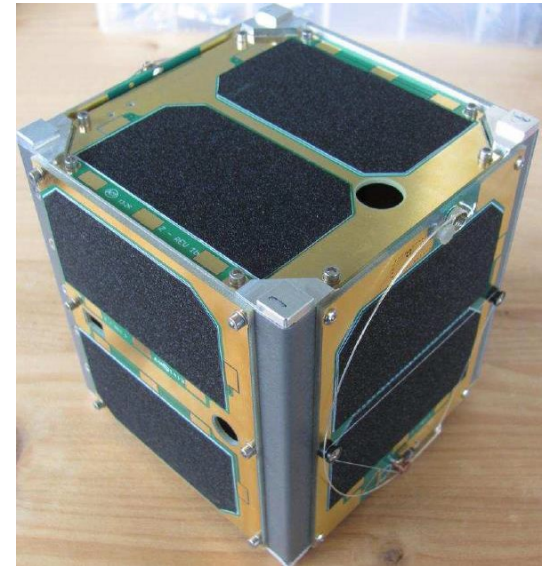

AO-85 Engineering
Prototype (AMSAT)

Outline

- **Background**
 - Radiation Effects
 - Radiation Hardness Assurance
 - NASA Reliability & Maintainability
 - CubeSat Experiment Block Diagram
- **Goal Structuring Notation (GSN)**
 - Custom Modeling Environment - WebGME
 - Goal Structuring Notation (GSN)
 - GSN Case for CubeSat Experiment

Radiation Effects

Radiation Effect	Physical Mechanism	Effect on CubeSat System
Total Ionizing Dose (TID)	Charge deposited in insulating oxides over time	1) Increased power consumption 2) Early system failure
Single Event Latch-up (SEL)	Self-sustaining high-current condition	1) Premature system failure 2) Drain battery
Single Event Functional Interrupt (SEFI)	Bit flip in microcontroller from particle strike	1) Unknown behavior 2) System crash

Radiation Hardness Assurance (RHA)

- **Methodology for ensuring systems against radiation environment**
 - Define system requirements, define radiation environment, test COTS, design radiation-tolerance

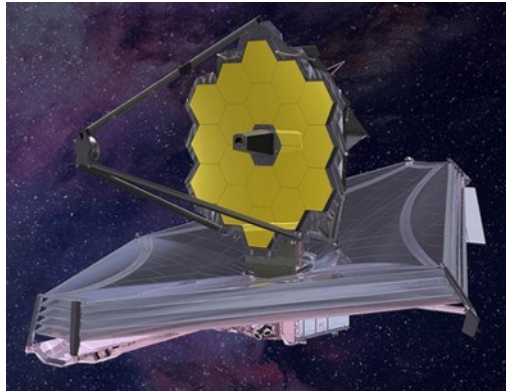

JWST
(Northrop Grumman)

VS.



CubeSat Deployment
(NASA)

NASA Reliability & Maintainability (R&M)

- Old Paradigm: Reliability proven through list of tests passed

- Proposed New Paradigm: NASA R&M Hierarchy created

to change reliability requirements to be objective-based (Groen, RAMS 2015)

- Based on GSN
- Integration with MBSE

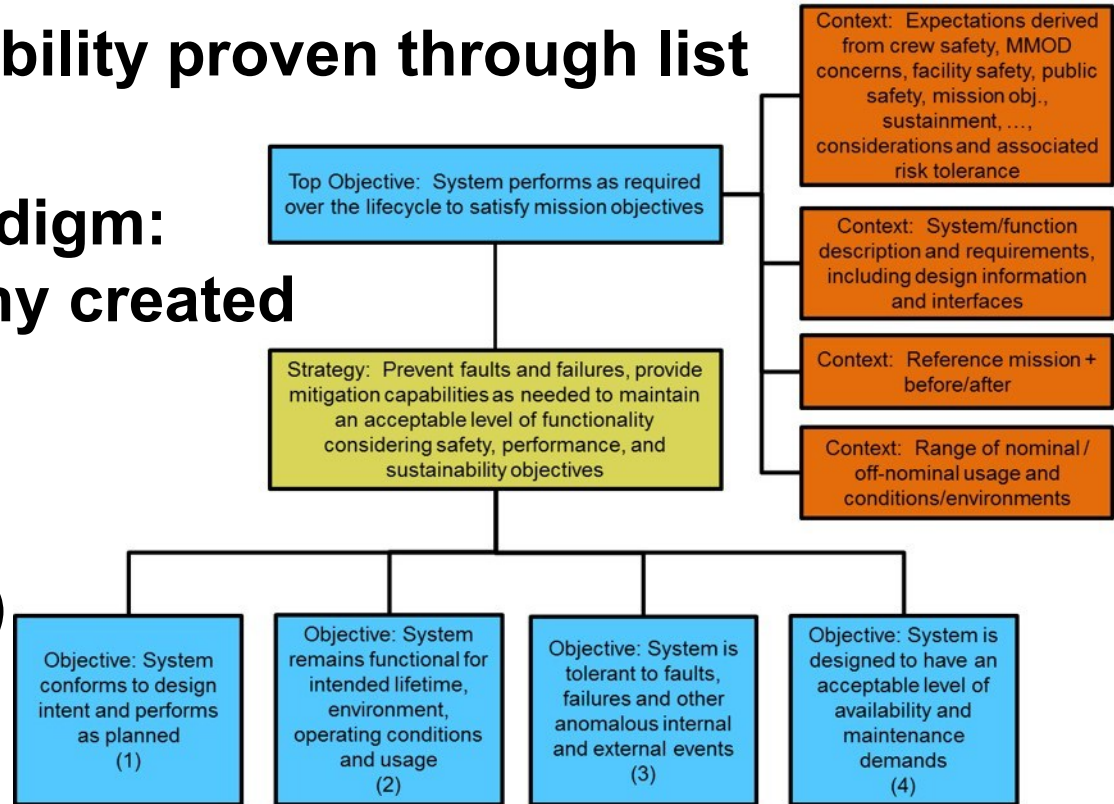

R&M Hierarchy (Groen, RAMS 2015)

CubeSat Experiment Block Diagram

Record the number of SEUs in 28nm bulk SRAM in LEO for a period of 1 year.

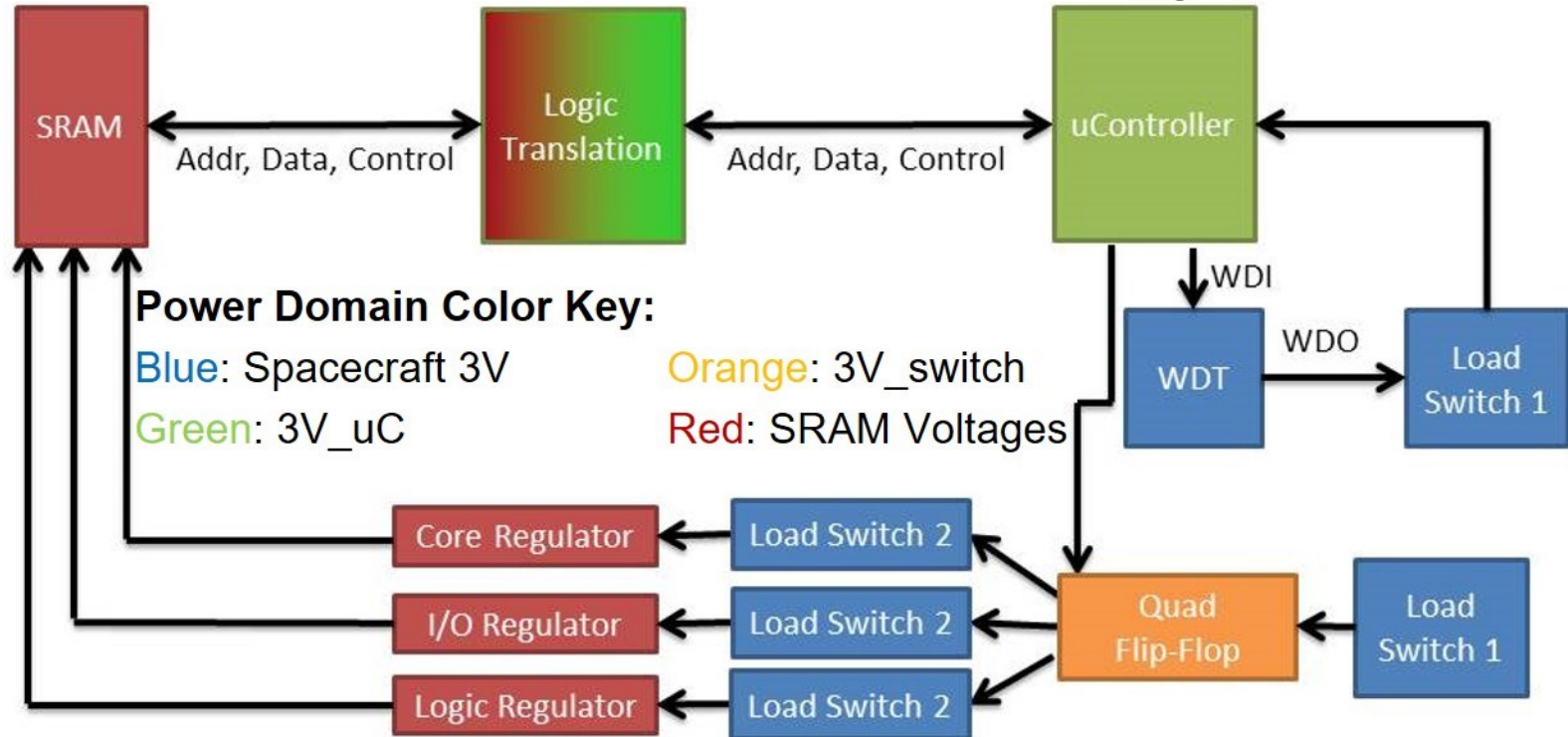

Custom Modeling Software - WebGME

- **Models include:**
 - Goal Structuring Notation (GSN)
 - SysML
 - Fault Propagation
 - Function Model
- **Links across models and external documents**

<https://webgme.org/>

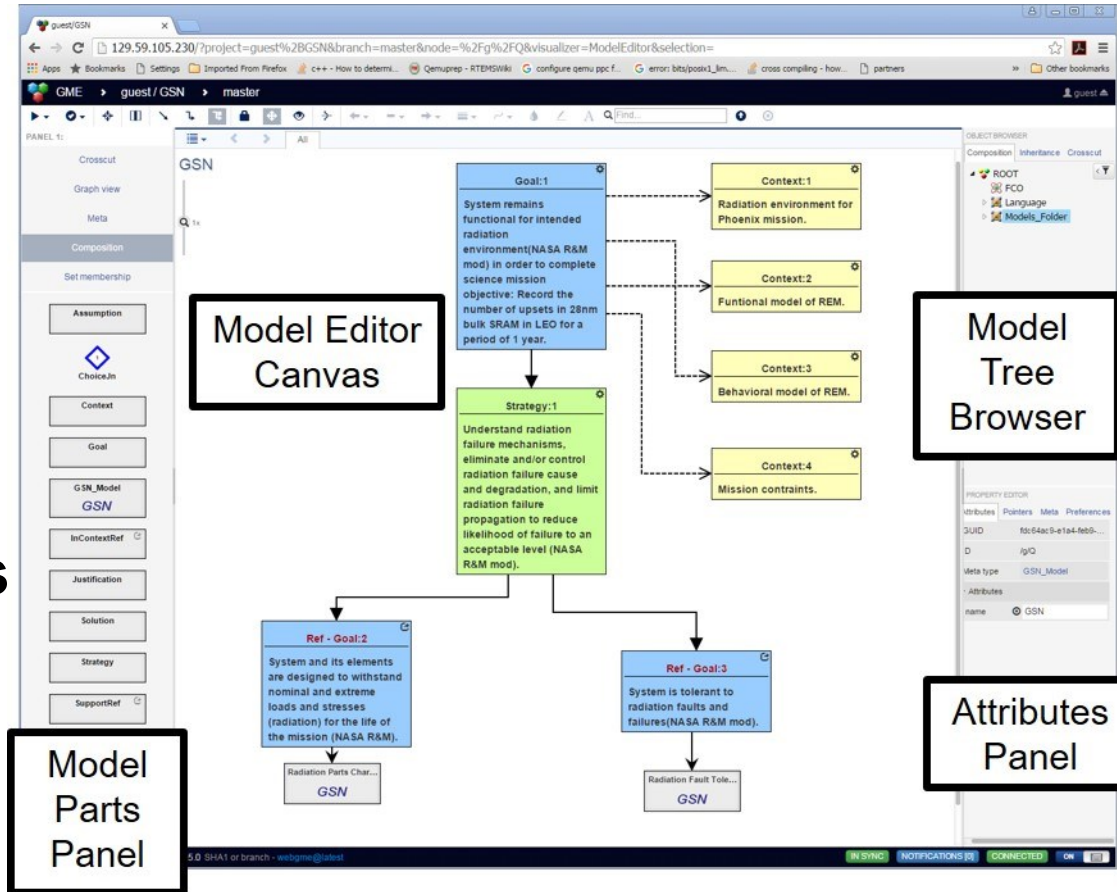

Goal Structuring Notation (GSN)

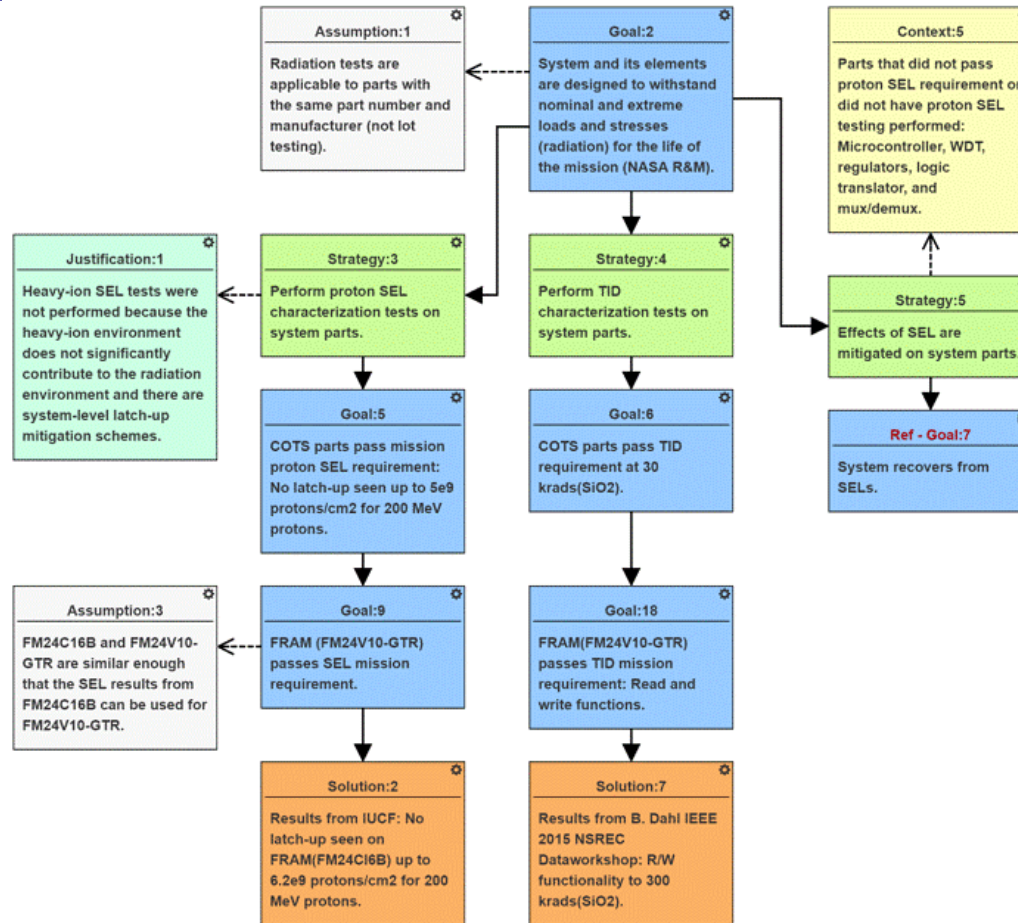

Goal Structuring Notation (GSN)

Goal

Strategy

Supported by

Solution

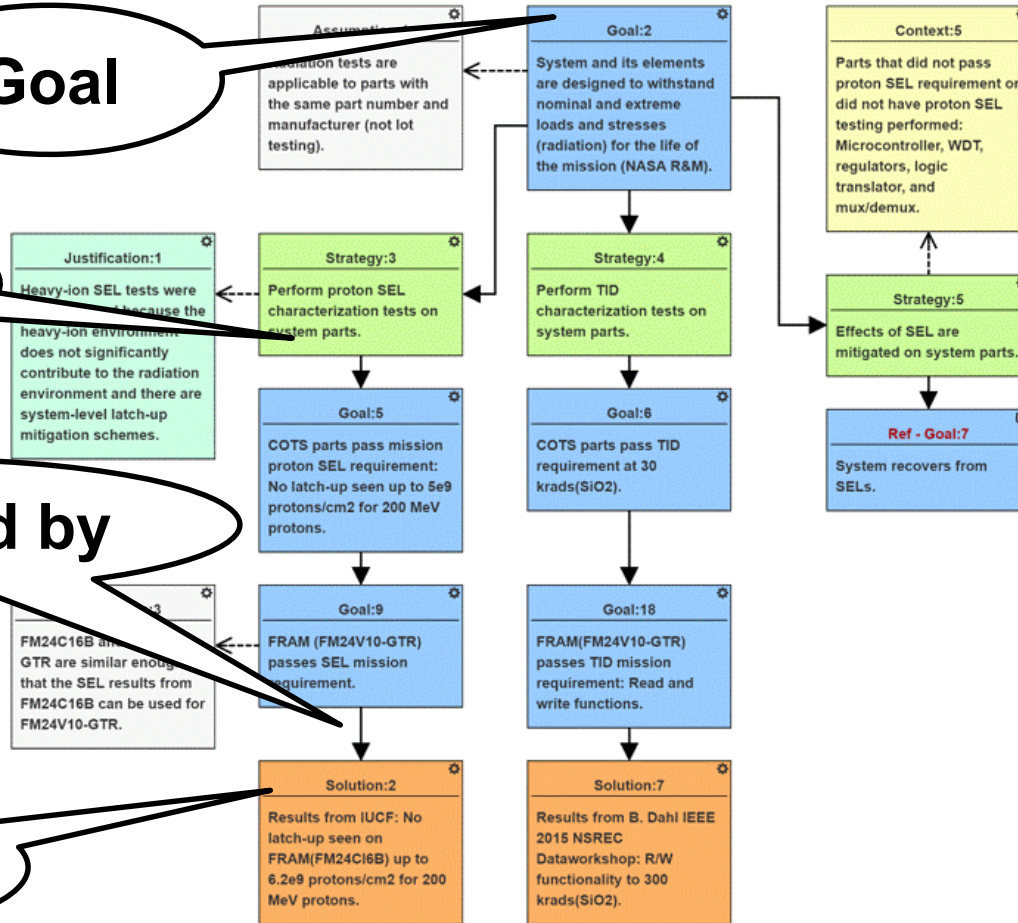

Goal Structuring Notation (GSN)

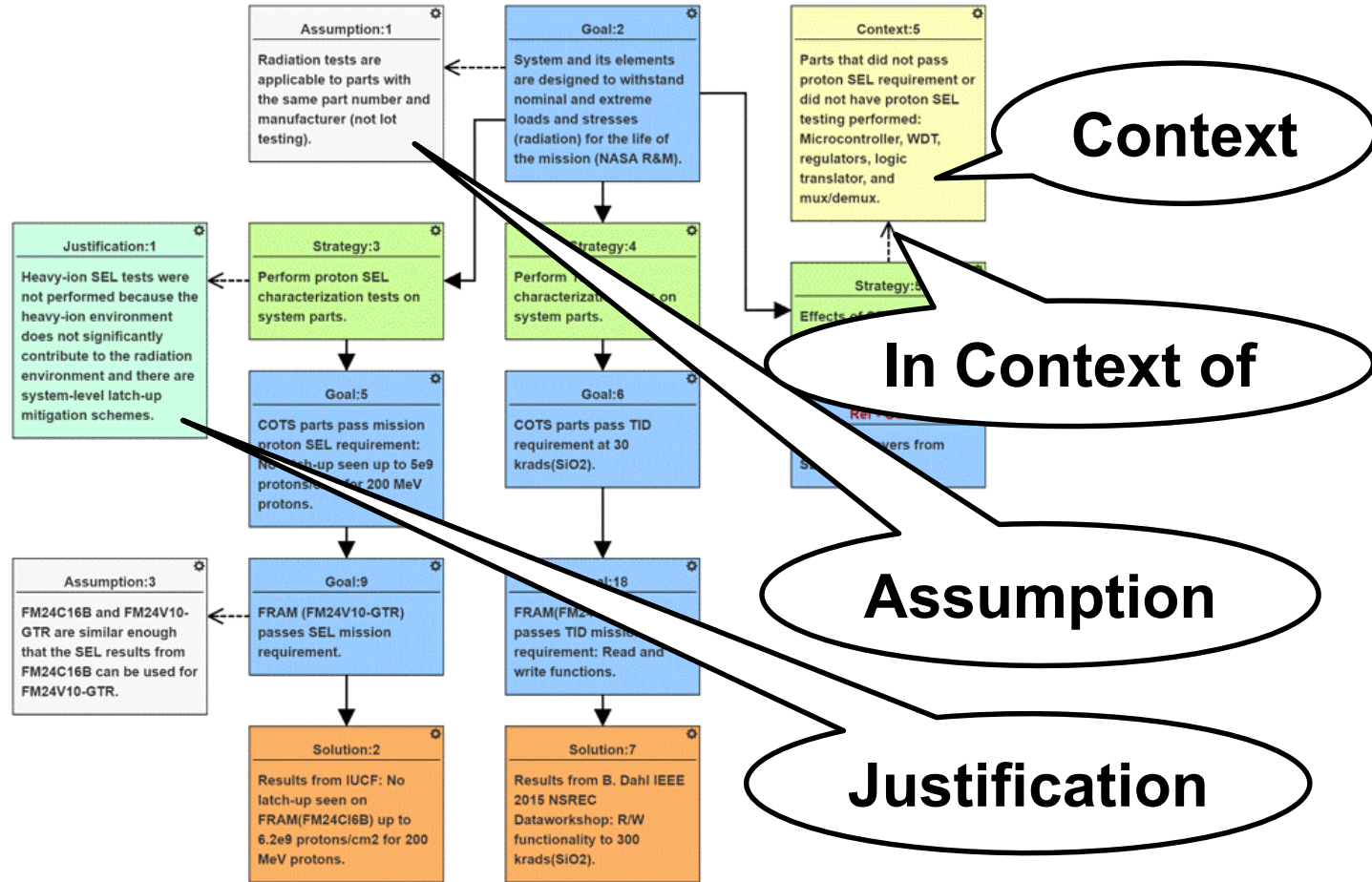

Goal Structuring Notation (GSN)

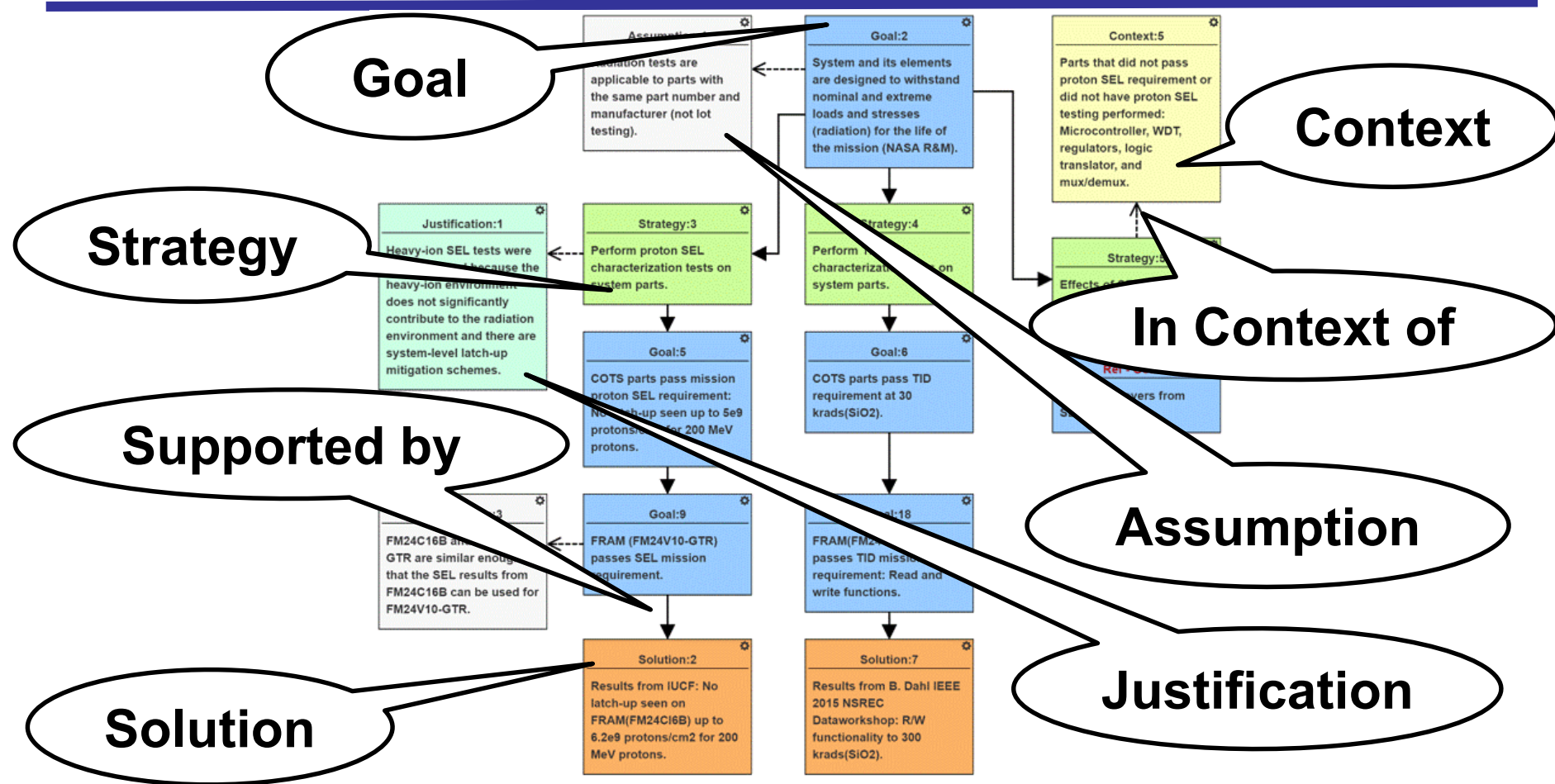

CubeSat Experiment GSN Model

- **Goal 1: Survives radiation environment to complete science mission objective**
- **Strategy 1: To complete science mission goal, the radiation environment is understood and mitigated**
- **Goal 2: Parts can survive the radiation environment**
- **Goal 3: System can survive radiation faults and failures**

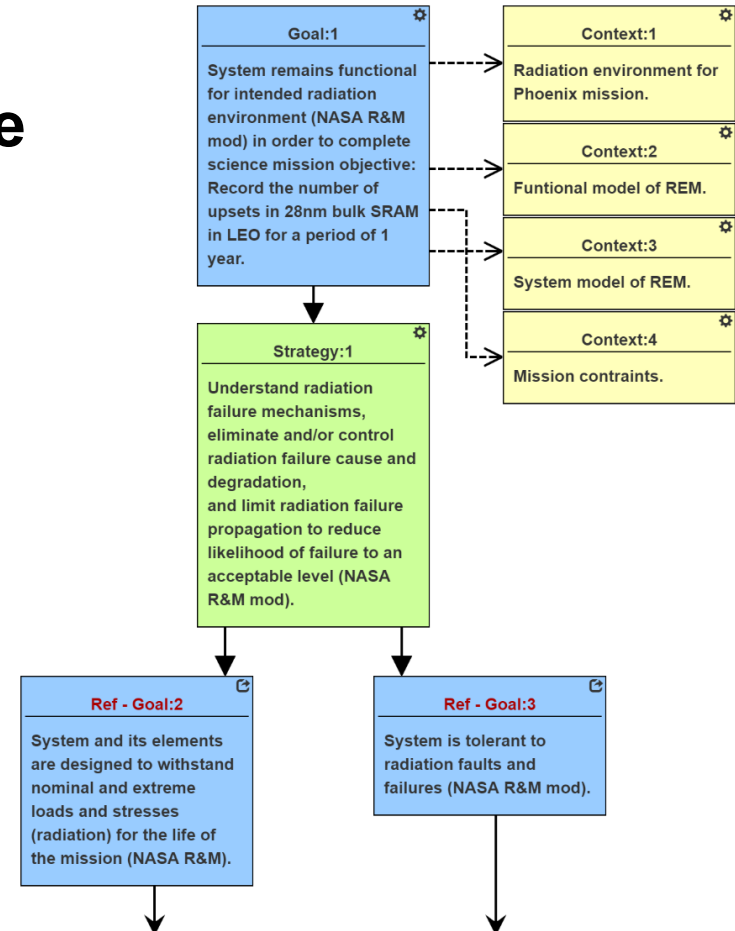

CubeSat Experiment GSN Model

- **Goal 13: SEL Detection**
- **Goal 14: SEL Recovery**
- **Goal 15: SEFI Detection**
- **Goal 16: SEFI Recovery**

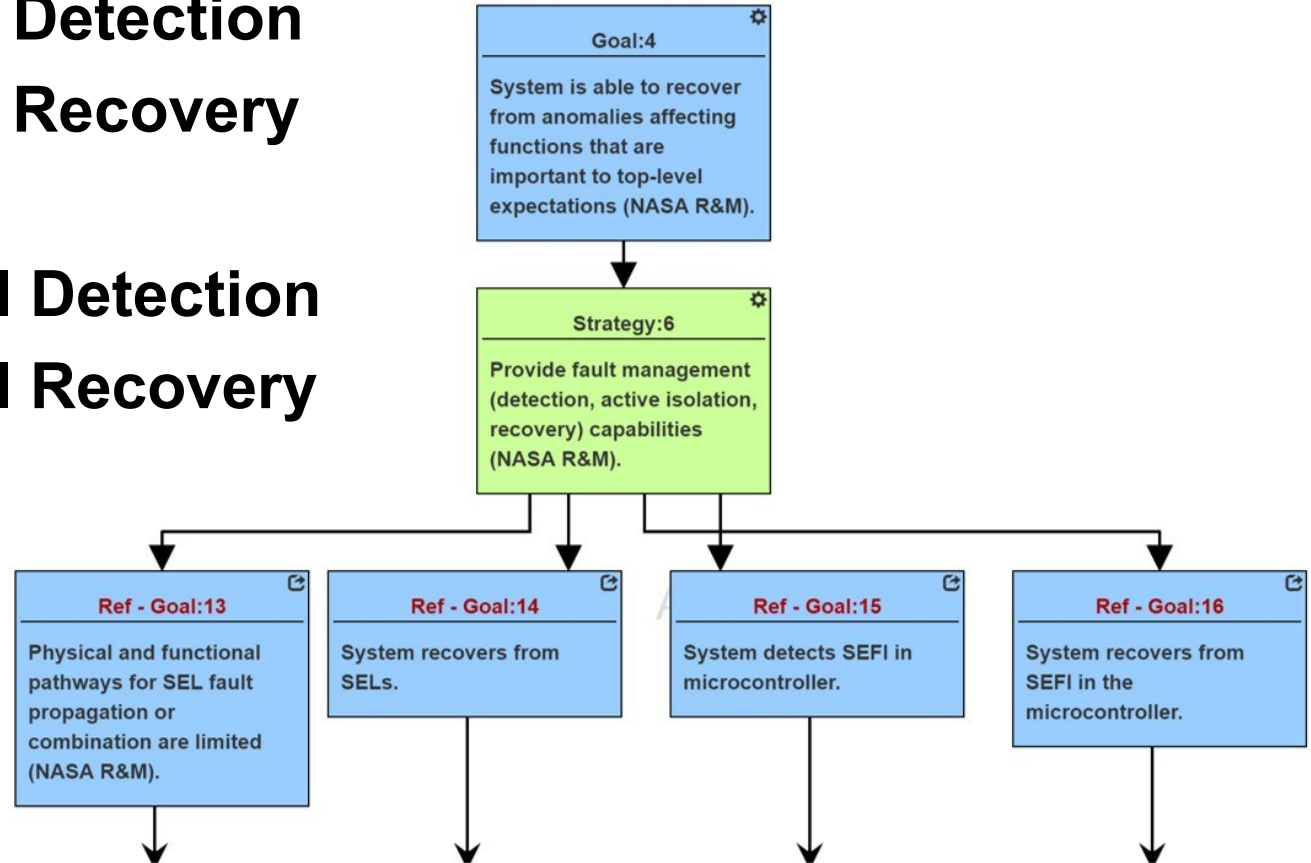

Results and Conclusions

- **Radiation-reliability assurance case made for CubeSat Experiment**
 - Based on R&M Hierarchy
 - Dependence of claims and solutions made explicit
 - Compatibility with MBSE

- **RHA for using COTS in CubeSats**
 - TID testing
 - SEL and SEFI system mitigation