

Demonstration of Airline-Based Airborne Reroute Operations using Trajectory Option Sets and Third-Party Tools

Paul U. Lee¹

NASA Ames Research Center, Moffett Field, CA, 94035

Connie L. Brasil², Conrad Gabriel Jr.³, Kevin Garzon⁴, Nathan J. Buckley⁵

San Jose State University/NASA Ames Research Center, Moffett Field, CA 94043

Scott N. Kalush⁶

Human Solutions Inc., Washington D.C., 20024

A concept that enables advanced airborne reroute operations is proposed, built on NextGen capabilities called Airborne Reroute (ABRR) and Trajectory Option Set (TOS). The concept introduces new third-party services / tools for the airline dispatchers to generate airline-preferred trajectories in response to convective weather events. The airborne TOS routes are sent to the traffic flow managers, who can evaluate the feasibility of the trajectory options with the help of their own third-party services / tools which have been built for this concept. A virtual demonstration study was conducted to elicit feedback from air traffic and airline subject-matter-experts. The feedback was generally positive, both in the benefits of the concept and the feasibility / need for the new tools to enable the concept but their feedback was mixed on the feasibility of the new tools to be third-party services instead of being integrated into their core tools. Nevertheless, this concept explores and demonstrates an evolutionary pathway toward a service-oriented future that shifts the responsibilities and the capabilities of air traffic operations from the air traffic service providers to the airline industry and third-party vendors.

I. Nomenclature

<i>AAL</i>	=	American Airlines
<i>ABRR</i>	=	Airborne Reroute
<i>ADRS</i>	=	Aeronautical Datalink and Radar Simulator
<i>ADS-B</i>	=	Automatic Dependent Surveillance-Broadcast
<i>AOC</i>	=	Airline Operations Center
<i>ANSP</i>	=	Air Navigation Service Provider
<i>ARTCC</i>	=	Air Route Traffic Control Center
<i>ATC</i>	=	Air Traffic Controllers
<i>ATCSCC</i>	=	Air Traffic Control System Command Center
<i>Data Comm</i>	=	Data Communication
<i>CDR</i>	=	Coded Departure Route
<i>CTOP</i>	=	Collaborative Trajectory Options Program

¹ Research Engineer, Human Systems Integration Division, NASA ARC

² Senior Research Associate, Human Systems Integration Division, SJSU/NASA ARC

³ Research Associate, Human Systems Integration Division, SJSU/NASA ARC

⁴ Research Associate, Human Systems Integration Division, SJSU/NASA ARC

⁵ Research Associate, Human Systems Integration Division, SJSU/NASA ARC

⁶ Simulation Engineer, Human Systems Integration Division, HSI/NASA ARC

<i>ERAM</i>	=	En Route Automation Modernization
<i>ETD</i>	=	Estimated Time of Departure
<i>FCA</i>	=	Flow Constrained Area
<i>FEA</i>	=	Flow Evaluation Area
<i>HITL</i>	=	Human-in-the-loop
<i>IAT</i>	=	Initial Arrival Time
<i>MACS</i>	=	Multi Aircraft Control System
<i>NAS</i>	=	National Airspace System
<i>PBN</i>	=	Performance-Based Navigation
<i>PDRR</i>	=	Pre-departure Reroute
<i>RAD</i>	=	Route Amendment Dialog
<i>RBS</i>	=	Ration by Schedule
<i>RTC</i>	=	Relative Trajectory Cost
<i>SWA</i>	=	Southwest Airlines
<i>SWIM</i>	=	System-Wide Information Management
<i>TBO</i>	=	Trajectory-Based Operation
<i>TFMS</i>	=	Traffic Flow Management System
<i>TMC</i>	=	Traffic Management Coordinator
<i>TMI</i>	=	Traffic Management Initiative
<i>TMU</i>	=	Traffic Management Unit
<i>TOS</i>	=	Trajectory Option Set
<i>TSD</i>	=	Traffic Situation Display
<i>UAL</i>	=	United Airlines
<i>UTM</i>	=	UAS Traffic Management
<i>ZOA</i>	=	Oakland ARTCC
<i>ZOB</i>	=	Cleveland ARTCC
<i>ZBW</i>	=	Boston ARTCC
<i>ZDC</i>	=	Washington ARTCC
<i>ZDV</i>	=	Denver ARTCC
<i>ZYZ</i>	=	Toronto Area Control Center

II. Introduction

In the early 2000s, the vision for NextGen was formed to modernize the air traffic system in the National Airspace System (NAS) for the next 25 years. The focus of NextGen centered on improving traditional commercial aviation to reduce congestion, reduce emissions, save fuel, and enable better information exchange. Under NextGen, capabilities such as Automatic Dependent Surveillance-Broadcast (ADS-B), System-Wide Information Management (SWIM), Data Communication (Data Comm), Performance-Based Navigation (PBN), and Trajectory-Based Operations (TBO) were developed and evaluated. Thanks to these capabilities, a more robust satellite-based navigation system can enable an aircraft to fly more precise and efficient routes, thereby reducing flight time, fuel costs, and emissions while maintaining a more predictable schedule.¹

In recent years, there has been significant interest in and rapid development of new types of missions and vehicles that had not not examined extensively earlier. New missions such as drone delivery services², on-demand air-taxi services³, autonomous cargo freighters, commercial space launches, high-altitude balloons⁴, high-altitude long-endurance vehicles⁴, and supersonic aircraft⁴ are predicted to be commonplace in the NAS and are expected to grow exponentially in the future. One of the key design thrusts of these new missions has been to build a community-based, cooperative traffic management system, built upon third-party services that provide functions such as separation, flight intent, and schedule management. This innovative approach has the potential to accelerate the expanded use of these new missions based on market forces and business incentives instead of relying or waiting on the government to implement these functionalities.

As new missions in the NAS develop these service-oriented architectures to support their operations, a desire to also evolve the existing traditional commercial aviation operations towards a more flexible, service-oriented architecture has been expressed. Unlike new missions, however, traditional operations have the burden of existing technology and equipment investments that cannot be discarded while moving towards a new air traffic system for the future. Therefore, new concepts, services, and tools in traditional operations will need to leverage and evolve existing

systems incrementally. These changes will need to ensure some compatibility with the current equipment during their expected lifetime and positively impact the safety and efficiency of operations.

One way that we envision developing this evolutionary pathway is to take incremental steps within the existing infrastructure to shift some of the non-safety critical functions from air navigation service providers (ANSPs) to airline and vehicle operators and introduce third-party services with automation and tools to aid decision making for ANSPs. In this paper, we describe a use case that utilizes advanced airborne reroute capabilities built on Airborne Reroute (ABRR), Trajectory Option Set (TOS), and third-party services / tools. This use case demonstrates how air traffic decision making may be partially shifted from ANSPs to airline operators, but only with the help of third-party services. In a later section, we will describe how the shift in roles and responsibilities and the introduction of third-party services could evolve into a full service-oriented system similar to the ones proposed for new missions (e.g. drone services).

III. Background

A. Airborne Reroute

In recent years, a suite of NextGen capabilities have been implemented to allow flexible rerouting options in response to dynamic changes in the air traffic environment. One such capability, called Airborne Reroute (ABRR), links the Traffic Flow Management System (TFMS), used by traffic management coordinators (TMCs), with the En Route Automation Modernization (ERAM) system used by air traffic controllers (ATCs). The ABRR connectivity enables TMCs to develop trajectory-based reroutes in TFMS for flow management purposes and digitally send complex, aircraft-specific reroutes to ATC ERAM stations for them to review and send to the flight deck as amended route clearances. The ABRR capability replaces today's cumbersome coordination between TMCs and ATCs, which is currently done by handwritten clearances and / or voice and therefore limits the ability of the TMCs to send more precise trajectories to the ATCs.

TMCs access the ABRR capability using the TFMS tool suite called Route Amendment Dialog (RAD)⁵, as shown in Fig 1. Using the RAD tool, TMCs can view the current route for specific aircraft, as well as different route options that are in its database with the "Rte Opts" button. These route options can be modified manually by typing in different route segments into the loaded flight trajectories, or a route can be generated from scratch by typing in entire trajectories.

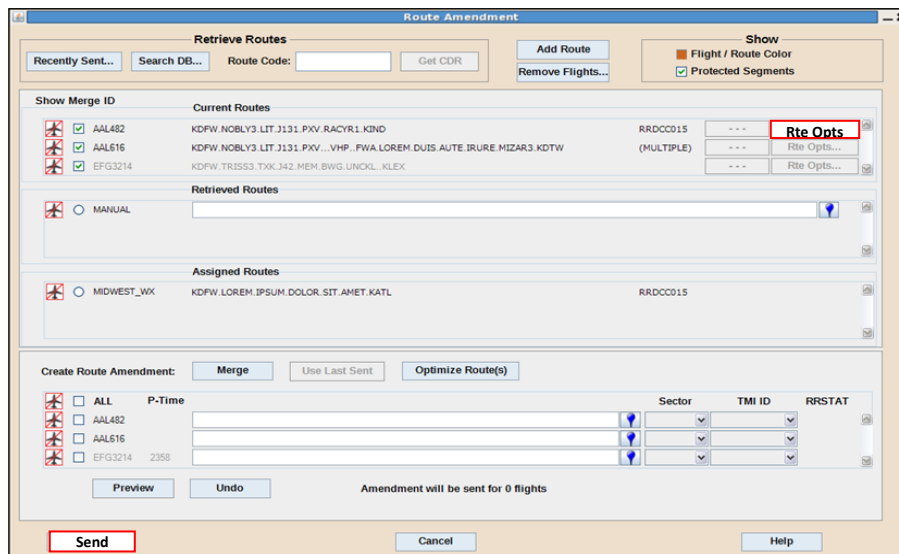

Fig. 1: Route Amendment Dialog (RAD) interface. "Rte Opts" and "Send" buttons are highlighted

Once the desired route option has been selected, TMCs can digitally send this route to the controllers via ABRR by clicking the "Send" button. This action sends the new trajectory to the appropriate controller station, which then displays a "T" notation next to the chosen aircraft on their radar display, as shown in the top figure in Fig. 2. The detailed route information is displayed on the radar associate display, as shown in the bottom figure in Fig. 2. ATCs

can review these route requests from the TMCs and if they approve, they can issue them as clearances to the flight deck by voice (or by Data Comm if the flight deck is Data Comm equipped).

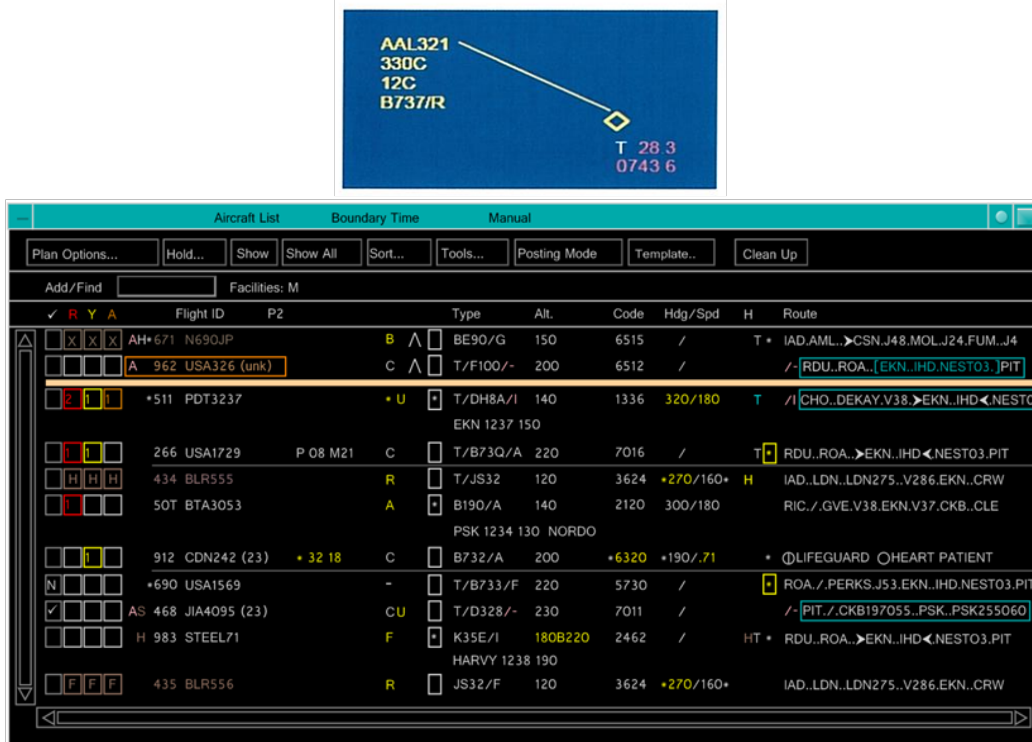

Fig. 2: ABRR route "T" indicator on the controller radar (top) and the radar associate display (bottom)

B. Trajectory Options Set

Trajectory Options Set (TOS) was originally developed as a part of the Collaborative Trajectory Options Program (CTOP).⁶ CTOP strategically controls the air traffic flow rates at multiple specified Flow Constrained Areas (FCAs) by allowing flight operators to submit the desired TOS for each affected flight prior to departure and then assess the multiple trajectories for each flight to select the route options that comply with capacity constraints while minimizing the "relative trajectory cost" (RTC) for each flight.

C. Integration of ABRR and TOS

Although TOS was originally developed to be used during the pre-departure phase as a part of CTOP, other potential uses of TOS have since been explored. In particular, a TOS could be updated and re-filed by flight operators while the flight is airborne, and these TOS may be reviewable by TMCs to provide a viable mechanism for allowing airlines to submit their user-preferred trajectories for airborne reroutes.

TMCs can review the TOS routes at any time using the RAD "Rte Opts" function, as illustrated in Fig. 1. The "Rte Opts" will show all available routes that were submitted via TOS, as well as other routes generated by the ANSP and stored in the database. Once these TOS routes are loaded into the RAD, the TOS routes can be selected and sent to ATCs using ABRR. Various researchers and operators have recently explored use cases for enabling ABRR / TOS combinations or related Pre-departure Reroutes (PDRR) / TOS combinations.⁷

D. Challenges of ABRR / TOS Operations without Additional Tools

Although ABRR and TOS capabilities together can enable user-preferred airborne reroutes in response to dynamic changes to weather or traffic patterns, in reality, there are various challenges and barriers that prevent both ATC and airline operators from utilizing them on a regular basis. One of the key barriers is that the TOS generation responsibilities for the airline dispatchers may be too labor intensive for them to execute without additional tool support. The tasks associated with TOS generation also do not fit neatly into the existing responsibilities within Airline

Operations Center (AOC). A closer examination of the procedures, and feedback from airline stakeholders, suggest that automation and decision support tools for TOS generation would be needed for airborne TOS to be fully utilized.

Airborne reroutes using ABRR / TOS integration also pose potential workload issues for TMCs. Allowing airline dispatchers to request airborne reroutes on a regular basis may overload TMCs who would need to evaluate multiple trajectories per flight request. The number of requests could multiply during a significant weather event, which would require TMCs to not only evaluate the individual trajectory requests, but also the impact of reroutes on the present and downstream sector capacity. Such scenarios will likely require multiple full-time "on-scope" TMC positions, who may need automation / decision support tools (DSTs) for evaluating the incoming TOS routes and their impact on downstream airspace constraints for the operational concept to be feasible.

In this paper, we explore if these new DST functions could potentially be provided by third-party vendors to help the decision-making process for both AOCs and TMCs. For the AOCs, we examine if the new functions should be integrated into their existing flight planning systems or be provided by third-party vendors without being fully incorporated into the flight planning systems. Similarly for the TMCs, we examine if the new functions should be integrated into TFMS or can be provided as additional DSTs provided by third-party vendors.

IV. Concept, Use Case and Operational Procedures

A. Conceptual Framework

In support of demonstrating airborne reroutes using ABRR / TOS integration, we developed a concept that augments ABRR and TOS capabilities with newly prototyped third-party services / tools for the airline dispatchers to generate airline-preferred trajectories in response to a convective weather event. AOC tools enable the airline dispatchers to generate dynamic airborne TOS on demand, calculate the RTCs, use them to prioritize the reroute trajectories, and communicate the routes and their priorities to the TMCs. The concept also allows TMCs to evaluate the traffic capacity / demand imbalance at one or more airspace constraints and provide support for communicating the reroute requests to the airlines to balance the traffic demand around the constraints. The ANSP / TMC tool uses its demand/capacity evaluation to determine how many flights must be removed from a given FCA over a defined time period. The details of the tool functionalities are described in the following sections in the context of a convective weather use case.

Fig. 3 shows the overall framework. The nominal communication framework is depicted in orange for the ANSP / TMC side and in green for the AOC side. Two third-party services / tools, i.e., one for ANSP / TMC and the other for AOC, are depicted in blue.

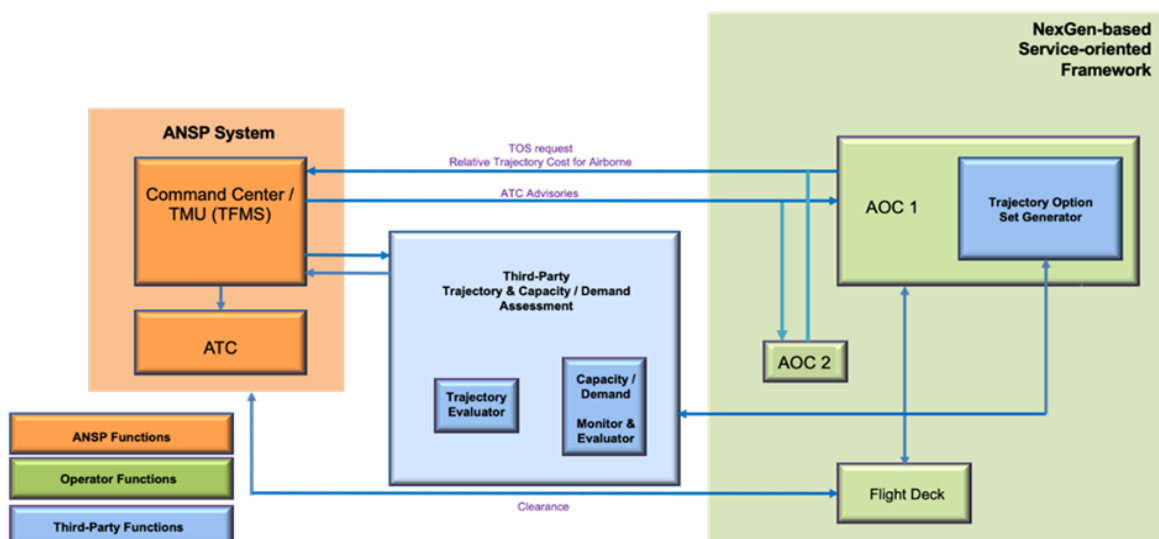

Fig. 3: Framework for using third-party tools and ABRR/TOS to enable airline-generated airborne routes

B. Use Case and Procedures

By leveraging existing technology and equipment investments in ABRR and TOS within traditional operations and adding third-party services / tools, the trajectory generation function has the potential to be shifted to the airlines. Such a shift could provide an evolutionary pathway from the current NAS structure towards the new service-oriented architecture being proposed in new vehicle operations such as UAS Traffic Management (UTM). To demonstrate this shift of decision making to the airlines, we developed a concept, a use case, and operational procedures that facilitate airborne reroutes in response to convective weather.

The use case that was selected was a forecasted weather change to a traffic management initiative (TMI) already in place through Cleveland Air Route Traffic Control Center (ZOB ARTCC). A TMI was put in place for scattered thunderstorms in ZOB sectors 57/59/77/79. These sectors are very busy and complex into and out of the Northeast Corridor. They primarily handle the eastbound arrivals from the west to New York metroplex airports as well as some of the westbound New York TRACON departures. In addition, Boston ARTCC (ZBW) arrivals and departures via J29, Philadelphia (PHL) arrivals from the west and northwest, and crossing Toronto Area Control Center (ZYZ), Rochester (ROC), and Buffalo (BUF) arrival and departure traffic to/from the south also transit this airspace.

A single FCA (blue dashed) was placed geographically around the boundaries of the four sectors (see Fig. 4) and traffic was reduced to 48 aircraft per hour (12 per 15 minutes). In addition, a monitoring Flow Evaluation Area (FEA) was established for ZBW to evaluate the effects of reroutes and ensure volume does not exceed maximum traffic levels through the area. The original TMI assigned ground delay and TOS reroutes to all filed pre-departure traffic through the ZOB FCA.

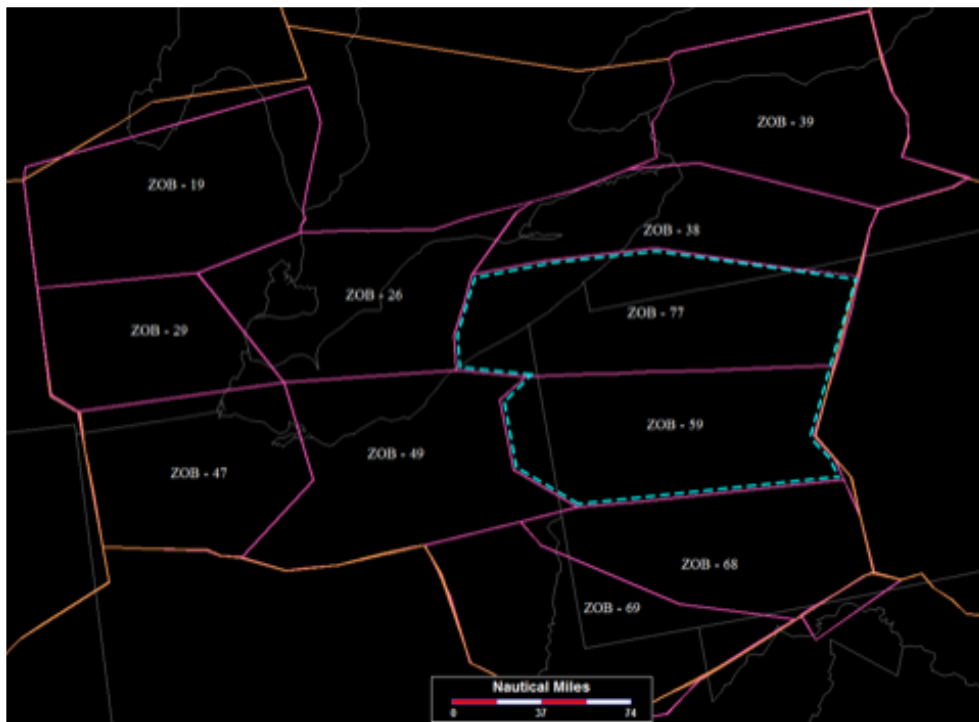
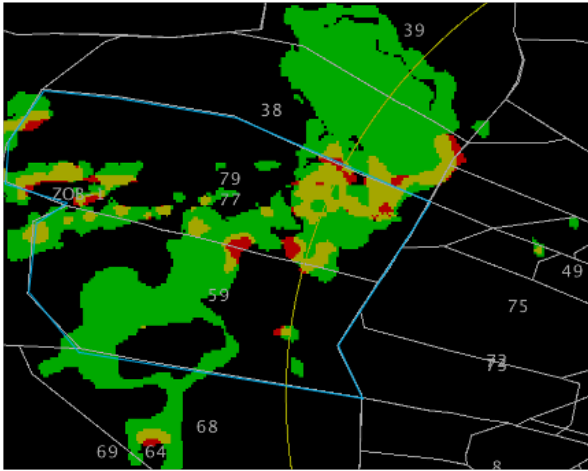

Fig. 4: FCA around ZOB sectors 57/59/77/79

About an hour into the TMI, a new updated 2-hour weather forecast (Fig. 5) was issued which indicated that the thunderstorm activity would be worse than expected. ZOB TMCs and Air Traffic Control System Command Center (ATCSCC) TMCs determined that they need to further lower the traffic rate by 50% and amend the TMI for 1-2 hours from current time. Third-party service tools were developed to demonstrate how service-oriented tools for both TMCs and AOCs could be utilized to aid in amending TMIs by evaluating the demand/capacity balance using the FCA and developing localized TOS for airborne flights to reroute around weather.

Initial TMI Forecast-permeable weather
~48/hr capacity



Revised AFP Forecast-2 hours later, limited permeability
~reduce traffic 50% further

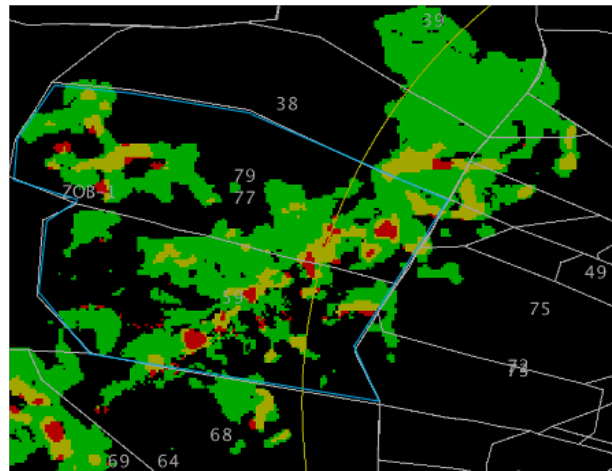

Fig. 5: ZOB FCA and convective weather: initial TMI forecast (left) and revised TMI forecast (right)

In current day operations, when an amendment to a TMI is needed, further ground delay and reroutes are added to all pre-departures and if any airborne flights need to be moved, it is usually done on a large scale through playbook routing (e.g., all flights from Denver Center reroute North up through Boston Center). The process usually has a broad impact on the NAS and there is no flexibility or input from the airlines on which flights they would like to move and what routes they prefer. In contrast, the new airborne reroute concept with third-party services / tools presented here enables more precise and flexible route options from the airlines and allows TMCs to assess the corresponding airspace impact.

The following sections outline the use case procedures from the ATCSCC perspective in regard to initiating a TMI amendment and utilizing the newly developed third-party ANSP Demand/Capacity Evaluation tool to give more precise timing and guidance to the airlines as to how many and which aircraft to move and when. Once these candidate flights have been selected and sent to the airlines, the use case procedures for AOCs describe how the AOC air traffic coordinators (and/or dispatcher) utilize a third-party TOS generation tool to develop and rank order both pre-departure and airborne TOS to be submitted back to the ATCSCC. Once the TOS are returned to the ATCSCC, the use case procedures describe another third-party tool for the TMC that receives, reviews, and evaluates an FCA impact assessment of the returned TOS. The following is a step-by-step description of the use case procedures:

1. *ATCSCC Use Case Procedures*

A prior CTOP TMI program is established for the ZOB FCA with initial capacity of 12 aircraft/15 min or 48/hour.

- ATCSCC receives a new 2-hour weather forecast where they decide they need to further lower the rate.
- ATCSCC looks at traffic demand with the current day suite of TFMS tools and/or utilizes the flight lists and bar charts in the ANSP Demand/Capacity Evaluator third-party tool to analyze the traffic and, along with ZOB TMCs, decides a 50% further reduction of traffic demand through the ZOB FCA is in order.
- ATCSCC builds and sends an initial ABRR/PDRR advisory to all users indicating reduction in FCA capacity for both ABRR and PDRR candidates.
- ATCSCC lowers the capacity rate in the ANSP Demand/Capacity Evaluator tool via automated ingestion of the advisory or manual capacity settings, as described below:
 - a. There is an interactive demand/capacity area in the Demand/Capacity Evaluator tool to allow manual or automatic setting of new capacities at specified times.
 - b. There is a “MODEL” button to run an algorithm (described below) to allocate capacity based on Initial Arrival Time (IAT) to the FCA or Ration by Schedule (RBS) and determine which airlines need to move aircraft out of each 15-minute time window and how many aircraft.

- i. IAT: The algorithm predicts how many aircraft are estimated for each time window, determines the number of aircraft over capacity and determines which airline operators need to move their aircraft and how many need to be moved per airline.
 - ii. RBS: A function ensures the airlines only have to move a percentage of their flights, based on their proportion of traffic over the entire period.
 - c. Model results are displayed for each airline, including:
 - i. How many aircraft need to be moved for which time window(s)
 - ii. Flight state of each aircraft to be moved
- ATCSCC sends a second advisory that is crafted automatically from the ANSP Demand/Capacity Evaluator tool and sent individually to each airline AOC with information about how many aircraft need to be moved and in what time windows.

2. AOC Use Case Procedure

- AOC receives the initial advisory that they will have to move some aircraft in a particular time frame to aid in further reducing aircraft demand through a specified FCA.
- AOC receives the second advisory with a corresponding aircraft list generated from the ANSP Demand/Capacity Evaluator tool.
- AOC opens up the list and selects which aircraft to generate TOS for from the aircraft flight list.
- AOC TOS Generator tool generates TOS for each flight (airborne or pre-departure)
 - a. The TOS will be ranked in order of Total Cost parameters (flight delay cost, fuel cost, crew cost, airspace cost) that have been prototyped for the study.
 - b. AOC can view the TOS routes on a Traffic Situation Display (TSD).
 - c. AOC can actively amend a route by redrawing it on the TSD or by typing in a new flight plan as desired.
 - d. AOC can view any changes in the TOS calculations and get updated cost information using a “REFRESH” button.
- AOC sends their preferred flights to move and their TOS options in rank order back to ATCSCC.

3. ATCSCC Final Use Case Procedures After AOCs Return TOS

- ATCSCC receives the returned list of TOS for each airline.
- ATCSCC TMC uses a TOS Selection Preview Evaluation tool to ingest, view and model the returned TOS.
 - a. The tool indicates the time windows with “new” demand that reflect aircraft that are rerouted out of the original constraint by using the alternate routes in the TOS. The “new” demand based on the reroutes reflects the compliance to the new capacity rate.
 - b. The tool can also show the new demand projected over any set of FEAs around any downstream constraints to see if the rerouted flights will adversely impact other airspaces. The tool allows TMCs to see if the routes would drive the demand in those FEAs over their maximum capacity.
 - c. ATCSCC sends all new pre-departure routes to the towers and coordinates all new airborne reroutes with ARTCC TMUs. ARTCC TMUs then send the new routes to the controllers who then issue the clearances to the aircraft.
 - d. ATCSCC simultaneously sends back the accepted flight plans to the AOCs.

C. ANSP and AOC Tool Functionalities for Airborne Reroute Operations

The previous section described the overall procedures and the tool functionalities that would support those procedures. This section will describe the details of the tool functionalities and how they look in our prototype tools.⁸ The tools have been developed to mirror some of the current day ANSP and AOC functionalities as well as the new ANSP and AOC services / tools that are envisioned to be provided by third-party vendors to aid the airborne reroute operations described in the above use case. The various tool functionalities are described below, in the sequence they appear in the use case procedure description.

1. TMI Advisory Panels for ANSP and AOC

The TMI Advisory Tool suite is comprised of the ATCSCC Advisory panel and AOC Advisory Alert window that mimic the advisory functionality that exists in today's TFMS. Fig. 6 illustrates our research prototype of the advisory tool functionality. ATCSCC can initiate a TMI to help mitigate the impact of traffic flow on an FCA. In our use case, a convective weather cell constrains an airspace such that traffic flow has to be reduced. In response, the

TMC proposes and sends a TMI using the ATCSCC Advisory panel in Fig. 6. The panel includes the following information:

- Control program name
- Range of program time
- Which FCAs are included
- Flights that will be exempt (if any)
- Percentage of flights being reduced
- The area where the traffic constraint is happening
- The reason behind the constraint
- Status of included flights (e.g., airborne, pre-departure, etc.)
- Other remarks
- Route guidance for reroutes

Once the necessary details of the proposed program have been set, the advisory is sent to all ARTCC, TRACON, and tower facilities that would be affected as well as the airlines whose flights will be affected by the program.

The screenshot shows a window titled "ATCSCC Advisory" with the following fields and values:

ATCSCC ADVZY 001 CTOP001 PROPOSED ABRR CTOP	
CTL PROGRAM:	3RD-PARTY
PROGRAM TIME:	211500Z - 231500Z
FCAS INCLUDED:	ZOB-FCA
FLT EXEMPT: ARRIVAL:	None
DEPARTURES:	None
AVERAGE PERCENT REDUCTION:	50 PERCENT
CONSTRAINED AREA:	Western boundary of ZOB
REASON:	Convective Weather Cell
INC (FLT STATUS):	All
REMARKS:	A 50% reduction of flights through ZOB-FCA for 2 hours from now. Your flight reductions are needed by 201500Z.
RTE GUIDANCE:	Preferred routes north via HNK or South via BKW
Buttons:	Send ATCSCC Advisory to AOCs Clear

Fig. 6: ATCSCC Advisory panel

AOCs receive the advisory that the TMI will be amended. The initial advisory will appear on the AOC advisory alert panel. Fig. 7 illustrates our research prototype of AOC alerts that are available to AOCs in today's operations. In Fig. 7, the alerts are represented by different categories, one of which is the alerts for ATC advisories. The color yellow represents that a new advisory has been received.

The screenshot shows a window with a navigation bar and a main content area:

- Navigation bar: ATC Advisories (yellow), Flight list (blue), TOS status (blue), TOS award amended (blue), Misc (blue)
- Main content area:

```

      ATCSCC ADVZY 001 CTOP001 PROPOSED ABRR CTOP
      CTL PROGRAM: 3RD-PARTY
      PROGRAM TIME: 233000Z - 013000Z
      FCAS INCLUDED: ZOB-FCA
      FLT EXEMPT: ARRIVAL: None
      DEPARTURES: None
      AVERAGE PERCENT REDUCTION: 50 PERCENT
      CONSTRAINED AREA: Western boundary of ZOB
      REASON: Convective Weather Cell
      INC (FLT STATUS): All
      REMARKS: A 50% reduction of flights through ZOB-FCA for 2 hours from now. Your flight reductions are needed by 223000Z.
      RTE GUIDANCE: Preferred routes north via HNK and South via BKW
      
```

Fig. 7: AOC Advisory Alert window

2. ANSP Demand / Capacity Evaluator Tool

The TMI advisory in Fig. 6 is ingested by a new DST, envisioned as a third-party service /tool, that was developed for our concept and use case. This functionality is a new capability to aid the TMCs in generating individual airline-specific advisories that dictate how many aircraft from each airline's fleet need to be rerouted while giving the flexibility to the airlines to pick which flights to reroute.

When the TMI advisory is generated by the ATCSCC TMC, this ANSP Demand / Capacity evaluation tool detects the advisory, sets the new capacity values, and calculates how many aircraft exceed the established rate during each 15 minute time window and which airlines' aircraft are affected. Once the tool generates a list for each airline with how many aircraft need to be moved in each 15 minute time window in order to meet the newly established FCA capacity, TMCs can send the airline-specific list to the affected AOCs to each airline.

Fig. 8 illustrates the ANSP tool interface when it receives the initial TMI advisory. The tool assesses the traffic demand that exceeds the established capacity limits. If a capacity has already been set for a given FCA, it will be shown with a blue line, as is seen in Fig. 8. Alternatively, a capacity value can be entered manually to select the FCA that you want to set the capacity.



Fig. 8: ANSP tool receives latest advisory

In order to calculate the number of aircraft that need to be rerouted per airline per 15 min time window, the "Model" button (upper right corner in Fig. 8) initiates a Demand Proportion based algorithm that distributes the reroute assignment across the airlines. The algorithm chooses how many aircraft each airline must move out of each time window based on their proportion of demand over the full advisory range, as shown in Model results in the top portion of Fig. 9. This ensures an equitable RBS for the ABRR and PDRR list of aircraft that will need to be routed out of the FCA. Once the TMC is satisfied with the capacity and modeled information, s/he presses the "Send All" button and receives a pop-up message detailing how many airlines were sent move requests and how many move requests to expect back as shown in bottom figure in Fig. 9. At the same time, the AOCs receive an advisory with a list of how many of their aircraft they will need to move and in what time bin.

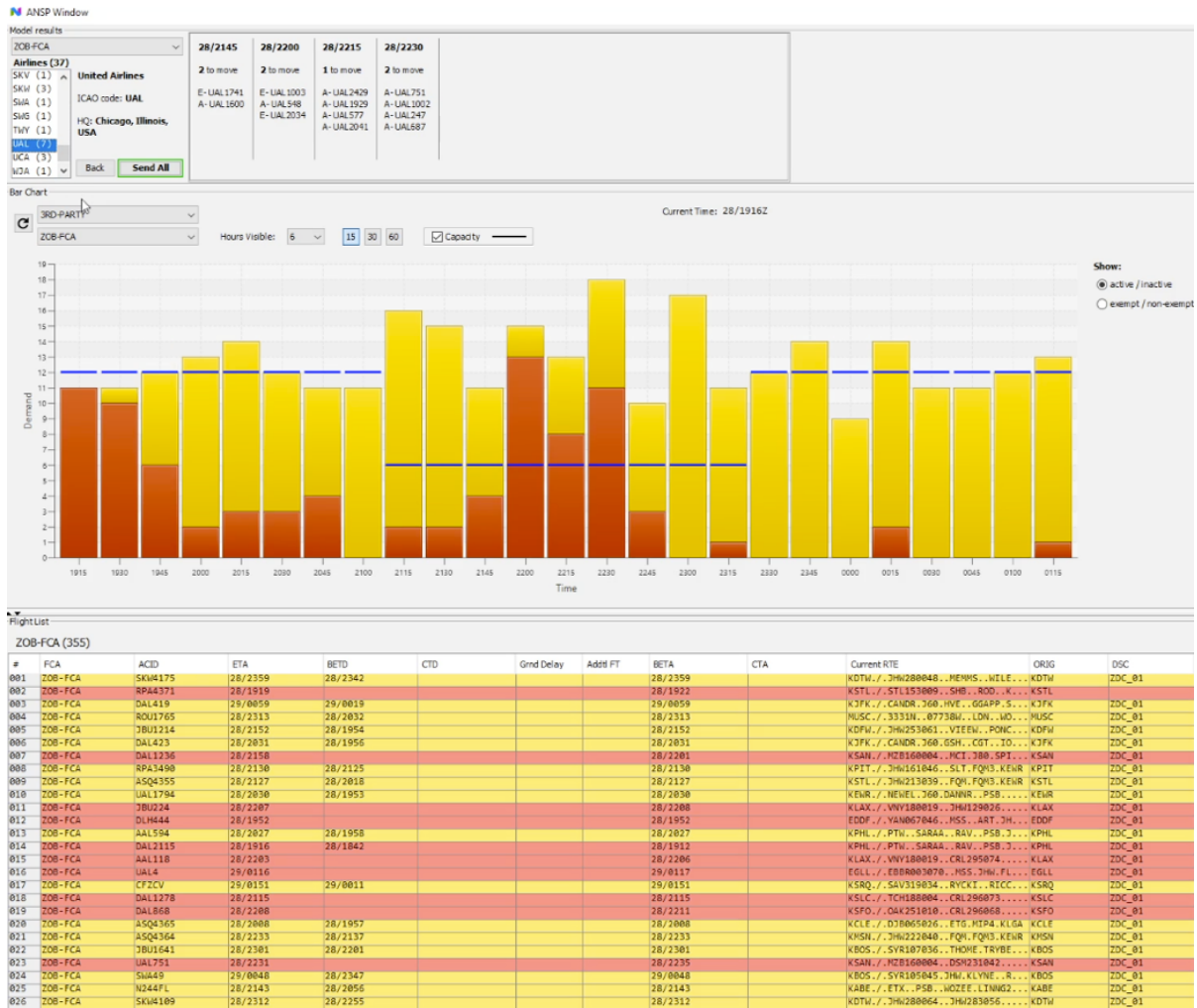

Results for 37 airlines sent successfully with a total of 49 move requests

OK

Fig. 9: Model results for generating and sending airline-specific advisories

3. AOC Advisory Alert Panel

AOCs receive a secondary advisory with the information that a certain number of its flights will be impacted. The advisory also indicates the blocks of time these flights would be entering the FCA. Fig. 10 illustrates an advisory for United Airlines where four of its flights are required to be rerouted out of the FCA. The advisory designates moving one flight for each block of time suggested. If there are multiple flights in a particular block of time (as there are in Fig. 10 example, move 1 out of 2 flight options in each time bin), then the airline has the choice to select which flight they prefer to be moved. If there is only one, then that flight must be rerouted. This process gives AOCs the flexibility to choose which flight(s) they want to move and give their preferential routes by submitting TOS back to ATCCSCC.

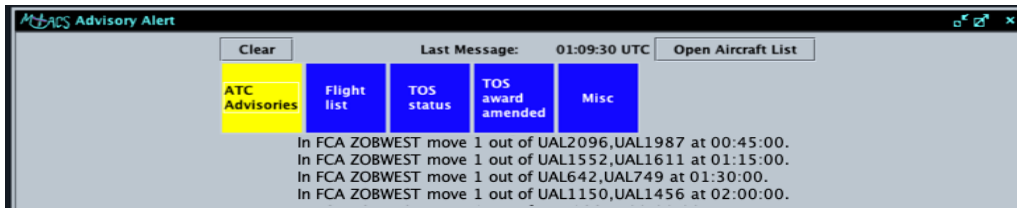

Fig. 10: AOC Advisory Alert window

4. AOC TOS Generation Tool

AOCs receive an advisory detailing the time windows and accompanying flight counts which need to be moved (see Fig. 10). Each AOC can then select from the list of available aircraft at each of those time windows and assess which flights to reroute. In current operations, airline dispatchers have access to their flight planning system and other tools to see which flights have a greater or lesser impact to their business case if they are rerouted and/or delayed.

In our research prototype tools, we recreated the AOC aircraft list functionality that similarly exists in the AOC's current operations. In our use case, after receiving the advisory that a TMI has been established by ATCSCC, the same flights listed on the Advisory Alert window appear on the AOC Flight List window (see Fig. 11). The AOC Flight List window displays the flights affected by the TMI and provides additional information regarding the specific flights impacted.

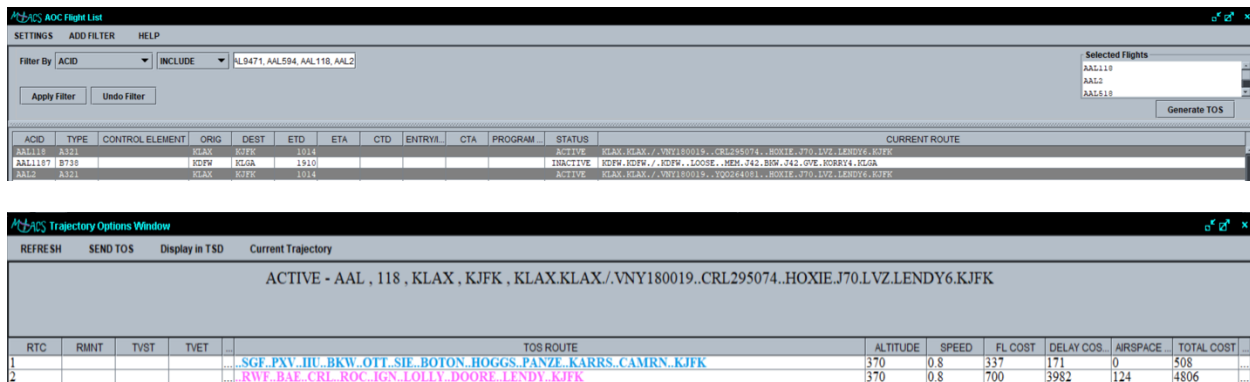

Fig. 11: AOC Flight List (top) and Trajectory Options Window (bottom)

Once a set of flights are selected to be rerouted, TOS routes are generated for each of the selected flights. In order to see available TOS for a particular flight or sets of flights, an aircraft or group of aircraft are selected on the AOC Flight List (see the top figure in Fig. 11). Once flights are chosen, the “Generate TOS” button populates the Trajectory Options Window (see the bottom figure in Fig. 11) with TOS routes available for the selected flight or set of flights. The Trajectory Options Window displays the flight’s current flight plan, status, and TOS routes available. Notice that TOS routes are shown in two different colors. Routes shown in the color cyan are ranked higher compared to the routes in the color magenta. The ranking order is determined by the least total cost in which flight cost, delay cost, and airspace cost are calculated.

Typically, airlines calculate their total costs differently depending on their business operations and these cost factors are proprietary to each airline. Therefore, we have developed a generic cost function to approximate the airline cost factors for the purposes of generating relative trajectory cost rankings for the alternate trajectories in the TOS.⁹ The cost values that we approximate may not mirror the real costs used by the airlines, but they were developed with inputs from various airline dispatchers and modeled the critical cost factors common across most airlines. Even if our prototyped costs differ from the actual ones, we predict that they are sufficient to generate similar trajectory rankings to ones that would be generated using more sophisticated, airline-specific models. More research is needed to validate this hypothesis.

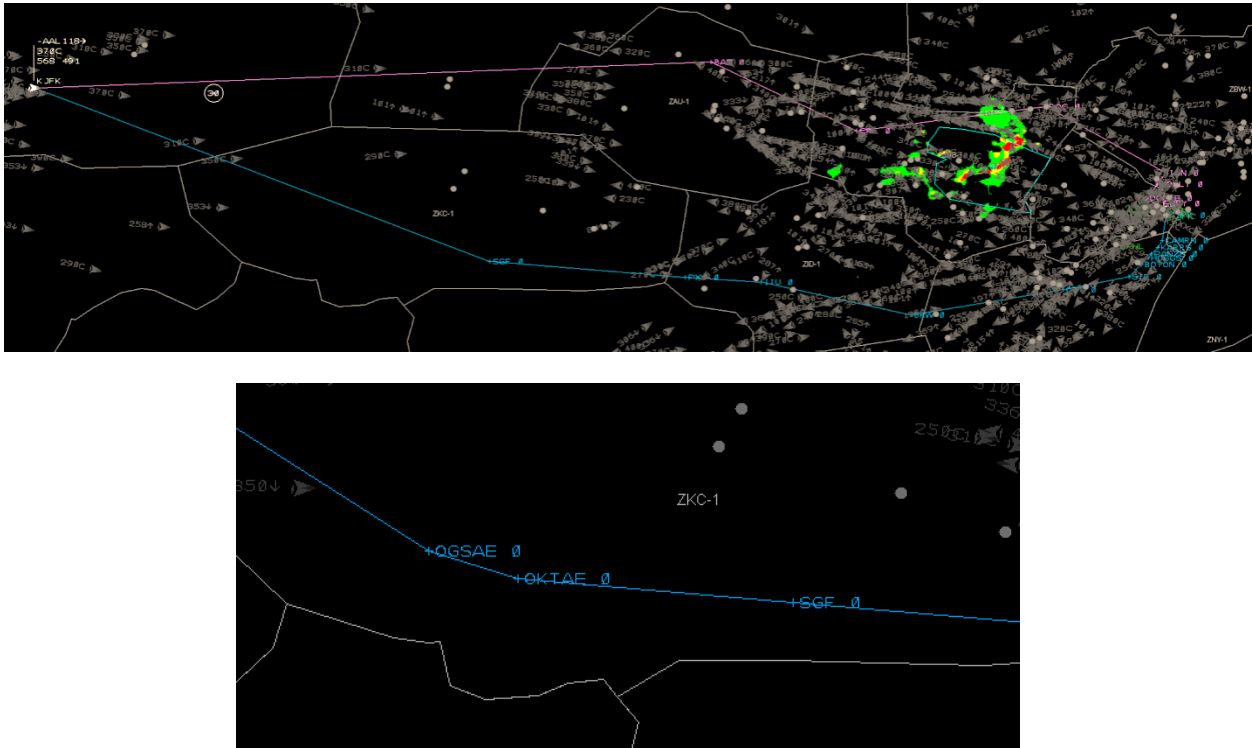

Fig. 12: TOS routes on TSD (top) and a close-up of a modified TOS route on TSD (bottom)

The TOS routes on the Trajectory Options Window can also be viewed graphically on the TSD. Fig. 12 illustrates the TOS routes in magenta and cyan colors to match those in the Trajectory Options Window. Both the cyan and magenta routes are rerouted away from the ZOB FCA where the weather is impacting the airspace. The cyan route is going south away from the weather cells and the magenta route is going north. While the TOS route depicted in magenta may look shorter in distance compared to the TOS route in cyan, the TOS route in magenta has larger additional costs that are not associated with route distance that makes its total cost higher. Should the user need to make modifications to any of the TOS routes, waypoints can be removed or added. The total cost for the modified TOS route can be recalculated on the Trajectory Options Window panel by clicking “REFRESH”, which recalculates the “TOTAL COST” column. Should the cost for the cyan TOS route become higher than the magenta TOS route, the ranking will change and so will the color. In addition to making changes to the routes on the TSD, TOS routes can be modified manually on the Trajectory Options Window. Users can add or remove waypoints by typing on the TOS “ROUTE” column of the Trajectory Options Window.

When TOS selection has been finalized, it can be sent back to ATCSCC. The TOS for each flight can have a single or multiple routes. When the AOC user clicks SEND TOS on the Trajectory Options Window, the TOS routes for the selected flights are then sent back to ATCSCC.

5. ANSP TOS Selection Preview Tool

When the AOCs select flights to be rerouted, generate TOS, and send them back to ATCSCC, a message will appear on the ATCSCC TMC display that AOC TOS has been received. At this juncture, the TMC can assess the TOS routes in the ANSP TOS Selection Preview window, which has been incorporated into the Demand/Capacity Evaluation tool, using the “View” and “Model” buttons. Clicking the “View” button will show the list of aircraft chosen with the available TOS routes listed for each aircraft, with the preferred route listed first (Fig. 13). To change the route to be modeled in the bar charts, the TMC clicks on a different route in the list and the bar chart will update accordingly. Additionally, s/he may change the selected TOS route for all chosen aircraft simultaneously to a specific entry number. This action can be done by selecting the value from the appropriate dropdown menu (the right figure in Fig. 13).

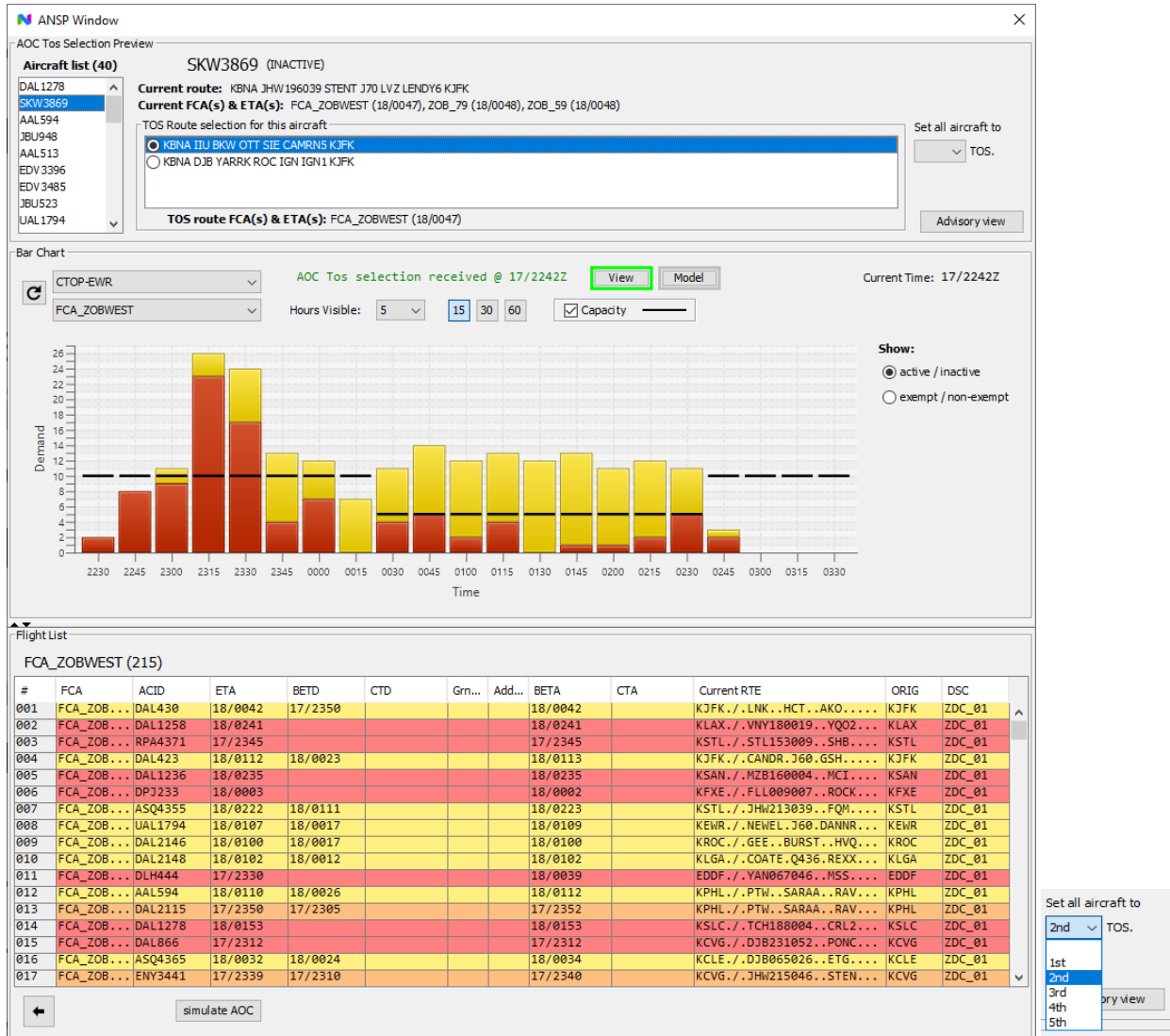

Fig. 13: Viewing / modifying the AOCs response (left) and selecting different TOS routes (right)

Once the TMC reviews the TOS routes, s/he can then model the impact on the FCAs and FEAs. As shown in Figure 14 (Top), once the “Model” button is selected, the bar chart will show black modeled bars that indicate which window the aircraft taking a TOS will be leaving. The new ‘demand’ based on the route outs is then shown in red and yellow to ensure compliance to the newly set capacity. The tool can also show the new demand projected over any set of FEAs to see where the TOS reroutes will be going to. As shown in Fig. 14 (bottom), the bar chart reflects these counts in white, allowing the TMC to see if the routes would drive the demand in those FEAs over their maximum. The ATCSCC TMC, via SWIM, would then send all the new pre-departure routes to the towers and coordinate all the new airborne reroutes with the ARTCC TMUs where these airborne flights are currently located. Then the TMUs can send the new routings to the controllers who have track control using ABRR technology and the controllers would issue the clearances to the flights.

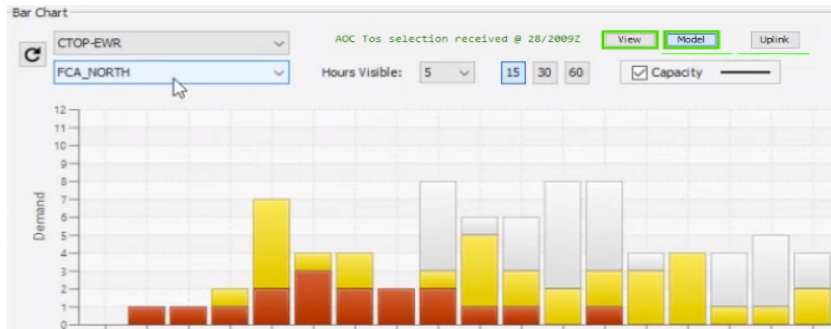
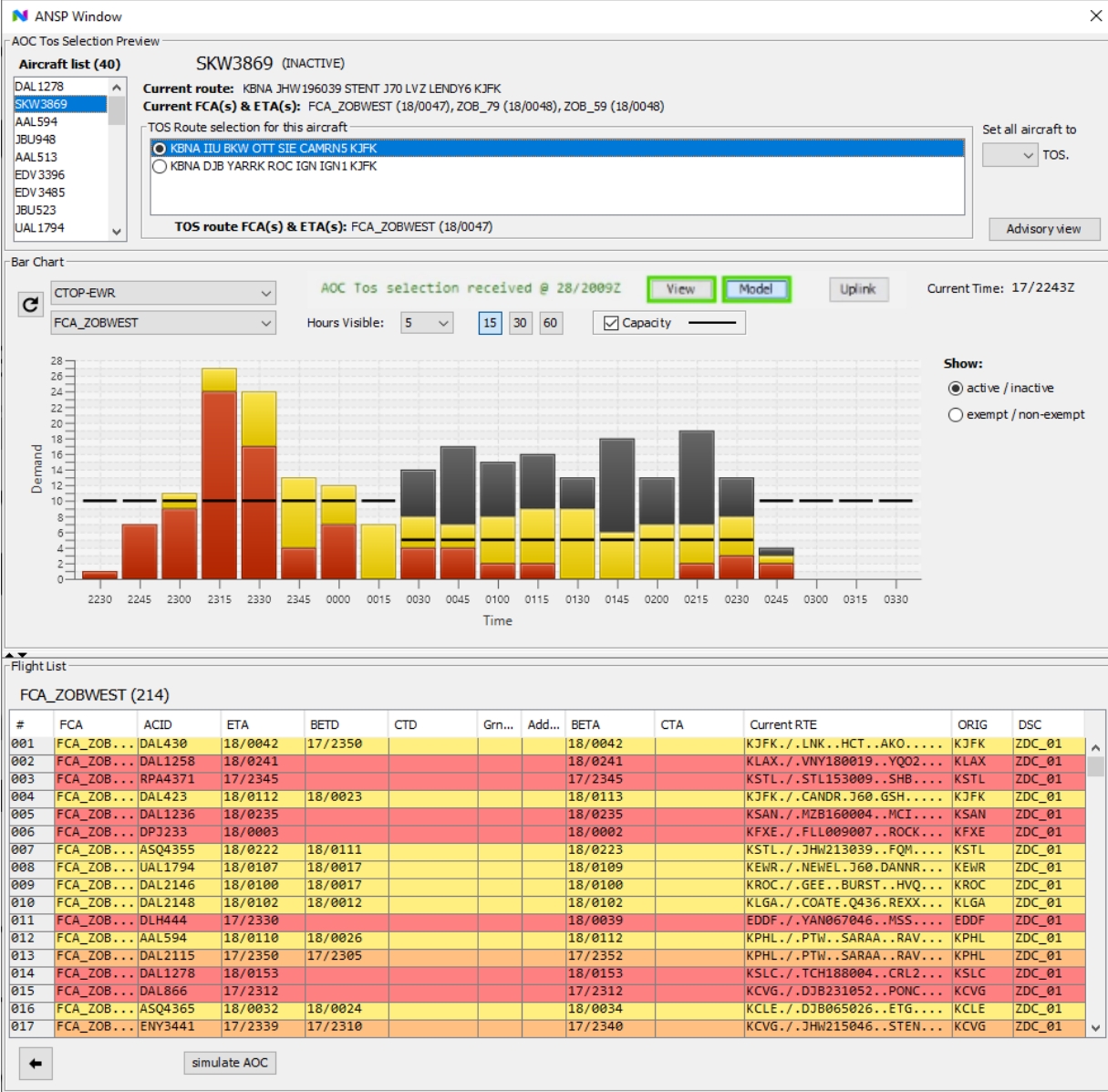

Fig 14: Modeling impact of TOS selection on FCA (top) and impact on FEAs (bottom)

V. Virtual Knowledge Elicitation Study

A. Study Design

In order to demonstrate the concept and third-party services / tools, human-in-the-loop (HITL) simulation software was used to simulate high density traffic scenarios in the Northeast Corridor. This simulation demonstrated how the concept and third-party services / tools could be used to generate airline-preferred trajectory options evaluated by TMCs. Our original intent was to run a mid- to high-fidelity HITL simulation study, consisting of ATCSCC and ARTCC TMCs, multiple AOCs, controllers, and pilots. However, due to COVID-19 and the associated shutdown to our laboratory and the simulation environment, we were not able to conduct the actual HITL simulation with the airline and air traffic participants, as originally intended. Instead, we simulated the concept and tools on our simulation platform and recorded the interactions with the tools. Then we demonstrated the concept and tools to our participants with a combination of live and recorded demonstrations of operational procedures and tool interactions via a virtual teleconferencing. During the demonstration, we elicited the participants' feedback on the benefits and feasibility of our concept, tools, and procedures.

The virtual study consisted of four TMC participants and three AOC participants. Each participant provided their feedback individually. Therefore, each study run consisted of one participant, lasting about six hours each. Each study session consists of an overview briefing and tool demonstration in the morning, followed by step-by-step tool-specific training and use case-specific procedure descriptions in the afternoon, intermixed with Q&A sessions with the participants.

Each day ended with a final debrief discussion. The Q&A sessions throughout the day and the final debrief discussion session were both captured using Microsoft Teams. The feedback was transcribed and analyzed and included in the results section of this paper.

B. Participants

The virtual study had seven participants: one ATCSCC specialist, three en-route TMC participants, and three AOC participants. The ATCSCC and en route TMC participants played the role of the TMC in our study. They were all retired controllers and their age ranged between 51 – 60 for three of the participants and over 60 for one participant. Three participants had experiences in an en route facilities only and one participant had experiences in the tower, TRACON, and ATCSCC. Their ATC / area supervisor experiences combined ranged between 19 – 33 years and their TMC / Supervisory TMC experiences combined ranged from 4 – 23 years. The three en route TMC participants were retired TMCs from ZDV (Denver), ZNY, and ZOA (Oakland) ARTCCs.

The AOC representatives were air traffic coordinator specialists representing United Airlines (UAL), American Airlines (AAL), and Southwest Airlines (SWA). Two of the AOC representatives were retired, and one was active. Their ages ranged between 31 – 40 years old for one participant and over 60 years old for two participants. Their experiences in various AOC roles were as follows: 15 – 35 years as dispatchers; 3 – 20 years as ATC coordinators; 2 – 22 years as dispatch instructors; and 0 – 5 years as lead dispatcher.

C. Airspace and Traffic scenario

High density traffic scenarios were generated for the Northeast Corridor. The convective weather cells were placed on the border of ZOB and ZNY and required a portion of the airborne aircraft in the region to be rerouted around the weather. An FCA was developed and placed in response to the weather.

1. FCA Development

The scenario selected for the experiment utilized a historical example of a weather scenario that started in central ZOB airspace and moved into western ZNY airspace. The type and placement of the FCAs in relation to the weather pattern was determined. Although FCAs in operational use were depicted as lines that capture traffic only in one direction, we used a polygon FCA that could capture all traffic through the impacted area as a better method for capturing the traffic demand. A weather pattern was constructed to impact the western edge of ZOB Sectors 57, 59, 77, and 79 at the beginning of the scenario, with the convective weather cell moving to the eastern edge of the same sectors at the end of the scenario. A corresponding FCA was built to encompass these four sectors in ZOB. Although it was possible to exclude some traffic from the FCA, it was ultimately decided to not exempt any traffic from the FCA leaving all flights subject to delay, reroutes, or both in the study.

2. Traffic Scenario Selection and Refinement

The initial seed traffic came from a combination of ZOB, ZNY, ZDC, and ZBW CTAS CM Sim track data¹⁰. The day selected was Wednesday October 9, 2019, using the time period 3-8 PM GMT. In order to determine that this data set was valid, the team compared the traffic load through ZOB Areas 5 (Sectors 57 and 59) and 7 (Sectors 77 and 79) during the chosen time period against the average of all other weekdays from October 1, 2018 through December 31, 2019 during the same time period. The analysis compared traffic counts going into area 5, into area 7, out of area 5, and out of area 7. Comparing each hour individually, most counts (into and out of each area) were within one standard deviation of the mean, and all counts were within two standard deviations of the mean. All counts were within one standard deviation of the mean for the five-hour period as a whole.

This traffic set was then down selected to pick the most meaningful data for the scenario and to ease computational load. This down-selection of flights resulted in a traffic scenario of 2,286 aircraft. All flights with cruise altitudes below FL240 were removed because the specific sectors of interest (ZOB 57, 59, 77, and 79) only handle flights at FL240 and above. The following sets of flights were removed because their trajectories would not come into contact with the trajectories of the flights going through the sectors of interest or their potential rerouted trajectories:

- European flights departing from or arriving at airports in ZNY, ZDC, or ZBW
- ZNY departures going through ZDC or ZBW and ZDC departures going North or South
- Flights with Canadian departure and arrival airports
- Flights originating from or arriving at airports in ZOB that are West of ZOB areas 5 and 7 were removed if they were going to or coming from West of ZOB (ex: DTW -> DEN)

The simulated traffic was then replayed on a TSD to identify flights that needed their flight plan adjusted to reflect normal traffic patterns. In the traffic file, many of the aircraft were on direct routes which briefly transited the FCA via ZOB sectors 77 and 79. These flights were put back on their filed routes which avoided the FCA. To further refine the scenario, the traffic was pre-conditioned using a strategic TMI to reduce traffic demand to 48 flights per hour through the ZOB FCA. From there, an additional 200 flights were trimmed from the scenario because their departure time pushed them past the time period of interest for the scenario, resulting in a final scenario of 2,086 flights. Fig. 15 shows the general traffic flows of the final scenario used to develop TOS routes. These flows were: N90 arrivals from the west and southwest; N90 departures to the west; ZBW arrival and departure traffic via Q29; PHL arrival traffic from the west and northwest; and ZYZ, ROC, BUF arrival and departure traffic to the south.

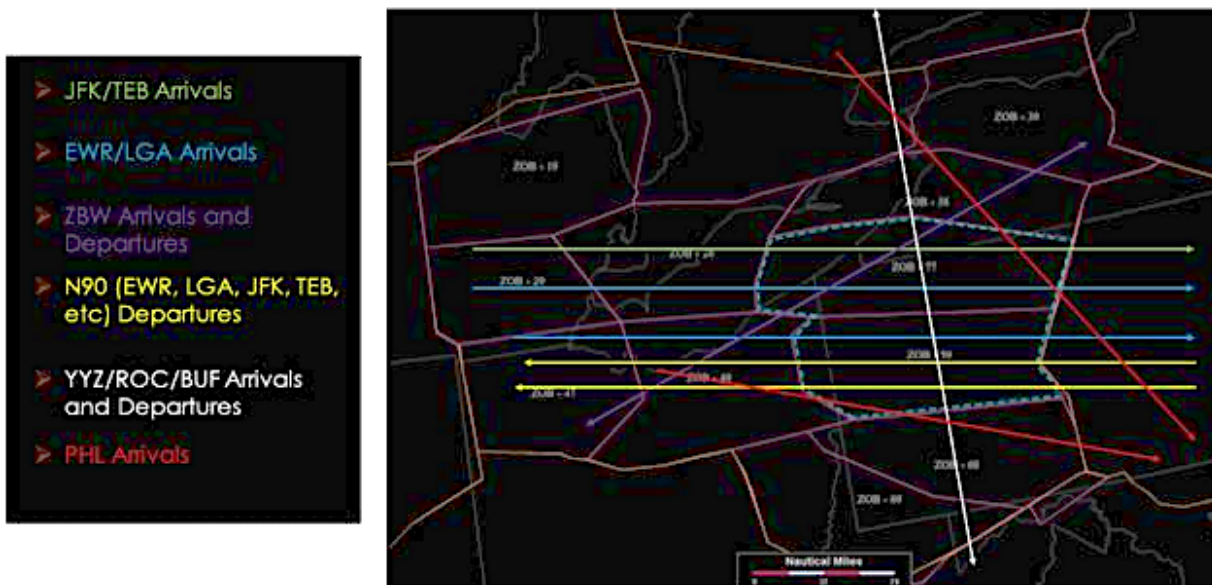

Fig. 15: Traffic Flow Patterns

D. TOS Development

TOS routes for each major flow were developed individually. For city pairs with a Coded Departure Route (CDR) in the FAA database which went north and/or south of the FCA, those routes were incorporated as TOS routes. When a city pair did not have a CDR listed, the following set of routes were used to develop an appropriate TOS route:

- FAA National Playbook routes were searched for possible routes.
- Nearby large airports were searched for a possible CDR and the route was adjusted for the new departure, or arrival airport.
- Free form TOS routes were developed from other route segments found in the CDR or Playbook database.

Flights that were not a part of the larger flows were identified as not having a TOS developed. This list was reviewed on an individual basis to determine if an appropriate TOS could be developed. Some flights received no TOS, others only a single alternative route in their TOS. This process resulted in 328 flights having at least one TOS route and 247 flights having two TOS routes for pre-departure. Fig. 16 shows the original trajectories for all flights having at least one TOS route, Fig. 17 shows the trajectories for the first TOS route, and Fig. 18 shows the trajectories for the second TOS route, if there is one.



Fig. 16: Original trajectories for flights with 1+ TOS routes



Fig. 17: Trajectories for TOS route 1

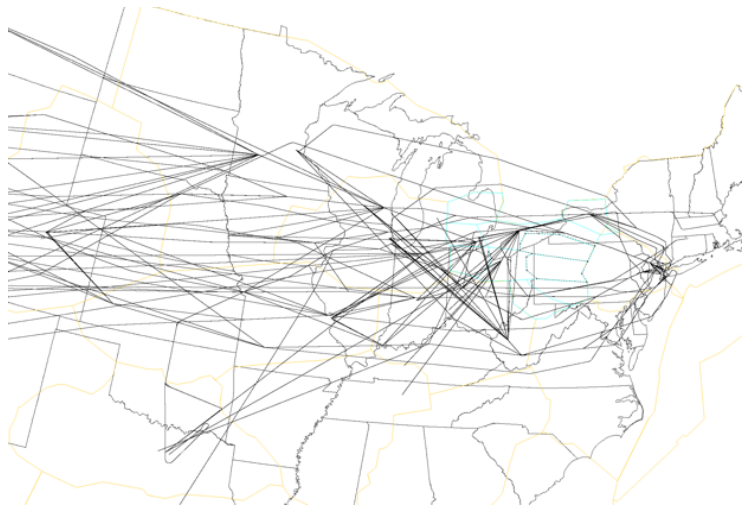

Fig. 18: Trajectories for TOS route 2

E. Apparatus

1. MACS

The Multi Aircraft Control System (MACS) is a software environment utilized as a research platform that supports air traffic controller and pilot in-the-loop simulations to assess various aspects of mid-high fidelity air traffic operations within the NAS. MACS enables reproduction of high-fidelity displays specific to ATCs and TMCs. Each unique MACS station is connected to one another by communicating and performing data exchange in a distributive network. The Aeronautical Datalink and Radar Simulator (ADRS) serves as the networking infrastructure for MACS functioning as a communication hub between each MACS station.¹¹ MACS was used to develop a ATCSCC TMC workstation, as shown in Fig. 19. The workstation consisted of displays for a TSD, Load Table, Multi-Load Graph, ATCSCC Advisory, and the third-Party ANSP Demand/Capacity Evaluation Tool.

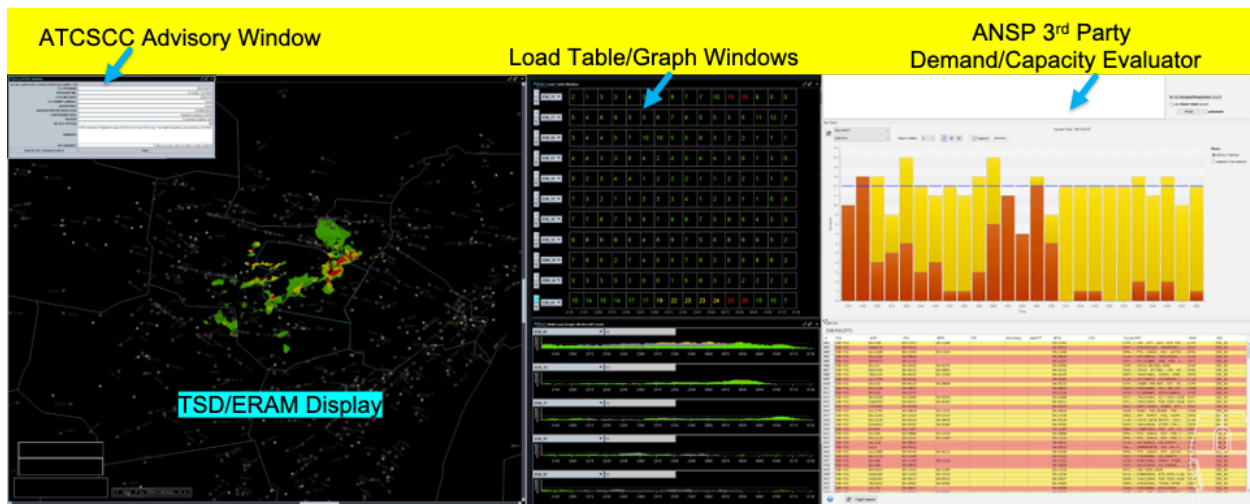

Fig. 19: MACS ATCSCC TMC station

Fig. 20 shows a MACS airline dispatcher workstation for the AOC participants. The AOC MACS station has a TSD, an AOC Advisory Alert panel, an AOC Flight List, and a third-party AOC TOS Generation Tool: Trajectory Options Window. Digital coordination (i.e., SWIM) is expected between the ATCSCC TMC and AOC dispatchers in our use case.



Fig. 20: MACS AOC station

2. *Microsoft Teams*

Microsoft Teams is a business communications platform that promotes chat, meet, call, and collaborate functionalities for a virtual working environment. Teams provides the necessary remote access to the lab to share the simulation environment with the entire team during on-site testing and simulation runs. During the virtual study, Teams was used to conduct the knowledge elicitation sessions with the participants. The traffic scenarios and the tool interactions were simulated in the MACS simulation platform and the interactions were recorded ahead of time. During the study, these recordings were presented as a part of the step-by-step procedures of the use case, along with targeted questions to elicit the participants' feedback.

F. **Data Collection**

At the end of the study, each participant was given a short post-study questionnaire, consisting of subjective ratings on various topics ranging from concept feasibility to feedback on the tool user interface. Their responses were collected and analyzed for the study findings in this paper. In addition, the discussions throughout the study were captured using the recording function in Teams. They were subsequently transcribed and analyzed to augment the findings from the post-sim questionnaires.

VI. Results

The TMC and AOC participants were asked questions about the respective third-party tools that were introduced in the study to aid the new procedures for handling weather-related airborne reroutes. The questions that were posed to the TMC and AOC participants were similar, but they were modified slightly to account for the differences in the procedures and the tool functionalities.

The questions generally followed a format that asked the participants to rate the concept, procedures, or the tools on a 1 to 5 scale, followed by a section where they can elaborate on their ratings. In general, both TMC and AOC participants showed good agreement in their ratings, where the minimum and maximum ratings for each question stayed between a 0-2 range with one exception. Given the good agreement across participants, only the average ratings score will be presented, and the one exception will be pointed out explicitly. The TMC and AOC feedback results are presented in the following sections.

A. TMC Feedback

1. Acceptability of the Concept and Procedures

Fig. 21 shows the ratings when the TMCs were asked about the acceptability of the dynamic airborne weather reroute concept and procedures. They rated that the operational procedures for handling dynamic reroutes using TOS, ABRR, and the new TMC tools were highly acceptable ($M=4.5$), as well as the idea of letting the TMC dictate the capacity limits and the number of aircraft to be rerouted but allow the airlines to choose the aircraft to be rerouted ($M=4.5$). They also unanimously agreed that determining the number of aircraft that each airline needs to move by using Demand Proportion method was highly acceptable ($M=5$). Demand Proportion method takes the proportion of the total aircraft within the advisory period that each airline owns and uses that proportion to determine the number of rerouted aircraft per airline. All participants felt that it was the most equitable method for distributing the reroute burden to the airlines.

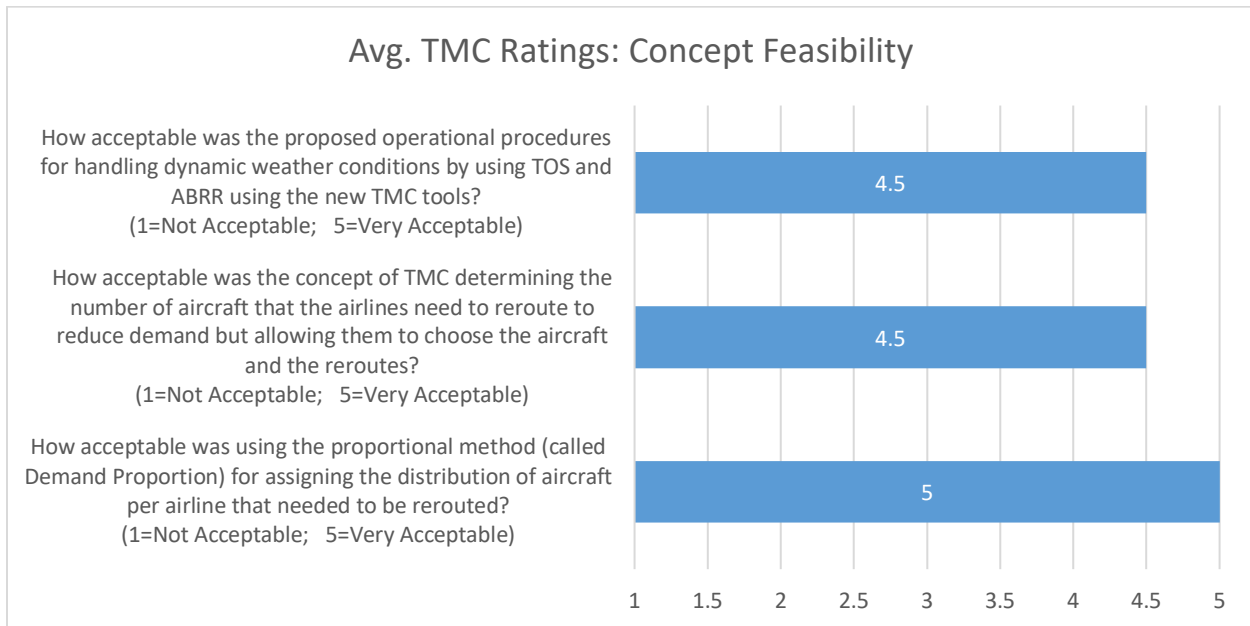

Fig. 21: Feasibility / Acceptability of the Concept and Procedures

The participants commented that the procedures in the concept were easy to follow, and the tools were great. They thought that the procedures / tools were great for handling local weather events and give the airlines flexibility in routings. One participant warned that the airlines may need to be incentivized to participate and that there needs to be a mechanism for increasing the traffic demand if the weather does not materialize. He also commented that there was too much traffic flowing through the FCA and that the traffic may need to be filtered based on flow. In general, they liked the idea of letting airlines select the rerouted aircraft, but one participant still felt that the procedure was more labor intensive and time consuming than in current operations, in which the TMC controls the demand directly by rerouting airborne or holding departure aircraft. He suggested an alternative method to requesting the airlines to generate reroute options would be for TMCs to generate the reroutes but to allow the airlines an option to swap the selected aircraft with another one from their fleet. He felt that this method would result in a quicker turnaround time while still allowing some inputs on the route options from the airlines.

2. Feedback on the New TMC Tool Functions

The TMC participants were asked to provide feedback on the implementation specifics on the TMC tool functionalities. In particular, they were asked about the tool functionality shown in Fig. 9, which showed how the new third-party TMC tool calculates the number of aircraft to be rerouted per airline using a Demand Proportion method and displays them to the TMC who can review and send them out to the appropriate AOCs. Fig. 22 shows the participant ratings related to this tool functionality.

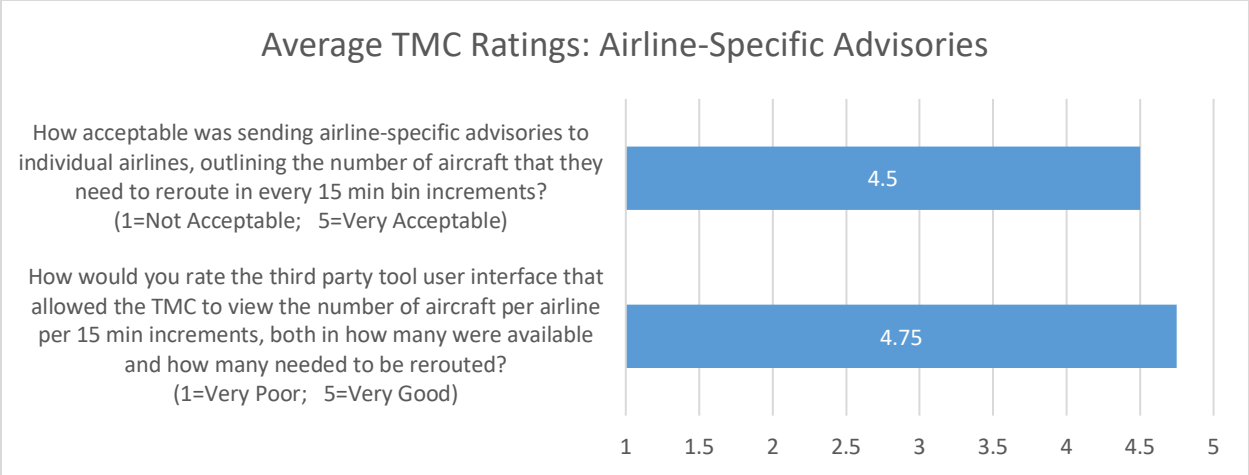

Fig. 22: Feedback on Airline-Specific Advisory Functionality in the TMC Tool

In general, participants rated that the concept of calculating and issuing airline-specific advisories to individual airlines were highly acceptable (M=4.5) and the tool user interface that showed the number of available and rerouted aircraft at 15 min increments was very good (M=4.75). They commented that the advisories worked well, and the interface was straight forward. One participant liked the 15-min increments but thought that perhaps there was too much information. Another participant commented that additional functions might be needed if the airlines do not move the necessary number of flights and the TMC has to take further actions to manage the demand.

The TMC participants were also asked for their feedback on the TOS evaluation portion of the tool functionality that was invoked after AOCs generated and returned their reroute TOS and the TOS priorities. Fig. 23 shows their ratings. For the TOS evaluation phase, the TMC participants thought that there was adequate information on the TMC tool to evaluate the TOS for the rerouted aircraft and the resulting changes to the demand profile, as well as knowing when and how to choose airline’s second TOS options if the first TOS option did not provide the desired results for the TMC (M=2.75; 3=Adequate Info). One participant said that he would look to implement the second TOS option if one of the downstream constraints become saturated due to the reroutes. They agreed that the number of TOS reroutes per aircraft should be limited, between one to two. They also suggested the ability to toggle between the TOS options on the TSD.

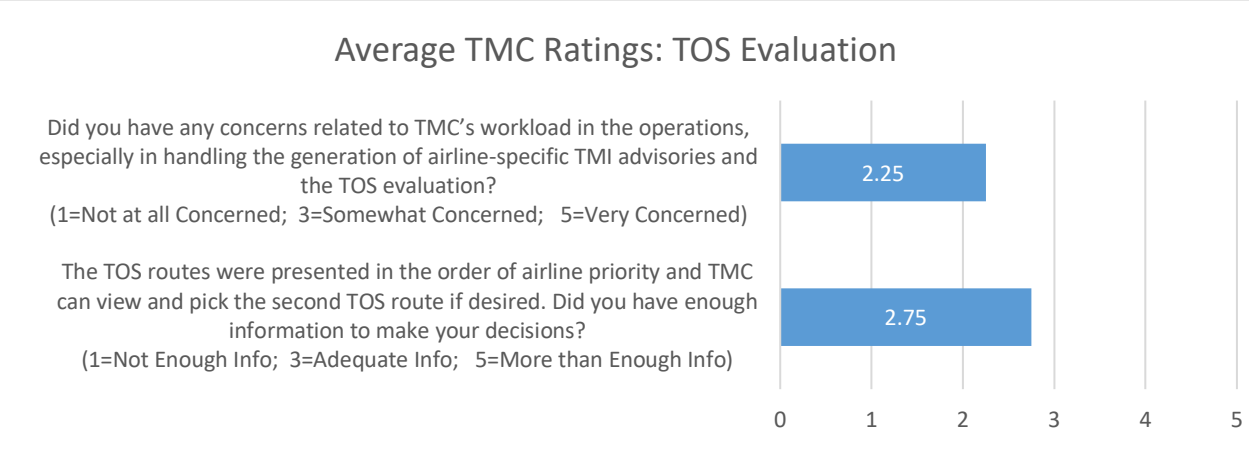

Fig. 23: Feedback on TOS Evaluation Functionality in the TMC Tool

When they were asked if they had any concerns related to TMC workload, they were somewhat concerned (M=2.25; 3=Somewhat Concerned). They did not think that it would be possible for the TMC to check every TOS route so they would need the tool to check the TOS. One participant was also concerned that the implementation of TOS routes might require individual coordination with the ATC facilities, which would also be labor intensive if that were the case. In general, they thought that the procedure in the study to check the overall demand / capacity balance after the TOS reroutes was acceptable in terms of TMC workload.

Finally, they were asked about other tool functionalities that they would like to see in the new TMC tool. Few participants requested for a better interplay between the target FCA and other downstream FEAs to better recognize the reroute impact on other sectors in the NAS. They would like to see this impact before implementing them as ABRR route amendments. On a related topic, one participant would like a TOS evaluation function that would check if the TOS route itself is a valid route, in addition to the provided functionality to check the TOS impact on the demand / capacity.

3. Feasibility of the New TMC Tool Functions as a Third-Party Tool

The participants were asked whether the tool would work better as a third-party vs. integrated tool functions. Unfortunately, they rated that the function would work better as integration functions in the TFMS tool suite (M=4.5; 1=Better as a Third-Party Tool; 5=Better Integrated into TFMS). They commented that the TOS options should automatically populate RAD in TFMS so that they can then be sent to the controllers using ABRR. They also mentioned that TMCs use TFMS at 90%-95% of the time to perform their central functions, so the information is best located as a part of that tool. One participant did recognize the benefits of a third-party tool in that the functions would likely be implemented and available much quicker than if they had to be included in the future TFMS development cycle.

4. Feasibility of the New Airborne Reroute Procedures without the Additional TMC Tools

The participants were asked a couple of questions about whether the dynamic airborne reroutes using TOS and ABRR, as presented in this study, would be possible without the aid of the new tool functionalities developed for the study. Their responses were somewhat mixed, as shown in Fig. 24.

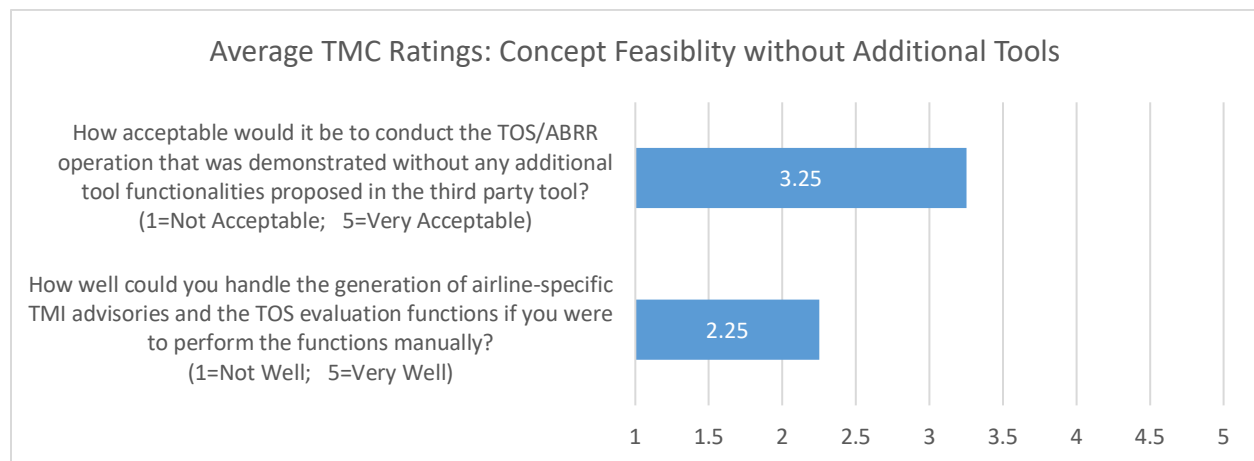

Fig. 24: Feasibility / Acceptability of the Concept and Procedures without the Additional TMC Tools

When they were asked if it would be acceptable to conduct the operation without the tools, they said that it would be somewhat acceptable (M=3.25; see Fig. 24). They suggested changes into the procedures, such as submitting only one TOS, utilizing more pre-departure flights to be ground delayed instead of trying to solve the entire problem with airborne reroutes, as well as more pre-planning coordination to assist the TMCs about the plan and its potential impacts. Even then, one participant thought that the process would be too labor intensive and the TOS participating airlines may get worse route options than those that did not choose to participate.

When they were asked more explicitly how well they could perform the advisory and TOS evaluation functions manually without the new tools, they responded that they would not perform very well (M=2.25; see Fig. 24). They commented that it would take a while to figure out how many aircraft to move for each airline and it would take more people to execute the tasks. One participant gave a high rating (M=4) that the operations can be done manually but the comments conflicted with the ratings in that he thought that while the advisories were not a problem, it would not be possible at all to evaluate multiple TOS options manually. One participant suggested that manual adjustments to TOS routes may be needed if the weather situation changed dynamically after the TOS reroutes were submitted by the airlines.

B. AOC Feedback

1. *Acceptability of the Concept and Procedures*

Fig. 25 shows the AOC ratings when they were asked about the acceptability of the concept and operational procedures associated with AOC's role in dynamic airborne weather reroutes. They unanimously agreed that the operational procedures for handling dynamic reroutes using third-party TOS generation tool were highly acceptable (M=5). They thought that the operation was feasible, and the procedures were clear. One participant raised some concern about the workload if there were a large number of reroutes needed to be processed but the ability to sort and organize the aircraft list in flexible ways could help organize and group the reroute process to reduce the workload. Another participant commented that in order to manage the workload, the feasibility of the concept depended on the assumption that the TOS submission and coordination between the AOC and the ATCSCC can be done electronically.

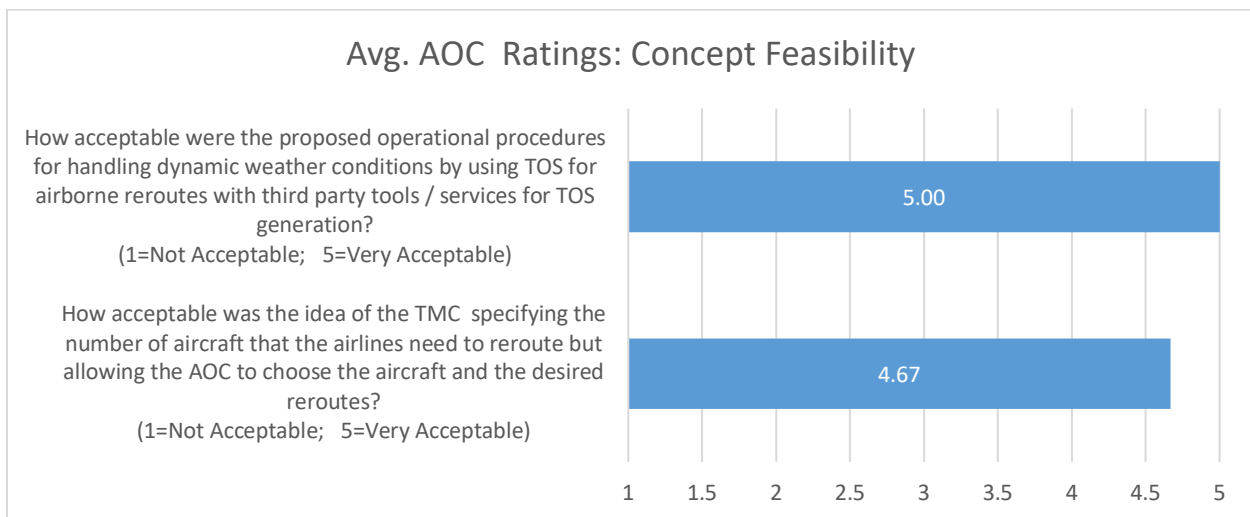

Fig. 25: Feasibility / Acceptability of the Concept and Procedures

They also rated the idea of letting the TMC dictate the number of aircraft to be rerouted to meet the new capacity but allow the airlines to choose the aircraft to be rerouted as highly acceptable (M=4.67). They thought that transparency was important to make sure that all airlines were taking the responsibility of rerouting their allotment of the aircraft and not “game the system”. One participant added that AOC should be given the capacity modeling capability that the TMC so that the airlines could independently model constraints and come up with alternative solutions. Another participant liked that the concept gave the AOCs the ability to choose their own solutions and “avoid the hammer” effect that results when the TMC reroutes the aircraft themselves, en masse, in today’s operations.

2. *Feedback on the New AOC Tool Functions*

The AOC participants were asked to provide feedback on the implementation specifics of the AOC tool functionalities. In particular, they were asked about the tool functionalities shown in Fig. 11 and Fig. 12, which showed how the new AOC tool generated TOS routes. Fig. 26 shows how the participant rated this tool functionality.

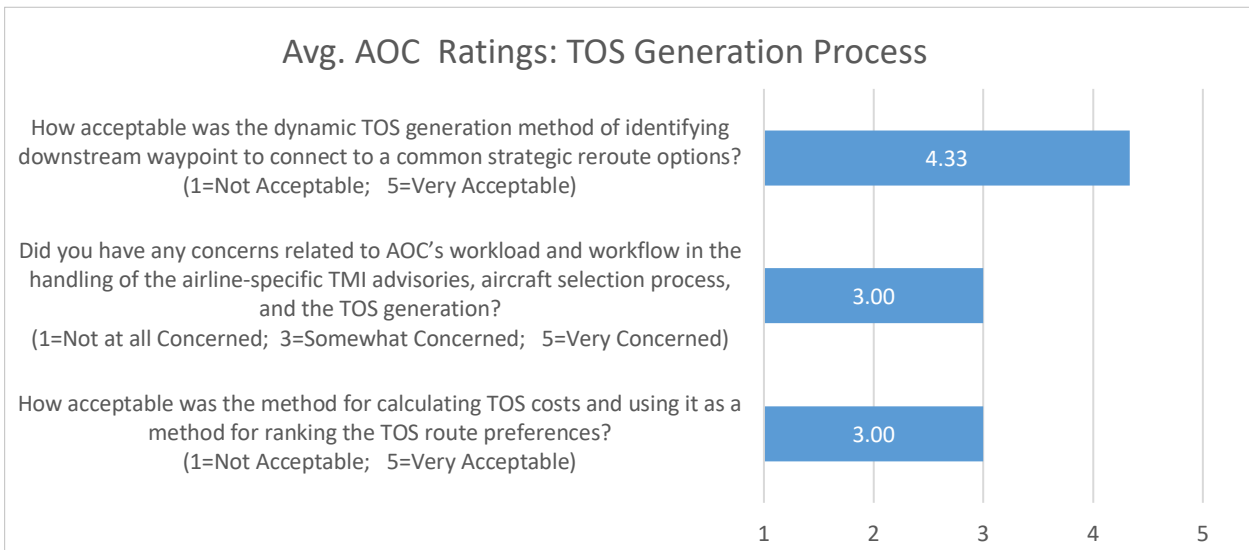

Fig. 26: Feedback on TOS Generation Functionality in the AOC Tool

In general, participants rated that the method for generating dynamic TOS routes as highly acceptable ($M=4.33$). The tool ingested a database of static TOS routes from various origin to destination airports that have been previously vetted as being acceptable routes. These routes have been successfully created in past research, either by using existing Playbook and Coded Departure Routes (CDRs), or by using clustering algorithms to find a set of alternative routes by scanning a database of historically flown routes. Once the static TOS routes from origin to destination airports were generated and stored, the dynamic airborne routes were generated by connecting the aircraft position for the airborne flights to a designated downstream waypoint on the TOS route options. Although the participants liked the TOS generation process, they had some suggestions for improvements. One participant suggested that the airlines should share some of their non-published, “proprietary” routes that are commonly used west of the Mississippi into the TOS route database, which could significantly improve the TOS generation process. Another participant suggested a different method for generating TOS routes manually by using a simple point-and-click method on the TSD.

When they were asked whether the method of ranking the TOS route options according to a cost calculated for each TOS option was acceptable, they rated it as somewhat acceptable ($M=3$). The cost was calculated by combining the cost of various factors, such as additional fuel consumption, additional monetary cost when flying through Canadian airspace, additional delay due to a downstream congestion along the new flight path, and additional crew cost due to delayed landing time and potential missed connections. They were concerned that the cost calculations used here for prioritizing the TOS rankings may differ significantly from the costs used by each airline based on their prerogatives (e.g., passenger connections, gate utilization, etc.) and therefore cause confusion when the calculated costs are presented in the TOS generation tool since they may not match those used in their flight planning system. One participant suggested minimizing this problem by showing just the TOS rankings and put the cost calculations in the background to keep the presentation simple for the users. Conversely, another participant suggested that the tool should provide add functionality to train and tune the underlying cost parameters to modify the underlying cost calculations in the TOS generation tool to fit the company priorities.

When they were asked if they had any concerns related to AOC workload, they were somewhat concerned ($M=3$; 3=Somewhat Concerned). One participant thought that AOC would need to analyze the workflow between ATC Coordinator and the airline dispatchers to coordinate the TOS generation and submission, and he was concerned that there is a potential for a significant workload increase, especially for the ATC Coordinator. The TOS generation tool would mitigate some of the additional workload but having it as a third-party tool with a separate user interface from the flight planning system would add to the workload for the airlines that already incorporate many different tools in their operations.

The AOC participants were also asked for their feedback on the TOS generation tool interface in Fig. 11 and TOS modification tool interface in Fig. 12. Fig. 27 shows their ratings. The participants really liked the ability to view the TOS routes on the TSD and manually grab the route and modify them, which in turn would automatically recalculate the associated costs and adjust the route priority / preferences based on the new costs. They found this functionality to be very good (M=5). They thought it was fast and easy to use and a great way to interact with the TOS. One participant commented that the interaction was similar to the way that they interact with the TSD in their current operations. They were impressed by the “click and drag” capability of modifying the TOS and ranking them by cost made sense to them. They thought that the ability to view and manipulate TOS graphically was a must-have requirement.

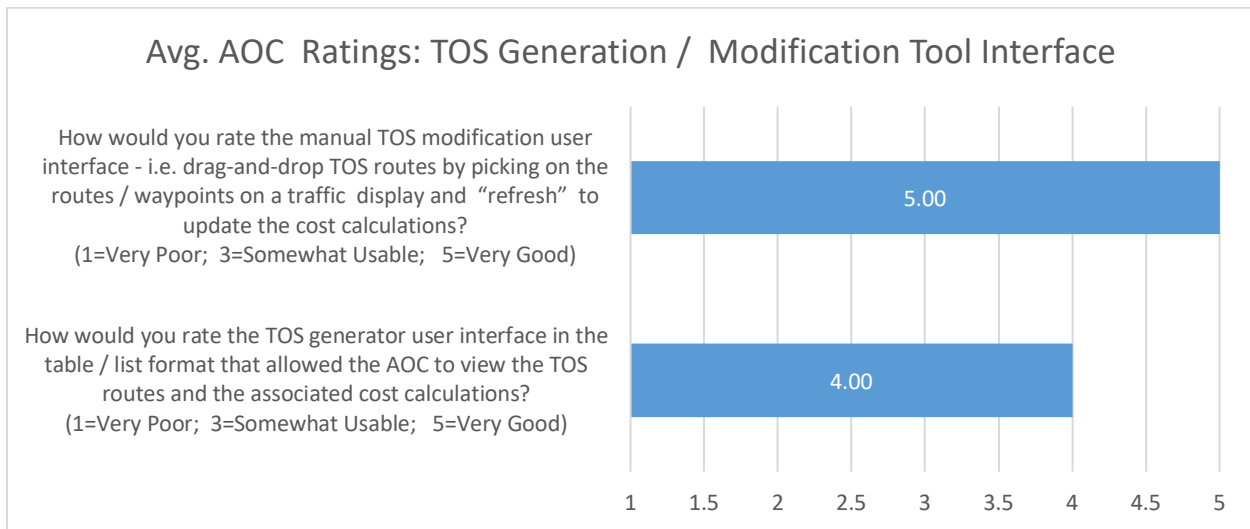

Fig. 27: Feedback on TOS Generation / Modification User Interface

They also rated the TOS generator user interface that displays the TOS options and their associated costs in a table / list format, as shown in Fig. 11, to be good (M=4). They liked the TOS options but were skeptical that the cost calculations would be correct without the help of the airlines’ proprietary information. One participant thought that the information on the list could be organized more efficiently, and another participant suggested that the information should be presented to many airline representatives to gather differing opinions and suggestions.

Finally, they were asked what additional tool functionalities they would want. One participant suggested that they would like to be able to reroute around the constraints proactively before the TMI advisory but “get credit” for the proactive reroute and not be rerouted further. He also suggested additional overlay of meteorological impacts other than convective weather, such as turbulence. Another participant suggested the ability to independently model and monitor the routes and TMIs and identify underutilized airspace to proactively avoid constrained airspace. A third participant requested having mileage labels for the flight distance for the TOS routes.

3. Feasibility of the New AOC Tool Functions as a Third-Party Tool

The participants were asked whether it would be feasible to implement the TOS generation function as a third-party tool or as an embedded function within their flight planning software. They rated that it would be somewhat feasible to implement the function as a third-party tool (M=3.67; 1=Not at all Feasible; 5=Very Feasible). One participant rated the feasibility to be low due to the difficulty of transferring airline proprietary information into a third-party tool. Other participants were more positive and thought that it was quite feasible. They suggested a data exchange capability between the third-party tool and the flight planning system to allow easier transfer of information. An ideal integration would allow the TOS generation tool to send the routes to the flight planning system electronically and allow the flight planning software to re-evaluate the routes using its own parameters.

4. Feasibility of the New Airborne Reroute Procedures without the Additional TMC Tools

The participants were asked a couple of questions about whether the dynamic airborne reroutes using TOS generation functions performed by AOC, as presented in this study, would be possible without the aid of the new tool functionalities that were also presented. Their responses were somewhat mixed, as shown in Fig. 28. When they were asked if it would be acceptable to conduct the operation without the tools, they said that it would be acceptable ($M=4$; see Fig. 28). However, their elaboration of the ratings seemed to suggest that a process without the new tools would not be possible without a lot of changes to the existing tools, such as an integration of TSD with their flight planning system to help them easily build the TOS routes manually. Since different airlines use different software and have different workflow, the integration would also be specific to each airline.

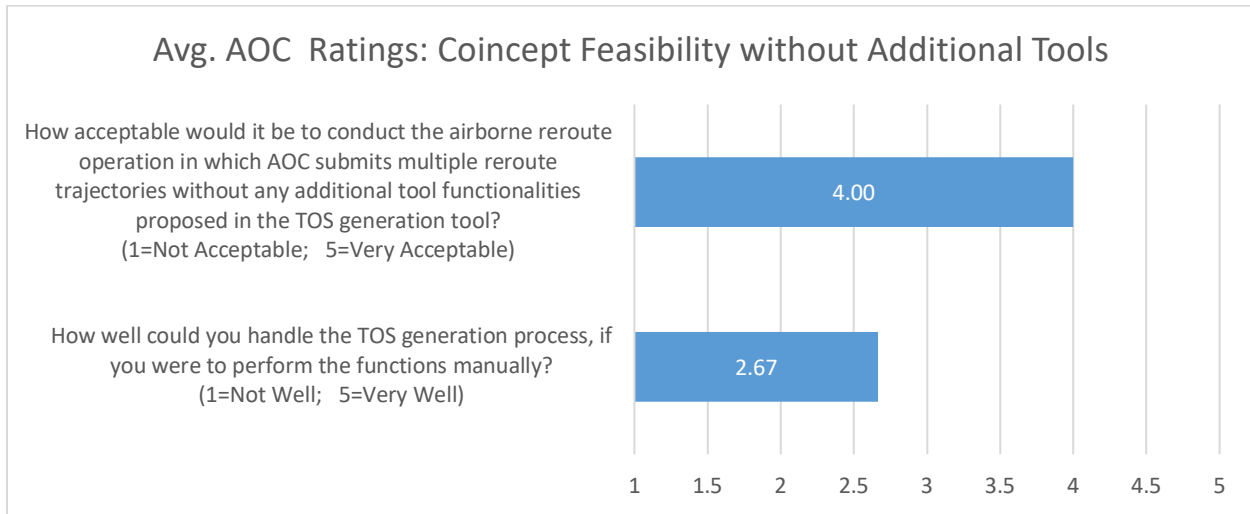

Fig. 28: Feasibility / Acceptability of the Concept and Procedures without the Additional AOC Tools

When they were asked more explicitly how well they could perform the TOS generation functions manually without the new tools, they responded that they would not perform well ($M=2.67$; see Fig. 28) but the ratings varied between participants. Two participants thought that they could pick the TOS routes reasonably well while one participant thought that it would be impossible to do it manually without the TOS generation tool.

VII. Discussions

In addition to the written responses in the questionnaires and interactive discussions during the study, we also conducted a final discussion session at the end of the study. The highlights and key points of those discussions are captured in the following sections.

A. Benefits

The participants reported a potential for significant benefits of allowing airline operators to submit their preferred trajectory options for the airborne flights in response to convective weather constraints. The TMC participants in the study indicated that in current operations, they respond to weather events by tactically delaying pre-departure flights almost exclusively, which puts disproportionate delay on short-haul flights. In our study, they were happy to have airborne reroute capability as an additional mechanism at their disposal to move flights around weather constraints. One participant remarked that this concept enables them to use “a scalpel instead of a hammer” to solve the airspace constraint problem.

Airline operator participants liked the possibility of choosing which flights to move and being able to generate their own trajectories to meet their business case. However, they had a difficult time visualizing the idea that they could now move airborne flights since their current experience has been solely focused on moving pre-departures. Therefore, it seems that the concept implementation would require substantial training for the airline operators to generate and evaluate airborne reroutes effectively.

B. Feasibility

All participants agreed that the concept would be feasible only with the help of the third-party tools that we provided to them. Neither air traffic nor airline participants could envision submitting and evaluating multiple trajectory options in response to a convective weather event without the third-party tools. TMC participants thought that their workload in evaluating the TOS would be way too high to be feasible without the tools, and the airline operators didn't feel that they had the time or the expertise to dynamically generate the trajectory options while adhering to various airspace and weather constraints.

Unfortunately, neither TMC nor AOC participants were fully convinced that the new tool functions that were developed for the study could be implemented as a third-party tool. TMC participants thought that the functions in their TMC tool was analogous to and an extension of those already in the TFMS tool suite, and therefore they felt that the functions should really be integrated into the TFMS tool suite. AOC participants were more neutral about the feasibility of the third-party TOS generation tool. In general, they felt that if there is an Application Programming Interface (API) that allows data to be passed between the TOS generation tool and their flight planning software, the integration would be seamless. They would like to incorporate the factors that impact the cost parameters to be passed from the flight planning system to TOS generation tool and to be able to send the TOS routes from the TOS generation tool to the flight planning system for further analyses.

C. Concerns and Challenges

One of the goals of the airline-based airborne reroutes using ABRR, TOS, and third-party services was to distribute the decision-making process for the airborne reroutes between TMCs and airline operators by letting the TMCs set the advisories for capacity reduction through the weather and letting the airlines choose which aircraft to reroute and which trajectories they prefer to fly. The concept and procedures in the study were received fairly well, but there was an overall concern that even with the additional tools, the dynamic airborne reroutes would require higher workload than managing the demand by holding the pre-departures. There was also a commonly shared concern among all participants about what would happen if some of the airlines did not "follow the rules" and refused to reroute their flights voluntarily. We stepped through a number of scenarios in which those non-conforming airlines would be "penalized", but we did not arrive at a common conclusion on what those penalties should be. Further development of the use case to define the procedures for dealing with non-conforming airlines will be needed to progress the concept forward.

VIII. Conclusion

In summary, we demonstrated service-oriented technologies improving traditional operations in a high complexity airspace in a simulated environment. We developed a concept of operations, a communication framework, procedures, roles, responsibilities, and third-party service / tools. We elicited feedback from air traffic and airline subject-matter-experts for the concept benefits and feasibility of using third-party services / tools to improve traditional operations. The feedback was generally positive, both in the benefits of the concept and the feasibility / need for additional tools to enable the concept, but their feedback was mixed on whether these tools could be provided by third-parties other than the ones who have developed the TFMS tool suite for the TMCs and the flight planning software for the AOCs. This concept explores and demonstrates an evolutionary pathway toward a service-oriented future that shifts the responsibilities and the capabilities of air traffic operations from the air traffic service providers to the airline industry and third-party vendors.

Acknowledgments

The authors would like to thank Charles Walter, Mythili Madhavan, and James Hunter for software development for the third-party service tool prototypes, and Duke Ho, Latha Balijepalle, and Julie Matsuda for simulation information technology support. In addition, the authors would like to thank the subject matter experts, Mark Evans, Don Wolford, and Glenn Godfrey who provided insights into the TMC and AOC operations.

References

- ¹ FAA, “NextGen Vision for Trajectory Based Operations”, version 2.0, September 2017.
- ² FAA, “Unmanned Aircraft System (UAS) Traffic Management (UTM) Concept of Operations”, version 2.0, March 2020.
- ³ FAA, “Urban Air Mobility (UAM) Concept of Operations”, version 1.0, June 2020.
- ⁴ FAA, “Upper Class E Traffic Management (ETM) Concept of Operations”, version 1.0, May 2020.
- ⁵ Traffic Flow Management System (TFMS) Reference Manual TSD Version 8.9 July 26, 2011. Report No. VNTSC-TFM-RM-010 Volpe National Transportation Systems Center U.S. Department of Transportation Kendall Square Cambridge, Massachusetts 02142.
- ⁶ Traffic Flow Management-Modernization (TFM-M) Program, Traffic Flow Management System (TFMS) Collaborative Trajectory Options Program (CTOP) Interface Control Document (ICD) for the Traffic Flow Management-Modernization (TFM-M) Program, Version 3.0, November 2012.
- ⁷ Smith, P. J., Evans, M., & Spencer, A., Traffic Flow Management for Trajectory Based Operations: Supporting Effective Predeparture Reroutes. *20th International Symposium on Aviation Psychology*, 2019, pp 49-54.
- ⁸ Brasil, C. L., Lee, P. U., Gabriel, C., Garzon-Galindo, K., Buckley, N. J., Kalush, S. N., Madhavan, M., Unlocking Airborne Reroute Capability utilizing Trajectory Option Sets with the Development of Third-Party Decision Support Tools, In *40th IEEE/AIAA Digital Avionics Systems Conference (DASC)*, 2021.
- ⁹ Garzon-Galindo, K., Lee, P. U., Brasil, C. L., Modeling Relative Trajectory Costs for Airborne Trajectory Reroutes using Trajectory Option Sets, In *40th IEEE/AIAA Digital Avionics Systems Conference (DASC)*, 2021.
- ¹⁰ NASA Ames Research Center Aviation Systems Division, Software Implementation for ATM Research, https://aviationsystems.arc.nasa.gov/research/foundations/sw_overview.shtml
- ¹¹ Prevot, T., Exploring the many perspectives of distributed air traffic management: The Multi Aircraft Control System MACS, In *Proceedings of the HCI-Aero, 2002*, pp. 149-154.