

Potential of Materials to Impact Megawatt-Scale Electric Machines

Andrew Woodworth, Tiffany Williams, Marisabel Kelly & William Sixel
NASA Glenn Research Center, Cleveland OH 44135,

E. Eugene Shin and Baochau. N. Nguyen
Universities Space Research Association, Cleveland, Ohio 441235,

Paria Naghipour
HX5 LLC, Brook Park, Ohio 44142 USA

AIAA/IEEE Electric Aircraft Technologies Symposium, August 11th-13th, 2021

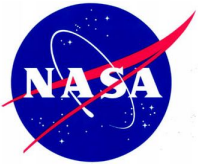

Introduction

Electric machine key performance parameters

- >1 MW, >13 kW/kg, >96% Efficient (< 40kW of waste heat/MW)
- Significant thermal management problem

Stator composition

- Thermally conductive electrical conductor
- Several nonthermally conductive potting and electrical insulation materials
- Multi-material systems is a composite material

Targets

- Slot/slot liner (high voltage separator)-extruded polymer composites
- Wire insulation-polyimide/BNNS composites
- Potting materials and methods

Limitation of cooling

- Dielectric fluids are a common way of cooling a stator
- Dielectric fluids are not as efficient at single-phase as water-based fluids for thermal transport applications
- Water based fluids have a relatively low dielectric breakdown
- A 3-D printable material that has significant dielectric strength and thermal conductivity would be of great interest

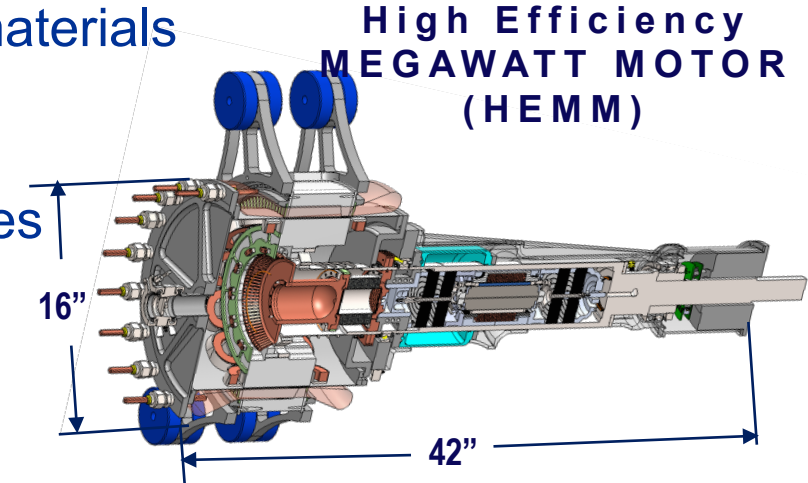

Extruded materials

- Extruded flexible polymer composite tapes have been demonstrated but other structures are possible
- Many different extrusion for possible including 3-D printer compatible filament extrusion possible
- 3-D printing of thermally conductive, electrically insulative heat exchanging stator teeth with integral fluid channels maybe useful

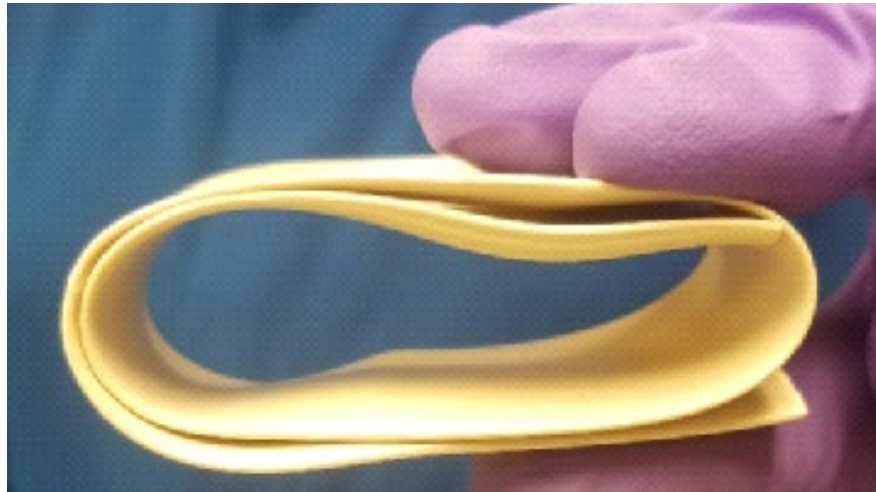
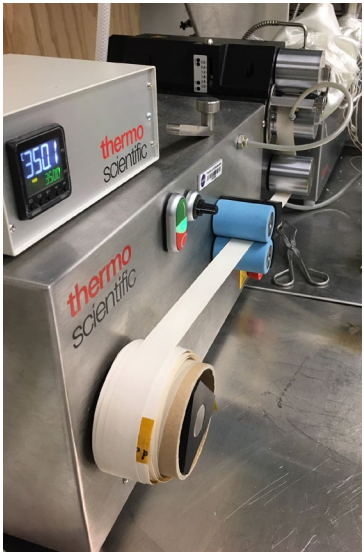

Flexible extruded PPSU (polyphenylsulfone)-hBN composite

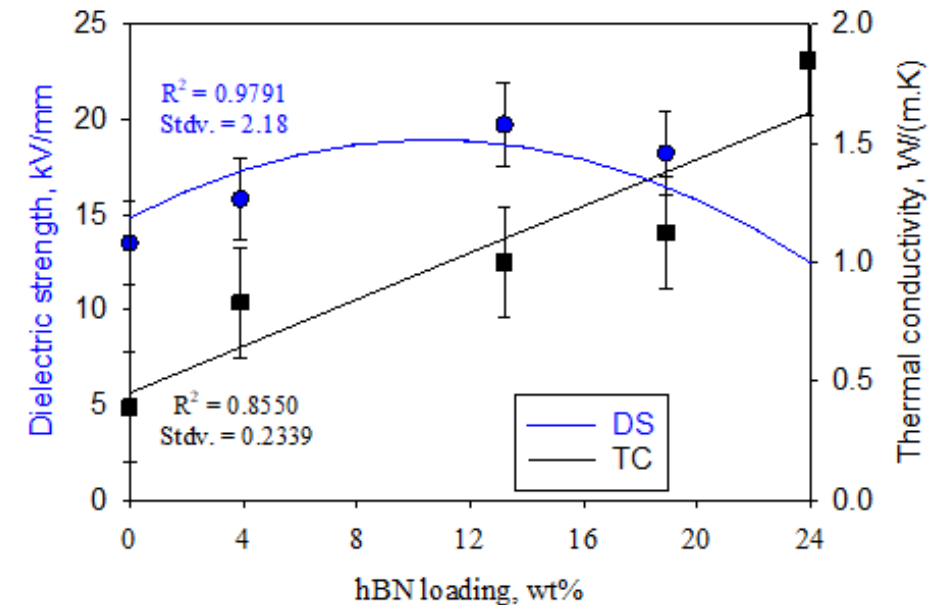

Take away: Flexible extruded polymer-hBN composites offer interesting solutions for electric machines

Williams, T., S, et. al, "Fabrication of Extruded Polyphenylsulfone-Boron Nitride Composite Tapes," *Society for the Advancement of Material and Process Engineering neXus*, Virtual, 2021.

Polyimide-BNNS composite

- Retention of flexibility is critical for wire coatings
- ~30% reduction in dielectric strength
- Order of magnitude increase in thermal conductivity

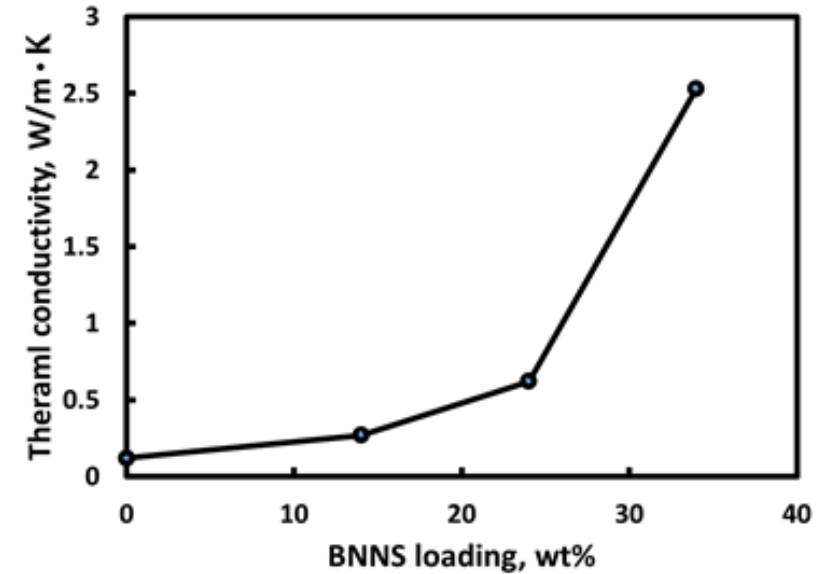
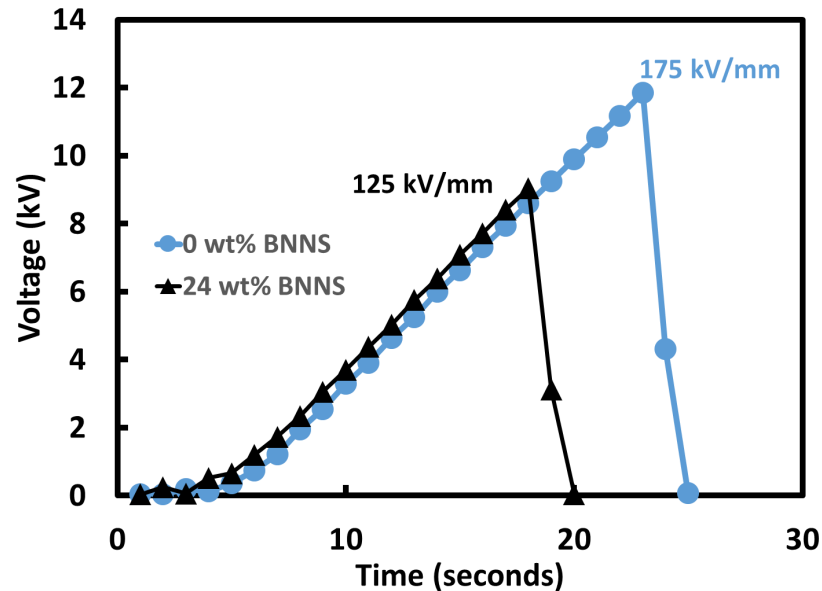

Take away: Polyimide-BNNS composites are a viable option for motor applications with improved thermal conductivity

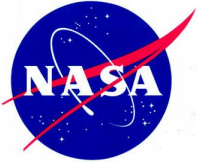

Potting and Microthermal Analysis

- Vacuum-assisted axial injection potting (VaAIP) process
 - E. E. Shin, "Improved potting of Litz Wires for High Power Density Electric Motor," 2021 AIAA/IEEE EATS
 - Allows epoxy to flow along wires instead of through a bundle
- Thermal conductivity in potting materials
 - Usually achieved through micron sized fillers
 - Drives up viscosity
- Microthermal Analysis
 - Thermal traps (no heat flow) between conductors
 - Simple 2X improvement in trap areas significantly improves heat flow
 - Need to channel high thermal conductivity materials to these locations

Thermal traps caused by SOA Materials

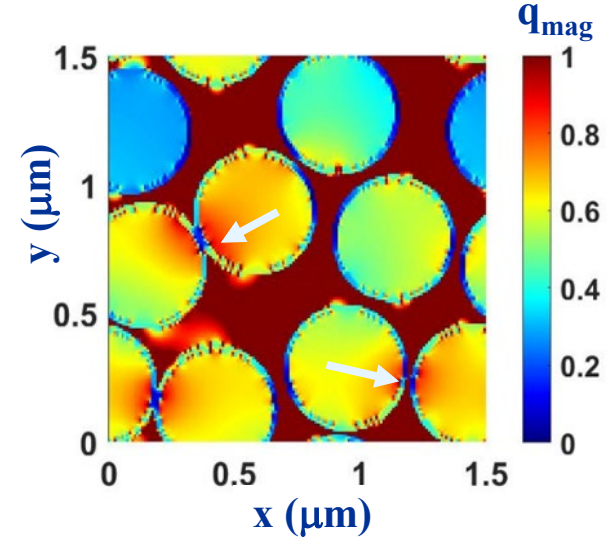
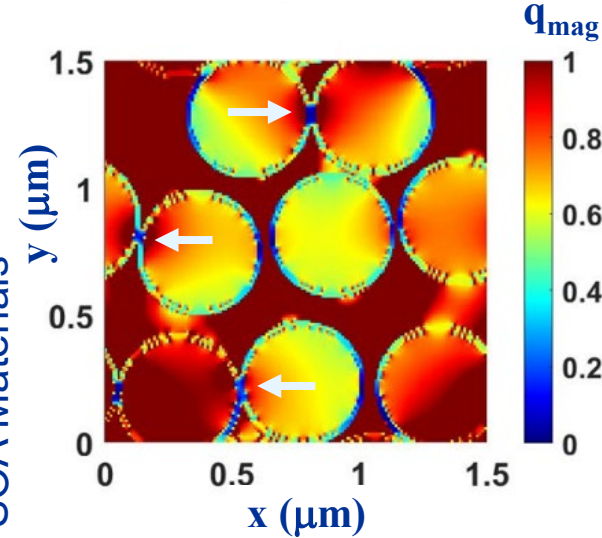

T.C. 2X in thermal trap areas

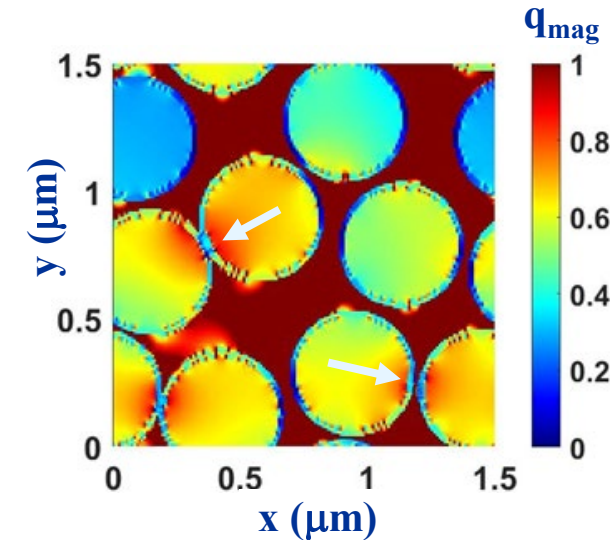
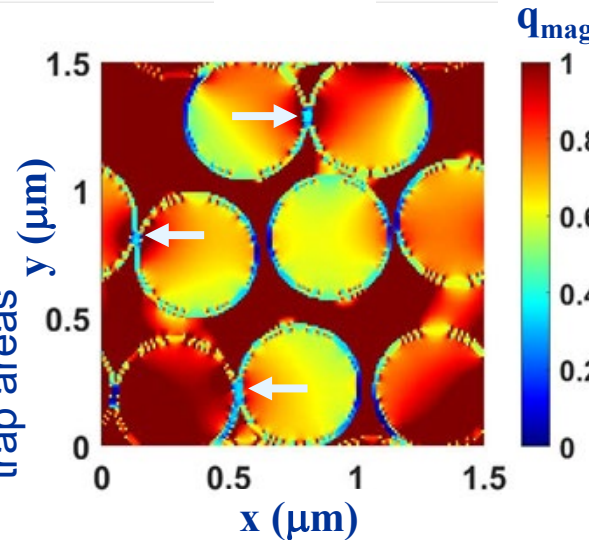

Take away: Combination of VaIP and low levels of nano fillers may enable significant thermal conductivity improvements

System Study

- 3-D printed direct winding heat exchangers
- BNNS infiltrated potting
- BNNS improved polyimide

Winding Insulation Component	Base Material	SOA Material (W/m-K)	Composite Material (W/m-K)
Encapsulation (Potting)	SOA Epoxy	1.3	1.7 *
Wire Insulation	Polyimide	0.1	2.5
Extruded 3D-DWHX**	PPSU	0.4	1.8

Printed direct winding heat exchangers (3D-DWHX 3-D)

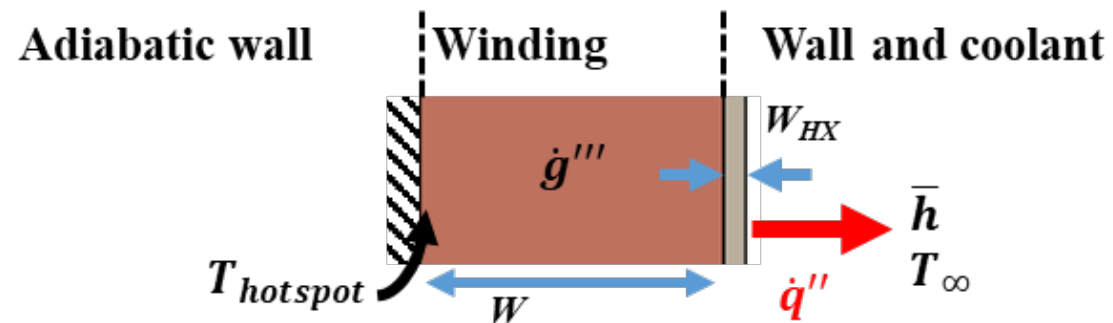

*Shin, E. E., "Improved potting of Litz Wires for High Power Density Electric Motor," 2021 AIAA/IEEE EATS

**Sixel, W., Liu, M., Nellis, G., and Sarlioglu, B., "Cooling of Windings in Electric Machines via 3-D Printed Heat Exchanger," IEEE Transactions on Industry Applications Vol. 56, No. 5, 2020, pp. 4718-4726.

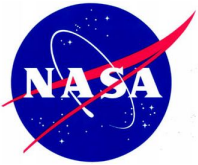

System Study

- Maximum current density was reached when the T_{hotspot} reached 220 °C

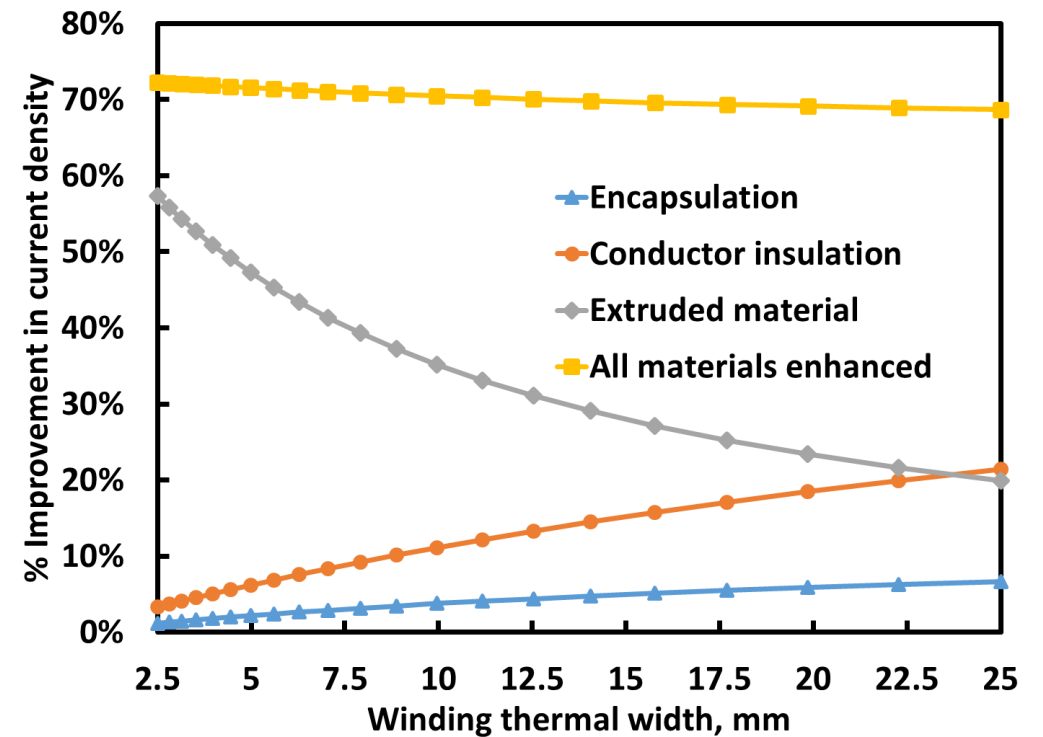
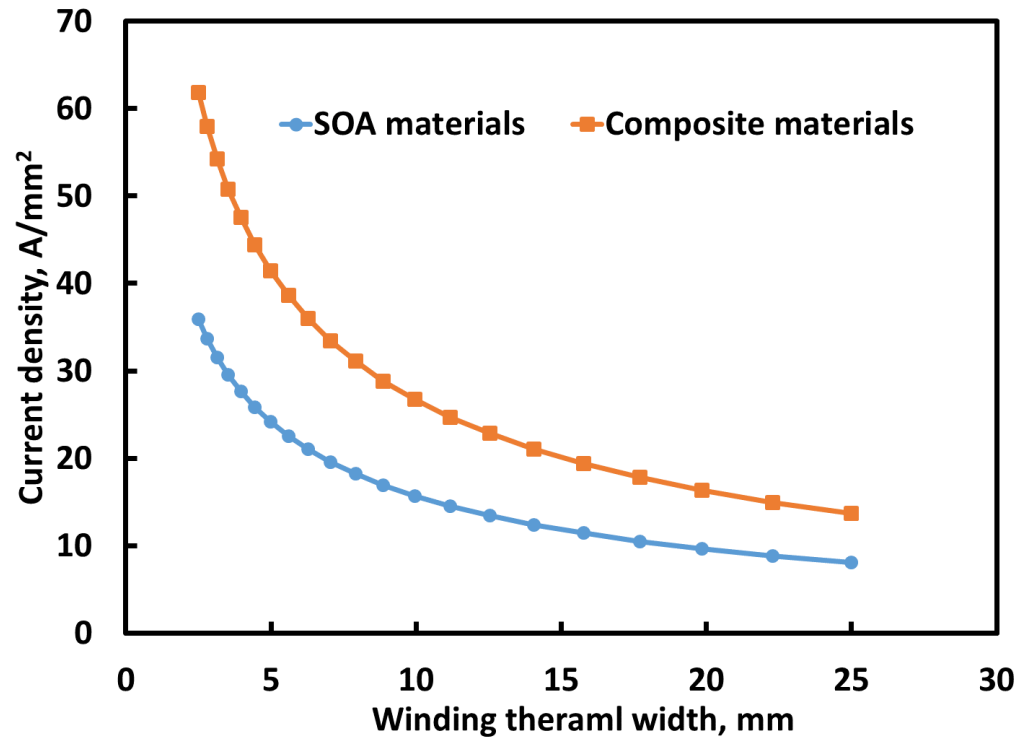

Takeaways

- Definite trade space between the number of turns and thermal performance
- Synergistic effects between the thermal conductivity individual components and system performance

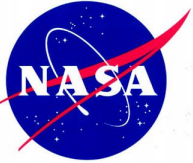

Summary

- Flexible extruded polymer-hBN composites offer interesting solutions for electric machines
- Polyimide-BNNS composites are a viable option for motor applications with improved thermal conductivity
- Combination of VaIP and low levels of nano fillers may enable significant thermal conductivity improvements
- System Study
 - Definite trade space between the number of turns and thermal performance
 - Synergistic effects thermal conductivity effected between individual components and system

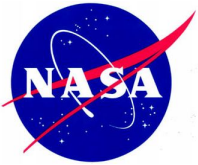

Acknowledgments

- NASA Advanced Air Transportation Technologies project's Power and Propulsion sub project ~Amy Jankovsky
- NASA Transformational Tools and Technologies (Microthermal Modeling)

Electric Machine Insulation Solutions Development Team

- Tiffany Williams
- Maricela Lizcano
- Eugen Shin
- Paria Naghipour
- Baochau. N. Nguyen
- Daniel Scheiman
- Marisabel Kelly
- Kathy Chuang
- Will Sixel
- Linda McCorkle

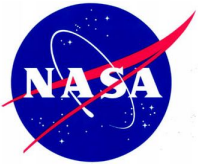

Thank you!

Presenter: Andrew Woodworth

email: andrew.a.woodworth@nasa.gov