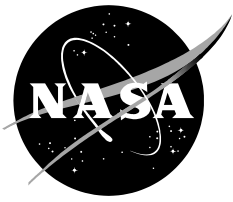


NASA/TP—20210021263



# **State-of-the-Art Small Spacecraft Technology**

*Small Spacecraft Systems Virtual Institute*

*Ames Research Center, Moffett Field, California*

---

**October 2021**

## NASA STI Program ... in Profile

Since its founding, NASA has been dedicated to the advancement of aeronautics and space science. The NASA scientific and technical information (STI) program plays a key part in helping NASA maintain this important role.

The NASA STI program operates under the auspices of the Agency Chief Information Officer. It collects, organizes, provides for archiving, and disseminates NASA's STI. The NASA STI program provides access to the NASA Aeronautics and Space Database and its public interface, the NASA Technical Reports Server, thus providing one of the largest collections of aeronautical and space science STI in the world. Results are published in both non-NASA channels and by NASA in the NASA STI Report Series, which includes the following report types:

- **TECHNICAL PUBLICATION.** Reports of completed research or a major significant phase of research that present the results of NASA Programs and include extensive data or theoretical analysis. Includes compilations of significant scientific and technical data and information deemed to be of continuing reference value. NASA counterpart of peer-reviewed formal professional papers but has less stringent limitations on manuscript length and extent of graphic presentations.
- **TECHNICAL MEMORANDUM.** Scientific and technical findings that are preliminary or of specialized interest, e.g., quick release reports, working papers, and bibliographies that contain minimal annotation. Does not contain extensive analysis.
- **CONTRACTOR REPORT.** Scientific and technical findings by NASA-sponsored contractors and grantees.

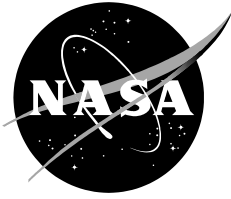
- **CONFERENCE PUBLICATION.** Collected papers from scientific and technical conferences, symposia, seminars, or other meetings sponsored or co-sponsored by NASA.
- **SPECIAL PUBLICATION.** Scientific, technical, or historical information from NASA programs, projects, and missions, often concerned with subjects having substantial public interest.
- **TECHNICAL TRANSLATION.** English-language translations of foreign scientific and technical material pertinent to NASA's mission.

Specialized services also include organizing and publishing research results, distributing specialized research announcements and feeds, providing information desk and personal search support, and enabling data exchange services.

For more information about the NASA STI program, see the following:

- Access the NASA STI program home page at <http://www.sti.nasa.gov>
- E-mail your question to [help@sti.nasa.gov](mailto:help@sti.nasa.gov)
- Fax your question to the NASA STI Information Desk at 443-757-5803
- Phone the NASA STI Information Desk at 443-757-5802
- Write to:  
STI Information Desk  
NASA Center for Aerospace Information  
7115 Standard Drive  
Hanover, MD 21076-1320

NASA/TP—20210021263



# **State-of-the-Art Small Spacecraft Technology**

*Small Spacecraft Systems Virtual Institute*

*Ames Research Center, Moffett Field, California*

National Aeronautics and  
Space Administration

*Ames Research Center  
Moffett Field, CA 94035-1000*

---

**October 2021**

The use of trademarks or names of manufacturers in this report is for accurate reporting and does not constitute an official endorsement, either expressed or implied, of such products or manufacturers by the National Aeronautics and Space Administration.

Available from:

NASA Center for AeroSpace Information  
7115 Standard Drive  
Hanover, MD 21076-1320  
443-757-5802

This report is also available in electronic form at  
<http://www.nasa.gov/smallsat-institute/sst-soa>

**NASA STI Support Services**  
Mail Stop 148  
NASA Langley Research Center  
Hampton, VA 23681-2199  
757-864-9658

**National Technical Information Service**  
5301 Shawnee Rd.  
Alexandria, VA 22312  
webmail@ntis.gov  
703-605-6000



SMALL SPACECRAFT SYSTEMS VIRTUAL INSTITUTE  
Small Spacecraft Technology  
**State of the Art Report**



## Cover Page Image Credits

### Top Left:

Spacecraft: Artist's (M. Combs and B. Malphrus) concept of Lunar IceCube in lunar orbit. Credits: Morehead State University

Profile Technology: Space Micro P400, Credits: Space Micro, Inc.

### Top Right:

Spacecraft: Illustration of Lunar Flashlight at the Moon. Credits: NASA/JPL

Profile Technology: Lunar Flashlight's propulsion system

Credits: NASA/Georgia Institute of Technology

### Lower Left:

Spacecraft: CAPSTONE is expected to be the first CubeSat to fly in cislunar space. Credits: NASA/Advanced Space/Tyvak Nano-Satellite Systems

Profile Technology: CAPSTONE's propulsion system. Credits: Stellar Exploration

### Lower Right:

Spacecraft: The LunaH-Map spacecraft's destination is an orbit around the Moon.

Credits: Arizona State University

Profile Technology: MMA eHAWK solar arrays, Credits: MMA Design, LLC

NASA Ames Research Center, Small Spacecraft Systems Virtual Institute

*October 2021*

**Small Spacecraft Systems Virtual Institute Director:**

Bruce Yost

**Editor:**

Sasha Weston

**Contributors and Reviewers:**

Helpful suggestions and contributions were also received from numerous people across NASA and The Aerospace Corporation. In particular, the following are acknowledged for their participation as contributors or reviewers on the 2021 SOA report:

From NASA Ames Research Center: Richard Alena, Rodolphe De Rosee, Andres Dono, John Hines, Marcus Jackson, Livingstone Johnson, Stanley Krzeński, Anh Nguyen, Mark Mallinson, David Mauro, Alex Mazhari, Marc Murbach and the TechEdSat team, Craig Pires, Jan Stupl, Shang Wu, and Senior Technical Editor Teague Soderman

From NASA Glenn Research Center: Gabriel Benavides and Thomas Liu

From NASA Goddard Spaceflight Center and Wallops Flight Facility: Andy Adams, Alistair Funge, and Luis Santos

From NASA Marshall Spaceflight Center: Daniel Cavender, John Dankanich, Linda Krause, Stephanie Mauro, Greg Schultz, and George Story

From NASA Kennedy Space Center: Scott Higginbotham

From NASA Langley Research Center: Laurence Thomsen

From NASA Headquarters: Joshua Krage

From NASA Jet Propulsion Laboratory: Ashley Karp

From The Aerospace Corporation: Dexter Becklund, Barbra Braun, Selasi Etchey, Rudd Johnson, Edward Jung, Yao Lao, Dave Lubar, Kiara O'Neill, Laura Ramos, Mark Skinner, and Catherine Venturini

The authors would like to also thank all of the companies, universities and organizations who provided information for this report.



## Contents

1. Introduction .....	1
2. Integrated Spacecraft Platforms .....	6
3. Power .....	25
4. In-Space Propulsion .....	52
5. Guidance, Navigation, and Control.....	121
6. Structures, Materials, and Mechanisms .....	155
7. Thermal Control.....	183
8. Small Spacecraft Avionics .....	202
9. Communications.....	232
10. Integration, Launch and Deployment.....	253
11. Ground Data Systems and Mission Operations .....	267
12. Identification and Tracking Systems.....	337
13. Deorbit Systems .....	347
14. Summary.....	362
15. Master Acronym List .....	363
16. Appendix E - NPR 7123.1C - Technology Readiness Levels .....	371





## Preface

When the first edition of NASA's *Small Spacecraft Technology State-of-the-art* report was published in 2013, 247 CubeSats and 105 other non-CubeSat small spacecraft under 50 kilograms (kg) had been launched worldwide, representing less than 2% of launched mass into orbit over multiple years. In 2013 alone, around 60% of the total spacecraft launched had a mass under 600 kg, and of those under 600 kg, 83% were under 200 kg and 37% were nanosatellites (1). Of the total 1,282 spacecraft launched in 2020, 94% were small spacecraft with an overall mass under 600 kg, and of those under 600 kg, 28% were under 200 kg, and 9% were nanosatellites (1). Since 2013, the flight heritage for small spacecraft has increased by over 30% and has become the primary source to space access for commercial, government, private, and academic institutions.

As with all previous editions of this report, the 2021 edition captures and distills a wealth of new information available on small spacecraft systems from NASA and other publicly available sources. This report is limited to publicly available information and cannot reflect major advances in development that are not publicly disclosed. We encourage any opportunity to publish mission outcomes and technology development milestones (e.g. via conference papers, press releases, company website) so they can be reflected in this report. Overall, this report is a survey of small spacecraft technologies sourced from open literature; it does not endeavor to be an original source, and only considers literature in the public domain to identify and classify devices. Commonly used sources for data include manufacturer datasheets, press releases, conference papers, journal papers, public filings with government agencies, news articles, presentations, and the compendium of databases accessed via NASA's Small Spacecraft Systems Virtual Institute Federated Search. Data not appropriate for public dissemination, such as proprietary, export controlled, or otherwise restricted data, are not considered. As a result, this report includes many dedicated hours of desk research performed by subject matter experts reviewing resources noted above. Content in this 2021 edition is based on data available by July 2021.

Each chapter is a mini-stand-alone report on spacecraft subsystems. The organizational approach for each chapter is relatively consistent with previous editions and includes an introduction of the technology, current development status of the technology's procurable systems, and a summary of technologies surveyed. New for this year's report is a table of contents for each chapter to better assist the reader in locating specific information. As in previous years, chapters are updated with new and maturing technologies and reference missions and include information from previous editions. Tables in each section provide a convenient summary of the technologies discussed, with explanations and references in the body text. The authors have attempted to isolate trends in the small spacecraft industry to point out which technologies have been adopted as a result of successful demonstration missions.

The report's subject chapters have changed, and information has been added and removed to reflect changes and growth in the small spacecraft market. A new chapter titled "Small Spacecraft Avionics" encompasses information from the previous "Command and Data Handling" and "Flight Software" chapters and provides more insight on a new generation of SmallSat avionics systems. The "Communications" chapter underwent a complete update to better display useful information for mission design engineers and has been separated appropriately into radio frequency and optical telecommunications descriptions and associated technologies. The "Complete Spacecraft Platforms" chapter has been reorganized to include more information on the development of small spacecraft platforms, provide systems engineering considerations, and to expose recent and upcoming trends in small spacecraft buses. The "Power" chapter was also completely reworked to focus more on engineering requirements and processes for choosing a device. Lastly, the authors tried to use the terms "SmallSat," "microsatellite," "nanosatellite," and "CubeSat" in a consistent manner, even as these terms are often used interchangeably in the space industry.



A central element of this report is to list state-of-the-art technologies by NASA standard Technology Readiness Level (TRL) as defined by the 2020 NASA Engineering Handbook, found in NASA NPR 7123.1C *NASA Systems Engineering Processes and Requirements*. The authors have endeavored to independently verify the TRL value of each technology by reviewing and citing published test results or publicly available data to the best of their ability. Where test results and data disagree with vendors' own advertised TRL, the authors have attempted to engage the vendors to discuss the discrepancy. Readers are strongly encouraged to follow the references cited to the literature describing the full performance range and capabilities of each technology. Readers of the report should reach out to individual companies to further clarify information. It is important to note that this report takes a broad system-level view. To attain a high TRL, the subsystem must be in a flight-ready configuration with all supporting infrastructure—such as mounting points, power conversion, and control algorithms—in an integrated unit.

An accurate TRL assessment requires a high degree of technical knowledge on a subject device, and an in-depth understanding of the mission (including interfaces and environment) on which the device was flown. There is variability in TRL values that depends on the design factors for a specific technology. For example, differences in TRL assessment based on the operating environment may result from the thermal environment, mechanical loads, mission duration, or radiation exposure. If a technology has flown on a mission without success, or without providing valid confirmation to the operator, such claimed “flight heritage” was discounted. The authors believe TRLs are most accurately determined when assessed within the context of a program's unique requirements.

While the overall capability of small spacecraft has matured since the 2020 edition of this report, technologies are still being developed to make deep space SmallSat missions more routine. This has led to intense scrutiny over the radiation tolerance of small spacecraft, especially given their tendency to use low-cost, commercial off-the-shelf (COTS) components. Consequently, this report also includes radiation mitigation strategies for small spacecraft missions. Future editions of this report may include content dedicated to the rapidly growing fields of assembly, integration, and testing services, and mission modeling and simulation—all of which are now extensively represented at small spacecraft conferences. Many of these subsystems and services are still in their infancy, but as they evolve and reliable conventions and standards emerge, the next iteration of this report may also evolve to include additional chapters.

## References

- (1) Bryce and Space Technology. “SmallSat by the Numbers, 2021.” Updated August 13, 2021. [Online] [Accessed: August 24, 2021]. <https://brycetek.com/reports>



## Chapter Glossary

(EELV)	Evolved Expendable Launch Vehicle
(ESPA)	EELV Secondary Payload Adapter
(FASTSAT)	Fast, Affordable, Science and Technology Satellite
(LADEE)	Lunar Atmosphere and Dust Environment Explorer
(LCROSS)	Lunar Crater Observation and Sensing Satellite
(NODIS)	NASA Online Directives Information System
(SST)	Small Spacecraft Technology
(STMD)	Space Technology Mission Directorate
(TMA)	Technology Maturity Assessment
(TRL)	Technology Readiness Level
(U)	Unit



## 1.0 Introduction

### 1.1 Objective

The objective of this report is to assess and provide an overview of the state of the art in small spacecraft technologies for mission designers, project managers, technologists, and students. This report focuses on the spacecraft system as a whole, provides current best practices for integration, and then presents the state of the art for each specific spacecraft subsystem. Certain chapters have a particular emphasis on CubeSat platforms, as nanosatellite applications have expanded due to their high market growth in recent years.

This report was first commissioned by NASA's Small Spacecraft Technology (SST) program in mid-2013 in response to the rapid growth in interest in using small spacecraft for missions beyond low-Earth orbit. The report was subsequently updated in 2015, 2018, and 2020. In addition to reporting currently available technologies that have achieved TRL 5 or above, a prognosis is provided describing technologies "on the horizon," or those technologies that are being considered for future application.

This work is now funded by NASA's Space Technology Mission Directorate (STMD) and Science Mission Directorate (SMD).

### 1.2 Scope

The SmallSat mission timeline began at NASA Ames Research Center with the launch of Pioneer 10 and 11 that launched in March 1972 and April 1973, respectively. Both spacecraft weighed < 600 kg. To address the increase in mass and associated cost with the high launch cadence, NASA established the Small Explorer (SMEX) Program in 1988 to encourage the development of small spacecraft. In 1998, Ames' SmallSat program then focused on lunar exploration and launched Lunar Prospector (< 700 kg), followed by the Lunar Crater Observation and Sensing Satellite (LCROSS), (< 630 kg) in 2009, and the Lunar Atmosphere and Dust Environment Explorer (LADEE), (~380 kg) which was launched in September 2013. In late 2010, NASA launched its first minisatellite called Fast, Affordable, Science and Technology Satellite (FASTSAT), which had a launch mass ~180 kg. This decrease in spacecraft mass and increase in science capabilities ignited interest in miniaturization and maturity of aerospace technologies which have proven to be capable of producing missions for less cost. The Evolved Expendable Launch Vehicle (EELV) Secondary Payload Adapter (ESPA) payloads provided up to 180 kg mass allocation to six payload slots in 2012 when this report was first being written.

As this report is focused on smaller platforms, the "180 kg mass limit" served as a good indicator to further classify a "SmallSat." SmallSats are generally grouped according to their mass, and this report adopts the following five small spacecraft mass categories (1):

- minisatellites are spacecraft with a total mass of 100 – 180 kg;
- microsatellites have a total spacecraft mass of 10-100 kg;
- nanosatellites have a total mass of 1 – 10 kg;
- picosatellites have a mass of 1 – 0.01 kg; and
- femtosatellites have a total spacecraft mass 0.01 – 0.09 kg.

Figure 1.1 offers examples of the various categorized spacecraft. On the lower mass end, there are projects such as KickSat-2, which deployed 100-centimeter (cm) scale "ChipSat" spacecraft, or Sprites, from a 2U femtosatellite deployer in March 2019. These femtosatellite ChipSats are the size of a large postage stamp and have a mass below 10 grams.

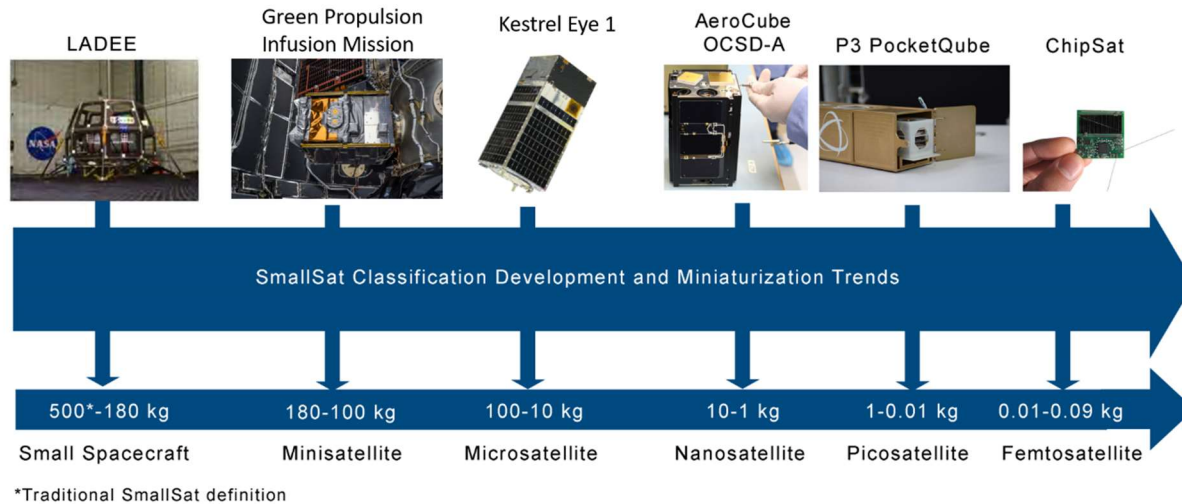


Figure 1.1: Overview of small spacecraft categories. Credit: NASA, SpaceX, Redwire Space, and Alba Orbital.

In 1999, a collaboration between California Polytechnic State University (Cal Poly) in San Luis Obispo and Stanford University in Stanford, California, developed a small educational platform called a "CubeSat" which was designed for space exploration and research for academic purposes. CubeSats are now a common form of small spacecraft that can weigh only a few kilograms (up to 30 kg) and are based on a form factor of a 10 cm square cube, or unit (U) (1). The original CubeSat was composed of a single cube, a 1U, and it is now common to combine multiple cubes to form, for instance, 3U or 6U units as shown in figure 1.2. These larger CubeSat sizes have become more standardized and popular in the past five years as much more science can be achieved at less cost with the additional volume, power, and overall increase in capability.

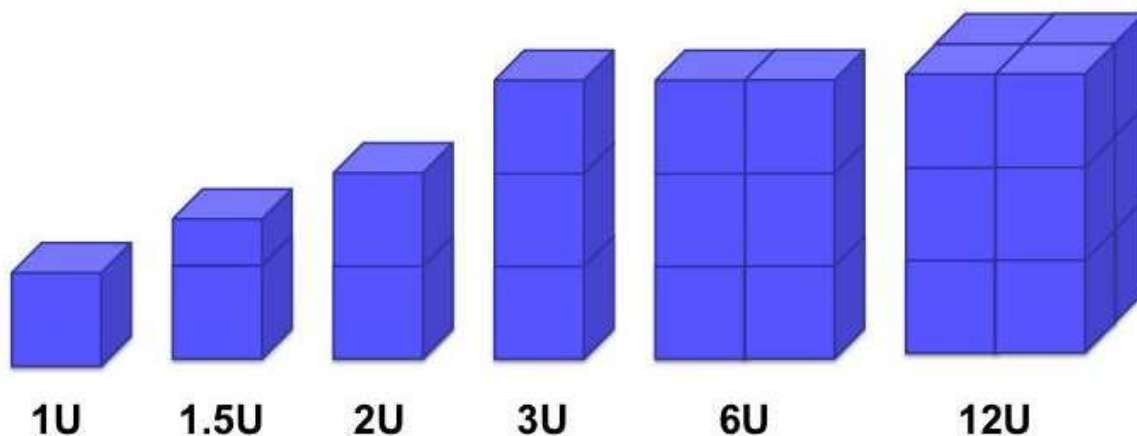


Figure 1.2: CubeSats are a class of nano- and microsatellites that use a standard size and form factor. Credit: NASA.



It is common to interchange the terms “CubeSat” and “NanoSat” (short for nanosatellite) as the original 1-3U CubeSat platforms fall under the nanosatellite category. Since the physical expansion of CubeSats in 2014 with the 6U form factor, CubeSats now fall into both nanosatellite and microsatellite categories, and this report refers to a nanosatellite as a spacecraft with mass under 10 kg; a microsatellite as a spacecraft with mass greater than 10 kg; and a CubeSat as the accepted form factor. Figure 1.3 illustrates the three smaller SmallSat categories: microsatellites, nanosatellites, and picosatellites.

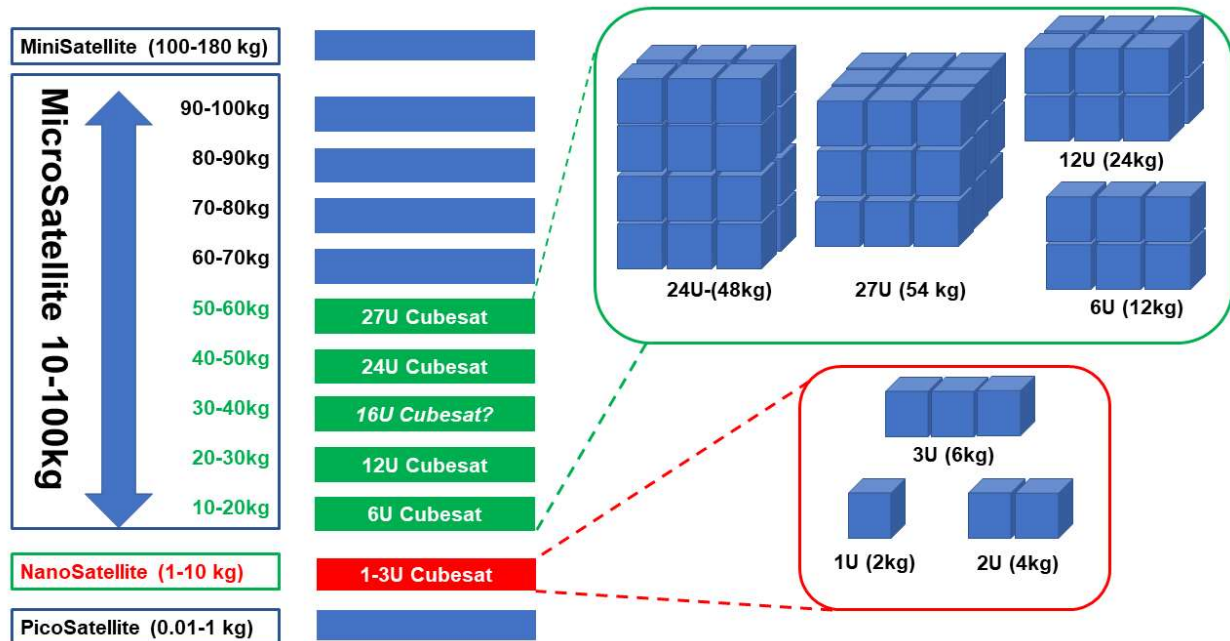


Figure 1.3: Nanosatellite sizes compared to CubeSat containerized sizes. Credit: NASA.

### 1.3 Assessment

This state-of-the-art assessment of SmallSat technology is performed using NASA’s Technology Readiness Level (TRL) scale (figure 1.4). For this report, a technology is deemed state-of-the-art whenever its TRL is larger than or equal to 5. A TRL of 5 indicates that the component and/or breadboard with realistic support elements was built and operated for validation in a relevant environment so as to demonstrate overall performance in critical areas. Success criteria include documented test performance demonstrating agreement with analytical predictions and documented definition of scaling requirements. Performance predictions are made for subsequent development phases (2).

A technology is considered not state of the art whenever its TRL is lower than or equal to 4. In this category, the technology is considered to be “on the horizon.” A TRL of 4 is defined as a component and/or breadboard

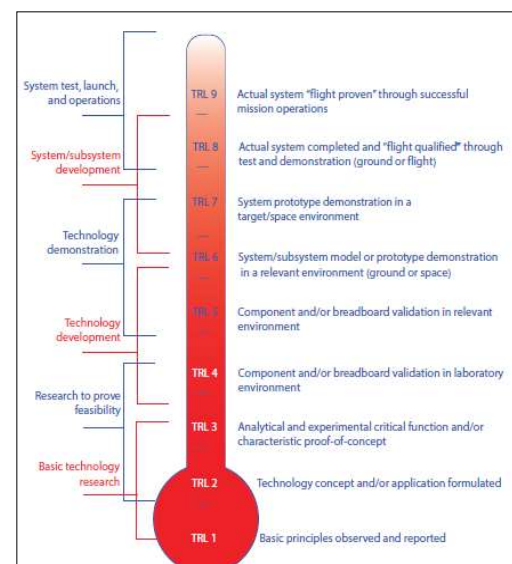


Figure 1.4: NASA’s standard TRL scale. Credit: NASA.

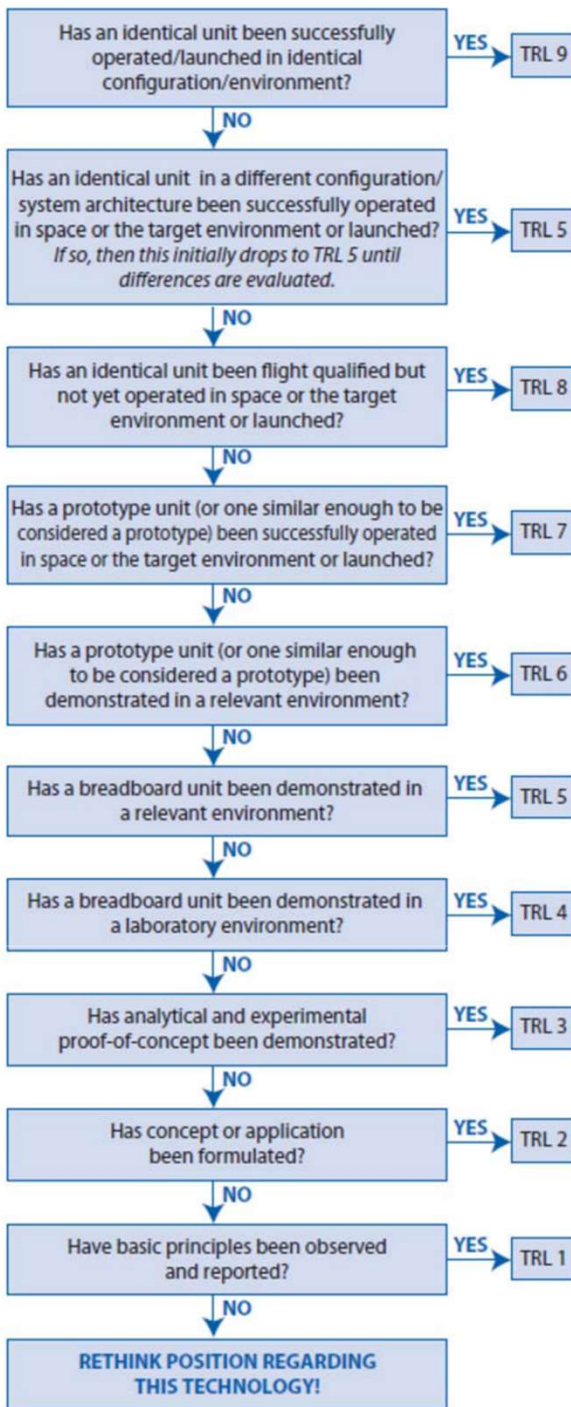


Figure 1.5: Technology Maturity Assessment (TMA) thought process. Credit: NASA.

validated in a laboratory environment with documented test performance demonstrating agreement with analytical predictions and a documented definition of the relevant environment.

NASA standard TRL requirements for this report edition are stated in the NPR 7123.1C, Appendix E, which is effective through February 14, 2025. The criteria for selection of appropriate TRL are described in the NASA Systems Engineering Handbook 6105 Rev 2 Appendix G: Technology Assessment/Insertion. Please refer to the NASA Online Directives Information System (NODIS) website

<https://nodis3.gsfc.nasa.gov/> for NPR documentation. The following paragraphs in sections 1.3.1 and 1.3.2 of this introduction are excerpts from the NASA Engineering Handbook 6105 Rev 2 (pp. 252 – 254). They highlight important aspects of NASA TRL guidelines in hopes of eliminating confusion on terminology and heritage systems.

### 1.3.1 Terminology

“At first glance, the TRL descriptions in figure 1.4 appear to be straightforward. It is in the process of trying to assign levels that problems arise. A primary cause of difficulty is in terminology, e.g., everyone knows what a breadboard is, but not everyone has the same definition. Also, what is a “relevant environment?” What is relevant to one application may or may not be relevant to another. Many of these terms originated in various branches of engineering and had, at the time, very specific meanings to that particular field. They have since become commonly used throughout the engineering field and often acquire differences in meaning from discipline to discipline, some differences subtle, some not so subtle. “Breadboard,” for example, comes from electrical engineering where the original use referred to checking out the functional design of an electrical circuit by populating a “breadboard” with

components to verify that the design operated as anticipated. Other terms come from mechanical engineering, referring primarily to units that are subjected to different levels of stress under testing, e.g., qualification, protoflight, and flight units. The first step in developing a uniform TRL



assessment (see figure 1.5) is to define the terms used. It is extremely important to develop and use a consistent set of definitions over the course of the program/project.”

### **1.3.2 Heritage Systems**

“Note the second box particularly refers to heritage systems (figure 1.5). If the architecture and the environment have changed, then the TRL decreases to TRL 5—at least initially. Additional testing may need to be done for heritage systems for the new use or new environment. If in subsequent analysis the new environment is sufficiently close to the old environment or the new architecture is sufficiently close to the old architecture, then the resulting evaluation could be TRL 6 or 7, but the most important thing to realize is that it is no longer at TRL 9. Applying this process at the system level and then proceeding to lower levels of subsystems and components identifies those elements that require development and sets the stage for the subsequent phase, determining the new TRL.”

### **References**

- (1) NASA. What are SmallSats and CubeSats? February 26, 2015. Revised August 6, 2017. <https://www.nasa.gov/content/what-are-smallsats-and-cubesats>
- (2) NASA Systems Engineering Handbook. NASA/SP-2016 6105 Rev. 2. <https://www.nasa.gov/feature/release-of-revision-to-the-nasa-systems-engineering-handbook-sp-2016-6105-rev-2>





## Chapter Contents

Chapter Glossary .....	ii
2.0 Complete Spacecraft Platforms .....	6
2.1 Introduction .....	6
2.1.1 Chapter Organizational Approach .....	6
2.2 State-of-the-Art – Small Spacecraft Platforms.....	7
2.2.1 Minisatellites (100 – 180 kg).....	7
2.2.2 Microsatellites (10 – 100 kg).....	8
2.2.3 Nanosatellites (1 – 10 kg).....	9
2.2.4 Picosatellites.....	10
2.3 Evolution of CubeSats.....	12
2.4 On the Horizon.....	13
2.5 Summary.....	13
References.....	21



## Chapter Glossary

(CAPSTONE)	Cislunar Autonomous Positioning System Technology Operations and Navigation Experiment
(COTS)	Commercial-off-the-Shelf
(ESA)	European Space Agency
(GEO)	Geostationary Equatorial Orbit
(IoT)	Internet-of-Things
(MEMS)	Microelectromechanical System
(MTBF)	Mean Time Between Failures
(NRHO)	Near Rectilinear Halo Orbit
(R&D)	Research and Development
(TDO)	Technology Demonstration Orbiter
(TRL)	Technology Readiness Level



## 2.0 Complete Spacecraft Platforms

### 2.1 Introduction

The availability of a functional spacecraft platform, with all the combined subsystem parts already integrated, has increased significantly since 2010 due to the higher demand and utility of SmallSats. This surge in SmallSat missions has supported readily available SmallSat platforms and a standardized process for obtaining an integrated bus. The past ten years of research and development has resulted in an abundance of commercial-off-the-shelf (COTS) assembled buses, where a demonstrated performance at a known cost can be delivered within a predicted schedule. Without needing to start the design from scratch, SmallSat buses can now be built and assembled into a mission with faster turnaround, which has ignited the SmallSat platform commercial industry.

These buses provide modular platforms for hosting payloads that can be ready to fly in a comparatively short amount of time. Complete spacecraft platforms can be used for a wide variety of missions, with integrated subsystems that are operable in a range of environmental and mission conditions. Two main options have emerged from the small spacecraft bus market in the last decade: turnkey bus solutions from CubeSat vendors who offer package “deals” with a sufficiently diverse portfolio of subsystems based around specific customer requirements; and COTS bus solutions for ready-made platforms that the customer obtains for their own integration, testing, and operation.

In performing a trade study to determine which design path to take, small satellite mission developers should take into account important Programmatic and Systems Engineering factors, such as:

- How well the systems meet functional and performance requirements.
- The mission’s key performance parameters (e.g. mass, volume, power, link budget, data rates) and how much margin they offer.
- The systems’/components’ flight heritage, Technology Readiness Level (TRL), and reliability, along with the level of Research and Development (R&D) effort required to integrate the system with existing and/or planned systems.
- The mission’s risk posture and how much development risk and performance risk are acceptable to the mission.
- Is it most important to meet performance requirements, cost, and/or schedule? What are the system or component production or procurement lead times, and what are the contractual mechanisms that will be used to procure the systems and ensure timely delivery if delays are encountered?

Design selection can be driven by unique mission constraints, manufacturing lead time, and documented reliability. All of these, and many more considerations, should be well understood for each trade space prior to down-selecting an option. Given mission system performance requirements for key performance parameters like mass, volume, power, link budget and data rate, a functional importance rating and risk-based trade study should be used to screen the many options available. In addition to functional performance, relevant flight heritage or Technology Readiness Level (TRL), production lead time, cost, and any available reliability data should be included in the trades, as these will drive the design for COTS or commercial support.

#### 2.1.1 Chapter Organizational Approach

This chapter follows the known NASA small spacecraft definitions though constrains the upper mass limit to 180 kg, which corresponded to the original ESPA secondary payload mass limit



(referred to as “ESPA-class”). The content on state-of-the-art small spacecraft buses is divided into the following categories:

1. Minisatellite 100 – 180 kg (2.2.1)
2. Microsatellite 10 – 100 kg (2.2.2)
3. Nanosatellite 1 – 10 kg (2.2.3)
4. Picosatellite <1 kg (2.2.4)
5. CubeSat Evolution (2.2.5)

Items 1 – 4 contain information on an overall description of the categorized bus, types of science missions, any recent or upcoming trends, and a table with a broad view of performance specifications from a variety of vendors. Vendor performance for each of these categories are found in tables 2-1, 2-2, 2-3, and 2-4. The SmallSat bus performance specifications included in the tables are: overall spacecraft envelope size, allocated payload mass and power, pointing capability, TRL, and any reference missions for these values. Pointing capability is provided in terms of pointing knowledge, how accurately the platform can measure its orientation and pointing control, and how accurately it can change its orientation.

Since the expanding assortment of CubeSats fall under both nanosatellite and microsatellite classifications, the terms are often used interchangeably. In this report, CubeSats are divided into their respective nanosatellite and microsatellite subsections. The term “CubeSat” refers to the accepted 1 – 12U platforms, “nanosatellite” to a spacecraft under 10 kg, and a “microsatellite” for spacecraft larger than 10 kg. Please refer to the Introduction of this report for more information on SmallSat classifications.

An examination of the evolution of CubeSats from 2010 – 2020 provides the reader with some information on smallsat mission trends which ultimately improves their overall capability. Data collected for this leverages information available “as is” on other publicly available sources. The appendix contains vendor specific information that hitherto was the body of preceding editions of this chapter. The intention is to add more companies in this section – as well as the tables – and the authors recognize that the list is non-exhaustive. The inclusion or exclusion of any vendors is not to be construed as a NASA endorsement - readers are encouraged to submit any missing information to the email in the Summary of this chapter for inclusion into the next revision.

The information described below is not intended to be exhaustive but provides an overview of current state-of-the-art technologies and their development status for a particular small spacecraft subsystem. It should be noted that TRL designations may vary with changes to mission requirements, payload-specific changes, reliability considerations, or changes to the environment in which performance was demonstrated. Readers are highly encouraged to reach out to companies for further information regarding the performance and TRL of described technology, as well as the basis for that determination. There is no intention of mentioning certain companies and omitting others based on their technologies or relationship with NASA.

## **2.2 State-of-the-Art – Small Spacecraft Platforms**

### **2.2.1 Minisatellites (100 – 180 kg)**

For decades, larger, non-containerized SmallSats have aptly demonstrated their capability in complex science missions and have been essential contributors to space science in the disciplines of astrophysics, Earth sciences, and heliophysics. They are equipped with more power (in-orbit and payload), have additional allocated payload mass, and carry more capable radios that can downlink more data than smaller spacecraft categories. It is common for these SmallSats to include propulsive capabilities, encrypted communications, and fine pointing that are beyond the reach of smaller containerized platforms. There is a market “pull” towards minisatellites given their enhanced capabilities; minisatellites are becoming more prominent in the low-Earth orbit

through Geostationary Equatorial Orbit (GEO) environments, and will likely have a more notable presence in deep space in the next five years. While the mass definition typically extends to around 600 kg, for the purposes of this report the mass limit for minisatellites is 180 kg, which is the limit for the readily available ESPA secondary launch opportunities.

Manufacture	Product	Vehicle Size (mm)	Payload Mass (kg)	Payload Power (W)	Pointing Control	Pointing Knowledge	T R L	Ref Mission	Citation
SFL	Dauntless	1000 x 1000 x 1000	< 500	Up to 1000	Unk.	Unk.	7-9	LEO2 (2017)	(1)
SFL	Nemo-150	600 x 600 x 600	< 70	>50	Unk.	Unk.	7-9	NEMO-HD (2020)	(2)
Redwire Space	MagicBus	965 x 660 x 610	50 – 220	Up to 150, option for 780	$\pm 0.15^\circ$ $3\sigma$	$0.01^\circ 3\sigma$	7-9	Kestrel Eye 1 (2017)	(3)
Surrey Satellite Technology	SSTL-Micro	450 x 340 x 340	< 65 kg	63 W	<0.1 degrees	< 0.05 degrees	7-9		(5)
Tyvak Nano-Satellite Systems	Mavericks Platform	560 x 560 x 230	Up to 250kg	180+	20 arcsec	10 arcsec	7-9		
Ball Aerospace (USA)	Ball Configurable Platform 100	$\leq 609$ x 711 x 965	70	100	$0.03^\circ - 0.10^\circ 3\sigma$	$0.03^\circ 3\sigma$	7-9	GPIM (2020)	

Minisatellites will continue to advance as component capability improves, and since they are able to provide missions with more substantial capabilities, they are ideal for demonstrating innovative technologies in space when stakeholders have sufficient funds to support them. It is now more common for larger small spacecraft to act as SmallSat dispensers, dropping a variety of SmallSats into particular orbits that a primary launch would not. Figure 2.1 is an example of a minisatellite platform.



*Figure 2.1: Mavericks MiniSat platform. Credit: Tyvak Nano-Satellite Technology, Inc.*

Table 2-1 lists available or in-development integrated minisatellite small spacecraft platforms and their specifications.

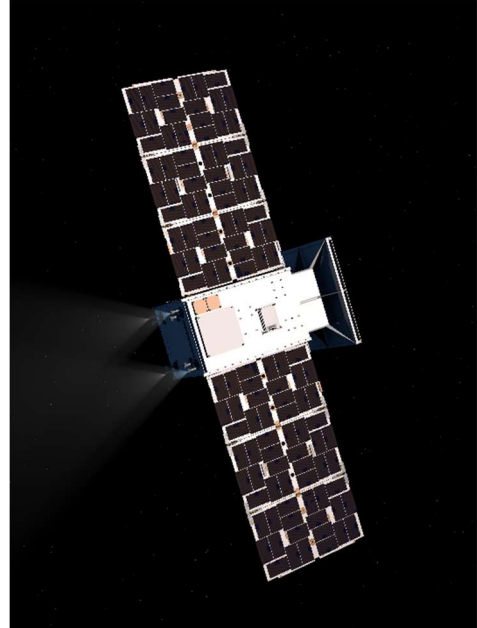
### 2.2.2 Microsatellites (10 – 100 kg)

The microsatellite has endured significant maturity since 2010 with a focus on improving SmallSat component technology. It is common for 50-70 kg spacecraft to demonstrate and test innovative capabilities and then use those new capabilities operationally on other missions. As with the term “minisatellite,” there are discrepancies with “microsatellite” mass limit as some portion of the space community may refer to microsatellite as large as 200 kg, encompassing “ESPA-class” satellites. Larger CubeSats such as 6U, 12U and up fall into this spacecraft mass category, and have started receiving more attention from NASA. Since 2017,

the use of the 6U form-factor in low-Earth orbit has more than tripled compared to its first space demonstration in 2014 with more than 140 6U platforms launched. According to nanosats.eu in 2020, there were 29 launches of 6U platforms that were involved with a variety of mission operations, including:

- Testing instruments for deep space technologies for future astrophysics missions
- Demonstrating technologies for higher accuracy data, or to achieve more significant science with inter-satellite links
- Commercial constellations for Earth observation data

The first 12U platform was launched in 2016, and since then, three were launched in 2019, two in 2020, and five 12U missions are planned to be launched in 2021. These 12U missions will demonstrate technology while also performing science data collection. The first two 12U spacecraft will be CubeSat platforms in a GTO environment and are part of the Technology Demonstration Orbiter (TDO-3 and TDO-4) missions for the United States Air Force Academy; TDO-1 was launched in July 2019 and TDO-2 in March 2020. The TDO missions successfully demonstrated an atmospheric modelling thesis (5). The Cislunar Autonomous Positioning System Technology Operations and Navigation Experiment (CAPSTONE) mission is a 12U lunar mission in a near rectilinear halo orbit (NRHO) that is slated for launch in October 2021. This microsatellite will characterize the unique orbit with specific power and propulsion requirements for future NRHO utility (20).



*Figure 2.2: Representation of CAPSTONE spacecraft travelling to Moon. Credit: Ball Aerospace.*

Microsatellite constellations are becoming more popular. Their potential is being recognized for upcoming missions like Internet-of-Things (IoT) communication infrastructure, in-space weather science collection, Earth observation data, and space observation to improve our understanding of deep space. HawkEye-360 has been periodically sending clusters of three ~15 kg spacecraft (based on the UTIAS NEMO platform) since December 2018. These are the first commercial spacecraft to demonstrate formation flying to develop an innovative class of radio frequency (6).

Table 2-2 (see below) lists available integrated microsatellite platforms and their specifications.

### **2.2.3 Nanosatellites (1 – 10 kg)**

This classification of microsatellites encompasses the classic CubeSat 1U and 3U platforms and is commonly used interchangeably with the term “CubeSat”. Primarily used for technology demonstrations following their inception in the early 2000s, nanosatellites are being used increasingly in other areas due to their relative low cost, short development time, and relative ease in which they can be deployed in small constellations. In 2020, there were 110 launched nanosatellites, a notable decrease from the 165 launched in 2019, with the slowdown likely caused by the COVID 19 pandemic.

The last ten years have witnessed a notable progression of the nanosatellite platform as it has expanded in both capability for increased mission complexity and physical dimensions to meet more complex needs. The first CubeSats that were built and launched were primarily technology demonstration and educational missions, and now they are used more for Earth science missions



and include more diverse CubeSat platforms. In-space CubeSat constellations have been a major contributor to CubeSats' growth as a science platform. Constellations like Planet Labs and Spire Global have ignited the nanosatellite/CubeSat expansion in low-Earth orbit since 2017. Of all CubeSat/nanosatellite launches since 2017, nearly 50% are 3U constellations (both Planet Labs and Spire Global). While most of these are in low-Earth orbit, CubeSats are starting to expand their operations beyond low-Earth orbit and into deep space.



Figure 2.3 (left to right): BCT XB3 spacecraft bus for the APL RAVAN mission (NASA); Standard 6U platform (GomSpace); M6P platform (NanoAvionics); and EnduroSat 1U and 3U spacecraft (EnduroSat).

Table 2-3 (see below) lists integrated nanosatellite platform specifications.

#### 2.2.4 Picosatellites

As described in the introduction, picosatellites, also known as picosats or FemtoSats, are defined as spacecraft with a total mass of 0.1 – 1 kg. In this classification, the PocketQube has been defined as half the size of a 1U CubeSat in 5 cm<sup>3</sup> dimensions, or 1P, where P = 1 PocketQube unit, one-eighth the volume of a CubeSat (14). The mass of these spacecraft vary from 0.15 – 0.28 kg and have been categorized as “1P,” “2P,” and “3P.” Table 2-4 describes the current specifications for picosatellite platforms that include PocketQubes and more the recent quarter-sized CubeSats (0.25 and 0.5U).

Table 2-4 lists integrated picosatellite platforms, reference missions and TRL.

Table 2-4: Picosatellite Platform Specifications								
Units (P or U)	Dimensions (mm)	Mass (kg)	Payload Mass (kg)	Power (W)	Payload Power (W)	TRL in LEO	Reference Mission	Citation
1P	50 x 50 x 50	0.15 – 0.28	0.1	0.25	Unk.	7-9	TRISAT, 2019	(8)
2P	50 x 50 x 114	0.5	0.3	1	0.5	7-9	ATL-1 & SMOG-P, 2019	(7)
3P	50 x 50 x 178	0.75	0.5	5	<5	7-9	NOOR 1-A & -B, 2019	(9, 10)



6P	40 x 50 x 300	0.85	0.8	Unk.	Unk.	7-9	STECCO, 2021	(11)
0.25U	100 x 100 x 28	0.2- 0.4	0.1	Unk.	Unk.	7-9	BEESAT (2018)	(12)
0.5U	55 x 55 x 100	0.5	0.3	2.5	1.75	7-9	ARCE-1 (2021)	(13)

Professor Twiggs from Stanford proposed the first PocketQube in 2009 for an academic evaluation of a cost-effective method for engaging students in space sciences. The first PocketQubes were launched in November 2013, on a Dnepr rocket via the Morehead Rome Femto Orbital Deployer attached to the UniSat-5 microsatellite (14). Since 2013, several companies and universities have shown an interest in PocketQube design, and by mid-2021, thirteen PocketQubes successfully completed in-space demonstration with five still in-orbit, while over 40 PocketQube missions are currently in development (15). The cost for a single 1P PocketQube spacecraft is around \$20k, based on a 1P PocketQube being one-eighth of a 1U CubeSat volume and thus one-eighth the cost; a 2P picosatellite is estimated to be 50% the cost of a 3U CubeSat mission (16). Due to this reduced cost, they have become popular for kick-starter companies and amateur radio satellite designers.

A clear limitation for these very small spacecraft is the ability to collect a wide variety of advanced science data, as these types of missions require high power for heavy data transmission and a fine ADCS for strict pointing requirements. However, picosatellites and PocketQubes are becoming more noticed for their ability to function as a coherent distributed group and usefulness in technology demonstrations. As low mass payloads with low power requirements, PocketQube/picosatellite constellations can achieve quite a bit for much less than CubeSat constellations, and are ideal platforms for IoT network connectivity and Earth and space observations. These ultra-small spacecraft have been used as technology demonstration platforms for imaging devices, communication systems, autonomy operations, and sensors. The focus of The Aerospace Corporation PICOSAT Program is to study very small spacecraft concepts, and they have launched eight <1 kg spacecraft that have all demonstrated innovative technologies.

Picosat constellations have become a recent addition to low-Earth orbit in the past few years and their increased presence has indeed bolstered their growth. The low cost of these small spacecraft is a benefit, and the constrained microelectromechanical system (MEMS) components can be customized and tested within the typical budget of a CubeSat mission. The SpaceBee 0.25U constellation by Swarm Technologies are the smallest two-way communications satellites that serve as a cost-effective, low data rate Internet of Things (IoT) network (17). As of July 2021, 112 SpaceBee spacecraft have been launched into low-Earth orbit (18). At TU Berlin, a picosatellite swarm mission consists of four 0.25U CubeSats (BEESAT-5 to BEESAT-8) with a mass of 0.375 kg each with a primary objective to demonstrate new UHF communication devices and an experimental GNSS receiver (12). The first four, launched March 2021, successfully demonstrated new technologies, and four more BEESATs are planned to launch in 2021 to verify other technologies. From the University of Boston, the Ad-hoc Network Demonstration for Spatially Extended Satellite-based Inquiry and Other Team Endeavors (ANDESITE) is a 6U CubeSat that deployed eight 0.38 kg "Sensor Node" spacecraft in June 2020 to act as a local network of magnetometers through the electrical currents that cause the Northern Lights (19).





## 2.3 Evolution of CubeSats

CubeSats were initially developed and adopted by the university science and engineering community as a means to provide hands-on experience to their students, complementing the many courses and degrees in engineering and other fields related to space offered by universities. CubeSats prospects for affordable access to space also quickly became a popular feature for government entities and industry, and the 1U – 3U CubeSat platform range was quickly utilized by all space enthusiasts. An endless application for CubeSats was quickly identified as more engineers and researchers found more CubeSat utility, making the form factor more diverse and complex. Capabilities such as greater data processing and transmission capacity, propulsion systems, optical communications, spacecraft autonomy, and inter-spacecraft navigation make a simple CubeSat more intricate.

As of 2021, the CubeSat spacecraft is a diverse platform that offers engineers, scientists, and researchers more volume, processing power, on-orbit capability, and science/data collection. The advancement of CubeSat systems and components has made even the smaller CubeSat platforms (1U-3U) more useful and advantageous since they were first introduced. Larger CubeSats are being favored as they offer more capability for complicated science and technology demonstrations. Another major shift in the evolution of CubeSats was in the type of missions the CubeSats were being designed for, as they have become more ubiquitous in both the space industry and their use in low-Earth orbit environments. A clear trend is that CubeSats are more scientific than they were in 2010. Since then, there has been a concentration in low-Earth orbit constellations that collect atmospheric data, Internet of Things (IoT) capability, and remote sensing.

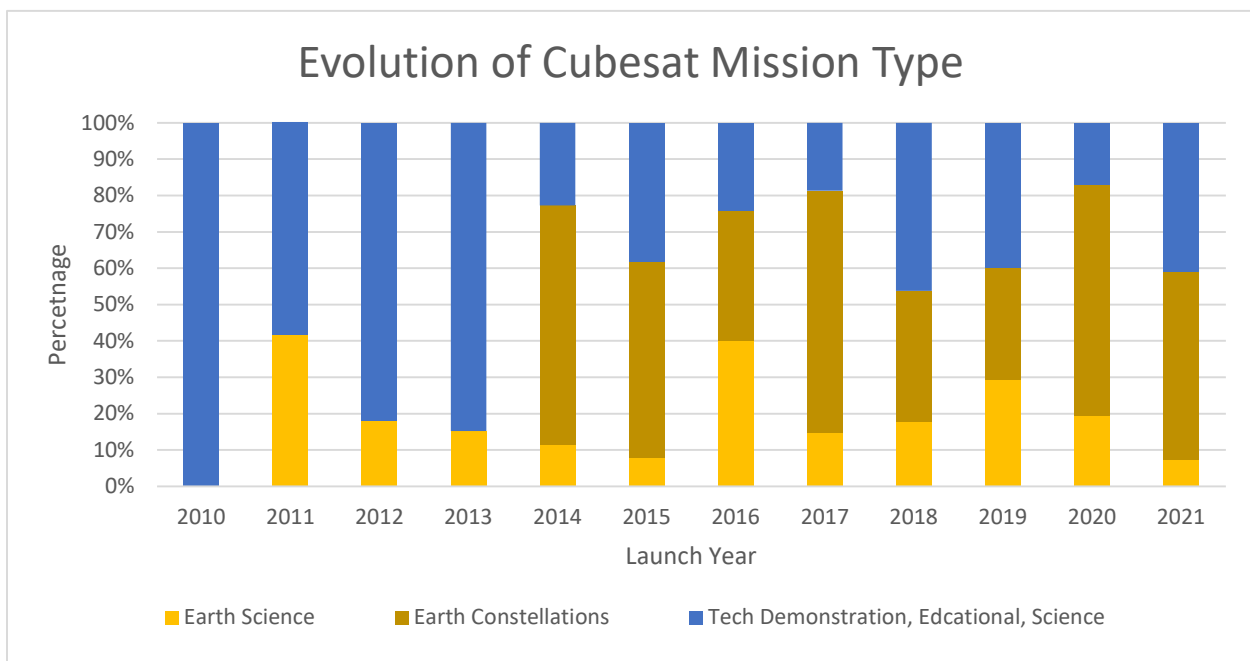


Figure 2.4: Evolution of CubeSat Mission Type. Credit: NASA.



## 2.4 On the Horizon

As spacecraft buses are combinations of the subsystems described in later chapters, it is unlikely there will be any revolutionary changes in this chapter that are not preceded by revolutionary changes in some other chapter. As launch services become even cheaper and more commonplace with the rise in dedicated SmallSats launches, the market will continue to expand allowing interested universities and researchers to purchase COTS spacecraft platforms as an alternative to developing and integrating SmallSats themselves. Another option is to use numerous turnkey solutions offered by SmallSat vendors who can customize and cater to customer constraints.

SmallSat subsystem technology will continue to mature and gain flight heritage, to produce improved next generation platforms offered by vendors. Platforms with increased performance will spark the interest of newer vendors as they emerge into the market. This was demonstrated in the PocketQube industry: the requirement to satisfy ultra-low mass and volume constraints enabled high-performance capabilities. As the industry grows, there will likely be key technological advancements in SmallSat in-space propulsion, pointing and navigation control, optical communications, radiation tolerance, and radiation hardening. Subsystems described in other chapters in this report include details on radiation testing (see Structures chapter), but a subsystems' mean time between failures (MTBF) and overall system reliability will become key design criterion as the sample groups become large enough to be statistically significant. These advancements will prepare SmallSats for their presence beyond low-Earth orbit, which is a new trend that is expected to increase in the future.

MarCO's two 6U spacecraft presence in deep space sparked an interest in designing SmallSats for environments beyond low-Earth orbit. There are several upcoming, larger CubeSat missions designed for GTO, GEO, lunar, and heliocentric orbits. The Aerodynamic Deorbit Experiment is a 1U designed at Purdue University that will enter in GTO to characterize the performance of a deployable drag device to accelerate the deorbit of small satellites (21). Expected to launch in 2021, SpectroCube is a 6U European Space Agency (ESA) mission that will measure photochemical changes of organic molecules exposed to high solar ultraviolet, and energetic particle radiation in a highly elliptical orbit (22). GTOSat is a 6U CubeSat expected to launch in 2021 that will study Earth's dynamic radiation belts and collect the first ever data on Earth's magnetosphere, as well as demonstrate the utility of CubeSats in GEO (23). The upcoming launch of Artemis I at the end of 2021 will send thirteen 6U MicroSats into deep space, where twelve will have innovative propulsive systems. Of these twelve, six of the propulsive 6U spacecraft will orbit the Moon to demonstrate technologies and collect science data, and the remaining seven will escape into a heliocentric orbit that will also demonstrate innovative small spacecraft technology and send science data back to Earth.

With the establishment of the Rideshare Office in 2020, NASA SMD is in the process of developing ESPA class missions that can take advantage of available rideshares. This interest in ESPA class spacecraft is beneficial to all four NASA divisions-- Heliophysics, Astrophysics, Earth Science, and Planetary Science-- as each are invested in advancing SmallSat missions. Several SmallSat missions are actively working on rideshares (or dedicated rides) to their destinations in 2022 – 2024 (24). Rideshares will greatly enhance the deep space presence and science data collection of SmallSats.

## 2.5 Summary

A number of vendors have pre-designed fully integrated small spacecraft buses that are space rated and available for purchase. Due to the small but growing market they are willing to cooperate with customers to customize their platforms. This archetype is continued in the CubeSat form factor, but a new design concept has also emerged: due to the CubeSat standard interfaces,



many interchangeable standardized components are available, leveraging consumer electronics standards to approach the plug-and-play philosophy available for terrestrial PCs and computer servers. In particular, CubeSat communications and guidance, navigation and control subsystems have matured significantly. Small spacecraft vendors are building preconfigured platforms with smaller and larger variants to meet the majority of potential smallsat needs. Since the 2020 edition of this report there are more buses available that offer scalability, integrated propulsion, and proven avionics. The maturity of these subsystems will facilitate high TRL COTS CubeSats for lunar or deep space environments. A reasonable conclusion is that a systems-level examination is required to determine the optimum architecture for a given scientific and/or operational objective (25).

SmallSat constellations will likely grow in number as they can significantly improve our understanding of the space environment with their ability to capture simultaneous, multipoint measurements with identical instruments across a large area (26). There will also be an improved coordination between spacecraft for inter-satellite navigation and communication which will benefit future complex CubeSat science missions. The current trend of enlarging the CubeSat platform bolsters the idea that they will continue to expand in physical dimensions and scalability for the continuous proliferation of their complex design. When CubeSats were first launched, their main advantage was affordable access to space, but now they are becoming more capable methods for space research.

For feedback solicitation, please email: [arc-sst-soa@mail.nasa.gov](mailto:arc-sst-soa@mail.nasa.gov). Please include a business email so someone may contact you further.



Table 2-2 Microsatellite Platform Specifications from Commercial Providers

Manufacture	Product	Vehicle Size (mm)	Payload Mass (kg)	Payload Power (W)	Pointing Control	Pointing Knowledge	TRL in LEO	Ref mission and Citation	
AAC Clyde Space (Sweden)	EPIC 6U	Unk	4.5U	120 (peak)	<0.05°	0.002°/s	7-9	NSLSat-1 (2019)	(56)
	EPIC 12U – 16U	Unk	8U – 12U	240 (peak)	Up to 0.05	0.002°	5-6		
Argotech (Italy)	Hawk-6	365 x 239 x 109	2.5	50 (peak)	0.007 deg 1-sigma	0.011 deg 1-sigma	5-6	LICIACube (2021)* ArgoMoon (2021)*	
	Hawk-12	365 x 239 x 219	7	50 (peak)	0.007 deg 1-sigma	0.011 deg 1-sigma	5-6		(37)
Artemis Space Technologies (Cyprus)	XPLORA	48U	Unk	250	Unk	0.01 arcsec	5-6		(38)
Berlin Space Technologies (Germany)	LEOS-50	600 x 600 x 300	50	20	1	10 arcsec	7-9	Kent Ridge 1 (2015)	
	LEOS-50MR	570 x 570 x 400	15-30kg	25	Unk.	Unk.	5-6		(27)
	LEOS-100	600 x 600 x 800	50-75	60-200	1	2.5 arcsec	7-9	DLR-TUBSAT (1998)	
Blue Canyon Technologies (USA)	XB6	335 x 238 x 115	4	140 (peak)	±0.002°	±0.002°	7-9	Asteria (2016) , TEMPEST-D (2018)	
	XB12	335 x 238 x 228	8	140 (peak)	±0.002°	±0.002°	5-6	XVI (2021)	(28)
	X-SAT Venus	470 x 470 x 230	90	350	±0.002°	±0.002°	5-6	Yam4 (2021)	
C3S Electronics Development (Hungary)	12U	226.3 x 226.3 x 366	14	165 (peak)	<1°	0.00833°	5-6		(30)
	6U	226.3 x 100 x 366	Unk	165 (peak)	<1 °	0.00833°	5-6		(30)
EnduroSat (Bulgaria)	6U	970 x 197 x 223	7.2 – 7.8	10 – 30	< 0.1°	Unk	7-9	Spartan (2021)	(31)
	12U	Unk	14-16	20-45	Unk	Unk	5-6	(ref)	
GomSpace (Denmark)	6U	Unk	8	12 (Ave)	1°	Unk	7-9	GOMX-4A&B (2018)	
	8U	Unk	4	Unk	0.07	0.05	5-6		(32)



	12U	Unk	16	Unk	0.07	0.05	5-6	GOMX-5* (2022)	(33)
	16U	Unk	16	Unk	0.07	0.05	5-6		(34)
Hemeria (France)	8U	Unk	5	15 (Ave)	<5	Unk	5-6		(35)
	12U	Unk	10	30 (Ave)	<1	Unk	7-9		(36)
	16U	Unk	8	45 (Ave)	<0.1	Unk	5-6		(35)
Ingegneria, Marketing, Tecnologia, IMT srl (Italy)	Nadir Platform	320 x 320 x 460	10	15 (EOL)	1°	0.5°	5-6		(57)
ISISPACE (The Netherlands)	12U Bus	Unk	Unk	40	0.05°	0.02°	7-9		
	6U Bus	Unk	6	10	< 0.05°	< 0.05°	7-9	Brik-II (2021)	(40)
NanoAvionics (Lithuania)	Multifunctional 6U platform "M6P"	380 x 189 x 236	7.5	32	< 0.2°	< 0.05°	7-9	Bravo and Charlie (2021) LacunaSat-1 (2018)	(41)
	Multifunctional 12U platform "M12P"	226 x 226 x 381	17.5	30	< 0.1°	< 0.05°	5-6		(42)
	Multifunctional 16U platform "M16P"	226.3 x 226.3 x 494	16.5	40	< 0.1°	< 0.05°	5-6		
NearSpace Launch (USA)	6U FastBus	1 x 6U	Unk	>100	Unk	Unk	7-9		(43)
		2 x 3U	Unk	>100	Unk	Unk	7-9	ThinSat (2019)	(44, 45)
Open Cosmos (United Kingdom)	6U	Unk	6	50	Up to 0.01°	40 arcsec 10°s slew rate	5-6		(46)
	12U	Unk	12	100	Up to 0.01°	40 arcsec 10°/s slew rate	5-6	MANTIS (2021)*	(46)
Orbital Astronautics (United Kingdom)	ORB-6	6U	6.5	400 (Peak)	0.1°	0.01°	5-6	Guardian Constellation (2022) (48)	(48)
	ORB-12	12U	13.5	Unk	Unk	Unk	5-6		(48)
	OB-16	16U	19	Unk	Unk	Unk	5-6		(48)



Redwire Space (USA)	12U	Up to 221 × 195 × 192	4U – 7U	84.3 (EOL)	±0.1° 3σ	<10 m	5-6		
Sitael (Italy)	S-50	340 x 340 x 660	20	26	Up to 0.1	<0.01 arcsec	7-9	ESEO (2018)	(49)
	S-75	320 x 320 x 400	20	< 30	Up to 0.1	Up to 0.009	7-9	uHET (2021)	(51)
SkyLabs	NANOSky I 6U	226 x 100 x 366	6	<150	Unk	Unk	5-6		(50)
	NANOSky I 24U	200 x 200 x 500	10-20	<300	Unk	Unk	5-6		(50)
Space Information Laboratories (USA)	Chameleon 6U – 27 U, Open, Modular, Scalable, and Reconfigurable Bus	220x200x300	12 - 30	30 - 61	<0.1	<0.003	5-6		(55)
Sputnix (Russia)	SXC6 6U	100 x 226.3 x 366	6	35	< 0.1°	Unk	7-9	Zorkiy (2021)	(52)
Tyvak NanoSatellite Technology (USA)	TRESTLES 6U	Unk	3	180	Unk	Unk	7-9	Tyvak-0129 (2019), Tyvak-0130 (2021)	(53)
	TRESTLES 12U	Unk	13	180	Unk	Unk	5-6	CASTONE (2021)*	(53, 58)
UTIAS SLF (Canada)	SPARTAN 6U	100 x 200 x 360	6	160	< 2°	< 2°	7-9	Kepler (2020)	(59)
	JAEGER 12U	200 x 200 x 360	12	< 76W h/ orbit, 215 W peak	2°	10 arcsec/ 1 arcsec	7-9	NORSAT-3 (2017)	
	JAEGER 16U	200 x 200 x 450	24	< 76W h/n orbit, 215 W peak	2°	10 arcsec/ 1 arcsec	5-6		
	Next-generation Earth Monitoring and Observation (NEMO)	200 x 300 x 440	12	160 (peak)	<2°	10 arcsec/ 1 arcsec	7-9	NEMO-AM (2014) NORSAT-1 & -2 (2017)	(60, 61)
	DEFIANT	300 x 300 x 400	Up to 30	< 65	< 2°	< 2°	7-9	HawkEye-360 Constellation (2018-2021)	(62)



Table 2-3 Nanosatellite Platform Specifications from Commercial Providers

Manufacturer	Product	Vehicle Size (mm)	Payload Mass (kg) or Volume (U)	Payload Power (W)	Point Control	Pointing Knowledge	TRL in LEO	Ref Missions and Citation	
AAC Clyde Space (Sweden)	EPIC 1U	Unk	0.3U	15 (peak)	< 5°	0.02°/s	7-9	MRIC Sat-1 (2021)	(63, 64)
	EPIC 3U	Unk	Unk	120 (peak)	< 0.1°	0.005°/s	7-9	IOD-1 GEMS (2019)	
Blue Canyon Technologies (USA)	XB3	335 x 115 x 112	2	Up to 60	±0.002°	±0.002°	7-9	RAVEN (2016)	
C3S Electronics Development (Hungary)	3U	100 x 100 x 340.5	4.7	35 (peak)	< 1°	0.00833°	7-9	RADCUBE (2021)	(65, 66)
EnduroSat (Bulgaria)	3U	970 x 970 x 173	1.7U	10 – 15	< 0.1 – 1°	9	5-6		(67)
	1.5U	Unk	0.950	0.9	Unk	Unk	5-6		(68)
	1U	970 x 970 x 108	0.950	900 mW	Up to 3°	9°	7-9	EnduroSat-1 (2018)	(69)
GomSpace (Denmark)	GomS-1U	Unk	1	3.4 (peak)	Unk	Unk	7-9		(70)
	2U	100 x 100 x 200	90 x 90 x 120	1.33			7-9	GOMX-1 (2013), GOMX-2 (2014)	



	GomS-3U	Unk	2	8 (peak)	Unk2.5°	2°	7-9	GOMX-3 (2015)	
Gumush (Turkey)	n-ART Extreme	100 x 100 x 340.5	1.6	4 10 Continuous	<2°	<0.05	5-6		(71)
	n-ART 3U	100 x 100 x 340.5	2.2	Up to 40	20°	<1°	5-6		(71)
Ingegneria, Marketing, Tecnologia, IMT srl (Italy)	3U	100 x 100 x 300	< 6	3	10°	5°	5-6		(72)
ISISpace (The Netherlands)	1U Bus	100 x 100 x100	0.7	400 mW	Unk	Unk	7-9	FunCube-1 (2014)	
	3U Bus	Unk	Up to 4	105	10° (in sunlight)	Unk	7-9	NAPA-1 (2020)	
MSS (USA)	Altair1	100 x 100 x 600	14	Unk	Unk	Unk	7-9	ALTAIR1 (2017)	
NanoAvionics (Lithuania)	Multifunctional 3U platform "M3P"	Unk	3	20	up to 0.1°	0.05°	7-9	Lithuania-2 (2017)	
Near Space Launch (USA)	3U FastBus	100 x 100 x 340.5	Unk	<40	Unk	Unk	7-9	SHARC (2017), TSAT (2014), GEARS1 (2015)	
	2U FastBus	100 x 100 x 227	Unk	<40	Unk	Unk	7-9	Asgardia-1 (2017)	
	1U FastBus	100 x 100 x 113.5	Unk	<40	Unk	Unk	7-9	MakerSat-1 (2020)	





OpenCosmos (Spain)	3U	100 x 100 x 300	2	25	1°	Unk	7-9	LacunaSAT-1 (2021)	
Orbital Astronautics (United Kingdom)	ORB-3	100 x 100 x 300	3	160 (peak)	<0.1°	<0.01°	5-6		(73)
SatRevolution (Poland)	NanoBus 3U	100 x 100 x 300	Unk	50 (peak)	<1°	<1°	7-9	SW1FT (2020) STORK-1 (2021)	
	Pre-Uni Bus 1U, Modular up to 2U	100 x 100 x 100	Unk	5	2°	0.5°	5-6		
	Swiatowid 2U Platform	106.7 x 107.7 x 227	Unk	Unk	2°	Unk	5-6		(74)
SkyLabs	NANOSky I 3U	100 x 100 x 341	2.5	25	Unk	Unk	7-9	TRISAT (2020)	
Spacemanic (Slovakia)	1U	100 x 100 x 113.5	0.52	0.4	Unk	1° and better (up to 0.1°)	7-9	GRBAAlpha (2021)	(75, 76)
	3U	100 x 340 x 100	2.11	0.6	+/- 3°	1° and better (up to 0.1°)	5-6		(75)
UTIAS SFL (Canada)	THUNDER 3U	100 x 100 x 340	< 3	62 (peak)	2°	10 arcsec	7-9	CanX-2 (2008), CanX-7 (2016)	



## References

- (1) Nicholas Sciuлло-Velenosi, Thermal Design and Analysis Methodologies Applied to the DAUNTLESS Bus and GHGSat-C Microsatellite, 2018, Thesis, Institute for Aerospace Studies University of Toronto
- (2) Clark, Stephen. Spaceflight now: After weather delays, Arianespace delays Vega launch to recharge batteries. [Online] 07 2020. <https://spaceflightnow.com/2020/07/01/after-weather-delays-arianespace-pauses-vega-launch-operations-to-recharge-batteries/>.
- (3) Kestrel Eye. ePortal Directory. [Online] 2018. Accessed: June 2018. <https://directory.eoportal.org/web/eoportal/satellite-missions/k/kestrel-eye>.
- (4) Surrey Satellite Technology . "Launched Missions." [Online] 2021. Accessed: July 16, 2021. <https://www.sstl.co.uk/space-portfolio/launched-missions>
- (5) A. Garges, Space and Missile Systems Center Public Affairs. "Multi-manifest Satellite Vehicles TDO-3 and TDO-4 Ready for Integration." [Online]. May 10, 2021. Accessed July 16, 2021. <https://www.losangeles.spaceforce.mil/News/Article-Display/Article/2602337/multi-manifest-satellite-vehicles-tdo-3-and-tdo-4-ready-for-integration/>
- (6) European Space Agency. "HawkEye 360 Pathfinder Cluster Mission to identify RFI locations." eoPortal Directory, Satellite Missions. [Online] <https://eoportal.org/web/eoportal/satellite-missions/h/hawkeye>
- (7) P. Stoetzer. "SMOG-P and ATL-1 Designated Magyar-OSCAR 105 (MO-105) and Magyar-OSCAR 106 (MO-106)." December 19, 2019. [Online] Accessed: August 27, 2021. <https://www.amsat.org/smog-p-and-atl-1-designated-magyar-oscar-105-mo-105-and-magyar-oscar-106-mo-106/>
- (8) D. Messier. "Rocket Lab Launches Satellites, Tests Next-Gen Reusable Booster." December 6, 2019. [Online] Accessed: august 27, 2021. <http://www.parabolicarc.com/tag/trsi-sat/>
- (9) "NOOR 1A, 1B (Unicorn 2B, 2C)." [Online] Accessed: July 16, 2021. [https://space.skyrocket.de/doc\\_sdat/noor-1.htm](https://space.skyrocket.de/doc_sdat/noor-1.htm)
- (10) Alba Orbital. "Unicorn-2: The world's most powerful PocketQube launch." October 24, 2018. [Online] Accessed: August 27, 2021. <http://www.albaorbital.com/new-blog/2018/7/19/unicorn-2-the-worlds-most-powerful-pocketqube-launch>
- (11) Sapienza Università di Roma. "Sapienza in the sky with Stecco." March 22, 2021. [Online] Accessed: July 16, 2021. <https://www.uniroma1.it/en/notizia/sapienza-sky-stecco>
- (12) F. Baumann. "BEESAT-5/-6/-7/-8." March 22, 201. [Online] Accessed: July 16, 2021. [https://www.raumfahrttechnik.tu-berlin.de/menue/research/current\\_projects/beesat\\_5\\_6\\_7\\_8/parameter/en/](https://www.raumfahrttechnik.tu-berlin.de/menue/research/current_projects/beesat_5_6_7_8/parameter/en/)
- (13) University of South Florida, College of Engineering News Room. "SATELLITES ENGINEERED BY IAE STUDENTS, FACULTY LAUNCH ON WORLD RECORD MISSION." 2021. [Online] Accessed: August 28, 2021.
- (14) Wikipedia. "PocketQube." July 24, 2018. [Online] Accessed: August 28, 2018. <https://en.wikipedia.org/wiki/PocketQube>
- (15) E. Kulu. "PocketQubes." [Online] Accessed: July 15, 2021. <https://www.nanosats.eu/cubesat>
- (16) R J Twiggs, J G Jernigan, L R Cominsky, B K Malphrus, BS Silverman, K Zack, S McNeil, W Roach-Barrett, and T-LogoQube Team. "The PocketQube Concept." California State Polytechnic University: s.n., 2014. CubeSat Workshop.
- (17) J. Schertz: "Swarm Preparing for 150 CubeSat Constellation" 01/19/2019, The Space Research



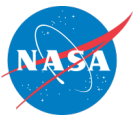
- (18) Gunter's Space Page. "SpaceBEE 10, ..., 180." [Online] Accessed: July 16, 2021. [https://space.skyrocket.de/doc\\_sdat/spacebee-10.htm](https://space.skyrocket.de/doc_sdat/spacebee-10.htm)
- (19) European Space Agency. "ANDESITE 6U CubeSat Auroral Plasma Science Mission of Boston University." eoPortal. [Online] Accessed July 16, 2021. <https://directory.eoportal.org/web/eoportal/satellite-missions/content/-/article/andesite>
- (20) NASA. "What is CAPSTONE?" July 31, 2020. [Online] Accessed: July 13, 2021. [https://www.nasa.gov/directorates/spacetech/small\\_spacecraft/capstone](https://www.nasa.gov/directorates/spacetech/small_spacecraft/capstone)
- (21) ADE (Aerodynamic Deorbit Experiment)." Purdue University, Missions. [Online] Accessed: July 14, 2021. <https://engineering.purdue.edu/CubeSat/missions/ade>
- (22) A. Elsaesser, F. Merenda, R. Lindner, R. Walker, S. Buehler, G. Boer, A. Villa, Y. Hallak, F. Aguado, E. Alberti, B. Wood. "SpectroCube: a European 6U nanosatellite spectroscopy platform for astrobiology and astrochemistry, Acta Astronautica, Volume 170, 2020, Pages 275-288, ISSN 0094-5765, <https://doi.org/10.1016/j.actaastro.2020.01.028>.
- (23) NASA. "GTOSat: A 6U CubeSat in Geosynchronous Transfer Orbit to Study Radiation Belt Dynamics." November 12, 2020. [Online] Accessed: July 14, 2021. <https://catalog.data.gov/dataset/gtosat-a-6u-cubesat-in-geosynchronous-transfer-orbit-to-study-radiation-belt-dynamics>
- (24) F. Tan and N. Khalil. "NASA Science Mission Directorate SmallSat Coordination Group, State of NASA Science with SmallSats." 2021. 35th Annual Small Satellite Conference.
- (25) National Research Council. 2000. The Role of Small Satellites in NASA and NOAA Earth Observation Programs. Washington, DC: The National Academies Press. doi: 10.17226/9819.
- (26) NASA. "10 Things: CubeSats — Going Farther." February 5, 2019. [Online] Accessed: July 14, 2021. <https://solarsystem.nasa.gov/news/834/10-things-cubesats-going-farther/>
- (27) Berlin Space Technologies. "LEOS-50MR." [Online] Accessed: July 16, 2021. <https://www.berlin-space-tech.com/portfolio/leos-50mr/>
- (28) "XVI (Link-16)." Gunter's Space Page. [Online] Accessed: July 16, 2021. [https://space.skyrocket.de/doc\\_sdat/xvi.htm](https://space.skyrocket.de/doc_sdat/xvi.htm)
- (29) "TAM 4." Gunter's Space Page. [Online] Accessed: July 16, 2021. [https://space.skyrocket.de/doc\\_sdat/yam-4.htm](https://space.skyrocket.de/doc_sdat/yam-4.htm)
- (30) Complex Systems and Small Satellites. "3U-12U Platforms." [Online] Accessed: July 16, 2021. Gunter's Space Page. [Online] Accessed: July 16, 2021.
- (31) EnduroSat. "Commercial space services redefined." July 1, 2021. [Online] Accessed: July 16, 2021. <https://www.endurosat.com/news/commercial-space-services-redefined/>
- (32) GomSpace. Datasheet, "8U PLATFORM."
- (33) GomSpace. "ESA and GomSpace sign contract for continuation of the GOMX-5 mission." October 2, 2020. [Online] Accessed: July 16, 2021. <https://news.cision.com/gomspace-a-s/r/esa-and-gomspace-sign-contract-for-continuation-of-the-gomx-5-mission,c3202464>
- (34) GomSpace. Datasheet, "16U PLATFORM."
- (35) Hermia. "range of Nanosatellites." [Online] Accessed: July 16, 2021. [https://www.hemeria-group.com/wp-content/uploads/2019/07/Datasheet-Nanosat-UK\\_versionfinale.pdf](https://www.hemeria-group.com/wp-content/uploads/2019/07/Datasheet-Nanosat-UK_versionfinale.pdf)
- (36) C. Henry. "French component suppliers demo constellation hardware with ANGELS cubesat." <https://spacenews.com/french-component-suppliers-demo-constellation-hardware-with-angels-cubesat/>
- (37) ArgoTech. Small Satellites Unit. <https://www.argotec.it/online/what-we-do/small-satellite-unit/>
- (38) Atermis Space. "Artemis XPLORA Platforms Range." [Online] Accessed: July 16, 2021. <https://www.spaceartemis.com/satellite-platforms/>
- (39) ISISPACE. "Brik-II first signals received." SpaceNews. July 5, 2021. [Online] Accessed July 16, 2021. <https://www.isispace.nl/news/brik-ii-first-signals-received/>



- (40) Nanoavionics. “Bravo – NanoAvionics adds satellite twin to Aurora Insight’s global wireless spectrum mission.”
- (41) Nanoavionics. “NanoAvionics Selected by Thales Alenia Space to Build the First Two Satellite Buses for Omnispace Constellation.” [Online] Accessed: July 16, 2021. <https://nanoavionics.com/news/bravo-nanoavionics-adds-satellite-twin-to-aurora-insights-global-wireless-spectrum-mission/>
- (42) [Online] Accessed: July 16, 2021 <https://nanoavionics.com/press-releases/nanoavionics-selected-by-thales-alenia-space-to-build-the-first-two-satellite-buses-for-omnispace-constellation/>
- (43) NearSpace Launch. “NSL Heritage.” [Online] Accessed July 16, 2021. <https://www.nearspacelaunch.com/pages/heritage>
- (44) NearSpace Launch. “NSL Constellation – ThinSat.” [Online] Accessed July 16, 2021. <https://www.nearspacelaunch.com/pages/constellation-solutions-thinsat>
- (45)
- (46) Open Cosmos. “A Revolution in Space Technology: A 3U, 6U, a12U and small-satellite platforms.” [Online] Accessed: July 16, 2021. <https://www.open-cosmos.com/satellites>
- (47) NewSpace Index. OrbAstro (Guardian). [Online] Accessed July 16, 2021. <https://www.newspace.im/constellations/orbastro>
- (48) Orb Astro. Satellites. [Online] Accessed: July 16, 2021. <https://orbastro.com/satellites/>
- (49) “ESEO student satellite successfully launched to space.” March 12, 2018. [Online] Accessed: August 31, 2021. [https://www.esa.int/Education/ESEO/ESEO\\_student\\_satellite\\_successfully\\_launched\\_to\\_space](https://www.esa.int/Education/ESEO/ESEO_student_satellite_successfully_launched_to_space)
- (50) Skylabs. “Satellite platforms.” [Online] Accessed: August 31, 2021. <https://www.skylabs.si/products/satellite-platforms/>
- (51) µHETSat. Gunter’s Space Page. [https://space.skyrocket.de/doc\\_sdat/myhetsat.htm](https://space.skyrocket.de/doc_sdat/myhetsat.htm)
- (52) Sputnix, LLC. Technical datasheet, “CUBESAT NANOSATELLITE PLATFORM.” [Online] Accessed: August 31, 2021. <https://sputnix.ru/en/satellites/in-orbit/cubesat-6u>
- (53) Tyvak Nano-Satellite Technologies. “Platforms.” [Online] Accessed: August 31, 2021. <https://www.tyvak.com/platforms/>
- (54) SPACE INFORMATION LABORATORIES. “SIL Chameleon 12U to 27U OMSR Flexible Satellite Bus” Bus to Payload ICD SIL Document Number 501767, 1/4/2020
- (55) Space Information Laboratories. “CHAMELEON 6U to 27U OMSR BUS.” [Online] Accessed: August 31, 2021. <https://www.spaceinformationlabs.com/products/chameleon/>
- (56) AAC Clyde Space. “AAC Clyde Space confirms successful launch of NSLSat-1.” July 14, 2019. [Online] Accessed: August 31, 2020. <https://www.aac-clyde.space/latest/6-successful-launch-of-nlsat-1>
- (57) Ingegneria, Marketing, Tecnologia. “Nadir Platform.” [Online] Accessed: August 31, 2020. <https://imtsrl.it/nadir.html>
- (58) “CAPSTONE, a small cubesat bound for the moon, is preparing for an October launch.” August 24, 2021. [Online] Accessed: September 1, 2021. <https://www.space.com/capstone-cubesat-moon-mission-october-2021-launch-prep>
- (59) SFL. “Nanosatellites: Kepler.” June 17, 2020. [Online] Accessed: July 31, 2020. [https://www.utias-sfl.net/?page\\_id=3344](https://www.utias-sfl.net/?page_id=3344)
- (60) SFL. “Microsatellites: NORSAT-1.” March 17, 2014. [Online] Accessed July 31, 2020. [https://www.utias-sfl.net/?page\\_id=1260](https://www.utias-sfl.net/?page_id=1260)
- (61) SFL. “Microsatellites: NEMO-HD.” March 17, 2014. [Online] Accessed July 31, 2020. [https://www.utias-sfl.net/?page\\_id=1233](https://www.utias-sfl.net/?page_id=1233)
- (62) SFL. “Microsatellites: NEMO-HD.” June 15, 2020. [Online] Accessed: July 31, 2020. [https://www.utias-sfl.net/?page\\_id=3305](https://www.utias-sfl.net/?page_id=3305)



- (63) AAC Clyde Space. EPIC 1U. [Online] 2020. Accessed: July 30, 2020. [://www.aac-clyde.space/epic-spacecraft/epic-1u](http://www.aac-clyde.space/epic-spacecraft/epic-1u)
- (64) J. Faleti. "MIR-SAT 1 Successfully Deploys from the ISS into Orbit." June 22, 2021. [Online] Accessed: August 31, 2021. <https://africanews.space/mir-sat-1-has-deployed-from-the-iss-into-orbit/>
- (65) Vega. "19th Vega mission demonstrates Arianespace's ability to deliver for the most innovative projects for the benefits of its clients." August 17, 2021. [Online] Accessed: August 24, 2021. <https://www.arianespace.com/press-release/vv19-vega-launch-success/>
- (66) Complex Systems and Small Satellites. "3U-12U Platforms." [Online] Accessed: July 24, 2021. <https://c3s.hu/3-12u-platforms/>
- (67) EnduroSat. "3U CubeSat Platform." [Online] Accessed: July 24, 2021. <https://www.endurosat.com/cubesat-store/cubesat-platforms/3u-cubesat-platform/>
- (68) EnduroSat. "1.5U CubeSat Platform." [Online] Accessed: July 24, 2021. <https://www.endurosat.com/cubesat-store/cubesat-platforms/1-5u-cubesat-platform/>
- (69) EnduroSat. "1U CubeSat Platform." [Online] Accessed: July 24, 2021. <https://www.endurosat.com/cubesat-store/cubesat-platforms/1u-cubesat-platform/>
- (70) GomSpace. "1U/2U Platform." [Online] Accessed: July 24, 2021. <https://gomspace.com/1u-2u-platform.aspx>
- (71) Gunmush. "N-Art Bus." [Online] Accessed: July 24, 2021. <https://gumush.com.tr/product/n-art-bus/>
- (72) Ingegneria, Marketing, Tecnologia. "Cubesat Platform." [Online] Accessed: July 24, 2021. <https://imtsrl.it/cubesat-3u.html>
- (73) Orb Astro. "ORB-3." 2021. [Online] Accessed: July 24, 2021. <https://orbastro.com/satellites/orb-3/>
- (74) CubeSat World. "Swiatowid Platform." 2021. [Online] Accessed: July 24, 2021. <https://cubesatworld.com/product/swiatowid-platform/>
- (75) Spacemind. "CubeSat platforms 1U – 24U." 2021. [Online] Accessed: July 24, 2021. <https://www.spacemanic.com/cubesat-platforms/>
- (76) Spacemind. "Scientific breakthrough for GRBAAlpha 1U CubeSat." August 11, 2021. [Online] Accessed: July 24, 2021. <https://www.spacemanic.com/news/scientific-breakthrough-for-grbalph-1u-cubesat/>



## Chapter Contents

Chapter Glossary .....	ii
3.0 Power .....	25
3.1 Introduction .....	25
3.2 State-of-the-Art – Power Generation .....	26
3.2.1 Solar Cells .....	26
3.2.2 Solar Panels & Arrays .....	28
3.3 On the Horizon – Power Generation .....	30
3.3.1 Multi-junction Solar Cells .....	30
3.3.2 Flexible Solar Cells .....	30
3.3.3 Organic Solar Cells .....	31
3.3.4 Fuel Cells .....	31
3.3.5 Nuclear Power .....	31
3.3.6 TPV .....	32
3.3.7 Alpha- and Beta-voltaics .....	32
3.3.8 Thermoradiative (TR) Cells .....	33
3.4 State-of-the-Art – Energy Storage .....	33
3.4.1 Secondary Li-ion and Li-po Batteries .....	37
3.5 On the Horizon – Energy Storage .....	40
3.5.1 Supercapacitors .....	40
3.5.2 Solid State Batteries .....	42
3.6 State-of-the-Art – Power Management and Distribution .....	42
3.7 On the Horizon – Power Management and Distribution .....	46
3.7.1 Modular Architecture .....	46
3.7.2 Wireless Power Transfer and Telemetry .....	46
3.8 Summary .....	46
References .....	47



## Chapter Glossary

(AFRL)	Air Force Research Laboratory
(BMS)	Battery Management System
(BOL)	Beginning-of-Life
(CFRPs)	Composite Fiber Reinforced Panels
(CIGS)	Cu(In,Ga)Se <sub>2</sub>
(COTS)	Commercial-off-the-Shelf
(EOL)	End-of-Life
(EPS)	Electrical Power System
(ESA)	European Space Agency
(GaN)	Galium Nitride
(GRC)	NASA Glenn Research Center
(KSC)	Kennedy Space Center
(Li-ion)	Lithium-ion
(LiCF <sub>x</sub> )	Lithium carbon monofluoride
(LiPo)	Lithium polymer
(LiSO <sub>2</sub> )	Lithium sulfur dioxide
(LiSOCl <sub>2</sub> )	Lithium thionyl chloride
(MIL)	Military
(QML)	Qualified Manufacturers List
(NiCd)	Nickel-cadmium
(NiH <sub>2</sub> )	Nickel-hydrogen
(OPV)	Organic Photovoltaic
(OSCAR)	Optical Sensors based on carbon materials
(PCB)	Printed Circuit Board
(PEASSS)	Piezoelectric Assisted Smart Satellite Structure
(PET)	polyethylene terephthalate
(PMAD)	Power management and distribution
(RHUs)	Radioisotopic Heater Units
(RTGs)	Radioisotope Thermoelectric Generators
(SABER)	Solid-state Architecture Batteries for Enhanced Rechargeability and Safety
(SWaP)	Size, Weight, and Power
(TPV)	Thermophotovoltaic



(TR) Thermoradiative  
(TRL) Technology Readiness Level  
(Wh kg<sup>-1</sup>) Watt hours per kilogram





## 3.0 Power

### 3.1 Introduction

The electrical power system (EPS) encompasses electrical power generation, storage, and distribution. The EPS is a major, fundamental subsystem, and commonly comprises a large portion of volume and mass in any given spacecraft. Power generation technologies include photovoltaic cells, panels and arrays, and radioisotope or other thermonuclear power generators. Power storage is typically applied through batteries; either single-use primary batteries, or rechargeable secondary batteries. Power management and distribution (PMAD) systems facilitate power control to spacecraft electrical loads. PMAD takes a variety of forms and is often custom-designed to meet specific mission requirements. EPS engineers often target a high specific power or power-to-mass ratio ( $\text{Wh kg}^{-1}$ ) when selecting power generation and storage technologies to minimize system mass impact. The EPS volume is more likely to be the constraining factor for nanosatellites.

EPS Engineers should note the fundamental differences between commercial-off-the-shelf (COTS) parts and space qualified parts while weighing those differences against spacecraft requirements. Military or Space (MIL/QML) parts need to go through a series of specific tests, while COTS go through a different, typically less stringent, set of tests. For example, Military or Space parts are typically tested and qualified to survive  $-55^{\circ}\text{C}$  to  $125^{\circ}\text{C}$ , while the alternative COTS requirement is  $-40^{\circ}\text{C}$  to  $85^{\circ}\text{C}$ . SmallSat missions, especially CubeSat missions, don't always have a need to be qualified for harsh environments from a temperature perspective, as well as other factors that are a part of the MIL/QML qualification process like radiation, reliability, etc. COTS parts are typically known to perform better than space rated parts while lacking the ability to survive in harsh environments. Another key limitation in QML parts is their lack of availability and slow revision timeline. Most electronic components don't come with a QML version, and when they are available, QML parts tend to be multiple generations behind their COTS equivalents. All in all, MIL/QML parts can be a limiting factor in SmallSat designs, from their relatively weaker technical capabilities, to the increased costs associated with incorporating them into a design. CubeSats and other SmallSats typically operate at low-Earth orbit in a mild environment for short periods of time, and so stringent qualification standards and high Technology Readiness Level (TRL) don't tend to carry a lot of weight on those missions.

In this chapter, the terms SmallSat and CubeSat are often used in the same context, however it is important for the reader to be aware of the distinctions between the two types of spacecraft. Please refer to the introduction of this report for more information on the categories of SmallSats. CubeSats fall under the category of both microsatellites and nanosatellites and CubeSat missions commonly use COTS parts for space applications. Due to their exclusive use in low-Earth orbit applications, CubeSats are more likely to incorporate COTS parts as they typically feature shorter mission lengths, more favorable environmental conditions, and as a result need less stringent standards when qualifying parts. Knowing the distinction between a CubeSat and a SmallSat is necessary in determining the potential for incorporating COTS parts in a SmallSat design.

The information described below is not intended to be exhaustive but provides an overview of current state-of-the-art technologies and their development status for a particular small satellite subsystem. It should be noted that TRL designations may vary with changes specific to payload, mission requirements, reliability considerations, and/or the environment in which performance was demonstrated. Readers are highly encouraged to reach out to companies for further information regarding the performance and TRL of described technology. There is no intention of



mentioning certain companies and omitting others based on their technologies or relationship with NASA.

### **3.2 State-of-the-Art – Power Generation**

Power generation on SmallSats is a necessity typically governed by a common solar power architecture (solar cells + solar panels + solar arrays). As the SmallSat industry drives the need for lower cost and increased production rates of space solar arrays, the photovoltaics industry is shifting to meet these demands. The standardization of solar array and panel designs, deployment mechanisms, and power integration will be critical to meet the desire of large proliferated constellations.

In SmallSat missions especially, cost and scheduling considerations are something that EPS engineers must pay attention to on a component level, and power generation components are no exception from this. When possible, choosing a pre-designed and qualified panel is preferred over designing unique solar panels to reduce the cost and schedule as well as unforeseen design and manufacturing issues. Companies that have capacity for mass production and automation are rare because space solar arrays, cells, and panels have always been a ‘boutique’ business; however, standardized designs have been appearing more often these days to meet the demands of highly proliferated constellations, with a couple examples being the OneWeb and StarLink constellations.

#### **3.2.1 Solar Cells**

Solar power generation is the predominant method of power generation on small spacecraft. As of 2021, approximately 85% of all nanosatellite form factor spacecraft were equipped with solar panels and rechargeable batteries. Limitations to solar cell use include diminished efficacy in deep-space applications, no generation during eclipse periods, degradation over mission lifetime (due to aging and radiation), high surface area, mass, and cost. To pack more solar cells into the limited volume of SmallSats and NanoSats, mechanical deployment mechanisms can be added, which may increase spacecraft design complexity, reliability, as well as risks. Photovoltaic cells, or solar cells, are made from thin semiconductor wafers that produce electric current when exposed to light. The light available to a spacecraft solar array, also called solar intensity, varies as the inverse square of the distance from the Sun. The projected surface area of the panels exposed to the Sun also affects power generation, and varies as a cosine of the angle between the panel and the Sun.

While single junction cells are cheap to manufacture, they carry a relatively low efficiency, usually less than 20%, and are not included in this report. Modern spacecraft designers favor multi-junction solar cells made from multiple layers of light-absorbing materials that efficiently convert specific wavelength regions of the solar spectrum into energy, thereby using a wider spectrum of solar radiation (1). The theoretical efficiency limit for an infinite-junction cell is 86.6% in concentrated sunlight (2). However, in the aerospace industry, triple-junction cells are commonly used due to their high efficiency-to-cost ratio compared to other cells. Figure 3.1 illustrates the available technologies plotted by energy efficiency at the beginning-of-life (BOL) performance.

The current state of the art for space solar cells are multijunction cells ranging from 3 to 5 junctions based on Group III-V semiconductor elements (like GaAs). SmallSats and CubeSats typically use some of the highest performing cells that provide efficiencies up to 29% and 32%, even though they have a substantially higher cost than terrestrial silicon solar cells (~19% efficient). Ultimately the size, weight and volume of smaller satellites may be the determining factor in choosing solar cell technology. Being a life-limiting component on most spacecraft, the end-of-life (EOL) performance at operating temperature is critical in evaluating their performance. Common factors



that degrade the functionality of solar cells include radiation exposure, coverglass/adhesive darkening, contamination, and mechanical or electrical failure.

This section individually covers small spacecraft targeted cells, fully-integrated panels, and arrays. Table 3-1 itemizes small spacecraft solar cell efficiency per the available manufacturers. Note the efficiency may vary depending on the solar cells chosen.

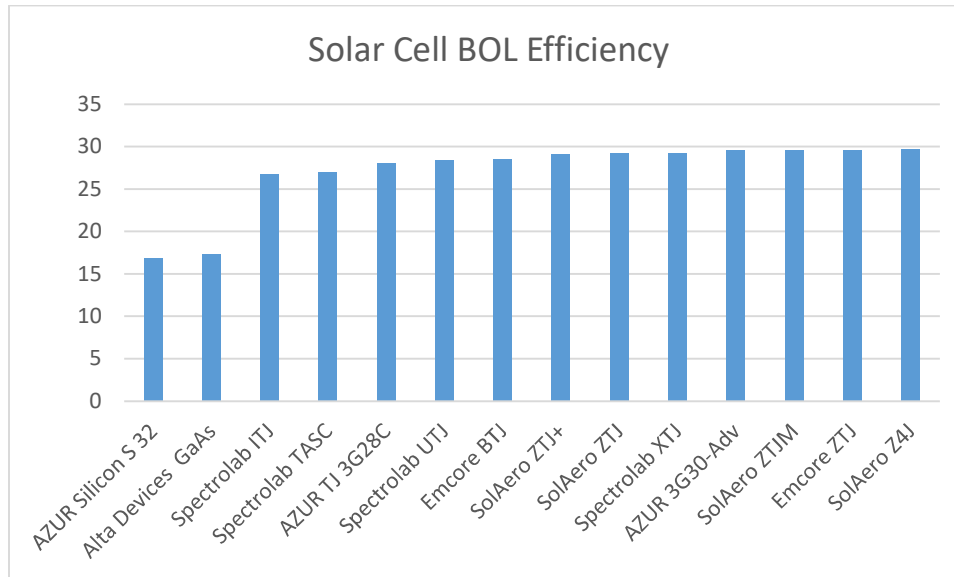


Figure 3.1: Solar cell efficiency. Credit: NASA.

Table 3-1: Solar Cells Product Table								
Company	Cell Name	BOL Efficiency	Voc (V)	Vmp (V)	Jsc (mA/cm <sup>2</sup> )	Jmp (mA/cm <sup>2</sup> )	Pmp (W/m <sup>2</sup> )	Citation
AZUR Space	Silicon S 32	16.8	0.628	0.528	45.8	43.4	229.2	(3)
	3G30-Adv	29.5	2.7	2.411	17.2	16.71	403	(3)
	4G32-Adv	31.5	3.426	2.999	15.2	14.37	431	(3)
	TJ 3G28C	28	2.667	2.37	16.77	16.14	1367	(3)
SolAero	ZTJ	29.2	2.726	2.41	17.4	16.5	397.7	(10)
	ZTJ+	29.1	2.69	2.39	17.1	16.65	397.9	(10)

	ZTJ Omega	29.9	2.73	2.43	17.4	16.8	408.2	(10)
	Z4J	29.7	3.95	3.54	12	11.5	407.1	(10)
	IMM $\alpha$	31.7	4.78	4.28	10.7	10.12	433.1	(10)
	ZTJM	29.5	2.72	2.38	17.1	16.5	392	(10)
SpectroLab	XTJ	29.2	2.633	2.348	17.8	17.02	399.6	(6)
	XTJ- Prime	30.4	2.715	2.39	18.1	17.4	415.9	(6)
	XTE- SF	31.9	2.75	2.435	18.6	17.8	433.4	(5)
	XTE- HF	31.8	2.782	2.49	18	17.4	427.9	(5)
	XTE- LF	31.3	2.755	2.459	18.1	17.4	427.9	(5)
	UTJ	28.4	2.66	2.35	17.14	16.38	384.93	(7)
	TASC	27	2.52	2.19	32	28	270	(8)
	ITJ	26.8	2.565	2.27	16.9	16	1353	(9)
Emcore	BTJ	28.5	2.7	2.37	17.1	16.3	386	(4)
Emcore	ZTJ	29.5	2.726	2.41	17.4	16.5	397	(4)

### 3.2.2 Solar Panels & Arrays

Solar panels & arrays are constructed from individual solar cells connected in series to form strings and in parallel to form circuits mounted on a substrate backing (e.g., figure 3.2). While very low power CubeSats and SmallSats may only need body-mounted solar panels, most will require more power from deployed solar arrays. The deployed solar arrays for CubeSats and SmallSats are mostly on rigid substrates made of either a Printed Circuit Board (PCB), Composite Fiber Reinforced Panels (CFRPs), or an aluminum honeycomb panel.

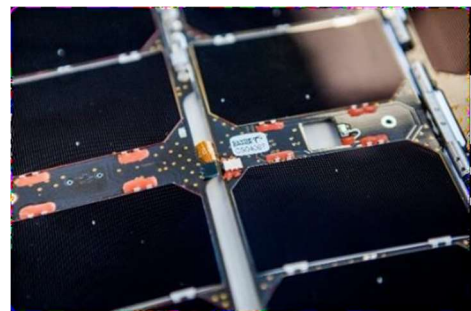


Figure 3.2: AAC Clyde Space solar arrays. Credit: AAC Clyde Space.

Deployed solar arrays are often the largest structure on a satellite; the ratio between the size of the deployed solar array and the size of the SmallSat may be much higher compared to other conventionally large spacecraft. The size and fundamental frequency of the solar arrays impact spacecraft pointing, propulsion, and delta-V needed for



station keeping. Important considerations for SmallSat solar arrays are: deployment mechanisms, deployed frequency, panel specific power, and power density, as well as stowed volume. Most of these metrics are not listed on manufacturer's data sheets.

Solar array comparison can be challenging because SmallSat/CubeSat manufacturers who make solar arrays specific to their bus and payload designs often do not report solar array power using the same metrics. Their reported "power" can mean multiple things: power available to the payload, peak power provided by a combination of solar array and battery, or an orbital specific average power. Solar array power (Peak BOL) reported in the chart is mainly referring to the peak power of the solar array at the beginning of life, 28°C which is mission-independent. Panel stiffness and moment of inertia are dependent on multiple factors such as size and mass of the panel as well as spacecraft size and weight distribution, and usually need to be calculated for a specific spacecraft.

<b>Table 3-2: Solar Array/Panel Products</b>						
<b>Company</b>	<b>Product</b>	<b>Panel Type</b>	<b>Specific Power (W/kg)</b>	<b>Peak BOL Solar Array Power (W)</b>	<b>TRL</b>	<b>Citation</b>
AAC Clyde Space	Photon	Body Mount + Deployed Rigid	*	9.25W / 3U Face	7-9	(11)
Blue Canyon Technologies	BCT Solar Array	Body Mount + Deployed Rigid	*	28 – 42 (3U) / 48-118 (6U-12U)	7-9	(12)
DHV Technologies	Solar Panels for CubeSats Set	Deployed Rigid (PCB)	67	0.272-60 (1P/1U/3U/6U/12U)	N/A	(13)
Exoterra	Fold Out Solar Arrays (FOSA)	Deployed Flexible	140	150	5-6	(14)
MMA Design	Hawk	Deployed Rigid (PCB)	121	36-112	7-9	(15)
	zHawk	Deployed Rigid (PCB)	95	36	7-9	(16)
Airbus Defense and Space Netherlands	Sparkwing Solar Panel	Deployed Rigid	165	66	5-6	(17)
Agencia Espacial Civil Ecuatoriana	DSA/1A	Deployed Rigid	107	7.2	7-9	(18)



GomSpace	Nanopower DSP	Deployed Rigid	*	1.2	7-9	(19)
ISISPACE	Smallsat Solar Panels	Body Mount + Deployed Rigid	46	2.3W / U	7-9	(20)
Redwire Space	ROSA	Flexible PV blanket	100	1000	5**	(21)
	Aladdin SmallSat Array	Hybrid Array: Flex Rigid	80	300	5-6	
EnduroSat	Solar Panel	Deployed Rigid	Unk	Unk	7-9	(35)
Nanoavionics	CubeSat GaAs Solar Panel	Deployed Rigid	Unk	Unk	7-9	(89)

\* Available with Inquiry to Manufacturer

\*\* For smallsat use

### 3.3 On the Horizon – Power Generation

New technologies continue to be developed for space qualified power generation. Promising technologies applicable to small spacecraft include advanced multi-junction, flexible and organic solar cells, hydrogen fuel cells and a variety of thermo-nuclear and atomic battery power sources.

#### 3.3.1 Multi-junction Solar Cells

Fraunhofer Institute for Solar Energy Systems has developed different four-junction solar cell architectures that currently reach up to 38% efficiency under laboratory conditions, although some designs have only been analyzed in terrestrial applications and have not yet been optimized (Lackner). Fraunhofer ISE and EV have achieved 33.3% efficiency for a 0.002 mm thin silicon based multi-junction solar cell, and future investigations are needed to solve current challenges of the complex inner structure of the subcells (22). Additionally, SpectroLab has been experimenting with 5- and 6-junction cells with a theoretical efficiency as high as 70% (23).

A collaboration between the Air Force Research Laboratory (AFRL) and SolAero has developed Metamorphic Multi-Junction (IMM- $\alpha$ ) solar cells that have been shown to be less costly with increased power efficiency for military space applications (1). The process for developing IMM- $\alpha$  cells involves growing them upside down, where reversing the growth substrate and the semiconductor materials allows the materials to bond to the mechanical handle, resulting in more effective use of the solar spectrum (1). A single cell can leverage up to 32% of captured sunlight into available energy. This also results in a lighter, more flexible product. These cells had their first successful orbit in low-Earth orbit in 2018, and since then they have operated in low-Earth orbit on other CubeSat missions.

#### 3.3.2 Flexible Solar Cells

Flexible and thin-film solar cells have an extremely thin layer of photovoltaic material placed on a substrate of glass or plastic. Traditional photovoltaic layers are around 350 microns thick, while thin-film solar cells use layers just one micron thick. This allows the cells to be flexible, lightweight, and cheaper to manufacture because they use less raw material. The performance of commercial flexible CIGS was investigated and reported in relation to potential deep space applications at the



University of Oklahoma. The authors found promising thin film solar material using Cu(In,Ga)Se<sub>2</sub> (CIGS) solar cells with record power conversion efficiencies up to 22.7% (24).

### 3.3.3 Organic Solar Cells

Another on the horizon photovoltaic technology uses organic or “plastic” solar cells. These use organic electronics or organic polymers and molecules that absorb light and create a corresponding charge. A small quantity of these materials can absorb a large amount of light making them cheap, flexible and lightweight.

Toyobo Co., Ltd. and the French government research institute CEA have succeeded in making trial organic photovoltaic (OPV) small cells on a glass substrate. Trial OPV modules on a lightweight and thin PET (polyethylene terephthalate) film substrate were demonstrated during their joint research project. Toyobo and CEA succeeded in making the OPV small cells on a glass substrate with the world’s top-level conversion efficiency by optimizing the solvents and coating technique. In a verification experiment under neon lighting with 220 lux, equivalent to the brightness of a dark room, the trial product was confirmed to have attained a conversion efficiency of about 25%, or 60% higher than that of amorphous silicon solar cells commonly used for desktop calculators (25).

In October 2016, the Optical Sensors based on carbon materials (OSCAR) stratospheric-balloon flight test demonstrated organic-based solar cells for the first time in a stratospheric environment. While more analysis is needed for terrestrial or space applications, it was concluded that organic solar energy has the potential to disrupt “conventional” photovoltaic technology (26). Since then, a joint collaborative agreement between the German Aerospace Center and the Swedish National Space Board REXUS/BEXUS has made the balloon payload available for European university student experiments collaborating with European Space Agency (ESA) (27).

No standardized stability tests are yet available for organic-based solar cell technology, and challenges remain in creating simultaneous environmental influences that would permit in-depth understanding of organic photovoltaic behavior, but these achievements are enabling progress in organic-based solar cell use. In 2018, Chinese researchers in organic photovoltaics were able to reach 17% power conversion energy using a tandem cell strategy. This method uses different layers of material that can absorb different wavelengths of sunlight, which enable the cells to use more of the sunlight spectrum, which has limited the performance of organic cells (28).

### 3.3.4 Fuel Cells

Hydrogen fuel cells are appealing due to their small, light and reliable qualities, and high energy conversion efficiency. They also allow missions to launch with a safe, storable, low pressure and non-toxic fuel source. An experimental fuel cell from the University of Illinois that is based on hydrogen peroxide rather than water has demonstrated an energy density of over 1000 Wh kg<sup>-1</sup> with a theoretical limit of over 2580 Wh kg<sup>-1</sup> (29). This makes them more appealing for interplanetary missions and during eclipse periods, however unlike chemical cells, they cannot be recharged on orbit. Carrying a large fuel tank is not feasible for small or nanosatellite missions. Regenerative fuel cells are currently being researched for spacecraft application. Today, fuel cells are primarily being proposed for small spacecraft propulsion systems rather than for power sub-systems (30).

### 3.3.5 Nuclear Power

Another source of spacecraft power comes from harnessing the energy released during radioactive decay. Radioisotope Thermoelectric Generators (RTGs) are associated with longer lifetimes, high reliability, predictable power production, and are more appealing beyond Mars orbit

(>3 AU) than relying on batteries and solar panels. Unlike fuel cells, an RTG may operate continuously for decades without refueling. A full-sized RTG, such as on New Horizons, has a mass of 56 kg and can supply 300 W (6.3% efficiency) at the beginning of its life (31). Additionally, the Perseverance rover is being powered by a nuclear energy system known as Multi-Mission Radioisotope Thermoelectric Generator (MMRTG) (90).

In addition to power generation, radioactive decay can also aid in offsetting the power requirements of SmallSats, allowing for smaller sized power generation and storage subsystems. Heaters are often one of the most power-hungry subsystems in space missions. An example of this is the Ingenuity Mars Helicopter which uses 90% of its power to heat its batteries and electronics. Radioisotopic Heater Units (RHUs) generate heat through the decay of plutonium-238 and can be used to keep SmallSat equipment warm, decreasing the load that conventional heaters have on the SmallSat electrical power system (32).

Although a radioisotope power system has not yet been integrated on a small spacecraft and may present challenges for SmallSats with limited mass and power requirements, options for nuclear power generation might be considered in the future (e.g., for small spacecraft missions that traverse interplanetary space). This concept would require substantial testing and modified fabrication techniques to facilitate use on smaller platforms. There are limits placed on the amount or mass of a radioisotope that can be used in a spacecraft before special handling and procedures are required. These limits are determined by values for specific types of radioactive material, but spacecraft designers should note that radioactivity levels below these values can be flown in spacecraft without any special handling. NASA/TM—2018-219940 gives a summary of low-power radioisotope-based power sources and acceptable values (91).

### 3.3.6 TPV

A thermophotovoltaic (TPV) battery consists of a heat source or thermal emitter and a photovoltaic cell which transforms photons into electrical energy. Thermophotovoltaic power converters are similar to high TRL thermoelectric converters, but the latter uses thermocouples and the former uses infrared-tuned photovoltaic cells.

A planar TPV system with very high efficiency and output power has been numerically demonstrated at near-field at large vacuum gaps, illustrated in figure 3.2. As a performance example, the 50 W scale-up TPV power supply with 1.5 kg of fuel has a projected weight specific energy density of 645 Wh kg<sup>-1</sup>. This is 4 times larger than for a Li-ion battery (33).

### 3.3.7 Alpha- and Beta-voltaics

Alpha- and beta-voltaic power conversion systems use a secondary material to absorb the energetic particles and re-emit them via luminescence. These photons can then be absorbed by photovoltaic cells. Methods for retrieving electrical energy from radioactive sources include beta-voltaic, alpha-voltaic, thermophotovoltaic, piezoelectric and

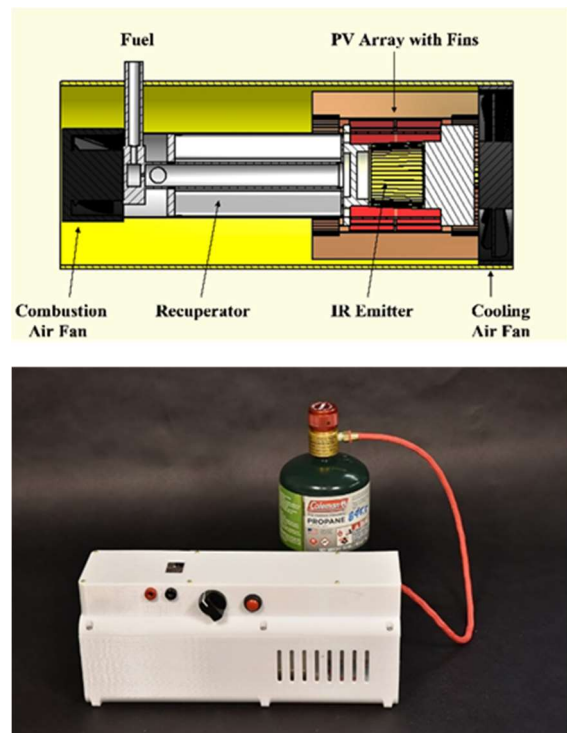


Figure 3.2: (top) Design of TPV power supply and (bottom) functional stand-alone TPV power supply. Credit: Fraas et al. (2017).





mechanical conversions. This technology is currently in the testing/research phase.

### **3.3.8 Thermoradiative (TR) Cells**

In the opposite way to which conventional solar cells deliver power through absorbing light from the sun, thermoradiative cells generate power through the emission of light. In practice, photons emitted by a blackbody near room temperature have far less energy than the bandgap of silicon, so these devices are constructed with ultralow-bandgap materials which, in ideal cases, can produce as much as  $54 \text{ W m}^{-2}$  ( $10 \text{ W m}^{-2}$  in practical cases), compared to the  $200 \text{ W m}^{-2}$  that is descriptive of modern commercial silicon solar cells. Despite yielding less power generation than regular solar cells, TR cells have the advantage of being able to generate power in shaded conditions, which lends itself to waste heat recovery, as well as being able to aid in preventing and recovering from spacecraft anomalies like a dead bus. Additionally, TR cells happen to perform the best in space where the lack of an atmosphere prevents losses due to absorption by the atmosphere. Researchers at University of California, Davis are currently testing and characterizing the limits of these devices. In the future TR cells could be pivotal in being able to extract electrical power from the radiative emission of thermal wavelengths from a device on earth to outer space (34).

## **3.4 State-of-the-Art – Energy Storage**

Solar energy is not always available during spacecraft operations; the orbit, mission duration, distance from the Sun, or peak loads may necessitate stored, on-board energy. Primary and secondary batteries are used for power storage and are classified according to their different electrochemistry. As primary-type batteries are not rechargeable, they are typically used for short mission durations. Silver-zinc are typically used as they are easier to handle and discharge at a higher rate, however there are also a variety of lithium-based primary batteries that have a higher energy density, including: lithium Sulfur dioxide ( $\text{LiSO}_2$ ), lithium carbon monofluoride ( $\text{LiCF}_x$ ) and lithium thionyl chloride ( $\text{LiSOCl}_2$ ) (36).

Secondary-type batteries include nickel-cadmium ( $\text{NiCd}$ ), nickel-hydrogen ( $\text{NiH}_2$ ), lithium-ion ( $\text{Li-ion}$ ) and lithium polymer ( $\text{LiPo}$ ), which have been used extensively in the past on small spacecraft. Lithium-based secondary batteries are commonly used in portable electronic devices because of their rechargeability, low weight, and high energy, and have become ubiquitous on spacecraft missions. They are generally connected to a primary energy source (e.g. a solar array) and can provide rechargeable power on-demand. Each battery type is associated with certain applications that depend on performance parameters, including energy density, cycle life and reliability (36). A comparison of energy densities can be seen in figure 3.3, and a list of battery energy densities per manufacturer is given in table 3-3.

This section will discuss the individual chemical cells as well as pre-assembled batteries of multiple connected cells offered from multiple manufacturers. Due to small spacecraft mass and volume requirements, the batteries and cells in this section will be arranged according to specific energy, or energy per unit mass. However, several other factors are worth considering, some of which will be discussed below (37).

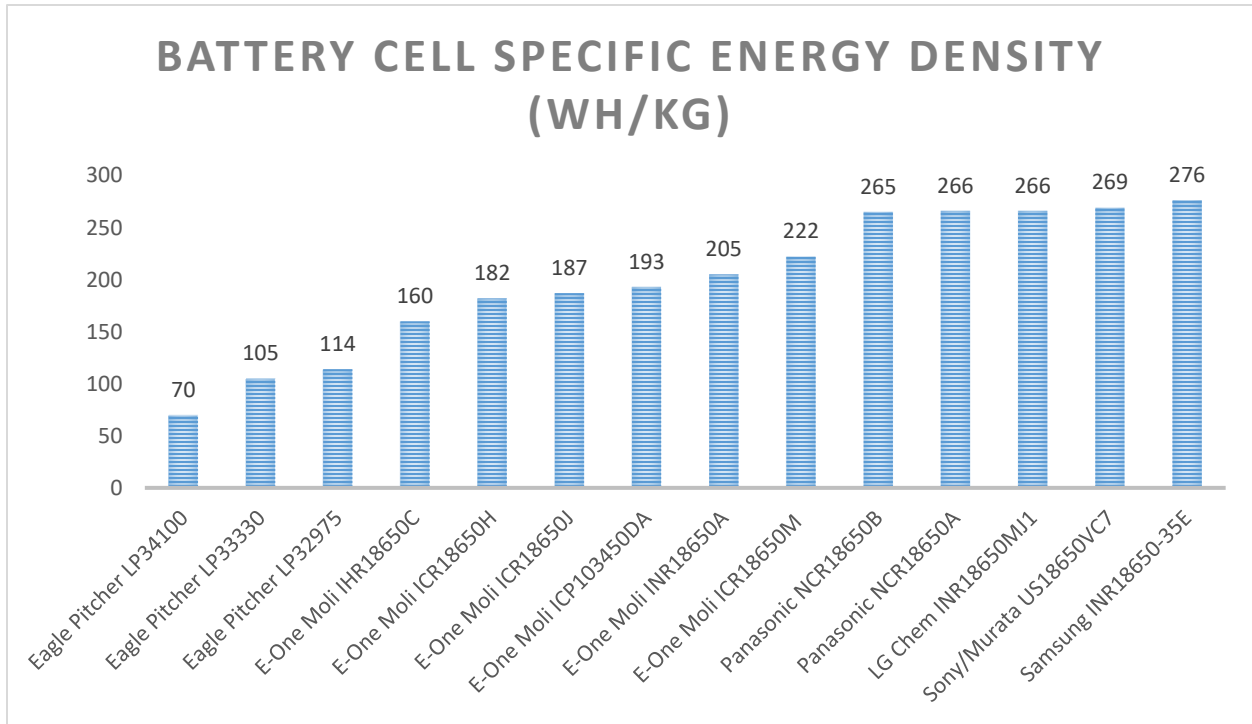


Figure 3.3: Battery cell energy density. Credit: The Aerospace Corporation.



Table 3-3: Battery Product Table								
Company	Product	Volumetric Energy Density [Wh L <sup>-1</sup> ]	Specific Energy [Wh kg <sup>-1</sup> ]	Typical Capacity [Ah]	Max Discharge Rate [A]	Cells Used	TRL	Citation
EaglePicher Technologies	NPD-002271	271	153.5	14.5	15	EaglePicher Li-ion	7-9	(39)
GomSpace	Nanopower BPX (4S-2P)	228.7	150	5.2	2.5	GomSpace NanoPower Li-ion	7-9	(42)
GomSpace	Nanopower BP4 (2S-2P)	211.9	149.2	5.2	2.5	GomSpace NanoPower Li-ion	7-9	(43)
AAC Clyde Space	Optimus-40	169.5	119	4.84	2.6	Clyde Space Li-Polymer	7-9	(44)
Ibeos	28V Modular Battery	151.1	109.8	9.82	20	*	N/A	(45)
Saft	VES16 4S1P	109.2	91	4.5	4.5 – Cont. 9 - Pulse	SAFT Li-ion	7-9	(46)
Vectronic Aerospace GmbH	VLB-X	101.96	74.6	12	10 – Cont. 20 - Pulse	SAFT Li-Ion	7-9	(47)
Berlin Space Technologies	BAT-110 Modular Battery (Nominal 3 strings)	69.73	57.75	7.5	3	Li-Fe	7-9	(48)

\* Available with Inquiry to Manufacturer



Table 3-4: Battery Cell Product Table							
Company	Product	Volumetric Energy Density [Wh L <sup>-1</sup> ]	Specific Energy [Wh kg <sup>-1</sup> ]	Typical Capacity [Ah]	Max Discharge Rate [A]	Voltage Range [V]	Citation
Samsung	INR18650-35E	733	276	3.4	8	2.65 – 4.2	(49)
Sony/Murata	US18650VC7	735	269	3.5	8	2 – 4.2	(50)
Panasonic	NCR18650A	620	266	3.1	3.9	2.5 – 4.2	(51)
	NCR18650B	730	265	3.35	6.4	2.5 – 4.2	(52)
LG Chem	INR18650MJ1	720	266	3.5	10	2.5 – 4.2	(53)
E-one Moli	ICR18650M	631	222	2.8	2.5	3 – 4.2	(54)
	INR18650A	520	205	2.5	20	2 – 4.2	(60)
	ICP103450DA	478	193	2.15	2.5	3 – 4.2	(58)
	ICR18650J	517	187	2.37	5	2.5 – 4.2	(57)
	ICR18650H	496	182	2.2	5	3 – 4.2	(56)
	IHR18650C	425	160	2.05	20	2 – 4.2	(55)
EaglePicher Technologies	LP32975	285	114	12	96	3 – 4.1	(41)
	LP33330	263	105	6	24	3 – 4.1	(40)
	LP34100	165	70	5	500 – Cont. 2000 - Pulse	3 – 4.1	(38)

\* Available with Inquiry to Manufacturer



The chemistry and cell design impacts the volumetric and specific energy densities. This limit represents the total amount of energy available per unit volume or weight, respectively. Current top of the line Li-ion energy cells exhibit  $\sim 270 \text{ Wh kg}^{-1}$ . Li-ion batteries exhibit lower energy densities due to inclusion of a battery management system (BMS), interconnects, and sometimes thermal regulation.

There are generally two groups of cells – high energy or high power. High power cells use a low resistance design, such as increasing coating surface area, or multiple points of contact for the current collector to cell which can allow for lower overall resistance values and a higher rate of discharge. High energy cells work to optimize gravimetric energy densities to obtain the most energy from the cell. Some common methods to increase gravimetric energy densities are via addition of silicon to the anode, use of high voltage cathodes, or using a metallic lithium anode. However, these methods can significantly reduce the cyclability of the battery system in exchange for increased energy density.

In general, for space applications, high energy density is important because a battery with high gravimetric energy density will be cheaper to launch into orbit (higher battery capacity per unit mass). However, for some high pulse applications, high power cells would meet mission needs with less weight. However, energy density is not the only factor to look into during cell selection. For non-space commercial applications, faster degradation (lower cyclability) of the battery can be beneficial as the electronic device often lasts as long as the battery, and faster turnover of a device may lead to increased revenue.

While space-designed cells typically underperform in energy density, they over-perform in cyclability with many space-designed cells used for longer ( $\sim 5$ -15 year) missions. Of a limited number of COTS cells tested, NASA results for 40% low-Earth orbit testing showed that the LG MJ1 provides the best cyclability compared to some of its peers for 1500 cycles (61). However, not all degradation modes for lithium-ion trend in a linear fashion, and trends often take time to settle, thus the test results don't necessarily show the best performing cell until others are further along in testing.

Due to the extremely short mission durations with primary cells, the current state-of-the-art energy storage systems use lithium ion (Li-ion) or lithium polymer (LiPo) secondary cells, so this subsection will focus only on these electrochemical compositions, with some exceptions.

### **3.4.1 Secondary Li-ion and Li-po Batteries**

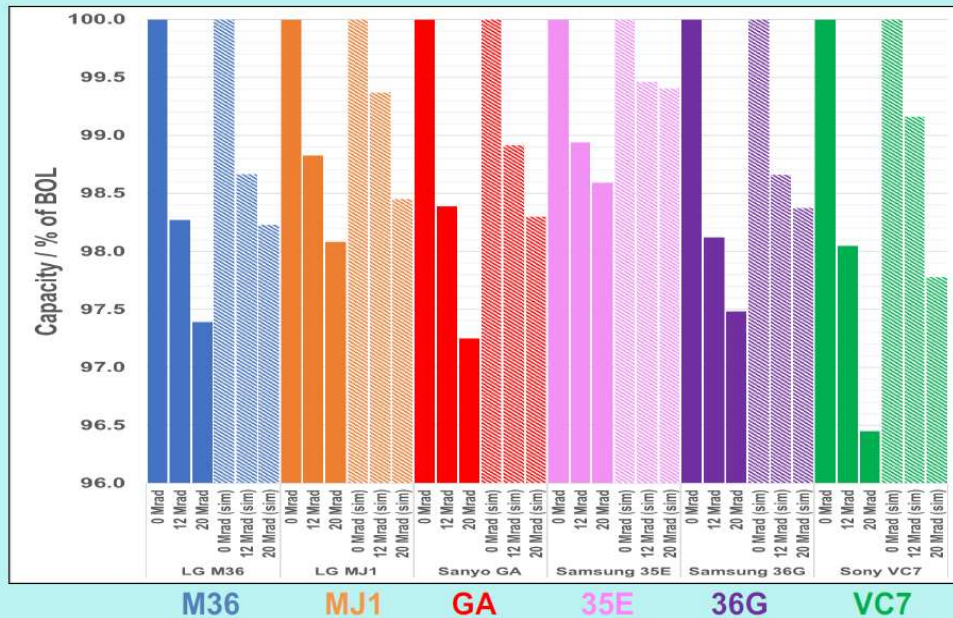
Typically, Li-ion cells deliver an average voltage of 3.6 V, while the highest specific energy obtained is well in excess of  $150 \text{ Wh kg}^{-1}$  (37). Unlike electronics, battery cells do not typically show significant damage or capacity losses due to radiation. However, in an experiment done by JPL, some capacity loss is seen among these latest lithium ion battery cells under high dosage of Cobalt-60. The results are shown below in figure 3.4 (62).

In Lithium-ion batteries, repeated charging cycles of the battery eventually result in aging or degradation that affects the overall energy (Watt-hours) that the battery may provide. There are many variables that impact aging, such as temperature, charge/discharge rate, depth of discharge, storage conditions, etc. Due to the numerous variables that impact aging, lithium-ion batteries are typically put under life test in mission conditions prior to launch to ensure the battery will meet the specific mission life requirements.



## Exposure to Cobalt-60 (<sup>60</sup>Co) Radiation

Capacity vs Radiation dose



- Solid: Irradiated; 0, 12 and 20 Mrad hashed: 0 control, after equivalent stand periods
- All the cells show impressive tolerance to radiation with <2% capacity loss (vs control cells) after 20 Mrad exposure.
- Radiation tolerance: Samsung 35E > MJ1 > Samsung 36G > M36 > Sanyo GA > Sony VC7

### 18650 Cells

18650 cylindrical cells (18 x 65 mm) have been an industry standard for lithium ion battery cells. Many manufacturers have staple high-performance 18650 cells, some of which have flown on multiple spacecraft and are documented in table 3-5 below.

Cell	Specific Energy (Wh kg <sup>-1</sup> )	Flight Heritage
LG ICR18650 B3 (2600 mAh)	191	NASA's PhoneSat spacecraft
Panasonic NCR18650B (3350 mAh)	243	N/A
Molicel ICR18650H (2200 mAh)	182	NASA's EDSN mission
Canon BP-930s (3000 mAh)	112	NASA's TechEdSat missions



Panasonic NCR18650GA (3450 mAh)	258	N/A
LG MJ1 (3500 mAh)	260	N/A

Cylindrical 18650s have become the most commonly used building blocks for many SmallSats today, although prismatic and pouch formats are also available. The lithium-ion industry has seen incremental increases in energy density via inclusion of silicon in the anode, high voltage cathodes, new electrolyte additives, and improved cell designs.

#### 21700 Cells

21700 (21 x 70 mm) is another type of cylindrical cells that are getting more popular. Samsung 50E and LG M50 both offer 5000 mA h of energy while the Samsung cells are slightly heavier. The specific energy densities are 262 Wh kg<sup>-1</sup> and 264 Wh kg<sup>-1</sup> respectively. Although 21700 cells are slightly larger than 18650 cells, they are among some of the cells with highest energy densities. They could offer some mechanical packaging benefits with fewer cells for certain missions.

#### 4680 Cells

4680 cells (46 x 80 mm) cylindrical cells are a form factor of battery cell that has been introduced to the energy storage scene by Tesla. The larger format cell potentially exacerbates several of the thermal management drawbacks (particularly internal temperature gradients and heterogeneity in current distribution) associated with other common smaller cells, however in order to address these drawbacks, Tesla has a “tabless current collection” method where the current collector foil is used in conjunction with an array of current collectors to reduce ohmic losses and the temperature increases that those losses can cause (63).

When it comes to the manufacturing of Li-ion batteries and battery cells, these companies are at the forefront for their respective sectors listed in table 3-6.

<b>Table 3-6: Commercial and Space Li-ion Manufacturers</b>			
<b>Commercial Li-ion Manufacturing</b>		<b>Space Li-ion Manufacturing</b>	
<b>Company</b>	<b>Headquarters</b>	<b>Company</b>	<b>Headquarters</b>
Panasonic	Japan	EaglePicher Technologies	USA
LG Chem	South Korea	Enersys	USA
Samsung	South Korea	GS Yuasa	Japan
E-one Moli	Taiwan	Saft	France
Sony	Japan		

### 3.5 On the Horizon – Energy Storage

In the area of power storage there are several on-going efforts to improve storage capability and relative power and energy densities; a Ragone Chart shown in figure 3.5 illustrates different energy devices (64). For example, the Rochester Institute of Technology and NASA Glenn Research Center (GRC) developed a nano-enabled power system on a CubeSat platform. The power system integrates carbon nanotubes into lithium-ion batteries that significantly increases available energy density. The energy density has exceeded  $300 \text{ Wh kg}^{-1}$  during testing, a roughly two-fold increase from the current state of the art. The results in this program were augmented from a separate high-altitude balloon launch in July 2018 organized through NASA GRC and showed typical charge and discharge behavior on ascent up to an altitude of 19 km (65). A collaborative project between the University of Miami and NASA Kennedy Space Center (KSC) is aiming to develop a multifunctional

structural battery system that uses an electrolytic carbon fiber material that acts as both a load bearing structure and a battery system. This novel battery system will extend mission life, support larger payloads, and significantly reduce mass. While several panel prototypes have shown successively increased electrochemical performance, further testing of the individual components can improve the accuracy of the computational models (66).

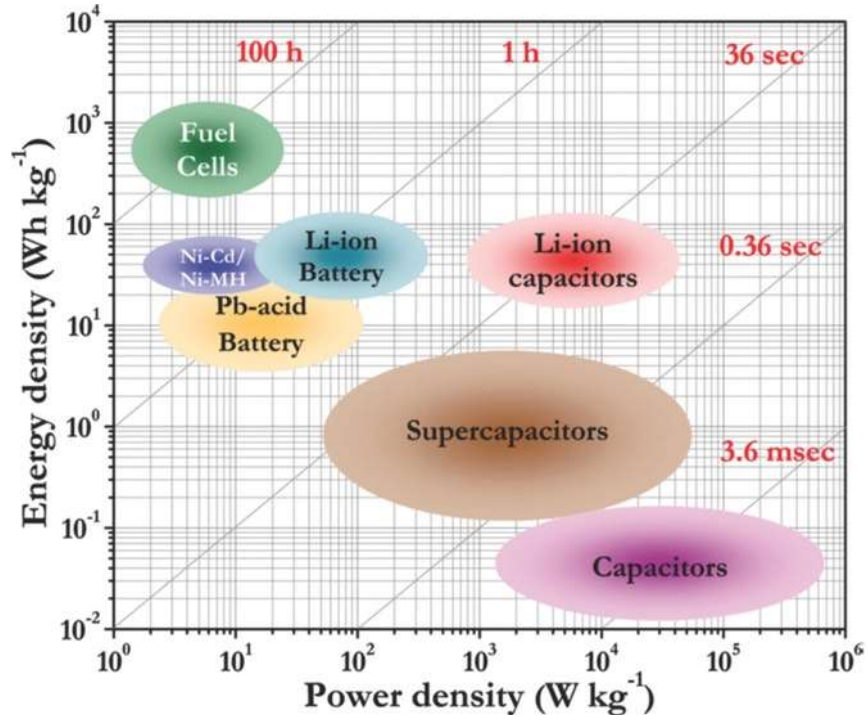


Figure 3.5 Relative power and energy densities of different energy devices. Ragone chart illustration reprinted with permission from Aravindan et al. Copyright (2014) American Chemical Society.

structural battery system that uses an electrolytic carbon fiber material that acts as both a load bearing structure and a battery system. This novel battery system will extend mission life, support larger payloads, and significantly reduce mass. While several panel prototypes have shown successively increased electrochemical performance, further testing of the individual components can improve the accuracy of the computational models (66).

#### 3.5.1 Supercapacitors

While the energy density for supercapacitors, also called ultracapacitors, is low (up to  $7 \text{ Wh kg}^{-1}$ ), they offer very high-power density (up to  $100 \text{ kW kg}^{-1}$ ). This property could be useful for space applications that require power transients. Their fast charge and discharge time, and their ability to withstand millions of charge / discharge cycles and wide range of operational temperatures ( $-40^\circ\text{C}$  to  $+70^\circ\text{C}$ ), makes them a perfect candidate for several space applications (launchers and satellites). This was demonstrated in an ESA Study Contract No. 21814/08/NL/LvH entitled “High Power Battery Supercapacitor Study” completed in 2010 by Airbus D&S (67). Currently the Nesscap 10F component and a bank of supercapacitor based on the Nesscap 10F component are space qualified after the completion in 2020 of the ESA Study Contract No. 4000115278/15/NL/GLC/fk entitled “Generic Space Qualification of 10F Nesscap Supercapacitors”. Although not likely to replace Li-ion batteries completely, supercapacitors could drastically minimize the need for a battery and help reduce weight while improving performance





in some applications. Figure 3.6 shows a comparison chart (68), and table 3-4 lists differences in Li-ion batteries and supercapacitors (69).

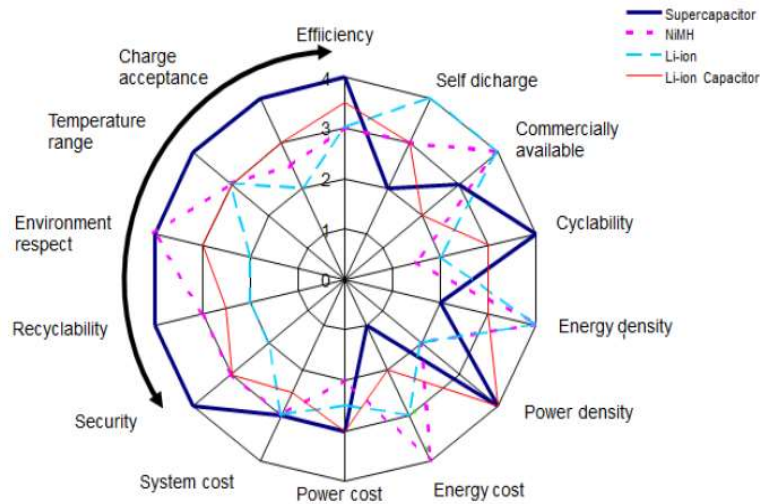


Figure 3.6: Supercapacitor comparison chart. Credit: Airbus Defense and Space and ESA (2016).

Table 3-7: Battery-vs-Supercapacitor Specifications		
Feature	Li-Ion Battery	Supercapacitor
Gravimetric energy (Wh kg <sup>-1</sup> )	100 – 265	4 – 10
Volumetric energy (Wh L <sup>-1</sup> )	220 – 400	4 – 14
Power density (W kg <sup>-1</sup> )	1,500	3,000 – 40,000
Voltage of a cell (V)	3.6	2.7 – 3
ESR (mΩ)	500	40 - 300
Efficiency (%)	75 – 90	98
Cyclability (nb charges)	500 – 1,000	500,000 – 20, 000,000
Life (years)	5 – 10	10 – 15
Self-discharge (% per month)	2	40 – 50 (descending)
Charge temperature	0 to 45°C	-40 to 65°C
Discharge temperature	yes	no
Deep discharge pb	yes	no



Overload pb	yes	no
Risk of explosion	yes	no
Charging 1 cell	complex	easy
Charging cells in series	complex	complex
Voltage on discharge	stable	decreasing
cost (\$) per kW h	235 – 1,179	11,792

The lithium ion capacitor is a promising recent development in the world of energy storage, combining the energy storage capabilities of both lithium ion batteries as well as double layered capacitors, providing a middle ground between power density and energy density, but suffers from a limited cycle life. Some lithium ion capacitors have a minimum specific energy of 200 Wh kg<sup>-1</sup> but are limited by a maximum specific power of <350 W kg<sup>-1</sup> (88).

### 3.5.2 Solid State Batteries

A majority of the batteries being used in contemporary space applications are lithium ion batteries that use liquid electrolytes, however these batteries carry an inherent risk of combustion from physical damage as well as thermal runaway due to overcharge. As a result, spacecraft often carry parasitic weight in the form of cooling systems and housing units. Interest in battery designs that solve the issue of safety and improve on energy and power density have been an industry topic for a long time, ultimately leading the way to NASA's SABER (Solid-state Architecture Batteries for Enhanced Rechargeability and Safety) project which aims to create solid state batteries that have significantly higher energy than current state of the art lithium-ion batteries and would not catch fire or lose capacity over time. Current strides in this project include examination and testing on unique battery chemistries including sulfur-selenium and "holey graphene" (70).

### 3.6 State-of-the-Art – Power Management and Distribution

Power management and distribution (PMAD) systems control the flow of power to spacecraft subsystems and instruments and are often custom designed by mission engineers for specific spacecraft power requirements, however, several manufacturers have begun to provide a variety of PMAD devices for inclusion in small spacecraft missions. PMAD not only delivers power coming from energy sources (typically solar arrays in SmallSat applications), but also conditions energy as well, mitigating harmful transient disturbances and fault conditions from propagating downstream and hurting connected loads.

Several manufacturers supply EPS which typically have a main battery bus voltage of 8.2 V but can distribute a regulated 5.0 V and 3.3 V to various subsystems. The EPS also protects the electronics and batteries from off-nominal current and voltage conditions. As the community settles on standard bus voltages, PMAD standardization may follow. Well-known producers of PMAD systems that focus on the small spacecraft market include Pumpkin, GomSpace, Stras Space, and AAC Clyde Space. However, a number of new producers have begun to enter the PMAD market with a variety of products, some of which are listed below. Table 3-3 lists PMAD system manufacturers; it should be noted that this list is not exhaustive.



Key considerations in determining PMAD device selection often include conversion efficiency, input/output voltage range, output power capabilities, and size, weight, and power (SWaP). These metrics are critical to consider for good smallsat PMAD designs, but it is important to note that PMAD devices are best chosen to suit the exact application of the SmallSat mission. SmallSat missions are often short in duration and more flexible in terms of risk management than larger satellites, thus lending themselves to greater flexibility in design choices. One must leverage the benefits and risks to the mission at hand when choosing COTS PMAD systems, which may include the following:

- COTS PMAD may require less intensive integration and testing but have drawbacks to be addressed in a custom PMAD build
- Unnecessary features and peripherals (e.g., excess switching, fusing, current capability) can greatly increase SWaP metrics on a SmallSat
- Variability in designs of COTS PMAD devices means that important features and protections are not available in all devices (MPPT, Dead-bus protections, redundancy mechanisms, etc.)

Due to the variability of COTS PMAD options, many choice considerations, from internal power management topologies/materials to telemetry and protection options, are either included or omitted from products depending on the manufacturer. Internal power regulation topologies have traditionally been silicon-based, but relatively recent research into the performance improvements of GaN (Gallium Nitride) topologies has increased the number of GaN-based PMAD options on the consumer market with the following benefits over their silicon counterparts:

- Ability to achieve high switching rates and lower switching losses, allowing for the downsizing of inductors and capacitors, and improving SWaP metrics
- Lack of gate oxide layer in GaN-based field effect transistors yields improvements in overall efficiency

It must also be noted that GaN-based PMAD options are not to be considered as drop-in replacements for silicon-based PMAD options, as despite the number of performance improvements, GaN architectures come with a variety of drawbacks including high complexity of control circuitry and lack of flight heritage.

In looking at the table below, one must note that there is no single COTS PMAD solution that can fit all needs of a mission at hand. In appealing to a broad range of applications, most COTS PMAD devices make sacrifices that can impact important metrics for SmallSats, including SWaP as well as the efficiency and quality of the power being managed. In choosing to use COTS PMAD devices, designers and system architects should be aware of, and try to minimize, unnecessary features not beneficial to the mission.



**Table 3-6: Product of Power Management and Distribution Systems**

Company	Product	Mass (kg)	Volume (cm <sup>3</sup> )	Peak Power Output (W)	Input Voltages (VDC)	Output Voltages (VDC)	Max Efficiency	TRL	Citation
Pumpkin	EPSM 1	0.300	250	160	8-55	3.3-50	98.5	9	(71)
AAC Clyde Space	Starbuck Micro	2.45	3968	120	28	28 / 5	97	9	(72)
	Starbuck Mini	5.90	13133	1200	*	22-34 / 5 / 8 / 12 / 15	*	9	(73)
	Starbuck Nano	0.086	140	*	*	3.3 / 5 / 12	*	9	(74)
GomSpace	P31U	0.100	127	30	0-8	3.3 / 5	96	9	(75)
ISISPACE	iEPS Type C	0.360	14.13	13	12.8-16	3.3 / 5 / Unreg	95	9	(76)
DHV	EPS Module	0.177	1530	56	4.5-28	3.3 / 5 / 12 / Batt	93	9	(77)
Extreme Engineering Solutions (X-ES)	XPM-2020	0.660	400	300	22-29	3.3 / 5 / 12 / -12	90	N/A	(78)
EnduroSat	EPS I	0.208	183	10-20	0-33	3.3 / 5 / Batt	86	9	(79)
EnduroSat	EPS I Plus	0.292	259	30	0-5.5	3.3 / 5 / Batt	*	9	(80)
EnduroSat	EPS II	1.280	*	250	10-36	3.3 / 5 / 6-12 / Batt	*	9	(81)
Ecarver GmbH	PCU-SB7	1.500	1800	250	0-23.1	5	85	N/A	(82)



Berlin Space Technologies	PCU-110	0.960	1191	*	20-25	3.3 / 5/ 12 / 24 / 1.8-28	*	9	(83)
Ibeos	150W CubeSat EPS	0.140	124	150	18-42	3.3 / 5/ 12/ Unreg Batt	95	N/A	(84)
Nanoavionics	CubeSat EPS	*	*	175	2.6-18	3.3 / 5 / 3-18	96	N/A	(85)

\* Available with Inquiry to Manufacturer



### **3.7 On the Horizon – Power Management and Distribution**

Power management and distribution has been steadily improving each year due to changes in technology, as well as from different approaches to maximizing the usefulness of these systems, including modular architectures, wireless telemetry, and power transmission options.

#### **3.7.1 Modular Architecture**

For small spacecraft, traditional EPS architecture is centralized (each subsystem is connected to a single circuit board). This approach provides simplicity, volume efficiency, and inexpensive component cost. However, a centralized EPS is rarely reused for a new mission, as most of the subsystems need to be altered based on new mission requirements. A modular, scalable EPS for small spacecraft was detailed by Timothy Lim and colleagues, where the distributed power system is separated into three modules: solar, battery and payload. This allows scalability and reusability from the distributed bus, which provides the required energy to the (interfaced) subsystem (86).

ISISPACE has a modular EPS for CubeSat missions (3U+) that includes a large amount of flexibility in output bus options with adjustable redundancy for certain parts of the device. The modular EPS consists of a power conditioning unit for solar panel input, secondary power storage, a battery holder with integrated fuse, and a power regulation and distribution unit for subsystem loads. Each unit is designed to be independent, allowing for daisy chaining and flexibility in redundancy and subsystem upgrades. This device is based on heritage from the Piezoelectric Assisted Smart Satellite Structure (PEASSS) CubeSat flown in 2016, with the device itself having been successfully flown in 2018 (76).

#### **3.7.2 Wireless Power Transfer and Telemetry**

In the commercial world, the technology already exists for wireless sensing and power transmission from the order of microwatts, all the way up to kilowatts. In the realm of SmallSats, wireless power transfer/detection would be useful as redundant options in dusty environments where physical connectors can be contaminated, or in situations where hardware needs to be swapped around and powered (battery swaps). While wireless power transfer/detection is highly inefficient when compared to conventional means, research and development in this technology for use in space applications has a lot of potential in increasing the reliability and robustness of SmallSat power management and distribution.

### **3.8 Summary**

Driven by weight and mostly size limitations, small spacecraft are using advanced power generation and storage technology such as >32% efficient solar cells and lithium-ion batteries. The higher risk tolerance of the small spacecraft community has allowed both the early adoption of technologies like flat lithium-polymer cells, as well as COTS products not specifically designed for spaceflight. This can dramatically reduce cost and increase mission-design flexibility. In this way, power subsystems are benefiting from the current trend of miniaturization in the commercial electronics market as well as from improvements in photovoltaic and battery technology.

Despite these developments, the small spacecraft community has been unable to use other, more complex technologies. This is largely because the small spacecraft market is not yet large enough to encourage the research and development of technologies like miniaturized nuclear energy sources. Small spacecraft power subsystems would also benefit from greater availability of flexible, standardized power management and distribution systems so that every mission need not be designed from scratch. In short, today's power systems engineers are eagerly adopting certain innovative Earth-based technology (like lithium polymer batteries) while, at the same time,



patiently waiting for important heritage space technology (like fuel cells and RTGs) to be adapted and miniaturized. Despite the physical limitations and technical challenges these power generation technologies have, most small and nanosatellites in the foreseeable future will still likely carry batteries to support the transient load.

For feedback solicitation, please email: [arc-sst-soa@mail.nasa.gov](mailto:arc-sst-soa@mail.nasa.gov). Please include a business email so someone may contact you further.

## References

- (1) Alia-Novobilski, M. "Advanced Multi-junction Solar Cells Deliver High Efficiency, Reduced Costs for Space." [Online] Jan 4, 2018. [Cited: July 15, 2018.] <https://phys.org/news/2018-01-advanced-multi-junction-solar-cells-high.html#jCp>.
- (2) Green, M. A. "Third Generation Photovoltaics: Advanced Solar Energy Conversion." Springer. Vol. 12. 2003.
- (3) AzurSpace. "Space Products, Solar Cells." [Online] 2020. [Accessed: May 15, 2021.] <http://www.azurspace.com/index.php/en/products/products-space/space-solar-cells>
- (4) EMCORE. BTJ Space Solar Cells. 2015.
- (5) SpectroLab. [Online] May 16, 2020. [Accessed: May 16, 2021.] [https://www.spectrolab.com/photovoltaics/XTE-SF%20Data%20Sheet%20\\_12.23.19.pdf](https://www.spectrolab.com/photovoltaics/XTE-SF%20Data%20Sheet%20_12.23.19.pdf).
- (6) SpectroLab. 30.7% Triple Junction Space Grade Solar Cell. [Online] 2018. [Cited: July 15, 2018.] [https://www.spectrolab.com/DataSheets/cells/XTJ\\_Prime\\_Data\\_Sheet\\_7-28-2016.pdf](https://www.spectrolab.com/DataSheets/cells/XTJ_Prime_Data_Sheet_7-28-2016.pdf).
- (7) SpectroLab. Datasheet, "Ultra Triple Junction (UTJ) Cells". [Online] 2018. [Accessed: July 16, 2021.] <http://www.spectrolab.com/DataSheets/cells/2015%20UTJ%20CIC%20Datsheet.pdf>
- (8) SpectroLab. Datasheet, "Triangular Advanced Solar Cells (TASC)." [Online] Accessed July 16, 2021. [https://www.spectrolab.com/DataSheets/PV/PV\\_NM\\_TASC\\_ITJ.pdf](https://www.spectrolab.com/DataSheets/PV/PV_NM_TASC_ITJ.pdf)
- (9) SpectroLab. Datasheet, "26.8% Improved Triple Junction (ITJ) Solar Cells." [Online] Accessed: July 16, 2021.
- (10) SolAero. "Space Solar Cells/CICs." [Online]. 2020. Accessed: June 30, 2021. <https://solaerotech.com/space-solar-cells-cics/>
- (11) AAC Clyde Space. Datasheet, "Photon." [Online]. Accessed: July 17, 2021. [https://www.aac-clyde.space/assets/000/000/078/PHOTON\\_original.pdf?1564954830](https://www.aac-clyde.space/assets/000/000/078/PHOTON_original.pdf?1564954830)
- (12) Blue Canyon Technologies. Datasheet, "Power Systems." [Online] Accessed: July 19, 2021. [https://www.bluecanyontech.com/static/datasheet/BCT\\_DataSheet\\_Components\\_Power\\_Systems.pdf](https://www.bluecanyontech.com/static/datasheet/BCT_DataSheet_Components_Power_Systems.pdf)
- (13) DHV Technology. Products - Solar Panels for CubeSats. [Online] 2020. <https://dhvtechnology.com/products>
- (14) Exoterra. Fold Out Solar Arrays (FOSA) Datasheet [Online]. <https://exoterracorp.com/products/power/>
- (15) MMA. HAWK (PAT.) CUBESAT SOLAR ARRAYS. 2015.



- (16) MMA\_Design. rHaWK Solar Array. [Online] May 16, 2020. [Cited: May 16, 2020.] <https://mmadesignllc.com/product/r-hawk-solar-array/>.
- (17) Airbus Defense and Space Netherlands: Datasheet, "Sparkwing: The plug and play solution in power your small satellite." [Online] Accessed: July 16, 2021. <https://sparkwing.space/>
- (18) Agencia Espacial Civil Ecuatoriana. Datasheet, "DSA: 1U Deployable Solar Arrays." [Online] Accessed: July 18, 2021. <https://satsearch.co/products/exa-1u-deployable-solar-panels-dsa-1a>
- (19) GomSpace Datasheet, "Nanopower Deployable Solar Panel for 3U or 6U satellite." [Online] Accessed: July 18, 2021. [https://gomspace.com/UserFiles/Subsystems/datasheet/GS-DS-NanoPower\\_DSP\\_1018088\\_25.pdf](https://gomspace.com/UserFiles/Subsystems/datasheet/GS-DS-NanoPower_DSP_1018088_25.pdf)
- (20) Innovative Solutions in Space: "Small satellite solar panels." 2021. [Online] Accessed: July 18, 2021. <https://www.isispace.nl/product/isis-cubesat-solar-panels/>
- (21) Redwire Space. "Redwire's Innovative Solar Array Technology Powering the Future of Space Exploration." May 25, 2021. [Online] Accessed: July 18, 2021. <https://redwirespace.com/2021/05/25/redwires-innovative-solar-array-technology-powering-the-future-of-space-exploration/>
- (22) Seeger, Daniel. "Fraunhofer ISE Announces 33% Efficiency for Multi-junction Solar Cell." [Online] 2018. <https://www.pv-magazine.com/2018/04/04/fraunhofer-ise-announces-33-efficiency-for-multi-junction-solar-cell/>
- (23) King, R. "Raising the Efficiency Ceiling in Multijunction Solar Cells." Stanford Photonics Research Center Symposium, 2009. 2015.
- (24) Brown, Collin, et al. "An Investigation of Flexible Cu(In,Ga)Se<sub>2</sub> Solar Cells Under Low Intensity Low Temperature for Potential Applications for Outer Planetary Missions." IEEE Journal of Photovoltaics. 2019.
- (25) Toyobo Co., Ltd. "Toyobo to practicalize power-generating material for organic photovoltaics with world's top-level conversion efficiency under room light." May 23, 2020.
- (26) Cardinaletti, I., et al. "Organic and Perovskite Solar Cells for Space Applications." Solar Energy Materials and Solar Cells, p. 182. 2018.
- (27) Nagels, S. "OSCAR: the First Hasselt University Aerospace Project." 2020.
- (28) Meng, Lingxian, et al. "Organic and Solution-processed Tandem Solar Cells with 17.3% efficiency." 6407, Vol. 361. 2018.
- (29) N. Luo et al. "Hydrogen-Peroxide-Based Fuel Cells for Space Power Systems." Vol. 24, no. 3. 2008.
- (30) Ethier, V, et al. "Development of a CubeSat Water-Electrolysis Propulsion System." 2013.
- (31) "Radioisotope Power Systems (RPS) Program." National Aeronautics and Space Administration. 2015.
- (32) Light-Weight Radioisotope Heater Unit | Thermal Systems -. (n.d.). NASA RPS: Radioisotope Power Systems, from <https://rps.nasa.gov/power-and-thermal-systems/thermal-systems/light-weight-radioisotope-heater-unit/>





- (33) Joannopoulos, Aristeidis Karalis and J. D.. "'Squeezing' near-field thermal emission for ultra-efficient high-power thermophotovoltaic conversion." 2016.
- (34) Nighttime Photovoltaic Cells: Electrical Power Generation by Optically Coupling with Deep Space. Tristan Deppe and Jeremy N. Munday. ACS Photonics 2020 7 (1), 1-9. DOI: 10.1021/acsp Photonics.9b00679
- (35) EnduroSat. CubeSat 3U Solar Panel X/Y MTQ. [Online] 2017. <https://www.endurosat.com/products/cubesat-3u-solar-panel-x-y-mtq/>
- (36) Nelson, R. A.: "Spacecraft Battery Technology." 1999.
- (37) Jung, D. S. and Manzo, M. A.. "NASA Aerospace Flight Battery Program." NASA/TM-2010-216728/Vol I. 2010.
- (38) Eagle Pitcher. LP34100 Datasheet [Online] <https://www.eaglepitcher.com/sites/default/files/LP34100%205Ah%20021820.pdf>
- (39) EaglePitcher Technologies. "Lithium-Ion Space Battery." Data Sheet Catalog\_Part2\_Part5. Page 21
- (40) EaglePitcher Technologies. LP33330 Datasheet [Online] <https://www.eaglepitcher.com/sites/default/files/LP%2033330%206Ah%20Space%20Cell%200319.pdf>
- (41) EaglePitcher Technologies. LP32975 Datasheet [Online] <https://www.eaglepitcher.com/sites/default/files/LP%2032975%2012%20Ah%20Space%20Cell%20%20040219.pdf>
- (42) GomSpace. Datasheet, "NanoPower BPX." [Online]. Accessed: July 19, 2021. <https://gomspace.com/shop/subsystems/power/nanopower-bpx.aspx>
- (43) GomSpace. Datasheet, "NanoPower BP4." [Online]. Accessed: July 19, 2021. <https://gomspace.com/shop/subsystems/power/nanopower-bp4.aspx>
- (44) AAC Clyde Space. Datasheet, "Optimus Battery." July 28. 2020.
- (45) Ibeos. Cubesat Product Overview. [Online] 2020. Accessed: July 16, 2021. <https://ibeos.com/products.html>.
- (46) Saft. 4s1p VES16 Battery [Online]. 2019. <https://www.saftbatteries.com/products-solutions/products/4s1p-ves16-battery>
- (47) Vectronic Aerospace. Li-Ion Battery Block VLB-4/ -8 /-16. 2014.[Online] Accessed July 18, 2021. <https://satsearch.co/products/vectronic-aerospace-li-ion-battery-block-vlb-4-8-16>
- (48) Berlin Space Technologies. BCT 110 Datasheet.
- (49) Samsung. INR18650-35E Datasheet [Online]. Accessed: July 18, 2021. <https://www.orbtronic.com/content/samsung-35e-datasheet-inr18650-35e.pdf>
- (50) Sony: Murata. US18650VC7 Battery Datasheet [Online]. Accessed: July 18, 2021. [https://www.batterypacks.com/content/sony\\_us18650vc7.pdf](https://www.batterypacks.com/content/sony_us18650vc7.pdf)
- (51) Panasonic. NCR18650B Datasheet [Online]. <https://www.orbtronic.com/content/NCR18650B-Datasheet-Panasonic-Specifications.pdf>



- (52) Panasonic. NCR18650A Datasheet [Online].  
[https://www.orbtronic.com/product\\_images/uploaded\\_images/panasonic-ncr18650a-datasheet-specs-sanyo-18650-battery-specifications.png](https://www.orbtronic.com/product_images/uploaded_images/panasonic-ncr18650a-datasheet-specs-sanyo-18650-battery-specifications.png)
- (53) LG Chem. Product Specification: Rechargeable Lithium Ion Battery Model ICR18650 B3 2600mAh. 2007
- (54) Molicel. ICR18650M Rechargeable Battery [Online].  
<https://www.custompower.com/documents/ICR18650M.pdf>
- (55) Molicel. IHR18650C Datasheet [Online]. [http://www.molicel.com/wp-content/uploads/DM\\_IHR18650C-V4-80073.pdf](http://www.molicel.com/wp-content/uploads/DM_IHR18650C-V4-80073.pdf)
- (56) Molicel. ICR18650H Datasheet [Online].  
<https://www.custompower.com/documents/ICR18650H.pdf>
- (57) Molicel. ICR18650J Datasheet [Online].  
<https://www.custompower.com/documents/ICR18650J.pdf>
- (58) Molicel. ICP103450DA Datasheet [Online].  
<https://www.custompower.com/documents/ICP103450DAProductDataSheetF.pdf>
- (59) Molicel. INR18650A Datasheet [Online] [http://www.molicel.com/wp-content/uploads/DM\\_INR18650A-V4-80078.pdf](http://www.molicel.com/wp-content/uploads/DM_INR18650A-V4-80078.pdf)
- (60) Molicel. Panasonic Lithium Ion NCR18650B. 2012.
- (61) A. Zimmerman, E. Jung: "Verification Sciences & Engineering Case Study of Counterfeit COTS Li-ion Cells." 2019. NASA Aerospace Battery workshop.
- (62) JPL. NASA Battery Workshop. [Online] Nov 19, 2019. [Cited: May 16, 2020.]  
[https://www.nasa.gov/sites/default/files/atoms/files/3-nasa\\_battery\\_workshop\\_nov\\_2019\\_high\\_power\\_li-ion\\_cells\\_final.pdf](https://www.nasa.gov/sites/default/files/atoms/files/3-nasa_battery_workshop_nov_2019_high_power_li-ion_cells_final.pdf)
- (63) T. G. Tranter et al 2020 J. Electrochem. Soc. 167 160544
- (64) Aravindan, V., Gnanaraj, J., Lee, Y., & Madhavi, S. (2014). Insertion-type electrodes for nonaqueous Li-ion capacitors. Chemical reviews, 114 23, 11619-35.
- (65) Raffaele, Ryne: "Demonstration of a Nano-Enabled Space." [Online] 2018.  
<https://ntrs.nasa.gov/archive/nasa/casi.ntrs.nasa.gov/20170011060.pdf>.
- (66) Karkkainen, Ryan L.: "Development of Lightweight CubeSat with Multi-Functional Structural Battery Systems." [Online] 2018.  
<https://ntrs.nasa.gov/archive/nasa/casi.ntrs.nasa.gov/20170011078.pdf>.
- (67) Faure, Bertrand, Cosqueric, Laurence Gineste, and Valéry: "Evaluation and Qualification of Commercial Off-The-Shelf Supercapacitors for Space." 2nd Space Passive Component Days (SPCD) International Symposium. Noordwijk, The Netherlands: s.n., 2016.
- (68) SupercapTech. SupercapTech. [Online] May 21, 2016. [Cited: June 1, 2020.]  
<https://www.supercaptech.com/battery-vs-supercapacitor>.
- (69) POWERBOX. "The Silent Power of Supercapacitors." White paper 017. 2019.
- (70) Gipson, L. (2021, April 7). NASA Seeks to Create a Better Battery with SABERS. NASA.  
<https://www.nasa.gov/feature/nasa-seeks-to-create-a-better-battery-with-sabers/>
- (71) Pumpkin, Inc. CubeSat Kit Electrical Power System 1 (EPS1). 2018.



- (72) AAC Clyde Space. Starbuck Micro Original Datasheet. 2020.
- (73) AAC Clyde Space. Starbuck Mini Original Datasheet. 2020.
- (74) AAC Clyde Space. Starbuck Nano Original Datasheet. 2020.
- (75) GomSpace. NanoPower P31u. [Online] 2018. [Accessed: July 16, 2021.] <https://gomspace.com/Shop/subsystems/power-supplies/nanopower-p31u.aspx>.
- (76) Innovative Solutions in Space. IEPS Electrical Power System. [Online] 2020. <https://www.ISISPACE.nl/product/ieps-electrical-power-system/>
- (77) DHV Technology. Datasheet, "EPS Module."
- (78) Extreme Engineering Solutions: "XPm2020." 2021. [Online] Accessed: July 20, 2021. <https://www.xes-inc.com/products/end-of-life-power-supplies/xpm2020/>
- (79) EnduroSat. EPS I [Online] <https://www.endurosat.com/cubesat-store/cubesat-power-modules/eps-power-module/>
- (80) EnduroSat. EPS I Plus [Online] <https://www.endurosat.com/cubesat-store/cubesat-power-modules/eps-power-module-i-plus/>
- (81) EnduroSat. EPS II + Battery Pack [Online] <https://www.endurosat.com/cubesat-store/cubesat-power-modules/eps-power-module-ii/>
- (82) Ecarver GmbH: "Satellite Power Systems: Power Control Unit PCU-SB7." [Online] Accessed: July 18, 2021. <https://satellite-power-systems.de/products.html>
- (83) Berlin Space Technologies. "Power Control Unit PCU-110." [Online]. Accessed: July 19, 2021. <https://www.berlin-space-tech.com/portfolio/powercontrolunit-pcu-110/>
- (84) Ibeos. Datasheet, "150-Watt SmallSat Electric Power Subsystem (EPS)." 2019.
- (85) NanoAvionics. CubeSat Electrical Power System "EPS" CubeSat Solar Panels & Power Systems. Electrical Power System "EPS". [Online] 2017. [Cited: July 15, 2018.] <https://nanoavionics.com/cubesat-components/solar-panels-and-power-systems/cubesat-electrical-power-system-eps/>.
- (86) Lim, T M, et al. "A Modular Electrical Power System." IEEE. 2017.
- (87) Canon. BP-930 Material Safety Data Sheet. 2011.
- (88) Mahdi Soltani, S. Hamidreza Beheshti, A comprehensive review of lithium ion capacitor: development, modelling, thermal management and applications, Journal of Energy Storage, Volume 34, 2021.
- (89) Nanoavionics. "Solar-panels-and-power-systems: cubesat-gaas-solar-panel." [Online] 2020. [Accessed: May 16, 2020.] <https://nanoavionics.com/cubesat-components/cubesat-gaas-solar-panel/>.
- (90) NASA. 2020 Mission Perseverance Rover: Power Source." [Online] 2020. [Accessed: September 27, 2021.] <https://mars.nasa.gov/mars2020/spacecraft/rover/electrical-power/>
- (91) Colozza, A.J. and Cataldo, R.L. "Low Power Radioisotope Conversion Technology and Performance Summary". 2018.



## Chapter Contents

Glossary .....	ii
4.0 In-Space Propulsion .....	52
4.1 Introduction .....	52
4.1.1 Document Organization .....	53
4.2 Public Data Sources and Disclaimers .....	53
4.3 Definitions .....	54
4.4 Technology Maturity .....	54
4.4.1 Application of the TRL Scale to Small Spacecraft Propulsion Systems .....	54
4.4.2 Progress Toward Mission Infusion (PMI) .....	55
4.5 Overview of In-Space Propulsion Technology Types .....	58
4.6 State-of-the-Art in Small Spacecraft Propulsion .....	60
4.6.1 In-Space Chemical Propulsion .....	60
4.6.2 In-Space Electric Propulsion .....	73
4.6.3 In-Space Propellant-less Propulsion .....	92
References .....	106



## Chapter Glossary

(ABS)	Acrylonitrile Butadiene Styrene
(AC)	Alternating Current
(ACE)	Apollo Constellation Engine
(ACO)	Announcement for Collaborative Opportunity
(ADN)	Ammonium Dinitramide
(AFRL)	Air Force Research Laboratory
(AFRL)	U.S. Air Force Research Laboratory
(AOCS)	Attitude and Orbit Control System
(AR)	Aerojet Rocketdyne
(ARC)	Ames Research Center
(CMNT)	Colloid MicroNewton Thrusters
(CNAPS)	Canadian Nanosatellite Advanced Propulsion System
(CNES)	French National Center for Space Studies
(CPOD)	CubeSat Proximity Operations Demonstration
(CUA)	CU Aerospace LLC
(DFMR)	Design for Minimum Risk
(DRM)	Design Reference Mission
(DSSP)	Digital Solid State Propulsion LLC
(EMC)	Electromagnetic Compatibility
(EMI)	Electromagnetic Interference
(EP)	Electric Propulsion
(EPSS)	Enabling Propulsion System for Small Satellites
(ESA)	European Space Agency
(ESPs)	Electrically Controlled Solid Propellant
(FASTSAT)	Fast, Affordable, Science and Technology Satellite
(FEED)	Field Emission Electric Propulsion
(FPPT)	Fiber-Fed Pulsed Plasma Thruster
(GEO)	Geostationary Equatorial Orbit
(GIT)	Gridded-ion Thrusters
(GOCE)	Gravity Field and Steady-State Ocean Circulation Explorer
(GOX)	Gaseous Oxygen
(GPIM)	Green Propellant Infusion Mission



(GPS)	Global Positioning System
(GRC)	Glenn Research Center
(GSFC)	Goddard Space Flight Center
(HAN)	Hydroxylammonium Nitrate
(HET)	Hall-effect Thruster
(HTP)	High Test Peroxide
(HTPB)	Hydroxyl-terminated Polybutadiene
(IPS)	Integrated Propulsion System
(ISS)	International Space Station
(JHU ERG)	Johns Hopkins University Energetics Research Group
(JPL)	Jet Propulsion Laboratory
(LFPS)	Lunar Flashlight Propulsion System
(LISA)	Laser Interferometer Space Antenna
(MAPS)	Modular Architecture Propulsion System
(MarCO)	Mars Cube One
(MCD)	Micro-cavity Discharge
(MEMS)	Microelectromechanical System
(MEO)	Medium Earth Orbit
(MMH)	Monomethyl Hydrazine
(MPUC)	Monopropellant Propulsion Unit for CubeSats
(MSFC)	Marshall Space Flight Center
(MVP)	Monofilament Vaporization Propulsion
(N <sub>2</sub> O)	Nitrous Oxide
(NEA)	Near-Earth Asteroid
(NODIS)	NASA Online Directives Information System
(NSTT)	Nanosat Terminator Tape
(OTS)	Orbital Transfer System
(OTV)	Orbital Transfer Vehicle
(PacSci EMC)	Pacific Scientific Energetic Materials Company
(PBM)	Plasma Brake Module
(PMD)	Propellant Management Device
(PMDs)	Propellant Management Devices
(PMI)	Progress toward Mission Infusion
(PMMA)	Polymethyl Methacrylate



(PPT)	Pulsed Plasma Thrusters
(PPU)	Power Processing Unit
(PTD)	Pathfinder Technology Demonstration
(PTFE)	Polytetrafluoroethylene
(PUC)	Propulsion Unit for CubeSats
(ROMBUS)	Rapid Orbital Mobility Bus
(SAA)	Space Act Agreement
(SBIR)	Small Business Innovative Research
(SCAPE)	Self Contained Atmospheric Protective Ensemble
(SEP)	Solar Electric Propulsion
(SMAP)	Soil Moisture Active Passive
(SMART-1)	Small Missions for Advanced Research in Technology
(SME)	Subject Matter Experts
(SSTL)	Surrey Satellite Technology Ltd.
(SSTP)	Small Spacecraft Technologies Program
(TCMs)	Trajectory Correction Maneuvers
(TMA)	Technology Maturity Assessment
(TRL)	Technology Readiness Level
(UTIAS)	University of Toronto Institute for Aerospace Research
(VAT)	Vacuum arc thrusters
(VENuS)	Vegetation and Environment monitoring on a New Microsatellite
(WFF)	Wallops Flight Facility



## 4.0 In-Space Propulsion

### 4.1 Introduction

In-space propulsion devices for small spacecraft are rapidly increasing in number and variety. Although a mix of small spacecraft propulsion devices have established flight heritage, the market for new propulsion products continues to prove dynamic and evolving. In some instances, systems and components with past flight heritage are being reconsidered to meet the needs of smaller spacecraft. This approach minimizes new product development risk and time to market by creating devices similar to those with existing spaceflight heritage, albeit accounting for small spacecraft volume, mass, power, safety and cost considerations. Such incremental advancement benefits from existing spaceflight data, physics-based models, and customer acceptance of the heritage technologies, which eases mission infusion. In other instances, novel technologies are being conceived specifically for small spacecraft. These technologies often use innovative approaches to propulsion system design, manufacturing, and integration. While the development of novel technologies typically carries a higher risk and slower time to market, these new technologies strive to offer small spacecraft a level of propulsive capability not easily matched through the miniaturization of heritage technologies. Such novel devices are often highly integrated and optimized to minimize the use of a small spacecraft's limited resources, lower the product cost, and simplify integration. Regardless of the development approach, the extensive investments by commercial industry, academia, and government to develop new propulsion products for small spacecraft suggests long-term growth in the availability of propulsion devices with increasingly diverse capabilities.

In the near-term, the surge in public and private investments in small spacecraft propulsion technologies, in combination with the immaturity of the overall small spacecraft market, has resulted in an abundance of confusing, unverified, sometimes conflicting, and otherwise incomplete technical literature. Furthermore, the rush by many device developers to secure market share has resulted in some confusion surrounding the true readiness of these devices for mission infusion. As third parties independently verify device performance, and end-users demonstrate these new devices in their target environments, the true maturity, capability, and flight readiness of these devices will become evident. In the meantime, this report will attempt to reduce confusion by compiling a list of publicly described small spacecraft propulsion devices, identifying publicly available technical literature for further consideration, recognizing missions of potential significance, and organizing the data to improve comprehension for both neophytes and subject matter experts.

This chapter avoids a direct technology maturity assessment (TMA) based on the NASA Technology Readiness Level (TRL) scale, recognizing insufficient in-depth technical insight into current propulsion devices to perform such an assessment accurately and uniformly. An accurate TRL assessment requires a high degree of technical knowledge on a subject device as well as an understanding of the intended spacecraft bus and target environment. While the authors strongly encourage a TMA that is well-supported with technical data prior to infusing technologies into programs, the authors believe TRLs are most accurately assessed within the context of a program's unique requirements. Rather than attempting to assess TRL in the absence of sufficient data, this chapter introduces a novel classification system that simply recognizes Progress toward Mission Infusion (PMI) as an early indicator of the efficacy of the manufacturers' approach to system maturation and mission infusion. PMI should not be confused with TRL as PMI does not directly assess technology maturity. However, PMI may prove insightful in early trade studies. The PMI classification system used herein is described in detail in Section 4.4.2.





### 4.1.1 Document Organization

This chapter organizes the state-of-the-art in small spacecraft propulsion into the following categories:

1. In-Space Chemical Propulsion (4.6.1)
2. In-Space Electric Propulsion (4.6.2)
3. In-Space Propellant-less Propulsion (4.6.3)

Each of these categories is further subdivided by the prevailing technology types. The subsections organize data on each prevailing technology type as follows:

- a. Technology Description
- b. Key Integration and Operational Considerations
- c. Current & Planned Missions
- d. Summary Table of Devices
- e. Notable Advancements

The organizational approach introduces newcomers to each technology, presents technology-specific integration and operation concerns for the reader's awareness, highlights recent or planned missions that may raise the TRL of specific devices, and finally tabulates procurable devices of each technology. Some sections further include an incomplete list of highlights of notable advancements. While the key integration and operational considerations are not all-inclusive, they provide initial insights that may influence propulsion system selection. In the cases where a device has significant flight heritage, this chapter reviews only select missions.

## 4.2 Public Data Sources and Disclaimers

This chapter is a survey of small spacecraft propulsion technologies as discussed in open literature and does not endeavor to be an original source. As such, this chapter only considers literature found in the public domain to identify and classify devices. Commonly used sources for public data include manufacturer datasheets, press releases, conference papers, journal papers, public filings with government agencies, and news articles.

This chapter summarizes device performance, capabilities, and flight history, as presented in publicly available literature. Data not appropriate for public dissemination, such as proprietary, export controlled, or otherwise restricted data, are not considered. As such, actual device maturity and flight history may be more extensive than what is documented herein. Device manufacturers should be consulted for the most up-to-date and relevant data before performing a TMA.

This chapter's primary data source is literature produced by device manufacturers. Unless otherwise published, do not assume independent verification of device performance and capabilities. Performance and capabilities described may be speculative or otherwise based on limited data.

The information described below is not intended to be exhaustive but to provide a general overview of current state-of-the-art technologies and their development status. It should be noted that technology maturity designations may vary with change to payload, mission requirements, reliability considerations, and/or the environment in which performance was demonstrated. Readers are highly encouraged to reach out to companies for further information regarding the performance and maturity of the described technology. There is no intention of mentioning certain companies and omitting others based on their technologies or relationship with NASA.

Suggestions or corrections to this document should be submitted to the NASA Small Spacecraft Virtual Institute [Agency-SmallSat-Institute@mail.nasa.gov](mailto:Agency-SmallSat-Institute@mail.nasa.gov) for consideration prior to the



publication of future issues. When submitting comments, please cite appropriate publicly accessible references. Private correspondence is not considered an adequate reference.

### 4.3 Definitions

- *Device* refers to a component, subsystem, or system, depending on the context.
- *Technology* refers to a broad category of devices or intangible materials, such as processes.

### 4.4 Technology Maturity

#### 4.4.1 Application of the TRL Scale to Small Spacecraft Propulsion Systems

NASA has a well-established guideline for performing TMAs, described in detail in the NASA Systems Engineering Handbook (1). A TMA determines a device's technological maturity, which is usually communicated according to the NASA TRL scale. The TRL scale is defined in NASA Procedural Requirements (NPR) 7123 (2). The NASA Systems Engineering Handbook and NPR 7123 can be accessed through the NASA Online Directives Information System (NODIS) library. Assessment of TRLs for components, systems, or software allows for coherent communication between technologists, program managers, and other stakeholders regarding the maturity of a technology. Furthermore, TRL is a valuable tool to communicate the potential risk associated with the infusion of technologies into programs. For TRLs to be applied across all technology categories, the NASA TRL definitions are written broadly and rely on subject matter experts (SME) in each discipline to interpret appropriately.

Recently, U.S. Government propulsion SMEs suggested an interpretation of the TRL scale specifically for micro-propulsion. The Micro-Propulsion Panel of the JANNAF Spacecraft Propulsion Subcommittee in 2019 published the *JANNAF Guidelines for the Application of Technology Readiness Levels (TRLs) to Micro-Propulsion Systems* (3). This guideline suggests an interpretation of TRL for micro-propulsion and reflects both NASA and DOD definitions for TRL. The JANNAF panel consisted of participants from the Air Force Research Laboratory (AFRL), Glenn Research Center (GRC), Jet Propulsion Laboratory (JPL), and Goddard Space Flight Center (GSFC). The panel further received feedback from the non-Government propulsion community. While this JANNAF guideline focuses on micro-propulsion (e.g., for CubeSats), the guideline still has relevance to rigorously assessing TRLs for the more general category of small spacecraft in-space propulsion. By establishing a common interpretation of TRL for small spacecraft propulsion, a more coherent and consistent communication of technology maturity can occur between small spacecraft propulsion providers and stakeholders. The JANNAF guideline is open to unlimited distribution and may be requested from the Johns Hopkins University Energetics Research Group (JHU ERG). Ensure the use of the latest JANNAF guideline, as the guideline is anticipated to evolve with further community input.

A fundamental limitation of the JANNAF guideline for TRL assessment, and TMA in general, is an assumption of in-depth technical knowledge of the subject device. In the absence of detailed technical knowledge, especially in a broad technology survey as presented herein, a TMA may be conducted inaccurately or inconsistently. Furthermore, assessment of TRL assumes an understanding of the end-user application. The same device may be concluded to be at different TRLs for infusion into different missions. For example, a device may be assessed at a high TRL for application to low-cost small spacecraft in low-Earth orbits, while assessed at a lower TRL for application to geosynchronous communication satellites or NASA interplanetary missions due to different mission requirements. Differences in TRL assessment based on the operating environment may result from considerations such as thermal environment, mechanical loads, mission duration, or radiation exposure. Propulsion-specific variances between missions might



include propellant type, total propellant throughput, throttle set-points, burn durations, and the total number of on/off cycles. As such, an accurate TRL assessment not only requires an in-depth technical understanding of a device's development history, including specifics on past flight-qualification activities, but also an understanding of mission-specific environments and interfaces. The challenge of assessing an accurate TRL in a broad technology survey poses a significant burden for data collection, organization, and presentation. Such activities are better suited for the programs seeking to infuse new technologies into their missions.

Given the rapid evolution of small spacecraft propulsion technologies and the variety of mission environments, as well as generally limited device technical details in open literature, the propulsion chapter implements a novel system to classify technical maturity according to Progress toward Mission Infusion (PMI). This novel classification system is not intended to replace TRL but is a complementary tool to provide initial insight into device maturity when it is not feasible to accurately and consistently apply the TRL scale. This novel classification system is discussed in detail below.

Readers using this survey are strongly encouraged to perform more in-depth technical research on candidate devices based on the most up-to-date information available, as well as to assess risk within the context of their specific mission(s). A thoughtful TMA based on the examination of detailed technical data through consultation with device manufactures can reduce program risk and in so doing increase the likelihood of program success. This survey is not intended to replace the readers' own due diligence. Rather, this survey and PMI seek to provide early insights that may assist in propulsion system down-select to a number of devices where an in-depth TMA becomes feasible.

#### **4.4.2 Progress Toward Mission Infusion (PMI)**

Rather than directly assessing a device's technical maturity via TRL, propulsion devices described herein are classified according to evidence of progress toward mission infusion. This is a novel classification system first introduced in this survey. Assessing the PMI of devices in a broad survey, where minimal technical insight is available, may assist with down-selecting propulsion devices early in mission development. Once a handful of devices are selected for further consideration, an in-depth technical examination of the selected devices may be more practical to conduct a TMA and rigorously assess TRL. The PMI classification system sorts devices into one of four broad technology development categories: Concept, In-Development, Engineering-to-Flight, and Flight-Demonstrated. The following sections describe the PMI classification system in detail. Furthermore, figure 4.1 summarizes the PMI classifications.

##### **Concept, 'C'**

The *Concept* classification reflects devices in an early stage of development, characterized by feasibility studies and the demonstration of fundamental physics. Concept devices typically align with the NASA TRL range of 1 to 3. At a minimum, these devices are established as scientifically feasible, perhaps through a review of relevant literature and/or analytical analysis. These devices may even include experimental verification that supports the validity of the underlying physics. These devices may even include notional designs. While Concept devices are generally not reviewed herein, particularly promising Concept devices will be classified in tables with a 'C'.

##### **In-Development, 'D'**

The *In-Development* classification reflects the bulk of devices being actively matured and covered in this survey, where only a modest number of devices may progress to regular spaceflight. In-Development devices typically align with the NASA TRL range of 4 to 5. While In-Development



devices may have specific applications attributed by their developers, no selection for a specific mission has been publicly announced. In the absence of a specific mission, device development activities typically lack rigorous system requirements and a process for independent requirement validation. Furthermore, qualification activities conducted in the absence of a specific mission typically require a delta-qualification to address mission-specific requirements. At a minimum, In-Development devices are low-fidelity devices that have been operated in an appropriate environment to demonstrate basic functionality and support prediction of the device's ultimate capabilities. They may even be medium- or high-fidelity devices operated in a simulated final environment, but lacking a specific mission pull to define requirements and a qualification program. They may even be medium- or high-fidelity devices operated in a spaceflight demonstration but lacking sufficient fidelity or demonstrated capability to reflect the anticipated final product. These devices are typically described as a technology push, rather than a mission pull. In-Development devices will be classified in tables with a 'D'.

### Engineering-to-Flight, 'E'

The *Engineering-to-Flight* classification reflects devices with a publicly announced spaceflight opportunity. This classification does not necessarily imply greater technical maturity than the In-Development classification, but it does assume the propulsion device developer is receiving mission-specific requirements to guide development and qualification activities. Furthermore, the Engineering-to-Flight classification assumes a mission team performed due diligence in the selection of a propulsion device, and the mission team is performing regular activities to validate that the propulsion system requirements are met. Thus, while the PMI classification system does not directly assess technical maturity, there is an underlying assumption of independent validation of mission-specific requirements, where a mission team does directly consider technical maturity in the process of device selection and mission infusion. Engineering-to-Flight devices typically align with the NASA TRL range of 5 to 6. At a minimum, these are medium-fidelity devices that have been operated in a simulated final environment and demonstrate key capabilities relative to the requirements of a specific mission. These devices may even be actively undergoing or have completed a flight qualification program. These devices may even include a spaceflight, but in which key capabilities failed to be demonstrated or further engineering is required. These devices may even include a previously successful spaceflight, but the devices are now being applied in new environments or platforms that necessitate design modifications and/or delta-qualification. These devices must have a specific mission pull documented in open literature. A design reference mission (DRM) may be considered in place of a specific mission pull, given detailed documentation in open literature, which includes a description of the DRM, well-defined propulsion system requirements, maturation consistent with the DRM requirements, and evidence of future mission need. Engineering-to-Flight devices will be classified in tables with an 'E'.

### Flight-Demonstrated, 'F'

The *Flight-Demonstrated* classification reflects devices where a successful technology demonstration or genuine mission has been conducted and described in open literature. Flight-Demonstrated devices typically align with the NASA TRL range of 7 to 9. These devices are high-fidelity components or systems (in fit, form, and function) that have been operated in the target in-space environment (i.e., low-Earth orbit, GEO, deep space) on an appropriate platform, where all key capabilities were successfully demonstrated. These devices may even be final products, which have completed genuine missions (not simply flight demonstrations). These devices may even be in repeat production and routine use for several missions. The devices must be described in open literature as successfully demonstrating key capabilities in the target environment to be considered Flight-Demonstrated. If a device has flown, but the outcome is not publicly known, the



classification will remain Engineering-to-Flight. Flight-Demonstrated devices will be classified in tables with an 'F'.

<p><b>Concept, 'C'</b></p> <ul style="list-style-type: none"> <li>- At minimum, an idea has been established as scientifically feasible.</li> <li>- May even include experimental verification of the underlying physics.</li> <li>- May even include notional device designs.</li> <li>- Approximately aligns to NASA TRL 1-3</li> </ul>
<p><b>In-Development, 'D'</b></p> <ul style="list-style-type: none"> <li>- At minimum, a low-fidelity device that has been operated in an appropriate environment to demonstrate the basic functionality and predict the ultimate capabilities.</li> <li>- May even be a medium- or high-fidelity device operated in a simulated final environment, but the device lacks a specific mission pull to define requirements and a qualification program.</li> <li>- May even be a medium- or high-fidelity device operated in a flight demonstration, but the device lacks sufficient fidelity or demonstrated capability to reflect the anticipated final product.</li> <li>- Approximately aligns to NASA TRL 4-5</li> </ul>
<p><b>Engineering-to-Flight, 'E'</b></p> <ul style="list-style-type: none"> <li>- At minimum, a medium-fidelity device that has been operated in a simulated final environment and demonstrates key capabilities relative to the requirements of a specific mission.</li> <li>- May even include a qualification program in-progress or completed.</li> <li>- May even include a spaceflight, but the device fails to demonstrate key capabilities.</li> <li>- May even include a successful spaceflight, but the device is now being applied in a new environment or platform, necessitating a delta-qualification.</li> <li>- A specific mission opportunity must be identified in open literature.</li> <li>- Approximately aligns to NASA TRL 5-6</li> </ul>
<p><b>Flight-Demonstrated, 'F'</b></p> <ul style="list-style-type: none"> <li>- At minimum, a high-fidelity component or system (fit, form, and function) that has been operated in the intended in-space environment (e.g., LEO, GEO, deep space) on an appropriate platform, where key capabilities have been successfully demonstrated.</li> <li>- May even be a final product that has completed a mission (not strictly a technology demonstration).</li> <li>- May even be a product in repeat production and routine use for a number of missions.</li> <li>- A successful spaceflight must be identified and the outcome described in open literature.</li> <li>- Approximately aligns to NASA TRL 7-9</li> </ul>

Figure 4.1: Progress toward mission infusion (PMI) device classifications. Credit: NASA.



## 4.5 Overview of In-Space Propulsion Technology Types

In-space small spacecraft propulsion technologies are generally categorized as (i) chemical, (ii) electric, or (iii) propellant-less. This chapter surveys propulsion devices within each technology category. Additionally, liquid-propellant acquisition and management devices are reviewed as an important component of in-space propulsion systems. Although other key subsystems have not yet been reviewed, such as small spacecraft propulsion power processing units, they may be included in future updates of this publication. Table 4-1 lists the in-space propulsion technologies reviewed. Figure 4.2 graphically illustrates the range of thrust and specific impulse for these small spacecraft propulsion devices. The thrust and specific impulse ranges provided in table 4-1 and figure 4.1 only summarize the performance of small spacecraft devices covered in this survey and may not reflect the broader capability of the technologies beyond small spacecraft or the limits of what is physically possible with further technology advancement.

Chemical systems have enabled in-space maneuvering since the onset of the space age, proving highly capable and reliable. These include hydrazine-based systems, other mono- or bipropellant systems, hybrids, cold/warm gas systems, and solid propellants. Typically, these systems are sought when high thrust or rapid maneuvers are required. As such, chemical systems continue to be the in-space propulsion technology of choice when their total impulse capability is sufficient to meet mission requirements.

On the other hand, the application of electric propulsion devices has been historically far more limited. While electric propulsion can provide an order of magnitude greater total impulse than chemical systems, research and development costs have typically eclipsed that of comparable chemical systems. Furthermore, electric propulsion generally provides thrust-to-power levels below 75 mN/kW. Thus, a small spacecraft capable of delivering 500 W to an electric propulsion system may generate no more than 38 mN of thrust. Therefore, while the total impulse capability of electric propulsion is generally considerable, these systems may need to operate for hundreds or thousands of hours, compared to the seconds or minutes that chemical systems necessitate for a similar impulse. That said, the high total impulse and low thrust requirements of specific applications, such as station keeping, have maintained steady investment in electric propulsion over the decades. Only in recent years has the mission pull for electric propulsion reached a tipping point where electric propulsion may overtake chemical for specific in-space applications. Electric propulsion system types considered herein include electrothermal, electrospray, gridded ion, Hall-effect, pulsed plasma and vacuum arc, and ambipolar.

Propellant-less propulsion technologies such as solar sails, electrodynamic tethers, and aerodynamic drag devices have long been investigated, but they have yet to move beyond small-scale demonstrations. However, growing needs such as orbital debris removal may offer compelling applications in the near future.

Some notable categories are not covered in this survey, such as nuclear in-space propulsion technologies. While substantial investment continues in such areas for deep space science and human exploration, such technologies are generally at lower TRL and typically aim to propel spacecraft substantially larger than the 180 kg limit covered by this report.

Whenever possible, this survey considers complete propulsion systems, which are composed of thrusters, feed systems, pressurization systems, propellant management and storage, and power processing units, but not the electrical power supply. However, for some categories, components (e.g., thruster heads) are mentioned without consideration of the remaining subsystems necessary for their implementation. Depending on the device's intended platform (i.e., NanoSat, MicroSat, SmallSat), the propulsion system may be either highly integrated or distributed within



the spacecraft. As such, it is logical to describe highly integrated propulsion units at the system level, whereas components of distributed propulsion systems may be logically treated at the sub-system level, where components from a multitude of manufacturers may be mixed-and-matched to create a unique mission-appropriate propulsion solution.

<b>Table 4-1: Summary of Propulsion Technologies Surveyed</b>		
<b>Technology</b>	<b>Thrust Range</b>	<b>Specific Impulse Range [sec]</b>
<b>4.6.1 CHEMICAL PROPULSION TECHNOLOGIES</b>		
Hydrazine Monopropellant	0.25 – 25 N	200 – 285
Alternative Mono- and Bipropellants	10 mN – 120 N	160 – 310
Hybrids	1 – 230 N	215 – 300
Cold / Warm Gas	10 $\mu$ N – 3 N	30 – 110
Solid Motors	0.3 – 260 N	180 – 280
Propellant Management Devices	N/A	N/A
<b>4.6.2 ELECTRIC PROPULSION TECHNOLOGIES</b>		
Electrothermal	0.5 – 100 mN	50 – 185
Electrosprays	10 $\mu$ N – 1 mN	225 – 5,000
Gridded Ion	0.1 – 20 mN	1,000 – 3,500
Hall-Effect	1 – 60 mN	800 – 1,950
Pulsed Plasma and Vacuum Arc Thrusters	1 – 600 $\mu$ N	500 – 2,400
Ambipolar	0.25 – 10 mN	400 – 1,400
<b>4.6.3 PROPELLANTLESS PROPULSION TECHNOLOGIES</b>		
Solar Sails	TBD	N/A
Electrodynamic Tethers	TBD	N/A
Aerodynamic Drag	TBD	N/A

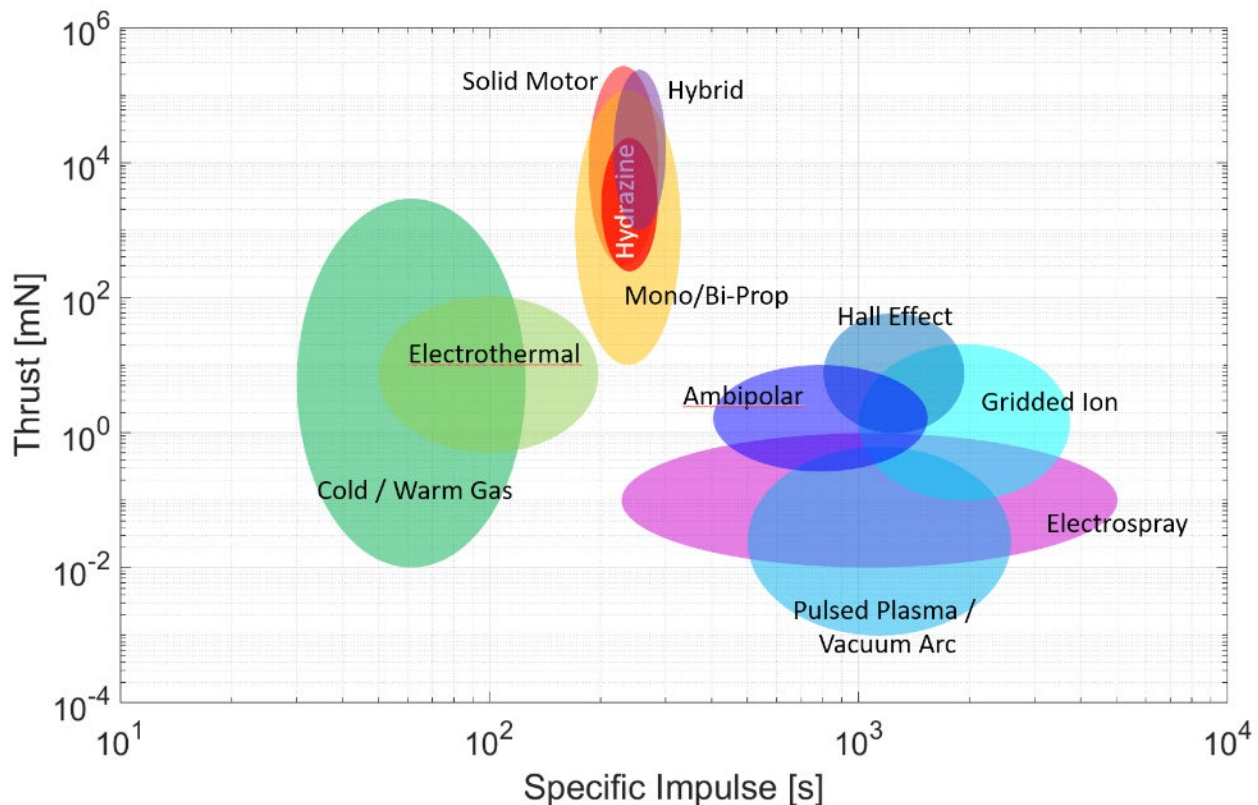


Figure 4.2: Typical small spacecraft in-space propulsion trade space (thrust vs. specific impulse). Credit: NASA.

## 4.6 State-of-the-Art in Small Spacecraft Propulsion

### 4.6.1 In-Space Chemical Propulsion

Chemical propulsion systems are designed to satisfy high-thrust impulsive maneuvers. They offer lower specific impulse compared to their electric propulsion counterparts but have significantly higher thrust to power ratios.

#### Hydrazine Monopropellant

##### a. Technology Description

Hydrazine monopropellant systems use catalyst structures (such as S-405 granular catalyst) to decompose hydrazine or a derivative such as monomethyl hydrazine (MMH) to produce hot gases. Hydrazine thrusters and systems have been in extensive use since the 1960's. The low mass and volume of a significant number of larger spacecraft hydrazine propulsion systems also allows those systems to be suitable for some small spacecraft buses. Thrusters that perform small corrective maneuvers and attitude control in large spacecraft may be large enough to perform high-thrust primary maneuvers for small spacecraft and can act as the main propulsion system. Hydrazine specific impulses are achievable in the 200 – 235 second range for 1-N class or larger thrusters.

##### b. Key Integration and Operational Considerations

Since hydrazine has been in use for some time, its traits are well defined (4). However, hydrazine (and its derivatives) is corrosive, toxic, and potentially carcinogenic. Its vapor pressure requires





the use of Self Contained Atmospheric Protective Ensemble (SCAPE) suits. This overhead increases the ground processing flow of spacecraft and may impose undesirable constraints on secondary spacecraft. Hydrazine propulsion systems typically incorporate redundant serial valves to prevent spills or leaks.

Because hydrazine systems are so widely used for larger spacecraft, a robust ecosystem of components and experience exists, and hydrazine propulsion systems are frequently custom designed for specific applications using available components. Typically, they also have the advantage of being qualified for multiple cold starts, which may be beneficial for power-limited buses if the lifespan of the mission is short.

#### c. Current & Planned Missions

ArianeGroup has developed a 1-N class hydrazine thruster that has extensive flight heritage, including use on the ALSAT-2 small spacecraft (5) (6).

Aerojet Rocketdyne has leveraged existing designs with flight heritage from large spacecraft that may be applicable to small buses, such as the MR-103 thruster used on New Horizons for attitude control (7). Other Aerojet Rocketdyne thrusters potentially applicable to small spacecraft include the MR-111 and the MR-106 (8). These thrusters have successfully flown on several missions.

Moog-ISP has extensive experience in the design and testing of propulsion systems and components for large spacecraft. These may also apply to smaller platforms, as some of their flight-proven thrusters are lightweight and have moderate power requirements. The MONARC-5 thrusters flew on NASA JPL's Soil Moisture Active Passive (SMAP) spacecraft in 2015 and provided 4.5 N of steady state thrust. Other thrusters potentially applicable to small spacecraft buses include the MONARC-1 and the MONARC-22 series (9).

#### d. Summary Table of Devices

See table 4-2 for current state-of-the-art hydrazine monopropellant devices applicable to small spacecraft.

#### e. Notable Advances

Aerojet Rocketdyne (AR) has developed a new class of green hydrazine propellant blends providing the low vapor-toxicity and high density- $I_{SP}$  of ionic liquids while retaining the low reaction and preheat temperatures of traditional hydrazine. This makes it possible to increase both safety and performance while still using conventional nickel-alloy catalytic thrusters. In testing completed to date, green hydrazine blends have demonstrated long-term thermal stability/storability, low shock/impact sensitivity, and good operational stability. Furthermore, they have demonstrated a 100-fold reduction in vapor pressure/toxicity and a similar low-temperature start capability as compared to pure hydrazine (10). Ongoing development efforts at Aerojet Rocketdyne, NASA GSFC, and the Aerospace Corporation are on track to advance the technical maturity of green hydrazine blends to flight-ready status by the end of 2022.



## Alternative Monopropellants and Bipropellants

### a. Technology Description

Alternative propellant technologies are increasingly being developed and adopted as a replacement for hydrazine, due to hydrazine's handling and toxicity concerns. These include replacements such as the emerging 'green' ionic liquids, and more conventional propellants like hydrogen peroxide or electrolyzed water (bi-propellant hydrogen/oxygen).

The primary ionic liquid propellants with flight heritage or upcoming spaceflight plans are LMP-103S, which is a blend of Ammonium Dinitramide (ADN), and AF-M315E (now: referred to as "ASCENT"), a blend of Hydroxylammonium Nitrate (HAN). Other alternative propellants, such as hydrogen peroxide, are also available and have been in use for many years. Some of these may be lower performing than hydrazine but offer more benign operating environments and require more readily available and lower-cost materials.

This group of ionic liquid propellants, commonly referred as 'green propellants', have reduced toxicity due in large part to the lower danger of component chemicals and significantly reduced vapor pressures as compared to hydrazine. The 'green' affiliation also results in potentially removing Self-Contained Atmospheric Protective Ensemble (SCAPE) suit requirements. The elimination of the SCAPE suit requirement reduces operational oversight by safety and emergency personnel, and potentially reduces secondary payload requirements. The 'green propellants' LMP-103S and ASCENT are ideally used as direct replacements for hydrazine. Usually, these green propellants are decomposed and combusted over a catalytic structure akin to hydrazine systems, which often requires pre-heating to decompose the propellant. However, they both require high catalyst pre-heating and have higher combustion temperatures. Therefore, these blends are not 'drop-in' replacements.

Green propellants also provide higher specific impulse performance than the current state-of-the-art hydrazine monopropellant thrusters for similar thrust classes and have a higher density-specific impulse achieving improved mass fractions. Additionally, these propellants have lower minimum storage temperatures which may be beneficial in power-limited spacecraft, as tank and line heater requirements are lower.

While other alternative propellant choices (such as electrolyzed water or hydrogen peroxide) are not 'green' propellants like the ionic liquids, they may also be considered within the 'green' category. They exhibit more benign characteristics relative to hydrazine and are therefore an alternative option to hydrazine. These alternative propellants are seen as particularly useful for small satellite applications, where the comparatively low mission cost can provide a mutual benefit in technology advancement and development while providing needed mission capabilities (11).

### b. Key Integration and Operational Considerations

Air Force Range Safety AFSPCMAN91-710 (12) requirements state that if a propellant is less prone to external leakage, which is often seen with the ionic liquid 'green' propellant systems due to higher viscosity of the propellant, then the hazardous classification is reduced. External hydrazine leakage is considered "catastrophic," whereas using ionic liquid green propellants reduces the hazard severity classification to "critical" and possibly "marginal" per MIL-STD-882E (Standard Practice for System Safety) (13). A classification of "critical" or less only requires two-seals to inhibit external leakage, meaning no additional latch valves or other isolation devices are required in the feed system (13). While these propellants are not safe for consumption, they have been shown to be less toxic compared to hydrazine. This is primarily due to green propellants having lower vapor pressures, being less flammable, and producing more benign constituent product gases (such as water vapor, hydrogen, and carbon dioxide) when combusted.



Fueling spacecraft with green propellants, generally permitted as a parallel operation, may require a smaller exclusionary zone, allowing for accelerated launch readiness operations (14). These green propellants are also generally less likely to exothermically decompose at room temperature due to higher ignition thresholds. Therefore, they require fewer inhibit requirements, fewer valve seats for power, and less stringent temperature storage requirements. The reduced hazard associated with some of these propellants may enable projects to take a Design for Minimum Risk (DFMR) approach to address some propulsion system safety concerns, but only with the support of associated range and payload safety entities.

While there are thrusters that are relatively mature (PMI E/F), incorporating them into propulsion systems is challenging, and the maturity of stand-alone propulsion systems has lagged the pace of component development. Historically, research and development efforts, like Small Business Innovative Research (SBIR) efforts, have focus on component development, and not the entire system. Efforts are now being made to focus on the development of system solutions. Most of these non-toxic propellants are still in some phase of development. Additionally, data on the propellants is also widely restricted. Therefore, a comprehensive, public, peer-reviewed databased of compatible materials does not currently exist, and would-be system developers using these propellants may have difficulty accessing such data to guide their efforts.

Other 'green propellants' such as Hydrogen Peroxide, High Test Peroxide (HTP), and HTP/Alcohol bipropellants also have their own unique handling considerations. For instance, HTP is a strong oxidizer and can exothermically decompose rapidly if improperly stored or handled. Hydrogen Peroxide, however, has been used as a rocket propellant for many decades, and there is a lot of information on safe handling, materials selection, and best practices. Electrolyzed water is another propellant option, wherein water is decomposed into hydrogen and oxygen and combusted as a traditional bi-propellant thruster. However, generating and managing the power required to electrolyze the water in a compact spacecraft presents its own unique challenges. Yet it does provide a safe-to-launch system with very benign constituents.

### c. Current & Planned Missions

Planet Labs launched a constellation of Earth observing satellites, called SkySat. These satellites are approximately 120 kg, and incorporate the Bradford-ECAPS HPGP system, a LMP-103S based system shown in figure 4.3. SkySats 3 – 21 include a propulsion system using four 1-N thrusters. As of August 2020, 13 SkySat satellites with the Bradford ECAPS propulsion system have been launched and are fully operational (15).



Figure 4.3: ECAPS HPGP thruster.  
Credit: Bradford ECAPS.

Astroscale has built and launched a highly maneuverable 'chaser' SmallSat called ELSA-d. ELSA-d is a twin SmallSat mission which will demonstrate key rendezvous and docking technologies, and proximity operational concepts in readiness for providing a commercial deorbit service (16). ELSA-d has an LMP-103S using eight 1-N Bradford ECAPS thrusters to provide both re-orbiting and de-orbiting capability. ELSA-d launched in March 2021.

The JPL-led Lunar Flashlight mission manifested for Artemis I will map the lunar south pole for volatiles. The mission will demonstrate several technological firsts, including being one of the first CubeSats to reach the Moon, the first planetary CubeSat mission to use green propulsion, and the first mission to use lasers to look for water ice (17).

NASA Marshall Space Flight Center (MSFC) led the development of the Lunar Flashlight Propulsion System (LFPS), a self-contained unit that can deliver over 3000 N-s of total impulse for this mission (figure 4.4). The LFPS is a pumped system that has four 100-mN ASCENT thrusters (figure 4.5), built by Plasma Processes LLC., and a micro-pump built by Flight Works Inc. The LFPS employs a propellant management device (PMD) and newly developed isolation and thruster micro-solenoid valves and a micro-fill/drain valve. The LFPS system was delivered to JPL in May 2021 and is now being integrated into the LF Spacecraft. The LFPS structural design and electronics controller development was performed by the Georgia Institute of Technology (Atlanta, GA).

Another ASCENT-based propulsion system flew as a technology demonstration on the NASA Green Propellant Infusion Mission (GPIM) launched in July 2019 (18). This small spacecraft was designed to test the performance of this propulsion technology in space by using five 1-N class thrusters (figure 4.6) for small attitude control maneuvers (19). Aerojet completed a hot-fire test of the GR-1 version in 2014 and further tests in 2015. Initial plans to incorporate the GR-22 thruster (22-N class) on the GPIM mission were deferred in mid-2015 to allow for more development and testing of the GR-22. As a result, the GPIM mission only carried and demonstrated five GR-1 units when launched (20).

CisLunar Explorer is part of a NASA Centennial Challenge mission planned for Artemis I. The CisLunar Explorer's concept consists of a pair of spacecrafts on a mission to orbit the Moon. The two spacecraft are mated together as a "6U"-sized box, and after deployment from the launch vehicle, they will split apart, and each give their initial rotation in the process of decoupling. The spacecraft will then enter and attempt to maintain lunar orbit. The propulsion system for this mission is a water electrolysis system developed by Cornell University (21).

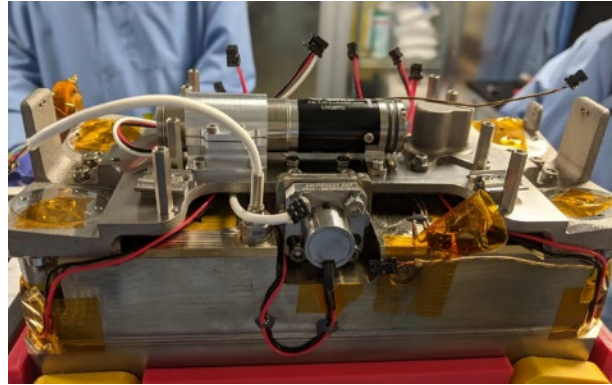


Figure 4.4: Lunar Flashlight Propulsion System. Credit NASA.



Figure 4.5: Plasma Processes LLC 100mN thruster. Credit: NASA MSFC.



Figure 4.6: GR1 thruster. Credit: Aerojet.

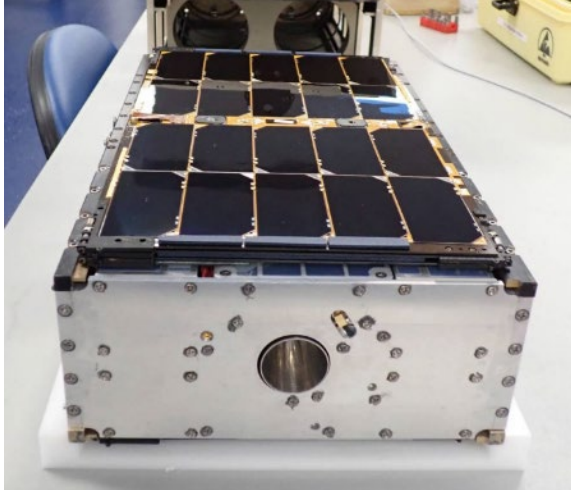
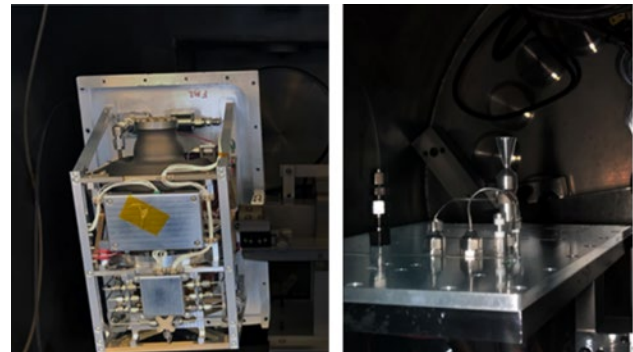


Figure 4.7: PTD-1 HYDROS-C Credit: NASA.

NASA's Small Spacecraft Technology (SST) program at Ames Research Center (ARC) have launched the first Pathfinder Technology Demonstration (PTD) mission in January 2021 (22) (23) (24). PTD-1 (figure 4.7) tested the HYDROS-C water electrolysis propulsion system, developed by Tethers Unlimited Inc. With a volume less than 2.4U, the HYDROS-C uses water as propellant. In-orbit, water was electrolyzed into oxygen and hydrogen, then combusted like a traditional bi-propellant thruster. Limited performance data is being evaluated, but is expected to provide an average thrust of 1.2 N with an  $I_{sp}$  of 310 s. The system requires 10 – 15 minutes of recharge time between pulses. A variant of the HYDROS-C system is the HYDROS-M system, which is intended to be sized for MicroSats.

Benchmark Space Systems has delivered its first three Halcyon propulsion systems (figure 4.8), which launched on June 30, 2021 on SpaceX's Transporter-2 rideshare mission. The Halcyon system combines an HTP thruster developed by legacy Tesseract with Benchmark's fluid handling and flight controller subsystems to provide a thrust of 1-N with an  $I_{sp}$  between 155-175s. It also uses proprietary on-demand pressurization technology, permitting it to be launch at low pressure (25).



Credit: Benchmark Space Systems.

VACCO Industries has built and delivered the first of its Integrated Propulsion System (IPS), which was designed to deliver 12,000 N-sec total impulse. The IPS (figure 4.9) features four 1-N LMP-103S Bradford ECAPS thrusters, using the LFP-103S propellant.

NanoAvionics has developed a non-toxic mono-propellant propulsion system called Enabling Propulsion System for Small Satellites (EPSS), which was demonstrated on LituaniaSAT-2, a 3U CubeSat, to correct orientation and attitude, avoid collisions, and extend orbital lifetime. It uses an ADN-blend as propellant, achieves 213 s of specific impulse, and provide 400 N-s of total impulse. LituaniaSAT-2 was launched in June 2017 and successfully separated from the primary payload (Cartosat-2) as part of the European QB50 initiative. According to product literature, multiple missions have since launched, with the latest being in April 2019 (26).

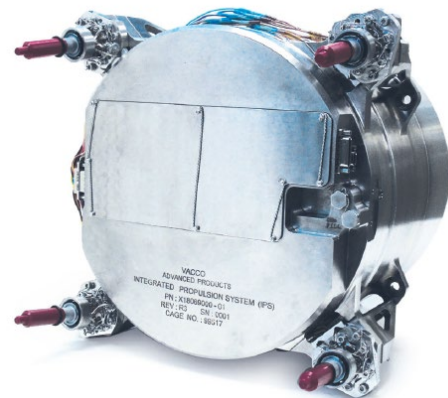


Figure 4.9: VACCO Industries IPS Credit: VACCO Industries.

Dawn Aerospace (formerly: Hyperion) has developed a 0.5 N bi-propellant system that consists of a single thruster with a gimbal to provide thrust in two axes. The 1U configuration (figure 4.10) provides 850 N-s of total impulse with a minimum impulse bit of 35 mN-s (27).

The Busek BGT-X5 CubeSat propulsion system (figure 4.11) occupies 1U+ volume and weighs ~1.5kg wet, including ~300g of ASCENT (AF-M315E) propellant. The module can deliver a maximum of 660 N-s of total impulse at  $I_{SP}$  of 225 s. Key components include a 0.5-N micro thruster, a bellows-based propellant tank, a custom micro solenoid valve, a secondary flow inhibit for range safety, integrated controller, and a Post-Launch Pressurization System (PLPS), enabling the system to be completely unpressurized at launch (28). The BGT-X5 system is currently undergoing qualification testing, with a projected launch date of Q2 CY2022.

Rocket Lab's Electron rocket has a liquid propellant kick-stage that uses a cold-gas RCS. The Rocket Lab Kick Stage, powered by the Curie engine, was designed to deliver small satellites to precise orbits before deorbiting itself to leave no part of the rocket in space. The kick stage was flown and tested onboard the "Still Testing" flight that was successfully launched on January 21, 2018. With the new kick stage Rocket Lab can execute multiple burns to place numerous payloads into different orbits. The kick stage is designed for use on the Electron launch vehicle with a payload capacity of up to 150 kg, and will be used to disperse CubeSat constellations fast and accurately, enabling satellite data to be received and used soon after launch (29) (30).

#### d. Summary Table of Devices

See table 4-3 for current state-of-the-art other mono- and bipropellant devices applicable to small spacecraft.

#### e. Notable Advances

Aerojet Rocketdyne continues development of its GR-M1 Advanced Green Monopropellant CubeSat Thruster. It employs the same advanced techniques, ultra-high-temperature catalyst, and refractory metal manufacture as the GPIM GR-1 thruster, but on a nanosat scale (31). To partially mitigate thermal management challenges exacerbated at the miniature scale, the GR-M1 is designed to operate on a reduced-flame-temperature variant of the AF M315E propellant containing 10% added water. The heat transfer to surrounding spacecraft structure both during heat up and operation are comparable to conventional hydrazine thrusters.



Figure 4.10: PM200.  
Credit: Dawn Aerospace.



Figure 4.11: BGT-X5 System  
Credit: Busek Space Systems.

Plasma Processes LLC is maturing a 1N and 5N ASCENT thruster (figure 4.12), intended for SmallSat application (32). Both offerings are built using the same materials and processes as those used on the 100mN thrusters delivered for the Lunar Flashlight Mission. Additionally, Plasma Processes intends to engineer a short-life, lower cost version of the 5N thruster. The prototype thruster accumulated > 1kg throughput and over 500 seconds before the end of the NASA Phase I SBIR. The Phase II effort will continue the development of the 5N thruster.

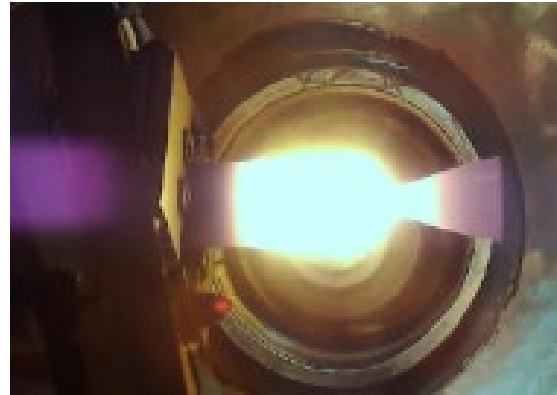


Figure 4.12: PP3616-A 5N ASCENT Thruster. Credit: Plasma Processes.

CU Aerospace LLC (CUA) is developing the Monopropellant Propulsion Unit for CubeSats (MPUC) system. The monopropellant is an  $H_2O_2$ -ethanol blend denoted as CMP-X. Tests on a thrust stand achieved a thrust level of >100 mN at  $I_{SP} > 180$  s with an average input power of  $\sim 3$  W, for hot fire runs typically spanning >10 minutes. 1.5U and 2U systems are in development with an estimated 1550 N-s and 2450 N-s total impulse, respectively. The  $\sim 950^\circ C$  flame temperature allows the thrust chamber to use non-refractory construction materials. CMP-X has low toxicity and was subjected to a scaled UN Series 1 detonation test series and demonstrated no detonation propagation when confined under a charge of high explosive. No special measures are anticipated for its long-term storage and permission for transport is expected. A NASA Phase II SBIR effort is currently underway.

## Hybrids

### a. Technology Description

Hybrid propulsion is a mix of both solid and liquid/gas forms of propulsion. In a hybrid rocket, the fuel is typically a solid grain and the oxidizer (often gaseous oxygen) is stored separately. The rocket is then ignited by injecting the oxidizer into the solid motor and igniting it with a spark or torch system. Since combustion can only occur while the oxidizer is flowing, these systems can readily be started or shutdown by controlling the flow of oxidizer.

### b. Key Integration and Operational Considerations

Because there is no oxidizer pre-mixed with the solid motor, these systems are inherently safer from a handling standpoint than solid motor systems, as the risk of pre-mature ignition is greatly reduced. They offer the best of both worlds of solids (storability & handling) and liquids (restart & throttling). Yet they do have drawbacks, as combustion efficiency tends to not be as high as in either system, and regression rate control and fuel residuals tend to be more problematic in these designs.

### c. Current & Planned Missions

An arc-ignition 'green' CubeSat hybrid thruster system prototype was developed at Utah State University. This system is fueled by 3-D printed acrylonitrile butadiene styrene (ABS) plastic known for its electrical breakdown properties. Initially, high-pressure gaseous oxygen (GOX) was to be used as the oxidizer. However, for the sake of the technology demonstration and after safety considerations by NASA Wallops High Pressure Safety Management Team, it was concluded the oxidizer needed to contain 60% nitrogen and only 40% oxygen. On March 25, 2018, the system was successfully tested aboard a sounding rocket launched from NASA Wallops Flight Facility



(WFF) into space and the motor was successfully re-fired 5 times. During the tests, 8 N of thrust and a specific impulse of 215 s were achieved as predicted (34) (35). The Space Dynamics Lab has miniaturized this technology to be better suited for CubeSat applications (0.25 - 0.5 N). A qualification unit is currently in development for the miniaturized system.

#### d. Summary Table of Devices

See table 4-4 for current state-of-the-art hybrid devices applicable to small spacecraft.

#### e. Notable Advances

Utah State University has an ongoing test series with Nytrox, a blend of nitrous oxide and oxygen, and ABS. This testing is focused on a 25-50 N system for a 12U sized vehicle and will cumulate in vacuum testing of the motor at MSFC in 2021. Investigation into different nozzle materials for low erosion in long duration burns is a key concern (36) (37).

JPL has pursued development of a hybrid propulsion system for 12U CubeSat and a 100 kg SmallSat. Testing included regression rate characterization of clear and black Poly (Methyl MethAcrylate) fuels with GOX to be included in propulsion system sizing. Later vacuum testing included an improvement of the ignition system to a laser operated system that eliminates the need for a separate ignition fuel gas to be carried (38).

NASA ARC developed a polymethyl methacrylate (PMMA) and nitrous oxide hybrid system that had ethylene and nitrous oxide thrusters. The ethylene and nitrous oxide also function as the hybrid ignition source. The hybrid system had a demonstrated efficiency of 91% and calculated  $I_{SP}$  of 247 sec, making it competitive with current small satellite propulsion systems (39) (40).

Aerospace Corporation and Penn State University developed an “Advanced Hybrid Rocket Motor Propulsion Unit for CubeSats (PUC)”. The design used additive manufacturing techniques for the carbon filled polyamide structure including the nitrous oxide tank and a paraffin grain within an acrylic shell, with acrylic diaphragms 3-D printed in-situ in the grain to aid in the performance of the grain. This design fits in a 1U space, for a 3 to 6U spacecraft (41).

Parabilis Space Technologies has done development work on two small satellite propulsion systems. Rapid Orbital Mobility Bus (ROMBUS) is a hybrid rocket-based system with nitrous oxide as the oxidizer and the attitude control system/reaction control system thruster propellant. It provides high-impulse thrust for satellite translational maneuvers which can be used for initial orbit insertion, rapid orbit rephasing, threat/collision avoidance, and targeted re-entry at the satellite’s mission end of life (42). Nano Orbital Transfer System (OTS) is a Hydroxyl-terminated polybutadiene (HTPB) and nitrous oxide ( $N_2O$ ) hybrid system, with  $N_2O$  based ACS thrusters. Nano OTS leverages Parabilis’ proven hybrid engine and small satellite technologies for low-cost, high performance maneuvers using non-toxic green propellants. The OTS has a modular design, enabling rapid and low-cost configuration of stages to accommodate 3U size NanoSats up to >50 kg MicroSat size vehicles.

### Cold Gas / Warm Gas

#### a. Technology Description

Cold gas systems are relatively simple systems that provide limited spacecraft propulsion and are one of the most mature technologies for small spacecraft. Thrust is produced by the expulsion of a propellant which can be stored as a pressurized gas or a saturated liquid. Warm gas systems, in which the propellant is heated but there is still no chemical reaction, have been used to increase thrust and specific impulse. Warm gas systems use the same basic principle as cold gas systems and have higher performance at the cost of added power requirements to heat the propellant.



Electrothermal systems, a type of warm-gas system where the gas is electrically heated in the thruster body or nozzle, are described in more detail in the Electric Propulsion section.

#### b. Key Integration and Operational Considerations

Cold gas thrusters are often attractive and suitable for small buses due to their relatively low cost and complexity. Many cold gas thrusters use inert, non-toxic propellants, which are an advantage for secondary payloads that must adopt “do no harm” approaches to primary payloads. Such systems are well suited to provide attitude control since they technically provide very low minimum impulse bits for precise maneuvering. However, the low specific impulse of these systems limits them from providing large orbit correction maneuvers. Recently, new designs have improved the capability of these systems for nanosatellite buses such as 3U CubeSats.

#### c. Missions

A cold gas thruster developed by Marotta flew on the NASA ST-5 mission (launch mass 55 kg) for fine attitude adjustment maneuvers. It incorporates electronic drivers that can operate the thruster at a power of less than 1 W. It has less than 5 ms of response time and it uses gaseous nitrogen as propellant (43).

The Micro-Electromechanical-based PICOSAT Satellite Inspector, or MEPSI, built by the Aerospace Corporation flew aboard STS-113 and STS-116. The spacecraft included both target and imaging/inspector vehicles connected via tether. The two vehicles were 4 x 4 x 5 in<sup>3</sup> in volume, each, and had five cold-gas thrusters, producing ~20 mN. The MEPSI propulsion system was produced using stereo-lithography. It was suited as a propulsion research unit for PicoSats (44).

Surrey Satellite Technology Ltd. (SSTL) has included a butane propulsion system in several small spacecraft missions for a wide range of applications in low-Earth orbit and Medium Earth Orbit (MEO). In this system, propellant tanks are combined with a resistojet thruster and operation is controlled by a series of solenoid valves (figure 4.13). It requires power to heat the thruster and improve the specific impulse performance with respect to the cold gas mode. (45) (46).

In June 2014, Space Flight Laboratory at University of Toronto Institute for Aerospace Research (UTIAS) launched two 15 kg small spacecraft to demonstrate formation flying. The Canadian Nanosatellite Advanced Propulsion System (CNAPS), shown in figure 4.14, consisted of four thrusters fueled with liquid sulfur hexafluoride. This non-toxic propellant was selected because it has high vapor pressure and density, which is important for making a self-pressurizing system (47). This propulsion module is a novel version of the previous NanoPS that flew on the CanX-2 mission in 2008 (48).

Another flight-demonstrated propulsion system was flown on the POPSAT-HIP1 CubeSat mission (launched June 2014), which was developed by Microspace Rapid Pte Ltd in Singapore. It



Figure 4.13: SSSL butane propulsion system. Credit: Surrey Satellite Technology, Ltd.

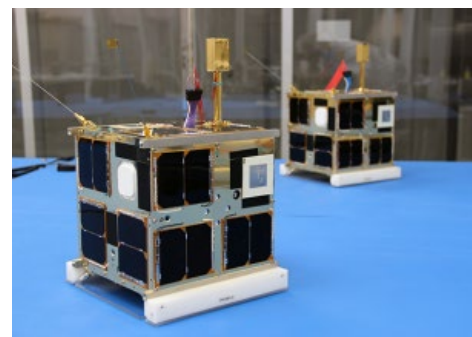


Figure 4.14: CanX-4 and CanX-5 formation flying nanosatellites with CNAPS propulsion systems. Credit: UTIAS SFL.

consisted of a total of eight micro-nozzles that provided control for three rotation axes with a single axis thrust for translational applications. The total delta- $v$  has been estimated from laboratory data to be between 2.25 and 3.05  $\text{ms}^{-1}$ . Each thruster has 1 mN of nominal thrust by using argon propellant. An electromagnetic microvalve with a very short opening time of 1 m-s operates each thruster (49).

Two related butane propulsion systems have been developed by GomSpace: the NanoProp 3U and NanoProp 6U. Both use proportional thrust control of four nozzles to control spacecraft attitude while providing delta- $v$ . The 6U configuration was flown on GOMX-4B in 2018 as a formation flight demonstration (50) (51).

An ACS cold gas propulsion system using R-236fa was produced and tested by Lightsey Space Research for the NASA ARC BioSentinel mission, a 6U CubeSat scheduled to launch on Artemis I. This propulsion system uses a 3D-printed propellant tank in order to reduce part count and use the available volume more efficiently (52) (53).

A complete cold gas propulsion system has been developed for CubeSats with a microelectromechanical system (MEMS) (figure 4.15) that provides accurate thrust control with four butane propellant thrusters. While thrust is controlled in a closed loop system with magnitude readings, each thruster can provide a thrust magnitude from zero to full capacity (1 mN) with 5- $\mu\text{N}$  resolution. The dry mass of the system is 0.220 kg and average power consumption is 2 W during operation (54). This system is based on flight-proven technology flown on larger spacecraft (PRISMA mission, launched in 2010). The MEMS cold gas system was included on the bus of the TW-1 CubeSat, launched in September 2015 (55).



Figure 4.15: NanoSpace MEMS cold gas system. Credit: GomSpace.

The CubeSat Proximity Operations Demonstration (CPOD) is a mission led by Tyvak Nano-Satellite Systems (56). It incorporates a cold gas propulsion system built by VACCO Industries that provides up to 186 N-s of total impulse. This module operates at a steady state power of 5 W and delivers 40-s of specific impulse while the nominal thrust is 10 mN (57). It uses self-pressurizing refrigerant R236fa propellant to fire a total of eight thrusters distributed in pairs at the four corners of the module. It has gone through extensive testing at the US Air Force Research Lab. Endurance tests consisted of more than 70,000 firings.

JPL is supporting the InSight mission, launched in March 2018, which incorporated two identical CubeSats as part of the Mars Cube One (MarCO) technology demonstration. These spacecrafts performed five trajectory correction maneuvers (TCMs) during the mission to Mars. The CubeSats included an integrated propulsion system developed by VACCO Industries, which contained four thrusters for attitude control and another four for TCMs. The module uses cold gas refrigerant R-236FA as propellant, produces 75 N-s of total impulse, and weighs 3.49 kg (58) (59).

NEA Scout is a NASA MSFC mission that is going to be launched as part of Artemis I. For its main propulsion system, NEA Scout will deploy a sail of 80  $\text{m}^2$  with 0.0601- $\text{mm s}^{-2}$  of characteristic acceleration and will be steered by active mass translation via a VACCO cold gas MiPS (R236FA propellant). This module is approximately 2U in volume and will use six 23-mN thrusters to provide 30  $\text{m s}^{-1}$  of delta- $v$  (60) (61).

The ThrustMe I2T5 iodine cold gas module, figure 4.16, is the first iodine propulsion system to be spaceflight tested, onboard of the Xiaoxiang 1-08 satellite. The demonstration was the result of a joint collaboration of ThrustMe and Spacety (62) (63). An I2T5 module is anticipated to launch in 2021 on the Robusta-3A satellite, developed by CSUM. The Robusta-3A will carry various scientific payloads related to meteorology and technology demonstration (64).

#### d. Summary Table of Devices

See table 4-5 for current state-of-the-art cold gas / warm gas devices applicable to small spacecraft.

### Solid Motors

#### a. Technology Description

Solid rocket technology is typically used for impulsive maneuvers such as orbit insertion or quick de-orbiting. Due to the solid propellant, they achieve moderate specific impulses and high thrust magnitudes that are compact and suitable for small buses.

There are some electrically controlled solid thrusters that operate in the milli-newton (mN) range. These are restartable, have steering capabilities, and are suitable for small spacecraft applications, unlike larger spacecraft systems that provide too much acceleration.

#### b. Key Integration and Operational Considerations

Thrust vector control systems can be coupled with existing solid rocket motors to provide controllable high delta-v in relatively short time. While some solid motors are restartable, in general solid motors are often considered a single-burn event system. To achieve multiple burns, the system must be either electrically restartable (aka electric solid propellants), or several small units must be matrixed into an array configuration. Because electrically controlled solid propellant (ESPs) are electrically ignited, they are safer than traditional solid energetic propellants.

#### c. Current & Planned Missions

A flight campaign tested the ability of thrust vector control systems coupled with solid motors to effectively control the attitude of small rocket vehicles. Some of these tests were performed by using state-of-the-art solid rocket motors such as the ISP 30 developed by Industrial Solid Propulsion and the STAR 4G by ATK (now: Northrop Grumman) (66).

SpinSat, a 57 kg spacecraft, was deployed from the International Space Station (ISS) in 2014 and incorporated a set of first-generation solid motors, the CubeSat Agile Propulsion System (figure 4.17), which was part of the attitude control system developed by Digital Solid State Propulsion LLC (DSSP). The system was based on a set of ESP thrusters that consist of two coaxial electrodes separated by a thin layer of electric solid propellant. This material is highly energetic but non-pyrotechnic and is only ignited if an electric current is applied. The thrust duration can be better controlled and allows for better burn control, and the lack of moving parts make the system suitable for small spacecraft (67).



Figure 4.16: I2T5 Iodine Cold Gas Module. Credit: ThrustMe.



Figure 4.17: SpinSat at the ISS. Credit: NASA.

The Modular Architecture Propulsion System (MAPS) by Pacific Scientific Energetic Materials Company (PacSci EMC) Propulsion array (figure 4.18) has a 10-plus year in-orbit lifespan. The MAPS system provides three axes capability to control such areas as attitude control, deorbit, drag makeup, and plane and attitude changes with a delta- $v$  greater than  $50 \text{ m s}^{-1}$ . The capability of MAPS “plug-and-play” bolt-on design and clean-burning propellant array is scalable and can be custom fit for a range of interfaces. MAPS was flown aboard the PACSCISAT (68) (69).

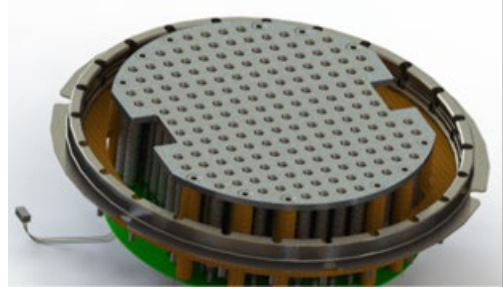


Figure 4.18: PacSci EMC MAPS sealed solid propellant rocket motor array. Credit: PacSci.

#### d. Summary Table of Devices

See table 4-6 for current state-of-the-art solid motor devices applicable to small spacecraft.

### Propellant Management Devices

#### a. Technology Description

While not specifically a propulsion type, propellant management devices (PMDs) are frequently used in larger liquid propulsion systems to deliver propellant to the thruster units. As small spacecraft start looking toward more complex propulsion systems, PMDs will undoubtedly play an integral part. Historically, small spacecraft have used bellows or membrane tanks to ensure propellant delivery and expulsion. However, there is the potential to incorporate PMD structures into additively manufactured tanks and propulsion systems, permitting much more conformal structures to be created for small spacecraft missions while still meeting mission performance targets. Hence, PMDs are a critical part of any in-space propulsion system that doesn't use bellows or membrane type tanks, and they are briefly covered here for awareness. A more detailed treatment and explanation can be found in the literature, and a good overview is provided by Hartwig (70).

#### b. Key Integration and Operational Considerations

The purpose of PMDs is to separate liquid and vapor phases within the propellant storage tank upstream of the thruster, and to transfer vapor-free propellant in any gravitational or thermal environment. PMDs have flight heritage with all classical storable systems, have been flown once with LMP-103S, have no flight heritage with cryogenic propellants, and have been implemented in electric propulsion systems. Multiple PMDs are often required to meet the demands of a particular mission, whether using storable or cryogenic propellants. A comprehensive, up-to-date list of the types of PMDs, as well as missions employing PMDs, is available in Hartwig (70).

#### c. Current & Planned Missions

The Lunar Flashlight Propulsion System will employ a PMD sponge and ribbon vane. The sponge was additively manufactured, while the ribbon vane was cut from sheet metal and bent to conform to the required dimensions. Surface tension properties, a necessary parameter for PMD sizing, have been determined for the ASCENT propellant by Kent State University, funded and managed by NASA. The design and modelling effort were a joint effort between MSFC and GRC.

#### d. Summary Table of Devices

No summary table is included for propellant management devices in this report edition.



#### e. Notable Advances

Northrop Grumman has made advances in development of SmallSat and CubeSat scale diaphragm propellant tanks using materials with known compatibility with hydrazine and some green monopropellant fuels (71). Some effort has been made to demonstrate the application of additive manufacturing to produce tank shells.

### 4.6.2 In-Space Electric Propulsion

In-space electric propulsion (EP) is any in-space propulsion technology wherein a propellant is accelerated through the conversion of electrical energy into kinetic energy. The electrical energy source powering in-space EP is historically solar, therefore these technologies are often referred to as solar electric propulsion (SEP), although other energy sources are conceivable such as nuclear reactors or beamed energy. The energy conversion occurs by one of three mechanisms: electrothermal, electrostatic, or electromagnetic acceleration (112) (113). Each of these technologies are covered herein.

This survey of the state-of-the-art in EP does not attempt to review all known devices but focuses on those devices that can be commercially procured or devices that appear on a path toward commercial availability. The intent is to aid mission design groups and other in-space propulsion end-users by improving their awareness of the full breadth of potentially procurable EP devices that may meet their mission requirements.

Metrics associated with the nominal operating condition for each propulsion device are published herein, rather than metrics for the complete operating range. A focus on the nominal operating condition was decided to improve comprehension of the data and make initial device comparisons more straightforward. When a manufacturer has not specifically stated a nominal operating condition in literature, the manufacturer may have been contacted to determine a recommended nominal operating condition, otherwise a nominal operating condition was assumed based on similarity to other devices. For those metrics not specifically found in published literature, approximations have been made when calculable from available data. Readers are strongly encouraged to follow the references cited to the literature describing each device's full performance range and capabilities.

#### Electrothermal

##### a. Technology Description

Electrothermal technologies use electrical energy to increase the enthalpy of a propellant, whereas chemical technologies rely on exothermal chemical reactions. Once heated, the propellant is accelerated and expelled through a conventional converging-diverging nozzle to convert the acquired energy into kinetic energy, like chemical propulsion systems. The specific impulse achieved with electrothermal devices is typically of similar magnitude as chemical devices given that both electrothermal and chemical devices are fundamentally limited by the working temperature limits of materials. However, electrothermal technologies can achieve somewhat higher specific impulses than chemical systems since they are not subject to the limits of chemical energy storage.

Electrothermal devices are typically subclassified within one of the following three categories.

1. *Resistojet devices* employ an electrical heater to raise the temperature of a surface that in turn increases the bulk temperature of a gaseous propellant.
2. *Arcjet devices* sustain an electrical arc through an ionized gaseous propellant, resulting in ohmic heating.



3. *Electrodeless* thrusters heat a gaseous propellant through an inductively or capacitively coupled discharge or by radiation.

Systems where the propellant enthalpy is increased by electrical heating within the propellant tank, rather than heating in the thruster head, are covered in the chemical propulsion section under cold/warm gas systems.

b. **Key Integration and Operational Considerations**

- **Propellant Selection:** Electrothermal technologies offer some of the most lenient restrictions on propellant selection for in-space propulsion. Whereas chemical systems require propellants with both the right chemical and physical properties to achieve the desired performance, electrothermal systems primarily depend on acceptable physical properties. For example, electrothermal devices can often employ inert gases or even waste products such as water and carbon dioxide. They also allow use of novel propellants such as high storage density refrigerants or in-situ resources. That said, not all propellants can be electrothermally heated without negative consequences. Thermal decomposition of many complex molecules results in the formation of polymers and other inconvenient byproducts. These byproducts may result in clogging of the propulsion system and/or spacecraft contamination.
- **Propellant Storage:** Electrothermal devices may require that propellants be maintained at a high plenum pressure to operate efficiently. This may require a high-pressure propellant storage and delivery system.
- **High Temperature Materials:** The working temperature limit of propellant wetted surfaces in the thruster head is a key limitation on the performance of electrothermal devices. As such, very high temperature materials, such as tungsten and molybdenum alloys, are often employed to maximize performance. The total mass and shape of these high temperature materials are a safety consideration for spacecraft disposal. While most spacecraft materials burnup on re-entry, the behavior of these high temperature materials will be considered when assessing the danger of re-entry debris to life and property.
- **Power Processing:** While some simple resistojets may operate directly from spacecraft bus power, other electrothermal devices may require a relatively complex power processing unit (PPU). For example, a radio-frequency electrodeless thruster requires circuitry to convert the DC bus power to a high-frequency alternating current (AC). In some cases, the cost and integration challenges of the PPU can greatly exceed those of the thruster.
- **Thermal Soak-back:** Given the high operating temperatures of electrothermal devices, any reliance on the spacecraft for thermal management of the thruster head should be assessed. While the ideal propulsion system would apply no thermal load on the spacecraft, some thermal soak-back to the spacecraft is inevitable, whether through the mounting structure, propellant lines, cable harness, or radiation.

### c. Missions

The Bradford (formerly Deep Space Industries) Comet water-based electrothermal propulsion system (figure 4.19) has been implemented by three customers operating in low-Earth orbit: HawkEye 360, Capella Space, and BlackSky Global (114). All three missions employ the same Comet thruster head, while the BlackSky Global satellites use a larger tank to provide a greater total impulse capability. The three HawkEye 360 pathfinder spacecraft employ the Space Flight Laboratory NEMO platform with each spacecraft measuring 20 x 20 x 44 cm<sup>3</sup> with a mass of 13.4 kg (115) (116). The Comet provides each HawkEye 360 a total delta-v capability of 96 ms<sup>-1</sup>. The approximate dimensions of the BlackSky Global spacecraft are 55 x 67 x 86 cm<sup>3</sup> with a mass of 56 kg (117).

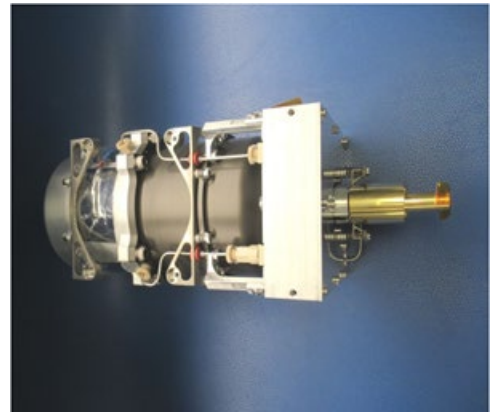


Figure 4.19: Comet-1000. Credit: Bradford Space.

The Propulsion Unit for CubeSats (PUC) system (118), figure 4.20, was designed and fabricated by CU Aerospace LLC (Champaign, IL) and VACCO Industries under contract with the U.S. Air Force to supply two government missions (119). The system was acquired for drag makeup capability to extend asset lifetime in low-Earth orbit. The system uses SO<sub>2</sub> as a self-pressurizing liquid propellant. The propulsion system electrothermally heats the propellant using a micro-cavity discharge (MCD) and expels the propellant through a single nozzle (120). It can alternatively use R134a or R236fa propellants, but only in a cold-gas mode with reduced performance. Eight (8) flight units were delivered to the Air Force in 2014, though it is unknown if any of the units have flown.



Figure 4.20: PUC module. Credit: CU Aerospace LLC.

In 2019, CU Aerospace was selected for a NASA STMD Tipping Point award to design, fabricate, integrate, and perform mission operations for the DUPLEX 6U CubeSat having two of CU Aerospace's micro-propulsion systems on board, one Monofilament Vaporization Propulsion (MVP) system (121) (122), figure 4.21, and one Fiber-Fed Pulsed Plasma Thruster (FPPT) system (123) (124) (125) (126), figure 4.44. The MVP is an electrothermal device that vaporizes and heats an inert solid polymer propellant fiber to 1100 K. The coiled solid filament approach for propellant storage and delivery addresses common propellant safety concerns, which often limit the application of propulsion on low-cost CubeSats. In-orbit operations will include inclination change, orbit raising and lowering, drag makeup, and deorbit burns demonstrating multiple mission capabilities with approximately 20 hours of operation for MVP and >1,000 hours for FPPT. Launch is anticipated in mid-2022 (127).

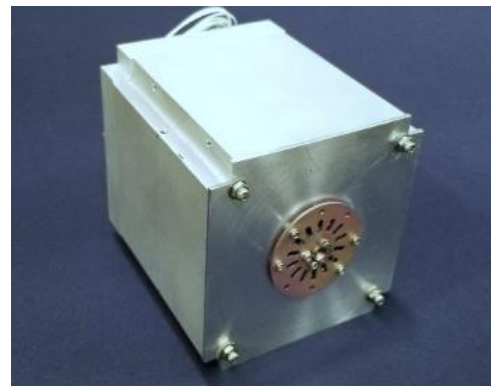


Figure 4.21: MVP module. Credit: CU Aerospace.

AuroraSat-1 is a technology demonstration 1.5U CubeSat that will demonstrate multiple propulsion devices by Aurora Propulsion Technologies. AuroraSat-1 will carry Aurora's smallest version of their Attitude and Orbit Control System (AOCS) (128), figure 4.22, and a demonstration unit of their Plasma Brake Module (PBM). The AOCS integrated in AuroraSat-1 has six resistojet thrusters for full 3-axis attitude control and 70 grams of water propellant, providing a total impulse of 70 N-s. AuroraSat-1 is built by SatRevolution with Aurora providing the payloads. The satellite is anticipated to be launched on an Electron rocket in Q4 2021 (129) (130) (131). See section 4.6.3 for discussion of the PBM module.

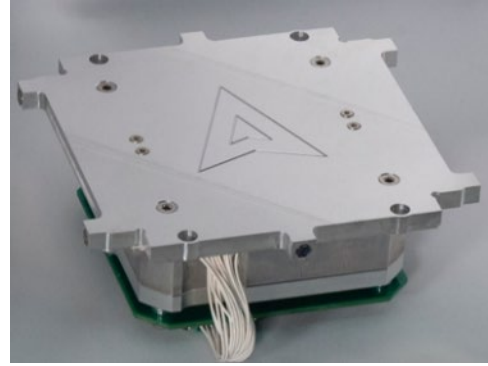


Figure 4.22: ARM-A AOCS module. Credit: Aurora Propulsion Technologies.

#### d. Summary Table of Devices

See table 4-7 for current state-of-the-art electrothermal devices applicable to small spacecraft.

### Electrosprays

#### a. Technology Description

Electrospray propulsion systems generate thrust by electrostatically extracting and accelerating ions or droplets from a low-vapor-pressure, electrically-conductive, liquid propellant (figure 4.23). This technology can be generally classified into the following types according to the propellant used:

**Ionic-Liquid Electrospays:** These technologies use ionic liquids (i.e., salts in a liquid phase at room conditions) as the propellant. The propellant is stored as a liquid, and onboard heaters may be present to maintain propellant properties within the desired operational temperature range. Commonly used propellants include 1-ethyl-3-methylimidazolium tetrafluoroborate (EMI-BF<sub>4</sub>) and bis(trifluoromethylsulfonyl)imide (EMI-Im). Thrusters that principally emit droplets are also referred to as colloidal thrusters.

**Field Emission Electric Propulsion (FEEP):** These technologies use low-melting-point metals as the propellant. The propellant is typically stored as a solid, and onboard heaters are used to liquefy the propellant prior to thruster operations. Common propellants include indium and cesium.

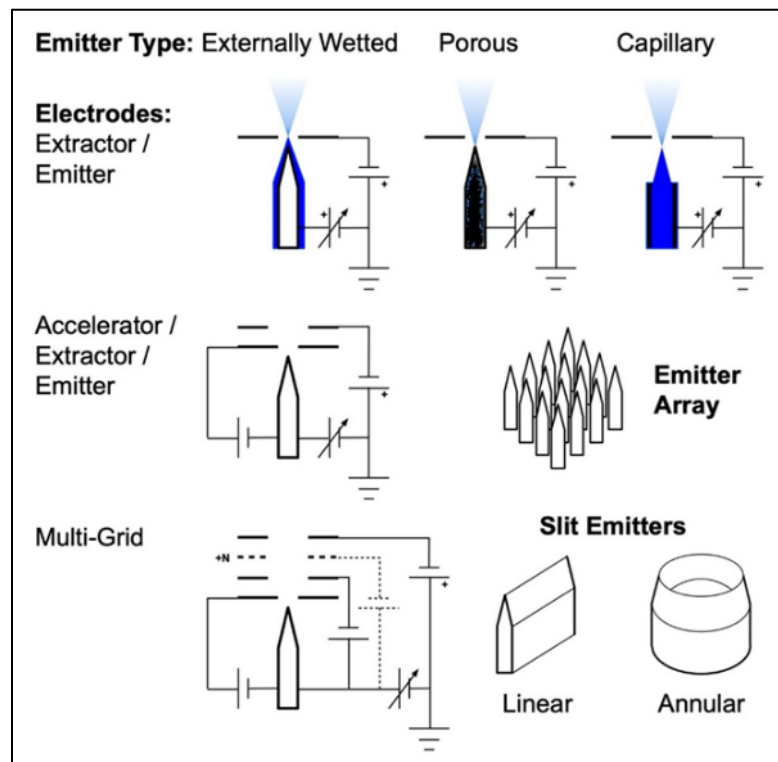


Figure 4.23: Schematic of typical electrospay emitter and electrode configurations. Credit: NASA.





Feed systems for electrospray technologies can be actively fed via pressurant gas or passively fed via capillary forces. The ion (high- $I_{SP}$ ) or droplet (moderate- $I_{SP}$ ) emission can be controlled by modulation of the high-voltage (i.e., >1 kV) input in a closed-loop feedback system with current measurements. Stable operations in either emission mode can provide very precise impulse bits. Propellants that result in both anion and cation emission may not require the presence of a cathode neutralizer to maintain overall charge balance; such neutralizers are included as part of the electrospray propulsion system for propellants that only emit positively charged species.

#### b. Key Integration and Operational Considerations

- **Plume Contamination:** Because propellants for electrospray propulsion systems are electrically conductive and condensable as liquids or solids, impingement of the thruster plume on spacecraft surfaces may lead to electrical shorting and surface contamination of solar panels and sensitive spacecraft components.
- **Propellant Handling and Thruster Contamination:** Ionic liquids and metallic propellants can be sensitive to humidity and oxidation, so care is needed if extended storage prior to flight is required. Electrospray technologies can also be sensitive to contamination of the thruster head during propellant loading, ground testing (e.g., backspatter or outgassed materials from the test facility), and handling (i.e., foreign object debris). Precautions should be taken to minimize contamination risks from manufacturing, through test, and to launch. Post-launch, ionic liquids can outgas (e.g., water vapor) when exposed to the space environment, and such behavior should be accounted for in the mission ConOps.
- **Performance Stability and Lifetime:** As an electrospray propulsion system operates over time, the propulsive performance can degrade as the plume impinges upon and deposits condensable propellant on thruster head surfaces; in time, sufficiently deposited propellant buildup can electrically short out the thruster electrodes and terminate thruster operations. Especially for missions with large total impulse requirements, lifetime testing or validated life models of the electrospray propulsion system in a relevant environment is important for understanding end-of-life behavior.
- **Specific Impulse:** Even for electrosprays that principally emit ions, operational thruster modes and instabilities can result in droplet emission that degrade the specific impulse and thrust efficiency. Caution is advised when considering claimed specific impulse or other propulsive properties (e.g., thrust vector and beam divergence) derived from plume characteristics; verification test data in a relevant environment is important for properly assessing these claims.
- **Precision Thrust:** Electrospray devices have the potential of providing very fine thrust precision during continuous operations. For devices that can operate in pulsed mode via pulsed modulation of the high-voltage input, fine impulse bits (i.e., <10  $\mu\text{N}\cdot\text{s}$ ) may be achievable. Such operations permit precise control over spacecraft attitude and maneuvering. Verification test data in a relevant environment should be used to properly assess the degree of thrust precision.

### c. Missions

The ESA Laser Interferometer Space Antenna (LISA) Pathfinder spacecraft was launched in December 2015, on Vega flight VV06. Onboard were two integrated propulsion modules associated with the NASA Space Technology 7 Disturbance Reduction System (ST7 DRS). Each propulsion module contained four independent Busek Colloid MicroNewton Thrusters (CMNT), propellant-less cathode neutralizers, power processing units, digital control electronics, and low-pressure propellant tanks. The propulsion system was successfully commissioned in-orbit in January 2016, after having been fully fueled and stored for almost eight years. The electro spray modules (figure 4.24), were operated at the Earth-Sun Lagrange Point 1 for 90 days to counteract solar disturbance forces on the spacecraft; seven of the eight thrusters demonstrated performance consistent with ground test results, and the full propulsion system met the mission-level performance requirements (132).

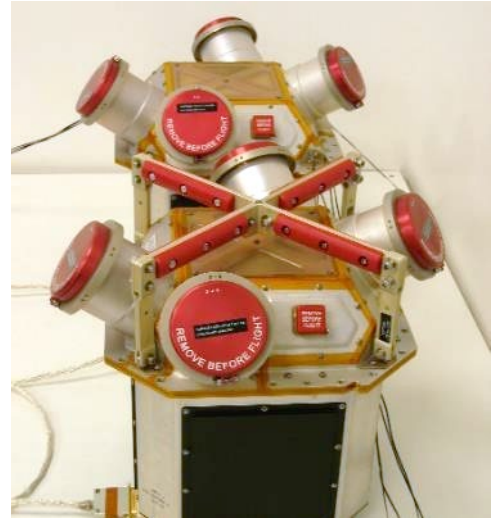


Figure 4.24: Flight CMNT modules for LISA Pathfinder. Credit: Busek.

Enpulsion's IFM Nano FEEP (figure 4.25), was first integrated onboard a 3U Planet Labs Flock 3P' CubeSat and launched via PSLV-C40 in January 2018. The indium-propellant propulsion system (with integrated thruster head, propellant storage, and power processing unit) was demonstrated in a 491 km by 510 km orbit. Two thruster firing sequences were reported, with the first a 15-minute firing in non-eclipse and the second a 30-minute firing in eclipse. Global Positioning System (GPS) telemetry data onboard the spacecraft indicated good agreement with the  $\sim 220 \mu\text{N}$  commanded thrust (133). Since this initial demonstration, the IFM Nano has flown onboard other spacecraft, but limited in-orbit data is publicly available. These missions include the ICEYE-X2 (launched onboard Falcon-9 flight F9-64 in December 2018) to provide low-Earth orbit interferometric synthetic aperture radar observations (134) (135) and the DOD-funded Harbinger technology demonstrator (launched onboard Electron flight STP-27RD in May 2019) (136) (137). The IFM Nano was also integrated onboard the Zentrum für Telematik (Würzburg) NetSat formation-flying demonstrator mission, which launched as a Soyuz-2 rideshare in September 2020 (138) (139).



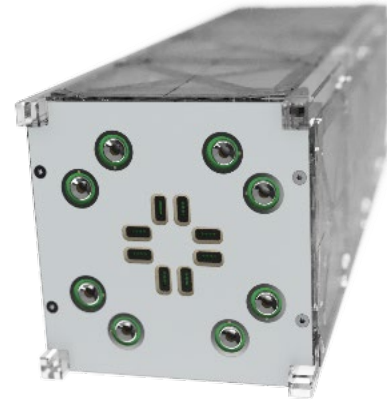
Figure 4.25: IFM Nano. Credit: Enpulsion.

The GMS-T mission was launched in January 2021 onboard a Rocket Lab Electron. The telecommunications satellite uses an OHB Sweden Innosat platform and houses an Enpulsion Micro R<sup>3</sup> (figure 4.26). Inaugural on-orbit commissioning of the propulsion system was confirmed in March 2021 (140).

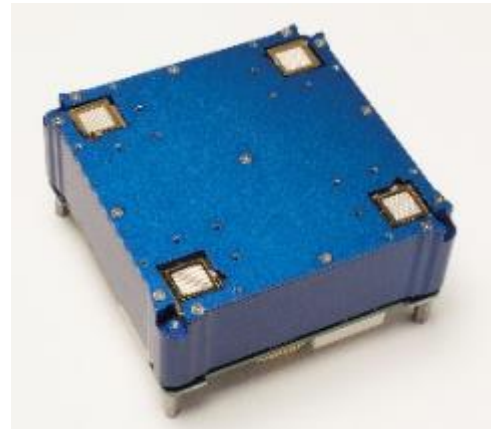


Figure 4.26: IFM Micro R<sup>3</sup>. Credit: Enpulsion.

The University Würzburg Experimental Satellite 4 (UWE-4) was launched as a secondary payload onboard the Soyuz Kanopus-V 5 and 6 mission in December 2018. This 1U spacecraft housed two Morpheus Space NanoFEEP systems, with each system consisting of two gallium-propellant thrusters, a power processing unit board for the UNISEC Europe bus, and a propellant-less cathode neutralizer. An experiment using one thruster as an attitude control actuator was reported, with the increased spacecraft rotation rate corresponding to a derived thrust magnitude of  $\sim 5 \mu\text{N}$ ; anomalous torque was attributed to unexpected impingement of the thruster plume upon the spacecraft antenna (141) (142). Orbit lowering capability was demonstrated in 2020; of the four individual thrusters, three experienced anomalous behavior during the UWE-4 mission (143). A 3U-Cubsat implementation of the same NanoFEEP technology is shown in figure 4.27.



Astro Digital's Tenzing satellite, which was integrated with a Sherpa-LTE Orbital Transfer Vehicle onboard the SpaceX Falcon 9 Transporter-2 launch in June 2021, houses two Accion Systems' TILE-2 units (figure 4.28) to demonstrate on-orbit rendezvous and proximity operations maneuvers (144). Another TILE-2 system is integrated onboard the Massachusetts Institute of Technology's BeaverCube, an educational mission that is expected to launch as a secondary payload onboard the SpaceX CRS-23 mission in August 2021 (145) (146) (147).



Accion's TILE-3 technology (consisting of an integrated unit with thruster heads, propellant storage, and power processing unit) is expected to be demonstrated onboard the D2/AtlaCom-1 mission. The spacecraft, a NanoAvionics M6P bus, was deployed in low Earth orbit following a SpaceX Falcon 9 Transporter-2 launch in June 2021 (148). Under a NASA Tipping Point Partnership, this mission seeks to demonstrate comparable propulsive capability as the MarCO CubeSats, but instead using electro spray technology (149). A TILE-3 unit is shown in figure 4.29.

Systems.



Figure 4.29: TILE-3. Credit: Accion Systems.

#### d. Summary Table of Devices

See table 4-8 for current state-of-the-art electro spray devices applicable to small spacecraft.

## Gridded-Ion

### a. Technology Description

Gridded-ion propulsion systems ionize gaseous propellant via a plasma discharge, and the resultant ions are subsequently accelerated via electrostatic grids (i.e., ion optics). This technology can be generally classified into the following types according to the type of plasma discharge employed:

- **Direct-Current (DC) Discharge:** The propellant is ionized via electron bombardment from an internal discharge cathode (figure 4.30).
- **Radio-Frequency (RF) Discharge:** No internal discharge cathode is present. Instead, the propellant is ionized via RF or microwave excitation from an RF generator (figure 4.31).

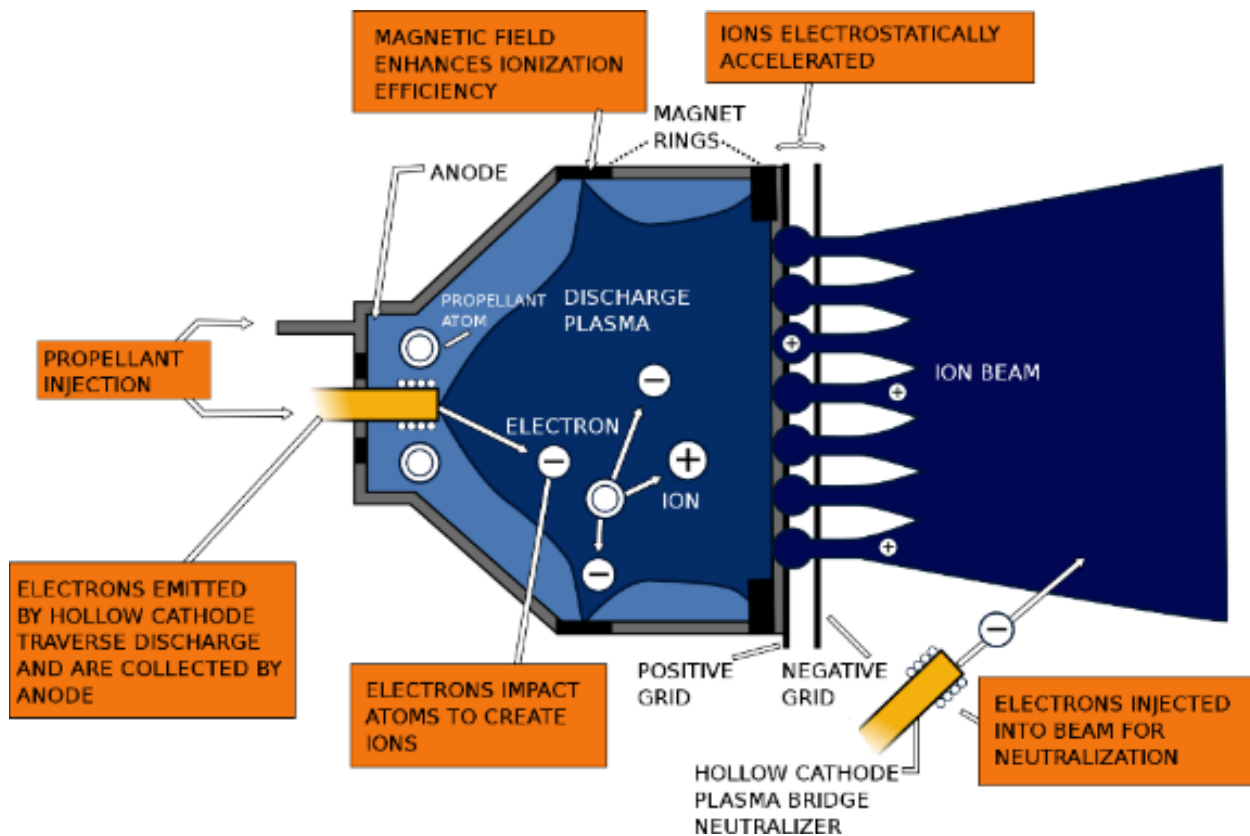


Figure 4.30: Schematic of typical DC-discharge gridded-ion thruster. Credit: NASA.

Gridded-ion thrusters typically operate at high voltages and include an external neutralizer cathode to maintain plume charge neutrality. High specific impulses can be achieved, but the thrust density is fundamentally limited by space-charge effects. While the earliest thruster technologies used metallic propellants (i.e., mercury and cesium), modern gridded-ion thrusters use noble gases (e.g., xenon) or iodine.

### b. Key Integration and Operational Considerations

- **Performance Prediction:** Due to the enclosed region of ion generation and acceleration, gridded ion thrusters tend to be less sensitive to test-facility backpressure effects than other devices such as Hall thrusters. This allows for more reliable prediction of in-flight performance based on ground measurements. Furthermore, the separation between ion

generation and acceleration mechanisms within the device tend to make calculations of thrust and ion velocity (or  $I_{SP}$ ) more straightforward.

- **Grid Erosion:** Charge-exchange ions formed in between and downstream of the ion optics can impinge upon and erode the grids. Over time, this erosion can lead to a variety of failure modes, including grid structural failure, an inability to prevent electrons from back streaming into the discharge chamber, or the generation of an inter-grid electrical short due to the deposition of electrically conductive grid material. Proper grid alignment is important to reducing grid erosion, and this alignment must be maintained during thruster assembly, transport, launch, and operations. Random vibration tests at the protoflight level should be conducted to verify the survivability of the ion optics against launch loads, and validated thermal modeling may be needed to assess the impact of grid thermal expansion during thruster operations.
- **Foreign Object Debris:** The grids are separated by a small gap, typically less than 1 mm, to maximize the electric field and thrust capability of the device. As a result, gridded-ion thrusters tend to be sensitive to foreign object debris, which can bridge the inter-grid gap and cause electrical shorting. Precautions should be taken to minimize such contamination risks from manufacturing, through test, and to launch.
- **Cathode Lifetime:** Cathodes for plasma discharge or plume neutralization may be sensitive to propellant purity and pre-launch environmental exposure. Feed system cleanliness, bake-out, and use of a high-purity propellant are key factors in maximizing cathode lifetime. The technology provider may recommend a maximum cumulative atmospheric exposure and humidity to reduce risk.
- **Roll Torque:** Misalignments in the ion optics can lead to disturbances in the thrust vector, resulting in a torque around the roll axis that cannot be addressed by the mounting gimbal.

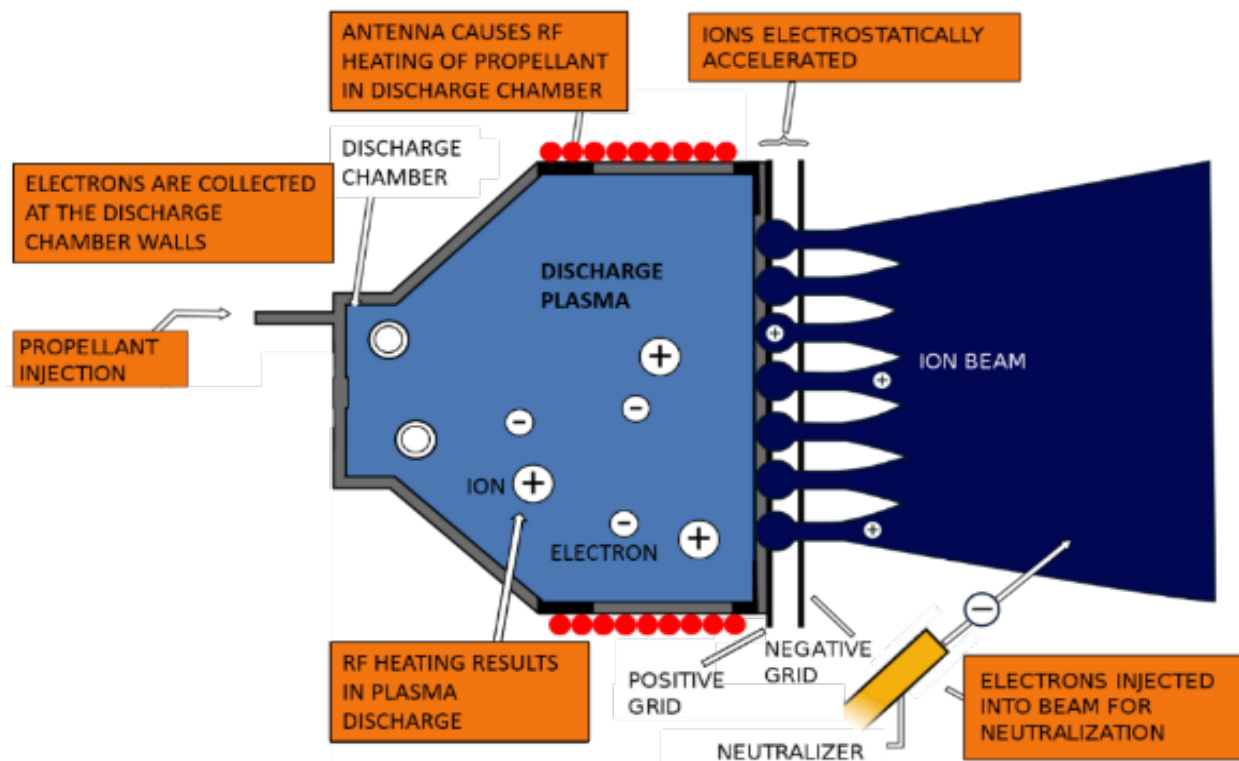


Figure 4.31: Schematic of typical RF-discharge gridded-ion thruster. Credit: NASA.

For missions requiring extended thruster operations, a secondary propulsion system or reaction wheels may be needed to counter the torque buildup (150).

- **Electromagnetic Interactions:** For RF-discharge thrusters, electromagnetic interference and compatibility (EMI/EMC) testing may be critical to assess the impact of thruster operations on spacecraft communications and payload functionality.
- **Iodine Propellant:** To address the volume constraints of small spacecraft, iodine is an attractive propellant. Compared to xenon, iodine's storage density is three times greater. Furthermore, iodine stores as a solid with a low vapor pressure, which addresses spacecraft integration concerns associated with high-pressure propellant storage. However, iodine is a strong oxidizer and long-duration impact on the thruster and spacecraft remain largely unknown. Upcoming flights will provide insight into potential spacecraft interactions and long-term reliability of feed system and thruster components.
- **Power Electronics:** Operation of gridded ion thrusters requires multiple high-voltage power supplies for discharge operation (ion generation), ion acceleration, and neutralization, leading to potentially complex and expensive power electronics.

### c. Missions

The ESA Gravity Field and Steady-State Ocean Circulation Explorer (GOCE) was launched in March 2009 onboard a Rokot / Briz-KM to provide detailed mapping of Earth's gravitational field and ocean dynamics from an altitude of ~220-260 km. Two QinetiQ T5 DC-discharge gridded-ion thrusters (figure 4.32), with one serving as a redundant backup, successfully provided drag-free control of the 1000-kg satellite until xenon propellant exhaustion in October 2013 (151) (152).

The Beihangkongshi-1 satellite was launched in November 2020 onboard a Long March 6 rocket. The 12U Spacety CubeSat housed a ThrustMe NPT30-I2-1U (figure 4.33), a 1U-integrated, RF-discharge gridded-ion propulsion system. As part of the first on-orbit demonstration of iodine-propellant electric propulsion, two 90-minute burns provided an orbit altitude change of 700 m (153). A 1.5U version of the NPT30-I2 is expected to fly onboard a Space Flight Laboratory of the University of Toronto, Institute for Aerospace Studies (UTIAS) 35-kg DEFIANT bus for the Norwegian Space Agency's NorSat-TD mission; expected to launch in 2022, this mission includes a demonstration of satellite collision avoidance maneuvers (154). NPT30-I2-1.5U is also expected to fly onboard a GomSpace 12U CubeSat for the 2022 ESA GOMX-5 technology demonstration mission (155).

Lunar IceCube is an upcoming NASA-funded CubeSat mission to characterize the distribution of water and other volatiles on the Moon from a highly-inclined lunar orbit with a perilune < 100 km. Led by Morehead State University, the mission will be conducted via a 6U spacecraft that is manifested as a secondary payload onboard Artemis I (156) (157).



Figure 4.32: T5 gridded-ion thruster for GOCE mission. Credit: QinetiQ.



Figure 4.33: NPT30-I2-1U. Credit ThrustMe.

Lunar Polar Hydrogen Mapper (LunaH-Map) is an upcoming NASA-funded CubeSat mission to map hydrogen distributions at the lunar south pole from a lunar orbit with a perilune  $< 20$  km. Led by Arizona State University, the mission will be conducted via a 6U spacecraft that is manifested as a secondary payload onboard Artemis I (158).

Both Lunar IceCube and LunarH-Map missions use an onboard Busek BIT-3 propulsion system (figure 4.34) with solid iodine propellant. The BIT-3 system will be used as primary propulsion during the lunar transfer trajectory, followed by lunar orbit capture, orbit lowering, and spacecraft disposal. Each integrated BIT-3 system



Figure 4.34: BIT-3 thruster. Credit: Busek.

includes a low-pressure propellant tank with heated propellant-feed components, a power processing unit to control the RF thruster and RF cathode, and a two-axis gimballed assembly.

#### d. Summary Table of Devices

See table 4-9 for current state-of-the-art gridded-ion devices applicable to small spacecraft.

### Hall-Effect

#### a. Technology Description

The Hall-effect thruster (HET) is arguably the most successful in-space EP technology by quantity of units flown. The Soviet Union first flew a pair of EDB Fakel SPT-60 HETs on the Meteor-1-10 spacecraft in 1971. Between 1971 and 2018, over 300 additional HETs flew internationally, although EDB Fakel produced the vast majority. The first flight of a non-Russian HET was on board the European Space Agency (ESA) Small Missions for Advanced Research in Technology (SMART-1) spacecraft in 2003. SMART-1 employed the French PPS-1350 HET, produced by Safran (159). The first flight of a U.S. manufactured HET, the Busek BHT-200, was onboard the TacSat-2 spacecraft (160), a U.S. Air Force Research Laboratory (AFRL) experimental satellite in 2006. In 2010, Aerojet, another U.S. entity, began commercially delivering their 4.5 kW XR5 HET (161), formerly BPT-4000. Launches of HETs greatly accelerated in 2019 with the launch of 120 SpaceX Starlink and 6 OneWeb spacecraft (162), each including an HET. By late-June 2021, an additional 1,617 SpaceX and 212 OneWeb satellites launched into low-Earth orbit with HETs. Suffice to say that HETs have become a mainstream in-space propulsion technology.

The rapid growth in demand for HETs can be attributed to their simple design, historically well-demonstrated reliability, good efficiency, high specific impulse, and high thrust-to-power ratio. Although, the higher voltage gridded-ion thrusters (GIT) can achieve even higher specific impulse, HETs can achieve higher thrust-to-power ratios because the HET's higher density quasi-neutral plasma is not subject to space-charge limitations. The HET's higher thrust-to-power ratio will typically shorten spacecraft transit time. On the other end of the spectrum, arcjets provide significantly higher thrust than HETs, however material limitations prevent arcjets from matching the HET's electrical efficiency and specific impulse. For many missions, HETs provide a good balance of specific impulse, thrust, cost, and reliability.

HETs are a form of ion propulsion, ionizing and electrostatically accelerating the propellant. Historically, all HETs flown in space have relied on xenon propellant, given its high molecular weight, low ionization energy, and ease of handling. The recent exception is the SpaceX Starlink spacecraft using krypton propellant. While HETs operate less efficiently with krypton propellant and krypton has more challenging storage requirements, krypton gas is considerably lower cost than xenon gas, which is a compelling attribute when the potential number of spacecraft are projected in the thousands, as with constellations. Many other propellants have been considered and ground tested for Hall-effect thrusters, but to date only Hall-effect thrusters using xenon or krypton have flown.

As schematically shown in figure 4.35, HETs apply a strong axial electric field and radial magnetic field near the discharge chamber exit plane. The  $\mathbf{E} \times \mathbf{B}$  force greatly slows the mean axial velocity of electrons and results in an azimuthal electron current many times greater than the beam current. This azimuthal current provides the means by which the incoming neutral propellant is collisionally ionized. These ions are electrostatically accelerated and only weakly affected by the magnetic field. The electron source is a low work function material typically housed in a refractory metal structure (i.e., hollow cathode), historically located external to the HET body, although many recent thruster designs have begun centrally mounting the cathode in the HET body as shown in figure 4.35. The cathode feeds electrons to the HET plasma and neutralizes the plasma plume ejected from the thruster. The high voltage annular anode sits at the rear of the discharge chamber and typically functions as the propellant distribution manifold.

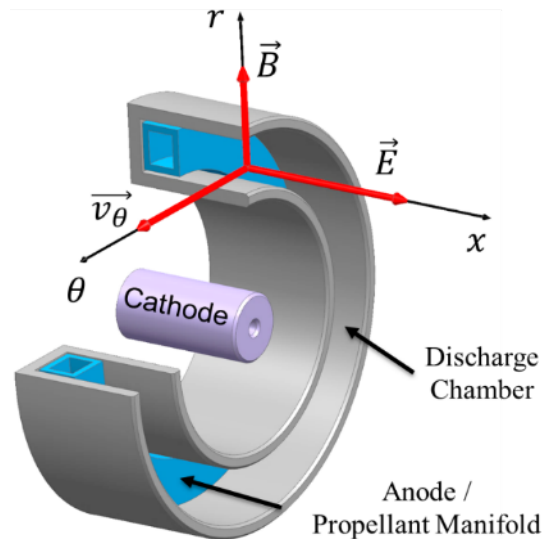


Figure 4.35: Hall-effect Thruster schematic. Credit: NASA.

#### b. Key Integration and Operational Considerations

- **Ground Facility Effects:** Ground facility effects may result in inconsistencies between ground and flight performance. The significance of the inconsistencies depend on factors such as test facility scale, test facility pumping speed, intrusiveness of diagnostics, and thruster electrical configuration.
- **Contamination:** Plume ions of an HET can affect spacecraft surfaces by erosion or contamination, even at large plume angles. Ground facility measurement of ion density at large angles may under predict flight conditions.
- **Thermal Soak-Back:** HET core temperature may exceed 400°C with the cathode exceeding 1000°C. Most HET waste heat radiates directly from the HET surfaces. However, some thermal soak-back to the spacecraft will occur through the mounting structure, propellant feed lines, electrical harness, and radiation.
- **Survival Heaters:** Given the thermal isolation between the HET and spacecraft, the HET may require a survival heater depending on the qualification temperature and flight environments.
- **Performance:** HET performance may vary over the life of the device due to erosion and contamination of the plasma wetted HET surfaces. Magnetically shielded thrusters demonstrate less time dependency to their performance than classical HETs.





- **Thruster Lifetime:** Classical HETs are primarily life-limited by erosion of the discharge chamber wall. Magnetically shielded HETs are primarily life-limited by erosion of the front pole covers.
- **Cathode Lifetime:** Cathode lifetime may be sensitive to propellant purity and pre-launch environmental exposure. Feed system cleanliness, bake-out, and use of a high purity propellant are key factors in maximizing cathode lifetime. The HET manufacturer may recommend a maximum cumulative atmospheric exposure and humidity. Some cathode emitter formulations are less sensitive to propellant impurities and atmospheric exposure, but these formulations may require other trades such as a higher ignition temperature.
- **Roll Torque:** The  $\mathbf{E} \times \mathbf{B}$  force results in a slight swirl torque. For missions requiring extended thruster operations, a secondary propulsion system or reaction wheels may be needed to counter the torque buildup. The roll torque may largely be countered by periodically reversing the direction of the magnetic field. Field reversal requires switching the polarity of current to the magnet coils. Field reversal is only possible with HETs using electromagnets.
- **Thrust Vector:** Non-uniformity of the azimuthal plasma, magnetic field, or propellant flow may result in slight variations of the thrust vector relative to the HET physical centerline. Temperature variation of the HET, such as during startup, also results in a slight walking of the thrust vector.
- **Heaterless Cathodes:** Heaterless cathode technologies continue to mature. The benefit of a heaterless cathode is elimination of the cathode heater, typically an expensive component due to rigorous manufacturing and acceptance processes. However, the physics of heaterless cathode life-limiting processes require further understanding. Nevertheless, heaterless cathode demonstrations have empirically shown significant promise. Heaterless cathode requirements on the EP system differ from an HET with a cathode heater. Impacts on the power processing unit and feed system should be well understood when trading a heaterless versus heated cathode.
- **Throttling Range:** HETs typically throttle stably over a wide range of power and discharge voltage. This makes an HET attractive for missions requiring multiple throttle set-points. However, an HET operates most efficiently at specific throttle conditions. Operating at off-nominal conditions may result in decreased specific impulse and/or electrical efficiency.

### c. Missions

Canopus-V (alternative spelling Kanopus-V) is a Russian Space Agency spacecraft for Earth observation with a design life of 5 years. The 450 kg spacecraft launched in 2012 employed a pair of EDB Fakel SPT-50 thrusters. Similarly, the Canopus-V-IK (Kanopus-V-IK) launched in 2017 with a pair of SPT-50. The SPT-50 thrusters have a long history of spaceflight dating back to the late 1970s. Although the Canopus bus exceeds 450 kg, the power class and physical scale of the SPT-50 are appropriate for smaller spacecraft. The SPT-50 is nominally a 220 W thruster operated on xenon propellant (163) (164) (165).

The KazSat-1 and KazSat-2 spacecraft produced by Khrunichev Space Center in cooperation with Thales Alenia Space launched in 2006 and 2011, respectively. The KazSat spacecraft are geosynchronous communication satellites. These spacecrafts employ the EDB Fakel SPT-70BR thruster. The SPT-70BR is Fakel's latest version of the SPT-70 product line. EDB Fakel optimized the SPT-70 for operation between 600 and 700 W, but no more than 900 W. Experiments demonstrate a lifetime of 3,100 hours, equating to about 450 kNs. The SPT-70 thrusters have a long history of spaceflight dating back to the early 1980s. Control of KazSat-1 was lost in 2008 (166) (167).

The Busek BHT-200 (figure 4.37) has the distinction of being the first U.S.-made HET to operate in space. The BHT-200 has flight heritage from demonstrations on the TacSat-2 mission launched in 2006, FalconSat-5 mission launched in 2010, and FalconSat-6 mission launched in 2018. A Busek PPU powered the 200 W HET for each of the FalconSat missions (168). Ground testing of the BHT-200 includes multiple propellants, although all spaceflights have used xenon. Busek developed an iodine compatible derivative of the BHT-200 for the NASA iSat mission. It was determined during the course of the iSat project that additional development related to iodine compatible cathodes was required before conducting an in-space demonstration of the technology at this scale of thruster (169) (170).

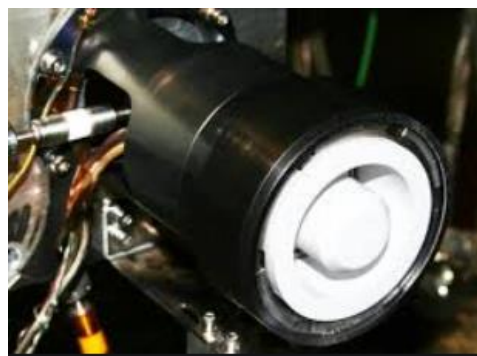


The Israel Space Agency and the French National Center for Space Studies (CNES) jointly developed the Vegetation and Environment monitoring on a New Microsatellite (VENuS) spacecraft launched in 2017. The 268 kg VENuS spacecraft includes a pair of Rafael IHET-300 thrusters (figure 4.36) and 16 kg of xenon propellant. Inflight operations have demonstrated operation between 250 and 600 W. Rafael developed the IHET-300, nominally operating at 300 W, specifically for small spacecraft (171) (172) (173) (174) (175).



Figure 4.36: IHET-300 thruster. Credit: Rafael.

The European and Italian space agencies selected the SITAEL HT100 (figure 4.38) for an in-orbit validation program to evaluate the device's capabilities for orbital maintenance and accelerated reentry of a small spacecraft. The uHETSat mission will be the first in-orbit demonstration of the HT100. SITAEL is currently performing ground qualification of the complete propulsion system. The HT100 is nominally a 175 W device operating on xenon propellant. The uHETSat will use the SITAEL S-75 microsatellite platform. The S-75 is 75 kg with dimensions of 60 x 40 x 36 cm<sup>3</sup>. The anticipated launch date targets 2021 (176) (177) (178).



The Astro Digital Ignis satellite is a technology demonstration spacecraft built to the 6U CubeSat standard. The spacecraft bus is the Astro Digital Corvus-6 design, which is 32 x 21 x 11 cm<sup>3</sup> with a mass no more than 12 kg. The Ignis includes the Apollo Fusion Apollo Constellation Engine (ACE), shown in figure 4.39. Apollo Fusion offers the ACE compatible with xenon, krypton, and a proprietary high-density propellant. This first flight of the ACE HET was anticipated to employ 1.1 kg of the proprietary propellant, providing approximately 12,000 Ns



Figure 4.39: ACE thruster. Credit: Apollo Fusion.

of total impulse. The anticipated lifetime of the spacecraft is less than 3 years in low-Earth orbit with an altitude of 500 km. Ignis was anticipated to launch in 2021 (179) (180). The ACE was further selected as the electric propulsion system for Spaceflight Inc.'s Sherpa-LTE using xenon propellant. The Sherpa-LTE is an orbital transfer vehicle (OTV) claimed to be capable of delivering customers to GEO, Cislunar, and Earth-escape orbits. The first Sherpa-LTE launched on SpaceX's Transporter-2 mission on June 30, 2021 (181) (182).

Exotrail launched its first in-orbit demonstration mission including the 50 Watt ExoMG-nano (figure 4.40) thruster in November 2020. NanoAvionics and Exotrail partnered to integrate the ExoMG-nano into NanoAvionics' M6P nanosatellite 6U bus. Exotrail and its partners designed, built, integrated, and qualified the ExoMG-nano demonstrator in 10 months. Exotrail further signed a contract with AAC Clyde Space to provide propulsion for the Eutelsat ELO 3 and ELO4 6U CubeSats anticipated to launch in 2021 (183) (184) (185) (186) (187).

ExoTerra has received a NASA Tipping Point award to perform an in-orbit demonstration of their 12U Courier SEP spacecraft bus with a target launch date of December 2021. The bus includes ExoTerra's Halo thruster (figure 4.41), propellant distribution, power processing unit and deployable solar arrays. The Courier spacecraft provides up to  $1 \text{ km s}^{-1}$  of delta-v, while hosting a 2U, 4 kg payload. The Tipping Point mission objective is to demonstrate the SEP system by spiraling to 800 km from a drop-off orbit of 400 km and then deorbiting. Primary mission objectives include demonstration of the solar array deployment and power generation, PPU efficiency, and 2 kg of thruster propellant throughput. The 0.67 kg, 1/4U thruster will nominally operate at 135 W. During the mission operations, a variation in thruster power and discharge voltage will demonstrate a performance range of 135 to 185 W and 150 to 400 V, respectively (188) (189) (190).

AST & Science (AST) of Midland, Texas, selected the Aurora Hall-Effect Propulsion System (figure 4.42) manufactured by Orbion Space Technology for its SpaceMobile network. AST anticipates SpaceMobile to be a low-Earth orbit constellation of hundreds of satellites providing cellular coverage for 4G and 5G smartphones. Orbion's Aurora thrusters will provide propulsion for orbital maintenance, collision avoidance, and de-orbiting at end-of-life. Orbion's Aurora propulsion system consists of a thruster, cathode, power processing unit, propellant



Figure 4.40: ExoMG-nano thruster. Credit: Exotrail.

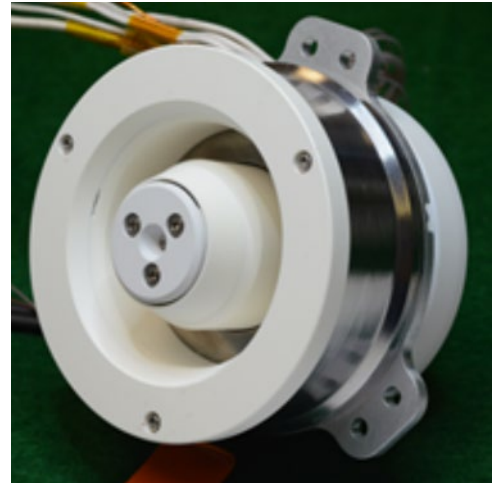
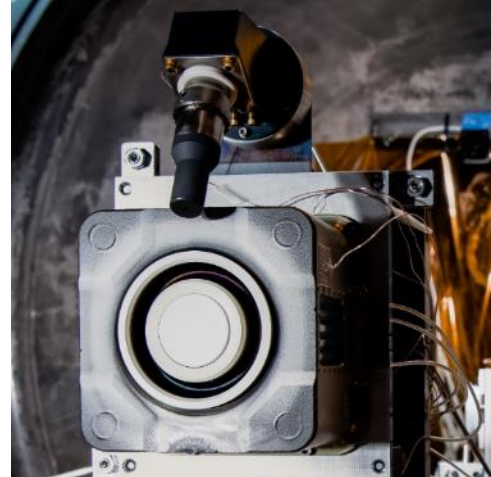


Figure 4.42: Two flight Aurora HETs undergoing qualification testing. Credit: Orbion Space Technology.

flow controller, and cable harness. The anticipated launch date for the first satellite of the SpaceMobile constellation is March 2022 (191) (192) (193).

Blue Canyon has also selected the Orbion Aurora thruster for DARPA Blackjack satellites. Blue Canyon is producing four satellites for the DARPA program as one of multiple satellite bus suppliers. Blackjack satellites are about 150 kilograms (194).

Busek shipped its first flight BHT-600 Hall-effect thruster system to a U.S. Government customer in early 2021 for an anticipated flight in 2021. The BHT-600 previously demonstrated a 7,000-hour ground test performed at NASA GRC as part of a NASA Announcement for Collaborative Opportunity (ACO) Space Act Agreement (SAA), figure 4.43. The thruster successfully demonstrated 70 kilograms of xenon propellant throughput before the test was terminated. The BHT-600 is designed for operation from 400 W to 1 kW (195) (196).



*Figure 4.43: BHT-600 Installed in NASA GRC Vacuum Test Facility. Credit: Busek Co.*

#### d. Summary Table of Devices

See table 4-10 for current state-of-the-art HET devices applicable to small spacecraft.

### Pulsed Plasma and Vacuum Arc Thrusters

#### a. Technology Description

Pulsed Plasma Thrusters (PPT) produce thrust by first triggering an electric arc between a pair of electrodes that typically ablates a solid-state propellant like polytetrafluoroethylene (PTFE) or ionizes a gaseous propellant. The plasma may be accelerated by either electrothermal or electromagnetic forces. Whether the mechanism of acceleration is electrothermal, electromagnetic, or often some combination thereof is determined by the device topology (197).

Electrothermal PPTs characteristically include a chamber formed by a pair of electrodes and solid propellant, wherein propellant ablation and heating occurs. During and immediately following each electric discharge, pressure accumulates and accelerates the propellant through a single opening. Electromagnetic PPTs characteristically do not highly confine the propellant as plasma forms. The current pulse, which may exceed tens of thousands of amps, highly ionizes the ablated material or gas. The current pulse further establishes a magnetic field, where the  $\mathbf{j} \times \mathbf{B}$  force accelerates the plasma. PPT devices that are predominantly electrothermal typically offer higher thrust, while devices that are predominantly electromagnetic offer higher specific impulse.

The simplest PPTs have no moving parts, which may provide a high degree of reliability. However, as the solid propellant is consumed, the profile of the propellant surfaces is constantly changing. Thus, PPTs with static solid propellant demonstrate a change in performance over their life and inherently have a relatively limited lifetime. More complex solid propellant PPTs include a propellant feed mechanism. Typically, the propellant surface profile changes during an initial burn-in period, but then settles into a steady-state behavior where the propellant advancement is balanced by the propellant ablation.

PPT devices are suitable for attitude control and precision pointing applications. PPTs offer small and repeatable impulse bits, which allow for very high precision maneuvering. The complete propulsion system consists of a thruster, an ignitor, and a power processing unit (PPU). Energy



to form the pulsed discharge is stored in a high voltage capacitor bank, which often accounts for a significant portion of the system mass. Once the capacitors are charged, resulting in a large differential voltage between the electrodes, the ignitor provides seed material that allows the discharge between the electrodes to form. Various materials and gases (including water vapor) have been tested with PPTs, however PTFE remains most common.

Vacuum arc thrusters (VAT) are another type of pulsed plasma propulsion (198). This technology consists of two metallic electrodes separated by a dielectric insulator. Unlike PPTs, one VAT electrode is sacrificial, providing the propellant source. The mechanism for propellant acceleration is predominantly electromagnetic, resulting in a characteristically high specific impulse and low thrust. One variant of the VAT is predominantly electrostatic, by the inclusion of a downstream electrostatic grid.

#### b. Key Integration and Operational Considerations

- **Safety:** PPT capacitor banks often store tens of joules of energy at potentially a couple thousand volts. Follow good electrical safety practices when operating and storing PPTs in a laboratory environment.
- **Input Power Range:** PPTs and VATs are pulsed devices, which operate by discharging energy stored in capacitors with each pulse. Thus, the propulsion system's average power draw from the spacecraft bus can be quite low or high depending on the capacitor energy storage and pulse frequency. This flexibility allows PPTs to be applied to spacecraft with limited power budgets of just a few watts, or ample power budgets of hundreds of watts.
- **Minimum Impulse Bit:** A compelling capability of pulsed devices is the ability to generate small, precise, and well-timed impulse bits for precise spacecraft maneuvering. By controlling the discharge voltage, very small impulse bits on the order of micronewton-seconds are easily achieved.
- **Compact and Simple Designs:** PPTs and VATs are typically very simple and compact devices. While the total impulse capability is small compared to other forms of EP, these devices offer a particularly attractive solution for CubeSats, where low cost may be a more significant consideration than total impulse. The systems are also attractive for learning environments where propulsion expertise such as high-pressure feed systems and propellant management may be lacking.
- **Late-Time Ablation:** Although pulsed devices allow for operation over a wide range of pulse frequency, thruster efficiency typically improves with higher pulse rate. Late time ablation is a key inefficiency of solid propellant pulsed devices, where material continues to ablate from the propellant surface well after the discharge pulse. Through higher frequency pulsing, the amount of material accelerated may be maximized.
- **Thrust-to-Power:** Pulsed devices suffer from several inefficiencies including late time ablation, frozen flow, and wall heating. Propulsion system efficiency is typically below 20% and may be as low as a few percent. Thus, although pulsed devices may have high specific impulse, the thrust-to-power is low. Small spacecraft with limited power for propulsion may find that large propellant loads provide little benefit as there is inherently a limitation to the number of pulses achievable over the life of the power-limited spacecraft.
- **Thermal Soak-back:** The low thruster efficiencies may result in large thermal loads on the spacecraft due to thermal soak-back, especially at high rates of pulsing. The spacecraft's ability to radiate this energy to limit heating may set an upper bound on pulse frequency.
- **Ignitor:** Pulsed devices usually require some form of ignitor to provide seed material to lower the impedance between the electrodes and initiate the discharge pulse. As such, the lifetime of the ignitor may dictate the lifetime of the thruster. Ignitors may fail due to

erosion or fouling that prevents sparking. Some devices may include multiple redundant ignitors to increase system lifetime.

- **Shorting:** The electrodes of pulsed devices are separated by isolating elements. Shadow shielding or other physical features are typically necessary to avoid shorting between electrodes as conductive material ejected by the thruster accumulates. While PTFE is an insulator, the PTFE is reduced to carbon and fluorine when ablated, where carbon accumulation provides a potentially conductive path. VATs employ metal propellants that can similarly result in unintended shorting.
- **Spacecraft Contamination:** As with any conductive propellant, contamination of the spacecraft is a concern. Plume interaction with the spacecraft must be understood to assess the impact of the plume on the operation of critical surfaces such as solar panels, antennas, and radiators.

### c. Missions

In 2019, CU Aerospace was selected for a NASA STMD Tipping Point award to design, fabricate, integrate, and perform mission operations for the DUPLEX 6U CubeSat having two of CU Aerospace's micro-propulsion systems on board, one Monofilament Vaporization Propulsion (MVP) system (121) (122), shown in figure 4.21, and one Fiber-Fed Pulsed Plasma Thruster (FPPT) system (123) (124) (125) (126), shown in figure 4.44. The FPPT can provide a large total impulse primary propulsion for micro-satellites through implementation of a novel PTFE fiber propellant storage and delivery mechanism. A major enhancement of the FPPT technology over classical PPTs is the ability to control both the propellant feed rate and pulse energy, thereby providing control of both the specific impulse and thrust. The FPPT can also provide precision control capability for small spacecraft requiring capabilities such as precision pointing or formation flying. In-orbit operations will include inclination change, orbit raising and lowering, drag makeup, and deorbit burns demonstrating multiple mission capabilities with approximately 20 hours of operation for MVP and >1,000 hours for FPPT. Launch is anticipated in mid-2022 (127).

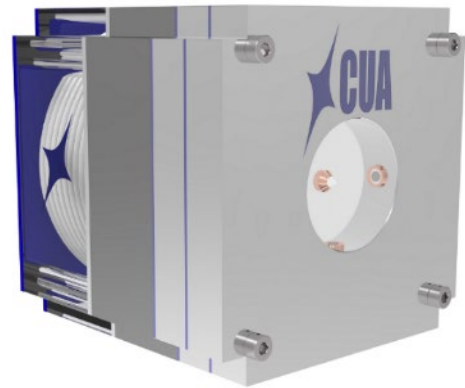


Figure 4.44: FPPT module. Credit: CU Aerospace.

### d. Summary Table of Devices

See table 4-11 for current state-of-the-art pulsed plasma and vacuum arc devices applicable to small spacecraft.

## Ambipolar

### a. Technology Description

Ambipolar thrusters ionize gaseous propellant within a discharge cavity via various means, including DC breakdown or RF excitation. The escape of high-mobility electrons from the discharge cavity creates a charge imbalance in the plasma discharge, and the subsequent ambipolar diffusion accelerates ions out of the cavity to generate thrust.

Because the thruster plume is charge neutral, no neutralizer assembly is necessary. A variety of propellants are theoretically usable due to the absence of exposed electrodes (and their associated material compatibility concerns).

#### b. Key Integration and Operational Considerations

- **Propellant Agnostic:** While ambipolar thrusters may be operable on a variety of propellants thanks to the devices' lack of exposed electrodes, different propellants will have different ionization costs (i.e., impact on thruster efficiency), plume behavior, and propellant storage requirements that should be considered during propellant selection.
- **Electromagnetic Interactions:** For RF-discharge thrusters, electromagnetic interference and compatibility (EMI/EMC) testing may be critical to assess the impact of thruster operations on spacecraft communications and payload functionality.
- **Thermal Soakback:** Low thruster efficiencies may result in large thermal loads on the spacecraft due to thermal soakback. Validated thermal modeling should be considered to assess impacts to the host spacecraft.

#### c. Missions

The SpaceX Falcon 9 Transporter-1 launch in January 2021 included two SmallSats with the Phase Four Maxwell Block 1 onboard. This integrated propulsion system (figure 4.45) includes the RF thruster and power electronics along with a xenon propellant tank and feed system (199).

The UniSat-7 mission, led by GAUSS, is a 36-kg microsatellite that launched via Soyuz-2-1a Fregat in March 2021. This technology demonstration mission included a T4i iodine-propellant REGULUS module (figure 4.46); the integrated propulsion system includes thruster, power processing unit, and heated propellant-feed components. The propulsion demonstration is expected to include orbit raising and lowering between orbital altitudes of 300 and 400 km (201) (202).

A 6U CubeSat from Team Miles has been awarded a rideshare slot onboard Artemis I, as one of the winning teams in NASA's Cube Quest Challenge. The objective of the mission is to demonstrate deep space communications from beyond a 2.5 million mile range. Twelve ConstantQ water-propellant thrusters (figure 4.47), an earlier version of Team Miles' M1.4 system, are integrated onboard the CubeSat to provide primary propulsion as well as 3-axis control (203) (204).

#### d. Summary Table of Devices

See table 4-12 for current state-of-the-art ambipolar devices applicable to small spacecraft.



Figure 4.45: Maxwell Block 1. Credit Phase Four.

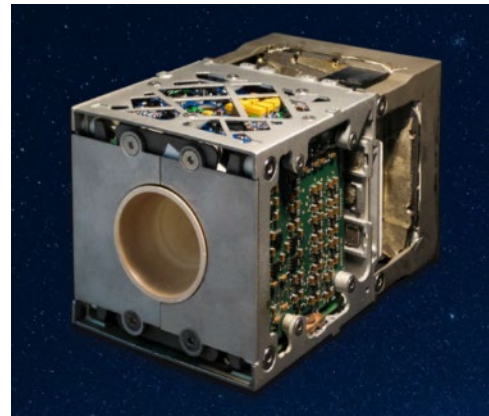


Figure 4.46: REGULUS propulsion module. Credit: T4i.

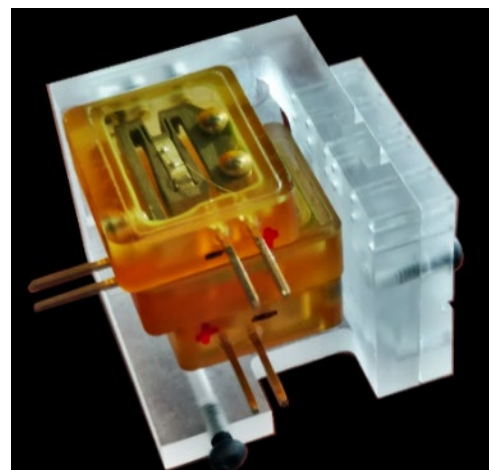


Figure 4.47: ConstantQ thruster head. Credit: Miles Space.



### 4.6.3 In-Space Propellant-less Propulsion

Propellant-less propulsion systems generate thrust via interaction with the surrounding environment (e.g., solar pressure, planetary magnetic fields, and planetary atmosphere). By contrast, chemical and electric propulsion systems generate thrust by expulsion of reaction mass (i.e., propellant). Three propellant-less propulsion technologies that have undergone in-space demonstrations to date include solar sails, electrodynamic tethers, and aerodynamic drag devices.

#### Solar Sails

Solar sails use solar radiation pressure to generate thrust by reflecting photons via lightweight, highly-reflective membranes. While no commercial products are presently available, a handful of missions have sought to demonstrate the technology using small spacecraft. Recent missions include:

- NASA's NanoSail-D2 launched as a 3U CubeSat secondary payload onboard the Fast, Affordable, Science and Technology Satellite (FASTSAT) bus in November 2010. The 10 m<sup>2</sup> sail made of CP-1 deployed from a 650 km circular orbit and de-orbited the spacecraft after 240 days in orbit (205).
- The Planetary Society's LightSail 2 mission launched as a 3U CubeSat secondary payload on the Department of Defense's Space Test Program (STP-2) in June 2019. The 32 m<sup>2</sup> mylar solar sail was deployed at 720 km altitude and demonstrated apogee raising of ~10 km. Its mission was still ongoing as of August 2020 (206).
- The University of Illinois (Urbana, IL) and CU Aerospace LLC (Champaign, IL) teamed to develop CubeSail, which launched as one of ten CubeSats on the Educational Launch of Nanosatellites ELaNA-19 mission on a Rocket Lab Electron rocket in December 2018. CubeSail launched as a mated pair of 1.5U CubeSats. When separated, it intended to deploy a 250 m-long, 20 m<sup>2</sup> aluminized mylar film between them. The development team envisions the CubeSail mission as the first of many missions of progressively increasing scale and complexity (207). Satellite beacons at the correct frequency were observed post-launch once on 18 Dec. 2018, but not with sufficient signal to noise ratio to demodulate the call sign in the beacons. No further communications were received from CubeSail. After more than 2 years of continued efforts to establish full communication with CubeSail, it is believed that the satellites irrevocably failed. While it is uncertain the specific cause, the best assessment is that the radios failed in orbit. Due to the lack of communications, CubeSail was never able to attempt sail deployment or attempt to demonstrate sail control and deorbiting (208).
- NASA's Near-Earth Asteroid (NEA) Scout mission is expected to launch as a secondary payload onboard Artemis I. The 6U CubeSat will deploy an 85 m<sup>2</sup> solar sail and conduct a flyby of Asteroid 1991VG, approximately 1 AU from Earth (209).

#### Electrodynamic Tethers

Electrodynamic tethers employ an extended, electrically conductive wire with current flow. In addition to atmospheric drag on the wire, its interaction with the ambient magnetic field about a planetary body causes a Lorentz force that can be used for orbit raising or lowering. This technology currently provides a means for end-of-mission small spacecraft deorbit.



### a. Missions

Georgia Institute of Technology's Prox-1 mission was launched as a secondary payload on the Department of Defense's Space Test Program (STP-2) in June 2019. The 70 kg spacecraft served as the host and deployer for the LightSail 2 mission. The Prox-1 spacecraft housed a Tethers Unlimited Nanosat Terminator Tape (NSTT), shown in figure 4.48, which deployed a 70 m tether in September 2019 to lower the orbit from 717 km. Data from the Space Surveillance Network indicate that the NSTT is causing Prox-1 to deorbit more than 24 times faster than otherwise expected. This rate of orbital decay will enable Prox-1 to meet its 25-year deorbit requirement (210) (211) (212).



Figure 4.48: Nanosat Terminator Tape (NSTT). Credit: Tethers Unlimited.

The Naval Postgraduate School's NPSat-1 was launched as a secondary payload on STP-2 and was expected to deploy its NSTT later in 2020 (212).

TriSept's DragRacer technology demonstration mission, launched as a rideshare onboard an Electron rocket in November 2020, sought to conduct a direct comparison of the deorbiting rates of two Millennium Space Systems satellites, one of which will use a 250 m NSTT (212) (213).

The AuroraSat-1 satellite is anticipated to be launched on an Electron rocket in Q4 2021 (131). The spacecraft is built by SatRevolution with Aurora Propulsion Technologies providing the payloads. The mission serves as a technology demonstration for a Plasma Brake module (figure 4.49), and an Attitude and Orbit Control System (AOCS) (128) (figure 4.22), both produced by Aurora. The Plasma Brake module on AuroraSat-1 is a dual redundant system for demonstration purposes. A 500-m tether will be deployed to demonstrate its deorbiting capability (129).

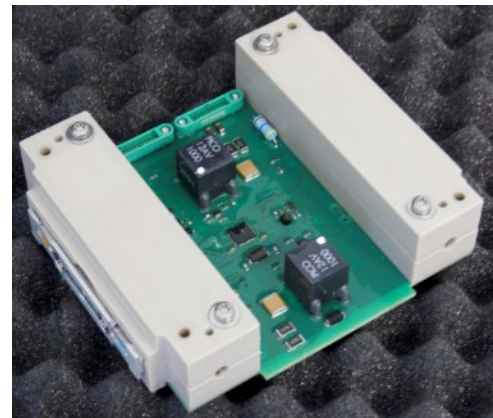


Figure 4.49: Plasma Brake Module (PBM) demo unit. Credit: Aurora Propulsion Technologies.

### Aerodynamic Drag

Satellites have historically deorbited from low-Earth orbits with the aid of thrusters or passive atmospheric drag. Given the increasing rate of new spacecraft launched, and in-turn potential for new orbital debris following completion of missions, orbital debris management has gained increasing attention. Space debris poses a growing threat to active satellites and human activity in space. Allowing decades for defunct spacecraft to decay naturally from low-Earth orbit may soon be insufficient. Aerodynamic drag devices may provide one method to rapidly remove spacecraft from low-Earth orbits upon mission completion.

Below about 1,000 km altitude, the atmosphere exerts a measurable drag force opposite the relative motion of any spacecraft, which results in a slow orbital decay. The intensity of the drag force exerted on the spacecraft depends on numerous factors such as local atmospheric density, the spacecraft forward facing area, the spacecraft velocity, and a drag coefficient. The drag coefficient accounts for the drag force's dependency on an object's unique geometric profile. While the spacecraft velocity and local atmospheric density are largely mission dependent, a spacecraft's forward-facing area and drag coefficient can be altered by introducing aerodynamic



drag devices such as exo-brakes and ballutes. These deployable or inflatable parachutes and balloons can greatly increase the drag force exerted on spacecraft by an order of magnitude or more and significantly increase the rate of orbital decay.

Furthermore, aerodynamic drag devices may be useful to reduce spacecraft propellant mass required for orbit capture and disposal at other planetary bodies, given sufficient atmospheric density exists.

For further details on these devices, see chapter on Deorbit Systems.



Table 4-2: Hydrazine Chemical Propulsion

Manufacturer	Product	Propellant	Thrust per Thruster (Quantity)	Specific Impulse	Total Impulse	Mass	Envelope	Power	ACS	Status	Missions	References
---	---	---	[N]	[s]	[kN-s]	[kg]	[cm <sup>3</sup> or U]	[W]	Y/N	C,D,E,F	---	---
<b>Integrated Propulsion Systems</b>												
Aerojet Rocketdyne	MPS-120	Hydrazine	0.25 – 1.0 (4)	N/A	>2 (2U) >0.8 (1U)	1.6 – 2.5 † 1.2 – 1.5 ‡	1U – 2U	N/A	Y	D	-	(73)
Aerojet Rocketdyne	MPS-125	Hydrazine	0.25 – 1.0 (4)	N/A	>19 (8U) >13 (6U) >7 (4U)	6.2 – 12.1 † 3.6 – 5.1 ‡	4U – 8U	N/A	Y	D	-	(73)
Stellar Exploration	Biprop 12U CubeSat system	Hydrazine/ NTO	3 N	>285	N/A	N/A	N/A	N/A	Y	D	-	(74)
<b>Thruster</b>												
Aerojet Rocketdyne	MR-103	Hydrazine	1 N	202-224	183	0.33-0.37	-	16 max total	-	F	numerous	(8)
Aerojet Rocketdyne	MR-111	Hydrazine	4 N	219-229	262	0.37	-	16 max total	-	F	numerous	(8)
Aerojet Rocketdyne	MR-106	Hydrazine	22 N	228-235	561	0.59	-	36 max total	-	F	numerous	(8)
ArianeGroup	1 N	Hydrazine	1 N	200 – 223	135	0.29	-	N/A	-	F	numerous	(6)
Moog	MONARC-1	Hydrazine	1 N	227.5	111	0.38	-	18 (Valve)	-	F	numerous	(9)
Moog	MONARC-5	Hydrazine	4.5 N	226.1	613	0.49	-	18 (Valve)	-	F	numerous	(9)
Moog	MONARC-22	Hydrazine	22 N	228-229	533 – 1,173	0.69-0.72	-	30 (Valve)	-	F	numerous	(9)

Note that all data is documented as provided in the references. Unless otherwise published, do not assume the data has been independently verified.

† denotes a wet mass, ‡ denotes a dry mass, N/A = Not Available



Table 4-3: Alternative Monopropellant and Bipropellant Propulsion

Manufacturer	Product	Propellant	Thrust per Thruster (Quantity)	Specific Impulse	Total Impulse	Mass	Envelope	Power	ACS	Status	Missions	References
---	---	---	[N]	[s]	[kN-s]	[kg]	[cm <sup>3</sup> or U]	[W]	Y/N	C,D,E,F	---	---
<b>Integrated Propulsion Systems</b>												
Aerojet Rocketdyne	MPS-130	AF-M315E	0.25 – 1.0 (4)	N/A	>2.7 (2U) >1.1 (1U)	1.7 – 2.8 † 1.1 – 1.4 ‡	1U – 2U	N/A	Y	D	-	(72) (73)
Aerojet Rocketdyne	MPS-135	AF-M315E	0.25 – 1.0 (4)	N/A	>19 (8U) >13.7 (6U) >7.3 (4U)	7.2 – 14.7 † 3.5 – 5.1 ‡	4U – 8U	N/A	Y	D	-	(73)
Aerospace Corp.	HyPer	Hydrogen Peroxide	N/A	N/A	N/A	N/A	~0.25U	N/A	N/A	D	-	(75)
Benchmark Space Systems	Halcyon	HTP & Alcohol	100 mN-22 N	270	1.7-10	2.5-7.5†	2000 – 7800 cm <sup>3</sup>	up to 10 W	Y	F	Tenzing-01 (2021)	(25) (76) (77)
Bradford-ECAPS	Skysat 1N HPGP Propulsion System	LMP-103S	1.0 (4)	200	>17	17	27U	10	Y	F	Skysat, PRISMA	(15) (84)
Busek	BGT-X5 System	AF-M315E	0.5	220 – 225	N/A	1.5 (BOL)	1U	20	N	D	-	(85)
Cornell Univ.	Cislunar Explorer	Water (Electrolysis)	N/A	N/A	N/A	N/A	6U total (2-units)	N/A	N/A	E	CubeQuest Challenge (Artemis I)	(21)
CU Aerospace	MPUC	(CMP-8) Peroxide/Ethanol blend	0.1 (1)	160 – 180	2.5	1.277 † 0.650 ‡	1U	3	N	D	-	(80) (87)
Dawn Aerospace	PM200	Nitrous Oxide & Propene	0.5 (1)	>285	>0.4 – 0.8	1.0 – 1.4	0.7 – 1U	12	Y	D	-	(27)
Moog	Monopropellant Propulsion Module	Green or 'Traditional'	0.5 (1)	224	0.5	1.01†	1U (baseline)	2 x 22.5 W/Thruster	N	D	-	(82)
MSFC	LFPS	AF-M315E	0.1 (4)	>200s	>3.5	<5.5kg	~2.4U	15 – 47W*	Y	E	Lunar Flashlight (Artemis I)	(17)
NanoAvionics	EPSS C1K	ADN-blend	1.0 (1) BOL 0.22 (1) EOL	213	>0.4	1.2 † 1.0 ‡	1.3U	0.19 (monitor) 9.6 (preheat) 1.7 (firing)	N	F	Lituanica-2	(26)
Rocket Lab	Kick Stage	Unk.	120	N/A	N/A	N/A	N/A	N/A	Y	F	Electron 'Still Testing'	(29) (30)
Tethers Unlimited	HYDROS-C	Water (Electrolysis)	1.1 (1)	>310	>2	2.61 † 1.87 ‡	190 mm x 130 mm x 92 mm	5-25	N	F	Pathfinder Technology Demonstration	(24) (81) (88)
Tethers Unlimited	HYDROS-M	Water (Electrolysis)	>1.2 (1)	>310	>18	12.6 † 6.4 ‡	381 mm dia. x 191 mm	7-40	N	D	-	(81)
VACCO	ArgoMoon Hybrid MiPS	LMP-103S/cold-gas	0.1 (1)	190	1	14.7 † 9 ‡	~1.3U	13.6 20 (max)	Y	E	ArgoMoon (Artemis I)	(57) (91)
VACCO	Green Propulsion System (MiPS)	LMP-103S	0.1 (4)	190	4.5	5 † 3 ‡	~3U	15 (max)	Y	D	-	(57) (89)
VACCO	Integrated Propulsion System	LMP-103S	1.0 (4)	200	12.5	14.7 † 9 ‡	~1U – 19,000 cm <sup>3</sup>	15 – 50 (max)	Y	E	-	(57) (90)

Note that all data is documented as provided in the references. Unless otherwise published, do not assume the data has been independently verified.

† denotes a wet mass, ‡ denotes a dry mass, N/A = Not Available



Table 4-3 (cont.): Other Monopropellant and Bipropellant Propulsion

Manufacturer	Product	Propellant	Thrust per Thruster (Quantity)	Specific Impulse	Total Impulse	Mass	Envelope	Power	ACS	Status	Missions	References
---	---	---	[N]	[s]	[kN-s]	[kg]	[cm <sup>3</sup> or U]	[W]	Y/N	C,D,E,F	---	---
<b>Integrated Propulsion Systems (cont.)</b>												
VACCO	Green Propulsion System (MiPS)	LMP-103S	0.1 (4)	190	4.5	5 † 3 ‡	~3U	15 (max)	Y	D	-	(57) (89)
VACCO	Integrated Propulsion System	LMP-103S	1.0 (4)	200	12.5	14.7 † 9 ‡	~1U – 19,000 cm <sup>3</sup>	15 – 50 (max)	Y	D	-	(57) (90)
<b>Thruster Heads</b>												
Aerojet Rocketdyne	GR-M1	AF-M315E	0.25	195	3.45	--	--	7	-	D	-	(31)
Aerojet Rocketdyne	GR-1	AF-M315E	0.4-1.1	231	23	N/A	-	12	-	F	GPIM	(8) (13)
Aerojet Rocketdyne	GR-22	AF-M315E	8.0-25	248	74	N/A	-	28	-	E	GPIM	(8) (13)
Aerospace Corp.	Hydrogen Peroxide Vapor Thruster (HyPer)	Hydrogen Peroxide	<10 mN	N/A	N/A	N/A	-	N/A	-	D	-	(75)
Bradford-ECAPS	0.1 N HPGP	LMP-103S	0.03 – 0.10	196 – 209	N/A	0.04 excl. FCV	-	6.3 – 8	-	E	ArgoMoon	(78)
Bradford-ECAPS	1 N HPGP	LMP-103S	0.25 – 1.0	204 – 235	N/A	0.38	-	8 – 10	-	F	SkySat	(15) (78)
Bradford-ECAPS	1 N GP	LMP-103S/LT	0.25 – 1.0	194 – 227	N/A	0.38	-	8 – 10	-	D	-	(79)
Bradford-ECAPS	5 N HPGP	LMP-103S	1.5 – 5.5	239 – 253	N/A	0.48	-	15 – 25	-	D	-	(78)
Bradford-ECAPS	22 N HPGP	LMP-103S	5.5 – 22	243 – 255	N/A	1.1	-	25 – 50	-	D	-	(78)
Busek	BGT-X1	AF-M315E	0.02 – 0.18	214	N/A	N/A	-	4.5	-	D	-	(86)
Busek	BGT-X5	AF-M315E	0.50	220 – 225	0.5	1.5†	1U	20	-	D	-	(85) (86)
Busek	BGT-5	AF-M315E	1.0 – 6.0	> 230	N/A	N/A	-	50	-	D	-	(86)
Dawn Aerospace	20N Thruster	N20/Propene	7.3 – 19.8N	>285		0.4	-	12W	-	F	numerous	(33)
NanoAvionics	EPSS-C1	ADN-blend	0.22 – 1.0	213	>0.4	N/A	-	9.6 (preheat) 1.7 (firing)	-	F	Lituanica-2	(26)
Plasma Processes	100mN Thruster PP3490-B	AF-M315E	0.1 – 0.17	195 - 208	N/A	.08	-	7.5 – 10	-	E	Lunar Flashlight	(17)
Rocket Lab	Curie Engine	unk.	120	N/A	N/A	N/A	-	N/A	-	F	Electron 'Still Testing'	(29) (30)

Note that all data is documented as provided in the references. Unless otherwise published, do not assume the data has been independently verified.

† denotes a wet mass, ‡ denotes a dry mass, N/A = Not Available



Table 4-4: Hybrid Chemical Propulsion

Manufacturer	Product	Propellant	Thrust (Quantity)	Specific Impulse	Total Impulse	Mass	Envelope	Power	ACS	Status	Missions	References
---	---	---	[N]	[s]	[N-s]	[kg]	[cm <sup>3</sup> or U]	[W]	Y/N	C,D,E,F	---	---
Aerospace Co.	Propulsion Unit for CubeSats	Paraffin/Nitrous Oxide	N/A	N/A	N/A	N/A	1U	N/A	-	D		(41)
JPL	Hybrid Rocket	PMMA/GOX	N/A	>300	N/A	N/A	N/A	N/A	-	D	-	(38) (93) (94) (95)
NASA Ames	Hybrid Rocket	PMMA/ Nitrous Oxide	25	247	N/A	N/A	N/A	N/A	-	D		(39)(40) (94)
Parabilis	ROMBUS	Various/N <sub>2</sub> O	222	260s	Configurable	N/A	ESPA, ESPA Grande	N/A	Y	D		(42)
Parabilis	NanoSat Orbital Transfer System	HTPB/N <sub>2</sub> O	9.4	245s	N/A	3U OTS	Modular, 3U to 50kg sat	N/A	Y	C		(96)
Utah State Univ.	Green Hybrid Rocket	ABS/Nyrox	25-50	220-300	N/A	N/A	3-25U	<30W for 1-2 sec	Y	D		(36)(37)
Utah State Univ.	Green Hybrid Rocket	ABS/GOX	8	215	N/A	N/A	N/A	N/A	-	D	-	(34) (35) (92)

Note that all data is documented as provided in the references. Unless otherwise published, do not assume the data has been independently verified.  
† denotes a wet mass, ‡ denotes a dry mass, N/A = Not Available



Table 4-5: Cold and Warm Gas Propulsion

Manufacturer	Product	Propellant	Thrust (Quantity)	Specific Impulse	Total Impulse	Mass	Envelope	Power	ACS	Status	Missions	References
---	---	---	[mN]	[s]	[N-s]	[kg]	[cm <sup>3</sup> or U]	[W]	Y/N	C,D,E,F	---	---
<b>Integrated Propulsion Systems</b>												
Aerospace Corp.	MEPSI	R236fa	20	N/A	N/A	0.188	4 in. x 4 in. x 5in.	N/A	Y	E	STS-113 and STS-116	(44)
GomSpace / NanoSpace	Nanoprop CGP3	Butane	0.01 – 1 (x4)	60-110	40	0.3‡ 0.35†	0.5U	<2	Y	D	-	(50) (108)
GomSpace / NanoSpace	Nanoprop 6U	Butane	1 – 10 (x4)	60-110	80	0.770‡ 0.900†	200 mm x 100 mm x 50 mm	<2	Y	F	GomX-4	(50) (51) (109)
Lightsey Space Research	BioSentinel Propulsion System	R236fa	40 - 70	40.7	79.8	1.08 kg ‡ 1.28 kg †	220 mm x 100 mm x 40 mm	<1 W idle <4 W operating	Y	E	BioSentinel	(52) (53)
Marotta	MicroThruster	Nitrogen	0.05 – 2.36 N	70	N/A	N/A	N/A	<1	N/A	F	numerous	(43)
Micro Space	POPSAT-HIP1	Argon	0.083 – 1.1 (x8)	43	N/A	N/A	N/A	N/A	N/A	F	POPSAT-HIP1	(49)
SSTL	Butane Propulsion System	Butane	0.5 N							D	-	(45) (46)
ThrustMe	I2T5	Iodine	0.2		75	0.9†	0.5U	10	N	F	Xiaoxiang 1-08, Robusta-3A (2021**)	(62) (63) (64) (65)
UTIAS/SFL	CNAPS	Sulfur Hexafluoride	12.5 – 40	30	81	N/A	N/A	N/A	N	F	CanX-4/CanX-5	(110) (111)
VACCO	NEA Scout	R236fa	N/A	N/A	500	2.54†	2U	9	Y	E	NEA Scout (2021**)	(60) (61)
VACCO	MiPS Standard Cold Gas	R236fa	25 (x4)	40	98 – 489	553 – 957‡	0.4 – 1.38U	12 W (max)	Y	D	-	(57) (105)
VACCO	MarCO-A and -B MiPS	R236fa	25 (x8)	40	755	3.5	2U	15	Y	F	MarCO-A & -B	(57) (58) (59) (106)
VACCO	C-POD	R134A	25 (x8)	40	186	1.3	0.8U	5	Y	E	CPOD	(57) (107)

Note that all data is documented as provided in the references. Unless otherwise published, do not assume the data has been independently verified.

† denotes a wet mass, ‡ denotes a dry mass, N/A = Not Available, \*\* anticipated launch date



Table 4-6: Solid Motor Chemical Propulsion												
Manufacturer	Product	Propellant	Thrust (Quantity)	Specific Impulse	Total Impulse	Mass	Envelope	Power	ACS	Status	Missions	References
---	---	---	[N]	[s]	[N-s]	[kg]	[cm <sup>3</sup> or U]	[W]	Y/N	C,D,E,F	---	---
<b>Integrated Propulsion Systems</b>												
D-Orbit	D-Raise	N/A	N/A	N/A	N/A	50 – 78	N/A	N/A	N	D	-	(103)
D-Orbit	D3	N/A	N/A	N/A	N/A	16 – 257	32 cm x 32 cm x 25 cm to 1100 cm x 500 cm x 1000 cm	N/A	N	D	-	(104)
DSSP	CAPS-3	HIPEP-501A	0.3 (3)	N/A	0.125	0.023	0.92 cm x 2.79 cm x 4.2 cm	< 2.3	N	F	SPINSAT	(67) (97)
DSSP	MPM-7	HIPEP-H15	N/A	200	1.5	<750 g (PPU)	< 0.75 U	200	N	D	-	(98)
PacSci EMC	MAPS	N/A	N/A (176 per lightband)	210	N/A	N/A	38 cm x 10.5 cm	N/A	N/A	F	PACSCISAT	(68) (69)
PacSci EMC	P-MAPS	N/A	N/A	N/A	N/A	N/A	N/A	N/A	N/A	D	-	(68)
<b>Thruster Heads</b>												
DSSP	CDM-1	AP/HTPB	186.8	235	226.4	0.046	0.64 dia x 0.47 length	< 5	-	D	Listed as "flight qualified"	(99) (100)
Industrial Solid Propulsion	ISP 30 sec. Motor	80% Solids HTPB/AP	37	187	996	0.95	5.7 cm	-	-	D	Optical target at Kirtland AFB	(66) (101)
Northrop Grumman (Former Orbital ATK)	STAR 4G	TP-H-3399	258	276	595	1.49	11.3 cm dia. x 13.8	-	-	D	-	(66) (102)

Note that all data is documented as provided in the references. Unless otherwise published, do not assume the data has been independently verified.

† denotes a wet mass, ‡ denotes a dry mass, N/A = Not Available



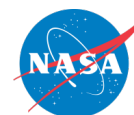


Table 4-7: Electrothermal Electric Propulsion												
Manufacturer	Product	Propellant	Thrust*	Specific Impulse*	Total Impulse*	Mass	Envelope	Power	ACS	Status	Missions	References
---	---	---	[mN]	[s]	[N-s]	[g]	[cm <sup>3</sup> or U]	[W]	Y/N	C,D,E,F	---	---
<b>Integrated Propulsion Systems</b>												
Aurora Propulsion Technologies <sup>Finland</sup>	AOCS	H <sub>2</sub> O	0.5	100	70	280 <sup>†</sup>	0.3U	10 <sup>£</sup>	Y	E	AuroraSat-1 (2021 <sup>**</sup> )	(128) (129) (131)
Busek <sup>USA</sup>	Micro Resistojet	Ammonia	10	150	404	1,250 <sup>†</sup>	1U	15	Y	D	---	(214)
Bradford Space <sup>Netherlands</sup>	Comet-1000	H <sub>2</sub> O	17	175	1,155	1,440 <sup>†</sup>	2,600	55	N	F	HawkEye 360, Capella Space	(114) (115) (116)
Bradford Space <sup>Netherlands</sup>	Comet-8000	H <sub>2</sub> O	17	175	8,348	6,675 <sup>†</sup>	23,760	55	N	F	BlackSky Global	(114) (117)
CU Aerospace and VACCO <sup>USA</sup>	CHIPS	R134a	31	76	478	1,375 <sup>†</sup>	1U	30	Y	D	---	(215) (216) (217) (218)
CU Aerospace and VACCO <sup>USA</sup>	CHIPS	R236fa	23	60	433	1,510 <sup>†</sup>	1U	30	Y	D	---	(215) (216) (217) (218)
CU Aerospace and VACCO <sup>USA</sup>	PUC	SO <sub>2</sub>	4.5	70	184	718 <sup>†</sup>	0.35U	15	N	E	8 flight units delivered to AFRL	(118) (119) (120)
CU Aerospace <sup>USA</sup>	MVP	Delrin Fiber	4.5	66	334	1,140 <sup>†</sup>	1.15U	45	N	E	DUPLEX (launch mid-2022 <sup>**</sup> )	(121) (122)
<b>Thruster Heads</b>												
Sitael <sup>Italy</sup>	XR-150	Xe	65	57	NA	220 <sup>‡</sup>	21.6	100	NA	D	---	(219) (220)
Sitael <sup>Italy</sup>	XR-150	Kr	67.2	70	NA	220 <sup>‡</sup>	21.6	100	NA	D	---	(219) (220)
Note that all data is documented as provided in the references. Unless otherwise published, do not assume the data has been independently verified.												
*nominal values (see references for full performance ranges), ** anticipated launch date, † denotes a wet mass, ‡ denotes a dry mass, £ per active thruster, NA = Not Applicable												



Table 4-8: Electro Spray Electric Propulsion												
Manufacturer	Product	Propellant	Thrust*	Specific Impulse*	Total Impulse*	Mass	Envelope	Power	Neutralizer	Status	Missions	References
---	---	---	[ $\mu$ N]	[s]	[N-s]	[kg]	[cm <sup>3</sup> or U]	[W]	---	C,D,E,F	---	---
Integrated Propulsion Systems												
Accion Systems <sup>USA</sup>	TILE-2	EMI-BF4 (ionic)	50	1,650	35	0.45 <sup>†</sup>	0.5U	4	NA	F	Astro Digital Tenzing, BeaverCube (2021 <sup>**</sup> )	(145) (146) (147) (233)
Accion Systems <sup>USA</sup>	TILE-3	EMI-BF4 (ionic)	450	1,650	755	2.25 <sup>†</sup>	1U	20	NA	F	D2/AtlaCom-1	(147) (148) (149) (234)
Busek <sup>USA</sup>	CMNT (4x heads)	EMI-Im (ionic)	4 x 20	225	980	14.8 <sup>†</sup>	29U	16.5	Carbon Nanotube	F	LISA Pathfinder	(132)
Busek <sup>USA</sup>	BET-300-P (4x heads)	EMI-Im (ionic)	4 x 55	850	360	0.8 <sup>†</sup>	1150	15	Carbon Nanotube	D	---	(221) (222) (223) (224) (225)
Enpulsion <sup>Austria</sup>	IFM Nano	Indium (FEFP)	350	3,500	---	0.90 <sup>†</sup>	10 x 10 x 8.3	40	Thermionic	F	Flock 3p', ICEYE X2, Harbinger, NetSat	(133) (134) (135) (136) (137) (138) (139) (226) (227) (228)
Enpulsion <sup>Austria</sup>	IFM Micro R <sup>3</sup>	Indium (FEFP)	1,000	3,000	---	3.9 <sup>†</sup>	14 x 12 x 13.3	100	Thermionic	F	GMS-T	(140) (229) (230)
Morpheus Space <sup>Germany</sup>	NanoFEFP (2x heads)	Gallium (FEFP)	<40	---	---	0.16 <sup>‡</sup>	9 x 2.5 x 4.3	<3	Propellant-less	E	UWE-4	(141) (142) (231) (232)
Morpheus Space <sup>Germany</sup>	MultiFEFP (2x heads)	Gallium (FEFP)	<140	---	---	0.28 <sup>‡</sup>	9 x 4.5 x 4.5	<19	Propellant-less	D	---	(231)

Note that all data is documented as provided in the references. Unless otherwise published, do not assume the data has been independently verified.  
\*nominal values (see references for full performance ranges), \*\* anticipated launch date, † denotes a wet mass, ‡ denotes a dry mass, NA = Not Applicable



Table 4-9: Gridded-Ion Electric Propulsion												
Manufacturer	Product	Propellant	Thrust*	Specific Impulse*	Total Impulse*	Mass	Envelope	Power	Cathode Type	Status	Missions	References
---	---	---	[mN]	[s]	[kN-s]	[kg]	[cm <sup>3</sup> or U]	[W]	---	C,D,E,F	---	---
<b>Integrated Propulsion Systems</b>												
Avant Space <sup>Russia</sup>	GT-50 <sup>RF</sup>	Xenon	<7	---	---	<8 <sup>†</sup>	<4U	<240	Hollow	D	---	(235) (236)
Busek <sup>USA</sup>	BIT-3 <sup>RF</sup>	Iodine	1.15	2,100	32	2.9 <sup>†</sup> (with gimbal)	18 x 8.8 x 10.2	75	RF	E	Lunar IceCube (2021 <sup>**</sup> ); LunaH-Map (2021 <sup>**</sup> )	(156) (157) (158) (237) (238) (239)
ThrustMe <sup>France</sup>	NPT30 <sup>RF</sup>	Xenon	<1.1	---	---	<1.7 <sup>†</sup>	<2U	<60	Thermionic	D	---	(240)
ThrustMe <sup>France</sup>	NPT30-I2 <sup>RF</sup>	Iodine	<1.1	---	---	1.2 <sup>†</sup> (1U) or 1.7 <sup>†</sup> (1.5U)	1U or 1.5U	<65	Thermionic	F	Beihangkongshi-1; NORSAT-TD (2022 <sup>**</sup> ); GOMX-5 (2022 <sup>**</sup> )	(153) (154) (155) (241) (242) (243)
<b>Thruster Heads</b>												
Ariane Group <sup>Germany</sup>	RIT $\mu$ X <sup>RF</sup>	Xenon	<0.5	---	---	0.44 <sup>‡</sup>	7.8 x 7.8 x 7.6	<50	RF	D	---	(244) (245) (246) (247)
Ariane Group <sup>Germany</sup>	RIT 10 EVO <sup>RF</sup>	Xenon	<15	---	---	1.8 <sup>‡</sup>	18.6 x 18.6 x 13.4	<435	Hollow	E	(Identical to flight-heritage RIT-10 with contemporary grid design)	(244) (246) (248)
QinetiQ <sup>UK</sup>	T5 <sup>DC</sup>	Xenon	<20	<3,000	---	2 <sup>‡</sup>	19 x 19 x 24.2	<600	Hollow	F	GOCE	(151) (152) (249) (250)
Note that all data is documented as provided in the references. Unless otherwise published, do not assume the data has been independently verified.												
*nominal values (see references for full performance ranges), ** anticipated launch date, † denotes a wet mass, ‡ denotes a dry mass, NA = Not Applicable, RF = Radio Frequency												



Table 4-10: Hall-Effect Electric Propulsion Thrusters

Manufacturer	Product	Propellant	Thrust*	Specific Impulse*	Total Impulse*	Mass	Envelope	Thruster Power*	Cathode Type	Status	Missions	References
---	---	---	[mN]	[s]	[kN-s]	[kg]	[cm <sup>3</sup> ]	[W]	Notes	C,D,E,F	---	---
Apollo Fusion <sup>USA</sup>	ACE	Xenon	22	1,300	200	1.0	---	400 <sup>‡</sup>	CM-HL	F	Sherpa-LTE (2021)	(181) (182) (251)
Apollo Fusion <sup>USA</sup>	ACE	Krypton	16	1,200	200	1.0	---	400 <sup>‡</sup>	CM-HL	D	---	(251)
Apollo Fusion <sup>USA</sup>	ACE	Proprietary	24	1,250	---	1.0	---	400 <sup>‡</sup>	CM-HL	E	Astro Digital Ignis (2020 <sup>**</sup> )	(179) (180)
Busek <sup>USA</sup>	BHT-100	Xenon	6.3	1,086	150	1.2	275 wo cath.	105	EM-SH	D	---	(168) (252)
Busek <sup>USA</sup>	BHT-200	Xenon	13	1,390	84 <sup>§</sup>	1.2	675 wo cath.	250 <sup>‡</sup>	EM-SH	F	TacSat-2, FalconSat-5, -6	(168) (169) (253) (254)
Busek <sup>USA</sup>	BHT-200-I	Iodine	14	1390	---	1.2	675 wo cath.	250	EM-SH	E	NASA iSat (Cancelled)	(169) (170) (253)
Busek <sup>USA</sup>	BHT-600	Xenon	39	1,500	1000 <sup>§</sup>	3.3	1,470 wo cath.	680 <sup>‡</sup>	EM-SH	E	US Government (2021 <sup>**</sup> )	(168) (195) (255) (256)
Busek <sup>USA</sup>	BHT-600-I	Iodine	39	---	---	3.3	1,470 wo cath.	600	EM-SH	D	---	(169) (255) (256) (257)
EDB FakeI <sup>Russia</sup>	SPT-50	Xenon	14	860	126 <sup>§</sup>	1.2	1,092	220	EM-SH	F	Canopus-V	(163) (164) (165) (166) (258)
EDB FakeI <sup>Russia</sup>	SPT-50M	Xenon	14.8	930	266	1.3	---	220	EM-SH	D	---	(258)
EDB FakeI <sup>Russia</sup>	SPT-70BR	Xenon	39	1,470	435 <sup>§</sup>	2.0	1,453	660	EM-SH	F	KazSat-1, KazSat-2	(166) (167)
EDB FakeI <sup>Russia</sup>	SPT-70M	Xenon	41.3	1,580	---	---	---	660	EM-SH	D	---	(167)
EDB FakeI <sup>Russia</sup>	SPT-70M	Krypton	31.3	1,460	---	---	---	660	EM-SH	D	---	(167)
ExoTerra <sup>USA</sup>	Halo	Xenon	7.1	1,110	100	0.67	220	185	CM-HL	E	Tipping Point (2021 <sup>**</sup> )	(188) (189) (190)
Exotrail <sup>France</sup>	ExoMG nano	Xenon	2.0	800	5	---	---	53	EM-SH	F	M6P Demo (2020 <sup>**</sup> ), ELO3 and ELO4 (2021 <sup>**</sup> )	(183) (184) (185) (186) (187)
Exotrail <sup>France</sup>	ExoMG micro	Xenon	5	1,000	19	---	---	100	EM-SH	D	---	(183) (186)
JPL <sup>USA</sup>	MaSMi	Xenon	55	1,920	3,000	3.4	1,700	1,000	CM-HL	D	---	(259) (260) (261) (262) (263) (264) (265) (266) (267)
Orbion <sup>USA</sup>	Aurora	Xenon	12	1,220	200	1.5	1,147	200	EM-SH	E	AST SpaceMobile (2022), DARPA Blackjack (**)	(191) (192) (193) (194) (268)
Rafael <sup>Israel</sup>	R-200HT	Xenon	---	---	---	---	---	200	EM-HL	D	---	(171)
Rafael <sup>Israel</sup>	IHET-300	Xenon	>14.3	>1,210	>135	1.5	1,836	300	EM-SH	F	VENuS	(171) (172) (173) (174)
Rafael <sup>Israel</sup>	R-800HT	Xenon	---	---	560	---	---	800	EM-HL	D	---	(171)
Safran <sup>France</sup>	PPS-X00	Xenon	43	1,530	1,000	---	---	650	EM-SH	D	---	(269)
SITAEL <sup>Italy</sup>	HT100	Xenon	9	1,300	73	---	407 wo cath.	175	EM-SH	E	uHETSat (2021 <sup>**</sup> )	(176) (177) (178)
SITAEL <sup>Italy</sup>	HT400	Xenon	27.5	1230	1,000	2.77	1,330	615	EM-SH	D	---	(270) (271) (272)
SETS <sup>Ukraine</sup>	ST25	Xenon	7.6	1,000	82	0.75	1,003	140	EM-SH	D	---	(273) (274)
SETS <sup>Ukraine</sup>	ST40	Xenon	25	1,450	450	1.1	1,170	450	EM-HL	D	---	(275)

Note that all data is documented as provided in the references. Unless otherwise published, do not assume the data has been independently verified.

\*nominal values (see references for full performance ranges), \*\* anticipated launch date, ‡ PPU input power, § demonstrated, CM = Center Mounted, EM = Externally Mounted, SH = Swaged Heater, HL = Heater-less, JPL = Jet Propulsion Laboratory, SETS = Space Electric Thruster Systems, EDB = Experimental Design Bureau



Table 4-11: Pulsed Plasma and Vacuum Arc Electric Propulsion													
Manufacturer	Product	Propellant	Thrust*	Impulse Bit	Specific Impulse*	Total Impulse*	Mass	Envelope	Power*	ACS	Status	Missions	References
---	---	---	[ $\mu$ N]	[ $\mu$ Ns]	[s]	[N-s]	[kg]	[cm <sup>3</sup> or U]	[W]	Y/N	C,D,E,F	---	---
<b>Integrated Propulsion Systems</b>													
Applied Sciences Corp. <sup>USA</sup>	Metal Plasma Thruster	Molybdenum	600	150	1,756	4,000	0.85	0.7U	50	N	D	---	(276)
Busek <sup>USA</sup>	BmP-220	PTFE	20	20	---	175	0.5	375 + ESV	3	N	D	---	(277)
Comat <sup>France</sup>	Plasma Jet Pack	(metal)	288	29	---	4,000	1.0	1U	30	N	D	---	(278) (279)
CU Aerospace <sup>USA</sup>	FPPT-1.6	PTFE Fiber	270	180	2,400	20,700	2.8 <sup>†</sup>	1.6U	48	N	E	DUPLEX (launch mid-2022 <sup>**</sup> )	(123) (124) (125)
Mars Space Ltd <sup>UK</sup> Clyde Space <sup>Sweden</sup>	PPTCUP	PTFE	40	40	655	48	0.27	0.33U	2.7	N	D	---	(280)

Note that all data is documented as provided in the references. Unless otherwise published, do not assume the data has been independently verified.  
 \*nominal values (see references for full performance ranges), \*\* anticipated launch date, † denotes a wet mass, ‡ denotes a dry mass, NA = Not Applicable, ESV = Ejector Spring Volume

Table 4-12: Ambipolar Electric Propulsion													
Manufacturer	Product	Propellant	Thrust*	Specific Impulse*	Total Impulse*	Mass	Envelope	Power	ACS	Status	Missions	References	
---	---	---	[mN]	[s]	[kN-s]	[kg]	[cm <sup>3</sup> ]	[W]	Y/N	C,D,E,F	---	---	
<b>Integrated Propulsion Systems</b>													
Phase Four <sup>USA</sup>	Maxwell (Block 1) <sup>RF</sup>	Xenon	6	400	5	5.9 <sup>‡</sup>	19 x 13.5 x 19	450	N	F	Capella	(199) (200) (281) (282) (283) (284)	
Phase Four <sup>USA</sup>	Maxwell (Block 3) <sup>RF</sup>	Xenon	5.5	800	---	---	22 x 12 x 24 (without tank)	450	N	D	---	(284)	
T4i <sup>Italy</sup>	REGULUS <sup>RF</sup>	Iodine	0.55	550	3	2.5 <sup>†</sup>	1.5U	50	N	F	UniSat-7	(201) (202) (285)	
Miles Space <sup>USA</sup>	M1.4	Water	2.8	1340	3.3	0.8 <sup>†</sup>	9 x 9 x 9.5	<11.5	N	E	Team Miles (2021 <sup>**</sup> )	(203) (204) (286)	

Note that all data is documented as provided in the references. Unless otherwise published, do not assume the data has been independently verified.  
 \*nominal values (see references for full performance ranges), \*\* anticipated launch date, † denotes a wet mass, ‡ denotes a dry mass, NA = Not Applicable, RF = Radio Frequency

Table 4-13: Propellant-less Propulsion													
Manufacturer	Product	Propellant	Thrust*	Specific Impulse*	Total Impulse*	Mass	Envelope	Power	ACS	Status	Missions	References	
---	---	---	[mN]	[s]	[kN-s]	[kg]	[cm <sup>3</sup> ]	[W]	Y/N	C,D,E,F	---	---	
Aurora <sup>Finland</sup>	Plasma Brake Module	NA	---	NA	NA	<1	1U	<4	N	E	AuroraSat-1 (2021 <sup>**</sup> )	(129) (131) (287)	
Tethers Unlimited <sup>USA</sup>	NSTT	NA	---	NA	NA	0.81	18 x 18 x 1.8	---	N	F	Prox-1, NPSat-1, DragRacer	(210) (211) (212) (288)	

Note that all data is documented as provided in the references. Unless otherwise published, do not assume the data has been independently verified.  
 \*nominal values (see references for full performance ranges), \*\* anticipated launch date, † denotes a wet mass, ‡ denotes a dry mass, NA = Not Applicable  
 See Chapter on Passive Deorbit Systems for review of aerodynamic drag devices.



## References

- (1) "NASA Systems Engineering Handbook." NASA/SP-2016-6105, Rev2.
- (2) "NASA Systems Engineering Processes and Requirements." NPR 7123.1C, Effective 14 February 2020, Expiration 14 February 2025.
- (3) JANNAF Spacecraft Propulsion Subcommittee, Micro-Propulsion Panel, "JANNAF Guidelines for the Application of Technology Readiness Levels (TRLs) to Micro-Propulsion Systems." JANNAF 2019, Tampa, FL, Distribution Unlimited
- (4) Marshall, W. M. and M. Deans. "Recommended Figures of Merit for Green Monopropellants." NASA TM-2013-216560. National Aeronautics & Space Administration. Cleveland, OH. August, 2013.
- (5) "AISat-2". <https://directory.eoportal.org/web/eoportal/satellite-missions/a/alsat-2>
- (6) Arianegroup. "Chemical Monopropellant Thruster Family." Product Brochure. <http://www.space-propulsion.com/brochures/hydrazine-thrusters/hydrazine-thrusters.pdf>
- (7) Stratton, J. 2004. "The use of the aeromet MR-103H thruster on the New Horizons mission to Pluto." 55th International Astronautical Congress.
- (8) Aerojet Rocketdyne. "In-Space Propulsion Data Sheets: Monopropellant and Bipropellant Engines." Product Brochure. <https://www.rocket.com/sites/default/files/documents/In-Space%20Data%20Sheets%209.13.19.pdf>
- (9) Moog Space and Defense Group. "Monopropellant Thrusters." Product Brochure. [https://www.moog.com/content/dam/moog/literature/Space\\_Defense/spaceliterature/propulsion/Moog-MonopropellantThrusters-Datasheet.pdf](https://www.moog.com/content/dam/moog/literature/Space_Defense/spaceliterature/propulsion/Moog-MonopropellantThrusters-Datasheet.pdf)
- (10) Robert K. Masse and Benjamin A. Glassy, Low-Vapor-Toxicity Hydrazine Propellant Blends," Joint Meeting of the 49th Combustion (CS), 37th Airbreathing Propulsion (APS), 37th Exhaust Plume and Signatures (EPSS), and 31st Propulsion Systems Hazards (PSHS) Subcommittees; and the 66th JANNAF Propulsion Meeting (JPM) and meeting of the Programmatic and Industrial Base (PIB), June 3 7, 2019.
- (11) Cavender, D., W. Marshall, and A. Maynard. "2018 NASA Green Propulsion Technology Development Roadmap." NASA/TP—2018—219861. National Aeronautics and Space Administration. August, 2018.
- (12) United States Air Force – Air Force Space Command. AFSPCMAN 91-710. "Range Safety User Requirements." 1 July 2004. Certified Current 17 September, 2013.
- (13) Spores, R., Masses, R., Kimbrel, S., McLean, C. AIAA-2013-3849. "GPIM AF-M315E Propulsion System." 49th AIAA/ASME/SAE/ASEE Joint Propulsion Conference & Exhibit. San Jose.
- (14) Mulkey, H., J. Miller, and C. Bacha. "Green Propellant Loading Demonstration at U.S. Range." AIAA-2016-4576. AIAA Propulsion and Energy Forum. Salt Lake City, UT. July 25-27, 2016.
- (15) Friedhoff, P., K. Anflo, M. Persson, and P. Thormahlen. "Growing Constellation of Ammonium Dinitramide (ADN) Based High Performance Green Propulsion (HPGP) Systems." AIAA-2018-4754. AIAA Propulsion and Energy Forum, Cincinnati, OH, July 9-11, 2018.
- (16) ESA Earth Observation Portal, "ELSA-d (End-of-Life Service by Astroscale)-d (demonstration)" <https://directory.eoportal.org/web/eoportal/satellite-missions/content/-/article/elsa-d#dev>
- (17) Jet Propulsion Laboratory, National Aeronautics and Space Administration. "Lunar Flashlight." [https://www.jpl.nasa.gov/CubeSat/missions/lunar\\_flashlight.php](https://www.jpl.nasa.gov/CubeSat/missions/lunar_flashlight.php).
- (18) National Aeronautics and Space Administration. "Green Propellant Infusion Mission Fires Thrusters for the First Time."



- [https://www.nasa.gov/directorates/spacotech/home/tdm/gpim\\_fires\\_thrusters\\_for\\_first\\_time](https://www.nasa.gov/directorates/spacotech/home/tdm/gpim_fires_thrusters_for_first_time)
- (19) McLean, C H, W D Deininger, B M Marotta, and et al. AIAA-2015-3751. "Green Propellant Infusion Mission Program Overview, Status, and Flight Operations." 51st AIAA/ASME/SAE/ASEE Joint Propulsion Conference.
  - (20) Masse, R K, M. Allen, E. Driscoll, L. Arrington, S. Schneider, and T. Vasek. AIAA-2016-4577. "AF-M315E Propulsion System Advances & Improvements." 52nd AIAA/SAE/ASEE Joint Propulsion Conference. Salt Lake City, UT., 25-27 July, 2016.
  - (21) NASA. 2017. "Cube Quest Challenge Team Spotlight: Cislunar Explorers." [https://www.nasa.gov/directorates/spacotech/centennial\\_challenges/cubequest/cislunar-explorers](https://www.nasa.gov/directorates/spacotech/centennial_challenges/cubequest/cislunar-explorers)
  - (22) "Pathfinder Technology Demonstrator, Demonstrating Novel CubeSat Technologies in Low-Earth Orbit", February 2,2021, [https://www.nasa.gov/directorates/spacotech/small-spacecraft/Pathfinder\\_Technology\\_Demonstrator/](https://www.nasa.gov/directorates/spacotech/small-spacecraft/Pathfinder_Technology_Demonstrator/)
  - (23) Messier, D. "NASA Selects Tethers Unlimited's HYDROS-C Thruster for First PTD CubeSat Mission." <http://www.parabolicarc.com/2018/06/30/nasa-selects-tuis-hydrosc-thruster-ptd-CubeSat-mission/>
  - (24) Satnews, "Rocket Fuel You Can Drink?" 26 January 2021.
  - (25) Rainbow, J., "Benchmark Space Systems unveils in-space mobility-as-a-service business," SpaceNews, 23, June, 2021.
  - (26) NanoAvionics. "CubeSat Propulsion System EPSS." <https://nanoavionics.com/CubeSat-components/CubeSat-propulsion-system-epss/>
  - (27) DawnAerospace. "CubeSat Propulsion Module." Revision B. Product Brochure. <https://static1.squarespace.com/static/5cb46b698d9740673f117259/t/5e3a2caed29b7f336bad9f52/1580870831508/CubeSat+Propulsion+Module+-+Dawn+Aerospace-compressed.pdf>
  - (28) "Busek BGT-X5 Green Monopropellant Thruster Technical Specification", [http://www.busek.com/index.htm\\_files/70008517E.pdf](http://www.busek.com/index.htm_files/70008517E.pdf)
  - (29) Rocket Lab. "The Rocket Lab Kick Stage." <https://www.rocketlabusa.com/electron/kickstage/>
  - (30) Rocket Lab. "Rocket Lab successfully circularizes orbit with new Electron kick Stage." <https://www.rocketlabusa.com/news/updates/rocket-lab-successfully-circularizes-orbit-with-new-electron-kick-stage/>
  - (31) Robert K. Masse, Ronald A. Spores, May Allen, "AF-M315E Advanced Green Propulsion – GPIM and Beyond," AIAA Propulsion & Energy Forum, Virtual Forum, August 24-26, 2020.
  - (32) Plasma Processes, "ASCENT (AF-M315E) Monopropellant Thrusters", 2020.
  - (33) Dawn Aerospace, "SmallSat Propulsion thruster – 20N", <https://www.dawnaerospace.com/products/p/smallsat-propulsion>
  - (34) Whitmore, S A, S L Merkley, Z S Spurrier, and S D Walker. 2015. "Development of a Power Efficient, Restartable, 'Green' Propellant Thruster for Small Spacecraft and Satellites." 29th Annual AIAA/USU Conference on Small Satellites.
  - (35) Bulcher, A. M. and S. A. Whitmore. "A Green Hybrid Thruster Using Moderately Enriched Compressed Air as the Oxidizer." AIAA-2018-4841. AIAA Propulsion and Energy Forum. Cincinnati, OH. July 9-11, 2018. doi: 10.2514/6.2018-4841
  - (36) Whitmore, S., Babb, R., Gardner, T., Lloyd, K., Stephens, J., "Pyrolytic Graphite and Boron Nitride as Low-Erosion Nozzle Materials for Long-Duration Hybrid Rocket Testing". AIAA-2020-3740, AIAA Propulsion and Energy Forum, 2020.



- (37) Whitmore, S., Babb, R., Stephens, J., Horlacher, J., "Further Development of Low-Erosion Nozzle Materials for Long-Duration Hybrid Rocket Burns". AIAA Propulsion and Energy Forum, 2021.
- (38) Jens, E., Karp, A., Williams, K., Nakazono, B., Rabinovitch, J., Dyrda, D., and Mechentel, F. "Low Pressure Ignition Testing of a Hybrid SmallSat Motor." AIAA-2019-4009, AIAA Propulsion and Energy Forum, 2019. <https://doi.org/10.2514/6.2019-4009>.
- (39) Simurda, L., Zilliac, G. and Zaseck, C., "High Performance Hybrid Propulsion System for Small Satellites," AIAA-2013-3635, 49th AIAA/ASME/SAE/ASEE Joint Propulsion Conference, 2013.
- (40) Simurda, L, Zilliac, G., "Continued Testing of a High Performance Hybrid Propulsion System for Small Satellites", AIAA-2015-4201, AIAA Propulsion and Energy Forum, 2015.
- (41) Desain, J., Brady, B., Curtiss, T., Hsu-Schouten, A., Fuller, J., Boyer, J.E., McKnight, B., Cortopassi, A., "Advanced Hybrid Rocket Motor Propulsion Unit for CubeSats(PUC)". Aerospace Report No. TOR-2015-03522.
- (42) ROMBUS Rapid Orbital Mobility Bus." Parabilis Space Technologies, datasheet
- (43) Schappell, D T, E Scarduffa, P Smith, and N Solway. AIAA-2005-4055. "Advances in Marotta Electric and Satellite Propulsion Fluid Control Activities." 41st AIAA/ASME/SAE/ASEE Joint Propulsion Conference.
- (44) Hinkley, D. "A Novel Cold Gas Propulsion System for Nanosatellites and Picosatellites." AIAA, 22nd Annual Conference on Small Satellites, SSC08-VII-7.
- (45) Gibbon, D. 2010. "A review of the use of butane as a low-cost propellant." Space Propulsion Conference.
- (46) Gibbon, D. and Underwood, C. "Low Cost Butane Propulsion System for Small Spacecraft," 15th AIAA / USU Conference on Small Satellites. SSC01-XI-1. <https://digitalcommons.usu.edu/cgi/viewcontent.cgi?article=2030&context=smallsat>
- (47) Pauliukonis, R S. 2017. "Fuel system comprising sulfur hexafluoride and lithium containing fuel." <https://patents.google.com/patent/US3325318>.
- (48) Bonin, G, N Roth, S Armitage, J Newman, B. Risi, and R. Zee. 2015. "CanX-4 and CanX-5 Precision Formation Flight: Mission Accomplished!" 29th Annual AIAA/USU Conference on Small Satellites.
- (49) Manzoni, G, and Y L Brama. 2015. "CubeSat Micropropulsion Characterization in Low Earth Orbit." 29th Annual AIAA/USU Conference on Small Satellites.
- (50) GOMSpace. "Attitude and Orbit Control Systems." <https://gomspace.com/shop/subsystems/attitude-orbit-control-systems/default.aspx>
- (51) "GomX-4," <https://directory.eoportal.org/web/eoportal/satellite-missions/g/gomx-4>.
- (52) National Aeronautics & Space Administration. "BioSentinel." Fact Sheet. [https://www.nasa.gov/sites/default/files/atoms/files/biosentinel\\_fact\\_sheet-16apr2019\\_508.pdf](https://www.nasa.gov/sites/default/files/atoms/files/biosentinel_fact_sheet-16apr2019_508.pdf)
- (53) Lightsey, E. G., T. Stevenson, and M. Sorgenfrei. "Development and Testing of a 3-D-Printed Cold Gas Thruster for an Interplanetary CubeSat." Proceedings of the IEEE, Vol. 106, No. 3, March, 2018. doi: 10.1109/JPROC.2018.2799898
- (54) Kvell, U, M Puusepp, F Kaminski, and et al. 2014. "Nanosatellite orbit control using MEMS cold gas thrusters." Proceedings of the Estonian Academy of Sciences, 63, 2S, 279–285.
- (55) Palmer, K., Sundqvist, J., Salaverri, A., Gronland, T., Li, Z., and Wu, S.. "In-Orbit Demonstration of a MEMS-based Micropropulsion System for CubeSats." Small Satellite Conference, August 2016.
- (56) Bowen, J, M Villa, and A Williams. 2015. "CubeSat based Rendezvous, Proximity Operations, and Docking in the CPOD Mission." 29th Annual AIAA/USU Conference on Small Satellites.





- (57) VACCO Industries. "CubeSat Propulsion Systems from VACCO." <https://www.CubeSat-propulsion.com/>
- (58) Klesh, A, and J Krajewski. 2015. "MarCO: CubeSats to Mars in 2016." 29th Annual AIAA/USU Conference on Small Satellites.
- (59) Jet Propulsion Laboratory, National Aeronautics and Space Administration. "Mars Cube One (MarCO)." <https://www.jpl.nasa.gov/CubeSat/missions/marco.php>.
- (60) VACCO Industries. "NEA Scout Propulsion System." Product Brochure. <https://www.CubeSat-propulsion.com/wp-content/uploads/2017/08/X16056000-data-sheet-080217.pdf>
- (61) Lockett, T., Castillo-Rogez, J., Johnson, L., Lightholder, J., and Few, A., "Near-Earth Asteroid Scout Flight Mission," IEEE A&E Systems Magazine, March 2020, DOI. No. 10.1109/MAES.2019.2958729
- (62) Editorial, "Iodine Impulse for SmallSats Demo'd On-Orbit by ThrustMe and Spacety," SmallSat News, 25 November 2019.
- (63) Werner, D., "Thrustme, Spacety report initial success of cold gas thruster," SpaceNews, 23 November, 2019.
- (64) Martinez, J., Rafalskyi, D., Aanesland, A., Laurand, X., Martinez, S., and Quinsac, G., "An off-axis iodine propulsion system for the Robusta-3A mission, 34<sup>th</sup> Small Satellite Conference, SSC20-IX-03, 2020.
- (65) ThrustMe, "I2T5 Cold Iodine Thruster," Company Datasheet, Version 02/21, 2021.
- (66) Zondervan, K L, J Fuller, D Rowen, and et al. 2014. "CubeSat Solid Rocket Motor Propulsion Systems Providing Delta-Vs Greater than 500 m/s." 28th Annual AIAA/USU Conference on Small Satellites.
- (67) Nicholas, A, T Finne, I Galysh, A Mai, and J Yen, W. Sawka, J. Ransdell, and S. Williams. 2013. "SpinSat Mission Overview." 27th Annual AIAA/USU Conference on Small Satellites.
- (68) Pacific Scientific Energetic Materials Company (PacSci EMC). Product information website. <https://psemc.com/products/satellite-propulsion-system/>
- (69) BusinessWire.com. 2017. "PacSci EMC Demonstrates First Ever Successful Orbital Maneuvers and Orbit Raising of a CubeSat Using a Commercial Solid Rocket Motor Array." <https://www.businesswire.com/news/home/20170925006504/en/PacSci-EMC-Demonstrates-Successful-Orbital-Maneuvers-Orbit>.
- (70) Hartwig, J.W. "Propellant Management Devices for Low Gravity Fluid Management: Past, Present, and Future Applications." AIAA Journal of Spacecraft and Rockets Vol. 54, No. 4, 808 – 824. 2017.
- (71) W. Tam, G. Kawahara, K. Wlodarczyk, "Review of ATK Diaphragm Tanks-An Update", Space Propulsion 2018, SP2018\_00024.
- (72) Carpenter, C, D Schmuland, J Overly, and R Masse. 2014. "Test Results for the MPS-120 and MPS-130 CubeSat Propulsion Systems." 28th Annual AIAA/USU Conference on Small Satellites. Logan.
- (73) Aerojet Rocketdyne. "Modular Propulsion Systems." Product Brochure. <https://www.rocket.com/sites/default/files/documents/CubeSat%20Mod%20Prop-2sided.pdf>
- (74) Stellar Exploration. "Nanosatellite Propulsion." Product Brochure.
- (75) Aerospace Corporation. "Propelling the Field of SmallSats Forward." <https://aerospace.org/article/propelling-field-small-sats-forward>
- (76) Gagne, K. R., M. R. McDevitt, and D. L. Hitt. "A Dual Mode Propulsion System for Small Satellite Applications." Aerospace. Vol. 5, No. 52. 2018. doi: 10.3390/aerospace5020052
- (77) Benchmark Space Systems. "B125 SmallSat Bipropellant Thruster." Product Brochure. <https://www.benchmarkspacesystems.com/b125>



- (78) Bradford ECAPS. "High Performance Green Propulsion." Product Brochure. [https://www.ecaps.space/assets/pdf/Bradford\\_ECAPS\\_Folder\\_2017.pdf](https://www.ecaps.space/assets/pdf/Bradford_ECAPS_Folder_2017.pdf)
- (79) Bradford ECAPS. "1N GP Thruster." <https://www.ecaps.space/products-1ngp.php>
- (80) CU Aerospace. "Space Propulsion Systems." <https://cuaerospace.com/products-services/space-propulsion-systems>
- (81) Tethers Unlimited. "Hydros." Product Brochure. <http://www.tethers.com/wp-content/uploads/2019/09/2019-HYDROS.pdf>
- (82) Moog, Inc. "Monopropellant Propulsion Module." Product Brochure. [https://www.moog.com/content/dam/moog/literature/Space\\_Defense/spaceliterature/propulsion/moog-monopropellant-propulsion-module-datasheet.pdf](https://www.moog.com/content/dam/moog/literature/Space_Defense/spaceliterature/propulsion/moog-monopropellant-propulsion-module-datasheet.pdf)
- (83) Tsay, M., C. Feng, and J. Zwahlen. "System-Level Demonstration of Busek's 1U CubeSat Green Propulsion Module 'AMAC'." AIAA-2017-4946. 53rd AIAA/SAE/ASEE Joint Propulsion Conference. Atlanta, GA. 10-12 July, 2017.
- (84) Anflo, K. and B. Crowe. "In-Space Demonstration of an ADN-based Propulsion System." AIAA-2011-5832. 47th AIAA/ASME/SAE/ASEE Joint Propulsion Conference & Exhibit. San Diego, CA. July 31 – August 3, 2011.
- (85) Busek Co., Inc. "BGT-X5 Green Monopropellant Thruster." Product Brochure. [http://busek.com/index.htm\\_files/70008517E.pdf](http://busek.com/index.htm_files/70008517E.pdf)
- (86) Busek Co., Inc. "Green Monopropellant Thrusters." [http://busek.com/technologies\\_greenmonoprop.htm](http://busek.com/technologies_greenmonoprop.htm)
- (87) CU Aerospace. "Performance Metrics for CUA Propulsion Systems." Product Brochure. <https://www.cuaerospace.com/Portals/2/SiteContent/pdfs/datasheets/CUA-Propulsion-Systems-v22.pdf>
- (88) NASA, 2015, "Pathfinder Technology Demonstrator." National Aeronautics & Space Administration. [https://www.nasa.gov/directorates/spacetech/small\\_spacecraft/ptd.html](https://www.nasa.gov/directorates/spacetech/small_spacecraft/ptd.html).
- (89) VACCO Industries. "Green Propulsion System." Product Brochure. <https://www.CubeSat-propulsion.com/wp-content/uploads/2019/08/X19041000-Green-Propulsion-System-datasheet-073019.pdf>
- (90) VACCO Industries. "Integrated Propulsion System." Product Brochure. <https://www.CubeSat-propulsion.com/wp-content/uploads/2019/08/Integrated-Propulsion-System-datasheet-080519.pdf>
- (91) VACCO Industries. "ArgoMoon Propulsion System." Product Brochure. <https://www.CubeSat-propulsion.com/wp-content/uploads/2017/08/X17025000-datasheet-080217.pdf>
- (92) Utah State University. "USU Technology Highlight: GOX and Nitrox Hybrid Green Rocket System." Product Brochure. <http://rgs.usu.edu/techtransfer/hybrid-green-rocket-system/>
- (93) Rabinovitch, J., Jens, E., Karp, A., Nakazono, N., Conte, A., Vaughan, D., "Characterization of PolyMethylMethAcrylate as a Fuel for Hybrid Rocket Motors". AIAA-2018-4530, AIAA Propulsion and Energy Forum, 2018.
- (94) Jens, E., Karp, A., Rabinovitch, J., Nakazono, B., Conte, A., Vaughan, D." Design of Interplanetary Hybrid CubeSat and SmallSat Propulsion Systems." AIAA-2018-4668, AIAA Propulsion and Energy Forum, 2018.
- (95) Dyrda, D., Mechentel, F., Cantwell, B., Karp, A., Rabinovitch, J., Jens, E., "Diode Laser Ignition Testing for PMMA/GOX Hybrid Motors." AIAA-2019-4095, AIAA Propulsion and Energy Forum, 2019.
- (96) Nano OTS Nanosatellite Orbital Transfer System", Parabilis Space Technologies, datasheet
- (97) Digital Solid State Propulsion, Inc. (DSSP) "CAPS-3." Product Brochure. <https://dsspotech.com/propellant-products>
- (98) DSSP. "MPM-7." Product Brochure. <https://dsspotech.com/propellant-products>
- (99) DSSP. "CDM-1." Product Brochure. <https://dsspotech.com/propellant-products>



- (100) Thrasher, J. and M. McPherson. "Design and Qualification of DSSP's CubeSat Delta-V Motor (CDM-1)." Digital Solid State Propulsion, Inc. Poster presented at Small Satellites Conference. Logan, UT. 2015.  
<https://digitalcommons.usu.edu/cgi/viewcontent.cgi?article=3261&context=smallsat>
- (101) Industrial Solid Propellant, Inc. "Product Portfolio." Product Brochure.  
<http://www.specificimpulse.com/>
- (102) Alliant Techsystems Inc. (ATK). "ATK Space Propulsion Products Catalog." Product Brochure. 2008. Available from:  
<https://forum.nasaspaceflight.com/index.php?action=dlattach;topic=31042.0;attach=494063;sess=0>
- (103) D-Orbit. "D-Raise." Product Brochure. <https://www.dorbit.space/d-raise>
- (104) D-Orbit. "D3." Product Brochure. <https://www.dorbit.space/d3>
- (105) VACCO Industries. "Standard Propulsion System." Product Brochure.  
<https://www.CubeSat-propulsion.com/wp-content/uploads/2019/08/Standard-MiPS-datasheet-080119.pdf>
- (106) VACCO Industries. "JPL MarCO – Micro CubeSat Propulsion System." Product Brochure.  
[https://www.CubeSat-propulsion.com/wp-content/uploads/2015/11/X14102000-01\\_2019update.pdf](https://www.CubeSat-propulsion.com/wp-content/uploads/2015/11/X14102000-01_2019update.pdf)
- (107) VACCO Industries. "Reaction Control Propulsion Module." Product Brochure.  
<https://www.CubeSat-propulsion.com/wp-content/uploads/2015/10/Reaction-control-propulsion-module.pdf>
- (108) GOMspace. "NanoProp CGP-3." Product Brochure.  
[https://gomspace.com/UserFiles/Subsystems/flyer/gomspace\\_nanoprop\\_cgp3.pdf](https://gomspace.com/UserFiles/Subsystems/flyer/gomspace_nanoprop_cgp3.pdf)
- (109) GOMspace. "NanoProp 6U." Product Brochure.  
[https://gomspace.com/UserFiles/Subsystems/flyer/gomspace\\_nanoprop\\_cgp6\\_flyer.pdf](https://gomspace.com/UserFiles/Subsystems/flyer/gomspace_nanoprop_cgp6_flyer.pdf)
- (110) Newman, J and Zee, R. E. "Drift Recovery and Station Keeping Results for the Historic CanX-4/CanX-5 Formation Flying Mission." 29<sup>th</sup> Annual AIAA/USU Conference on Small Satellites, Logan, UT, 2015.
- (111) Risi, B.W. "Propulsion System Development for the CanX-4 and CanX-5 Dual Nanosatellite Formation Flying Mission." Master of Applied Science Thesis, University of Toronto, 2014.
- (112) Jahn, R. G. and Choueiri, E. Y. "Electric Propulsion." Academic Press, Encyclopedia of Physical Science and Technology, Third Edition, Volume 5, 2002.
- (113) Goebel, D. M. and Katz, I. "Fundamentals of Electric Propulsion: Ion and Hall Thrusters." California Institute of Technology, Jet Propulsion Laboratory, JPL Space Science and Technology Series, 2008.
- (114) Bradford Space, "Comet: Water-based Propulsion for Small Satellites." Company Website, Datasheet, Copyright 2019.
- (115) Sarda, K., Roth, N., Zee, R. E., Cajacob, D., and Orr, N. G. "Making the Invisible Visible: Precision RF-Emitter Geolocation from Space by the HawkEye 360 Pathfinder Mission." 32<sup>nd</sup> AIAA/USU Conference on Small Satellites, Logan, UT, 2018.
- (116) eoPortal, "HawkEye 360 Pathfinder Cluster Mission to identify RFI locations." June, 2020. URL: <https://directory.eoportal.org/web/eoportal/satellite-missions/h/hawkeye>
- (117) BlackSky Global, "Global-4 Orbital Debris Assessment Report (ODAR)." FCC Licensing, 18 December, 2018.
- (118) CU Aerospace, "Propulsion Unit for CubeSats." Company Website, Datasheet, 2018.
- (119) Carroll, D. L., Cardin, J. M., Burton, R. L., Benavides, G. F., Hejmanowski, N., Woodruff, C., Bassett, K., King, D., Laystrom-Woodard, J., Richardson, L., Day, C., Hageman, K., and Bhandari, R. "Propulsion Unit for CubeSats (PUC)." 62<sup>nd</sup> JANNAF Propulsion Meeting, Nashville, TN, 1-5 June, 2015, Paper Tracking # 4059, 2015, Dist. A.



- (120) Burton, R.L., Benavides, G.F., and Carroll, D.L. "Space Thruster using Robust Microcavity Discharge." U.S. Patent No. 9,242,747 B1, 2016.
- (121) Woodruff, C., Carroll, D., King, D., Burton, R., and Hejmanowski, N. "Monofilament Vaporization Propulsion (MVP) – CubeSat propulsion system with inert polymer propellant." Small Satellite Conf., Paper # SSX18-III-09, Logan, UT, Aug. 6-9, 2018.
- (122) CU Aerospace, "Monofilament Vaporization Propulsion System Solid Inert Polymer Propellant." Company Website, Datasheet, 2020.
- (123) Woodruff, C., King, D., Burton, R., Bowman, J., and Carroll, D. "Development of a Fiber-Fed Pulsed Plasma Thruster for Small Satellites." Small Satellite Conference, Logan, UT, Paper # SSC19-WKVIII-06, 2019.
- (124) Woodruff, C., King, D., Burton, R., and Carroll, D. "Fiber-fed Pulsed Plasma Thruster for Small Satellites." 36th International Electric Propulsion Conference (IEPC) 2019, Vienna, Austria, Paper # IEPC 2019-A899, 2019.
- (125) Woodruff, C., King, D., Burton, R., and Carroll, D. "Fiber-Fed Advanced Pulsed Plasma Thruster (FPPT)." U.S. Patent # 10,570,892, Feb. 25, 2020.
- (126) CU Aerospace, "Fiber-Fed Pulsed Plasma Thruster System Solid Inert Polymer Propellant." Company Website, Datasheet, 2020.
- (127) "NASA Funds Long-Standing Partners in CubeSat Development." Press Release, University of Illinois at Urbana/Champaign, Aerospace Engineering, 9 Oct., 2019.
- (128) Aurora Propulsion Technologies, "Attitude and Orbit Control System (AOCS)." Company Website, URL: <https://aurorapt.fi>, Datasheet, Copyright May, 2020.
- (129) Werner, D. "Aurora to test deorbit tether on Momentus mission." SpaceNews, 5 February, 2020. URL: <https://spacenews.com/aurora-momentus-plasma-brake/>
- (130) Frost, J., "Momentus delays first Vigoride launch," SpaceNews, 7 January, 2021. URL: <https://spacenews.com/momentus-delays-first-vigoride-launch/>
- (131) Satnews, "AuroraSat-1 From Aurora Propulsion Technologies To Be Launched By Rocket Lab," 17 August 2021.
- (132) Ziemer, J., Marrese-Reading, Colleen, Cutler, C., Dunn, C., Romero-Wolf, A., Javidnia, S., Le, T., Li, I., Barela, P., Demmons, N., Hruby, V., Slutsky, J., Thorpe, J., Maghami, P., Hsu, O., and O'Donnell, J. "In-Flight Verification and Validation of Colloid Microthruster Performance." AIAA Propulsion and Energy Forum, Cincinnati, OH, AIAA-2018-4643.
- (133) Krejci, D., Reissner, A., Seifert, B., Jelem, D., Horbe, T., Plesescu, F., Friedhoff, P., and Lai, S. "Demonstration of the IFM Nano FEEP Thruster in Low Earth Orbit." 4S Symposium, 2018.
- (134) Krejci, D., Reissner, A., Schonherr, T., Seifert, B., Saleem, Z., and Alejos, R. "Recent Flight Data from IFM Nano Thrusters in a Low Earth Orbit." 36<sup>th</sup> IEPC, Vienna, Austria, IEPC-2019-A724.
- (135) Amos, J. "ICEYE's Small Radar Satellites Achieve Big Capability." BBC News, 6 May, 2020, URL: <https://www.bbc.com/news/science-environment-52560809>
- (136) Werner, D. "Key Hurdle Cleared for York Space Systems and U.S. Army Small Satellite Launch." SpaceNews, 22 February, 2018, URL: <https://spacenews.com/key-hurdle-cleared-for-york-space-systems-and-u-s-army-small-satellite-launch/>
- (137) Clark, S. "Rocket Lab Deploys Experimental U.S. Military SmallSats on First Night Launch." Spaceflight Now, 5 May, 2019. URL: <https://spaceflightnow.com/2019/05/05/rocket-labs-deploys-experimental-u-s-military-SmallSats-on-first-night-launch/>
- (138) Wörner, N. "Sensor Networks of Satellites." ElektronikNet, 26 May, 2020. URL: <https://www.elektroniknet.de/international/sensor-networks-of-satellites-176831.html>
- (139) "NetSat – Pioneering Research in Formation Control", website accessed June 2021, <https://www.telematik-zentrum.de/en/projects/netsat/>



- (140) "First Use of the Enpulsion Micro R3 Thruster in the GMS-T Mission", Space Daily, 18 March 2021.
- (141) Bangert, P., Kramer, A., and Schilling, K. "UWE-4: Integration State of the First Electrically Propelled 1U CubeSat." 31<sup>st</sup> Annual AIAA/USU Conference on Small Satellites, SSC17-WK-47, 2017.
- (142) Kramer, A., Bangert, P., and Schilling, K. "Hybrid Attitude Control On-Board UWE-4 Using Magnetorquers and the Electric Propulsion System NanoFEEP." 33<sup>rd</sup> Annual AIAA/USU Conference on Small Satellites, SSC19-WKI-02, 2019.
- (143) D. Werner, "Miniature Thruster Propels Single CubeSat to Lower Orbit", SpaceNews, 22 July 2020, <https://spacenews.com/uwe-4-lowers-altitude/>
- (144) "Accion Systems TILE 2 In-Space Propulsion System to Launch on the June 2021 SpaceX Rideshare with Astro Digital and Starfish Space", press release, 19 April 2021, <https://accion-systems.com/news/press/accion-systems-tile-2-in-space-propulsion-system-to-launch-on-the-june-2021-spacex-rideshare-with-astro-digital-and-starfish-space/>
- (145) NASA, "Upcoming ELaNa CubeSat Launches." NASA CubeSat Launch Initiative. URL: <https://www.nasa.gov/content/upcoming-elana-CubeSat-launches>
- (146) NASA, "NASA Announces Tenth Round of Candidates for CubeSat Space Missions." 14 March, 2019, Press Release. URL: <https://www.nasa.gov/feature/nasa-announces-tenth-round-of-candidates-for-CubeSat-space-missions>
- (147) "Accion Systems Raises \$11 Million in Series B Funding." 5 February, 2020, Satnews. URL: <https://www.satnews.com/story.php?menu=1&number=351788008>
- (148) Satnews, "Two NanoAvionics-Built SmallSats were Passengers on the SpaceX Transporter-2 Mission Launched to Successful Orbit," 6 July 2021.
- (149) "Accion Systems to demonstrate its propulsion system in NanoAvionics US rideshare mission", press release, 12 October 2020, <https://accion-systems.com/news/press/accion-systems-to-demonstrate-its-propulsion-system-in-nanoavionics-us-rideshare-mission/>
- (150) N. Arthur. "Ion Thruster Produced Roll Torque." AIAA-2019-4166.
- (151) N. Wallace et al., "The GOCE Ion Propulsion Assembly – Lessons Learnt from the First 22 Months of Flight Operations", IEPC-2011-327.
- (152) "ESA's GOCE Mission Comes to an End", ESA press release #33-2013, 21 Oct 2013, [https://www.esa.int/Newsroom/Press\\_Releases/ESA s GOCE mission comes to an end](https://www.esa.int/Newsroom/Press_Releases/ESA_s_GOCE_mission_comes_to_an_end)
- (153) A. Jones, "French Startup Demonstrates Iodine Propulsion in Potential Boost for Space Debris Mitigation Efforts", SpaceNews, 22 January 2021, <https://spacenews.com/french-startup-demonstrates-iodine-propulsion-in-potential-boost-for-space-debris-mitigation-efforts/>
- (154) "Trial Integration Completed By Norwegian Space Agency Of ThrustMe's Propulsion System For NorSat-TD", SatNews, 27 April 2021, <https://news.satnews.com/2021/04/27/trial-integration-completed-by-norwegian-space-agency-of-thrustmes-propulsion-system-for-norsat-td/>
- (155) "ESA and GomSpace Sign Contract for Continuation of the GOMX-5 Mission", GomSpace press release, 2 October 2020, <https://news.cision.com/gomspace-a-s/r/esa-and-gomspace-sign-contract-for-continuation-of-the-gomx-5-mission,c3202464>
- (156) Malphrus, B. "The Lunar IceCube EM-1 Mission: Prospecting the Moon for Water Ice." IEEE Aerospace and Electronic Systems Magazine, Vol 34, Issue 4, DOI: 10.1109/MAES.2019.2909384.
- (157) Clark, P. "Lunar Ice Cube Mission: Determining Lunar Water Dynamics with a First Generation Deep Space CubeSat." 47<sup>th</sup> Lunar and Planetary Science Conference, 2016.



- (158) Hardgrove, C. "The Lunar Polar Hydrogen Mapper CubeSat Mission." IEEE Aerospace and Electronic Systems Magazine, Vol 35, Issue 3, DOI: 10.1109/MAES.2019.2950747.
- (159) eoPortal, "SMART-1 (Small Mission for Advanced Research in Technology)." June, 2020. URL: <https://directory.eoportal.org/web/eoportal/satellite-missions/s/smart-1>
- (160) eoPortal, "TacSat-2 / Roadrunner." June 2020. URL: <https://earth.esa.int/web/eoportal/satellite-missions/content/-/article/tacsat2>
- (161) de Grys, K., Mathers, A., Welander, B., and Khayms, V. "Demonstration of 10,400 Hours of Operation on a 4.5 kW Qualification Model Hall Thruster." 46<sup>th</sup> AIAA Joint Propulsion Conference, Nashville, TN, July, 2010.
- (162) Sheetz, M. and Petrova, M. "Why in the next decade companies will launch thousands more satellites than in all of history." CNBC, 15 December, 2019. URL: <https://www.cnbc.com/2019/12/14/spacex-oneweb-and-amazon-to-launch-thousands-more-satellites-in-2020s.html>
- (163) Gorbunov, A., Khodnenko, V., Khromov, A., Murashko, V., Koryakin, A., Zhosan, V., and Grikin, G. "Vernier Propulsion System for Small Earth Remote Sensing Satellite "Canopus-V." 32<sup>nd</sup> IEPC, Wiesbaden, Germany, 2011.
- (164) eoPortal, "Kanopus-V 1 (Kanopus-Vulkan N1, Environmental Satellite)." June, 2020. URL: <https://directory.eoportal.org/web/eoportal/satellite-missions/k/kanopus-v-1>
- (165) eoPortal, "Kanopus-V-IK 1 (Kanopus-Vulkan-Infra-Krasny-1)." June, 2020. URL: <https://directory.eoportal.org/web/eoportal/satellite-missions/k/kanopus-v-ik-1>
- (166) EDB Fakel, "Stationary Plasma Thrusters." Company Website, Datasheet, 2020.
- (167) Gnizdor, R., Markov, A., Mitrofanova, O., and Semenenko, D. "The research of the modified SPT-70 thruster parameters and characteristics." 36<sup>th</sup> IEPC, Vienna, Austria, 2019.
- (168) Hruby, P., Demmons, N., Courtney, D., Tsay, M., Szabo, J., and Hruby, V. "Overview of Busek Electric Propulsion." 36<sup>th</sup> IEPC, Vienna, Austria, 2019.
- (169) Kamhawi, H., Haag, T., Benavides, G., Hickman, T., Smith, T., Williams, G., Myers, J., Polzin, K., Dankanich, J., Byrne, L., Szabo, J., and Lee, L. "Overview of Iodine Propellant Hall Thruster Development Activities at NASA Glenn Research Center." 52<sup>nd</sup> AIAA Joint Propulsion Conference, Salt Lake City, Utah, 2016.
- (170) NASA TechPort, "Iodine Satellite (iSAT)." June, 2020. URL: <https://techport.nasa.gov/view/91492>
- (171) Lev, D., Zimmerman, R., Shoor, B., Appel, L., Ben-Ephraim, M., Herscovitz, J., and Epstein, O. "Electric Propulsion Activities at Rafael in 2019." 36<sup>th</sup> IEPC, Vienna, Austria, 2019.
- (172) Herscovitz, J., and Karnieli, A. "VENUS Program: Broad and New Horizons for Super-Spectral Imaging and Electric Propulsion Missions for a Small Satellite." 22<sup>nd</sup> AIAA/USU Conference on Small Satellites, Logan, Utah, 2008.
- (173) Herscovitz, J., Appel, L., Barnett, D., Baron, D., Davidson, A., Gontmacher, P., Kedem, M., Lev, D., Merenstein, A., Rbinovich, L., Reiner, D., Salama, O., Amit-Shapira, Y., Shechter, Y., Shoor, B., Warshavsky, A., and Zhuravel, N. "VENUS – A Novel Technological Mission Using Electric Propulsion." 35<sup>th</sup> IEPC, Atlanta, Georgia, 2017.
- (174) Herscovitz, J., Lev, D., Shoor, B., Katz-Franco, D., Berkman, S., Baron, D., and Adler, S. "VENUS – Updates on Technological Mission using the Israeli Hall Effect Thruster (IHET)." 36<sup>th</sup> IEPC, Vienna, Austria, 2019.
- (175) eoPortal "VENUS (Vegetation and Environment monitoring on a New Microsatellite)." June, 2020. URL: <https://directory.eoportal.org/web/eoportal/satellite-missions/v-w-x-y-z/venus>
- (176) SITael "Electric Propulsion – HT100 Hall Effect Thruster Product Sheet." Company Website, Datasheet, 2020.



- (177) Misuri, T., Ducci, C., Gregucci, S., Pedrini, D., Cannelli, F., Cesari, U., Nania, F., Vicini, A., Pace, G., Magistro, F., Cenni, J., Dignani, D., Farauanu, C., Quaranta, V., Tiseo, B., Orefice, M., and Bruno, G. "SITAEL HT100 Thruster Unit, Full Ground Qualification." 36<sup>th</sup> IEPC, Vienna, Austria, 2019.
- (178) Tambini, A., Antonini, F., Melega, N., Mariotti, G., Centonze, V., and Gabriele, A. "uHETSat small Power System for high demanding payloads." European Space Power Conference, 2019.
- (179) Apollo Fusion, "Apollo Constellation Engine (ACE)." Company Website, <https://apollofusion.com/ace.html>, Copyright 2019.
- (180) Astro Digital US, Inc. "Astro Digital Ignis Orbital Debris Assessment Report (ODAR) v1.0." FCC Public Database, 2019.
- (181) Apollo Fusion Press Release, "Apollo Fusion, Inc. To Propel Spaceflight Inc.'s Orbital Sherpa-LTE," 12 November 2020.
- (182) Foust, J., "SpaceX launches second dedicated rideshare mission," SpaceNews, 30, June 2021.
- (183) Exotrail, "Hall effect thruster for small satellites." Company Website, Online Datasheet, May, 2020.
- (184) Exotrail Press Release, "Exotrail delivers its first Hall Effect Propulsion system prototype for In-Orbit Demonstration mission." 02 October, 2019.
- (185) Exotrail Press Release, "Exotrail secures contract with AAC Clyde Space to equip their spacecrafts for Eutelsat's ELO 3 and 4." 18 February, 2020.
- (186) Gurciullo, A., Jarrige, J., Lascombes, P., and Packan, D. "Experimental performance and plume characterization of a miniaturized 50W Hall thruster." 36<sup>th</sup> IEPC, Vienna, Austria, 2019.
- (187) ExoTrail Press Release, "Exotrail paves the way for new space mobility with first of its kind successful in-orbit demonstration mission," 01 January 2021.
- (188) ExoTerra Resource, "Halo Hall-Effect Thruster." Company Website, Datasheet, May, 2020.
- (189) VanWoerkom, M., Gorokhovskiy, V., Pulido, G., Pettigrew, R., and Seidcheck, A. "Test Results of ExoTerra's Halo Micro Electric Propulsion System." 36<sup>th</sup> IEPC, Vienna, Austria, 2019.
- (190) NASA Press Release, "NASA Announces New Tipping Point Partnerships for Moon and Mars Technologies." 27 September, 2019.
- (191) Vinoski, J. "Orbion's Plasma Rocket Thrusters Will Power AST's New Space-Based Cell Tower." Forbes, 23 July, 2020.
- (192) Henry, C. "Megaconstellation startup raises \$110 million to connect smartphones via satellite." SpaceNews, 5 March, 2020.
- (193) Jewett, R., "AST SpaceMobile to Launch Demo Satellite With SpaceX," Via Satellite, 30 July 2021.
- (194) Erwin, S., "Blue Canyon selects Orbion electric thrusters for DARPA's Blackjack satellites," SpaceNews, 15 September 2020.
- (195) Busek Co Press Release, "Busek Ships First LEO to GEO Capable Electric Propulsion System – Design Demonstrated One Million Newton-Seconds in NASA-Led Test," PR Newswire, 23 February 2021.
- (196) Szabo, J., Byrne, L., Strain, M., Paintal, S., Sawyer, S., Yu, T., Kolencik, G., and Hruby, V., "One Million Newton-Second Duration Test of a 600 Watt Hall Effect Thruster Fueled By Xenon," 2020 AIAA Propulsion and Energy Forum, Virtual Event, August 24-28, 2020.
- (197) Burton, R. "Pulsed Plasma Thrusters." In Encyclopedia of Aerospace Engineering (eds R. Blockley and W. Shyy). doi:[10.1002/9780470686652.eae120](https://doi.org/10.1002/9780470686652.eae120).
- (198) Kolbeck, J., Anders, A., Beilis, I., and Keidar, M. "Micro-propulsion based on vacuum arcs." Journal of Applied Physics, June, 2019, <https://doi.org/10.1063/1.5081096>.



- (199) J. Foust, "Phase Four Launches First Plasma Propulsion Systems", SpaceNews, 25 January 2021, <https://spacenews.com/phase-four-launches-first-plasma-propulsion-systems/>
- (200) Debra Werner "Capella Space and Phase Four reveal Maxwell Engine performance" SpaceNews 30 June 2021.
- (201) REGULUS, 6 May 2020, URL: <https://www.t4innovation.com/wp-content/uploads/2020/05/T4i-REGULUS-Magazine.pdf>
- (202) Bellomo, N. "Enhancement of Microsatellites' Mission Capabilities: Integration of REGULUS Electric Propulsion Module into UniSat-7." 70<sup>th</sup> International Astronautical Congress, Washington, D.C., October, 2019.
- (203) "Cube Quest Challenge NASA Facts." NASA, FS-2019-12-073-MSFC. URL: [https://www.nasa.gov/sites/default/files/atoms/files/cubequest\\_fs\\_june2020\\_508.pdf](https://www.nasa.gov/sites/default/files/atoms/files/cubequest_fs_june2020_508.pdf)
- (204) "Three DIY CubeSats Score Rides on NASA's First Flight of Orion, Space Launch System." NASA Press Release 17-055, 8 June, 2017. URL: <https://www.nasa.gov/press-release/three-diy-CubeSats-score-rides-on-nasa-s-first-flight-of-orion-space-launch-system>
- (205) Alhorn, D., Casas, J., Agasid, E., Adams, C., Laue, G., Kitts, C., and O'Brien, S. "NanoSail-D: The Small Satellite That Could!" SmallSat Conference, 2011.
- (206) Mansell, J., Spencer, D., Plante, B., Diaz, A., Fernandez, M., Bellardo, J., Betts, B., and Nye, B. "Orbit and Attitude Performance of the LightSail 2 Solar Sail Spacecraft." AIAA 2020-2177.
- (207) "CubeSail." Laboratory for Advanced Space Systems at Illinois (LASSI), Accessed 5 July, 2020. URL: <https://aerospace.illinois.edu/research/research-facilities/laboratory-advanced-space-systems-illinois-lassi>
- (208) CU Aerospace Press Release, "CubeSail Mission Update," 8 April, 2021. URL: <https://cuaerospace.com/news/details/cubesail-mission-update>
- (209) Johnson, L, et al. "Near Earth Asteroid Scout: Exploring Asteroid 1991VG Using a SmallSat." *Proceedings of the 70<sup>th</sup> International Astronautical Congress*, IAC-19/B4/2.
- (210) "AE's Prox-1 Satellite Launches from Kennedy Space Center." Georgia Institute of Technology, 25 June, 2019. URL: <https://ae.gatech.edu/news/2019/06/aes-prox-1-satellite-launches-kennedy-space-center>
- (211) C. Henry. "Tethers Unlimited Says Early Results of Deorbit Hardware Test Promising." SpaceNews, 23 January, 2020. URL: <https://spacenews.com/tethers-unlimited-says-early-results-of-deorbit-hardware-test-promising/>
- (212) Clark, S. "SmallSat Companies Teaming Up on Deorbit Experiment." Spaceflight Now, 15 August, 2019. URL: <https://spaceflightnow.com/2019/08/15/SmallSat-companies-teaming-up-on-deorbit-experiment/>
- (213) Satnews, "SmallSat Space Debris Remediation Technology Being Demo'd By Millennium Space Systems," 7 December 2020.
- (214) Busek Company, "Busek Micro Resistojet." Company Website, Datasheet, Copyright 2013.
- (215) Hejmanowski, N. J., Woodruff, C. A., Burton, R. L., Carroll D. L., Palla, A. D., and Cardin J. M. "CubeSat High Impulse Propulsion System (CHIPS) Design and Performance." JANNAF, Phoenix, AZ, 2016, Dist. A.
- (216) Hejmanowski, N. J., Woodruff, C. A., Burton, R. L., and Carroll D. L. "Electrothermal Space Thruster Heater for Decomposable Propellants." U.S. Patent # 9,909,574 B1, 2018.
- (217) Hejmanowski, N. J., Woodruff, C., Burton, R.L., Carroll, D.L., and Cardin, J. "CubeSat High Impulse Propulsion System (CHIPS)." 62nd JANNAF Propulsion Meeting, Nashville, TN, 1-5 June, 2015, Dist. A.





- (218) CU Aerospace, "CubeSat High Impulse Propulsion System." Company Website, Datasheet, 2019.
- (219) Cifali, G., Gregucci, S., Andreussi, T., and Andrenucci, M. "Resistojet Thrusters for Auxiliary Propulsion of Full Electric Platforms." 35<sup>th</sup> International Electric Propulsion Conference, Atlanta, GA, IEPC-2017-371, 2017.
- (220) Sitael, "XR Resistojet Product Family." Datasheet, Company Website, Copyright 2015.
- (221) Courtney, D., Wright, P., Lafko, D., Metivier, E., and Demmons, N. "Electrospray Propulsion for Precise Attitude and Position Control." AAS 17-088, Breckenridge, CO., 2017.
- (222) D. Courtney et al. "Electrospray Thrusters for Small Spacecraft Control: Pulsed and Steady State Operation." AIAA-2018-4654.
- (223) Courtney, D., Wood, Z., and Fedkiw, T. "Reconstructing Electrospray Plume Current Spatial Distributions Using Computed Tomography." 36<sup>th</sup> IEPC, Vienna, Austria, IEPC-2019-A-787.
- (224) D. Courtney et al. "High-Speed Transient Characterization of the Busek BET-300-P Electrospray Thruster." 36<sup>th</sup> IEPC, Vienna, Austria, IEPC-2019-A-788.
- (225) T. Fedkiw, Z. Wood, and N. Demmons, "Environmental and Lifetime Testing of the BET-300-P Electrospray Thruster", AIAA 2020-3614.
- (226) Enpulsion, "IFM Nano Thruster." Company Website, Datasheet ENP2018-001.F.1, Accessed 2020.
- (227) Schönherr, T., Little, B., Krejci, D., Reissner, A., and Seifert, B. "Development, Production, and Testing of the IFM Nano FEEP Thruster." 36<sup>th</sup> IEPC, Vienna, Austria, IEPC-2019-362, 2019.
- (228) Krejci, D., Hugonnaud, V., Schonherr, T., Little, B., Reissner, A., Seifert, B., Kock, Q, Borrás, E., and Amo, J. "Full Performance Mapping of the IFM Nano Thruster, Including Direct Thrust Measurements." *Journal of Small Satellites*, 2019, Vol. 8, No. 2, pp. 881-893.
- (229) Enpulsion, "Enpulsion Micro R<sup>3</sup>." Company Website, Datasheet ENP2018-002.H.1, Accessed 2021.
- (230) Grimaud, L., Krejci, D., and Seifert, B. "The IFM Micro FEEP Thruster: A Modular Design for SmallSat Propulsion." 36<sup>th</sup> IEPC, Vienna, Austria, IEPC-2019-A675, 2019.
- (231) Morpheus Space, "nanoFEEP and multiFEEP." Company Website, Datasheet, June, 2020. URL: <https://www.morpheus-space.com/static/MSWeb/documents/M-Space%20Products.pdf>.
- (232) Bock, D., Spethmann, A., Trottenberg, T., Kersten, H., and Tajmar, M. "In-Plume Thrust Measurement of NanoFEEP Thruster with a Force Measuring Probe Using Laser Interferometry." 36<sup>th</sup> IEPC, Vienna, Austria, IEPC-2017-391, 2017.
- (233) Accion Systems, "TILE-2-4C." Company Website, Datasheet, Copyright 2019.
- (234) Accion Systems, "TILE-3-36C-1U." Company Website, Datasheet, Copyright 2019.
- (235) Avant Space, "GT-50 RF Ion Thruster." Company Datasheet. URL: <http://www.avantspace.com/upload/iblock/dc9/Data-sheet.pdf>
- (236) Kralkin, E., et al. "Exploratory Testing of a Radio-Frequency Thruster for Small Satellites." IEPC-2017-425.
- (237) Busek, "BIT-3 RF Ion Thruster." Company Website, Datasheet, Copyright 2019.
- (238) "All-Electric CubeSat Propulsion Technologies for Versatile Mission Application." 32nd International Symposium on Space Technology and Science (ISTS), Fukui, Japan, June, 2019, ISTS-2019-b-002.
- (239) Tsay, M., Frongillo, J., Model, J., Zwahlen, J., Barcroft, C., Feng, C. "Neutralization Demo and Thrust Stand Measurement for BIT-3 RF Ion Thruster." 2017 AIAA Propulsion and Energy Forum, Atlanta, GA, July, 2017, AIAA-2017-4890.
- (240) ThrustMe, "NPT30-Xe." Company Website, Datasheet, Copyright 2019.



- (241) ThrustMe, "NPT30-I2 1.5U," Company Website, Datasheet, Copyright 2020.
- (242) Martinez, J., Rafalskyi, D., and Aanesland, A. "Development and Testing of the NPT30-I2 Iodine Ion Thruster." 36<sup>th</sup> IEPC, Vienna, Austria, IEPC-2019-811, 2019.
- (243) ThrustMe, "NPT30-I2 1U," Company Website, Datasheet, Copyright 2021.
- (244) Leiter, H., Lauer, D., Bauer, P., Berger, M., and Rath, M. "The Ariane Group Electric Propulsion Program 2019-2020." 36<sup>th</sup> IEPC, Vienna, Austria, IEPC-2019-592, 2019.
- (245) Leiter, H., Altmann, C., Lauer, D., Rath, M., Becker, F., Feili, D., and Amo, J. "A Nouvelle Neutralization Concept for RIT- $\mu$ X Miniaturized Radio Frequency Ion Thruster Systems." 36<sup>th</sup> IEPC, Vienna, Austria, IEPC-2019-806, 2019.
- (246) Ariane Group, "Electric Propulsion Systems and Components." Company Website, Datasheet, Accessed 2020.
- (247) Leiter, H., Lotz, B., Feili, D., Tartz, M., Neumann, H., and Cara, D. "Design Development and Test of the RIT- $\mu$ X Mini Ion Engine System." IEPC-2009-179.
- (248) Leiter, H., Altmann, C., Porst, J., Lauer, D., Berger, M., and Rath, M. "Six Decades of thrust – The Ariane Group Radiofrequency Ion Thrusters and Systems Family." IEPC-2017-027.
- (249) C.H. Edwards et al., "The T5 Ion Propulsion Assembly for Drag Compensation on GOCE", 2nd International GOCE User Workshop, ESA-ESRIN Frascati Italy, 8-10 March 2004.
- (250) P.N. Randall et al., "T5 Performance, Industrialization and Future Applications", IEPC-2019-688.
- (251) Apollo Fusion, "Apollo Constellation Engine (ACE) Krypton/Xenon Propulsion System." Company Website, Datasheet, Copyright 2020.
- (252) Szabo, J., Tedrake, R., Metivier, E., Paintal, S., and Taillefer, Z. "Characterization of a One Hundred Watt, Long Lifetime Hall Effect Thruster for Small Spacecraft." 53<sup>rd</sup> AIAA Joint Propulsion Conference, Atlanta, Georgia, 2017.
- (253) Busek, "BHT-200 Busek Hall Effect Thruster." Company Website, Datasheet, 2019.
- (254) Hruby, V., Monheiser, J., Pote, B., Freeman, C., and Connolly, W. "Low Power, Hall Thruster Propulsion System." IEPC-99-092, Kitakyushu, Japan, 1999.
- (255) Busek, "BHT-600 Busek Hall Effect Thruster." Company Website, Datasheet, 2016.
- (256) Szabo, J., Pote, B., Tedrake, R., Paintal, S., Byrne, L., Hruby, V., Kamhawi, H., and Smith, T. "High Throughput 600 Watt Hall Effect Thruster for Space Exploration." 52<sup>nd</sup> AIAA Joint Propulsion Conference, Salt Lake City, Utah, 2016.
- (257) Benavides, G., Kamhawi, H., Mackey, J., Haag, T., and Costa, G., "Iodine Hall-Effect Electric Propulsion System Research, Development, and System Durability Demonstration," 2018 Joint Propulsion Conference, Cincinnati, Ohio, July 9-11, 2018.
- (258) Saevets, P., Semenenko, D., Albertoni, R., and Scremin, G. "Development of a Long-Life Low-Power Hall Thruster." 35<sup>th</sup> IEPC, Atlanta, Georgia, 2017.
- (259) Conversano, R., Goebel, D., Katz, I., and Hofer, R. "Low-Power Hall Thruster with an Internally Mounted Low-Current Hollow Cathode." U.S. Patent No. 10,723,489, 2020.
- (260) Conversano, R., Reilly, S., Kerber, T., Brooks, J., and Goebel, D. "Development of and Acceptance Test Preparations for the Thruster Component of the Ascendant Sub-kW Transcelestial Electric Propulsion System (ASTRAEUS)." 36<sup>th</sup> IEPC, Vienna, Austria, 2019.
- (261) Conversano, R., Lobbia, R., Kerber, T., Tilley, K., Goebel, D., and Reilly, S. "Performance characterization of a low-power magnetically shielded Hall thruster with an internally-mounted hollow cathode." Plasma Sources Science and Technology, Vol. 28, No. 10, 2019.
- (262) Conversano, R., Barchowsky, A., Lobbia, R., Chaplin, V., Lopez-Ortega, A., Loveland, J., Lui, A., Becatti, G., Reilly, S., Goebel, D., Snyder, J., Hofer, R., Randolph, T., Mikellides, I., Vorperian, V., Carr, G., Rapinchuk, J., Villalpando, C., and Grebow, D. "Overview of



- the Ascendant Sub-kW Transcelestial Electric Propulsion System (ASTRAEUS).” 36<sup>th</sup> IEPC, Vienna, Austria, 2019.
- (263) Lobbia, R., Conversano, R., Ortega, A., Reilly, S., Mikellides, I. “Pole Erosion Measurements for the Development Model of the Magnetically Shielded Miniature Hall Thruster (MaSMi-DM).” 36<sup>th</sup> IEPC, Vienna, Austria, 2019.
- (264) Ortega, A., Mikellides, I., Conversano, R., Lobbia, R., Chaplin, V. “Plasma Simulations for the Assessment of Pole Erosion in the Magnetically Shielded Miniature Hall Thruster (MaSMi).” 36<sup>th</sup> IEPC, Vienna, Austria, 2019.
- (265) JPL Press Release, “2020 Technology Highlights, Jet Propulsion Laboratory,” CL#20-6401.
- (266) Conversano, R., Barchowsky, A., Vorperian, V., Chaplin, V., Becatti, G., Carr, G., Stell, C., Loveland, J., and Goebel, D., “Cathode & Electromagnet Qualification Status and Power Processing Unit Development Update for the Ascendant Sub-kW Transcelestial Electric Propulsion System,” 34<sup>th</sup> Small Satellite Conference, 2020, SSC20-VI-10.
- (267) Conversano, R., Lobbia, R., Lopez-Ortega, A., Chaplin, V., Reilly, S., Arestie, S., Goebel, D., “Long-Duration Wear Testing of the ASTRAEUS Hall Thruster, Phase 1: 50 kg Xe Total Throughput,” Space Propulsion 2020+1, 17-19 March 2021, SP2020-005.
- (268) Sommerville, J., Frunceck, C., King, L., Makela, J., Terhune, K., Washeleski, R., and Myers, R. “Performance of the Aurora Low-Power Hall-Effect Thruster.” 36<sup>th</sup> IEPC, Vienna, Austria, 2019.
- (269) Vaudolon, J., Vial, V., Cornu, N., and Habbassi, I. “PPS-X00 Thruster Development Status at Safran.” 36<sup>th</sup> IEPC, Vienna, Austria, 2019.
- (270) SITAEL “Electric Propulsion – HT400 Hall Effect Thruster Product Sheet.” Company Website, Datasheet, 2020.
- (271) Ducci, C., Raiji, H., Pedrini, D., Misuri, T., and Onida, L. “SITAEL’s HT400 Hall Effect Thruster for Constellation Applications.” 36<sup>th</sup> IEPC, Vienna, Austria, 2019.
- (272) Pedrini, D., Ducci, C., Misuri, T., Paganucci, F., Andrenucci, M. “Sitael Hollow Cathodes for Low-Power Hall Effect Thrusters.” IEEE Transactions on Plasma Science, Vol. 46, No. 2, February, 2018.
- (273) Space Electric Thruster Systems “ST25 Hall-Effect Thruster.” Company Website, Datasheet, 2020.
- (274) Petrenko, O., Tolok, S., Maslov, V., Kulagin, S., Serbin, V., Alekseenko, O., and Shcherbak, D. “Electric propulsion system SPS-25 with Hall Thruster.” 70<sup>th</sup> International Astronautical Congress (IAC), Washington D.C., October, 2019.
- (275) Space Electric Thruster Systems “ST40 Hall-Effect Thruster.” Company Website, Datasheet, 2020.
- (276) Krishnan, M., Velas, K., and Leemans, S. “Metal Plasma Thruster for Small Satellites.” Journal of Propulsion and Power, March, 2020, DOI: 10.2514/1.B37603.
- (277) Busek “BmP-220 Technical Specifications.” Company Website, Datasheet, Copyright 2019.
- (278) Jarrige, J., Packan, D., Blanchet, A., and Herrero, L. “Direct Thrust Measurement of a Vacuum Arc Thruster.” 36<sup>th</sup> IEPC, Vienna, Austria, 2019.
- (279) Blanchet, A., Herrero, L., Voisin, L., Pilloy, B., and Courteville, D. “Plasma Jet Pack Technology for Nano-Microsatellites.” 36<sup>th</sup> IEPC, Vienna, Austria, 2019.
- (280) Ciaralli et al. “Results of the Qualification Test Campaign of a Pulsed Plasma Thruster for CubeSat Propulsion (PPTCUP).” Acta Astronautica, Volume 121, Pages 314-322, April–May, 2016.
- (281) Siddiqui, M., Cretel, C., Synowiec, J., Hsu, A., Young, J., and Spektor, R. “First Performance Measurements of the Phase Four RF Thruster.” 35<sup>th</sup> IEPC, Atlanta, GA, October, 2017.



- (282) Siddiqui, M. and Cretel, C. "Updated Performance Measurements and Analysis of the Phase Four RF Thruster." Joint Propulsion Conference, Cincinnati, OH, AIAA-2018-4817.
- (283) Cretel, C., Ajamia, M., Thompson, D., and Siddiqui, M. "Torsional Balance Thrust Measurement Techniques for Small RF Thrusters."
- (284) "Meet Maxwell." Phase Four, website, accessed 2020, URL: <https://www.phasefour.io/maxwell/>
- (285) "REGULUS Electrical Propulsion System for Micro-satellites." T4i, datasheet. URL: [https://www.t4innovation.com/wp-content/uploads/2019/10/T4i\\_REGULUS\\_datasheet .pdf](https://www.t4innovation.com/wp-content/uploads/2019/10/T4i_REGULUS_datasheet.pdf)
- (286) "M1.4 Thruster Interface and User Manual", version 1.4, <https://miles-space.com/thruster/>
- (287) "Plasma Brake Module (PBM)." Aurora, datasheet, 2020. URL: <https://aurorapt.fi/wp-content/uploads/2020/05/Aurora-PBM.pdf>
- (288) "Terminator Tape." Tethers Unlimited, datasheet, 2020. URL: <https://www.tethers.com/wp-content/uploads/2020/03/2020-Terminator-Tape.pdf>



## Chapter Contents

Glossary .....	ii
5.0 Guidance, Navigation & Control .....	121
5.1 Introduction .....	121
5.2 State-of-the-Art – GNC Subsystems .....	122
5.2.1 Integrated Units .....	122
5.2.2 Reaction Wheels .....	125
5.2.3 Magnetic Torquers.....	127
5.2.4 Thrusters .....	128
5.2.5 Star Trackers .....	128
5.2.6 Magnetometers.....	131
5.2.7 Sun Sensors .....	132
5.2.8 Horizon Sensors .....	136
5.2.9 Inertial Sensing.....	137
5.2.10 GPS Receivers .....	149
5.2.11 Deep Space Navigation.....	150
5.2.12 Atomic Clocks.....	150
5.3 On the Horizon .....	151
5.4 Summary.....	152
References.....	152



## Chapter Glossary

(ADCS)	Attitude Determination and Control System
(CoCom)	Coordinating Committee for Multilateral Export Controls
(COTS)	Commercial-off-the-Shelf
(DOF)	Degrees of Freedom
(DSAC)	Deep Space Atomic Clock
(DSN)	Deep Space Network
(EAR)	Export Administration Regulations
(FOGs)	Fiber Optic Gyros
(GNC)	Guidance, Navigation & Control
(GSO)	Geo-stationary Orbit
(USAF)	U.S. Air Force
(HCI)	Horizon Crossing Indicators
(IMUs)	Inertial Measurement Units
(JPL)	Jet Propulsion Laboratory
(LMRST)	Low Mass Radio Science Transponder
(MarCO)	Mars Cube One
(PMSM)	Permanent-magnet Synchronous Motor
(SDST)	Small Deep Space Transponder
(SWaP)	Size, weight, and power
(TLE)	Two-Line Element
(TRL)	Technology Readiness Level



## 5.0 Guidance, Navigation & Control

### 5.1 Introduction

The Guidance, Navigation & Control (GNC) subsystem includes both the components used for position determination and the components used by the Attitude Determination and Control System (ADCS). In Earth orbit, onboard position determination can be provided by a Global Positioning System (GPS) receiver. Alternatively, ground-based radar tracking systems can also be used. If onboard knowledge is required, then these radar observations can be uploaded and paired with a suitable propagator. Commonly, the U.S. Air Force (USAF) publishes Two-Line Element sets (TLE) (1), which are paired with a SGP4 propagator (2). In deep space, position determination is performed using the Deep Space Network (DSN) and an onboard radio transponder (3). There are also optical technologies being developed that use celestial bodies such as planets and pulsars to provide position data (26).

Using SmallSats in cislunar space and beyond requires a slightly different approach than the GNC subsystem approach in low-Earth orbit. Use of the Earth's magnetic field, for example, is not possible in these missions, and alternate ADCS designs and methods must be carefully considered. Two communication relay CubeSats (Mars Cube One, MarCO) successfully demonstrated such interplanetary capability during the 2018 Insight mission to Mars (4). This interplanetary mission demonstrated both the capability of this class of spacecraft and the GNC fine pointing design for communication in deep space.

ADCS includes sensors to determine attitude and attitude rate, such as star trackers, sun sensors, horizon sensors, magnetometers, and gyros. In addition, the ADCS is often used to control the vehicle during trajectory correction maneuvers and, using accelerometers, to terminate maneuvers when the desired velocity change has been achieved. Actuators are designed to change a spacecraft's attitude and to impart velocity change during trajectory correction maneuvers. Common spacecraft actuators include magnetic torquers, reaction wheels, and thrusters. There are many attitude determination and control architectures and algorithms suitable for use in small spacecraft (5).

Miniaturization of existing technologies is a continuing trend in small spacecraft GNC. While three-axis stabilized, GPS-equipped, 100 kg class spacecraft have been flown for decades, it has only been in the past few years that such technologies have become available for micro- and nano-class spacecraft. Table 5-1 summarizes the current state-of-the-art of performance for GNC subsystems in small spacecraft. Performance greatly depends on the size of the spacecraft and values will range for nano- to micro-class spacecraft.

The information described below is not intended to be exhaustive but provides an overview of current state-of-the-art technologies and their development status for a particular small spacecraft subsystem. It should be noted that Technology Readiness Level (TRL) designations may vary with changes specific to payload, mission requirements, reliability considerations, and/or the environment in which performance was demonstrated. Readers are highly encouraged to reach out to companies for further information regarding the performance and TRL of described technology. There is no intention of mentioning certain companies and omitting others based on their technologies or relationship with NASA.



Table 5-1: State-of-the-Art GNC Subsystems		
Component	Performance	TRL
Reaction Wheels	0.00023 – 0.3 Nm peak torque, 0.0005 – 8 N m s storage	7-9
Magnetic Torquers	0.15 A m <sup>2</sup> – 15 A m <sup>2</sup>	7-9
Star Trackers	8 arcsec pointing knowledge	7-9
Sun Sensors	0.1° accuracy	7-9
Earth Sensors	0.25° accuracy	7-9
Inertial Sensors	Gyros: 0.15° h <sup>-1</sup> bias stability, 0.02° h <sup>-1/2</sup> ARW Accels: 3 μg bias stability, 0.02 (m s <sup>-1</sup> )/h <sup>-1/2</sup> VRW	7-9
GPS Receivers	1.5 m position accuracy	7-9
Integrated Units	5 – 0.002° pointing capability	7-9
Atomic Clocks	10 – 150 Frequency Range (MHz)	5-6
Deep Space Navigation	Bands: X, Ka, S, and UHF	7-9

## 5.2 State-of-the-Art – GNC Subsystems

### 5.2.1 Integrated Units

Integrated units combine multiple different attitude and navigation components to provide a simple, single-component solution to a spacecraft's GNC requirements. Typical components included are reaction wheels, magnetometers, magnetic torquers, and star trackers. The systems often include processors and software with attitude determination and control capabilities. Table 5-2 describes some of the integrated systems currently available. Blue Canyon Technologies' XACT (figure 5.1) flew on the NASA-led missions MarCO and ASTERIA, both of which were 6U platforms, and have also flown on 3U missions (MinXSS was deployed from NanoRacks in February 2016).



Figure 5.1: BCT XACT Integrated ADCS Unit. Credit: Blue Canyon Technologies.





Table 5-2. Currently Available Integrated Systems

Manufacturer	Model	Mass (kg)	Actuators	Sensors	Processor	Pointing Accuracy	T R L
Arcsec	Arcus ADC	0.715	3 reaction wheels 3 magnetic torquers	1 star tracker 3 gyros 6 photodiodes 3 magnetometers	Yes	0.1°	7-9
Berlin Space Technologies / Hyperion Technologies	iADCS-200	0.400	3 reaction wheels 3 magnetic torquers	1 star tracker 3 gyros, 1 magnetometer, 1 accelerometer	Yes	1°	7-9
Berlin Space Technologies / Hyperion Technologies	iADCS-400	1.7	3 reaction wheels 3 magnetic torquers	1 star tracker, optional IMU	Yes	<1°	7-9
Blue Canyon Technologies	XACT-15	0.885	3 reaction wheels 3 magnetorquers	1 star tracker 3-axis magnetometer	Yes	0.007°	7-9
Blue Canyon Technologies	XACT-50	1.230	3 reaction wheels 3 magnetorquers	1 star tracker 3-axis magnetometer	Yes	0.007°	7-9
Blue Canyon Technologies	XACT-100	1.813	3 reaction wheels 3 magnetorquers	1 star tracker 3-axis magnetometer	Yes	0.007°	7-9
Blue Canyon Technologies	Flexcore	configuration dependent	3 – 4 reaction wheels 3 magnetorquers	1 star tracker 3-axis magnetometer	Yes	0.007°	7-9
CubeSpace	CubeADCS 3-Axis Small	0.55	3 reaction wheels 3 magnetorquers	10 coarse sun sensors 2 fine sun/earth sensors 1 magnetometer	Yes	<1°	7-9



CubeSpace	CubeADCS 3-Axis Small with Star Tracker	0.61	3 reaction wheels 3 magnetorquers	10 coarse sun sensors 2 fine sun/earth sensors 1 magnetometer 1 star tracker	Yes	<0.5°	7-9
CubeSpace	CubeADCS 3-Axis Medium	0.79	3 reaction wheels 3 magnetorquers	10 coarse sun sensors 2 fine sun/earth sensors 1 magnetometer	Yes	<1°	7-9
CubeSpace	CubeADCS 3-Axis Medium with Star Tracker	0.84	3 reaction wheels 3 magnetorquers	10 coarse sun sensors 2 fine sun/earth sensors 1 magnetometer 1 star tracker	Yes	<0.5°	7-9
CubeSpace	CubeADCS 3-Axis Large	1.1	3 reaction wheels 3 magnetorquers	10 coarse sun sensors 2 fine sun/earth sensors 1 magnetometer	Yes	<1°	7-9
CubeSpace	CubeADCS 3-Axis Large with Star Tracker	1.15	3 reaction wheels 3 magnetorquers	10 coarse sun sensors 2 fine sun/earth sensors 1 magnetometer 1 star tracker	Yes	<0.5°	7-9
CubeSpace	CubeADCS Y- Momentum	0.3	3 reaction wheels 3 magnetic torquers	10 coarse sun sensors 1 magnetometer	Yes	<5°	7-9



## 5.2.2 Reaction Wheels

Miniaturized reaction wheels provide small spacecraft with a three-axis precision pointing capability and must be carefully selected based on several factors including the mass of the spacecraft and the required rotation performance rates. Reaction wheels provide torque and momentum storage along the wheel spin axis and require the spacecraft to counter-rotate around the spacecraft center of mass due to conservation of angular momentum from the wheel spin direction. Table 5-3 lists a selection of high-heritage miniature reaction wheels. Except for three units, all the reaction wheels listed have spaceflight heritage. For full three-axis control, a spacecraft requires three wheels. However, a four-wheel configuration is often used to provide fault tolerance (6). Due to parasitic external torques, reaction wheels need to be periodically desaturated using an actuator that provides an external torque, such as thrusters or magnetic torquers (7).

In addition, the multiple reaction wheels are often assembled in a “skewed” or angled configuration such that there exists a cross-coupling of torques with two or more reaction wheels. While this reduces the torque performance in any single axis, it allows a redundant, albeit reduced, torque capability in more than one axis. The result is that should any single reaction wheel fail, one or more reaction wheels are available as a reduced-capability backup option.

<b>Manufacturer</b>	<b>Model</b>	<b>Mass (kg)</b>	<b>Peak Power (W)</b>	<b>Peak Torque (Nm)</b>	<b>Momentum Capacity (Nms)</b>	<b># Wheels</b>	<b>Radiation Tolerance (krad)</b>	<b>T R L</b>
Berlin Space Technologies	RWA05	1.700	0.5	0.020	0.0005	1	30	7-9
Blue Canyon Technologies	RWP015	0.130	1	0.004	0.015	1	Unk	7-9
Blue Canyon Technologies	RWp050	0.240	1	0.007	0.050	1	Unk	7-9
Blue Canyon Technologies	RWp100	0.330	1	0.007	0.100	1	Unk	7-9
Blue Canyon Technologies	RWp500	0.750	6	0.025	0.500	1	Unk	7-9
Blue Canyon Technologies	RW1	0.950	9	0.100	1.000	1	Unk	7-9
Blue Canyon Technologies	RW4	3.200	10	0.250	4.000	1	Unk	7-9
Blue Canyon Technologies	RW8	4.400	10	0.250	8.000	1	Unk	7-9
CubeSpace	CubeWheel Small	0.060	0.65	0.00023	0.00177	1	24	7-9
CubeSpace	CubeWheel Small+	0.090	2.3	0.0023	0.0036	1	24	7-9
CubeSpace	CubeWheel	0.150	2.3	0.001	0.0108	1	24	7-9



	Medium							
CubeSpace	CubeWheel Large	0.225	4.5	0.0023	0.0306	1	24	7-9
GomSpace	NanoTorque GSW-600	0.940	0.3	0.0015	0.019	1	Unk	Unk
Hyperion Technologies	RW210	0.48	0.8	0.0001	0.006	1	36	7-9
Hyperion Technologies	RW400	0.375	1.9	0.012	0.050	1	36	7-9
NanoAvionics	RWO	0.137	3.25	0.003	0.020	1	20	7-9
NanoAvionics	4RWO	0.665	6	0.006	0.037	4	20	7-9
NewSpace Systems	NRWA-T005	1.2	0.4	0.01	0.050	1	10	7-9
NewSpace Systems	NRWA-T065	1.55	0.8	0.02	0.65	1	10	7-9
NewSpace Systems	NRWA-T2	2.2	1.08	0.09	2	1	10	7-9
Sinclair Interplanetary	RW-0.03	0.185	1.8	0.002	0.040	1	20	7-9
Sinclair Interplanetary	RW-0.003	0.050	Unk	0.001	0.005	1	10	5-6
Sinclair Interplanetary	RW-0.01	0.120	1.05	0.001	0.018	1	20	7-9
Sinclair Interplanetary	RW3-0.06	0.226	23.4	0.020	0.180	1	20	7-9
Sinclair Interplanetary	RW4-0.2	0.6	Unk	0.1	0.2	1	60	7-9
Sinclair Interplanetary	RW4-0.4	0.77	Unk	0.1	0.4	1	60	7-9
Sinclair Interplanetary	RW4-1.0	1.38	45	0.1	1	1	60	7-9
Vectronic Aerospace	VRW-A-1	1.900	110	0.090	6.000	1	20	Unk
Vectronic Aerospace	VRW-B-2	1.000	45	0.020	0.200	1	20	Unk
Vectronic Aerospace	VRW-C-1	2.3	45	0.020	1.20	1	20	Unk
Vectronic Aerospace	VRW-D-2	2	65	0.05	2.0	1	20	Unk



Vectronic Aerospace	VRW-D-6	3	110	0.09	6	1	20	Unk
---------------------	---------	---	-----	------	---	---	----	-----

### 5.2.3 Magnetic Torquers

Magnetic torquers provide control torques perpendicular to the local external magnetic field. Table 5-4 lists a selection of high heritage magnetic torquers and figure 5.3 illustrates some of ZARM Technik's product offerings. Magnetic torquers are often used to remove excess momentum from reaction wheels. As control torques can only be provided in the plane perpendicular to the local magnetic field, magnetic torquers alone cannot provide three-axis stabilization.



Figure 5.3: Magnatorquers for micro satellites. Credit: ZARM Technik.

Use of magnetic torquers beyond low-Earth orbit and in interplanetary applications need to be carefully investigated since their successful operation is dependent on a significant local external magnetic field. This magnetic field may or may not be available in the location and environment for that mission and additional control methods will be required during transit.

Manufacturer	Model	Mass (kg)	Power (W)	Peak Dipole (A m <sup>2</sup> )	# Axes	Radiation Tolerance (krad)	T R L
CubeSpace	CubeTorquer Small	0.028	0.42	0.24	1	24	7-9
CubeSpace	CubeTorquer Medium	0.036	0.37	0.66	1	24	7-9
CubeSpace	CubeTorquer Large	0.072	0.37	1.90	1	24	7-9
CubeSpace	CubeTorquer Coil(Single)	0.046	0.31	0.13	1	24	7-9
CubeSpace	CubeTorquer Coil(Double)	0.074	0.64	0.27	1	24	7-9
GomSpace	Nano Torque GST-600	0.156	Unk	0.31 – 0.34	3	Unk	Unk
GomSpace	NanoTorque Z-axis Internal	0.106	Unk	0.139	1	Unk	Unk
ISISPACE	Magnatorquer Board	0.196	1.2	0.20	3	Unk	7-9
MEISEI	Magnetic Torque Actuator for Spacecraft	0.5	1	12	1	Unk	7-9
Hyperion Technologies	MTQ800	0.395	3	15	1	Unk	7-9
NanoAvionics	MTQ3X	0.205	0.4	0.30	3	20	7-9



NewSpace Systems	NCTR-M003	0.030	0.25	0.29	1	Unk	7-9
NewSpace Systems	NCTR-M012	0.053	0.8	1.19	1	Unk	7-9
NewSpace Systems	NCTR-M016	0.053	1.2	1.6	1	Unk	7-9
Sinclair Interplanetary	TQ-40	0.825	Unk	48.00	1	Unk	7-9
Sinclair Interplanetary	TQ-15	0.400	Unk	19.00	1	Unk	7-9
ZARM	MT0.2-1	0.005	0.25	0.2	1	Unk	7-9
ZARM	MT1-1	0.060	0.23	1	1	Unk	7-9
ZARM	MT2-1	0.2	0.5	2	1	Unk	7-9
ZARM	MT4-1	0.15	0.6	4	1	Unk	7-9
ZARM	MT5-1	0.19	0.73	5	1	Unk	7-9
ZARM	MT5-2	0.3	0.77	5	1	Unk	7-9
ZARM	MT6-2	0.3	0.48	6	1	Unk	7-9
ZARM	MT7-2	0.4	0.9	7	1	Unk	7-9
ZARM	MT10-1-01	0.35	0.53	10	1	Unk	7-9
ZARM	MT10-2-H	0.37	1	10	1	Unk	7-9
ZARM	MT15-1	0.45	1.1	15	1	Unk	7-9

#### 5.2.4 Thrusters

Thrusters used for attitude control are described in Chapter 4: In-Space Propulsion. Pointing accuracy is determined by minimum impulse bit, and control authority by thruster force.

#### 5.2.5 Star Trackers

A star tracker can provide an accurate, standalone estimate of three-axis attitude by comparing a digital image captured with a focal plane array detector to an onboard star catalog (8). Star trackers typically identify and track multiple stars and provide three-axis attitude (and often attitude rate) several times a second, usually provided as a quaternion. Table 5-5 lists some models suitable for use on small spacecraft. For example, Arcsec's Sagitta Star Tracker was launched on the SIMBA cubesat in 2020.



Table 5-5. Star Trackers Suitable for Small Spacecraft

Manufacturer	Model	Mass (kg)	Power (W)	FOV	Cross axis accuracy (3s)	Twist accuracy (3s)	Radiation Tolerance (krad)	TRL
Redwire Space	Star Tracker	0.475	2	14x19	10/27"	51"	75	7-9
Arcsec	Sagitta	0.26	1.2	25.4°	6	30	20	7-9
Arcsec	Twinkle	0.04	0.6	10.4°	30	180	Unk	7-9
Ball Aerospace	CT-2020	3.000	8	Unk	1.5"	1"	Unk	5-6
Berlin Space Technologies / Hyperion Technologies	ST200	0.040	0.65	22°	30"	200"	11	7-9
Berlin Space Technologies / Hyperion Technologies	ST400	0.250	0.67	15°	15"	150"	11	7-9
Blue Canyon Technologies	Standard NST	0.350	1.5	10° x 12°	6"	40"	Unk	7-9
Blue Canyon Technologies	Extended NST	1.300	1.5	10° x 12°	6"	40"	Unk	7-9
Creare	UST	0.840	Unk	Unk	7"	15"	Unk	5-6
CubeSpace	CubeStar	0.055	0.264	42° diameter	55.44"	77.4	19	7-9
Danish Technical University	MicroASC	0.425	1.9	Unk	Unk	Unk	Unk	7-9
Leonardo	Spacestar	1.600	6	20° x 20°	7.7"	10.6"	Unk	7-9
NanoAvionics	ST-1	0.108	1.2	21° full-cone	8"	50"	20	7-9



Sinclair Interplanetary	ST-16RT2	0.185	1	8° half-cone	5"	55"	Unk	7-9
Sodern	Auriga-CP	0.210	1.1	Unk	2"	11"	Unk	7-9
Sodern	Hydra-M	2.75	8	Unk	Unk	Unk	Unk	5-6
Sodern	Hydra-TC	5.3	8	Unk	Unk	Unk	Unk	5-6
Solar MEMS Technologies	STNS	0.14	1.4	13° x 18°	40"	70"	20	7-9
Space Micro	MIST	0.520	4	14.5°	15"	105"	30	7-9
Space Micro	μSTAR-100M	1.800	5	Unk	15"	105"	100	Unk
Space Micro	μSTAR-200M	2.100	10	Unk	15"	105"	100	Unk
Space Micro	μSTAR-200H	2.700	10	Unk	3"	21"	100	Unk
Space Micro	μSTAR-400M	3.300	18	Unk	15"	105"	100	Unk
Terma	T1	0.923	0.75	20° circular	2.2"	9"	100	5-6
Terma	T3	0.35	.5	20° circular	2.6"	10"	8	5-6
Vectronic Aerospace	VST-41MN	0.900	2.5	14° x 14°	27"	183"	20	7-9
Vectronic Aerospace	VST-68M	0.470	3	14° x 14°	7.5"	45"	20	Unk





## 5.2.6 Magnetometers

Magnetometers provide a measurement of the local magnetic field and this measurement can be used to provide both estimates of attitude (9). The vast majority of CubeSats use commercial-off-the-shelf (COTS) magnetometers and improve their performance with software. Table 5-6 provides a summary of some three-axis magnetometers available for small spacecraft, one of which is illustrated in figure 5.4.



Figure 5.4: NSS Magnetometer. Credit: NewSpace Systems.

Table 5-6. Three-axis Magnetometers for Small Spacecraft							
Manufacturer	Model	Mass (kg)	Power (W)	Resolution (nT)	Orthogonality	Radiation Tolerance (krad)	T R L
GomSpace	NanoSense M315	0.008	Unk	Unk	Unk	Unk	7-9
Hyperion Technologies	MM200	0.012	0.01	Unk	Unk	30	7-9
MEISEI	3-Axis Magnetometer for Small Satellite	0.220	1.5	Unk	1°	Unk	7-9
NewSpace Systems	NMRM-Bn25o485	0.085	0.75	8	1°	10	7-9
SpaceQuest	MAG-3	0.100	Voltage Dependent	Unk	1°	10	7-9
ZARM	Analogue High-Rel Fluxgate Magnetometer FGM-A-75	0.33	0.75	Unk	1°	50	7-9
ZARM	Digital AMR Magnetometer AMR-RS422	0.06	0.3	Unk	1°	Unk	7-9
ZARM	Digital AMR Magnetometer AMR-D-100-EFRS485	0.1	0.2	Unk	1°	30	5-6

### 5.2.7 Sun Sensors

Sun sensors are used to estimate the direction of the Sun in the spacecraft body frame. Sun direction estimates can be used for attitude estimation, though to obtain a three-axis attitude estimate at least one additional independent source of attitude information is required (e.g., the Earth nadir vector or the direction to a star). Because the Sun is easily identifiable and extremely bright, Sun sensors are often used for fault detection and recovery. However, care must be taken to ensure the Moon or Earth's albedo is not inadvertently misidentified as the sun.

There are several types of Sun sensors which operate on different principles, but the most common types for small spacecraft are cosine detectors and quadrant detectors. Quadrant detectors appear to be gaining popularity in the CubeSat world due to their compact size and low cost.

Cosine detectors are photocells. Their output is the current generated by the cell, which is (roughly) proportional to the cosine of the angle between the sensor boresight and the Sun. For that reason, at least two cosine detectors (pointing in different directions) are needed to estimate the direction to the Sun and typically four are used to obtain an unambiguous solution and for additional sky coverage. Cosine detectors (e.g., figure 5.5) are inexpensive, low-mass, simple and reliable devices, but their accuracy is typically limited to a few degrees and they do require analog-to-digital converters.

Quadrant detectors. Quadrant sun sensors typically operate by shining sun light through a square window onto a 2 x 2 array of photodiodes. The current generated by each photodiode is a function of the direction of the sun relative to the sensor boresight. The measured currents from all four cells are then combined mathematically to produce the angles to the sun.

Examples of small spacecraft sun sensors are described in table 5-7.

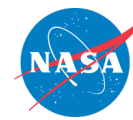


*Figure 5.5: Redwire Coarse Sun Sensor Detector (Cosine Type). Credit: Redwire Space*

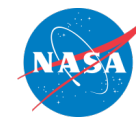


Table 5-7. Small Spacecraft Sun Sensors

Manufacturer	Model	Sensor Type	Mass (kg)	Peak Power (W)	Analog or Digital	FOV	Accuracy (3s)	# Measurement Angles	Radiation Tolerance (krad)	TRL
Redwire Space	Coarse Analog Sun Sensor	Coarse Analog Sun Sensor	0.045	0	Analog	±40° (Can be modified to meet specific FOV requirements)	±1°	1	>100	7-9
Redwire Space	Coarse Sun Sensor (Cosine Type)	Coarse Sun Sensor (Cosine Type)	0.010	0	Analog	APPROXIMATE COSINE, CONICAL SYMMETRY	±2° to ±5°	Depends on configuration	>100	7-9
Redwire Space	Coarse Sun Sensor Pyramid	Coarse Sun Sensor Pyramid	0.13	0	Analog	2π STERADIAN PLUS	±1° to ±3°	2	>100	7-9
Redwire Space	DIGITAL SUN SENSOR (±32°)	DIGITAL SUN SENSOR (±32°)	Sensor 0.3 kg Electronics ~1	1	Digital	±32° x ±32° (each sensor)	±0.1°	2	100	7-9
Redwire Space	Digital Sun Sensor (±64°)	Digital Sun Sensor (±64°)	Sensor 0.25 Electronics 0.29 - 1.1	0.5	Digital	128° X 128° (EACH SENSOR) NOTE: 4π STERADIANS ACHIEVED WITH 5 SENSORS	±0.25°	2	100	7-9



Redwire Space	Fine Pointing Sun Sensor	Fine Pointing Sun Sensor	Sensor .95 Electronics 1.08	< 3	Digital	$\pm 4.25^\circ \times \pm 4.25^\circ$ (Typical)	Better than $\pm 0.01^\circ$	2	100	7-9
Redwire Space	Fine Spinning Sun Sensor ( $\pm 64^\circ$ )	Fine Spinning Sun Sensor ( $\pm 64^\circ$ )	Sensor 0.109 Electronics 0.475 – 0.725	0.5	Analog and Digital	$\pm 64^\circ$ FAN SHAPED (each sensor)	$\pm 0.1^\circ$	1 plus Sun Pulse	100	7-9
Redwire Space	Micro Sun Sensor	Micro Sun Sensor	< 0.002	< 0.02	Analog	$\pm 85^\circ$ MINIMUM	$\pm 5^\circ$	2	Approx. 10	5-6
Redwire Space	Miniature Spinning Sun Sensor ( $\pm 87.5^\circ$ )	Miniature Spinning Sun Sensor ( $\pm 87.5^\circ$ )	< 0.25	0.5	Digital	$\pm 87.5^\circ$ (FROM NORMAL TO SPIN AXIS)	$\pm 0.1^\circ$	1 plus Sun Pulse	100	7-9
Redwire Space	FINE SUN SENSOR ( $\pm 50^\circ$ )	FINE SUN SENSOR ( $\pm 50^\circ$ )	Unk	Unk	Digital	Typically $\pm 50^\circ \times \pm 50^\circ$	$\pm 0.01^\circ$ TO $\pm 0.05^\circ$	2	100, 150, or 300	7-9
Bradford Engineering	CoSS	Cosine	0.024	0	Analog	160° full cone	3°	1	40000	7-9
Bradford Engineering	CoSS-R	Cosine	0.015	0	Analog	180° full cone	3°	1	120000	7-9
Bradford Engineering	CSS-01, CSS-02	Cosine	0.215	0	Analog	180° full cone	1.5°	2	70000	7-9
Bradford Engineering	FSS	Quadrant	0.375	0.25	Analog	128° x 128°	0.3°	2	100	7-9
Bradford Engineering	Mini-FSS	Quadrant	0.050	0	Analog	128° x 128°	0.2°	2	20000	7-9
CubeSpace	CubeSense	Camera	0.030	0.2	Digital	170° full cone	0.2°	2	24	7-9
GomSpace	NanoSense FSS	Quadrant	0.002	Unk	Digital	{45°, 60°}	{ $\pm 0.5^\circ$ , $\pm 2^\circ$ }	2	Unk	Unk



Hyperion Technologies	SS200	Unk	.003	.04	Digital	110°	0.3°	Unk	36	7-9
Lens R&D	BiSon64-ET	Quadrant	0.023	0	Analog	±58° per axis	0.5°	2	9200	7-9
Lens R&D	BiSon64-ET-B	Quadrant	0.033	0	Analog	±58° per axis	0.5°	2	9200	7-9
Lens R&D	MAUS	Quadrant	0.014	0	Analog	±57° per axis	0.5°	2	9200	7-9
NewSpace Systems	NFSS-411	Unk	0.035	0.150	Digital	140°	0.1°	TBD	20	7-9
NewSpace Systems	NCSS-SA05	Unk	0.005	0.05	Analog	114°	0.5°	TBD	Unk	7-9
Solar MEMS Technologies	nanoSSOC-A60	Quadrant	0.004	0.007	Analog	±60° per axis	0.5°	2	100	7-9
Solar MEMS Technologies	nanoSSOC-D60	Quadrant	0.007	0.076	Digital	±60° per axis	0.5°	2	30	7-9
Solar MEMS Technologies	SSOC-A60	Quadrant	0.025	0.01	Analog	±60° per axis	0.3°	2	100	7-9
Solar MEMS Technologies	SSOC-D60	Quadrant	0.035	0.315	Digital	±60° per axis	0.3°	2	30	7-9
Solar MEMS Technologies	ACSS	Quadrant & Redundant	0.035	0.072	Analog	±60° per axis	0.5°	2	200	7-9
Space Micro	CSS-01, CSS-02	Cosine	0.010	0	Analog	120° full cone	5°	1	100	7-9
Space Micro	MSS-01	Quadrant	0.036	0	Analog	48° full cone	1°	2	100	7-9

### 5.2.8 Horizon Sensors

Horizon sensors can be simple infrared horizon crossing indicators (HCI), or more advanced thermopile sensors that can be used to detect temperature differences between the poles and equator. For terrestrial applications, these sensors are referred to as Earth Sensors, but can be used for other planets. Examples of such technologies are described in table 5-8 and illustrated in figure 5.6.



Figure 5.6: MAI-SES. Credit: Redwire Space

In addition to the commercially-available sensors listed in table 5-8, there has been some recent academic interest in horizon sensors for CubeSats with promising results (27) (10) (11).

Table 5-8. Commercially Available Horizon Sensors									
Manufacturer	Model	Sensor Type	Mass (kg)	Peak Power (W)	Analog or Digital	Accuracy	# Measurement Angles	Rad Tolerance (krad)	TRL
CubeSpace	CubeSense	Camera	0.030	0.200	Digital	0.2°	2	24	7-9
CubeSpace	CubeIR	Infrared	0.050	0.230	Digital	1.5°	2	24	7-9
Servo	Mini Digital HCI	Pyroelectric	0.050	Voltage Dependent	Digital	0.75°	Unk	Unk	7-9
Servo	Mini HCI	Pyroelectric	0.0115	Voltage Dependent	Unk	Unk	Unk	Unk	Unk
Servo	RH 310 HCI	Pyroelectric	1.5	1	Unk	0.015°	Unk	20	Unk
Solar MEMS Technologies	HSNS	Infrared	0.120	0.150	Digital	1°	2	30	7-9



### 5.2.9 Inertial Sensing

Inertial sensing is a broad category which includes gyroscopes for measuring angular change and accelerometers for measuring velocity change.

Inertial sensors are packaged in different ways, ranging from single-axis devices (e.g., a single gyroscope or accelerometer), to packages which include multiple axes of a single device type (e.g., Inertial Reference Units are typically three gyroscopes mounted in a triad orientation to provide three-axes angular change), to Inertial Measurement Units (IMUs), which are packages which include multiple axes of both gyroscopes and accelerometers (to enable 6-DOF inertial propagation). Some vendors also offer packages that incorporate magnetometers and barometers.

Inertial sensors are frequently used to propagate the vehicle state between measurement updates of a non-inertial sensor. For example, star trackers typically provide attitude updates at 5 Hz or possibly 10 Hz. If the control system requires accurate knowledge between star tracker updates, then an IMU may be used for attitude propagation between star tracker updates.

The main gyroscope types used in modern small spacecraft are fiber optic gyros (FOGs) and MEMS gyros, with FOGs usually offering superior performance at a mass and cost penalty (12). Other gyroscope types exist (e.g., resonator gyros, ring laser gyros), but these are not common in the SmallSat/CubeSat world due to size, weight, and power (SWaP) and cost considerations.

Gyro behavior is a complex topic (13) and gyro performance is typically characterized by a multitude of parameters. Table 5-9 only includes bias stability and angle random walk for gyros, and bias stability and velocity random walk for accelerometers, as these are often the driving performance parameters. That said, when selecting inertial sensors, it is important to consider other factors such as dynamic range, output resolution, bias, sample rate, etc.



Table 5-9. Gyros Available for Small Spacecraft

Manufacturer	Model	Sensor Type	Technology	Mass (kg)	Power (W)	Gyros				Accelerometers			
						# Axes	Bias Stability		ARW (°/rt(hr))	# Axes	Bias Stability		VRW (m/sec/rt(hr))
							(°/hr)	stat			(µg)	stat	
Advanced Navigation	Orientus	IMU + magnetometers	MEMS	0.025	0.325	3	3.000	TBD	0.240	3	20	TBD	0.059
Advanced Tech International	AU7684	IMU	MEMS	TBD	TBD	3	10.000	TBD	0.500	3	2000	TBD	TBD
Epson	M-G370	IMU	MEMS	0.010	0.016	3	0.800	av	0.060	3	12	av	0.025
Epson	M-G365	IMU	MEMS	0.010	0.016	3	1.200	av	0.080	3	16	av	0.033
Epson	M-G364	IMU	MEMS	0.010	TBD	3	2.200	av	0.090	3	50	av	0.025
Epson	M-G354	IMU	MEMS	0.010	TBD	3	3.000	av	0.100	3	70	av	0.030
Emcore	SDI50x-AF00	IMU	MEMS	0.60	5.0	3	1	1σ	0.02	3	100	1σ	0.059
Emcore	SDI50x-BF00	IMU	MEMS	0.60	5.0	3	3	1σ	0.02	3	200	1σ	0.059
Emcore	SDI50x-CF00	IMU	MEMS	0.60	5.0	3	10	1σ	0.02	3	200	1σ	0.071
Emcore	SDG500	Gyro	MEMS	0.025	0.6	1	20	Typical	N/A	N/A	N/A	N/A	N/A

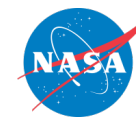




Emcor e	SDG1400	Gyro	MEMS	0.60	0.6	1	6	Typical	N/A	N/A	N/A	N/A	N/A
Emcor e	SDD3000-A01	Gyro	MEMS	0.227	2.25	1	0.5	1 $\sigma$	N/A	N/A	N/A	N/A	N/A
Emcor e	QRS11	Gyro	MEMS	$\leq 0.06$	0.8	1	6	Typical	N/A	N/A	N/A	N/A	N/A
Emcor e	QRS14-102	Gyro	MEMS	$\leq 0.05$	0.3	1	N/A	N/A	N/A	N/A	N/A	N/A	N/A
Emcor e	QRS14-103	Gyro	MEMS	$\leq 0.05$	0.7	1	N/A	N/A	N/A	N/A	N/A	N/A	N/A
Emcor e	QRS28	Gyro	MEMS	$\leq 0.025$	0.5	2	N/A	N/A	N/A	N/A	N/A	N/A	N/A
Emcor e	QRS116	Gyro	MEMS	$\leq 0.06$	0.2	1	20	1 $\sigma$	N/A	N/A	N/A	N/A	N/A
Emcor e	EN-300-1	IMU	FOG	0.82	18.0	3	0.1	1 $\sigma$	0.008	3	150	1 $\sigma$	0.026
Emcor e	EN-300-3	IMU	FOG	0.82	18.0	3	0.2	1 $\sigma$	0.015	3	300	1 $\sigma$	0.026
Emcor e	EN-300-5	IMU	FOG	0.82	18.0	3	0.4	1 $\sigma$	0.03	3	500	1 $\sigma$	0.026
Emcor e	EG-120	Gyro	FOG	0.08	5.0	1	1	1 $\sigma$	$\leq 0.04$	N/A	N/A	N/A	N/A
Gladiator Technologies	A40	Accel	MEMS	0.015	TBD	0	N/A	Unk	N/A	1	45	TBD	0.038
Gladiator Technologies	G150Z	Gyro	MEMS	0.028	TBD	1	1.200	TBD	0.060	0	N/A	N/A	N/A
Gladiator	G300D	IRU	MEMS	0.019	0.25	3	5.000	TBD	0.168	0	N/A	N/A	N/A



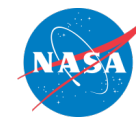
Technologies													
Gladiator Technologies	LandMark 60LX	IMU	MEMS	0.115	0.600	3	4.000	TBD	0.096	3	10	TBD	0.0016
Gladiator Technologies	LandMark 005	IMU	MEMS	0.019	0.400	3	3.5	TBD	0.102	3	20	TBD	0.0024
Gladiator Technologies	LandMark 007	IMU	MEMS	0.025	0.270	3	4.000	TBD	0.12	3	5000	TBD	0.3
Gladiator Technologies	LandMark 007X	IMU	MEMS	0.025	0.450	3	4.000	TBD	0.12	3	5000	TBD	0.3
Gladiator Technologies	LandMark 60LX	IMU	MEMS	0.115	0.600	3	4.000	TBD	0.096	3	10	TBD	0.00168
Gladiator Technologies	LandMark 65	IMU	MEMS	0.115	0.600	3	7.000	TBD	0.120	3	10	TBD	0.0021
Gladiator Techn	MRM60	IMU	MEMS	0.120	1.000	3	3.000	TBD	0.096	3	25	TBD	0.0024



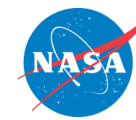
ologies													
Honeywell	MIMU	IMU	RLG	Unk	Unk	Unk	Unk	Unk	Unk	Unk	Unk	Unk	Unk
Honeywell	HG1930	IMU	MEMS	0.16	3.000	3	20.000	1 $\sigma$	0.175	3	10	1 $\sigma$	0.400
Honeywell	HG1700	IMU	RLG	0.9	5.000	3	1.000	1 $\sigma$	0.125	3	1000	1 $\sigma$	0.65
Inertial Sense	$\mu$ IMU	IMU + magnetometers + barometer	MEMS	0.011	0.340	3	10.000	max	0.150	3	40	max	0.070
Inertial Labs	IMU-NAV-100 "Tactical" A	IMU	MEMS	0.155	0.800	3	0.500	rms	0.100	3	3	rms	0.008
Inertial Labs	IMU-P "Tactical" Standard A	IMU	MEMS	0.070	0.800	3	1.000	rms	0.200	3	5	rms	0.015
KVH	1725 IMU	IMU	FOG	0.700	8.000	3	0.10	1 $\sigma$	0.017	3	15	1 $\sigma$	0.071
KVH	1750 IMU	IMU	FOG	0.700	8.000	3	0.100	1 $\sigma$	0.012	3	45	1 $\sigma$	0.014
KVH	1775 IMU	IMU + magnetometers	FOG	0.700	8.000	3	0.100	1 $\sigma$	0.012	3	45	1 $\sigma$	0.071
KVH	CG-5100	IMU	FOG	2.270	15.000	3	1	1 $\sigma$	0.067	3	250	1 $\sigma$	0.12
KVH	DSP-1760	IRU	FOG	0.600	8.000	3	0.100	1 $\sigma$	0.0120	0	N/A	Unk	N/A



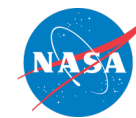
KVH	DSP-3000	Gyro	FOG	0.27 0	3.0 00	1	1.000	1 $\sigma$	0.067	0	N/A	U n k	N/A
KVH	DSP-3100	Gyro	FOG	0.20 0	3.0 00	1	1.000	1 $\sigma$	0.067	0	N/A	U n k	N/A
KVH	DSP-3400	Gyro	FOG	0.30 0	3.0 00	1	1.000	1 $\sigma$	0.067	0	N/A	U n k	N/A
KVH	DSP-4000	Gyros	FOG	2.36 0	9.0 00	2	1.000	1 $\sigma$	0.067	0	N/A	U n k	N/A
L3	CIRUS	Gyros	FOG	15.4 00	40. 00 0	3	0.000	1 $\sigma$	0.100	0	N/A	U n k	N/A
LORD Sensin g	3DM-CV5-10	IMU	MEMS	0.01 1	0.5 00	3	8.000	TB D	0.450	3	80	T B D	0.059
LORD Sensin g	3DM-CX5-10	IMU	MEMS	0.00 8	0.3 00	3	8.000	TB D	0.300	3	40	T B D	0.015
LORD Sensin g	3DM-GX5-10	IMU	MEMS	0.01 65	0.3 00	3	8.000	TB D	0.300	3	40	T B D	0.015
MEMS ENSE	MS-IMU3020	IMU + magnet ometer	MEMS	0.02 0	0.6 50	3	1.060	typ	0.220	3	14.8	ty p	0.078
MEMS ENSE	MS-IMU3025	IMU + magnet ometer	MEMS	0.01 9	0.8 50	3	0.80	typ	0.150	3	6.7	ty p	0.008
MEMS ENSE	MS-IMU3030	IMU + magnet ometer	MEMS	0.02 5	1.3 50	3	0.550	typ	0.11	3	2.9	ty p	0.005



MEMS ENSE	MS-IMU3050	IMU + magnet ometer	MEMS	0.07 9	2.5 00	3	0.300	typ	0.065	3	2.6	ty p	0.006
NewS pace Syste ms	NSGY-001	IRU	Image-based rotation estimate	0.05 5	0.2 00	3	N/A		N/A	0	N/A	U n k	N/A
Northr op Grum an	LN-200S	IMU	FOG, SiAc	0.74 8	12	3	1.000	1 $\sigma$	0.070	3	300	1 $\sigma$	Unk
Northr op Grum an	$\mu$ FORS-3U	Gyro	FOG	0.15 0	2.3 00	1	0.050	1 $\sigma$	0.080	0	N/A	U n k	N/A
Northr op Grum an	$\mu$ FORS-6U	Gyro	FOG	0.15 0	2.3 00	1	0.050	1 $\sigma$	0.047	0	N/A	U n k	N/A
Northr op Grum an	$\mu$ FORS-36m	Gyro	FOG	0.11 0	2.2 5	1	18.000	1 $\sigma$	1.000	0	N/A	U n k	N/A
Northr op Grum an	$\mu$ FORS-1	Gyro	FOG	0.13 7	2.5	1	1.000	1 $\sigma$	0.100	0	N/A	U n k	N/A
Northr op Grum an	$\mu$ IMU-I-SP	IMU	MEMS	0.68 0	8.0 00	3	6.000	1 $\sigma$	0.300	3	3000	r m s	0.147
Northr op Grum an	$\mu$ IMU-I-HP	IMU	MEMS	0.68 0	8.0 00	3	3.000	1 $\sigma$	0.150	3	1500	r m s	0.041



Northrop Grumman	μIMU-IC-SP	IMU	MEMS	0.680	8.000	3	6.000	1σ	0.300	3	3000	rms	0.147
Northrop Grumman	μIMU-IC-HP	IMU	MEMS	0.680	8.000	3	9.000	1σ	0.150	3	1500	rms	0.041
Northrop Grumman	μIMU-M-SP	IMU	MEMS	0.680	8.000	3	9.000	1σ	0.450	3	3000	rms	0.147
Northrop Grumman	μIMU-M-HP	IMU	MEMS	0.680	8.000	3	4.500	1σ	0.230	3	1500	rms	0.041
NovAtel	IMU-HG1900	IMU	MEMS	2.500	8.000	3	1.000	TBD	0.090	3	700	TBD	Unk
NovAtel	IMU-μIMU-IC	IMU	MEMS	2.570	11.000	3	6.000	TBD	0.300	3	3000	TBD	0.250
NovAtel	OEM-IMU-ADIS-16488	IMU	MEMS	0.048	0.254	3	6.25	TBD	0.300	3	100	TBD	0.029
NovAtel	OEM-IMU-EG370N	IMU	MEMS	0.010	0.100	3	0.800	TBD	0.060	3	12	TBD	0.025
NovAtel	OEM-HG1900	IMU	MEMS	0.460	3.000	3	1.000	TBD	0.090	3	700	TBD	Unk
NovAtel	OEM-HG1930	IMU	MEMS	0.200	3.000	3	2.000	TBD	0.125	3	3000	TBD	Unk



NovAtel	OEM-IMU-HG4930P	IMU	MEMS	0.200	3.000	3	Unk	TBD	Unk	3	Unk	TBD	Unk
NovAtel	OEM-IMU-STIM300	IMU	MEMS	0.055	1.500	3	0.500	TBD	0.150	3	50	TBD	0.060
Sensor	STIM202	IRU	MEMS	0.055	1.500	3	0.400	TBD	0.170	0	N/A	TBD	N/A
Sensor	STIM210	IRU	MEMS	0.052	1.500	3	0.300	TBD	0.150	0	N/A	TBD	N/A
Sensor	STIM300	IMU	MEMS	0.055	2.000	3	0.300	TBD	0.150	3	50	TBD	0.070
Sensor	STIM318	IMU	MEMS	0.057	2.500	3	0.300	TBD	0.150	3	3	TBD	0.015
Sensor	STIM320	IMU	MEMS	0.057	2.500	3	0.300	TBD	0.100	3	3	TBD	0.015
Sensor	STIM277H	IRU	MEMS	0.052	1.500	3	0.300	TBD	0.150	0	N/A	TBD	N/A
Sensor	STIM377H	IMU	MEMS	0.055	2.000	3	0.300	TBD	0.150	3	50	TBD	0.070
Silicon Sensing Systems	CRH03	Gyro	MEMS	0.42	0.2W	1	CRH03-010 – 0.03 CRH03-025 – 0.04 CRH03-100 – 0.04		CRH03-010 – 0.005 CRH03-025 – 0.006 CRH03-100 – 0.006	0	N/A	-	N/A



							CRH03-200 – 0.05 CRH03-400 – 0.1		CRH03-200 – 0.008 CRH03-400 – 0.010				
Silicon Sensing Systems	CRH03 (OEM)	Gyro	MEMS	0.18	0.2 W	1	CRH03-010 – 0.03 CRH03-025 – 0.04 CRH03-100 – 0.04 CRH03-200 – 0.05 CRH03-400 – 0.1		CRH03-010 – 0.005 CRH03-025 – 0.006 CRH03-100 – 0.006 CRH03-200 – 0.008 CRH03-400 – 0.010	0	N/A	-	N/A
Silicon Sensing Systems	RPU30	Gyro	MEMS	1.35	<0.8 W	3	0.06		0.006	0	N/A	-	N/A
Silicon Sensing Systems	DMU41	9 DoF IMU	MEMS	<2	<1.5 W	3	0.1		0.015	3	15	-	0.05
Silicon Sensing Systems	DMU11	6 DoF IMU	MEMS	0.04	0.425	3	10		0.4	3	50	-	0.05





Silicon Sensing Systems	CRM	Gyro	MEMS	0.001	0.0165	1	12			0.2	0	N/A		N/A
Silicon Sensing Systems	CAS	Acc	MEMS	0.004	Unk	0	N/A			N/A	2	CAS2X 1S - 7.5 CAS2X 2S - 7.5 CAS2X 3S - 7.5 CAS2X 4S - 25 CAS2X 5S - 75	CAS2X 1S - TBC CAS2X 2S - TBC CAS2X 3S - TBC CAS2X 4S - TBC CAS2X 5S - TBC	
Systro Donner	SDI50x-AE00	IMU	MEMS	0.590	5.000	3	1.000	1 $\sigma$		0.020	3	100	1 $\sigma$	0.059
Thales	InterSense NavChip Series 3 Class A	IMU	MEMS	0.003	0.135	3	4.000	TBD		0.180	3	6	TBD	0.020
Thales	InterSense NavChip Series 3 Class B	IMU	MEMS	0.003	0.135	3	5.000	TBD		0.180	3	40	TBD	0.030
Thales	InterSense NavChip	IMU	MEMS	0.003	0.135	3	5.000	TBD		0.180	3	40	TBD	0.030
Thales	InterSense InertiaCube4	IRU	MEMS	0.011	TBD	3	TBD	TBD		TBD	0	N/A	Unk	N/A



Vector Nav	VN-100	IMU + magnetometers + barometer	MEMS	0.015	0.220	3	10.000	max	0.210	3	40	max	0.082
Vector Nav	VN-110	IMU + magnetometers	MEMS	0.125	2.500	3	1.000	max	0.054	3	10	max	0.024
Xsens Technologies	MTi-610	IMU	MEMS	0.009	1.0	3	8.000	TBD	0.420	3	10	TBD	0.035



### 5.2.10 GPS Receivers

For low-Earth orbit spacecraft, GPS receivers are now the primary method for performing orbit determination, replacing ground-based tracking methods. Onboard GPS receivers are now considered a mature technology for small spacecraft, and some examples are described in table 5-10. There are also next-generation chip-size COTS GPS solutions, for example the NovaTel OEM 719 board has replaced the ubiquitous OEMV1.

GPS accuracy is limited by propagation variance through the exosphere and the underlying precision of the civilian use C/A code (14). GPS units are controlled under the Export Administration Regulations (EAR) and must be licensed to remove Coordinating Committee for Multilateral Export Control (COCOM) limits (15).

However, past experiments have demonstrated the ability of using a weak GPS signal at GSO, and potentially soon to cislunar distances (16) (17). Development and testing in this fast-growing area of research and development may soon make onboard GPS receivers more commonly available.

Table 5-10. GPS Receivers for Small Spacecraft						
Manufacturer	Model	Mass (kg)	Power (W)	Accuracy (m)	Radiation Tolerance (krad)	T R L
APL	Frontier Radio Lite	0.4	1.3	15	20	5-6
Eurotech	COM-1289	0.85	3.625	1.2	Unk	Unk
General Dynamics	Explorer	1.2	8	15	100	7-9
General Dynamics	Viceroy-4	1.1	8	15	100	7-9
NASA GSFC	NavCube Mini 3.0 (Above GPS Constellation Receiver)	2.1*	11*	<80 @ 29Re** <30 @ Moon***	100	5-6
Novatel	OEM719	0.031	1.8	1.5	Unk	7-9
Novatel	OEM729	0.048	1.8	1.5	Unk	7-9
SkyFox Labs	piNAV-NG	0.024	0.124	10	30	7-9
SkyFox Labs	piPATCH-L1E1	0.05	0.02	Unk	Unk	7-9
SkyFox Labs	piPATCH-L1G1	0.05	0.02	Unk	Unk	7-9
SkyFox Labs	miniPATCH-L1	0.05	0.02	Unk	Unk	7-9
Surrey Satellite Technology	SGR-Ligo	0.09	0.5	5	5	5-6
GomSpace	GPS-kit	0.031	1.3	1.5	Unk	Unk

\* Estimate does not include filter, LNA and antenna which will depend on the orbit

\*\* About ½ way to the Moon with Ultra Stable Oscillator (not included in mass and power estimates)

\*\*\* With Rubidium Atomic Frequency Standard Clock (not included in mass and power estimates)



### 5.2.11 Deep Space Navigation

In deep space, navigation is performed using radio transponders in conjunction with the Deep Space Network (DSN). As of 2020, the only deep space transponder with flight heritage suitable for small spacecraft was the JPL-designed and General Dynamics-manufactured Small Deep Space Transponder (SDST). JPL has also designed IRIS V2, which is a deep space transponder that is more suitable for the CubeSat form factor. Table 5-11 details these two radios, and the SDST is illustrated in figure 5.7. IRIS V2, derived from the Low Mass Radio Science Transponder (LMRST), flew on the MarCO CubeSats and is scheduled to fly on INSPIRE (18) and was selected for seven Artemis I secondary payloads (28).



Figure 5.7: General Dynamics SDST. Credit: General Dynamics.

Manufacturer	Model	Mass (kg)	Power (W)	Bands	Radiation Tolerance (krad)	TRL
General Dynamics	SDST	3.2	19.5	X, Ka	50	7-9
Space Dynamics Laboratory	IRIS V2.1	1.2	35	X, Ka, S, UHF	15	7-9

### 5.2.12 Atomic Clocks

Atomic clocks have been used on larger spacecraft in low-Earth orbit for several years now, however integrating them on small spacecraft is relatively new. The conventional method for spacecraft navigation is a two-way tracking system of ground-based antennas and atomic clocks. The time difference from a ground station sending a signal and the spacecraft receiving the response can be used to determine the spacecraft's location, velocity, and (using multiple signals) the flight path. This is not a very efficient process, as the spacecraft must wait for navigation commands from the ground station instead of making real-time decisions, and the ground station can only track one spacecraft at a time, as it must wait for the spacecraft to return a signal (19). In deep space navigation, the distances are much greater from the ground station to spacecraft, and the accuracy of the radio signals needs to be measured within a few nanoseconds.

JPL's Deep Space Atomic Clock (DSAC) project plans to launch a prototype of a miniaturized, low-mass (16 kg) atomic clock based on mercury-ion trap technology which underwent demonstration testing in the fall of 2017. The project aims to produce a <10 kg configuration in the second generation. The DSAC was launched in 2019 as a hosted payload on General Atomics Orbital Test Bed spacecraft aboard the U.S. Air Force Space Technology Program (STP-2) mission (20), and has been extended for in-orbit demonstration through August 2021 and was still in orbit as of June 2021 (29).

More small spacecraft designers are developing their own version of atomic clocks and oscillators that are stable and properly synchronized for use in space. They are designed to fit small spacecraft, for missions that are power- and volume-limited or require multiple radios.

<b>Manufacturer</b>	<b>Model</b>	<b>Dimensions (mm)</b>	<b>Mass (kg)</b>	<b>Power (W)</b>	<b>Frequency Range</b>	<b>Rad Tolerance</b>	<b>T R L</b>
AccuBeat	Ultra Stable Oscillator	131 x 167 x 107	2	5.64 W	57.5185 MHz	50	7-9
Bliley Technologies	Miniature Half-DIP Package Low Power OCXO	Up to 12 x 12 x 10	0.01	0.180	10 MHz to 60 MHz	Unk	7-9
Bliley Technologies	Iris Series 1"x1" OCXO for LEO	19 x 11 x 19	0.016	1.5	10 MHz to 100 MHz	39	7-9
Bliley Technologies	Aether Series TCVCXO for LEO	21 x 14 x 8	Unk	0.056	10MHz to 150 MHz	37	Unk
Microsemi	Miniature Atomic Clock (MAC SA5x)	51 x 51 x 18	0.1	8	10 MHz	Unk	Unk
Microsemi	Space Chip Scale Atomic Clock (CSAC)	41 x 36 x 12	0.035	0.12	10 MHz	20	5-6

### 5.3 On the Horizon

Technological progress in the area of guidance, navigation, and control is slow. Given the high maturity of existing GNC components, future developments in GNC are mostly focused on incremental or evolutionary improvements, such as decreases in mass and power, and increases in longevity and/or accuracy. This is especially true for GNC components designed for deep space missions, where small spacecraft missions have only very recently been demonstrated. However, in a collaborative effort between the Swiss Federal Institute of Technology and Celeroton, there is progress being made on a high-speed magnetically levitated reaction wheel for small satellites (figure 5.8). The idea is to eliminate mechanical wear and stiction by using magnetic bearings rather than ball bearings. The reaction wheel implements a dual hetero/homopolar, slotless, self-bearing, permanent-magnet synchronous motor (PMSM). The fully active, Lorentz-type magnetic bearing consists of a heteropolar self-bearing motor that applies motor torque and radial forces on one side of the rotor's axis, and a homopolar machine that exerts axial and radial forces to allow active control of all six degrees of freedom. It is capable of storing 0.01 Nm of momentum at a maximum of 30,000 rpm, applying a maximum torque of 0.01 Nm (21).



*Figure 5.8: High-speed magnetically levitated reaction wheel. Credit: Celeroton AG.*



Another interesting approach to measuring angular velocity is the Stellar Gyro from NewSpace Systems. This sensor estimates angular rates from star images taken by a camera; one advantage of this approach is that it avoids the problem of gyro drift. Of course, such a sensor does require a clear view of the sky.

## 5.4 Summary

Small spacecraft GNC is a mature area, with many previously flown, high TRL components offered by several different vendors. Progress in developing integrated units will offer simple, single vendor, modular devices for ADCS, which will simplify GNC subsystem design. Other areas of GNC have potential for additional improvements as more research is being conducted. For example, a team at the University of Michigan is developing a multi-algorithmic hybrid ADCS system for CubeSats that can implement multiple estimation and control algorithms (22). Another team from Johns Hopkins University is conducting ground simulations of docking, charging, relative navigation, and deorbiting for a fully robotic CubeSat (23).

The rising popularity of SmallSats in general, and CubeSats in particular, means there is a high demand for components, and engineers are often faced with prohibitive prices. The Space Systems Design Studio at Cornell University is tackling this issue for GNC with their PAN nanosatellites. A paper by Choueiri et al. outlines an inexpensive and easy-to-assemble solution for keeping the ADCS system below \$2,500 (25). Lowering the cost of components holds exciting implications for the future and will likely lead to a burgeoning of the SmallSat industry.

For feedback solicitation, please email: [arc-sst-soa@mail.nasa.gov](mailto:arc-sst-soa@mail.nasa.gov). Please include a business email so someone may contact you further.

## References

- (1) Shepherd, L. C. G. and Shepherd, A. F. S. C.: "*Space Surveillance Network.*" Shared Space Situational Awareness Conference. Olorado Springs. 2006.
- (2) Vallado, D A, et al.: "*Revisiting spacetrack report 3.*" 2006.
- (3) Thornton, C L and Border, J S: "*Radiometric Tracking Techniques For Deep-Space Navigation.*" s.l. : John Wiley & Sons,, 2003.
- (4) JPL. MarCO: Mission Overview. *CubeSat*. [Online] 2020. [<https://www.jpl.nasa.gov/CubeSat/missions/marco.php>].
- (5) Wertz, J. R.: "*Spacecraft attitude determination and control.*" Springer Science & Business Media. Vol. 73. 2012,
- (6) Jin, J, Ko, S and Ryoo, C K: "*Fault Tolerant Control For Satellites With Four Reaction Wheels.*" vol. 16, no. 10, pp. 1250–1258. 2008.
- (7) Kulczycki, R. and Wisniewski, P.: "*Slew Maneuver Control For Spacecraft Equipped With Star Camera And Reaction Wheels.*" Vol. 13, no. 3, pp. 349–356. 2005.
- (8) Spratling, B. B. and Mortari, D.: "*A Survey On Star Identification Algorithms.*" Vol. 2, no. 1, pp. 93–107. 2009.
- (9) Psiaki, M L, Martel, F and Pal, P K.: "*Three-Axis Attitude Determination Via Kalman Filtering Of Magnetometer Data.*" Vol. 13, no. 3, pp. 506–514. 1990.



- (10) Wessels, J H.: "Infrared Horizon Sensor for CubeSat Implementation." *Masters Thesis, Stellenbosch University*. 03 2018.
- (11) Pelemeshko, A, et al.: "*High-Precision Cubesat Sun Sensor Coupled With Infrared Earth Horizon Detector*." IOP Conf. Ser.: Mater. Sci. Eng. Vol. 734. pp. 0121-8. 2020,
- (12) Greenheck, D, et al.: "*Design and Testing of a Low-Cost MEMS IMU Cluster for SmallSat Applications*." 2014. 28th Annual AIAA/USU Conference on Small Satellites.
- (13) Merhav, S.: *Aerospace Sensor Systems and Applications*. Springer New York, 1998.
- (14) Montenbruck, O. et al.: "*Precision Spacecraft Navigation Using A Low-Cost GPS Receiver*." Vol. 16, no. 4, pp. 519–529. 2014.
- (15) "*Foreign Availability Determination Procedures And Criteria*." Office of the Federal Register. Title 15 Part 768.7. 2015.
- (16) Jeffery Foust: "GPS in Space." *MIT Technology Review*. [Online] 01 2002. <https://www.technologyreview.com/2002/01/01/275613/gps-in-space/>.
- (17) Adam Hadhazy: "Cosmic GPS." *Aerospace America*. [Online] 05 2020. <https://aerospaceamerica.aiaa.org/features/cosmic-gps/>.
- (18) Aguirre, F. H.: "*X-Band Electronics For The INSPIRE Cubesat Deep Space Radio*." 2015. IEEE Aerospace Conference.
- (19) Baird, D.: "NASA Tests Atomic Clock for Deep Space Navigation." [Online] 2018. <https://www.jpl.nasa.gov/news/news.php?feature=7053>.
- (20) Cornwell, D.: "NASA's Deep Space Atomic Clock and Optical Communications Program for PNT Applications." [Online] 2016. [Cited: June 19, 2018.] <https://www.gps.gov/governance/advisory/meetings/2016-12/cornwell.pdf>.
- (21) JW, Kolar, et al.: "*High-Speed Magnetically Levitated Reaction Wheels For Small Satellites*." Anacapri, Capri: 23rd International Symposium on Power Electronics, Electrical Drives, Automation and Motion (SPEEDAM 2016), 2016.
- (22) Lee, D Y, Kuevor, P. and Culter, J.: "Multi-algorithmic Hybrid Attitude Determination and Control System of the CubeSat 'CADRE'." [Online] 2016. <https://digitalcommons.usu.edu/smallsat/2016/S2CDH/2/>.
- (23) Mishra, S., Basescu, M. and Kobilarov, M.: "Laboratory Validation of Vision Based Grasping, Guidance and Control with Two Nanosatellite Models." [Online] 2016. <https://digitalcommons.usu.edu/smallsat/2016/S5GuidCont/6/>.
- (24) Gunter, B. C., et al.: "The Ranging and Nanosatellite Guidance Experiment (RANGE)." [Online] 2016. <https://digitalcommons.usu.edu/smallsat/2016/S5GuidCont/3/>.
- (25) Choueiri, M N, Bell, M and Peck, M A.: "Cost-Effective and Readily Manufactured Attitude Determination and Control System for NanoSatellites." *AIAA/ASCE/AHS/ASC Structures, Structural Dynamics, and Materials Conference, AIAA SciTech Forum*. 2018.



- (26) D. Dickinson: "NICER and SEXTANT demonstrate XNAV pulsar navigation system that may be used on Artemis." [Online] 2020. <https://skyandtelescope.org/astronomy-news/nasa-to-use-pulsar-navigation-for-deep-space-missions/>
- (27) Kapás, K., Bozóki, T., Dály, G. et al. Attitude determination for nano-satellites – I. Spherical projections for large field of view infrasensors. *Exp Astron* 51, 515–527 (2021). <https://doi.org/10.1007/s10686-021-09730-y>
- (28) M. M. Kobayashi et al., "The Iris Deep-Space Transponder for the SLS EM-1 Secondary Payloads," in *IEEE Aerospace and Electronic Systems Magazine*, vol. 34, no. 9, pp. 34-44, 1 Sept. 2019, doi: 10.1109/MAES.2019.2905923.
- (29) NASA: "Deep Space Atomic Clock." [Online] 2021 <https://www.jpl.nasa.gov/missions/deep-space-atomic-clock-dsac>





## Chapter Contents

Glossary .....	ii
6.0 Structure, Mechanisms, and Materials .....	155
6.1 Introduction .....	155
6.2 State-of-the-Art – Primary Structures .....	156
6.2.1 Monocoque Construction .....	156
6.2.2 Modular Frame Designs .....	157
6.2.3 Card Slot Systems .....	159
6.2.4 Custom Primary Structures .....	160
6.2.3 Mechanisms .....	161
6.3 State-of-the-Art – Additive Manufacturing (AM).....	165
6.3.1 Applicability of TRL to Polymer AM .....	165
6.3.2 Thermoplastics and Photopolymers .....	166
6.3.3 AM Design Optimization .....	173
6.4 Radiation Effects and Mitigation Strategies.....	174
6.4.1 Shielding from the Space Environment .....	174
6.4.2 Inherent Mass Shielding .....	175
6.4.3 Shields-1 Mission, Radiation Shielding for CubeSat Structural Design ...	176
6.4.4 Ad Hoc Shielding .....	177
6.4.5 Charge Dissipation Coating .....	178
6.4.6 LUNA Innovations, Inc. XP Charge Dissipation Coating.....	178
6.5 Summary.....	178
References .....	179



## Chapter Glossary

(ABS)	Acrylonitrile Butadiene Styrene
(ACS3)	Advanced Composite Solar Sail project
(AE)	Aerospace Corporation Electron
(AM)	Additive manufacturing
(AMODS)	Autonomous On-orbit Diagnostic System
(AP)	Aerospace Corporation Proton
(CAM)	Computer Aided Manufacturing
(COBRA)	Compact On-Board Robotic Articulator
(COTS)	Commercial-off-the-Shelf
(CSLI)	CubeSat Launch Initiative
(CTD)	Composite Technology Deployment
(DCB)	Deployable Composite Boom
(DDD)	Displacement Damage Dose
(DLP)	Digital Light Projection
(DOF)	Degrees of Freedom
(EEE)	Electrical, Electronic and Electro-mechanical
(EELV)	Evolved Expendable Launch Vehicle
(ESD)	Electrostatic Discharge
(ESPA)	EELV Secondary Payload Adapter
(FDM)	Fused Deposition Modeling
(FFF)	Fused Filament Fabrication
(FPGAs )	Field Programmable Gate Arrays
(FST)	Flame, Smoke, and Toxicity
(GCD)	Game Changing Development
(GEVS)	General Environmental Verification Standard
(HDT)	Heat Deflection Temperature
(ISS)	International Space Station
(LaRC)	Langley Research Center
(MOSFETs)	Metal Oxide Semiconductor Field Effect Transistors
(NSTAR)	Naval Academy Satellite Team for Autonomous Robotics
(PAEK)	Polyaryletherketone
(PC)	Polycarbonate



(PCB)	Printed Circuit Board
(PEEK)	Polyetheretherketone
(PEI)	Polyetherimide
(PEKK)	Polyetherketoneketone
(PLA)	Polylactic Acid
(PLEO)	Polar Low-Earth Orbit
(PSC)	Planetary Systems Corporation
(RECS)	Robotic Experimental Construction Satellite
(ROC)	Roll Out Composite
(RSat-P)	Repair Satellite-Prototype
(SADA)	Solar Array Drive Actuator
(SEUs)	Single Event Upsets
(SLA)	Stereolithography
(SLS)	Selective Laser Sintering
(SPEs)	Solar Particle Events
(STELOC)	Stable Tubular Extendable Lock-Out Composite
(STMD)	Space Technology Mission Directorate
(TID)	Total Ionizing Dose
(TRAC)	Triangle Rollable and Collapsible
(ULA)	United Launch Alliance



## 6.0 Structure, Mechanisms, and Materials

### 6.1 Introduction

Additive manufacturing (AM) has played a large role in the increase of custom structural solutions for SmallSats, and materials that were once out of reach of AM are now readily available in higher end systems and have demonstrated high throughput of complex structures. Once only for secondary structures, AM has seen an expansion in primary structures – especially in small CubeSat or PocketQube buses.

However, for larger CubeSats and Evolved Expendable Launch Vehicle (EELV) Secondary Payload Adapter (ESPA) SmallSats, conventionally machined assemblies constructed from aluminum alloys still have their place for primary structures. Secondary structures, such as solar panels, thermal blankets, and subsystems, are attached to primary structures. They stand on their own and transmit little to no critical structural loads. When a primary structure fails, catastrophic failure of the mission occurs. While failure of a secondary structure typically does not affect the integrity of the spacecraft, it can have a significant impact on the overall mission. These structural categories serve as a good reference but can be hard to distinguish for small spacecraft that are particularly constrained by volume. This is especially true for SmallSats, as the capabilities of these spacecraft may be similar to full size buses, but the volume afforded by dispensers or deployment rings become the constraining factor. Therefore, it is imperative that structural components are as volume efficient as possible. The primary structural components need to serve multiple functions to maximize volume efficiency. Such functions may include thermal management, radiation shielding, pressure containment, and even strain actuation. These are often assigned to secondary structural components in larger spacecraft.

Material selection is of primary importance when considering small spacecraft structures. Requirements for both physical properties (density, thermal expansion, and radiation resistance) and mechanical properties (modulus, strength, and toughness) must be satisfied. The manufacture of a typical structure involves both metallic and non-metallic materials, each offering advantages and disadvantages. Metals tend to be more homogeneous and isotropic, meaning properties are similar at every point and in every direction. Non-metals, such as composites, are inhomogeneous and anisotropic by design, meaning properties can be tailored to directional loads. Recently, resin or photopolymer-based AM has advanced sufficiently to create isotropic parts. In general, the choice of structural materials is governed by the operating environment of the spacecraft, while ensuring adequate margin for launch and operational loading. Deliberations must include more specific issues, such as thermal balance and thermal stress management. Payload or instrument sensitivity to outgassing and thermal displacements must also be considered.

Structural design is not only affected by different subsystems and launch environments, but also the spacecraft application and intended environment. There are different configurations for spin-stabilized and 3-axis stabilized systems, and the instrumentation used places requirements on the structure. Some require mechanisms, such as deployable booms, to create enough distance between a magnetometer and the spacecraft to minimize structural effects on the measurement. The spacecraft exterior and interior material and electronic subsystems need to be understood in the specific mission environment (e.g., in-space charging effects). Mitigation for charge build up is provided in section 6.3.2 Thermoplastics and Photopolymers.

Highly configurable or modular systems may be desirable in quick-turn products, as prototyping and firmware and software development can be extended further into the spacecraft design cycle



with flight hardware in the loop. Card slot systems not only provide those benefits, but when paired with certain standards, they can still fulfill the same structural, mechanical, and thermal requirements as the current CubeSat method of “stacking” electronics and payloads.

An overview of radiation effects and some mitigation strategies is included in this chapter because radiation exposure can impact the structural design of small spacecraft. For SmallSats operating out of low-Earth orbit with increased radiation exposure, mission planners may also want to consider risk mitigation strategies associated with specific radiation environments. This includes both interplanetary missions, where solar radiation dominates, and polar low-Earth orbit (PLEO) missions, where solar radiation risk increases over the poles. In addition, as solar maximum approaches in 2025 (1) with an increased number of solar particle events (SPEs), mission planners will need to consider many orbital environments.

The information described below is not intended to be exhaustive but provides an overview of current state-of-the-art technologies and their development status for a particular small spacecraft subsystem. It should be noted that Technology Readiness Level (TRL) designations may vary with changes specific to payload, mission requirements, reliability considerations, and/or the environment in which performance was demonstrated. Readers are highly encouraged to reach out to companies for further information regarding the performance and TRL of described technology. There is no intention of mentioning certain companies and omitting others based on their technologies or relationship with NASA.

## **6.2 State-of-the-Art – Primary Structures**

Two general approaches are common for primary structures in the small spacecraft market: commercial-off-the-shelf (COTS) structures and custom machined or printed components. It is not surprising that most COTS offerings are for the CubeSat market. Often COTS structures can simplify development, but only when the complexity of the mission, subsystems, and payload requirements fall within the design intent of a particular COTS structure. Custom machined structures enable greater flexibility in mission specific system and payload design. The typical commercially available structure has been designed for low-Earth orbit applications and limited mission durations, where shielding requirements are confined to limited radiation protection from the Van Allen Belts.

There are now several companies that provide CubeSat primary structures (often called frames or chassis). Most are machined from aluminum alloy 6061 or 7075 and are designed with several mounting locations for components to allow flexibility in spacecraft configuration. This section highlights several approaches taken by various vendors in the CubeSat market. Of the offerings included in the survey, 1U, 3U and 6U frames are most prevalent, where a 1U is nominally a 10 x 10 x 10 cm structure. However, 12U frames are becoming more widely available. As there are now dispensers for the 12U CubeSat structure, there is an additional standard for CubeSat configurations. This trend has followed the development path of the 6U and 12U CubeSat structure, as 12U dispensers are now available through several launch service providers like NanoRacks and United Launch Alliance (ULA) through the Atlas series.

### **6.2.1 Monocoque Construction**

Monocoque structures are load-bearing skins that have significant heritage on aircraft. On small spacecraft, the intent of this design is several-fold – it maximizes internal volume, it provides more thermal mass for heat sinks or sources, it allows for more mounting points, and it has more surface area to potentially reduce total ionizing dose (TID). Monocoque construction is common, and “extruded” designs are relatively easy to fabricate through CNC machining, waterjet, or laser cutting. The following are two examples of monocoque CubeSat structures.

### Pumpkin, Inc.

In the structural monocoque approach taken by Pumpkin for their 1U – 3U spacecraft, loads are carried by the external skin to maximize internal volume. Pumpkin provides several COTS CubeSat structures intended as components of their CubeSat Kit solutions, ranging in size from sub-1U to the larger 6U – 12U SUPERNOVA structures (2). Pumpkin offerings are machined from Al 5052-H32 and can be either solid-wall or skeletonized.

Pumpkin has developed the SUPERNOVA, a 6U and 12U structure that features a machined aluminum modular architecture. The 6U structure in figure 6.1 is designed to integrate with the Planetary Systems Corporation (PSC) Canisterized Satellite Dispenser and accommodates the PSC Separation Connector for power and data during integration (2). Configurations for other dispensers are also available.

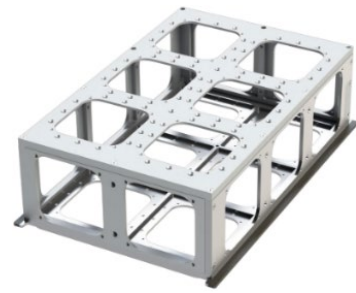


Figure 6.1: The 6U Supernova Structure Kit. Credit: Pumpkin, Inc.

### AAC Clyde Space CS CubeSat Structure

AAC Clyde Space offers a monocoque CubeSat structure from 1U to 3U. The 1U chassis has a total mass of 0.155 kg and dimensions of 100 x 100 x 113.5 mm. The 2U structure has a mass of 0.275 kg and dimensions of 100 x 100 x 227 mm. The 3U structure has a mass of 0.394 kg and dimensions of 100 x 100 x 340.5 mm. AAC Clyde Space standardized their components to facilitate spacecraft configuration, as both 1U and 3U structures interface with all standard dispensers, such as NanoRacks (3). The 3U structure is seen in figure 6.2.



Figure 6.2: 3U CS Structure. Credit: AAC Clyde Space.

### 6.2.2 Modular Frame Designs

Modular frames allow for a flexible internal design for quick turn missions, while still ensuring strict adherence to external dimensions of the CubeSat standard, especially when deployment from a standardized, reusable dispenser is a requirement. Open frames are suitable for low-Earth orbit, as radiation shielding is not provided by the structure. Care must also be taken to design for thermal mass requirements, as modular frames are inherently light. The following subsections contain examples of modular CubeSat frame designs. Table 6-1 lists commercially available CubeSat structures.

#### NanoAvionics Modular Frame

NanoAvionics has developed what it calls “standardized frames and structural element” that, when assembled, form the primary structure for 1U to 12U spacecraft. A modular 3U structure from NanoAvionics is shown in figure 6.3. These components are intended to be modular, made from 7075 aluminum, and like many COTS CubeSat structures, compliant with the PC/104 form factor (4).

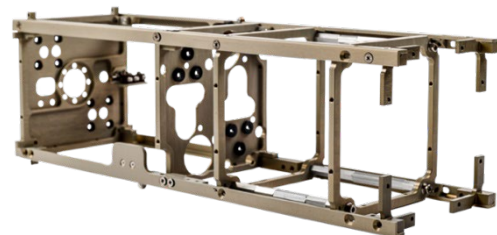


Figure 6.3: NanoAvionics Small Satellite Structures. Credit: NanoAvionics.

#### Innovative Solutions In SPACE

ISISPACE offers a wide array of CubeSat structures, with the largest being a 16U structure. Several of their 1U, 2U, 3U and 6U structures have been flown in low-Earth orbit (see table 6-1 for more

information on these structures). Multiple mounting configurations can be considered to allow a high degree of creative flexibility with the ISISPACE design. Detachable shear panels allow for access to all the spacecraft's electronics and avionics, even after final integration (5).

### GomSpace

GomSpace provides full turn-key solutions for small satellite systems. They offer modular nanosatellite structures from 1 – 6U with strong flight heritage. The 6U (figure 6.4) has a 4U payload allocation, mass of 8 kg, and propulsive configuration capabilities. The 3U structure was first deployed from the International Space Station (ISS) in 2015, and two 6U systems were deployed in early 2018 (5).

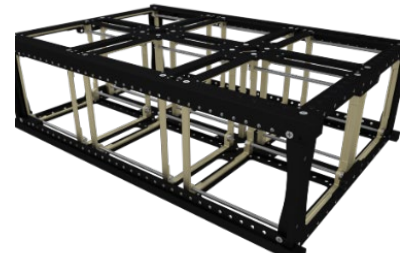


Figure 6.4: 6U nanosatellite structure. Credit: GomSpace.

### EnduroSat

EnduroSat provides 1U, 1.5U, 3U, 6U CubeSat structures and material; all EnduroSat structures are made of either Aluminum 6061-T651 or Al 7075. All the listed structures have undergone environmental qualification including vibrational, thermal and TVAC testing while the 1U structure and 3U structure also have flight heritage (6).

Table 6-1: Commercial Modular Frames				
Manufacturer	Structure	Dimensions (mm)	Primary Structure Mass (kg)	Material
EnduroSat	1U	100 x 100 x 114	< 0.1	Al 6061 or 7075
	1.5U	100 x 100 x 170.2	0.11	Al 6061 or 7075
	3U	100 x 100 x 340	< 0.29	Al 6061
	6U	100 x 226 x 366	< 1	Al 6061
	1U	100 x 100 x 114	0.1	Al 6061
ISISPACE	2U	100 x 100 x 227	0.16	Al 6061
	3U	100 x 100 x 341	0.24	Al 6061
	6U	100 x 226 x 340.5	0.9	Al 6061
	8U	226 x 226 x 227	1.3	Al 6061
	12U	226.3 x 226 x 341	1.5	Al 6061
	16U	226.3 x 226.3 x 454	1.75	Al 6061
GomSpace	6U	340.5 x 226.3 x 100	1.06	Al 7075
Ishitoshi Machining	1U	100 x 100 x 113.5	0.1	A7075, A6061
NanoAvionics	1U	100 x 100 x 113.5	0.105	Al 7075-T6
	2U	100 x 100 x 227.0	0.208	Al 7075-T6
	3U	100 x 100 x 340.5	0.312	Al 7075-T6
Spacemind	1U	113.5 x 100 x 100	0.0849	Al 6061



	2U	227 x 100 x 100	0.0156	Al 6061
	3U	340.5 x 100 x 100	0.0226	Al 6061
	6U	F: 340.5 x 226.3 x 100 L: 366 x 226.3 x 100	0.055	Al 6061
	12U	340.5 x 226.3 x 226.3	0.143	Al 6061
Sputnik	1U	100 x 100 x 113.5	0.0132	
	3U	100 x 100 x 340.5	0.0455	

### 6.2.3 Card Slot Systems

Card slot systems for military and space applications are increasingly being employed due to the ease of installation and ability to hot-swap quickly. The card slot system uses a “backplane” PCB that has an array of standardized connectors. In various applications, cards are mechanically supported by a standardized structure on “rails.” This is similar to custom desktop personal computers or rack servers that use expansion cards, such as graphics or networking cards using the PCIe standard. As of 2021, very few commercial card slot systems specific to CubeSats have been produced, however the new SpaceVNX standard may change this in the coming years as PC/104 did in the past for CubeSats.

#### SpaceVNX

For both connectors and structural elements, the VPX standard (VITA 46) was formed in 2009 by Mercury Systems (8). Already supported by dozens of military suppliers, the standard allows for a robust mechanical and electrical connection between the board and expansion card, while still allowing for access to individual systems through interoperability. VPX was modified to create SpaceVNX, ratified in 2017. The SpaceVNX standard (VITA 74) was developed to meet demand for smaller form factors and embedded systems, which is directly compatible with the CubeSat standard. The card slot system was designed for conduction cooling and full contact with structural components to maximize heat transfer. This allows for high-power systems such as large die Field Programmable Gate Arrays (FPGAs) and single board computers. These are important systems engineering considerations, as commercial computing systems with a focus on AI/ML generally have higher thermal dissipation power. More thermal mass in the SpaceVNX structural design also has the benefit of limited radiation shielding. As discussed previously, the backplane system inherent to SpaceVNX allows for hot-swapping of modules and late-load or last-minute software or hardware changes. NASA Goddard’s SpaceCube 3.0 data processing system demonstrated the use a custom-designed SpaceVNX connector and backplane system in 2019 (9).

Because SpaceVNX includes a mechanical standard, it can provide a rigid interface to the spacecraft primary structure. The 400-pin backplane connectors are also designed to withstand 0.2 g<sup>2</sup>/Hz for 12 hours and the full military temperature range, with 125°C exposure for a minimum of 1,000 hours (10).



### Complex Systems & Small Satellites (C3S)

C3S has developed a 3U CubeSat structure (figure 6.5) that uses a backplane printed circuit board (PCB) for bus communication, which provides independent assembly order, simplifies the stack-up tolerances, and uses space-grade interface connectors (7). These benefits include:

- High reliability electronic, structural, and thermal connections
- Access to individual cards and units during integration and testing
- Simplified stack-up tolerances
- Dedicated and independent thermal interfaces for all cards

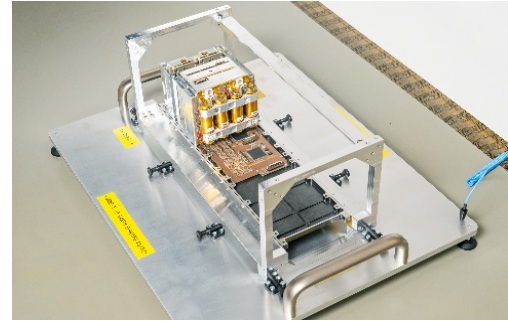


Figure 6.5: C3S 3U CubeSat Structure. Credit: Complex Systems & Small Satellites.

#### 6.2.4 Custom Primary Structures

A growing development in building custom small satellites is the use of detailed interface requirement guidelines. These focus on payload designs with the understanding of rideshare safety considerations for mission readiness and deployment methods. Safety considerations include safety switches, such as the "remove before flight" pins and foot switch, and requirements that the spacecraft remain powered-off while stowed in the deployment dispensers. Other safety requirements often entail anodized aluminum rails and specific weight, center of gravity, and external dimensions for a successful canister or dispenser deployment. The required interface documents originate with the rideshare integrator for the specific dispenser being used with the launch vehicle. The launch vehicle provider typically provides the launch vibrational conditions. The NASA CubeSat Launch Initiative (CSLI) requires CubeSat or SmallSat systems be able to withstand the General Environmental Verification Standard (GEVS) vibration environment of approximately 10  $G_{rms}$  over a 2-minute period (11). The NASA CSLI rideshare provides electrical safety recommendations for spacecraft power-off requirements during launch and initial deployment. The detailed dispenser or canister dimensional requirements provide enough information, including CAD drawings in many cases, to enable a custom structural application. Table 6-3 lists some dispenser and canister companies that provide spacecraft physical and material requirements for integration (12-14).

<b>Table 6-3: Spacecraft Physical Dimension and Weight Requirements from Deployers</b>			
<b>Manufacturer</b>	<b>U</b>	<b>Requirements</b>	<b>Available Documents</b>
Tyvak Railpod III, 6U NLAS, 12U Deployer	3U, 6U, 12U	Dimensions, Weight, Rail	Interface Control Documentation
Planetary Sciences Corporation	3U, 6U, 12U	Dimensions, Weight, Tabs	Interface Guide, CAD Drawings

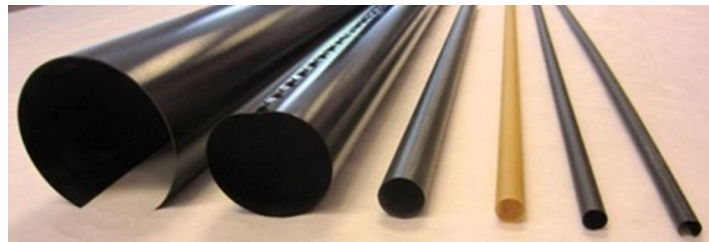
ISIPOD ISIS CubeSat Shop	1U, 2U, 3U, 4U, 6U, 8U, 12U, 16U	Dimensions, Weight, Rail	Follows CubeSat Standard
-----------------------------	--	-----------------------------	--------------------------

### 6.2.3 Mechanisms

There are several companies offering mechanisms for small spacecraft. Although not exhaustive, this section will highlight a few devices for release actuation, component pointing, and boom extension, which represent the state-of-the-art for the CubeSat market. Please refer to the Deorbit Systems chapter for deployable mechanisms used for deorbit devices.

#### Composite Technology Deployment (CTD): Deployable Booms

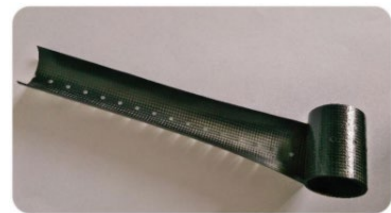
CTD has developed a composite boom called the Stable Tubular Extendable Lock-Out Composite (STELOC), that is rolled up or folded for stowage and deploys using stored strain energy. The slit-tube boom, shown in figure 6.6 employs an innovative interlocking SlitLock™ edge feature along the tube slit that greatly enhances stability. The boom can be fabricated in many custom diameters and lengths, offers a small stowed volume, and has a near-zero coefficient of thermal expansion (CTE) (15). This technology has flown in low-Earth orbit.



*Figure 6.6: CTD's Deployable Composite Booms. Credit: Composite Technology Development.*

#### AlSat-1N: AstroTube Deployable Boom

Oxford Space Systems collaborated with the Algerian Space Agency to develop the AstroTube deployable boom (figure 6.7) that was recently demonstrated in low-Earth orbit on a 3U CubeSat called AlSat-1N. It is the longest retractable boom that has been deployed and retracted on the 3U CubeSat platform. It incorporates a flexible, composite structure for the 1.5 m-long boom element, and a novel deployment mechanism for actuation. When retracted, the boom is housed within a 1U volume and has a total mass of 0.61 kg (16).



*Figure 6.7: The flexible composite member that is employed on the AstroTube. Credit: Oxford Space Systems.*

#### Redwire Space: Deployable Booms and Manipulators

Redwire Space (previously ROCCOR) has developed several different deployable booms that have a wide range of applications on small spacecraft. The Roll Out Composite (ROC) Booms are designed to deploy instruments or provide deployment force and structure to antennas, solar arrays, and other system architectures. These booms are 1 – 5 m in length and are fabricated from fiber reinforced polymer composites and can be tailored to meet a wide range of requirements for stiffness, force output, thermal stability, etc. These booms can also be made either motor driven, or strain energy driven, and some versions have features for harness management. Furthermore, several versions of these booms can be made to retract on-orbit. There are currently three ROC Booms in orbit, with other systems awaiting launch in 2022 (17).

The CubeSat ROC Boom Deployer was developed for magnetometer applications, using a similar high strain composite slit-tube boom, however it is implemented in a different way (17). The CubeSat ROC Boom Deployer is root rolled and motorized while the ROC-FALL system is tip-

rolled and passively deployed. The CubeSat ROC Boom Deployer is awaiting a launch opportunity to reach TRL 7.

Redwire Space's family of robotic manipulators provide a wide range of capabilities, including 5 to 7 DOF, 1 to 4 m reach, and 8 to 65 kg mass, supporting a variety of orbital and lunar surface applications. The robotic arms are built from a suite of modular interchangeable elements, enabling variable reach, torque applications, configuration, and grappling capabilities. This technology is primarily for ESPA class satellites.

### NASA: Deployable Composite Boom (DCB)

NASA Langley Research Center (LaRC) has developed DCBs through the Space Technology Mission Directorate (STMD) Game Changing Development (GCD) program and a joint effort with the German Aerospace Center. DCBs have high bending and torsional stiffness, packaging efficiency, thermal stability, and a low weight of less than 25% compared to metallic booms (18). The Advanced Composite Solar Sail project (ACS3) will demonstrate DCB technology for solar sailing applications. The DCB/ACS3 7 m boom technology is extensible to 16.5 m deployable boom lengths (figure 6.8).

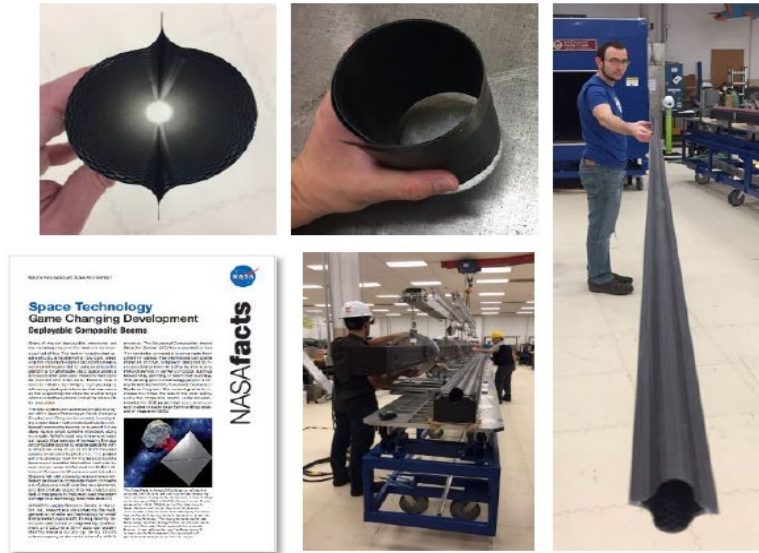


Figure 6.8: NASA Deployable Composite Boom (DCB) Technology. Credit: NASA.

### RSat-P and RECS: Robotic Arms

Repair Satellite-Prototype (RSat-P) is a 3U CubeSat that is part of the Autonomous On-orbit Diagnostic System (AMODS) built by the US Naval Academy Satellite lab to demonstrate capabilities for on-orbit repair systems (19). RSat-P uses two 60 cm extendable robotic arms with the ability to maneuver around a satellite to provide

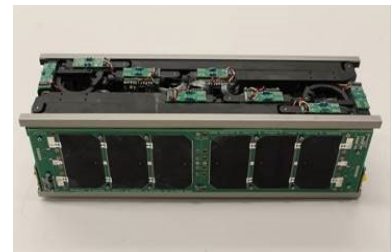
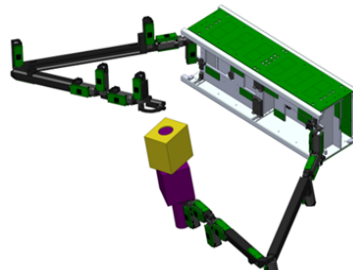


Figure 6.9: Robotic Experimental Construction Satellite (RECS). Credit: The Naval Academy.

images and other diagnostic information to a ground team. RSAT-P launched with the ELaNaXIX Mission in December 2018 and was lost during initial deployment. The robotic development has continued with the Naval Academy Satellite Team for Autonomous Robotics (NSTAR) Robotic Experimental Construction Satellite (RECS), a 3U CubeSat, which will demonstrate the robotic arm capabilities in the ISS microgravity environment in late 2021 (20). The RECS robotic arms were built using 3D Windform print technology. Figure 6.9 shows the robotic arms from RSAT CubeSat heritage that are being developed further for RECS.

### Tethers Unlimited, Inc.: 3 DOF Gimbal Mechanism

Tethers Unlimited offers a three degrees of freedom (3DOF) gimbal mechanism called the Compact On-Board Robotic Articulator (COBRA) that has two available configurations. A few of the varying specifications are found in table 6-4, and the HPX configuration is shown in figure 6.10. This mechanism provides accurate and continuous pointing for sensors and thrusters (21).

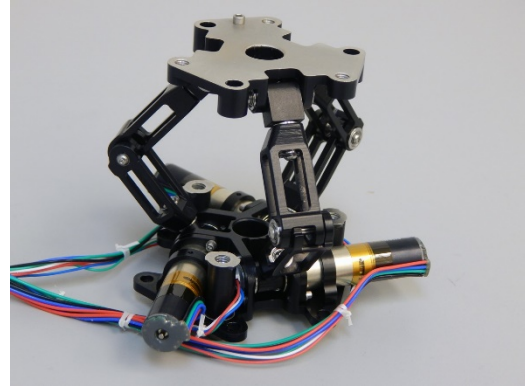


Figure 6.10: COBRA-HPX. Credit: Tethers Unlimited, Inc.

Five COBRA gimbals have been deployed on-orbit over the past year, providing precision pointing for optical and high frequency RF satellite crosslinks on private small spacecraft missions.

The KRAKEN robotic arm is modular, with high-dexterity (up to 7 DOF) and will enable CubeSats to perform challenging missions, such as in-orbit assembly, satellite servicing, and debris capture. The standard configuration is a 1 m arm that can stow in a 190 x 270 x 360 mm volume with a mass of 5 kg. The TRL for this system is 6, assuming a low-Earth orbit environment (22).

Table 6-4: Tethers Unlimited COBRA Specifications		
	COBRA-UHPX	COBRA-HPX
Mass (kg) (with launch locks)	0.491	0.276
Stowed diameter footprint (mm)	165	113
Deployed Height (excl. launch locks)	85.5	73.5
Operating Temperature Range (°C)	-35 to +70	-35 to +70
Power Consumption	Load Dependent	2.4 W
Payload Capacity	0.5 kg in 1G	1.2 kg in zero-G
Actuator	22 mm BLDC Motor	12 mm Stepper Motor
TRL in LEO	9	9

The COBRA-Bee carpal-wrist mechanism was developed for the NASA Astrobee-- a small, free-flying robot that assists astronauts aboard the ISS. The COBRA-Bee gimbal can enable Astrobee to precisely point and position sensors, grippers, and other tools (23). COBRA-Bee is a small-scale, tightly integrated COTS product, that can provide precise multi-purpose pointing and positioning with an interface to support third-party sensors, end-effectors, and tools.

### Honeybee: Solar Panel Drive Actuator

Honeybee, in cooperation with MMA, has developed a CubeSat Solar Array Drive Actuator (SADA) that accommodates  $\pm 180^\circ$  single-axis rotation for solar array pointing, can transfer 100 W of power from a pair of deployed panels, and features an auto sun-tracking capability (14). Honeybee also offers the unit in a slip-ring configuration for continuous rotation. Table 6-5 highlights a few key specifications for this actuator. As of 2021, the SADA is in high-rate production for the OneWeb satellite internet constellation (24).

<b>Mass (slip ring option)</b>	0.18 kg
<b>Backlash</b>	< 3°
<b>Operating Temperature Range (°C)</b>	-30 to +85
<b>Size</b>	100 x 100 x 6.5 mm
<b>Radiation Tolerance</b>	10 kRad
<b>Wire Wrap (7 channels per wing)</b>	@ 1.4 A per channel
<b>Slip Ring (10 channels per wing)</b>	@ 0.5 A per channel
<b>TRL</b>	9
<b>Reference Mission(s)</b>	OneWeb

### Ensign-Bickford Aerospace & Defense

EBAD's TiNi™ product line has a full array of small and reusable non-pyrotechnic actuators suitable for SmallSats. In particular, the Mini Frangibolt® and MicroLatch are suitable for CubeSat deployers or other high loading mechanical release mechanisms.

The Frangibolt operates by applying power to a Copper-Aluminum-Nickel memory shape alloy cylinder which generates force to fracture a custom notched #4 fastener in tension. The Frangibolt is intended to be reusable by re-compressing the actuator using a custom tool and replacing the notched fastener (25), and it has operated in low-Earth orbit on Pumpkin™ CubeSat buses. The ML50 Micro Latch is designed to release loads up to 50 lbf (222.4 N) and is capable of supporting forces up to 100 lbf (445 N) during maximum launch conditions. A standard interface uses a 4 – 40 thread to attach a bolt or stud to the releasable coupling nut. Field resetting of the device is done simply by ensuring no more power is being sent to the device, placing the coupler back on the device, and hand pressing it until the coupler engages with the ball locks (25). Figure 6.11 shows a model of the FD04 Frangibolt actuator and a picture of the ML50 microlatch, and table 6-6 describes a few key specifications of both mechanisms.



Figure 6.11: (left) TiNi Aerospace Frangibolt Actuator and (right) ML50 microlatch. Credit: Ensign-Bickford Aerospace & Defense.



<b>Table 6-6: Ensign-Bickford Aerospace &amp; Defense Release Mechanisms</b>			
<b>TiNi™ FD04 Frangibolt Actuator</b>		<b>TiNi™ ML50 Specifications</b>	
<b>Mass (kg)</b>	0.007	<b>Mass (kg)</b>	0.015
<b>Power C</b>	15 W @ 9 VD	<b>Power/Operational Current</b>	1.5 A to 3.75 A
<b>Operating Temperature Range (°C)</b>	-50 to +80	<b>Operating Temperature Range (°C)</b>	-50°C to +60
<b>Size</b>	13.72 x 10.16 mm	<b>Max Release Load</b>	222.4 N
<b>Holding Capacity</b>	667 N	<b>Max Torque</b>	106 N mm
<b>Function Time Typically</b>	20 sec @ 9 VDC	<b>Function Time Typically</b>	120 ms @ 1.75A (23°C)
<b>Life</b>	50 cycles MIN	<b>Life</b>	50 cycles MIN
<b>TRL</b>	9	<b>TRL</b>	9

### 6.3 State-of-the-Art – Additive Manufacturing (AM)

Additive manufacturing processes for primary spacecraft structures have long been proposed; only recently such methodologies have been adopted for flight. However, it is important to note that AM has become common for smallsat secondary structural elements for many years. Typically, the advantage of AM is to free the designer from constraints imposed by standard manufacturing processes and allow for monolithic structural elements with complex geometry. In practice, additive manufacturing has a separate design space and design process, which has seen tighter integration into computer-aided design, computer-aided manufacturing, and modal and structural analysis packages in the past few years. Such tools can enable quicker turnaround times for smallsat development. This is instrumental in mass optimization, the potential for using AM materials in radiation shielding, and high-throughput, high-quality manufacturing. As the AM field is rapidly evolving, this section makes a best attempt to cover as many materials and printers as possible that are potentially applicable to SmallSat development.

#### 6.3.1 Applicability of TRL to Polymer AM

While AM systems and platforms might be considered mature and of high TRL, the TRL of AM parts configured for spaceflight depends on the material, the configuration of the actual part, the manufacturing process of the material, the postprocessing of the manufactured part, the testing and qualification process, and many other factors. For example, nylon fabricated with a fused filament fabrication (FFF) system will have different bulk structural properties from nylon fabricated with a selective laser sintering system.

In other words, a TRL might be assignable to a component created through a particular manufacturing process with a specific material. If a particular component manufactured with nylon on an FFF system was flown to low-Earth orbit successfully, the TRL for this component would be 7. If this component was subsequently flown on another mission manufactured with Antero 840 PEEK also on an FFF system, the TRL would still be 7. Documentation of the manufacturing process is important to properly account for TRL. This section focuses on polymer AM and does not address metal AM for SmallSats.



### Inspection and Testing

When new materials and/or processes are used, testing shall be performed to minimize risk by lowering the gap between jumps in TRL. In particular, the only way to validate what the structure, component, or material is being tailored for is through testing, especially if more freedom is allocated to research and development. For new material types, if there is latitude afforded in upfront research and development, mechanical, modal, and thermal tests should be performed to compare against a known, proven structural design.

#### 6.3.2 Thermoplastics and Photopolymers

With the expansion of available open-source AM platforms in the last decade, thermoplastics and photopolymer materials have rapidly gained traction and acceptance in many applications ranging from mechanical validation and fit-checking to engineering-grade, low-rate production products. Photopolymer or “thermoset” resins, and the associated manufacturing processes, have improved to the point where microfluidics experiments may be additively manufactured, where microfluidics channels and growth chambers are directly manufactured as one piece, as opposed to the more traditional microfluidics approach of machining a plastic block.

As of publication, there are three primary methods of conducting AM for plastics: FFF, which uses thermoplastics in either a spool or pellet form; stereolithography (SLA), which uses photopolymer resin; and selective laser sintering (SLS), which uses a fine powder. Within SLA, there are two methods of curing resin: digital light projection (DLP), which uses a very high-resolution LED matrix – a monochrome display – to nearly instantly cure the entire layer; and polyjets, which deposit resin from a line array of jets, much like an inkjet printer with a large print head.

Certain thermoplastics are quickly gaining acceptance for high-reliability parts and applications on Earth; though, as of writing, this has yet to be seen in widespread acceptance in any space application. A factor in this is the lack of ability to produce surfaces as smooth as machined metals, in which the latter is required for parts with tight tolerances. However, some thermoplastics are machinable, such as Nylon or polyetherimide (PEI). Similar to the manufacture of cast iron parts, machining to a final, high tolerance specification may allow these thermoplastics to further gain more acceptance.

Except for some large-format AM centers, almost all thermoplastics are manufactured in spools, and may or may not be packaged for proprietary solutions. For SLA, almost all resins are used specifically for commercial solutions and AM centers. Additionally, some manufacturers may mix in additives to enhance material properties or ease the printing process. Because of this, the following sections on each material include a table of materials for both open-source and commercial solutions, and selected properties of interest. Availability of recommended nozzle and bed temperature is indicative of the ability to be printed on an open-source machine, except otherwise noted in the material description. Materials are not picked according to preference but picked through availability of technical specifications and potential applicability. Readers are encouraged to use these sections as a rough guide for commercially available filaments at the time of writing for either type of AM solutions. Additionally, the material tables will be expanded as more data is obtained on the following materials.

Surface discharges, or electrostatic discharge (ESD), is a result of in-space charging effects and are caused by interactions between the in-flight plasma environment and spacecraft materials and electronic subsystems (26). The field buildup and ESD can negatively affect the spacecraft and there are design precautions that must be taken depending on the environment in which the spacecraft will be operating. Per ESD guidelines from NASA Spacecraft Charging Handbook 4002A, dielectric materials above  $10^{12}$  Ohm ( $\Omega$ ) cm should be avoided because charge



accumulation occurs regardless. Please refer to the NASA Handbook 4002A, 5.2.1.5 Material Selection for more information. Historically, ESD due to faulty grounding has been a leading cause of spacecraft or subsystem failures (26). Volume resistivity and dielectric constant are two material properties used to determine charge dissipation for the evaluation of electrostatic discharge risk in the space environment (26). Please refer to NASA Handbook 4002A, Appendix D.7 “Dielectric Constant, Time Constant” page 138 for determining the leakage time constant.

### Polylactic Acid (PLA)

PLA is the most common filament used in AM and table 6-7 lists several PLA filaments. It exhibits very low shrinkage and is extremely easy to print because it does not require a heated bed or build chamber and requires a relatively low extruder (nozzle) temperature. It also has low offgassing during printing, important in open-frame AM systems in rapid prototyping environments such as lab settings. Unless the application has a very short-term exposure to harsh conditions, and if the conditions are well characterized and controlled, it is not recommended to use PLA for an application beyond TRL 3-4. For laboratory settings in controlled environments not subject to excessive mechanical forces, ESD-compatible filaments are available.

Filament Name (Citation)	ISO 75/ASTM D648 Deflection Temp (°C)	ISO 179-1 Hardness (kJ/m <sup>2</sup> ) or Izod D256-10A (J/m)	ISO 527-1/ASTM D638 ZX Tensile strength (MPa)	ASTM D790/ISO 178 Flexural strength (MPa)	Nozzle Temp (°C)	Bed Temp (°C)	Density (g/cc)	Volume Resistivity (Ω-cm)
Prusament PLA	55	12 kJ/m <sup>2</sup>	57	N/A	215	50-60	1.24	--
Verbatim PLA	50	16 kJ/m <sup>2</sup>	63	N/A	210	50-60	1.24	--
ColorFabb PLA-PHA (27)	N/A	30 kJ/m <sup>2</sup>	61	89	210	50-60	1.24	--
Stratasys PLA (28)	51	27 kJ/m <sup>2</sup>	26	84	N/A	N/A	1.264	10 <sup>15</sup>
3DXSTAT™ ESD-PLA	55	N/A	55	95	210	23-60	1.26	10 <sup>6</sup> -10 <sup>9</sup>





### Acrylonitrile Butadiene Styrene (ABS)

ABS has traditionally been the choice for higher strength, lightweight prints from the Fused Deposition Modeling (FDM) process in the open-source community. It is generally temperature resistant and UV resistant, but turns yellow and eventually becomes more brittle over time when exposed to sunlight. It is a marginally difficult filament to print, especially in open-frame systems. High temperature gradients during printing may cause warping as parts get larger. Enclosed AM systems with heated chambers print ABS well. Additionally, ABS shrinks 1 to 2 percent of its printed size upon cooling – the shrinkage varies from manufacturer to manufacturer. ABS has flown as the complete structure for KickSat-2, a FemtoSat deployer for chip-scale satellites (68). The single-use, short mission duration, and intricate dispenser frame made a conventionally machined deployer mass- and cost-prohibitive. Table 6-8 lists some examples of ABS filaments.

Filament Name	ISO 75/ASTM D648 Deflection Temp (°C)	ISO 179-1 Hardness (kJ/m <sup>2</sup> ) or Izod D256-10A (J/m)	ISO 527-1/ASTM D638 Tensile strength (MPa)	ASTM D790/ISO 178 Flexural strength (MPa)	Nozzle Temp (°C)	Bed Temp (°C)	Density (g/cc)	Volume Resistivity (Ω-cm)
Stratasys ABS-CF10	100	20-51 J/m	21	29-69	N/A	N/A	1.0972	10 <sup>4</sup> -10 <sup>9</sup>
Stratasys ABS-ESD7	105	36.2 J/m	35	44	N/A	N/A	1.07	10 <sup>4</sup> -10 <sup>9</sup>
3DXSTAT <sup>™</sup> ESD-ABS	97	N/A	58	80	230	110	1.09	10 <sup>6</sup> -10 <sup>9</sup>
Verbatim ABS	106 (ISO 306)	21 J/m	47	78	240-260	90	1.05	--

### Nylon

Versatile and tough, there are multiple formulations for nylon that allow for a very wide range of applications and material properties. In general, nylon is more difficult to manufacture than ABS on open-source FFF systems due to the need for an enclosure for thermal stability and additional bed preparation due to the need for higher adhesion. Secondary structural pieces have been flown through the TechEdSat program using Markforged Onyx carbon fiber filaments. Table 6-9 lists some examples of nylon filaments.



Filament Name (Citation)	ISO 75/ASTM D648 Deflection Temp (°C)	ISO 179-1 Hardness (kJ/m <sup>2</sup> ) or Izod D256-10A (J/m)	ISO 527-1/ASTM D638 ZX Tensile strength (MPa)	ASTM D790/ISO 178 Flexural strength (MPa)	Nozzle Temp (°C)	Bed Temp (°C)	Density (g/cc)	Volume Resistivity (Ω-cm)
Taulman3D Alloy 910 (29)	82	N/A	56	N/A	250-255	30-65	N/A	--
Taulman3D Alloy 910 HDT (29)	112	N/A	56	N/A	285-300	55	N/A	--
Taulman3D Nylon 680 Food Grade (30)	N/A	N/A	47	N/A	250-255	30-65	N/A	--
Markforged Onyx ESD 316)	138	44 J/m	52	83	N/A	N/A	1.2	10 <sup>5-10</sup> <sup>7</sup>
3DXTECH CARBONX™ HTN+CF (32)	240	N/A	87	95	295	130	1.24	10 <sup>9</sup>
Stratasys Nylon 12 (33)	92-95	71-138 J/m	33-42	55-57	N/A	N/A	1.01	10 <sup>13</sup>

### Polycarbonate (PC)

Also known as Lexan™, this thermoplastic has some of the highest impact resistance, tensile strength, and temperature resistance available for most open source-based AM systems. After manufacturing, it is dimensionally stable and very stiff. However, it is difficult to print on open-frame, open-source AM systems due to very high warping especially when printing large components. Very high bed and nozzle temperatures are required, and poor adhesion to the bed is a typical issue. It is also highly hygroscopic; if possible, filament should be baked out before printing, or should be kept in a dedicated dry box while printing. Certain filaments, like the Prusament PC Blend, have additives to mitigate some of the difficulties of printing PC. If PC is desired for a smallsat structure, it should be printed on a commercial AM system. Table 6-10 lists some polycarbonate filaments.



Table 6-10: Polycarbonate Filaments								
Filament Name (Citation)	ISO 75/ASTM D648 Deflection Temp (°C)	ISO 179-1 Hardness (kJ/m <sup>2</sup> ) or Izod D256-10A (J/m)	ISO 527-1/ASTM D638 ZX Tensile strength (MPa)	ASTM D790/ISO 178 Flexural strength (MPa)	Nozzle Temp (°C)	Bed Temp (°C)	Density (g/cc)	Volume Resistivity (Ω-cm)
Prusament PC Blend (34)	113	No break for ISO 179	63	88-94	275	110	1.22	--
Prusament PC Blend Carbon Fiber (35)	114	35 kJ/m <sup>2</sup>	55-65	85-106	285	110	1.16	--
Stratasys PC (36)	143	27-77 J/m	60	75	N/A	N/A	1.20	--

### Windform

Manufactured by CRP USA, these proprietary materials are classified as a carbon fiber reinforced polymer originally designed for the automotive racing industry. They are unique in that these composites are manufactured through SLS (43). This results in higher dimensional stability and more isotropic properties than FFF. Windform XT 1.0 and 2.0 have been used on CubeSat and PocketQube platforms and have flight heritage through KySat-2 launched on ELaNa IV, and TANCREDO-1, launched through the ISS via JEM in 2017 (37). Table 6-11 lists CRP Windform filaments.

Table 6-11: CRP Windform								
Filament Name (Citation)	ISO 75/ASTM D648 Deflection Temp (°C)	ISO 179-1 Hardness (kJ/m <sup>2</sup> ) or Izod D256-10A (J/m)	ISO 527-1/ASTM D638 ZX Tensile strength (MPa)	ASTM D790/ISO 178 Flexural strength (MPa)	Manufacturing process	Bed Temp (°C)	Density (g/cc)	Volume Resistivity (Ω-cm)



Windform XT 2.0 (38)	173	4.72 kJ/m <sup>2</sup>	84	133	N/A, SLS	N/A, SLS	1.097	10 <sup>8</sup>
Windform RS (39)	181	10.8 kJ/m <sup>2</sup>	48-85	139	SLS	SLS	1.10	10 <sup>8</sup>

### Polyetherimide

PEI, also known by the Saudia SABIC trade name Ultem™, is a very tough thermoplastic resin with high thermal and chemical stability. It is inherently flame-resistant and can be machined. Some formulations of PEI are FAA-approved for flame, smoke, and toxicity (FST), and may also have ESD formulations. PEI is also known for extremely low offgassing, crucial in optical and sensitive scientific packages. PEI is a common bed material for higher end open-source FFF systems due to its adhesive properties with other thermoplastics at higher temperatures. PEI has similar characteristics to polyetheretherketone (PEEK). Due to these similarities, PEI is only practically printable on commercial FFF systems. Table 6-12 lists some PEI filaments.

Filament Name (Citation)	ISO 75/ASTM D648 Deflection Temp (°C)	ISO 179-1 Hardness (kJ/m <sup>2</sup> ) or Izod D256-10A (J/m)	ISO 527-1/ASTM D638 ZX Tensile strength (MPa)	ASTM D790/ISO 178 Flexural strength (MPa)	Nozzle Temp (°C)	Bed Temp (°C)	Density (g/cc)	Volume Resistivity (Ω-cm)
THERMAX™ Ultem™ 9085	158	N/A	63	90	275	115	1.34	--
3DXSTAT™ Ultem™ 1010 CF-ESD (40)	205	N/A	62	115	395	150	1.34	10 <sup>7</sup> -10 <sup>9</sup>
Stratasys Ultem™ 1010 CG (41)	212	22-27 J/m	81	82-128	N/A	N/A	1.29	10 <sup>14</sup>
Stratasys Ultem™ 9085 (41)	153	39-88 J/m	69	80-98	N/A	N/A	1.27	10 <sup>15</sup>
Zortrax Z-PEI 9085 (42)	186	N/A	54	90	N/A	N/A	1.34	--



## PAEK

Polyetheretherketone (PEEK) and polyetherketoneketone (PEKK) – in the polyaryletherketone (PAEK) family – are the highest performing thermoplastics developed as of writing. With certain additives and matrix materials, they can rival the strength of stainless steel and withstand over 200°C continuously in some formulations, after annealing. PEEK/PEKK are naturally flame-retardant; they are accepted for use in aviation ducting. They also achieve extremely low offgassing in operation, which makes these thermoplastics good candidates for compatibility with optical components in space. Due to the extreme conditions required for manufacturing and the very high filament cost, these materials are only practically available for printing in extremely robust commercial FFF systems with sealed and heated chambers. PEEK has heritage on long-term, external ISS experiments, and structural elements on the Juno spacecraft, making it suitable for extreme radiation environments (42). Table 6-13 lists some PAEK-based filaments.

Filament Name (Citation)	ISO 75/ASTM D648 Deflection Temp (°C)	ISO 179-1 Hardness (kJ/m <sup>2</sup> ) or Izod D256-10A (J/m)	ISO 527-1/ASTM D638 ZX Tensile strength (MPa)	ASTM D790/ISO 178 Flexural strength (MPa)	Nozzle Temp (°C)	Bed Temp (°C)	Density (g/cc)	Volume Resistivity (Ω-cm)
3DXSTAT™ ESD-PEEK (44)	140	N/A	105	141	380-400	150	1.32	10 <sup>7</sup> -10 <sup>9</sup>
3DXSTAT™ ESD-PEKK	185	N/A	109	135	375	140	1.34	10 <sup>7</sup> -10 <sup>9</sup>
CarbonX™ CF PEKK-Aerospace	285	N/A	126	178	390	140	1.33	10 <sup>7</sup>
Stratasys Antero 840 (45)	150	28-43 J/m	95	87-139	N/A	N/A	1.27	10 <sup>4</sup> -10 <sup>9</sup>
Zortrax Z-PEEK (42)	160	N/A	100	130	N/A	N/A	1.30	--

## Photopolymers

Otherwise known as “thermosets,” these materials are liquid polymers cured by an optical and thermal process. Compared to other AM processes, photopolymers and their manufacturing



processes allow for superior isotropic material properties, very high resolution, and the ability to manufacture optical quality parts. Some formulations, especially from 3D Systems and Stratasys, are designed for extreme temperature resistance and strength, desirable in aerospace applications. In some cases, the listed heat deflection temperature (HDT) may be superior to those of PAEK. As previously discussed, there are three major methods of curing photopolymers, one of which is proprietary. Many photopolymers are specifically paired for commercial systems. As a result, the following table includes the commercial system associated with the photopolymer.

Some of the photopolymers listed below have several additional characteristics not listable in this table, including, but not limited to, elasticity, tear strength, optical clarity, water absorption, and medical grade certifications. Such characteristics may be useful for biological experiments in future SmallSats. Please consult the products' specific websites and datasheets for additional information. Additionally, photopolymers have the advantage of being able to be mixed, in-situ, as the object is being manufactured. This allows for continuously varying material properties throughout the object. Table 6-14 lists some photopolymers.

<b>Table 6-14: Photopolymers</b>							
Photopolymer Name (Citation)	ISO 75/ASTM D648 HDT (°C)	ISO 179-1/ASTM D256-10A (J/m)	ISO 527-1/ASTM D638 Tensile (MPa)	ASTM D790 Flexural (MPa)	Density (g/cc) at 25°C	ESD Risk (Ω-cm)	Manufacturing and/or Machine Type
Accura Bluestone (46)	267-284	13-17	66-68	124-154	1.78	ND	3D Systems ProX 800
VisiJet M2S-HT250 (47)	250	10	51	83	1.15	ND	3DS MJP 2500 Plus
DSM Somos® Watershed XC	50	25	50	69	1.12	ND	Stratasys V650 Flex SL
Henkel LOCTITE® IND402 A70 Flex (48, 49)	N/A	N/A	5.5	N/A	1.068	ND	Several
Henkel LOCTITE® 3D 3843 (48)	80	54	60	81	N/A	ND	DLP SLA types only

### 6.3.3 AM Design Optimization

Design optimization is an integral part of manufacturing validation and testing. As previously discussed for AM, validation, testing, and optimization encompass all materials and manufacturing processes. Software platforms, especially those that integrate toolpathing



generation, computer aided manufacturing (CAM), load analysis, and fill generation, help speed up this process. The inherent advantage of AM to allow monolithic structural elements implies a much-expanded design space compared to subtractive manufacturing. Software has kept up with the pace of manufacturing advances and incorporates tools to assist with AM designs.

The manufacturing ecosystem includes software ranging from simple CAM solutions generating toolpaths (G-code) to complete, structural analysis and high-fidelity manufacturing simulations. As of writing, AM has gained significant traction and value in low-TRL demonstrations and physical validation, partly due to the ease of fabrication in typical AM ecosystems. It is beginning to displace traditional machining – “subtractive” manufacturing – as AM systems have matured enough to print advanced thermoplastics, resins, and metals.

### **Infill Patterns**

Due to the flexibility that AM offers, new methods of lightweighting are now possible. “Lightweighting” refers to the reduction of mass of structural elements, without compromising structural integrity. The best examples of well-proven heritage methods of lightweighting are “honeycomb” sandwiched aluminum panels, subtractive machining, and truss structures. However, such methods have certain limitations. Honeycomb panels for example, do not have uniform, or isotropic, properties – they do not exhibit the same stiffness in all directions.

Lightweighting in AM encompasses what is called “infill,” or the internal structure of a hollow body or panel. With a minimal increase in mass, an internal structure manufactured with AM can vastly increase the strength of a body. Very recently, the AM community has renewed interest in the use of the gyroid pattern, discovered by NASA researcher Alan Schoen in 1970, due to the ease of generation in AM toolpath programs. Aside from honeycomb and gyroids, several options for infill exist. Different options are offered with different AM-focused software packages.

### **Digital Materials**

Both honeycomb panels and AM parts with infill have a common repetitive unit cell. By repeating this unit cell throughout the interior of a part, or as a structure on its own, a larger structure can be made. Further, by defining properties into this unit cell, information can effectively be encoded into the design, allowing for differing behavior of different parts of the structure. Digital materials can dramatically expand the design space of a structure, allowing for targeted optimization of various properties such as mass to strength ratios, structural lightweighting, and others. As previously discussed, with certain resin polyjet AM centers, resins can be mixed in real time to form an object that has continuously varying properties.

## **6.4 Radiation Effects and Mitigation Strategies**

### **6.4.1 Shielding from the Space Environment**

Radiation Shielding has been described as a cost-effective way of mitigating the risk of mission failure due to total ionizing dose (TID) and internal charging effects on electronic devices. In space mission analysis and design, the average historical cost for adding shielding to a mission is below 10% of the total cost of the spacecraft (50). The benefits include reducing the risk of early total ionizing dose electronics failures (51). Some of the key CubeSat and SmallSat commercial electronic semiconductor parts include processors, voltage regulators, and memory devices, which are key components in delivering science and technology demonstration data (52).

Shielding the spacecraft is often the simplest method to reduce both a spacecraft’s ratio of total ionizing dose to displacement damage dose (TID/DDD) accumulation, and the rate at which single event upsets (SEUs) occur if used appropriately. Shielding involves two basic methods: shielding



with the spacecraft's pre-existing mass (including the external skin or chassis, which exists in every case whether desired or not), and spot/sector shielding. This type of shielding, known as passive shielding, is only very effective against lower energy radiation, and is best used against high particle flux environments, including the densest portions of the Van Allen belts, the Jovian magnetosphere, and short-lived solar particle events. In some cases, increased shielding is more detrimental than if none was used, owing to the secondary particles generated by highly penetrating energetic particles. Therefore, it is important to analyze both the thickness and type of materials used to shield all critical parts of the spacecraft. Due to the strong omni-directionality of most forms of particle radiation, spacecraft need to be shielded from the full  $4\pi$  steradian celestial sphere. This brings the notion of "shielding-per-unit-solid-angle" into the design space, where small holes or gaps in shielding are often only detrimental proportionally to the hole's solid angle as viewed by the concerned electrical, electronic and electro-mechanical (EEE) components. Essentially, completely enclosing critical components should not be considered a firm design constraint when other structural considerations exist.

### 6.4.2 Inherent Mass Shielding

Inherent mass shielding consists of using the entirety of the pre-existing spacecraft's mass to shield sensitive electronic components that are not heavily dependent on location within the spacecraft. This often includes the main spacecraft bus processors, power switches, etc. Again, the notion of "shielding-per-unit-solid-angle" is invoked here, where a component could be well shielded from its "backside" ( $2\pi$  steradian hemisphere) and weakly shielded from the "front" due to its location near the spacecraft surface. It would only then require additional shielding from its front to meet operational requirements. The classic method employed here is to increase the spacecraft's structural skin thickness to account for the additional shielding required. This is the classic method largely due to its simplicity, where merely a thicker extrusion of material is used for construction. The disadvantage to this method is the material used, very often aluminum, is mass optimized for structural and surface charging concerns and not for shielding either protons/ions or electrons. Recent research has gone into optimizing structural materials for both structural and shielding concerns and is currently an active area of NASA's Small Business Innovation Research (SBIR) program research and development.

The process to determine exactly how much inherent shielding exists involves using a reverse ray tracing program on the spacecraft solid model from the specific point(s) of interest. After generating the "shielding-per-unit-solid-angle" map of the critical area(s) of the spacecraft, a trade study can be performed on what and where best to involve further additional shielding.

Numerous CubeSat and SmallSat systems use commercial, processors, radios, regulators, memory, and SD cards. Many of these products rely on silicon diodes and metal oxide semiconductor field effect transistors (MOSFETs) in these missions. A comprehensive NASA guidance document on the use of commercial electronic parts was published for the ISS orbit, which is a low-Earth orbit where the predominant radiation source is the South Atlantic Anomaly. The hardness of commercial parts was noted as having a range from 2 – 10 kRad (54). For typical thin CubeSat shielding of 0.20 cm (0.080 in) aluminum, yearly trapped dose is 1383 Rad; with an additional estimated 750 Rad from solar particle events, the total dose increases to 2133 Rad for the ELaNaXIX Mission environment at 85 degrees inclination and 500 km circular orbit (table 6-9) (53). Adding a two-fold increase for the trapped belt radiation uncertainty brings the total radiation near the TID lifetime of many commercial parts (54), even before estimating a SPE TID contribution. The uncertainty of radiation model results of low-earth orbit below 840 km has been estimated as at least two-fold; Van Allen Belt models are empirical and rely on data in the orbital environment (55). The NASA Preferred Reliability Series "Radiation Design Margin Requirements" also recommends a radiation design margin of 2 for reliability (56). Currently, The

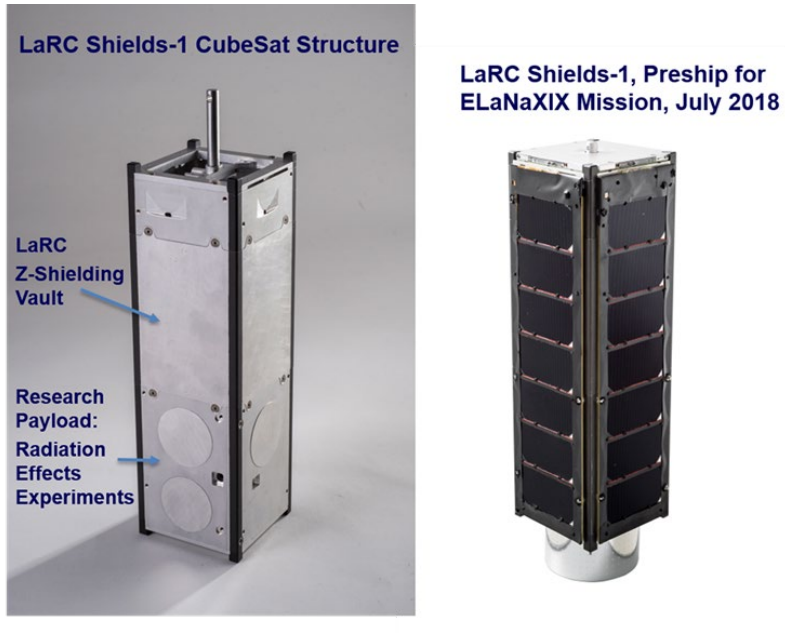




Aerospace Corporation proton (AP) (57) and The Aerospace Corporation electron (AE) (58) Models do not have radiation data below 840 km, and radiation estimates are extrapolated for the lower orbits (55). For spacecraft interplanetary trajectories near the sun or Earth, the radiation contributions from SPEs will be higher than low-Earth orbit, where there is some limited SPE radiation protection by the magnetosphere. By reducing the total ionizing dose on commercial parts, the mission lifetimes can be increased by reducing the risk of electronic failures on sensitive semiconductor parts.

### 6.4.3 Shields-1 Mission, Radiation Shielding for CubeSat Structural Design

Shields-1 has operated in polar low-Earth orbit and was launched through the ELaNaXIX Mission in December 2018. The Shields-1 mission increased the development level of atomic number (Z) Grade Radiation Shielding with an electronic enclosure (vault) and Z-grade radiation shielding slabs with aluminum baselines experiments (figure 6.15) (59). Preliminary results in table 6-9 show a significant reduction in total ionizing dose in comparison to typical modeled 0.20 cm (0.080 in) aluminum structures sold by commercial CubeSat providers. The 3.02 g cm<sup>-2</sup> Z-Shielding vault has over 18 times reduction in total ionizing dose compared to modeled 0.20 cm aluminum shielding (53).



Shields-1 structure and Final Preship Picture with LaRC Z-Shielding Vault and Experiment, Solar Panels and Thermal Radiator

Figure 6.15: Shields-1 Z-shielding structure and final Preship picture, ELaNaXIX Mission. Credit: NASA.

Z-shielding enables a low volume shielding solution for CubeSat and SmallSat applications where reduced volume is important. AlTiTa, Z-shielding, at 2.08 g cm<sup>-2</sup> reduces the dose from a SPE by half when compared to a standard 0.2 cm aluminum structure (figure 6.16). NASA has innovated “Methods of Making Z-Shielding” with patents in preparing different structural shieldings (60-63), from metals to hybrid metal laminates and thin structural radiation shielding, to enable low-volume integrated solutions with CubeSats and SmallSats (64).

Table 6-9. Shields-1 Experimental Total Ionizing Dose Measurements in PLEO				
Shielding	Areal Density (g/cm <sup>2</sup> )	Thickness (cm)	Trapped Belts TID Total (Rad (Si)/Year)	SPE King Sphere Model, (Rad (Si))
Al	0.535	0.198	1383+/-47 #	750+/-5
Al	1.26	0.465	<b>90.9 +/-2.7 (SL)</b>	432 +/- 7



Al	1.69	0.624	<b>84.3 +/-2.5 (SL)</b>	345 +/- 9
Al	3.02	1.11	<b>73.6 +/-3.2 (SL)</b>	183 +/- 11
AlTi	1.33	0.378	<b>89.7 +/-2.7 (SL)</b>	451 +/- 6
AlTiTa20	2.08	0.429	<b>84.3 +/-2.5 (SL)</b>	338 +/- 6
AlTiTa40	3.02	0.483	<b>81.9 +/-3.4 (SL) 75.6+/-3.2 (Vault)</b>	253 +/- 6

Table 6-9. Shields-1 Experimental total ionizing dose measurements in PLEO in comparison to typical 0.20 cm aluminum shielding commercially available for CubeSats and SPE additional contributions to dose. **Bold values** Shields-1 experimental results. SL = Slab, Vault = Z-Shielding electronics enclosure. # sphere Space Environment Information System (SPENVIS) Multi-layered Shielding Simulation Software (MULASSIS) AP8 Min AE8 Max modeled results. SPE King Sphere Model SPENVIS MULASSIS modeled results.

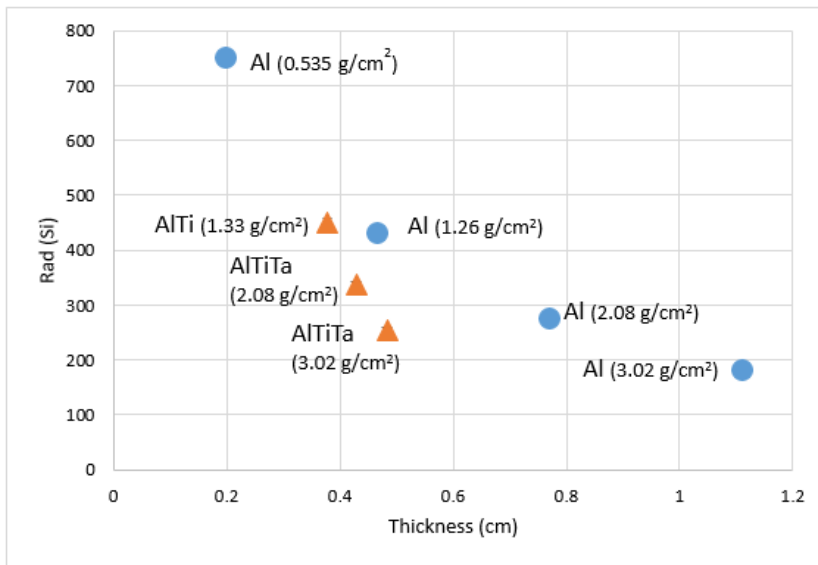


Figure 6.16: SPE Contribution to TID in PLEO, King Sphere Model, ELaNaXIX Shields-1 orbit. Credit: NASA.

### 6.4.4 Ad Hoc Shielding

There are two types of ad hoc shielding used on spacecraft: spot shielding, where a single board or component is covered in shield material (often conformally), and sector shielding, where only critical areas of the spacecraft have shielding enhancement. These two methods are often used in concert as necessary to further insulate particularly sensitive components without unnecessarily increasing the overall shield mass and/or volume. Ad hoc shielding is more efficient per unit mass than inherent mass

shielding because it can be optimized for the spacecraft’s intended radiation environment while loosening the structural constraints. The most recent methods include: multiple layer shields with layer-unique elemental atomic numbers which are layered advantageously (often in a low-high-low Z scheme), known as “graded-Z” shielding, and advanced low-Z polymer or composite mixtures doped with high-Z, metallic micro-particles. Low-Z elements are particularly capable at shielding protons and ions while generating little secondary radiation, where high Z elements scatter electrons and photons much more efficiently. Neutron shielding is a unique problem, where optimal shield materials often depend on the particle energies involved. Commercial options include most notably Tethers Unlimited’s VSRS system for small spacecraft, which was specifically designed to be manufactured under a 3D printed fused filament fabrication process for conformal coating applications (a method which optimizes volume and minimizes shield gaps).

### 6.4.5 Charge Dissipation Coating

The addition of conformal coatings over finished electronic boards is another method to mitigate electrostatic discharge on sensitive electronic environments. Arathane, polyurethane coating materials (65), and HumiSeal acrylic coatings (66) have been used to mitigate discharge and provide limited moisture protection for electronic boards. This simple protective coating over sensitive electronic boards supports mission assurance and safety efforts. Charge dissipation films have decreased electrical resistances in comparison to standard electronics and have been described by NASA as a coating that has volume resistivities between  $10^8 - 10^{12}$  ohm-cm. In comparison, typical conformal coatings have volume resistivities from  $10^{12} - 10^{15}$  ohm-cm (26).

### 6.4.6 LUNA Innovations, Inc. XP Charge Dissipation Coating

The XP Charge Dissipation Coating has volume resistivities in the range of  $10^8 - 10^{12}$  ohm-cm (table 6-9) and is currently developing space heritage through the NASA MISSE 9 mission and Shields-1 (67). The XP Charge Dissipation Coatings were developed through the NASA SBIR program from 2010 to present for extreme electron radiation environments, such as Outer Planets, medium Earth, and geostationary orbits, to mitigate charging effects on electronic boards.

Table 6-10: XP Charge Dissipation Coating and Commercial Conformal Coating Resistivity Comparisons	
Material	Volume Resistivity (Ohm-cm)
XP Charge Dissipation Coating	$10^8 - 10^{12}$ , $4.7 \times 10^9$ at 25°C
Arathane 5750 A/B	$9.3 \times 10^{15}$ at 25°C, $2.0 \times 10^{13}$ at 95°C
Humiseal 1B73	$5.5 \times 10^{14}$ Ohms (Insulation Resistance per MIL-I-46058C)

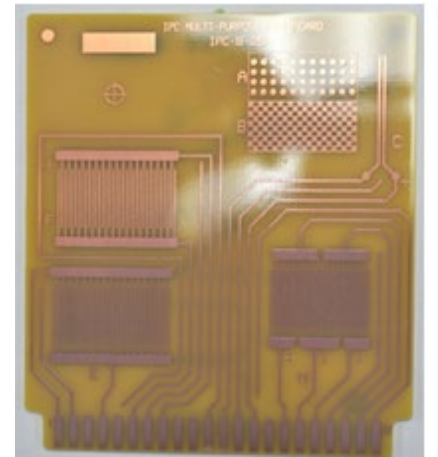


Figure 6.17: Transparent LUNA XP Charge Dissipation Coating on an Electronic Board. Credit: LUNA Innovations, Inc.

The LUNA XP Charge Dissipation Coating has reduced resistance compared to typical commercial conformal coatings as shown in table 6-10, which reduces surface charging risk on electronic boards. LUNA XP Coating (figure 6.17) on an electronic board has transparency for visual parts inspection. For extreme radiation environments, a combination of radiation shielding and charge dissipation coating reduces the ionizing radiation that contributes to charging and provides a surface pathway for removing charge to ground (26).

## 6.5 Summary

The Structures, Materials, and Mechanisms chapter was revised in 2020 to include custom structure references with the dimensional and material requirements of integrating deployment systems. The chapter has been updated with the current status of structures, materials, and mechanisms for small satellite missions. The Mechanisms section has been updated with new technology. In 2020, a radiation environment section was revised with radiation shielding considerations for orbits and solar maximum with references for commercial parts and radiation design margin. State-of-the-art radiation shielding and charge dissipation materials have been updated.



Reflecting the fast pace of developments in additive manufacturing, a new section was added in 2021 with a wide sampling of available thermoplastics and resin-based materials suitable for different TRL levels. To complement additive manufacturing, a new section was added to bring attention to the increasing importance of design optimization.

For feedback solicitation, please email: [arc-sst-soa@mail.nasa.gov](mailto:arc-sst-soa@mail.nasa.gov). Please include a business email so someone may contact you further.

## References

- (1) Space Weather Prediction Center. Solar Cycle 25 Forecast Update. [Online] 12 19, 2019. <https://www.swpc.noaa.gov/news/solar-cycle-25-forecast-update>.
- (2) Pumpkin, Inc. CubeSat Kit Structures. *Pumpkin Space Systems*. [Online] 2017.
- (3) AAC Clyde Space. CS 3U CubeSat Structure. *Clyde Space*. [Online] 2018.
- (4) NanoAvionics. NanoAvionics Structural Components. *NanoAvionics*. [Online] 2018.
- (5) GomSpace. GomSpace's fourth Demonstration Mission is Successfully Launched – intended to Pioneer the Advanced. [Online] 2018. <https://gomspace.com/news/gomspaces-fourth-demonstration-mission-is-suc.aspx>.
- (6) Endurosat. 2017. "CubeSat-3u-structure." Accessed July 15, 2018. <https://www.endurosat.com/products/CubeSat-3u-structure/>.
- (7) Complex Systems & Small Satellites. C3S CubeSat Structure. *Complex Systems & Small Satellites*. [Online] 2018.
- (8) ELMA Electronic: "OpenVPX: VITA 65 Family of Standards." [Online]. 2021. [Cited: June 17, 2021].
- (9) NASA Goddard Spaceflight Center: "SpaceCube v3.0 Mini: NASA Next-Generation Data-Processing System for Advanced CubeSat Applications." June 2019. NASA Electronic Parts and Packaging (NEPP) Program 2019 Electronics Technology Workshop.
- (10) P. Collier and M. walmsley: "SpaceVPX and the world of interconnect." [Online]. June 18, 2020. [Cited: July 12, 2021]. <https://militaryembedded.com/unmanned/connectors/spacevpx-and-the-world-of-interconnect>
- (11) NASA Goddard Technical Standards, "GSFC General Environmental Verification Standard (GEVS) for GSFC Flight Programs and Projects", GSFC-STD-7000B, 28 April 2021.
- (12) Tyvak. "Launch Services". [Online] 2021. [Accessed: August 24, 2021]. <https://www.tyvak.com/launch-services/>
- (13) Planetary Systems Coporation. "Canisterized Satellite Dispenser." [Online]. [Accessed: August 28, 2021]. <https://www.planetarysystemscorp.com/product/canisterized-satellite-dispenser/>
- (14) ISISPACE. CubeSat Deployers. <https://www.cubesatshop.com/wp-content/uploads/2016/07/ISIS-CubeSat-deployers-Brochure-v2-compressed.pdf>
- (15) Composite Technology Development: "STELOC Composite Booms. *Composite Technology Development*." 2018. [Online].
- (16) Reveles, J., et al.: "In-Orbit Performance of AstroTube: AISat Nano's Low Mass Deployable Composite Boom Payload." Logan, UT : s.n., 2017. 31st Annual AIAA/USU Conference of Small Satellites.
- (17) Redwire Space: "CubeSat Boom Deployer."



- (18) NASA: "Deployable Composite Booms (DCB)." [Online]. August 26, 2020. [Cited May 18, 2021].  
[https://www.nasa.gov/directorates/spacetech/game\\_changing\\_development/projects/dc](https://www.nasa.gov/directorates/spacetech/game_changing_development/projects/dc)
- (19) Wenberg, D. L., B. P. Keegan, M. E. Lange, E. A. S. Hanlon, and J. S. Kang. 2016. "RSat Flight Qualification and Test Results for Manipulable Robotic Appendages Installed on 3U CubeSat Platform." *30th Annual AIAA/USU Conference on Small Satellites*. Logan, UT.
- (20) Knight, A. N., T.R. Tetterton, A.J. Engl, P.M. Sinkovitz, B.J. Ward, J.S. Kang, "Design and Development of On-orbit Servicing CubeSat-class Satellite", 34h AIAA/USU Conf. on Small Sat SSC20-V-01, 1-6 August 2020, Logan, UT
- (21) Tethers Unlimited, Inc. Cobra Gimbal. *Tethers Unlimited*. [Online] 2018.
- (22) NASA. COBRA-Bee Carpal-Wrist Gimbal for Astrobee. [Online] February 2017. [Cited: July 18, 2018.] <https://www.sbir.gov/sbirsearch/detail/1426639>.
- (23) Tethers Unlimited. 2018. "KRAKEN Robotic Arm." Accessed July 2018. [http://www.tethers.com/SpecSheets/Brochure\\_KRAKEN.pdf](http://www.tethers.com/SpecSheets/Brochure_KRAKEN.pdf).
- (24) Honeybee Robotics. CubeSat Solar Array Drive Assembly. *Honeybee Robotics*. [Online] 2018.
- (25) Ensign-Bickford Aerospace & Defense. TiNi™ Mini Frangibolt® Actuator: Small, Simple, Powerful. [Online] 2020. <https://www.ebad.com/tini-mini-frangibolt>.
- (26) NASA: Technical Handbook, "Mitigating In-Space Charging Effects – A Guideline." NASA-HDBK-4002A. October 19, 2017.
- (27) ColorFabb: Technical Datasheet, "PLA/PHA". April 8, 2020.
- (28) Stratasys: Datasheet, "PLA: Economy Thermoplastic for Stratasys F123 Series Printers." 2018
- (29) Taulman3D: "Alloy 910 Specifications ." [Online] [Cited July 12, 2021].  
<https://taulman3d.com/alloy-910-spec.html>
- (30) Taulman3D: "Alloy 680 Specifications ." [Online] [Cited July 12, 2021].  
<https://taulman3d.com/nylon-680-spec.html>
- (31) Markforged: Datasheet, "Onyx ESD™." [Online] [Cited July 12, 2021].  
<https://markforged.com/materials/plastics/onyx-esd>
- (32) 3DXTech Additive Manufacturing: "CARBONX HTN+CF [HIGH TEMP CF NYLON]." [Online] [Cited July 12, 2021]. <https://www.3dxtech.com/product/carbonx-htn-cf/>
- (33) Statasys: "Nylon 12." [Online] [Cited July 12, 2021].  
<https://www.stratasys.com/materials/search/fdm-nylon-12>
- (34) Prusa Polymers: Technical Datasheet, "Prusament PC Blend."
- (35) Prusa Polymers: Technical Datasheet, "Prusament PC Blend Carbon Fiber."
- (36) Stratasys: Datasheet, "PC (Polycarbonate): FDM Thermoplastic Filament." [Online] [Cited July 12, 2021]. [https://www.stratasys.com/-/media/files/material-spec-sheets/mds\\_fdm\\_pc\\_0920a.pdf](https://www.stratasys.com/-/media/files/material-spec-sheets/mds_fdm_pc_0920a.pdf)
- (37) CRP USA: "Windform 3D Printing materials launch into Orbit on KySat-2." [Online]. [Cited July 12, 2021] <https://www.crp-usa.net/windform-3d-printing-materials-launch-orbit-kysat-2/>
- (38) Winform: Technical Datasheet, "Winform XT 2.0" [Online] [Cited July 12, 2021].  
<http://www.windform.com/windform-xt-2-0.html>
- (39) Winform: Technical Datasheet, "Winform XT 2.0" [Online] [Cited July 12, 2021].  
<http://www.windform.com/windform-rs.html>



- (40) 3DXTech Additive Manufacturing: Technical Datasheet, “3DXSTAT™ ESD-Ultem™ 3D Printing Filament.”
- (41) Stratasys: “ULTEM™ 1010 Resin” [Online] [Cited July 12, 2021]. <https://www.stratasys.com/materials/search/ultem1010>
- (42) Zortrax: “Z-PEEL.” [Online] [Cited July 12, 2021]. <https://zortrax.com/filaments/z-peek/>
- (43) CRP Technology. 2018. “Vacuum Ultraviolet Light Exposure of Windform SP and Windform LX 3.0.”
- (44) 3DXTech Additive Manufacturing: Technical Datasheet, “3DXSTAT™ ESD-PEEK 3D Printing Filament
- (45) Stratasys: “Antero 840CN03 High-Performance PEKK-Based ESD Thermoplastic.” [Online] [Cited July 12, 2021]. <https://www.stratasys.com/materials/search/antero-840cn03>
- (46) BIBLIOGRAPHY 3D Systems Inc. 2015. “*Accura Bluestone Technical Data.*”
- (47) 3D Systems: “VisiJet M2S-HT250 (MJP).” [Online] [Cited June 24, 2021]. <https://www.3dsystems.com/materials/visijet-m2s-ht250>
- (48) Henkel Corporation, Loctite: Technical Datasheet, “IND402TM: PhotoElastic A70 High Rebound Black.” July 10, 2020.
- (49) Stratasys: “First in the USAF F-16 approval sprint challenge.” [Online] [Cited June 24, 2021]. <https://www.stratasys.com/explore/video/origin-one-aerospace>
- (50) Wertz, J. R., W. J. Larson. “Space Mission Analysis and Design, Third Edition.” Space Technology Library, Space Technology Series, Hawthorne, CA: Microcosm Press and New York: Springer, 1999, p.976.
- (51) Hastings, D., H. Garrett, “Spacecraft Environment Interactions.” New York, NY: Cambridge University Press, 1996, p.292.
- (52) Langer, M and Boumeester. “Reliability of CubeSats – Statistical Data, Developers’ Beliefs and the Way Forward”, 30<sup>th</sup> Annual AIAA/USU Conference on Small Satellites, August 2016, Logan, UT, SSC16-X-2, 1-12.
- (53) Thomsen, D.L., “Shields-1 Preliminary Radiation Shielding Dosimetry in Polar Low Earth Orbit”, Committee on Space Research (COSPAR), Small Satellites for Sustainable Science and Development, Herzliya, Israel, 7 November 2019.
- (54) NASA Preferred Reliability Series PD 1258, “Space Radiation Effects on Electronic Components in Low Earth Orbit”, August 1996.
- (55) Vampola, A. L. “The Space Particle Environment”, NASA/SDIO Space Environmental Effects on Materials Workshop, NASA Conference Proceedings 3035, part 2, NASA Langley Research Center, Hampton, VA June 28 – July 1, 1988, pg. 367.
- (56) NASA Preferred Reliability Series PD 1260, “Radiation Design Margin Requirement”, May 1996.
- (57) Sawyer, D. M., and J. I. Vette, AP-8 Trapped Proton Environment for Solar Maximum and Solar Minimum, NSSDC/WDC-A-R&S 76-06, 1976.
- (58) Vette, J. I., The AE-8 Trapped Electron Model Environment, NSSDC/WDC-A-R&S 91-24, 1991a.
- (59) Thomsen III, D.L., W. Kim, and J.W. Cutler. “Shields-1, A SmallSat Radiation Shielding Technology Demonstration”, 29th AIAA/USU Conf. on Small Sat., SSC15-XII-9, August 2015.
- (60) U.S. Patent No. 8,661,653, 4 March 2014, “Methods of Making Z-Shielding.” D.L. Thomsen III, R.J. Cano, B.J. Jensen, S.J. Hales, and J.A. Alexa.



- (61) U.S. Patent No. 10,039,217, 31 July 2018, "Methods of Making Z-Shielding." D.L. Thomsen III, R.J. Cano, B.J. Jensen, S.J. Hales, and J.A. Alexa.
- (62) U.S. Patent No. 10,600,52212, 24 March 2020, "Method of Making Thin Atomic (Z) Grade Shields", D.L. Thomsen III.
- (63) U.S. Patent No. 10,919,650, 16 February 2021, "Atomic Number (Z) Grade Shielding Materials and Methods of Making Atomic Number (Z) Grade Shielding." D.L. Thomsen III, S.N. Sankaran, and J.A. Alexa.
- (64) U.S. Patent No. 11,043,311, 22 June 2021, "Method of Making Atomic Number (Z) Grade Small SAT Radiation Shielding Vault", D.L. Thomsen III and W.R. Girard.
- (65) Arathane.  
[https://apps.huntsmanservice.com/WebFolder/ui/browse.do?pFileName=/opt/TDS/Huntsman%20Advanced%20Materials/English%20US/Long/Arathane%205750%20AB\\_LV\\_US\\_e.pdf](https://apps.huntsmanservice.com/WebFolder/ui/browse.do?pFileName=/opt/TDS/Huntsman%20Advanced%20Materials/English%20US/Long/Arathane%205750%20AB_LV_US_e.pdf)
- (66) Chase Electronic Coatings: "HumiSeal® 1B73 Acrylic Conformal Coating Technical Data Sheet." <https://chasecorp.com/humiseal1/wp-content/uploads/sites/12/2018/10/1B73-TDS.pdf>
- (67) LUNA: Blog: "Luna coating provides radiation protection in space." [Online]. February 2, 2018. [Cited June 28, 2020]. <https://lunainc.com/blog/luna-coating-provides-radiation-protection-space>
- (68) NASA: "What is KickSat-2?" [Online] June 3, 2019. [Cited July 12, 2021]. <https://www.nasa.gov/ames/kicksat>



## Chapter Contents

Glossary .....	ii
7.0 Thermal Control.....	183
7.1 Introduction .....	183
7.2 State-of-the-Art – Passive Systems .....	184
7.2.1 Paints, Coatings, and Tapes.....	186
7.2.2 Multi-layer Insulation.....	187
7.2.3 Thermal Straps .....	188
7.2.4 Thermal Interface Materials and Conductive Gaskets .....	190
7.2.5 Sunshields .....	191
7.2.6 Thermal Louvers.....	191
7.2.7 Deployable Radiators .....	191
7.2.8 Heat Pipes .....	192
7.2.9 Phase Change Materials/ Thermal Storage Units.....	193
7.2.10 Thermal Switches .....	194
7.2.11 Multifunctional Thermal Structures .....	194
7.3 State-of-the-Art – Active Systems .....	194
7.3.1 Heaters .....	195
7.3.2 Cryocoolers .....	195
7.3.3 Thermoelectric Coolers (TEC) .....	197
7.3.4 Fluid Loops .....	198
7.3.5 Active Thermal Architecture.....	198
7.4 Summary.....	199
References.....	199





## Chapter Glossary

(APG)	Annealed Pyrolytic Graphite
(ARC)	Ames Research Center
(ATA)	Active Thermal Architecture
(BIRD)	Bi-Spectral Infrared Detection
(CSE, USU)	Center for Space Engineering at Utah State University
(ESPA)	EELV Secondary Payload Adapter
(FEP)	Fluorinated Ethylene Propylene
(FETS)	Folding Elastic Thermal Surface
(FOX)	Flat-Plate Heat Pipe On-Orbit Experiment
(GFTS)	Graphite Fiber Thermal Straps
(GSFC)	Goddard Space Flight Center
(HEC)	High Efficiency Cooler
(IR)	Infrared
(ISS)	International Space Station
(KGS)	Kaneka Graphite Sheets
(MLI)	Multi-Layer Insulation
(MPFL)	Mechanically Pumped Fluid Loop
(MWIR)	Midwave Infrared
(NLAS)	Nanosatellite Launch Adapter System
(P-POD)	Poly-Picosatellite Orbital Deployer
(PFL)	Pumped Fluid Loop
(PGF)	Pyrovo Pyrolytic Graphite Film
(PGS)	Pyrolytic Graphite Sheets
(PRISM)	Portable Remote Imaging Spectrometer
( $q_{\text{albedo}}$ )	Solar heating reflected by the planet
( $Q_{\text{gen}}$ )	Heat generated by the spacecraft
( $Q_{\text{out,rad}}$ )	Heat emitted via radiation
( $q_{\text{planetshine}}$ )	IR heating from the planet



( $q_{\text{solar}}$ )	Solar heating
( $Q_{\text{stored}}$ )	Heat stored by the spacecraft
(SDL)	Space Dynamics Laboratory
(SI)	International System of Units
(SPOT)	Standard Passive Orbital Thermal-Control
(SST)	Small Satellite Technology
(TAFTS)	Two Arm Flexible Thermal Strap
(TEC)	Thermoelectric Coolers
(TMT)	Thermal Management Technologies
(TRL)	Technology Readiness Level
(TSU)	Thermal Storage Unit
(UAM)	Ultrasonic additive manufacturing
(ULP)	Ultra-Low Power

## 7.0 Thermal Control

### 7.1 Introduction

All spacecraft components have a range of allowable temperatures that must be maintained to meet survival and operational requirements during all mission phases. Spacecraft temperatures are determined by how much heat is input to, stored, and output from the spacecraft. Figure 7.1 shows a simplified overview of heat into and out of an orbiting satellite. The image shows the Earth as the orbited planet, but it applies to any planet or body a spacecraft is orbiting.  $Q_{gen}$ ,  $Q_{out,rad}$ , and  $Q_{stored}$  are represented as heat values, Watts in International System of Units (SI), whereas  $q_{solar}$ ,  $q_{albedo}$ , and  $q_{planetshine}$  are represented as heat fluxes, Watts per square meter in SI.

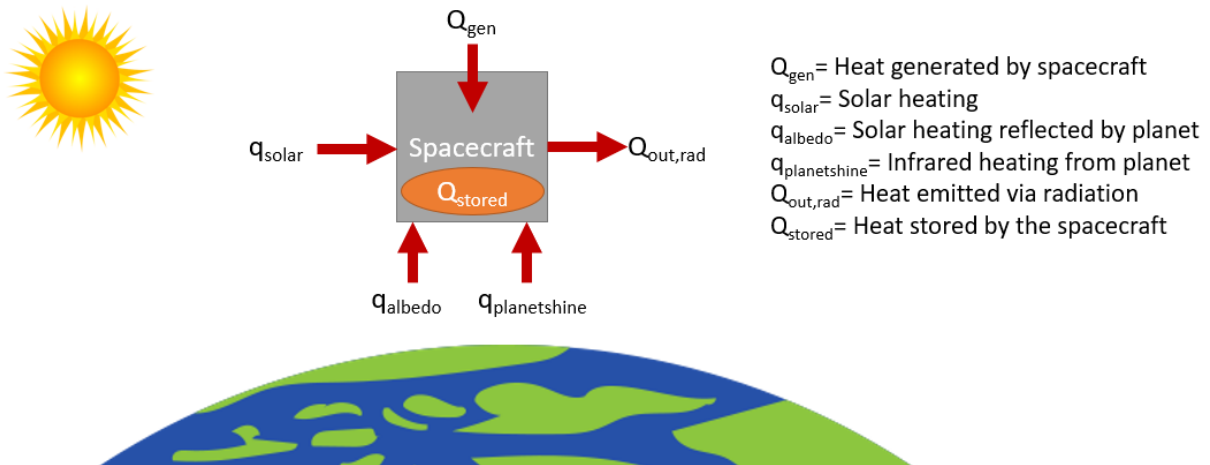


Figure 7.1: Orbiting spacecraft heating simplified overview. Credit: NASA.

The amount of heat absorbed, stored, and dissipated by the spacecraft depends on several factors, listed below. Solar absorptivity and infrared (IR) emissivity are surface optical properties referenced below and are described further in section 7.2.1: Paints, Coatings, and Tapes.

- $Q_{gen}$  (heat generated by the spacecraft) depends on the power and efficiency of spacecraft components.
- The amount of  $q_{solar}$  (solar heating) absorbed by the spacecraft depends on the solar flux, which is determined by distance to the sun, the surface area viewing the sun, and the solar absorptivity of that surface.
- The amount of  $q_{albedo}$  (solar heating reflected by the planet) absorbed by the spacecraft depends on the planet, the surface area viewing the planet, and the solar absorptivity of that surface.
- The amount of  $q_{planetshine}$  (IR heating from the planet) absorbed by the spacecraft depends on the planet, the surface area viewing the planet, and the IR emissivity of that surface.
- $Q_{out,rad}$  (heat emitted via radiation) depends on the surface area designated as radiator space, the IR emissivity of the surface, and the difference in temperature between the spacecraft radiator and the heat sink to which it is dissipating, typically and most effectively deep space.  $Q_{out,rad}$  may also include heat lost through insulation or other surfaces not specifically intended to function as radiators.
- $Q_{stored}$  (heat stored by the spacecraft), is based on the thermal capacitance of the spacecraft.

Temperatures are regulated with passive and/or active thermal management technology and design methods. Many of the same thermal management methods used on larger spacecraft are



also applicable to SmallSats and given the increased interest in small spacecraft over the last decade, some spacecraft thermal control technologies have been miniaturized or otherwise adapted to apply to SmallSats. Thermal control methods and technologies as applied to large spacecraft are considered state-of-the-art for the purposes of this review but may have a Technology Readiness Level (TRL) value less than 9 for small spacecraft applications.

Challenges of designing a thermal control system for a SmallSat stem from four intrinsic properties, summarized in table 7-1.

<b>Table 7-1: SmallSat Thermal Control Challenges</b>	
<b>SmallSat Property</b>	<b>Challenge</b>
Low thermal mass	The spacecraft is more reactive to changing thermal environments.
Limited external surface area	There is less real estate to be allocated to solar cells, designated radiator area, and/or viewports required for science instruments.
Limited volume	There is less space for electronic components, science instruments, and thermal control hardware. Components can be more thermally coupled.
Limited power	There is less power available for powered thermal control technology.

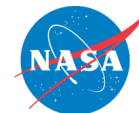
The information described in this section is not exhaustive but provides an overview of current state-of-the-art thermal technologies and their development. TRL designations may vary with changes specific to the payload, mission requirements, reliability considerations, and/or the environment in which performance was demonstrated. Readers are highly encouraged to reach out to companies for further information regarding the performance and TRL of described technology. There is no intention of mentioning certain companies and omitting others based on their technologies or relationship with NASA.

## 7.2 State-of-the-Art – Passive Systems

Passive thermal control maintains component temperatures without using powered equipment. Passive systems are typically associated with low cost, volume, weight, and risk, and so are advantageous to spacecraft with limited, mass, volume, and power, like SmallSats and especially CubeSats. Multi-layer Insulation (MLI), coatings/surface finishes, interface conductance, heat pipes, sunshades, thermal straps, interface materials, and louvers are some examples of passive thermal control technology.

In addition to passive thermal control technology, structural and electrical design methods also contribute to managing the thermal environment, passively. These design methods include:

- Material selection
  - Structural component materials chosen based on needed heat transfer through the structure. A high or low thermal conductivity may be more advantageous based on the application.
- Spacecraft orientation
  - If orientation is not dictated by science objectives, changing the orientation of the spacecraft can help maintain temperatures.
  - Changing orientation may only be needed during certain mission phases, such as science operation if larger amounts of heat are dissipated.
  - This method is often used in conjunction with other thermal control methods, such as orienting the spacecraft so that the radiator area can face deep space.



- Thermal interfaces
  - Dictation of thermal contact between components through specific mounting methods can thermally isolate components or allow more heat to be transferred to a structural element (or radiator area) when each is needed.
    - Heat transfer can be reduced by mounting a component through multiple stacked washers with low thermal conductivity.
    - Heat transfer can be increased by mounting components with more fasteners (if applicable) and can be further increased by using thermal interface materials between a component and mounting surface.
- Circuit board design considerations
  - Copper layers within each board can be increased to conduct heat away from electrical components through the boards to their structural connection points.
  - Circuit boards can be mounted to increase heat transfer away from the boards to the structure, such as by mounting with wedge locks.

Table 7-2 is a list of current passive thermal control technology as applied to SmallSats. One key factor to consider when choosing thermal control technology, both passive and active, is the temperature limits of the technology, itself. The goal is to use the appropriate technology to maintain the temperatures of spacecraft components within their limits, but the technology used to achieve this also has limits. It is recommended to verify that the technology used is applicable to the given design not only with respect to needed function, but to the environment (temperature limits), as well.

<b>Table 7-2: Passive Thermal Technology</b>		
<b>Manufacturer</b>	<b>Product</b>	<b>TRL in LEO Environments</b>
AZ Technology, MAP, Astral Technology Unlimited, Inc., Dunmore Aerospace, AkzoNobel Aerospace Coatings, Parker-Lord, Medtherm	Paint and Coatings	7-9
Sheldahl, Dunmore, Aerospace Fabrication & Materials, 3M	Tapes	7-9
Sheldahl, Dunmore, Aerospace Fabrication & Materials	MLI Materials	7-9
NASA GSFC, Aerothreads, Aerospace Fabrication & Materials	MLI Blanket Fabrication	7-9
Space Dynamics Laboratory, Thermal Management Technologies, Aavid, Technology Applications, Inc., Thermotive Technology	Thermal Straps	7-9
Bergquist, Parker Chomerics, Aerospace Fabrication & Materials, AIM Products LLC, Intermark USA, Indium Corporation, Dow Corning, NeoGraf, Laird Technologies	Thermal Interface Materials and Conductive Gaskets	7-9
Sierra Lobo, Aerospace Fabrication and Materials	Sun Shields	4 – 7
NASA Goddard Space Flight Center (GSFC)	Thermal Louvers	7-9



Aerospace Fabrication and Materials, Thermal Management Technologies	Deployable Radiators	5-6
Aavid Thermacore, Inc., Advanced Cooling Technology, Inc., Redwire Space	Heat Pipes	7-9
Thermal Management Technologies, Active Space Technologies, Advanced Cooling Technology, Inc.	Phase Change Materials/ Thermal Storage Units	7-9
Starsys, Redwire Space	Thermal switches	7-9
Thermal Management Technologies	Multifunctional Thermal Structures	4-5

**7.2.1 Paints, Coatings, and Tapes**

In a vacuum, heat is transferred only by radiation and conduction, with no convection. The internal environment of a fully enclosed small satellite is usually dominated by conductive heat transfer, while heat transfer to/from the outside environment is driven via thermal radiation.

The thermal radiation band of the electromagnetic spectrum is between 0.1 and 100  $\mu\text{m}$  in wavelength, as shown in figure 7.2. Outside of the thermal radiation waveband, electromagnetic energy generally passes through objects or has very little heat energy under practical conditions. Thermal analyses are typically conducted using a two waveband absorptance model which subdivides the thermal energy spectrum into solar ( $< 3 \mu\text{m}$ ) and IR ( $> 3 \mu\text{m}$ ) wavelengths.

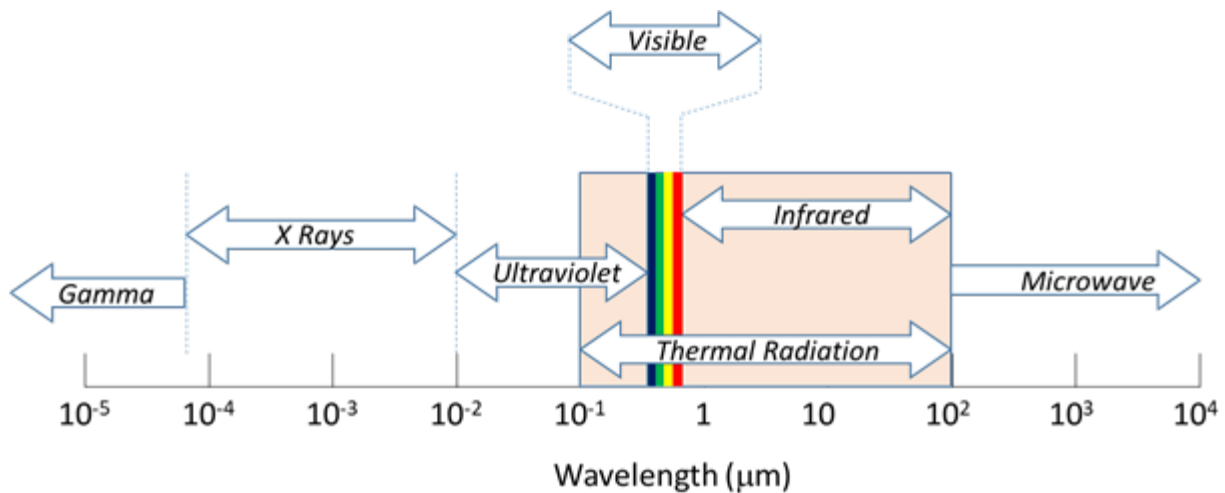
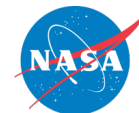


Figure 7.2: Electromagnetic spectrum showing the range of Thermal Radiation. Credit: NASA.

Thermal radiation heat transfer is controlled by using materials that have specific optical surface properties, namely: solar absorptivity and IR emissivity. Solar absorptivity governs how much incident heating from solar radiation a spacecraft absorbs, while IR emissivity determines how much heat a spacecraft emits to space, relative to a perfect blackbody emitter, and what fraction of thermal radiation from IR sources (e.g., the Earth, Moon, any particularly hot spacecraft components) are absorbed by that spacecraft surface.



The surface properties of a spacecraft can be modified by adding specialized paints, coatings, surface finishes, or adhesive tapes, depending on the needs of the spacecraft. For example, matte black paint has a high solar absorptivity and high IR emissivity for surfaces required to absorb a high percentage of solar heating and emit a high percentage of spacecraft heat. Alternatively, matte white paint has a low solar absorptivity and high IR emissivity (1) for surfaces required to absorb a low percentage of solar heating and emit a high percentage of spacecraft heat. Second-surface silver Fluorinated Ethylene Propylene (FEP) tapes offer excellent performance as radiator coatings, reflecting incident solar energy (low solar absorptivity) while simultaneously emitting spacecraft thermal energy efficiently (high IR emissivity). The selection between paints, coatings, and tapes depends on the application. Tape is typically easy to apply and remove, is comparatively inexpensive, and has a longer usable lifetime than paint (2). Tape can also be added later in the assembly process if changes to thermal control need to be made after the spacecraft has already begun assembly. Some tapes, however, must be handled carefully to maintain optical properties and can be difficult to bond properly to curved surfaces. Coatings and paints must often be applied earlier in the assembly process but can cover non-flat surfaces more easily. Some paints, like Parker-Lord's Aeroglaze 306/307, are expensive and require extensive and highly specialized processes to apply, however. Different options may also have different temperature limits. All these factors must be considered with regard to the needed application when selecting the final solution.

AZ Technology, MAP, Astral Technology Unlimited, Inc., Parker-Lord, Inc., Sheldahl, and AkzoNobel Aerospace Coatings manufacture thermal paint, coatings, and tapes for aerospace use that have been demonstrated on multiple small spacecraft missions. Most manufacturers have catalogs and/or guidebooks that provide detailed product information, including optical properties, and application guidance (for example, Sheldahl provides "The Red Book," (3)) to aid design selection.

One example, BioSentinel, a 6U spacecraft in development at NASA Ames Research Center (ARC) that is currently slated to be launched as a secondary payload on the Artemis I mission (2021), makes extensive use of Sheldahl metallized tape coatings and second-surface silvered FEP tapes to control its external thermal radiative properties and overall energy balance (4). Another example, Picard, a 150 kg SmallSat, used white paint on the Sun pointing face to reduce the amount of solar flux absorbed and lower temperatures. For most small spacecraft projects to date, adhesive tapes, such as silver FEP, or other standard surface finishes (e.g., polishing, anodize, alodine) have been the preferred choices.

### **7.2.2 Multi-layer Insulation**

A MLI blanket is typically comprised of multiple inner layers of a thin material with low IR emissivity and a durable outer layer. The amount of radiative heat transfer allowed is limited by the many layers of reflectors. The low IR emissivity layers are either perforated or alternated with thin netting to prevent conduction through the layers, thus forcing any heat transport to be limited to radiative heat transfer. The perforations allow the MLI to vent trapped gas once arriving on-orbit. MLI is used as a thermal radiation barrier to both protect spacecraft from incoming solar and IR flux, and to prevent undesired radiative heat dissipation. It is commonly used to maintain temperature ranges for electronics and batteries in-orbit.

MLI is delicate and performance drops drastically if compressed (causing a thermally conductive "short circuit"), so it should be used with caution or avoided altogether on the exterior of small satellites that fit into a deployer (e.g., P-POD, NLAS). MLI blankets can also pose a potential snagging hazard in these tight-fitting, pusher-spring style deployers. Additionally, MLI blankets tend to drop efficiency as size decreases because heat transfer through the blanket increases



closer to the blanket edges, and the specific attachment method has a large impact on performance because attachment to the spacecraft creates a heat path.

Due to these challenges, MLI generally does not perform as well on small spacecraft (more specifically CubeSat form factors) as on larger spacecraft. Surface coatings are typically less delicate and more appropriate for the exterior of a small spacecraft that will be deployed from a dispenser. Internal MLI blankets that do not receive direct solar thermal radiation can often be replaced by a variety of low emissivity tapes or coatings that perform equally well in that context, using less volume and at a potentially lower cost.

Dunmore Aerospace provides an option for cubesat developers to make their own MLI blanket with Satkit. (5) Satkit provides Dunmore's STARcrest MLI materials cut into manageable sizes, including a roll of outer layer material, a larger roll of inner layer material, and polyimide tapes for assembly and edge binding. The materials included in the kit have been flown in spaceflight applications before, but Satkit is currently TRL 6. Dunmore also offers polyimide film tape and MLI tape designed to insulate wires and cables on SmallSats and is TRL 7.

### 7.2.3 Thermal Straps

A thermal strap is a flexible, thermally conductive link added between a heat source and sink to conductively transfer heat. They are often used between high heat dissipating chips or components and a chassis wall or other radiator surface. Their flexibility prevents the addition of structural loads. Thermal straps can be made metal, traditionally copper or aluminum, or high conductivity carbon materials, such as graphite. They can be formed of multiple foil sheets or wound cables (also referred to as ropes and braids), with end blocks at each end to hold the sheets/cables in place and to mount or otherwise attach to the needed surfaces. Straps with more than two end blocks and multiple material combinations can also be produced and have been used on large spacecraft.

There are multiple companies that manufacture thermal straps for spaceflight. For example, Thermal Management Technologies manufactures standard flexible thermal straps in aluminum and copper foil layers or copper braids as shown in figure 7.3.

Custom thermal straps are also commonly fabricated and tested (6). Space Dynamics Laboratory (SDL) has pioneered solderless flexible thermal straps that contain no solder, epoxy, or other filler materials to maximize thermal performance. Figure 7.4 shows a comparison of the as-tested conductance for the same strap geometry fabricated with three different foil materials of aluminum, copper, and pyrolytic graphite sheets (PGS). SDL has supplied Utah State University with a PGS strap for the Active Thermal Architecture (ATA) project, a follow on to the ACCS project referenced in the cryocooler section. Advances in thermal straps are being developed to further increase heat transfer capability. Aavid, Boyd Corporation's thermal division, has designed thermal straps using their patented k-core technology that has an annealed pyrolytic graphite (APG) core within an encapsulating structure. These have greater conduction efficiency compared to traditional aluminum straps (7), as the k-Core increases the overall thermal conductivity. This technology has been fully designed and tested and is TRL 5 for small spacecraft application.



*Figure 7.3: Flexible Thermal Straps. Credit: Thermal Management Technologies.*





Figure 7.4: Thermal strap design with aluminum foils, copper foils, and PGS in aluminum end blocks (above), and their respective measured thermal conductance (left). The dashed lines connecting data points are based on material thermal conductivity curves. Credit: SDL.

Technology Applications, Inc. has specialized in testing and developing Graphite Fiber Thermal Straps (GFTS), with flight heritage on larger spacecraft missions (Orion and Spice). GFTS, shown in figure 7.5, are extremely lightweight and highly efficient and thermally conductive with unmatched vibration attenuation (8). While this technology has not been demonstrated on a small spacecraft, the fittings can only be made so small and most of the straps fall into a very typical size range with the end fitting thickness at a minimum of 0.10 – 0.30 in, with a thinner flexible section.

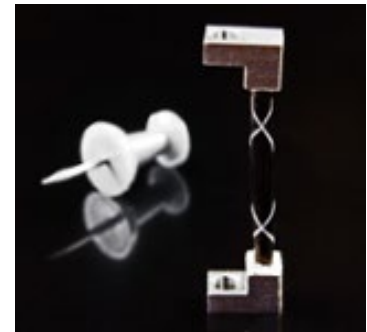


Figure 7.5: Graphite Fiber Thermal Straps (GFTS). Credit: Technology Applications, Inc.

Thermotive Technology developed the Two Arm Flexible Thermal Strap (TAFTS) that is currently flying on JPL’s Portable Remote Imaging Spectrometer (PRISM) instrument. Space infrared cameras require extremely flexible direct cooling of mechanically sensitive focal planes. The design of TAFTS uses three swaged terminals and a twisted section that allows for significant enhanced elastic movement and elastic displacements in three planes, while a more conventional strap of the same conductance offers less flexibility and asymmetrical elasticity (9). While infrared cameras have flown on small spacecraft missions, the TAFTS design has not been employed on a SmallSat.

The Pyrovo Pyrolytic Graphite Film (PGF) thermal straps developed by Thermotive have already flown in optical cooling applications for high altitude cameras and avionics on larger spacecraft. The specific thermal conductivity of this material has been shown to be 10x better than aluminum and 20x better than copper, as seen in figure 7.6 (10). These straps flew on JPL’s ASTERIA

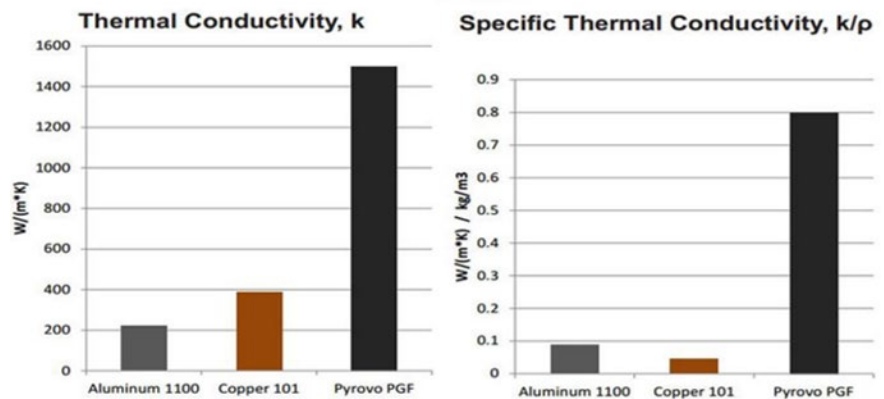


Figure 7.6: Pyrovo PGF Material Comparison. Credit: Thermotive Technology.

CubeSat in 2017 and is planned to be used on the Mars 2020 rover mission.

### 7.2.4 Thermal Interface Materials and Conductive Gaskets

Thermal interface materials are materials that are inserted between two components in order to increase the conductive heat transfer between them. They are often made as a sheet or pad of material to be sandwiched between surfaces, but there are many different types that vary in material, thickness, thermal conductivity, temperature limits, and vacuum-compatibility. Thermal interface materials can also be a grease or paste.

Thinner sheets of materials are commonly used between heat dissipating electronics boxes and mounting surfaces to thermally sink the hot components to a colder surface and reduce the temperature of the electronics. The performance of these types of materials depends on reaching a certain contact pressure between components to ensure the needed heat transfer. Laird Performance Materials has developed many different types of thermal interface materials for a variety of applications. For example, their Tflex series, shown in figure 7.7, is about 1 to 5 mm thick with a thermal conductivity of  $6 \text{ W mK}^{-1}$  (11), whereas their Tgon series of materials are about 0.13 to 0.5 mm thick with a thermal conductivity of  $5 \text{ W mK}^{-1}$  (12).

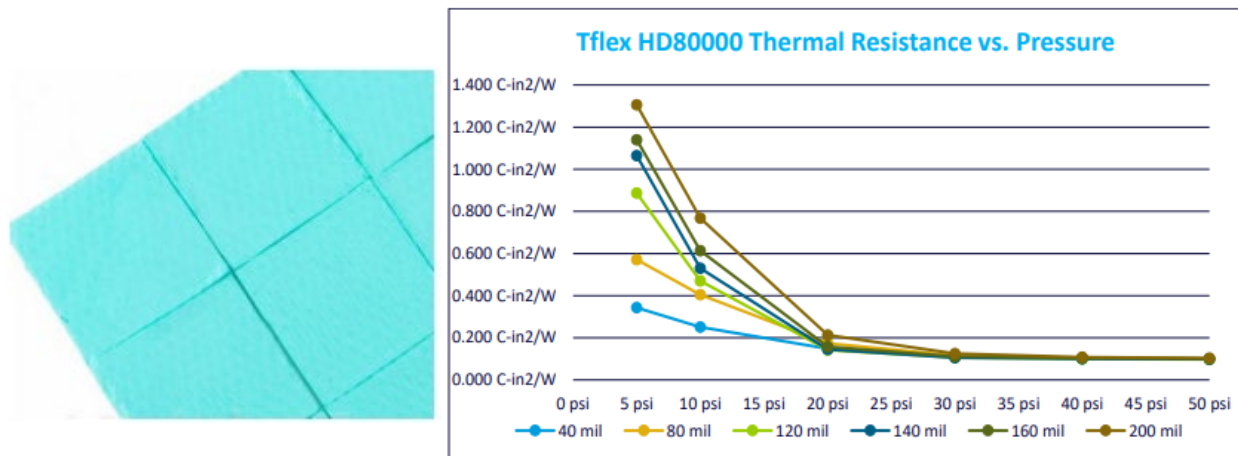


Figure 7.7: Laird Tflex HD80000 series sheets (left) and Thermal Resistance vs. Pressure (right). Credit: Laird Performance Materials.

Thicker pad-like materials, such as Henkel brand GAP PADS®, are often used between high heat dissipating chips on an electronics boards and the electronics enclosure. These are also made to fit a variety of applications, with varying material, thickness, conformability, tear-resistance, electrical isolation, thermal conductivity, and more (13). Several additional thermal interface materials developed by Henkel Corporation are shown in figure 7.8.

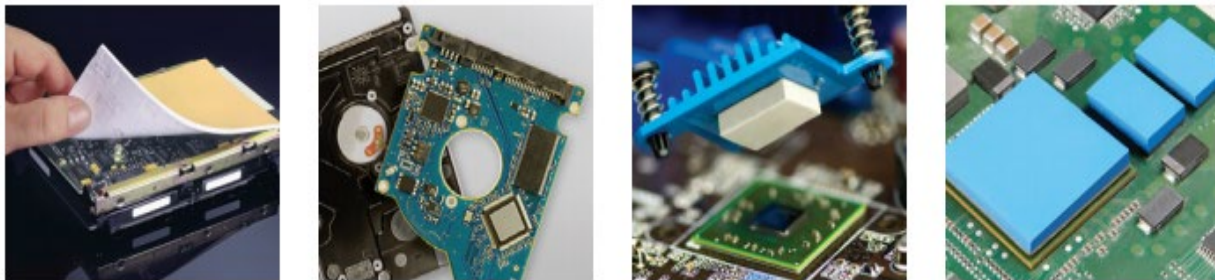


Figure 7.8: A variety of thermal interface materials. Credit: Henkel Corporation.

### 7.2.5 Sunshields

A sunshield, or sunshade, is an often-deployed device made up of a material with low solar absorptivity that reduces the amount of incident solar flux impinging a spacecraft, by blocking the view to the sun. Sunshields are commonly used for spacecraft thermal control, although only recently on small spacecraft. Sierra Lobo developed a deployable sunshield that flew on CryoCube-1, shown in figure 7.9, which was launched on Dragon CRS-19 in February 2020. In low-Earth orbit, this sunshield can support a multiple month-long duration lifetime and can provide temperatures below 100 K and below 30 K with additional cooling (14).

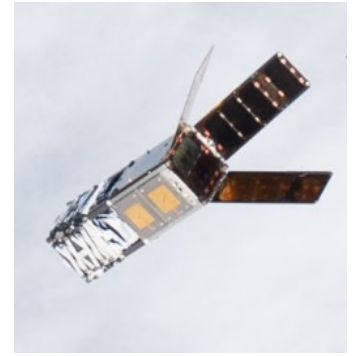
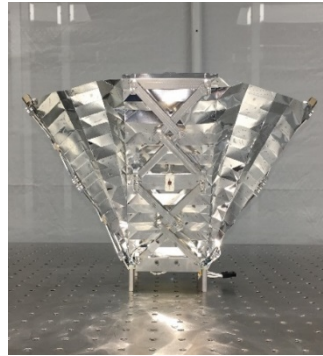


Figure 7.9: Deployed Sunshield on CryoCube-1 (left) and CryoCube-1 in orbit with shield stowed (right). Credit: Sierra Lobo (left) and NASA (right).

### 7.2.6 Thermal Louvers

Thermal louvers are thermally activated shutters that regulate how much heat the louvered surface can dissipate. As the louvers open, the average IR emissivity of the surface changes, changing how much heat the surface dissipates. Full-sized louvers on larger spacecraft have high efficacy for thermal control, however, integration on small spacecraft is challenging. Typical spacecraft louvers are associated with a larger mass and input power, which are both limited on small spacecraft.

Although commonly defined as active thermal control, here we consider louvers as a passive thermal control component because the Cubesat-adapted design considered does not require a power input from the spacecraft. NASA GSFC has developed a passive thermal louver that uses bimetallic springs to control the position of the flaps; when the temperature of the spacecraft rises, the springs expand, opening the louvers to modify the average IR emissivity of the exterior surface. Similarly, when the spacecraft cools and the flaps close, the exterior surface returns to the previous optical properties (15). The louvers were developed for a 6U CubeSat, Dellinger, which was released from the NanoRacks CubeSat Deployer on the International Space Station (ISS) into low-Earth orbit in late 2017 (16), and has a demonstrated thermal dissipation of 14 W. This louver design is illustrated in figure 7.10.



Figure 7.10: Passive Thermal Louver on 6U CubeSat Dellinger. Credit: NASA GSFC.

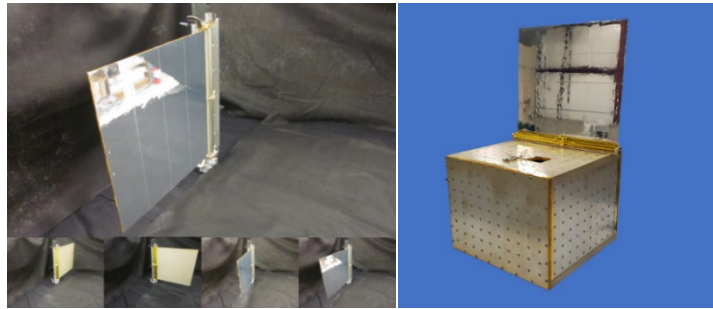
### 7.2.7 Deployable Radiators

A radiator is a dedicated surface for dissipating excess heat via radiative heat transfer and has a high IR emissivity and low solar absorptivity, an optical property combination typically referred to as “radiator properties.” A deployable radiator is stowed during transit or when the radiator is not needed and deployed when excess heat dissipation is required. Deployable radiators on small spacecraft can be challenging due to volumetric constraints. While paint has been widely used to create efficient radiator surfaces on larger spacecraft, the relatively limited available external surface area on SmallSats that already have body-mounted solar cells reduces the potential for creating dedicated radiative surfaces. For a system that requires a large amount of heat



dissipation, a passive deployable radiator would greatly enhance thermal performance by increasing the available radiative surface area. There has been steady development in this technology over the last five years and radiator designs for SmallSats have improved to TRL 5.

Thermal Management Technologies has developed thermally efficient deployable radiators for small spacecraft that integrate a radiator surface with a high-conductance hinge. The thermally conductive hinge causes minimal temperature gradients between the radiator and spacecraft; thus, the radiator can operate near spacecraft temperatures. Figure 7.11 shows the radiator design. The radiating surface uses graphite composite material for mass reduction and increased stiffness, where the typical radiator uniformity is less than  $0.1^{\circ}\text{C W}^{-1}\text{ m}^{-1}$ . This technology is currently in the development and testing phase (17).



*Figure 7.11: 100W deployable radiator (left), and radiator shown on ESPA structure (right). Credit: Thermal Management Technologies.*

The design of a flexible deployable radiator for small spacecraft was developed and tested by Shoya Ono, Hosei Nagano, and colleagues from Kaneka Corporation and JAXA in 2015. This design can deploy or stow the radiation area to control heat dissipation depending on environmental temperatures. It has an overall volume of  $0.5 \times 360 \times 560$  mm and 0.287 kg total mass. The radiator is passively stowed and deployed by an actuator made of a shape memory alloy and bias spring. To increase radiator size and thermal conductivity, multiple layers of Kaneka Graphite Sheets (KGS) are used for the fin material. The rear surface of the fin is insulated with MLI to reduce the amount of heat dissipation under cold conditions. Deployment and stowage tests were conducted in a thermostatic chamber, and the thermal performance test was conducted under vacuum conditions, where it was shown that the half-scaled radiator dissipated 54 W at  $60^{\circ}\text{C}$  (18).

Thermotive is researching the Folding Elastic Thermal Surface (FETS), a deployable passive radiator for hosted payload instruments and CubeSats. Originally conceived as a thermal shield and cover for a passive cooler (cryogenic radiator) on JPL's MATMOS mission, this proposed concept is being modified as a deployable radiator for small spacecraft (19).

Since deployable radiators may be needed because of a lack of radiator surfaces on the spacecraft body due to body-mounted solar cells, an alternate option is to use the chassis body as radiator area and have a deployable solar array. Also, deployed solar arrays would be able to radiate off a high emissivity/low solar absorptance backside for improved thermal management of the array.

### 7.2.8 Heat Pipes

A traditional heat pipe is a passive device comprised of a metal container (pipe) that holds a liquid under pressure and has a porous wick-like structure within the container. When heat is applied to one end of the tube, the liquid inside the tube near the hot end vaporizes into a gas that moves through the tube to the cooler end, where it condenses back into a liquid. The wick transports the condensed liquid back to the hot end via capillary action. There are also more complicated and non-passive types of heat pipes such as variable conductance, diode, and loop heat pipes, which are not further explained in this document.

Heat pipes are an efficient passive thermal transfer technology, where a closed-loop system transports excess heat via temperature gradients, typically from electrical devices to a colder surface, which is often either a radiator itself, or a heat sink that is thermally coupled to a radiator. Traditional constant conductance heat pipes are cylindrical in shape with a grooved inner wick, like those used on Bi-Spectral Infrared Detection (BIRD), a 92 kg satellite launched in 2001, to join satellite segments (20), see figure 7.12. Heat pipes can also be configured as flat plates with tubing sandwiched between two plates and charged with a working fluid inside. SDS-4, a 50 kg small spacecraft launched in 2012, incorporated the Flat-Plate Heat Pipe On-Orbit Experiment (FOX), developed at JAXA (21).

Redwire Space has developed a conformable micro heat pipe thermal management solution based on proprietary “FlexCool” technology for small satellites that is a cross between a heat pipe and a thermal strap (22). The conformable micro heat pipe flew on TechEdSat-10, a 6U CubeSat deployed from the ISS in 2020, to thermally manage the radio. An image of this technology in a 1U CubeSat model is shown in figure 7.13.

### 7.2.9 Phase Change Materials/ Thermal Storage Units

A phase change material used as a thermal storage unit is made up of a material (e.g., wax) within a metal housing. A heat source is attached to the housing so that, as the source conducts heat to the enclosure, the phase change material within absorbs the energy as it changes phase (usually from solid to liquid). Then, as the heat source energy output reduces, the phase change material releases the energy as it changes back to its initial phase (usually from liquid to solid). Owing to the low thermal conductivity of the phase change material, the metal housing must conduct heat into the phase change medium for efficient solidification or melting. Thermal storage units are typically used with components that will experience repeated temperature cycling. They can be challenging to apply to CubeSats and other small satellites because of the extra mass of the housing needed.

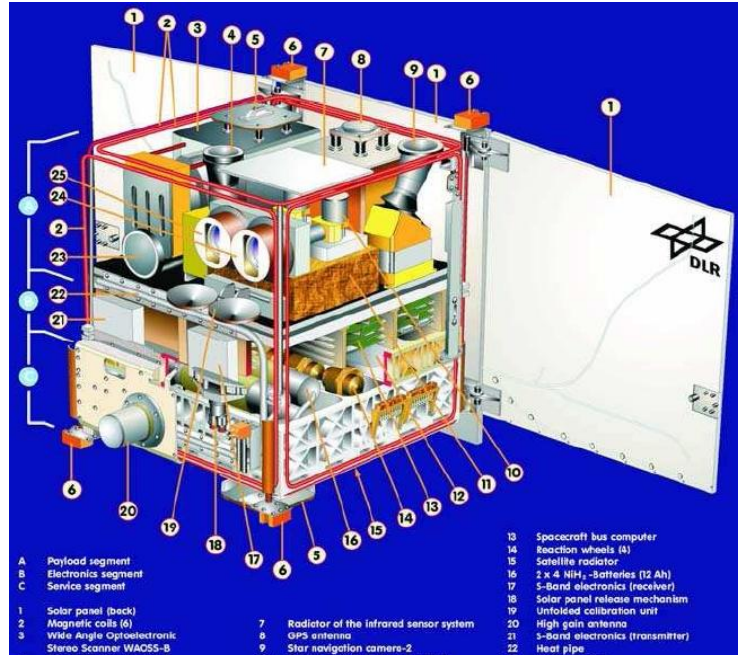


Figure 7.12: Diagram of BIRD, heat pipe denoted by #22. Credit: DLR-OS (DLR Institute of Optical Sensor Systems).

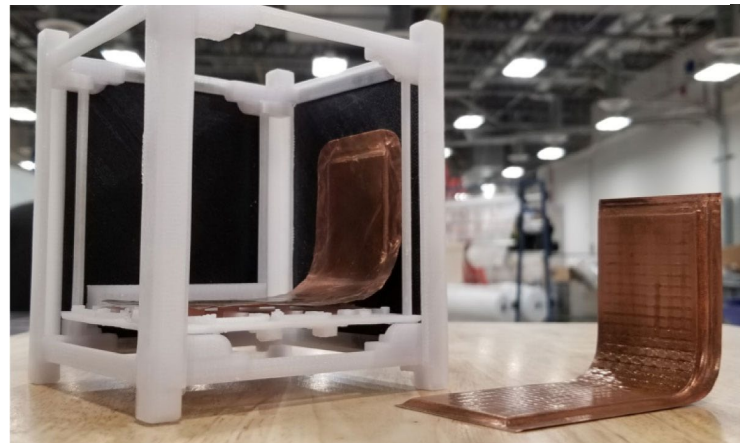


Figure 7.13: FlexCool conformable micro heat pipe before integrating with TechEdSat-10 DVB-S2 radio. Source: Redwire Space.

Thermal Management Technologies has developed a phase-changing thermal storage unit (TSU) that considers desired phase-change temperatures, interfaces, temperature stability, stored energy, and heat removal methodologies, as shown in figure 7.14. This device will allow the user to control temperature peaks, stable temperatures and/or energy storage (36).

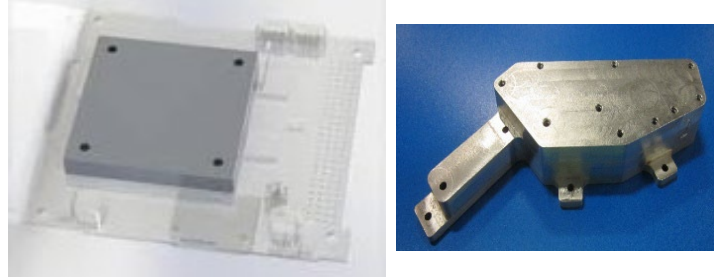


Figure 7.14: CubeSat Thermal Storage Unit. Credit: Thermal Management Technologies.

### 7.2.10 Thermal Switches

A thermal switch is a device that switches a heat conduction path between either a strong thermal coupling or weak thermal coupling (thermal insulation) as needed to control the temperature of heat producing components. A switch typically connects a heat producing component and a low temperature sink, such as a radiator. Heat switches differ from thermostats in that they passively modulate a thermal coupling while thermostats modulate heater circuits (23). Part of the challenge in integrating a thermal switch in SmallSats is that they take up additional space between a component and heat sink. Typical, heat switches may provide a conduction ratio of 10:1 with a technology goal of 100:1 (24). This technology is rated at TRL 7 – 9.

### 7.2.11 Multifunctional Thermal Structures

A newer development in passive thermal control for small spacecraft are multi-functional thermal structures. These integrate thermal control capabilities directly into the structure. This is particularly advantageous for small spacecraft due to strict mass and volume constraints. Currently, Thermal Management Technologies has adapted its multifunction heat spreading structure technology, scaled it to smaller satellite configurations, and called it Standard Passive Orbital Thermal-control (SPOT) Structures. SPOT Structures come in four standard configurations: 6U, 12U, Launch U, and ESPA (25). Each incorporates heat-spreading technology that improves the ability to radiate waste heat. They incorporate features such as low mass, high stiffness/strength, and integrated heat pipes. This new technology is at TRL 4.

## 7.3 State-of-the-Art – Active Systems

Active thermal control methods rely on input power for operation and have been shown to be more effective in maintaining tighter temperature control for components with stricter temperature requirements or higher heat loads (26). Typical active thermal devices used on large-scale spacecraft include electrical resistance heaters, cryocoolers, thermoelectric coolers, and fluid loops. Electrical heaters are usually easily integrated into SmallSat architecture as they do not typically use much mass or volume. Heaters are frequently used in all space applications, including small and large satellites, so they are often included as passive thermal control technology. Other active systems are challenging to integrate into CubeSats and other small satellites because of the power, mass, and volume needs associated with each given technology. Until spacecraft designers can miniaturize existing actively controlled thermal techniques and reduce power requirements or increase available spacecraft power, the use of active thermal systems in small spacecraft will be limited.

The current state-of-the-art of active thermal technologies in SmallSats is shown in table 7-3.



<b>Manufacturer</b>	<b>Products</b>	<b>TRL in LEO Environment</b>
Minco Products, Inc., Birk Manufacturing, All Flex Flexible Circuits, LLC., Fralock, Tayco Engineering, Inc., Omega	Electrical Heaters	7-9
Ricor-USA, Inc., Creare, Sunpower Inc., Northrop Grumman, NASA Jet Propulsion Lab, and Lockheed Martin Space Systems Company	Cryocoolers	5-6
Marlow, TE Technology Inc., Laird	Thermoelectric Coolers (TEC)	7-9
Lockheed Martin	Fluid Loops	4-5
NASA Small Spacecraft Technology program	Active Thermal Architecture (ATA)	4-6

### 7.3.1 Heaters

Electrical resistance heaters used on small spacecraft are most often Kapton heaters, which consist of a polyimide film with etched foil circuits that produce heat when a current is applied. Kapton heaters also often have a pressure sensitive adhesive on one side for easy application. Heaters are typically used in cold environments to maintain battery temperature, which is usually the component with the narrowest temperature limits, and are controlled by a thermostat or temperature sensor. The low mass of SmallSats requires little additional heater power to maintain temperature limits, and so heaters do not typically need to be very high power to effectively manage temperatures.

The 1U CubeSats Compass-1, MASAT-1, and OUTFI-1 each required an electrical heater attached to the battery in addition to passive control for the entire spacecraft system to maintain thermal regulation in eclipses (27). Additionally, as biological payloads become more common on small spacecraft, their temperature limits must be considered and maintained as well. NASA ARC biological nanosats (GeneSat, PharmaSat, O/OREOS, SporeSat, EcAMSat, and BioSentinel) all use actively-controlled heaters for precise temperature maintenance for their biological payloads, with closed-loop temperature feedback to maintain temperatures.

### 7.3.2 Cryocoolers

Cryocoolers are refrigeration devices designed to cool around 100K and below. A summary of cryocooler systems is given in figure 7.15 and a detailed review of the basic types of cryocoolers and their applications is given by Radebaugh (28). The first two systems (a) and (b) are recuperative cycles, and (c), (d), and (e) are regenerative cycles. Cryocoolers are used on instruments or subsystems requiring cryogenic cooling, such as high precision IR sensors. Instruments such as imaging spectrometers, interferometers and midwave infrared (MWIR) sensors require cryocoolers to function at extremely low temperatures. The low temperature improves the dynamic range and extends the wavelength coverage. The use of cryocoolers is also associated with longer instrument lifetimes, low vibration, high thermodynamic efficiency, low mass, and supply cooling temperatures less than 50K (29).

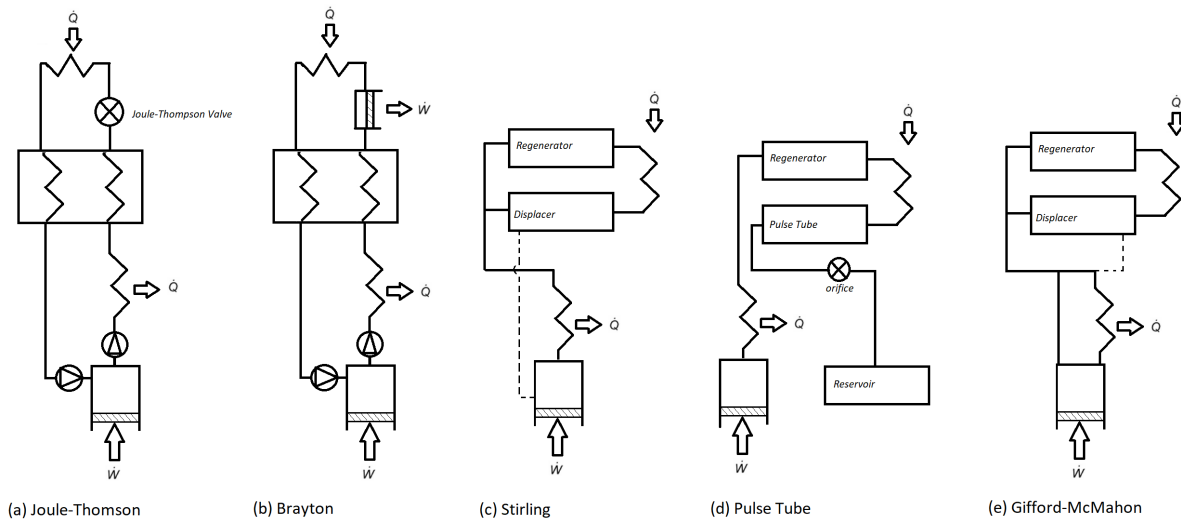


Figure 7.15: A comparison of cryocooler types. Credit: NASA.

Creare has developed an Ultra-Low Power (ULP) single-stage, turbo-Brayton cryocooler that operates between a cryogenic heat rejection temperature and the primary load temperature. The cryocooler includes a cryogenic compressor, a recuperative heat exchanger, and a turboalternator. The continuous flow nature of the cycle allows the cycle gas to be transported from the compressor outlet to a heat rejection radiator at the warm end of the cryocooler and from the turboalternator outlet to the object to be cooled at the cold end of the cryocooler (30). This cryocooler is designed to operate at cold end temperatures of 30 to 70K, with loads of up to 3 W, and heat rejection temperatures of up to 210K by changing only the charge pressure and turbo machine operating speeds. This technology has completed testing and fabrication and is TRL 6. The development of this technology has not specifically targeted small satellite applications, but with its comparatively low power requirements could be adapted to SmallSats in the future.

A reverse turbo-Brayton cryocooler that produces negligible vibration, is also being developed by Creare. This technology uses a continuous flow of gas to transport heat from the active elements of the cryocooler to the objects to be cooled and to heat rejection surfaces.

Ricor-USA, Inc. developed the K562S, a rotary Sterling mini micro-cooler. It has a cooling capacity of 200 mW at 95 K and 300 mW at 110K. It has been used in several small gimbals designed for military applications. Ricor also developed K508N, a Sterling ½ W micro cooler that has a cooling capacity of 500 mW at 77 K and 700 mW at 77K that is suitable for use on small spacecraft. These coolers, shown in figure 7.16, are TRL 6 for small spacecraft applications.

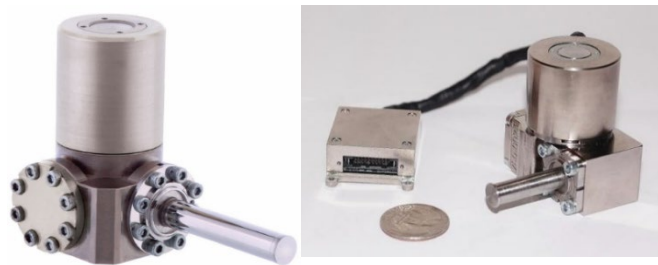


Figure 7.16: (left) K508N 1/2 W Micro Cooler, and (right) K562S Mini-cooler. Credit: Ricor-USA.



Sunpower, Inc. developed the CryoTel DS1.5 Sterling Cryocooler, shown in figure 7.17, featuring a dual-opposed-piston pressure wave generator and a separate cold head to minimize exported vibration and acoustic noise, and has a nominal heat lift of 1.4 W at 77K using 30 W power with a 1.2 kg mass (31). Sunpower also offers MT-F, a mini-cooler that has a nominal heat lift of 5 W at 77K, using 80 W power with a total mass of 2.1 kg. So far, these units have not been used in small spacecraft applications but are candidates given their size and performance.



Figure 7.17: (left) CryoTel DS1.5 1.4 W Cryocooler and (right) CryoTel MT-F 5 W Cryocooler. Credit: Sunpower, Inc.

Northrop Grumman designed a Micro Pulse Tube cooler that is a split-configuration cooler that incorporates a coaxial coldhead connected via a transfer line to a vibrationally balanced linear compressor. This micro compressor has been scaled from a flight proven, high efficiency cooler (HEC) compressor, although it has not operated on a SmallSat. It has a TRL of 6. The cooler has an operational range of 35 to 40K and a heat rejection temperature of 300K, using 80 W of input power, has 750 mW refrigeration at 40K, and a total mass of 7.4 kg (32).

Lockheed Martin Space Systems Company has engineered a pulse tube micro-cryocooler, a simplified Sterling cryocooler consisting of a compressor driving a coaxial pulse tube coldhead, shown in figure 7.18. The unit has a mass of 0.345 kg for the entire thermal mechanical unit, and is compact enough to be packaged in a ½U CubeSat (33). After qualification testing, the microcooler is at TRL 6 and is compatible with small spacecraft missions.



Figure 7.18: TRL6 Microcryocooler. Cryocooler Credit: Lockheed Martin.

Thales Cryogenics has also developed a Linear Pulse Tube (LPT) cryocooler that has gone through extensive testing by JPL. The Thales LPT9510 cryocooler has an operating temperature range of -40 to 71°C, an input power of <85 W, and a total unit mass of 2.1 kg. The unit has no flight heritage but has undergone extensive testing and is TRL 6 (34).

### 7.3.3 Thermoelectric Coolers (TEC)

A TEC is a solid-state heat pump that requires a heat exchanger to dissipate heat using the Peltier effect. During operation, current flows through the TEC to create heat transfer and a temperature differential across the ceramic substrates, causing one side of the TEC to be cold, while the other side is hot.

### 7.3.4 Fluid Loops

A pumped fluid loop (PFL) consists of a circulating pump that moves a liquid through tubing connected to a heat exchanger and heat sink. A heat source is mounted to the heat exchanger and the pumped fluid carries the heat from the source to a heat sink, typically a radiator, and then the cooled fluid is returned to the heat source to continue providing cooling. A PFL is capable of cooling multiple locations via forced fluid convective cooling. Mechanically pumped fluid loops (MPFL) are not typically used on SmallSats because they are associated with high power consumption and mass.

Lockheed Martin Corporation is developing a low mass circulator pump for a closed cycle Joule Thomson cryocooler, as shown in figure 7.19. With an overall mass of 0.2 kg, it can circulate gas as part of a single-phase or two-phase thermal management system using 1.2 W of electrical power and can manage around 40 W of spacecraft power as a single-phase loop, or several hundred Watts of spacecraft power as part of a 2-phase loop. The compressor went through applicable testing with a compression efficiency of 20 – 30% in a 2016 study (35). This design is TRL 4.

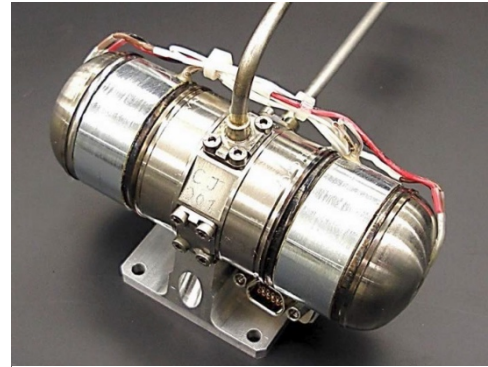


Figure 7.19: JT Compressor.  
Credit: Lockheed Martin.

### 7.3.5 Active Thermal Architecture

The ATA project is an advanced design effort to develop active thermal control technologies for small satellites in support of future advanced missions in deep space, helio-physics, earth science, and communications. The ATA project is led by the Center for Space Engineering at Utah State University (CSE, USU) and funded by the NASA Small Satellite Technology (SST) program in partnership with JPL.

The ATA is a 1U two-stage active thermal control system targeted at 6U CubeSat form factors and larger. The first stage consists of a mechanically pumped fluid loop (MPFL). A micro-pump circulates a working fluid between an internal integrated heat exchanger and a deployed tracking radiator. The second stage is a miniature tactical cryocooler, which directly provides cryogenic cooling to payload instrumentation. The conceptual operation of the ATA system is shown in figure 7.20.

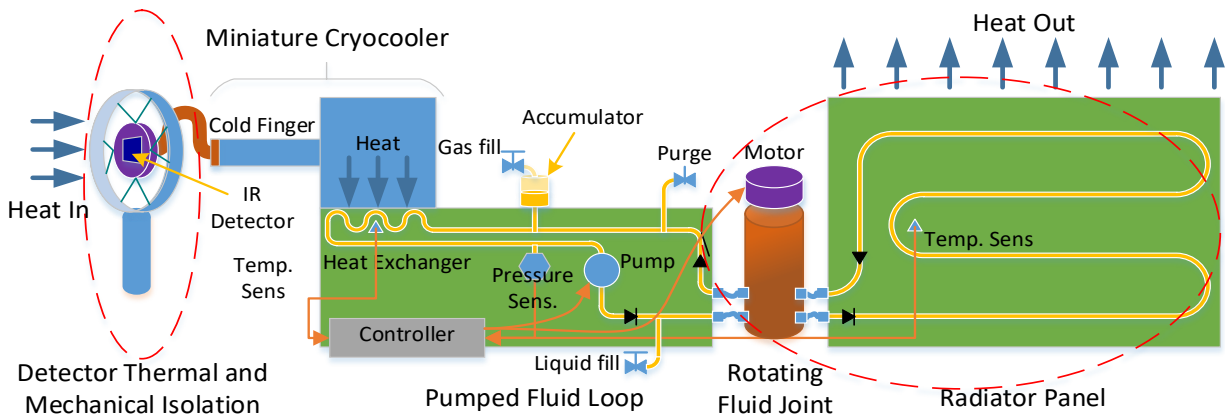
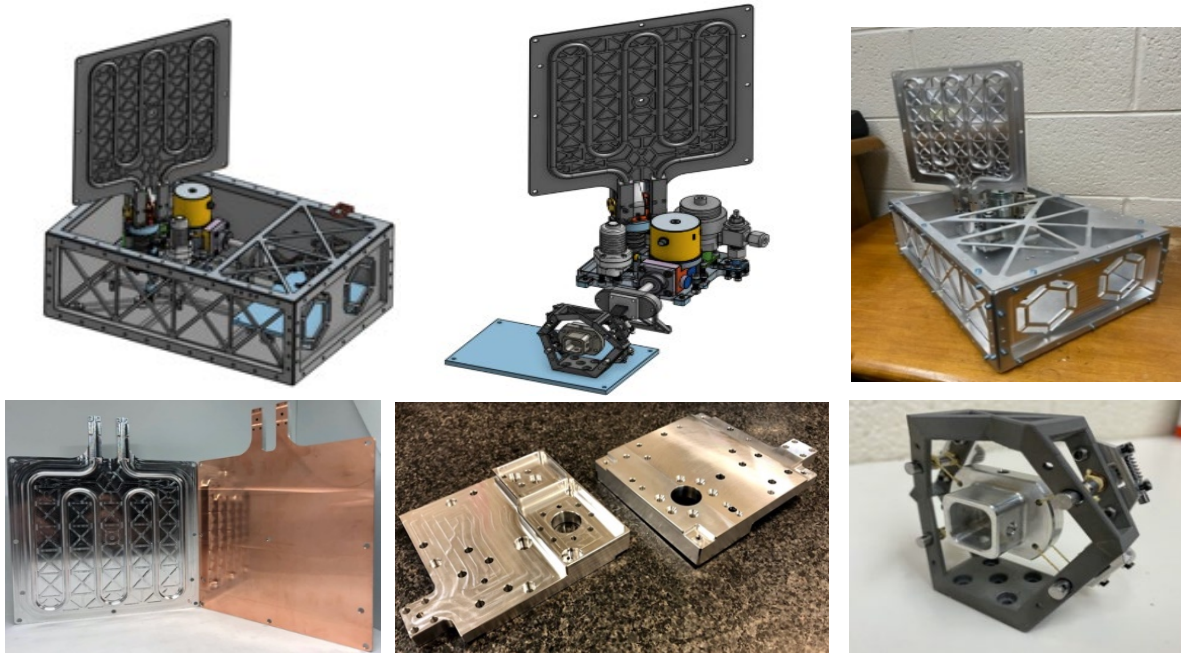


Figure 7.20: Conceptual operation of the ATA thermal control system. Credit: CSE/USU/ NASA/JPL.

Ultrasonic additive manufacturing (UAM) techniques were used to simplify and miniaturize the ATA system by embedding the MPFL fluid channels directly into the integrated HX, CubeSat chassis, and the external radiator. The ATA system also features a dual rotary fluid union design, and an integrated geared micro-motor which allows for the two-stage deployment and solar tracking of the ATA radiator. The ATA also features passive vibration isolation and jitter cancellation technologies such as a floating wire-rope isolator design, particle damping, flexible PGS thermal links and a custom Kevlar isolated cryogenic electro-optical detector mount. Figure 7.21 shows some of the technologies developed for ATA as well as the ground-based prototype CubeSat.



*Figure 7.21: From top left: ATA CubeSat prototype, 1U ATA subsystem, ATA prototype, UAM radiator with copper backing, UAM heat exchanger, Kevlar isolated Cryogenic Electro-optical prototype mount. Credit: CSE/USU/NASA/JPL.*

## 7.4 Summary

As thermal management on small spacecraft is limited by mass, surface area, volume and power constraints, traditional passive technologies, such as paints, coatings, tapes, MLI, and thermal straps, dominate thermal design. Active technologies, such as thin flexible resistance heaters have also seen significant use in small spacecraft, including some with advanced closed-loop control. Many technologies that have to date only been integrated on larger spacecraft are being designed, evaluated, and tested for small spacecraft to meet the growing needs of SmallSat developers as small satellites become more and more advanced. Passive louvers that have successfully flown on 6U Dillengr, and deployable solar panels that have been used by many other SmallSats are paving the way for thermal deployable components, while advanced deployable radiators and thermal storage units are still undergoing testing for small spacecraft.



Technology in active thermal control systems has started expanding to accommodate volume and power restrictions of a smaller spacecraft; cryocoolers are being designed to fit within 0.5U volume that will allow small spacecraft to use optical sensors and imaging spectrometers.

For feedback solicitation, please email: [arc-sst-soa@mail.nasa.gov](mailto:arc-sst-soa@mail.nasa.gov). Please include a business email.

## References

- (1) A. Anvari, F. Farhani, and K. S. Niaki. *Comparative Study on Space Qualified Paints Used for Thermal Control of a Small Satellite*. 2009.
- (2) Soulage, M. *Personal Correspondence*. 2013.
- (3) Sheldahl. "The Red Book". [Online] 2020. [https://www.sheldahl.com/sites/default/files/2020-02/RedBook\\_0.pdf](https://www.sheldahl.com/sites/default/files/2020-02/RedBook_0.pdf).
- (4) Benton, Josh. 2018.
- (5) Dunmore MLI: Satkit. *Dunmore*. [Online] <https://www.dunmore.com/products/satkit-mli.html>.
- (6) Thermal Management Technologies. *Flexible Thermal Straps*. 2015.
- (7) Thermacore. *Thermal Straps: Efficient Cooling without Structural Loading*. 2015.
- (8) Technology Applications Inc. *Graphite Fiber Thermal Straps (GFTS)*. 2015.
- (9) E. Urquiza, C. Vasquez, J. Rodriguez, and B. V. Gorp. *Development and testing of an innovative two-arm focal-plane thermal strap (TAFTS)*. 2012.
- (10) Thermotive. Products. [Online] 2014.
- (11) Laird Technologies. Tflex HD80000 Series Thermal Gap Filler. *Laird Technologies*. [Online] <https://www.laird.com/sites/default/files/tflex-hd80000-datasheet.pdf>.
- (12) Tgon 800 Series Electrically and Thermally Conductive Interface Pad. *Laird Technologies*. [Online] <https://www.laird.com/sites/default/files/tgon-800-datasheet.pdf>.
- (13) Henkel Corporation. Bergquist Thermal Interface Materials Selection Guide. *Bergquist*. [Online] 2019. <https://dm.henkel-dam.com/is/content/henkel/lt-8116-brochure-thermal-interface-materials-selection-guidepdf>.
- (14) Sierra Lobo. *CryoCube-1*. 2014.
- (15) NASA Goddard Space Flight Center. *Dellingr*. 2014.
- (16) NASA. NASA Begins Checkout of Dellingr Spacecraft Designed to Improve Robustness of CubeSat Platforms. [Online] November 2017.
- (17) Thermal Management Technologies. *Thermally Efficient Deployable Radiators*. 2020.
- (18) *Thermophysical Properties of a High-thermal-conductive Graphite Sheet and Application to a Deployable/Stowable Radiator*. Ono, S, et al. Vail : International Conference on Environmental Systems, 43rd International Conference on Environmental Systems, 2013.
- (19) Urquiza, Eugenio , et al. Folding Elastic Thermal Surface — FETS. *Tech Briefs*. [Online] 07 2013. <https://www.techbriefs.com/component/content/article/tb/pub/techbriefs/mechanics-and-machinery/16598>.



- (20) ESA. BIRD (Bi-Spectral Infrared Detection). *eoPortal: Earth Observation Directory & News*. [Online] ESA. <https://directory.eoportal.org/web/eoportal/satellite-missions/b/bird>.
- (21) Nakamura, Y. *Small Demonstration Satellite-4 (SDS-4): Development, Flight Results, and Lessons Learned in JAXA's Microsatellite Project*. 2013.
- (22) Redwire Space. Thermal Products. *Roccor*. [Online] 2020. [https://www.roccor.com/thermal\\_products/](https://www.roccor.com/thermal_products/).
- (23) Gilmore, David. *Spacecraft Thermal Control Handbook, Volume I, Fundamental Technologies, Chapter 10: Heat Switches*. 2002.
- (24) NASA. NASA Technology Roadmaps TA14: Thermal Management Systems, July 2015. [Online] [https://www.nasa.gov/sites/default/files/atoms/files/2015\\_nasa\\_technology\\_roadmaps\\_ta\\_14\\_thermal\\_management\\_final.pdf](https://www.nasa.gov/sites/default/files/atoms/files/2015_nasa_technology_roadmaps_ta_14_thermal_management_final.pdf).
- (25) Thermal Management Technologies. Products: Small Spacecraft Structures. *Thermal Management Technologies*. [Online] <https://www.tmt-ipe.com/small-spacecraft-structures>.
- (26) Hogstrom, K. *State-of-the-Art Thermal Analysis Methods and Validations for Small Spacecraft*. 2013.
- (27) D. Hengeveld, J. Braun, E. Groll, and A. Williams. *Review of Modern Spacecraft Thermal Control Technologies and Their Application to Next- Generation Buildings*. 2010.
- (28) *Refrigeration for superconductors*. Radebaugh. 2004, IEEE, pp. 1719 - 1734 .
- (29) R. Hon, C. Kesler, and D. Sigurdson. *Integrated Testing of a Complete Low Cost Space Cryocooler System*. 2009.
- (30) M. V. Zagarola, R. W. Hill, J. R. Gagne, and R. W. Kaszeta. *Ultra Low Power Cryo-Refrigerator for Space Applications*. 2012.
- (31) Sunpower Inc. *CryoTel® DS 1.5*. 2015.
- (32) D. Durand, E. Tward, G. Toma, and T. Nguyen. *Efficient High Capacity Space Microcooler*. 2014.
- (33) Nast, J. Olson and T. *Lockheed Martin Microcryocooler*. 2013.
- (34) Thales Cryogenics. *LPT9510 1400 mW / 18 mm slip-on*. 2018.
- (35) Champagne, P. *Development of a J-T Micro Compressor*. 2015.
- (36) Thermal Management Technologies. *Isothermal, compact, energy dense phasechange thermal storage units for thermal management*. 2015.



## Chapter Contents

Glossary .....	ii
8.0 Small Spacecraft Avionics .....	202
8.1 Introduction .....	202
8.2 Chapter Scope and Organization .....	203
8.3 State-of-the-Art (TRL 5-9): Command and Data Handling .....	204
8.3.1 Avionics and On-board Computing Form Factors .....	205
8.3.2 Highly Integrated On-Board Computing Products .....	206
8.3.3 Radiation-Hardened Processors and FPGAs .....	210
8.3.4 Memory, Electronic Function Blocks, and Components .....	211
8.3.5 Bus Electrical Interfaces .....	212
8.3.6 Radiation Mitigation and Tolerance Schemes .....	212
8.4 State-of-the-Art (TRL 5-9): Flight Software .....	215
8.4.1 Implication of C&DH Processors on FSW .....	216
8.4.2 Frameworks .....	217
8.4.3 Operating Systems .....	218
8.4.4 Software Languages .....	219
8.4.5 Mission Operations and Ground Support Suites .....	220
8.4.6 Development Environment, Standards, and Tools .....	220
8.5 On the Horizon (TRL 1-4): Command and Data Handling .....	224
8.5.1 Open-Source Platforms .....	224
8.6 On the Horizon (TRL 1-4): Flight Software .....	225
8.7 Avionics Systems Platform and Mission Development Considerations .....	225
8.7.1 Flight Payload and Subsystems Avionic elements examples .....	226
8.7.2 Platform Size Ranges and Configurations .....	226
8.7.3 Integrated Avionics Platform Architectures .....	227
8.7.4 SS Mission Avionics Configurations .....	227
8.7.5 Spacecraft and Mission Autonomy .....	227
8.7.6 Industry 4.0, Foundational and Enabling Technologies and Products .....	228
8.8 Summary .....	228
References .....	229



## Glossary

(ADC/DAC)	Analog to Digital/Digital to Analog
(API)	Application Programming Interfaces
(ASICs)	Application Specific Integrated Circuits
(ASIST)	Advanced Spacecraft Integration and System Test
(BSPs)	Broadband Service Providers
(C&DH)	Command and Data Handling
(CCD)	Charge Couple Devices
(CCSDS)	Consultative Council for Space Data Systems
(cFE)	core Flight Executive
(cFS)	core Flight System
(CI)	Continuous Integration
(CM)	Configuration Management
(CMOS)	Complementary Metal Oxide Semiconductors
(COTS)	Commercial-off-the-Shelf
(CRAM)	Chalcogenide Random Access Memory
(CRC)	Cyclic Redundancy Check
(DRAM)	Dynamic Random Access Memory
(ECC)	Error-Correcting Code
(EDAC)	Error Detection and Correction
(EPS)	Electrical Power System
(ES)	Executive Services
(ESSI)	Enhanced Synchronous Serial Interface
(FEC)	Forward Error Correction
(FERAM)	Ferro-Electric Random Access Memory
(FPGA)	Field Programmable Gate Arrays
(FSW)	Flight Software
(GPIO)	General Purpose Input/Output
(GPUs)	Graphics Processor Units
(HIL)	Hardware-in-the-Loop
(I/O)	Input & Output
(I&T)	Integration and Testing
(IMA)	Integrated Mission Architectures



(IoT)	Internet of Things
(ITOS)	Integrated Test and Operations System
(ITOS)	Integrated Test and Operations System
(LVDS)	Low-Voltage Differential Signaling
(MarCO)	Mars Cube One
(MBSE)	Model-Based Systems Engineering
(MRAM)	Magnetoresistive Random Access Memory
(NMF)	NanoSat MO Framework
(NMF)	NanoSat MO Framework
(OSAL)	Operating System Abstraction Layer
(PCM)	Phase Change Memory
(PIL)	Processor-in-the-loop
(PSA)	Payload and Subsystems Avionics
(PZT)	Lead-Zirconium-Titanium Oxide
(rad-hard)	radiation-hardened
(RAM)	Random Access Memory
(ROS)	Robot Operating System
(RTEMS)	Real-Time Executive for Multiprocessor Systems
(RTOS)	Real Time Operating System
(SCFW)	SpaceCloud Framework
(SDK)	Software Development Kit
(SDR)	Software Defined Radios
(SEEs)	Single Event Effects
(SEL)	Single Event Latch-up
(SEU)	Single Event Upsets
(SMP)	Symmetric Multiprocessing
(SRAM)	Static Random Access Memory
(SSA)	Small Spacecraft Avionics
(SWaP)	Size, Weight and Power
(TID)	Total Ionizing Dose
(TMR)	Triple Modular Redundancy
(USB)	Universal Serial Bus





## 8.0 Small Spacecraft Avionics

### 8.1 Introduction

Small Spacecraft Avionics (SSA) are described as all electronic subsystems, components, instruments, and functional elements included in the spacecraft platform. These include primarily flight sub-elements Command and Data Handling (C&DH), Flight Software (FSW), and other critical flight subsystems, including Payload and Subsystems Avionics (PSA). All must be configurable into specific mission platforms, architectures, and protocols, and be governed by appropriate operations concepts, development environments, standards, and tools. The C&DH and FSW are the brain and nervous system of the integrated avionics system, and generally provide command, control, communication, and data management interfaces with all other subsystems in some manner, whether in a direct point-to-point, distributed, integrated, or hybrid computing mode. The avionics system is essentially the foundation for all components and their functions integrated on the spacecraft. As the nature of the mission influences the avionics architecture design, there is a large degree of variability in avionics systems.

Traditional spacecraft avionics have been designed around centralized architectures where each subsystem relies on a single processor whereby if one element fails, then the entire architecture commonly fails. This design often results in heavy weight, high power consumption, large volume, complex interfaces, and weak system reconfiguration capabilities. An open, distributed, and integrated avionics architecture with modular capability in software and hardware design is becoming more appealing for complex spacecraft development needs. In anticipation of extended durations in low-Earth orbit and deep space missions, vendors are now incorporating radiation hardened or radiation-tolerant architecture designs in their small spacecraft avionics packages to further increase their overall reliability. Figure 8.1 illustrates the general functional construct and distribution of a centralized small spacecraft system.

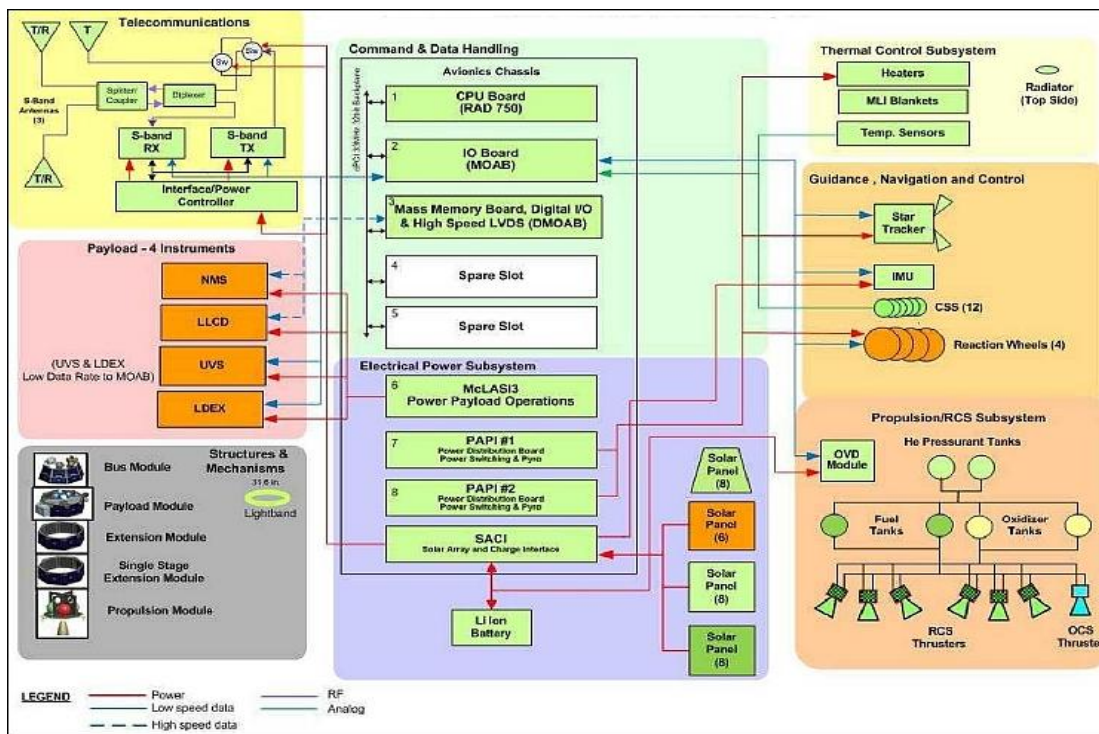


Figure 8.1: Functional block diagram of the LADEE spacecraft. Credit: NASA.

As new generation avionics systems will integrate most of the electronic equipment on the spacecraft, an avionics system designed with networked real-time multitasking distributed system software, which can also implement dynamic reconfiguration of functions and task scheduling and improves the failure tolerance may minimize the need for expensive radiation-hardened electronic components. The improved avionics composition can include high-performance computing hardware to handle the large amount of anticipated data generated by more complex small spacecraft; embedded system software networked for real-time multitasking distributed system software; and software partition protection mechanisms. Some systems now implement a heterogeneous architecture in mixed criticality configurations, meaning they contain multiple processors with varying levels of performance and capabilities.

An example of new generation SSA/PSA distributed avionics application is the integration of Field Programmable Gate Arrays (FPGA)-based software defined radios (SDR) on small spacecraft. A software defined radio can transmit and receive in widely different radio protocols based on a modifiable, reconfigurable architecture, and is a flexible technology that can "enable the design of an adaptive communications system." This can enable the small spacecraft to increase data throughput and provides the ability for software updates on-orbit, also known as re-programmability. Additional FPGA-based functional elements include imagers, AI/ML processors, and subsystem-integrated edge and cloud processors. The ability to reprogram sensors or instruments while on-orbit have benefited several CubeSat missions when instruments do not perform as anticipated, or they enter into an extended mission and subsystems or instruments need to be reprogrammed quickly. Figure 8.2 is a block diagram of an FPGA-based SDR system.

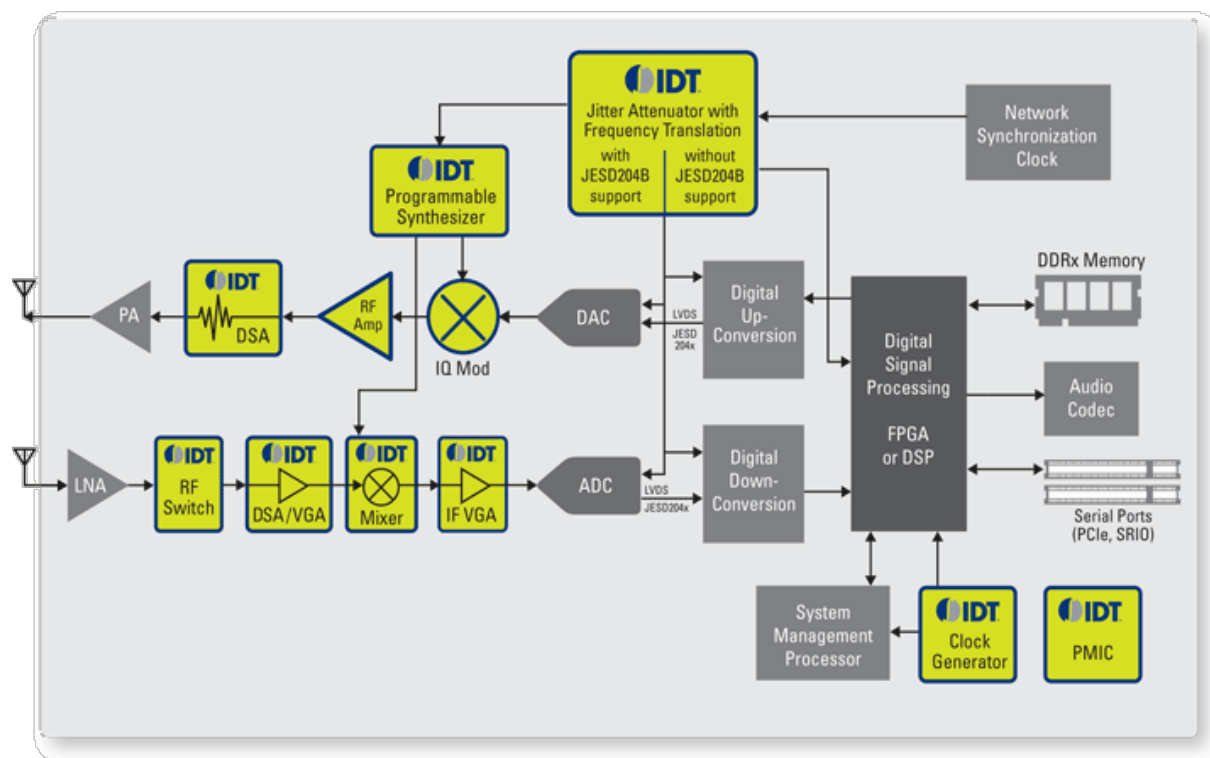


Figure 8.2: Functional block diagram example of a Software Defined radio. Credit: Renesas (IDT is now part Renesas).

## 8.2 Chapter Scope and Organization

This chapter updates and organizes state-of-the-art SSA by combining and integrating two previously separate chapters, C&DH and FSW. Given the distributed and integrated nature of



modern, small spacecraft avionics, flight payload and subsystems avionic elements are also included, but only describes the avionics (electronics) elements, while the more detailed small spacecraft subsystems specifics are discussed in their respective chapters.

The chapter organizes the state-of-the-art in small spacecraft avionics into C&DH (8.3) and FSW (8.4), where modern requirements of avionics systems are identified to meet the need of complex small spacecraft systems, and the technological progression of SSA systems avionics architecture and composition is expanded upon. Some of the challenges this technology may encounter are also identified, and on the horizon activities (TRL <5) (8.5) highlight the development of new generational small spacecraft avionics systems. Finally, a summary discussion of Avionics Systems Platform and Mission Development Considerations (8.6) is provided that discusses how these considerations are being addressed and/or mitigated by state-of-the-art advances in C&DH FSW, and Payload/Subsystems avionics products, and some projections for future Small Spacecraft Avionic systems (8.7).

The information described below is not intended to be exhaustive but provides an overview of current state-of-the-art technologies and their development status. It should be noted that Technology Readiness Level (TRL) designations may vary with changes specific to payload, mission requirements, reliability considerations, and/or the environment in which performance was demonstrated. Readers are highly encouraged to reach out to companies for further information regarding the performance and TRL of described technology. There is no intention of mentioning certain companies and omitting others based on their technologies or relationship with NASA.

### **8.3 State-of-the-Art (TRL 5-9): Command and Data Handling**

Current trends in small spacecraft C&DH generally appear to be following those of previous, larger scale C&DH subsystems. The current generation of microprocessors can easily handle the processing requirements of most C&DH subsystems and will likely be sufficient for use in spacecraft bus designs for the foreseeable future. Cost and availability are likely primary factors for selecting a C&DH subsystem design from a given manufacturer. The ability to spread non-recurring engineering costs over multiple missions, and to reduce software development through reuse, are desirable factors in a competitive market. Heritage designs are desirable for customers looking to select components with proven reliability for their mission. This C&DH Section is organized as follows:

Avionics and on-board computing form factors

1. Highly Integrated On-Board Computing Products
2. Radiation-Hardened Processors and FPGAs
3. Memory, Electronic Function Blocks, and Components
4. Bus Electrical Command and Data Interfaces
5. Radiation Mitigation and Tolerance Schemes

As small satellites move from the early CubeSat designs with short-term mission lifetimes to potentially longer missions, radiation tolerance also comes into play when selecting parts. These distinguishing features, spaceflight heritage and radiation tolerance, are the primary differentiators in the parts selection process for long-term missions, verses those which rely heavily on commercial-off-the-shelf (COTS) parts. Experimental missions typically focused on low-cost, easy-to-develop systems that take advantage of open-source software and hardware provide an easy entry into space systems development, especially for hobbyists or those who lack specific spacecraft expertise.



Small spacecraft C&DH technologies and capabilities have been continuously evolving, enabling new opportunities for developing and deploying next-generation small spacecraft avionics. When small spacecraft were first introduced, a primary purpose was to observe and send information back to Earth. As awareness and utility has expanded, there is a need to improve the overall capability of collecting data in a specific mission environment. Small spacecraft, including nanosatellites and CubeSats, currently perform a wide variety of science in low-Earth orbit and these smaller platforms are emerging as platform candidates for more formidable missions beyond low-Earth orbit.

Since the publication of the earlier editions of this report, several CubeSats using COTS components and integrated systems have successfully flown in the low-Earth orbit environment with short mission durations of typically less than one year. As an example of open-source compilation resources, the Nanosatellite Database (<https://www.nanosats.eu>) describes itself as the “World’s largest database of nanosatellites, [with] over 3000 nanosats and CubeSats...”.

Significant differences in mission requirements between short-term experimental missions and long-term high reliability missions can impact how state-of-the-art is perceived for flight units. As CubeSats become larger and SmallSats become smaller, technology maturation and miniaturization will further increase capabilities. The Mars Cube One (MarCO) mission was the first CubeSat to operate in deep space, and in late 2021 Artemis I will release seven 6U spacecraft into lunar orbit, and five 6U spacecraft that will demonstrate a variety of technologies in deep space. Although not technically a spacecraft, the Mars Helicopter Ingenuity successfully integrated and demonstrated the use of COTS hardware and open-source software during its successful technology demonstration as a component of the NASA Perseverance Mars Rover mission currently in operation on the Mars surface.

As spacecraft manufacturers begin to use more space qualified parts, they find that those devices can often lag their COTS counterparts by several generations in performance but may be the only means to meet the radiation requirements placed on the system. Presently there are several commercial vendors who offer highly integrated systems that contain the on-board computer, memory, electrical power system (EPS), and the ability to support a variety of Input & Output (I/O) for the CubeSat class of small spacecraft. A variety of C&DH developments for CubeSats have occurred due to in-house development by new companies that specialize in CubeSat avionics, and the use of parts from established companies who provide spacecraft avionics for the space industry in general. While parallel developments are impacting the growth of CubeSats, vendors with ties to the more traditional spacecraft bus market are increasing C&DH processing capabilities within their product lines.

In-house designs for C&DH units are being developed by some spacecraft bus vendors to better accommodate small vehicle concepts. While these items generally exceed CubeSat form factors in size, they can achieve similar environmental performance and may be useful in small satellite systems that replicate more traditional spacecraft subsystem distribution. In anticipation of extended durations in low-Earth orbit and deep space missions, vendors are now incorporating radiation hardened or radiation tolerant designs in their CubeSat avionics packages to further increase the overall reliability of their products.

### **8.3.1 Avionics and On-board Computing Form Factors**

The CompactPCI and PC/104 form factors continue generally to be the industry standard for CubeSat C&DH bus systems, with multiple vendors offering components that can be readily integrated into space rated systems. Overall form factors should fit within the standard CubeSat dimension of less than 10 x 10 cm. The PC/104 form factor was the original inspiration to define standard architecture and interface configurations for CubeSat processors. But with space at a premium, many vendors have been using all available space exceeding the formal PC/104 board



size. Although the PC/104 board dimension continues to inspire CubeSat configurations, some vendors have made modifications to stackable interface connectors to address reliability and throughput speed concerns. Many vendors have adopted the use of stackable "daughter" or "mezzanine" boards to simplify connections between subsystem elements and payloads, and to accommodate advances in technologies that maintain compatibility with existing designs. A few vendors provide a modular package which allows users to select from a variety of computational processors.

The form factors used in more traditional spacecraft designs frequently follow "plug into a backplane" VME standards. 3U boards offer a size (roughly 100 x 160 mm) and weight advantage over 6U boards (roughly 233 x 160 mm) if the design can be made to fit in the smaller form factor. It should be noted that CubeSats also use "U" designations, but these refer to the volume of the vehicle based on initial CubeSat standards of 1U (100 x 100 x 100 mm), 3U (100 x 100 x 300 mm), and 6U (100 x 200 x 300 mm). Some small spacecraft bus designers consider using just a single board C&DH unit as a means of saving weight.

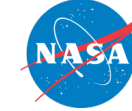
A hybrid form factor configuration is that of the Qseven Computer-on-Module (Q7). "The Qseven concept is an off-the-shelf, multi-vendor, Computer-On-Module that integrates all the core components of a common PC and is mounted onto an application specific carrier board. Qseven modules have a standardized form factor of 70 x 70 mm or 40 x 70 mm and have specified pinouts based on the high speed MXM system connector that has a standardized pinout regardless of the vendor. The Qseven module provides the functional requirements for an embedded application. These functions include, but are not limited to, graphics, sound, mass storage, network and multiple USB ports. A single ruggedized MXM connector provides the carrier board interface to carry all the I/O signals to and from the Qseven module. This MXM connector is a well-known and proven high speed signal interface connector that is commonly used for high-speed PCI Express graphics cards in notebooks (<https://sqet.org/standards/qseven/>).

### **8.3.2 Highly Integrated On-Board Computing Products**

A variety of vendors are producing highly integrated, modular, on-board computing systems for small spacecraft. These C&DH packages combine microcontrollers and/or FPGAs with various memory banks, and with a variety of standard interfaces for use with the other subsystems on board. The use of FPGAs and software-defined architectures also gives designers a level of flexibility to integrate uploadable software modifications to adapt to new requirements and interfaces. Table 8-1 summarizes the current state-of-the-art of these components. Since traditional CubeSat designs are based primarily on COTS parts, spacecraft vendors often try to use parts that have radiation tolerance or have been radiation-hardened (rad-hard), as noted in the pedigree column in table 8-1. The vehicle column shows which spacecraft classification corresponds to each on-board unit; "general satellite" classification refers to larger SmallSat platforms (i.e., larger than CubeSats). It should be noted that while some products have achieved TRL 9 by virtue of a space-based demonstration, what is relevant in one application may not be relevant to another, and different space environments and/or reliability considerations may result in lower TRL assessments. Some larger, more sophisticated computing systems have significantly more processing capability than what is traditionally used in SmallSat C&DH systems, however the increase in processing power may be a useful tradeoff if payload processing and C&DH functions can be combined (note that overall throughput should be analyzed to assure proper functionality under the most stressful operating conditions).

**Table 8-1: Sample of Highly Integrated On-board Computing Systems**

<b>Manufacturer</b>	<b>Product</b>	<b>Processor</b>	<b>Pedigree</b>	<b>Vehicle</b>	<b>TRL</b>	<b>Citation</b>
GomSpace	Nanomind A3200	Atmel AT32UC3C MCU	COTS	CubeSat	Ukn	(1)
ISISPACE	iOBC	ARM 9	COTS	CubeSat	9	(2)
Pumpkin	PPM A1	TI MSP430F1612	COTS	CubeSat	9	(3)
	PPM A2	TI MSP430F1611	COTS	CubeSat	9	
	PPM A3	TI MSP430F2618	COTS	CubeSat	9	
	PPM B1	Silicon Labs C8051F120	COTS	CubeSat	9	
	PPM D1	Microchip PIC24FJ256GA110	COTS	CubeSat	9	
	PPM D2	Microchip PIC33FJ256GP710	COTS	CubeSat	9	
	PPM E1	Microchip PIC24FJ256GB210	COTS	CubeSat	9	
Xiphos	Q7S	Xilinx Zynq 7020 Arm 9	COTS w/SEE mitigation	Nano-, Micro- and SmallSats	9	(4)
	Q8S	Xilinx Ultrascale+ ARM Cortex-A53	COTS w/SEE mitigation	Nano- Micro- and SmallSats	8	(5)
BAE	RAD750	RAD750	rad-hard	General Satellite	9	(6)
	RAD5545	RAD5545	rad-hard by design	General Satellite	Ukn	(7)
AAC Clyde Space	Kryten-M3	SmartFusion Cortex-M3	COTS	CubeSat	Ukn	(8)
	Sirius OBC	SmartFusion Cortex-M3	COTS w/SEE mitigation	CubeSat	Ukn	(9)

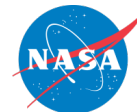


Innoflight	cfc-300	Xilinx Zynq ARM Cortex A9	COTS	CubeSat	Ukn	(10)
	cfc-400	Xilinx Zynq Ultrascale+	COTS	CubeSat	Ukn	(11)
	cfc-500	Xilinx Kintex Ultrascale+ NVIDIA TK1	COTS	CubeSat	Ukn	(12)
Space Micro	CSP	Xilinx Zynq-7020 Dual ARM Core	COTS	CubeSat	Ukn	(13)
NanoAvionics	SatBus 3C2	STM32 ARM Cortex M7	COTS	CubeSat	9	(14)
MOOG	G-Series Steppe Eagle	AMD G-Series compatible	Rad Hard by design	General Satellite	Ukn	(15)
	V-Series Ryzen	AMD V-Series compatible	Rad Hard by design	General Satellite	Ukn	
SEAKR	Athena-3 SBC	PowerPC e500	Ukn	General Satellite	9	(16)
	Medusa SBC	PowerPC e500	Ukn	General Satellite	9	
	RCC5	Virtex 5 FX-130T	Ukn	General Satellite	9	
Unibap	iX10-100	Microchip PolarFire FPGA with RISC-V , AMD V1605b (Ryzen) CPU and GPU, and up to 3 Intel Movidius Myriad X VPUs and optional NVMe based compute storage (up to 8 TB)	COTS with SEE mitigation	Nano-, Micro- and SmallSats	5	(41)
	iX5-100	Microchip SmartFusion2 ARM Cortex-M3 and AMD G-Series SOC	COTS with SEE mitigation	Nano-, Micro- and SmallSats	8	(19)
	e2160	Microchip SmartFusion2 FPGA with ARM Cortex- M3 and AMD 2 <sup>nd</sup>	COTS with SEE mitigation	Nano-, Micro- and SmallSats	9	(18)



		generation G-Series SOC CPU and GPU				
	e2155	Microchip SmartFusion2 FPGA with ARM Cortex- M3 and AMD 1 <sup>st</sup> generation G-Series SOC CPU and GPU	COTS with SEE mitigation	Nano-, Micro- and SmallSats	9	(18)
Ibeos	EDGE Computer	Nvidia TK1	COTS with Single Event Effects and TID Characterizat ion. Radiation- tolerant with single event effects mitigation	CubeSat, general SmallSat, ESPA-class satellite and larger	6	(42)





System developers are gravitating towards ready-to-use hardware and software development platforms that can provide seamless migration to higher performance architectures. As with non-space applications, there is a reluctance to change controller architectures due to the cost of retraining and code migration. Following the lead of microcontrollers and FPGA vendors, CubeSat avionics vendors are now providing simplified tool sets and basic, cost-effective evaluation boards.

Two such example units have been identified which may be able to support small satellite designs beyond the CubeSat form factors (see table 8-2). Spacecraft bus vendors may also have preferred sources for C&DH units, such as those developed in-house.

<b>Table 8-2: Sample of Small C&amp;DH Units</b>						
<b>Vendor</b>	<b>Unit</b>	<b>Mass (kg)</b>	<b>Power (W)</b>	<b>Processor</b>	<b>MIPs</b>	<b>References</b>
Moog	C&DH Avionics unit	< 3	25	BRE 440	266	(17)
SEAKR	C&DH Avionics unit	5.4	14	LEON	25	(16)

### **8.3.3 Radiation-Hardened Processors and FPGAs**

An example of an FPGA-based C&DH System, the FPGA functions as the Main Control Unit, with interfaces to all functional subcomponents of a typical C&DH system. This then enables embedded, adaptive, and reprogrammable capabilities in modular, compact form factors, and provides inherent architectural capabilities for processor emulation, modular redundancies, and “software-defined-everything.”



Several radiation-hardened embedded processors have recently become available. These are being used as the core processors for a variety of purposes including C&DH. Some of these are the Vorago VA10820 (ARM M0) and the VA41620 and VA41630 (ARM M4); Cobham GR740 (quad core LEON4 SPARC V8) and the BAE 5545 quad core processor. These have all been radiation tested to at least 50 kRad total ionizing dose (TID).

Xilinx and Microchip (formerly Microsemi), leaders in the space-grade FPGA market, have both released new radiation-tolerant FPGA families in the past two years rated to 100 kRad TID. The Xilinx RT Kintex UltraScale, a 20 nm device, has 726 k logic cells and supports 12.5 Gbps serial data transmission. The Microchip RT PolarFire is a 28 nm device with 481k logic cells and up to 10.3125 Gbps data transmission. These both offer far more capability than either company's previous families of rad-tolerant FPGA (Xilinx Virtex-5 and Microchip RTG4) and may be adopted for more complex payload data processing needs than merely C&DH use. The Kintex UltraScale is integrated within the Innoflight CFC-500 and Moog Steppe Eagle and Ryzen, listed in the table above.

### 8.3.4 Memory, Electronic Function Blocks, and Components

The range of on-board memory for small spacecraft is wide, typically starting around 32 KB and increasing with available technology. For C&DH functions, on-board memory requires high reliability. A variety of different memory technologies have been developed for specific traits, including Static Random Access Memory (SRAM), Dynamic RAM (DRAM), flash memory (a type of electrically erasable, programmable, read-only memory), Magnetoresistive RAM (MRAM), Ferro-Electric RAM (FERAM), Chalcogenide RAM (CRAM) and Phase Change Memory (PCM). SRAM is typically used due to price and availability. A chart comparing the various memory types and their performance is shown in table 8-3.

<b>Feature</b>	<b>SRAM</b>	<b>DRAM</b>	<b>Flash</b>	<b>MRAM</b>	<b>FERAM</b>	<b>CRAM/ PCM</b>
Non-volatile	No	No	Yes	Yes	Yes	Yes
Operating Voltage, $\pm 10\%$	3.3 – 5 V	3.3 V	3.3 & 5 V	3.3 V	3.3 V	3.3 V
Organization (bits/die)	512 k x 8	16 M x 8	16 M x 8; 32 M x 8	128 k x 8	16 k x 8	Unk
Data Retention (@ 70°C)	N/A	N/A	10 years	10 years	10 years	10 years
Endurance (Erase/Write cycles)	Unlimited	Unlimited	10 <sup>6</sup>	1013	1013	1013
Access Time	10 ns	25 ns	50 ns after page ready; 200 s write; 2 ms erase	300 ns	300 ns	100 ns
Radiation (TID)	1 Mrad	50 krad	30 krad	1 Mrad	1 Mrad	1 Mrad
SEU rate (relative)	Low-nil	High	Nil (cells); Low (device electronics)	Nil	Nil	Nil
Temperature Range	Mil-std	Industrial	Commercial	Mil-std	Mil-std	Mil-std
Power	500 mW	300 mW	30 mW	900 mW	270 mW	Unk



Package	4 MB	128 MB	128 – 256 MB	1 MB	1.5 MB (12 chip package)	Unk
---------	------	--------	--------------	------	--------------------------------	-----

There are many manufacturers that provide a variety of electronic components that have high reliability and are space rated (see table 8-4 for a noncomprehensive list). A visit to any of their respective websites will show their range of components and subsystems including processors, FPGAs, SRAM, MRAM, bus interfaces, Application Specific Integrated Circuits (ASICs), and Low-Voltage Differential Signaling (LVDS).

Apogee Semiconductor (USA)	Honeywell (USA)	STMicroelectronics (Switzerland)
BAE Systems (UK)	Intel (USA)	Texas Instruments (USA)
Moog Broad Reach (USA)	Renesas (Japan)	3D Plus (USA)
Space Micro, Inc. (USA)	SEAKR (USA)	Xilinx (USA)
Cobham (Aeroflex, Gaisler) (Sweden)	Microchip (USA)	Vorago Technologies (USA)

### 8.3.5 Bus Electrical Interfaces

CubeSat class spacecraft continue to use interfaces that are common in the microcontroller or embedded systems world. Highly integrated systems, especially SoC, FPGA and ASICs, will typically provide several interfaces to accommodate a wide range of users and to ease the task of interfacing with peripheral devices and other controllers. FPGAs are commonly used for these interfaces because of their flexibility and ability to change interfaces if needed. Some of the most common bus electrical interfaces are listed below with a brief description of applicable interface standards:

- Serial Communication Interfaces (SCI): RS-232, RS-422, RS-485 etc.
- Synchronous Serial Communication Interface: I2C, SPI, SSC and ESSI (Enhanced Synchronous Serial Interface)
- Multimedia Cards (SD Cards, Compact Flash etc.)
- Networks: Ethernet, LonWorks, etc.
- Fieldbuses: CAN Bus, LIN-Bus, PROFIBUS, etc.
- Timers: PLL(s), Capture/Compare and Time Processing Units
- Discrete IO: General Purpose Input/Output (GPIO)
- Analog to Digital/Digital to Analog (ADC/DAC)
- Debugging: JTAG, ISP, ICSP, BDM Port, BITP, and DB9 ports
- SpaceWire: a standard for high-speed serial links and networks
- High-speed data: RapidIO, XAUI, SERDES protocols are common in routing large quantities of mission data in the gigabit per second speeds

### 8.3.6 Radiation Mitigation and Tolerance Schemes

Deep space and long-duration low-Earth orbit missions will require developers to incorporate radiation mitigation strategies into their respective designs. The CubeSat platform has traditionally used readily available COTS components. Use of COTS parts has allowed for low-cost C&DH development, while also allowing developers to take advantage of state-of-the-art technologies in their designs. Many of the component and system vendors also provide radiation hardened (rad-



hard) equivalent devices as well. While there are many commercially available rad-hard components, using these components impacts the overall cost of spacecraft development. To keep costs as reasonable as possible, C&DH developers will need to address appropriate use of rad-hard components, along with other radiation mitigation techniques for developing an overall radiation tolerant design as discussed in the following section.

For space applications, radiation can damage electronics in two ways. TID is the amount of cumulative radiation received, and single event effects (SEEs) are disturbances created by single particles hitting the electronics (20). Total dose is measured in kilorads and can affect transistor performance. Single Event Upsets (SEU) can affect the logic state of memory. A Single Event Latch-up (SEL) can affect the output transistors on Complementary Metal Oxide Semiconductors (CMOS) logic, potentially causing a high-current state.

This section summarizes techniques used to mitigate system failures caused by radiation effects. C&DH element areas of consideration include: memory, imaging, protection circuits (watchdog timers, communications watchdog timers, overcurrent protection, and power control), memory protection (error-correction code memory and software error detection and correction), communication protection (several components), and parallel processing and voting.

### **Memory**

FRAM is a non-volatile random-access memory that is persistent like Flash memory. FRAM memory cells are latched using a Lead-Zirconium-Titanium oxide (PZT) film structure, which is more likely to maintain state during a single event effect than traditional capacitive latches found in RAM (21) (22).

MRAM is another type of non-volatile random-access memory that is persistent. It is different than FRAM and others in that it has virtually unlimited read and write cycle endurance. MRAM has been built into some processors (TI MSP430FR) as well as separate chips.

### **Imaging**

Charge Couple Devices (CCD) and CMOS are image sensors that are useful in radiation environments. However, CCDs are preferred in space applications, while the CMOS detectors are a newer technology for rad hardened image sensors (23) (24) (25) (26).

### **Protection Circuits**

#### **Watchdog Timers**

Watchdog timers are often used to monitor the state of a processor. A watchdog timer is a hardware circuit, external or internal to the processor, which resets the processor when the timer expires unless refreshed by the processor. If the processor jumps to an erroneous memory location through a SEU or a software exception, the watchdog timer resets the processor to restore operations.

#### **Communication Watchdog Timer**

A dedicated communication watchdog timer circuit can monitor commands and responses to determine if the system is locked up. Such a circuit resets power after a specific number of failed transmissions.

#### **Overcurrent Protection**

Single Event Latch-up (SEL) can cause device failure due to an elevated current state. Hardware and software overcurrent protection can be implemented to watch for elevated current levels and



then issue a power reset to the offending circuit. The sampling frequency for software overcurrent protection must be sufficient to detect and reset the subsystem before the elevated current causes permanent damage. For hardware protection, a shunt resistor and bypass diode can be used in conjunction to filter voltage and current spikes for rad hardened devices.

#### Power Control

Since many components are more prone to radiation effects when powered on, a candidate mitigation strategy is to power off devices when they are not operationally needed.

### **Memory Protection**

#### Error-Correcting Code Memory

Error-Correcting Code (ECC) memory is capable of detecting and correcting bit errors in RAM and flash memory. In general, ECC works by storing a checksum for a portion of the memory. This checksum can be used to simply mark a portion of memory unstable. Additional processing can use the memory and checksums to correct single and sometimes multi-bit errors. The memory controller is responsible for managing the ECC memory during read and write operations (30).

#### Software Error Detection and Correction

Bit errors can be detected and corrected using software. In general, Error Detection and Correction (EDAC) algorithms use Hamming codes or three copies of the memory to detect and correct bit discrepancies. Software routinely "scrubs" the memory, compares each of the three stored memory values, selects the majority value, and corrects the erroneous memory location. Software EDAC can be performed at the bit or byte level. Memory lifetime needs to be considered for software EDAC implementations, since every correction increases the write count to a memory location.

### **Communication Protection**

#### Shared Bus Switching

Another option is to decouple the clock and data lines so that each peripheral has its own pair. Additional data lines can be used on the master controller. Alternatively, an external FPGA could be used to assign a unique clock/data pair to each peripheral and, optionally, include a method to reconfigure those assignments in flight.

#### Cyclic Redundancy Check

Cyclic Redundancy Check (CRC) is a common method for detecting memory or communication errors. Parity is a single-bit implementation of a CRC where the bit of summary information is calculated by the XOR of the data to be communicated or stored to memory. For communication channels, a CRC is calculated prior to sending the message, and is appended to the message stream in a known location. When the message is received, the CRC is calculated again and compared to the previously generated CRC appended to the data stream. For memory, the CRC is calculated prior to writing the data to memory. When the data is read out, a new CRC is calculated and compared to the previously generated CRC. CRCs help detect data corruption but cannot be used to correct the defective data.

#### Forward Error Correction



Forward Error Correction (FEC) transmits redundant data to help the receiver recover corrupted data. In its simplest form, FEC could transmit three bits for every bit of data and then vote to restore the original data. More efficient algorithms balance the data overhead with the correction accuracy (27).

### **Parallel Processing and Voting**

#### Triple Modular Redundancy

SEU can interrupt discrete logic, including processing. Triple Modular Redundancy (TMR) is a fault mitigation technique where logic is replicated three times, and the output of the logic is determined by a majority vote.

#### Firmware Protection

Many spacecraft subsystems include a processor to handle and optimize operations. These processors require firmware which is written into onboard program memory. Like data memory, program memory is also susceptible to single-event upsets and device failure. To counter this issue, a bootloader may be used to check the validity of the firmware and provide a mechanism for uploading new versions. Additionally, multiple copies of the firmware may be stored in memory in case the primary version is corrupt.

## **8.4 State-of-the-Art (TRL 5-9): Flight Software**

The FSW is, at a fundamental level, the instructions for the spacecraft to perform all operations necessary for the mission. These include all the science objectives as regular tasks (commands) to keep the spacecraft functioning and ensure the storage and communication of data (telemetry). The FSW is usually thought of as the programs that run on the C&DH avionics but should also include all software running on the various subsystems and payload(s).

There are many factors in the selection of a development environment and/or operating system used for a space mission. A major factor is the amount of memory and computational resources. There are always financial and schedule concerns. Another factor is what past software an organization may have used and their experiences with that software. Also, the maturity of the software as well as its availability on the target are additional factors to be considered in the final selection.

Flight Software complexity refers to the amount of operations to be performed and is not based on the size of the spacecraft, only the overall requirements and mission objectives. The more software is required to do, the bigger the task and cost. This complexity is what primarily drives the cost and schedule for the program or mission. Required reliability and fault management can also increase complexity and cost, regardless of the size of the spacecraft.

With the increase in processing capability with C&DH and other processors, more capabilities have been enabled with FSW. Previously, larger processors have only been in larger spacecraft and would not be possible in CubeSats and MicroSats. There have been several advances that make more processing capability now available for CubeSats. Low-power ARM-based processors, as well as advances in radiation hardened processors, have brought similar processing capabilities down to the small size of CubeSats. All of this has brought increased demands and requirements on FSW.

FSW must operate in a real-time environment. This definition can have numerous interpretations. Generally, C&DH and other subsystems need to be able to supervise several inputs and outputs as well as process and store data within a fixed time-period. These all need to be performed in a



reliable and predictable fashion throughout the lifetime of the mission. The needs of each mission can vary greatly, but this basic deterministic and reliable processing is a fundamental requirement.

#### **8.4.1 Implication of C&DH Processors on FSW**

The processor and memory available on the C&DH can put significant limitations on the FSW. For some of the smaller jobs, or to reduce electronic complexity, smaller processors are used. These have typically been thought of as embedded processors, with many of them containing dedicated memory. Modern integrated space avionics, including heterogeneous and mixed criticality architectures, also impact the nature and operational constructs, and can contribute to advanced configurations such as Multiple Modular Redundant systems architectures which can allow advanced paradigms for radiation tolerance and system redundancies in critical small spacecraft missions.

Software code and programs are very integrated with the hardware, requiring careful implementation and integration. Software development environments for these kinds of processors usually come from the microprocessor themselves, or from third party vendors. Some of the past tools (and processors used) have been MPLAB (Microchip PIC family), and TI CCStudio (TI MSP430). On some of these types of processors a “bare bones” approach to the software design is usually implemented with limited to no operating system. This is primarily because of memory and processor limitations. These programs tend to be highly optimized. Part of the challenge with these systems is development and testing. Most interactions with the software must be done remotely through a secondary processor, usually a PC. This type of development usually requires unique skills and can involve a significant learning curve for developers. Efficient programmers need to have a good understanding of both the software and hardware and how they function together. Timing and performance matter greatly, so that they need to be able to write code in an efficient manner. Typically, these projects have up to 20,000 lines of code.

Larger processors have been increasing in popularity with current missions, especially CubeSats. With increases in power production as well as lower power processors, radiation tolerant processors have been available in both SmallSats and CubeSats. Several vendors have large processors that can run Real-Time Operating Systems (RTOS) such as VxWorks, RTEMS and FreeRTOS that were described earlier. Linux has been used, usually with real-time extensions. In other instances, functionality is distributed between a large capability processor and a smaller dedicated flight controller whereby the controller conducts and manages the real-time aspects, allowing efficient management of power and operational complexity. These give software developers a significant advantage with a software development environment and usually a base implementation on the processing target. RTOS have been designed to operate in minimal processor/memory environments with real-time needs. These projects typically have for small projects 50K to 70K lines of code, to larger projects that can exceed a million.

This FSW Section is organized as follows:

1. Frameworks: In the context of Small Spacecraft Avionics, a Flight Software Framework can be described as a hierarchal systems-of-systems architecture, sometimes described as a set of Lego-like building block constructs, partitions, and functions
2. Operating Systems (OS): System software that manages computer hardware, software resources, and provides common services for computer programming.
3. Software Languages: System programming involves designing and writing computer programs that allow the computer hardware to interface with the programmer and the



user, leading to the effective execution of application software on the computer system (Techopedia).

4. Mission Operations Suites: Software and systems used to monitor, control, communicate, and display command, control, status, and data dissemination of all aspects of a space mission, include spacecraft performance and procedures, systems health, science and technology data handling and management, and telemetry tracking and control.
5. Development environment, standards, and tools: the collection of hardware and software systems tools to design, develop, validate, and operate small spacecraft missions, with adherence to accepted software and space mission standards.

#### 8.4.2 Frameworks

##### cFS – <https://cfs.gsfc.nasa.gov>

The core Flight System (cFS) is a generic flight software architecture framework. cFS has been used in dozens of space missions ranging from flagship spacecraft to small satellite and CubeSats. cFS is actively being used in a number of missions both in flight and in development. The core Flight Executive (cFE) and Executive Services (ES) are a set of applications, application framework, and runtime environment developed by Goddard Space Flight Center. cFE includes core services like messaging, timekeeping, events, and table-driven commanding and configuration (18). cFS is built on an Operating System Abstraction Layer (OSAL) that leads to the same code base running on different operating systems. cFS provides most of the basic functionality to operate a spacecraft. The core Flight System, as well as supporting infrastructure, has been used by NASA on numerous missions and is being used by other organizations. cFS, as well as the supporting OSAL, are open-source and currently released under the Apache 2.0 license (29).

##### F' – <https://github.com/nasa/fprime>

F' is a software framework for rapid development and deployment of embedded systems and spaceflight applications. Originally developed at JPL, F' is open-source software that has been successfully deployed for several space applications. It has been used for, but is not limited to, CubeSats, SmallSats, instruments, and deployables. F' is currently released under the Apache 2.0 license (33, 34). Most recently, F' was used to operate the Mars Helicopter, Ingenuity, along with other open-source SW and HW products.

##### NanoSat Mission Operations Framework – [https://en.wikipedia.org/wiki/NanoSat\\_MO\\_Framework](https://en.wikipedia.org/wiki/NanoSat_MO_Framework)

From the above webpage: "...The NanoSat MO Framework (NMF) is a software framework for nanosatellites based on [Consultative Council for Space Data Systems] (CCSDS) Mission Operations services. It facilitates not only the monitoring and control of the nanosatellite software applications, but also the interaction with the nanosatellite platform. This is achieved by using the latest CCSDS standards for monitoring and control, and by exposing services for common peripherals among nanosatellite platforms. Furthermore, it is capable of managing the software on-board by exposing a set of services for software management.<sup>[1]</sup>

In simple terms, it introduces the concept of apps in space that can be installed, and then simply started and stopped from the ground. Apps can retrieve data from the nanosatellite platform through a set of well-defined platform services. Additionally, it includes CCSDS standardized services for monitoring and control of apps. An NMF App can be easily developed, distributed, and deployed on a spacecraft.<sup>[2]</sup>





There is a Software Development Kit (SDK) to help develop software based on the NanoSat MO Framework. This SDK allows quick development of software that can run on ground and/or in space. The reference implementation of the NanoSat MO Framework will be used in ESA's OPS-SAT mission.”

### **SpaceCloud**

The SpaceCloud Framework (SCFW) revolutionizes satellite software development, converting purpose-built, custom space hardware into flexible and reusable compute nodes. This allows for simplified space missions, providing an all-inclusive solution for on-orbit data processing and on the ground management software. Like cloud computing on ground, it also allows orchestration of operations each node (or satellite) will perform, including approving execution of applications and upgrading the SCFW software. SpaceCloud® offers common types of cloud resources such as processors, GPU or dedicated AI accelerators, and in some cases optimized resources in FPGA technology. For storage, the S3 application programming interfaces (API) is compatible with Amazon Web Services. Machine learning and inference can be done with TensorFlow, TVM, PlaidML, OpenVINO / OneAPI, among others.

### **ROS – [https://en.wikipedia.org/wiki/Robot\\_Operating\\_System](https://en.wikipedia.org/wiki/Robot_Operating_System)**

Taken directly from webpage: “...Robot Operating System (ROS or ros) is an open-source robotics middleware suite. Although ROS is not an operating system but a collection of software frameworks for robot software development, it provides services designed for a heterogeneous computer cluster such as hardware abstraction, low-level device control, implementation of commonly used functionality, message-passing between processes, and package management. Running sets of ROS-based processes are represented in a graph architecture where processing takes place in nodes that may receive, post and multiplex sensor data, control, state, planning, actuator, and other messages. Despite the importance of reactivity and low latency in robot control, ROS itself is not a Real Time Operating System (RTOS). It is possible, however, to integrate ROS with real-time code.[3] The lack of support for real-time systems has been addressed in the creation of ROS 2.0,[4][5][6] a major revision of the ROS API which will take advantage of modern libraries and technologies for core ROS functionality and add support for real-time code and embedded hardware.”

### **8.4.3 Operating Systems**

#### **VxWorks**

Windriver calls VxWorks the industry-leading RTOS. VxWorks is fully featured and has been used by the industry for many years, and by NASA for over 20 years since the Clementine mission. It is used in satellites as well as robotics such as Robonaut and MER. It has many features of a user operating system with tasks and processes, memory protection and separation. VxWorks has a commercial license, with several advanced development and diagnostic tools licensed separately. Due to the cost, VxWorks needs to be budgeted for the life of the mission.

VxWorks currently supports 32-, 64-bit, and multi-core processors including Intel, Arm, Power Architecture and RISC-V. Multi-core processors support both asymmetric and symmetric multiprocessing. There are numerous board support packages for enabling early prototyping and aiding software development (31).

#### **RTEMS**

From the RTEMS.org website: “the Real-Time Executive for Multiprocessor Systems (RTEMS) is an open-source RTOS that supports open standard API such as POSIX. It is used in space flight, medical, networking and many more embedded devices. RTEMS currently supports 18 processor architectures and approximately 200 [broadband service providers] (BSPs). These include ARM,



PowerPC, Intel, SPARC, RISC-V, MIPS, and more. RTEMS includes multiple file systems, symmetric multiprocessing (SMP), embedded shell, and dynamic loading, as well as a high-performance, full-featured IPV4/IPV6 TCP/IP stack from FreeBSD which also provides RTEMS with USB.”

RTEMS is considered open-source, released under a modified GNU General Public License. Support is available through the primary manager OAR. It has been sponsored, deployed, and used widely on several NASA and ESA missions. RTEMS has been in development since the 1980s. RTEMS could be considered a simpler operating system with no provided memory or process management. Although build environments are provided, development tools are not as featured as commercial products (32).

### FreeRTOS

FreeRTOS is a small, real-time operating system kernel designed for embedded devices. It is open-source and released under the MIT license. FreeRTOS is designed to be small and simple; however, it lacks some of the more advanced features found on larger operating systems. FreeRTOS has been used on several CubeSat projects where memory is limited.

### Linux

Linux is another operating system that is being implemented on several spacecraft. Linux is deployed on PowerPC-, LEON-, and ARM-based processors. It is readily available and widely used in both government and commercial sectors. There are several distributions and guides that have been developed for embedded use that would be suitable for spacecraft use. Some of the distributions have been Yocto (Xilinx ZYNQ) and Debian (BeagleBone Black and PowerPC). There are real-time extensions, as well as additional extensions such as Xenomai, to improve critical real-time performance. Numerous development and diagnostic tools are available. Linux is a full featured operating system that has been used for desktop applications. Linux tends to be larger, requiring more memory and processing capability. It is popular on the ARM processors because those issues tend not to be a factor.

### Debian – <https://en.wikipedia.org/wiki/Debian>

Taken directly from webpage: “Debian also known as Debian GNU/Linux, is a Linux distribution composed of free and open-source software, developed by the community-supported Debian. The Debian Stable branch is the most popular edition for personal computers and servers. Debian is also the basis for many other distributions, most notably Ubuntu. Debian is one of the oldest operating systems based on the Linux kernel.”

#### 8.4.4 Software Languages

Rather than list details for each listed software language, reference links to examples of relevant software languages are provided from Wikipedia and other sources listed below in table 8-5.

Software Language	Wikipedia page
C	<a href="https://en.wikipedia.org/wiki/C_(programming_language)">https://en.wikipedia.org/wiki/C_(programming_language)</a>
C++	<a href="https://en.wikipedia.org/wiki/C%2B%2B">https://en.wikipedia.org/wiki/C%2B%2B</a>
Python	<a href="https://en.wikipedia.org/wiki/Python_(programming_language)">https://en.wikipedia.org/wiki/Python_(programming_language)</a>
Arduino	<a href="https://en.wikipedia.org/wiki/Arduino">https://en.wikipedia.org/wiki/Arduino</a>
Assembly Language	<a href="https://en.wikipedia.org/wiki/Assembly_language">https://en.wikipedia.org/wiki/Assembly_language</a>



### 8.4.5 Mission Operations and Ground Support Suites

Although not directly used on the spacecraft, operators need a way to talk to the spacecraft, and ground operations and testing need that same capability. For smaller spacecraft and missions, it is usually best to use the same ground support software for these three tasks: mission operations, integration and testing, and development and testing. There are numerous proprietary tools and programs, but a small set of tools that have been used at NASA are described below. For more information, please refer to the Ground Data System and Mission Operations chapter.

Integrated Test and Operations System (ITOS) is a space ground system developed for GSFC by the Hammers Company ITOS (37). It is a comprehensive command and telemetry solution for spacecraft, component, and instrument development, integration, testing, and mission operations. It is highly user configurable, and provides a scalable, cost-effective platform for small-budget projects to billion-dollar observatories. It includes multi-spacecraft control and closed-loop simulation capabilities.

Advanced Spacecraft Integration and System Test (ASIST) is also a space ground system developed for GSFC by Design America, Inc. ASIST provides satellite telemetry and command processing for integration and testing (I&T) and operations environments (38). ASIST is described as “an object-oriented, real-time command and control system for spacecraft development, integration, and operations. Mature and reliable, ASIST has logged hundreds of thousands of hours in component development, spacecraft integration, and validation labs.”

INCONTROL is a proprietary tool developed by L3HARRIS. Some of the features include providing support for single-mission, multi-mission, and constellation support. It also provides capabilities for automation, event logging, data distribution, procedure development, archiving, data displays, equipment monitor and control, data retrieval, report generation, and simulation (39).

#### **COSMOS – <https://www.ball.com/aerospace/programs/cosmos>**

COSMOS is a tool developed by Ball Aerospace that provides a framework for operating and testing an embedded system (40). COSMOS is open-source, licensed under the MIT license. The tool includes modules for telemetry display, plotting, scripting, logging, and configuration table management.

#### **Yamcs – <https://yamcs.org>**

Yamcs is an open-source software framework for command and control of spacecraft, satellites, payloads, ground stations and ground equipment. Yamcs /jæmz/ is open-source software developed by Space Applications Services, an independent Belgian company, with a subsidiary in Houston, USA. The aim of Space Applications Services is to research and develop innovative systems, solutions and products and provide services to the aerospace and security markets and related industries. Activities cover manned and unmanned spacecraft, launch/re-entry vehicles, control centers, robotics and a wide range of information systems. Yamcs is developed around the criteria of flexibility and open-source code to innovate, reduce MCS development, implementation and integration costs through easy expandability, scalability, and adaptability over time.

### 8.4.6 Development Environment, Standards, and Tools

Most software development tools that are used for FSW are also used in the overall software development industry. Common version control tools are Git and Subversion. More large projects are switching to the Git repository due to its distributed nature and merging features. The NASA cFS project uses Git and is sourced on <https://github.com/>.



Additional tools have been used with these version control tools to provide more process control and configuration management. The Atlassian tools are an example of these that interface directly to Git or Subversion and provide issue/bug tracking (Jira), documentation (Confluence), continuous integration (Bamboo) and others. The Atlassian tools are a licensed product that is free for trial and suitable for a small number of users. There are several other tools for each of these functions that are used. For instance, Trac is an open-source, web-based project management and bug tracking system.

### **Model-Based Systems Engineering (MBSE)**

Excerpted from (<https://www.omgwiki.org/MBSE/doku.php?id=start>)

“The Object Management Group Standards Development Organization, in accordance with The INCOSE SE Vision 2020 (INCOSE-TP-2004-004-02 September, 2007), defines Model-based systems engineering (MBSE) as “the formalized application of modeling to support system requirements, design, analysis, verification and validation activities beginning in the conceptual design phase and continuing throughout development and later life cycle phases. MBSE is part of a long-term trend toward model-centric approaches adopted by other engineering disciplines, including mechanical, electrical and software. In particular, MBSE is expected to replace the document-centric approach that has been practiced by systems engineers in the past and to influence the future practice of systems engineering by being fully integrated into the definition of systems engineering processes.” Applying MBSE is expected to provide significant benefits over the document centric approach by enhancing productivity and quality, reducing risk, and providing improved communications among the system development team.

Modeling has always been an important part of systems engineering to support functional, performance, and other types of engineering analysis. Wayne Wymore introduced a mathematical foundation for MBSE in his book entitled *Model-Based Systems Engineering* in 1993. However, the growth in computing technology and the introduction of modeling standards such as SysML, UPDM, Modelica, HLA, and others, are helping to enable MBSE as a standard practice, and provide a foundation to integrate diverse models needed to fully specify and analyze systems....”

### **Auto-Generation of Software**

Automatic generation of source code from higher symbolic languages is being adopted by a wide number of missions. This technique is commonly being used by several NASA centers including ARC, GSFC and JSC. Key advantages of using this approach are rapid development and testing, and significant time and cost savings. There are a variety of tools that have been used in the past, but the most popular is MATLAB/Simulink. This allows an engineer to completely develop the algorithms in a graphical or higher-level language and have flight code automatically generated. Simulations and tests are also developed within MATLAB/Simulink. A common way that these kinds of tools are used are within the GNC development, but other missions such as LADEE have used it for almost the entire FSW with over 85% of the new code generated in this manner (35, 36).

Using these tools has advantages. They are designed for analysis and have built-in simulation tools. They are usually seen as being easier to understand due to their graphical nature. These tools are familiar to many engineers since they have been used by several colleges and universities. One thing to be aware when developing software with this method is that good modeling practices need to be adopted so that the resultant models produce good code. These include all the best practices performed with traditional software development. An example is to establish and use modeling guidelines so that the resultant code is consistent.



## Simulations and Simulators

Simulations are needed to fully test software before release to verify and help validate the software. In a sense, unit tests are very simple simulations. Overall simulations need to be large enough to run all released flight software. The preferred method is to test all the FSW in an integrated fashion. If that cannot be performed, then partial tests may have to be performed. The testing should be designed to cover all executed code. The issues of not testing all the code is that total execution performance and possible interactions between modules may not be tested. Scenarios or a “day in the life” tests should be covered, as well as off-nominal fault recovery.

Simulators usually refer to the hardware and infrastructure needed to run the FSW and simulations. The main part of the simulation is the actual FSW. This should be run on a processing environment as close to the flight processor as possible. For some situations, that can be an actual spare flight unit. For some processors that are costly, such as the RAD750, either an engineering unit or a similar PowerPC processor that is binary compatible may be used. These processors are either connected to actual hardware interfaces that are connected to spacecraft subsystems, or subsystem simulators. These types of simulators are referred to as Hardware-in-the-Loop (HIL) simulators because they use actual hardware for testing. The other type of simulator is a processor-in-the-loop (PIL) simulator where a flight-like processor is tested against simulations of the hardware and subsystems. Depending on the environment and processing load, this is usually done in a separate processor, but can be done on a single flight-like processor. The simulation portion (non-flight software) is almost always preferred to be executed on a separate processor so that interference with the flight software is minimized or eliminated.

NASA Ames has created a development environment where the same flight executable can be executed on a flight-like processor in simulation. This is done by simulating each of the interfaces through a standard POSIX interface and having the flight executable talk to that interface. Lower-level interface communication can then occur either through a hardware interface (flight-like), or UDP Ethernet (simulation) based on the simulator configuration.

## Software Best Practices and NPR7150

Software can be complex and overwhelming because of the large scope and unique nature of software development. Additionally, flight software can be costly and have reliability issues because it can be large in scope, complex, and there are significant difficulties with testing in a flight-like environment. To help address developmental challenges, software development has created best practices. These can be implemented several ways but encompass some basic elements. Some software best practices include:

- Create a plan\*, schedule, and budget for software: a plan is needed to fully understand the scope of the software effort. Ideally, plans would be developed based on previous experiences, but there may not be a similar experience that can be used for a particular project, and the software manager must rely on instinct and best judgement. Usually, software will require multiple releases because incrementally developed features of the software are needed by the customer at various stages of the project (e.g. I&T, pre-launch, operations). Include a cost discussion and customer sign-off.
- Configuration management/revision control: this should be used for all software development not just FSW. There are many readily available tools, but two of the most popular are Git and Subversion. These tools provide an automatic history of the software development. Configuration Management (CM) allows coordination between multiple team members, assists in the overall software release, and tracks what changes are in that release. CM also allows back tracing to see when a software bug may have been introduced.



- Code reviews: all code should be inspected prior to being accepted by the project. These reviews can be performed in a variety of methods, from off-line informal peer reviews to more formal meetings such as perspective-based code inspections. Some developers believe that this is a poor use of time and are hesitant to have others look at their work. Code reviews lead to a higher quality product and better understanding of the software.
- Documentation: documentation can be both within the code or developed separately. Some documentation tools process the software code to produce formal documentation. The documentation should be consistent with the overall software effort.
- Testing: testing can come as three different parts.
  - Unit- and component-level tests: each software module should have a unit test (function level) and/or component test (module level) that is required to pass before that code is accepted for release. A record of these tests should be kept as part of the overall software release procedure. When fixing a discrepancy or bug the unit test should be modified to test those fixes.
  - Manual or interface testing: software is tested against the actual devices or a copy to ensure that both the hardware and software can successfully communicate and control each subsystem. Tests should be repeated, and edge cases should be tested whenever possible.
  - Integrated testing: integrated testing is the main time that all the FSW can be tested together. This ensures that the overall system operates in an expected and reliable manner. Ideally subsystems have actual hardware, but simulations can be used.
- Continuous integration: Continuous Integration (CI) works with the CM tools to know when changes have been committed. The CI tools automatically build executables and run configured tests (unit and integrated tests). This removes the burden of building and testing from the developers and finds any issues with new code much faster. CI does require setup time and an understanding of the tools.

\*Software planning is a whole topic unto itself. There are several software development approaches. Currently agile software development is one of the most popular. The overall cost of the software development effort needs to be understood, and a detailed cost estimate should be performed. As the complexity of the FSW increases, so does the cost and the effort of estimating that cost. There are a number of different methods for estimating those costs, including analogy, parametric models such as Cocomo, and bottoms-up cost estimates (16) (17) (18). Typically, there is a lot of uncertainty in software cost estimates, so it is important to try to understand the bounds of that uncertainty and, if possible, to give confidence in the estimate.

In order to ensure that all NASA projects follow best software practices NASA Software Engineering Requirements standard NPR 7150.2 (currently NPR7150.2C – for updated NPR standards please see <https://nodis3.gsfc.nasa.gov/>) is mandated for all NASA Flight Software (and NASA developed software in general). It covers requirements for software management and planning, software engineering life cycle requirements, and supporting software life cycle requirements. Overall NPR 7150.2 addresses:

- Roles and responsibilities for tailoring requirements
- Software management
  - Software lifecycle planning
  - Cost estimates
  - Training
  - Classification assessments
  - Software assurance and software verification and validation
- Software engineering life cycle requirements
  - Requirements



- Architecture
- Design
- Implementation
- Testing
- Operations, maintenance, and retirement
- Supporting software life cycle requirements
  - Configuration management
  - Risk management
  - Peer reviews/inspections
  - Measurements
  - Non-conformance or defect management
- Recommended software documentation

### **Digital Twin – [https://en.wikipedia.org/wiki/Digital\\_twin](https://en.wikipedia.org/wiki/Digital_twin)**

Taken directly from the webpage: "...A digital twin is a virtual representation that serves as the real-time digital counterpart of a physical object or process. ...The first practical definition of digital twin originated from NASA in an attempt to improve physical model simulation of spacecraft in 2010. Digital twins are the result of continual improvement in the creation of product design and engineering activities. Product drawings and engineering specifications progressed from handmade drafting to computer aided drafting/computer aided design to model-based systems engineering.

The digital twin of a physical object is dependent on the digital thread—the lowest level design and specification for a digital twin—and the "twin" is dependent on the digital thread to maintain accuracy."

## **8.5 On the Horizon (TRL 1-4): Command and Data Handling**

Many C&DH systems will continue to follow trends set for embedded systems. Short duration missions in low-Earth orbit will continue to take advantage of advances made by industry leaders who provide embedded systems, technologies, and components. In keeping with the low-cost, rapid development theme of CubeSat-based missions, many COTS solutions are available for spacecraft developers.

While traditional C&DH processing needs are relatively stagnant, as small satellites are being targeted for flying increasingly data-heavy payloads (i.e. imaging systems) there is new interest in advanced on-board processing for mission data. Typically, these higher performance functions would be added as a separate payload processing element outside of the C&DH function. Automotive and smartphone industries have pushed the energy efficiency of embedded Graphics Processor Units (GPUs) – processors optimized for matrix multiplication.

### **8.5.1 Open-Source Platforms**

Several open-source hardware platforms hold promise for small spacecraft systems. Arduino boards consist of a microcontroller with complementary hardware circuits, called shields. The Arduino platform uses Atmel microcontrollers; therefore, developers can exploit Atmel's development environment to write software (<https://www.arduino.cc>). The ArduSat spacecraft used the Arduino platform and successfully engaged the public to raise funding on Kickstarter.

Raspberry Pi (<https://www.raspberrypi.org>) is another high-performance open-source hardware platform capable of handling imaging, and potentially, high-speed communication applications (27). Raspberry Pi microcontrollers have been shown to be able to accommodate NASA standard core Flight Software and are available in multiple, demonstrated embodiments (28).



BeagleBone (<https://beagleboard.org/bone>) has also emerged as a popular open-source hardware platform. BeagleBone contains an ARM processor and supports OpenCV, a powerful open-source machine vision software tool that could be used for imaging applications. BeagleSat is an open-source CubeSat platform based on the BeagleBone embedded development board. It provides a framework and tool set for designing a CubeSat from the ground up, while expanding the CubeSat community and bringing space to a broader audience.

Arduino has become known for being beginner friendly and making the world of microcontrollers more approachable for software designers. Though it presents a relatively familiar set of APIs to developers, it does not run its own operating system. On the other hand, the BeagleBone Black, Raspberry Pi, and Intel Edison are full-featured embedded Linux systems running Angstrom, Raspbian, and Yocto Linux kernels out of the box respectively. This broadens the range of developer tool options, from web-based interfaces to Android and Python environments. Not only does this further ease the learning curve for novice developers, but it allows the full power of a Linux system to be harnessed in computation tasks.

Several vendors have developed and implemented C&DH solutions using the Xilinx ZYNQ family of processors (<https://www.xilinx.com/products/silicon-devices/soc/zynq-ultrascale-mpsoc.html>). This processor offers single- to quad-core ARM processing at GHz speeds with built-in FPGA. Although not directly radiation hardened, several radiation mitigation factors have been implemented. These systems typically have been developed on open-source Linux OS.

## **8.6 On the Horizon (TRL 1-4): Flight Software**

FSW is key to mission success. The field of software is a very dynamic environment and continuously evolving. The challenges with flight software usually remain the same regardless of the size of the spacecraft (CubeSat to SmallSat) and are related to the size and complexity of the endeavor. Overall, flight software can be known for scheduling issues and implementation issues especially during integration and test. Temptation of adding additional features is usually present. All these factors can drive up overall complexity and threaten success of FSW and the mission as a whole.

It is essential that FSW be as simple as possible. It is critical to survey the options and plan any FSW effort early. Wherever possible early development and testing should be exercised. Efforts to add additional features should be looked at very critically with strong efforts to stick to the existing plan. With good planning and careful execution, a favorable outcome can be achieved.

## **8.7 Avionics Systems Platform and Mission Development Considerations**

There are many factors to be considered in the optimum selection, configuration and implementation of avionics subsystems, components, and elements for small spacecraft missions. Overall spacecraft concerns of size, weight and power (SWaP) always need to be considered. Some of the more pertinent issues and concerns that all small spacecraft missions must address include:

- Mission applicability and tailoring
- Element, module, and component modularity and interoperability
- Manufacturing and production efficiency, complexity, and scaling
- Mission environment, especially radiation and long-duration space exposure
- Standards and regulatory concerns

Small Spacecraft Avionic systems considerations of particular interest in determining the state-of-the-art for the C&DH, FSW, and subsystem/payload specific electronic systems include the following:





- Small spacecraft platform size ranges and configurations
- Integrated avionics platform architectures
- Mission avionics configurations
- Spacecraft and mission autonomy

### 8.7.1 Flight Payload and Subsystems Avionic elements examples

Below are some reference examples of representative flight payload and subsystems avionics products. These include onboard controllers, systems health avionics, payload processors, and cloud-based processors. Other examples can include use of FPGAs, single-board computers, compute modules, and open-source platforms as described elsewhere in this chapter.

#### Subsystem integrated OBC controllers:

ex. UNIBAP ix5-100 ([www.unibap.com](http://www.unibap.com))

#### Integrated systems health avionics:

ex. IoT Mesh avionics ([https://ti.arc.nasa.gov/m/pub-archive/426h/0426%20\(Alena\).pdf](https://ti.arc.nasa.gov/m/pub-archive/426h/0426%20(Alena).pdf))

#### Onboard Payload Processors

[https://www.esa.int/Enabling\\_Support/Space\\_Engineering\\_Technology/Onboard\\_Computers\\_and\\_Data\\_Handling/Architectures\\_of\\_Onboard\\_Data\\_Systems](https://www.esa.int/Enabling_Support/Space_Engineering_Technology/Onboard_Computers_and_Data_Handling/Architectures_of_Onboard_Data_Systems)

#### Cloud-based processors

ex: Spacecloud (<https://incubed.phi.esa.int/portfolio/uss/>)

### 8.7.2 Platform Size Ranges and Configurations

The generally accepted and documented small spacecraft standard size definitions are described in incremental order of magnitude increments (subNano=0.1-10 kg; Nano=1-10 kg, and micro=10-100 kg). With increased capability and miniaturization of space subsystems and components, and availability of standard launch vehicle deployers and interfaces, many SmallSat providers have begun to develop smaller spacecraft platforms based on containerized CubeSat ranges in increments of "U" described as 10 cm cubic volume, 2 kg max/cube. These units straddle the generic NanoSat/MicroSat size ranges, with 1-3U being considered nanosatellites, and 6-27U standard CubeSats now in the lower half of the microsatellite range.

This often-overlapping standardization impacts small spacecraft avionics in several ways:

- Spacecraft avionics components are performance driven, and not necessarily dependent on spacecraft platform sizes.
- In general, containerized CubeSat standard components are probably upward compatible with equivalent nanosatellite size ranges, but not necessarily the reverse.
- CubeSat subsystems, assemblies, and components are being developed in "U" compatible form factors and may in some cases limit the use and integration of products that do not fit within the U or multiple U dimension and mass constraints.
- Consideration for using available higher TRL avionics products may be constrained to those selected for containerized spacecraft platforms.



### 8.7.3 Integrated Avionics Platform Architectures

The aeronautics industry has defined and adapted the concept of Integrated Mission Architectures (IMA), where IMA are defined as real-time computer network airborne systems. Standard IMA avionics protocols exist (ARINC653 and ARINC 654) to define and inform the community, thus facilitating interfacing and interchangeability of systems components and software functionalities.

Following the trend now well established for aircraft, two embodiments and configurations for integrated modular avionics architectures for small spacecraft can be characterized as follows:

- Federated: Each subsystem of the spacecraft is considered an independent dedicated autonomous element, with the avionic component performing all functions independently, with data exchanged only over standardized communications protocols and interfaces.
- Integrated: Shared, distributed functionality, that can be configured as distributed, heterogeneous, and/or mixed criticality elements, with the capability for smart subsystems, and modular redundant fault tolerant radiation and anomaly mitigation procedures.

### 8.7.4 SS Mission Avionics Configurations

As the use and utility of lower cost small spacecraft for space missions gains acceptance beyond technology demonstration, risk reduction, and education, multi-satellite mission architectures are gaining increasing interest and acceptance. Such configuration architectures as distributed *ad hoc* constellation networks and swarms, synchronized formations, and other multi-satellite cluster formations are creating new opportunities and for small spacecraft avionics. Increased need for synchronization, intersatellite communications, controlled positioning for integrated C&DH functionality, coordination and conduct, operation of ConOps and autonomous operations impose new constraints on the avionics system, not only for single satellites, but now also as systems of systems, whereby overall mission performance is now dependent on all the platform elements acting in a co-dependent fashion.

### 8.7.5 Spacecraft and Mission Autonomy

The NASA 2020 Technology Roadmap defines autonomous systems (in the context of robotics, spacecraft, or aircraft) as a cross-domain capability that enables the system to operate in a dynamic environment independent of external control. ([https://www.nasa.gov/sites/default/files/atoms/files/2020\\_nasa\\_technology\\_taxonomy.pdf](https://www.nasa.gov/sites/default/files/atoms/files/2020_nasa_technology_taxonomy.pdf))

Of particular interest for spacecraft autonomy are the topic areas listing the characteristics of autonomous systems:

- Situational and self-awareness
- Reasoning and acting
- Collaboration and interaction
- Engineering and integrity

Spacecraft autonomy can be considered a part of management, direction, and control for all subsystems and functions in a spacecraft. The C&DH is the brain and executive decision-making component and the nerve center. It takes input from and provides direction to all subsystems (ADCS, Power, Propulsion, Comm, vehicle health, etc.). Those subsystems may also have a degree of autonomy depending on the complexity if it's a local "smart subsystems" processor.

Some systems now implement a heterogeneous architecture, meaning they contain multiple processors with varying levels of performance and capabilities. For instance, the higher performance modules and components can be used for sophisticated number crunching and processing, AI and onboard computing for both spacecraft and mission performance optimization,



as well as science data real-time adaptive analysis (we used to call these co-processors, now heterogeneous architectures). This allows lower performance onboard processors and FPGAs etc. to conduct the routine spacecraft operations functions and interact with the subsystems which also may include distributed performance cascades.

### **8.7.6 Industry 4.0, Foundational and Enabling Technologies and Products**

In keeping with the trends seen in other disciplines and industries, the Industry 4.0 and “digitally managed everything” is absolutely of critical importance for technological and programmatic efficiencies in small spacecraft avionic systems development and utilization. The following is just a short list of 21<sup>st</sup> century tools, technologies, and approaches that must be considered in development and deployment of next-generation small spacecraft avionic systems:

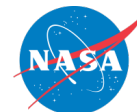
1. Artificial Intelligence, Machine Learning / Machine Vision
2. Robotics and Automation
3. Model-Based Systems Engineering
4. Embedded Systems / Edge Computing
5. Internet-of-Space-Things
6. Cloud Computing
7. Augmented Reality/ Virtual Reality / Mixed Reality
8. Software-Defined-Everything
9. Advanced manufacturing
10. Digital Twin

### **8.8 Summary**

Space applications now require considerable autonomy, precision, and robustness, and are refining technologies for such operations as on-orbit servicing, relative and absolute navigation, inter-satellite communication, and formation flying. An exciting trend is that small spacecraft missions are becoming more complex in the anticipation of these platforms being used for lunar and deep space science and exploration missions. Small spacecraft technology must expand to meet the needs of this increasing small spacecraft mission complexity, to achieve the next generational goals of collecting important science in deep space using small spacecraft, as well as risk mitigation for larger more complex and mission-critical situations. In parallel, spacecraft electronic components have matured to have higher performance, higher reliability, and are being miniaturized to meet the growing needs of these now very capable spacecraft.

With the combination and integration of the previously separate C&DH and FSW chapters, the 2021 Small Spacecraft Avionics chapter has attempted to cast these elements in a broader, interrelated framework, and attempts to show that C&DH, FSW, and smart payloads are not just independent space platform subsystems but are part of an integrated avionics ecosystem of all electronic elements of a space platform, now primarily digitally based and or managed. Also, SSA should not be considered as an isolated spaceflight technology component, but rather as a core digital engineering technology emphasis area, capable of taking advantage of and integrating products, processes, and technologies from other disciplines. To continue to be relevant and efficient, the small spacecraft avionics communities must remain cognizant and receptive of the continuously evolving nature of the digital based Industry4.0 technology revolution now being evidenced in other related and/or associated vertical disciplines and solutions.

For feedback solicitation, please email: [arc-sst-soa@mail.nasa.gov](mailto:arc-sst-soa@mail.nasa.gov). Please include a business email for further contact.



## References

- (1) GomSpace. NanoMind A3200 - Datasheet. [Online] 2019. <https://gomspace.com/shop/subsystems/command-and-data-handling/nanomind-a3200.aspx>.
- (2) ISIS. ISIS On board computer - Datasheet. [Online] 2019. <https://www.isispace.nl/wp-content/uploads/2016/02/IOBC-Brochure-web-compressed.pdf>.
- (3) Pumpkin Space Systems. "Processor-specific CubeSat Kit™ Components." Pumpkin Products/Store. [Online] 2020. [https://www.pumpkinspace.com/store/c19/Processor-specific\\_CubeSat\\_Kit%E2%84%A2\\_Components.html](https://www.pumpkinspace.com/store/c19/Processor-specific_CubeSat_Kit%E2%84%A2_Components.html).
- (4) Xiphos. Q7S Specifications - Datasheet. [Online] 2020. <http://xiphos.com/wp-content/uploads/2015/06/XTI-2001-2020-e-Q7S-Spec-Sheet.pdf>.
- (5) Xiphos. Q8S SPECIFICATIONS - Datasheet. [Online] 2020. <http://xiphos.com/wp-content/uploads/2020/06/XTI-2001-2025-f-Q8S-Rev-B-Spec-Sheet-1.pdf>.
- (6) BAE Systems. "RAD750 3U CompactPCI single-board computer." BAE Systems: Space product literature. [Online] 2008. <https://www.baesystems.com/en-us/our-company/inc-businesses/electronic-systems/product-sites/space-products-and-processing/radiation-hardened-electronics>.
- (7) BAE Systems. "RAD5545 Space VPX single-board computer." BAE Systems: Space products literature. [Online] 2017. <https://www.baesystems.com/en-us/our-company/inc-businesses/electronic-systems/product-sites/space-products-and-processing/radiation-hardened-electronics>.
- (8) AAC Clyde Space. Command & Data Handling KRYTEN-M3 - Datasheet. [Online] 2020. [https://www.aac-clyde.space/assets/000/000/179/AAC\\_DataSheet\\_Kryten\\_original.pdf?1600342763](https://www.aac-clyde.space/assets/000/000/179/AAC_DataSheet_Kryten_original.pdf?1600342763).
- (9) AAC Clyde Space. Command & Data Handling Sirius OBC LEON3FT - Datasheet. [Online] 2020. [https://www.aac-clyde.space/assets/000/000/181/AAC\\_DataSheet\\_Sirius\\_OBC\\_-\\_updated\\_tables\\_original.pdf?1599046187](https://www.aac-clyde.space/assets/000/000/181/AAC_DataSheet_Sirius_OBC_-_updated_tables_original.pdf?1599046187).
- (10) Innoflight. CFC-300: Compact Flight Computer - Datasheet. [Online] 2020. <https://www.innoflight.com/product-overview/cfcs/cfc-300/>.
- (11) Innoflight. CFC-400: Compact Flight Computer - Datasheet. [Online] 2020. <https://www.innoflight.com/product-overview/cfcs/cfc-400/>.
- (12) Innoflight. CFC-500: Compact On-Board Computer - Datasheet. [Online] 2020. <https://www.innoflight.com/product-overview/cfcs/cfc-500/>.
- (13) Space Micro. CubeSat Space Processor (CSP). Datasheets. [Online] 2019. <https://www.spacemicro.com/assets/datasheets/digital/slices/CSP.pdf>.
- (14) Nanoavionics. CubeSat On-Board Computer - Main Bus Unit SatBus 3C2 - Datasheet. [Online] 2020. <https://nanoavionics.com/CubeSat-components/CubeSat-on-board-computer-main-bus-unit-satbus-3c2/>.
- (15) Moog. Radiation Tolerant, 75GLOP 3U SPaceVPX GPU Single Board Computer - Datasheet. Moog: Space Defense: Space Literature. [Online] 2020. [https://www.moog.com/content/dam/moog/literature/Space\\_Defense/spaceliterature/avionics/Moog-Rad-Tolerant-75GFLOP-3U-SpaceVPX-GPU-Single-Board-Computer-Datasheet.pdf](https://www.moog.com/content/dam/moog/literature/Space_Defense/spaceliterature/avionics/Moog-Rad-Tolerant-75GFLOP-3U-SpaceVPX-GPU-Single-Board-Computer-Datasheet.pdf).



- (16) SEAKR. Commercial Products. SEAKR: Catalog. [Online] 2020. <https://www.seakr.com/catalog/>.
- (17) Moog. Integrated Avionics Unit - Datasheet. *Moog: Space: Avionics*. [Online] 2020. [https://www.moog.com/content/dam/moog/literature/Space\\_Defense/spaceliterature/avionics/moog-integrated-avionics-unit-datasheet.pdf](https://www.moog.com/content/dam/moog/literature/Space_Defense/spaceliterature/avionics/moog-integrated-avionics-unit-datasheet.pdf).
- (18) Fitzsimmons, S.: "Open-source Software for CubeSat Satellites." AIAA/USU Conference on Small Satellites. 2012.
- (19) Bruhn, F.C., Tsog, N., Kunkel, F. et al. Enabling radiation tolerant heterogeneous GPU-based onboard data processing in space. *CEAS Space J* 12, 551–564 (2020). <https://doi.org/10.1007/s12567-020-00321-9>
- (20) Nguyen, M.: "FPGA Advances Improve Radiation Mitigation for Remote-Sensing Satellites." 2015, pp. vol. 17, no. 8.
- (21) Ball Aerospace & Technologies Corp. "The User Interface for Command and Control of Embedded Systems." 2015.
- (22) Henkel, H.: "Total Dose Radiation Tests at FRAM Non-Volatile Memories." 1996.
- (23) NASA Goddard Space Flight Center. "GSFC Open-Source Software." 2015.
- (24) Bardoux, A., et al.: "Radiation Effects on Image Sensors." International Conference on Space Optics. 2012.
- (25) Chapman, T.: "Radiation Tolerances." 2015.
- (26) Holbert, K. E.: "Single Effect Events." 2015.
- (27) Wooster, P, et al.: "Open-Source Software for Small Satellites." AIAA/USU Conference on Small Satellites. No. #SSC07-XII-3. 2007.
- (28) Cudmore, Alan: "Pi-Sat: a Low-Cost Small Satellite and Distributed Spacecraft Mission System Test Platform." s.l.: NASA GSFC, 2015. GSFC-E-DAA-TN27347.
- (29) NASA Goddard Space Flight Center. "Core Flight Software System." 2015.
- (30) LaBel, K. A. et. al.: "Commercial Microelectronics Technologies for Applications in the Satellite radiation Environment." Aerospace Applications Conference. 1996.
- (31) Windriver. VXWORKS. [Online] <https://www.windriver.com/products/vxworks/>.
- (32) RTEMS. RTEMS Real Time Operating System (RTOS). [Online] 2020. <https://www.rtems.org>.
- (33) NASA. A Flight Software and Embedded Systems Framework. [Online] 2020. <https://nasa.github.io/fprime/>.
- (34) Bocchino, Robert, et al.: "F Prime: An Open-Source Framework for Small-Scale Flight Software Systems." Logan: 32nd Annual Small Satellite Conference, 2018.
- (35) Multi-Purpose Spacecraft Simulator for the LADEE Mission. Benz, Nathaniel, Viazzo, Danilo and Gundy-Burlet, Karen. s.l.: IEEE, 2015.
- (36) Gundy-Burlet, Karen: "Validation and Verification of LADEE Models and Software." s.l. : American Institute of Aeronautics and Astronautics.
- (37) NASA. ITOS Capabilities. *Integrated Test and Operations Systems (ITOS)* . [Online] 2020. <https://itos.gsfc.nasa.gov/itos-capabilities.php>.
- (38) NASA. ASIST Public Web Site - NASA. [Online] 2012. <https://nasa-asist.gsfc.nasa.gov>.
- (39) L3Harris Technologies. Space Software. Telemetry and RF products. [Online] 2020. <https://www2.l3t.com/trf/incontrol/index.htm>.
- (40) Ball Aerospace. The User Interface for Command and Control of Embedded Systems. [Online] 2020. <https://cosmosrb.com/>.



- (41) Bruhn, F.C., Tsog, N., Kunkel, F. et al. Enabling radiation tolerant heterogeneous GPU-based onboard data processing in space. CEAS Space J 12, 551–564 (2020). <https://doi.org/10.1007/s12567-020-00321-9>
- (42) Ibeos: “Standard Products.” [Online] 2021. Accessed August 8, 2021. <https://www.ibeos.com/standard-products>



## Chapter Contents

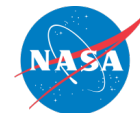
Glossary .....	ii
9.0 Communications.....	232
9.1 Introduction .....	232
9.1.1 Document Organization .....	232
9.2 Public Data Sources and Disclaimers .....	233
9.3 Definitions .....	233
9.4 Technological Maturity .....	233
9.4.1 Application of the TRL Scale to SmallSat Communications Systems .....	233
9.5 Radio Frequency Communications .....	234
9.5.1 Frequency Bands .....	234
9.5.2 System Architecture .....	235
9.5.3 Definitions.....	236
9.5.4 Design Considerations.....	237
9.5.5 Policies and Licensing.....	237
9.5.6 Encryption.....	238
9.5.7 Antennas .....	238
9.5.8 Radios .....	239
9.5.9 On the Horizon RF Communications .....	240
9.6 Optical Communications .....	241
9.6.1 System Architecture .....	241
9.6.2 Design Considerations.....	242
9.6.3 Policies and Licensing.....	242
9.6.4 Missions.....	243
9.6.5 On the Horizon Optical Communications.....	243
9.7 Summary.....	244
References.....	251



## Chapter Glossary

(ADCS)	Attitude Determination and Control System
(BPF)	BandPass Filters
(CDH)	Command and Data Handling
(COTS)	Commercial-off-the-Shelf
(DSN)	Deep Space Network
(DSP)	Digital Signal Processing
(DVB-S2)	Digital Video Broadcast Satellite Second Generation
(FCC)	Federal Communications Commission
(FIPS)	Federal Information Processing Standard
(FPGAs)	Field Programmable Gate Arrays
(FSO)	Free Space Optical
(IARU)	International Amateur Radio Union
(IEEE)	Institute of Electrical and Electronics Engineers
(ISARA)	Integrated Solar Array and Reflectarray Antenna
(ISM)	Industrial, Scientific, and Medical
(ISS)	International Space Station
(JPL)	Jet Propulsion Laboratory
(LADEE)	Lunar Atmosphere and Dust Environment Explorer
(Lasercom)	Laser Communications
(LCH)	Laser ClearingHouse
(LCT)	LaserCom Terminals
(LDPC)	Low-Density Parity-check Code
(LLCD)	Lunar Laser Communications Demonstration
(LNA)	Low Noise Amplifier
(MA)	Multiple Access
(MarCO)	Mars Cube One
(MEMS)	Micro-Electro-Mechanical
(MRR)	Modulating Retro-Reflector





(NEN)	Near Earth Network
(NICT)	National Institute of Information and Communications Technology
(NOAA)	National Oceanic and Atmospheric Administration
(NTIA)	National Telecommunications and Information Administration
(RF)	Radio Frequency
(SBIR)	Small Business Innovative Research
(SCaN)	Space Communications and Navigation
(SDR)	Software Defined Radios
(SME)	Subject Matter Expert
(SNR)	Signal-to-Noise Ratio
(SOTA)	Small Optical Transponder
(SWaP)	Size, Weight, and Power
(TDRS)	Tracking and Data Relay Satellite
(TMA)	Technology Maturity Assessments
(TRL)	Technology Readiness Levels
(TT&C)	Tracking, Telemetry & Command
(WFF)	Wallops Flight Facility

## 9.0 Communications

### 9.1 Introduction

The communication system is an essential part of a spacecraft, enabling spacecraft to transmit data and telemetry to Earth, receive commands from Earth, and relay information to one another. A communications system consists of the ground segment: one or more ground stations located on Earth, and the space segment: the spacecraft(s) and their respective communication payloads. The three functions of a communications system are receiving commands from Earth (uplink), transmitting data down to Earth (downlink) and transmitting or receiving information from another satellite (crosslink or inter-satellite link). There are two types of communication systems: radio frequency (RF) and free space optical (FSO) also referred to as laser communications (lasercom).

Most spacecraft communications systems are radio frequency based. They are conducted in the Institute of Electrical and Electronics Engineers (IEEE) radio bands of 300 MHz to 40 GHz. A RF system communicates by sending data over electromagnetic waves to and from antennas. Information is encoded onto radio frequency waves using modulation and sent to the receiving system where it is demodulated and decoded.

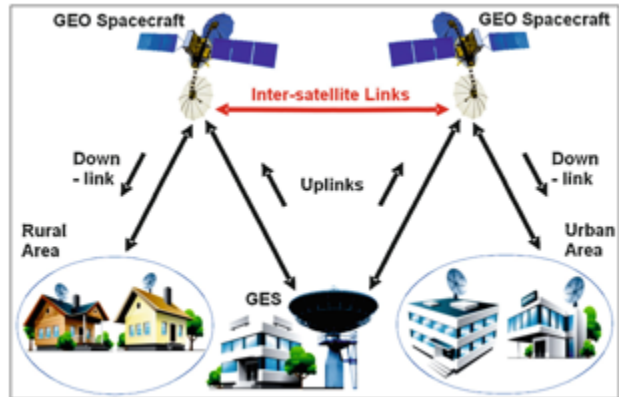


Figure 9.1: Satellite uplink, downlink, and crosslink. Credit: D. Stojce (2019).

Recent development in FSO communications has made it a strong alternative to RF systems. FSO systems consist of a transmitting terminal and receiving terminal. Much like an RF system, information is encoded onto electromagnetic waves using modulation and sent to the receiving system. FSO links operate at a much higher frequency than RF links, generally at infrared or visible bands. Higher frequencies result in wider bandwidths which result in higher data rates.

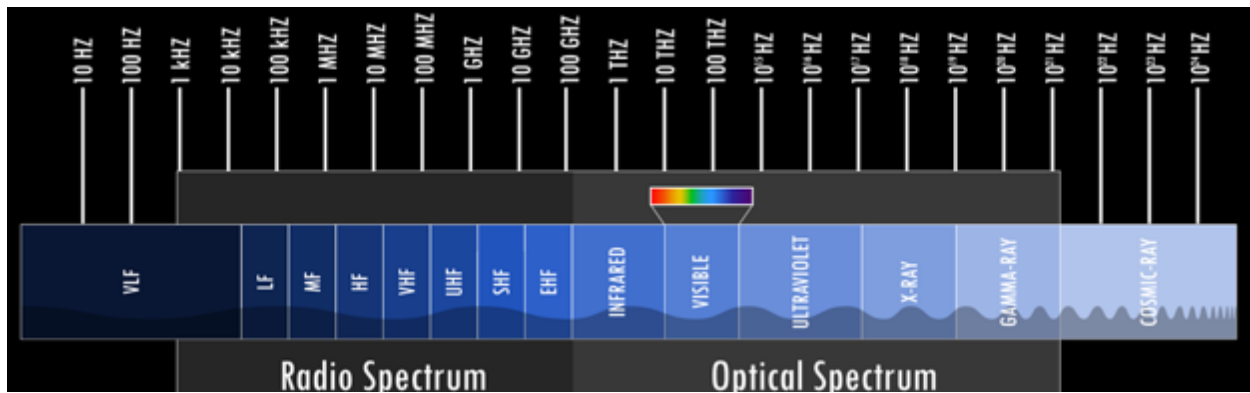


Figure 9.2: Radio and optical spectrum used by spacecraft for communication. Credit: NASA.

#### 9.1.1 Document Organization

This chapter organizes the state-of-the-art in small spacecraft communications hardware into the following categories:

1. Radio Frequency Communications (9.5)
2. Optical Communications (9.6)



Each of these categories is further subdivided by the system background and prevailing technology types. The subsections organize data as follows:

- a. System Introduction
  - i. Frequency Bands
  - ii. System Architecture
  - iii. Design Considerations
  - iv. Policies and Licensing
- b. Hardware
  - i. Device Introduction
  - ii. Device Tables
- c. On the Horizon

## 9.2 Public Data Sources and Disclaimers

This chapter is a survey of small spacecraft communications technologies as discussed in open literature and does not endeavor to be an original source. This chapter only considers literature in the public domain to identify and classify devices. Commonly used sources for data include manufacturer datasheets, press releases, conference papers, journal papers, public filings with government agencies, and news articles.

## 9.3 Definitions

- Device refers to a component, subsystem, or system, depending on the context.
- Technology refers to a broad category of devices or intangible materials, such as processes.
- System refers to the integration of components from a multitude of manufacturers, which may be mixed-and-matched to create a unique mission-appropriate subsystem solution.

## 9.4 Technological Maturity

### 9.4.1 Application of the TRL Scale to SmallSat Communications Systems

NASA has clear guidelines for Technology Maturity Assessments (TMA) outlined in the NASA SP-2016-6105 NASA Systems Engineering Handbook Appendix G: Technology Assessment/Insertion. An assessment determines a device's maturity level, and the Technology Readiness Level (TRL) as the frequently used system of measure. The TRL scale is defined in NASA Procedural Requirements (NPR) 7123. In general, technologies rated TRL 5 have been demonstrated in a laboratory, TRL 7 has been demonstrated in a flight-like environment, and TRL 9 is flight ready and space-qualified. TRL is used to communicate the maturity and risk levels associated with a particular technology. TRLs are applied across all technology categories, resulting in broad definitions for each level. Assessment of a device's TRL level requires the consideration of a subject matter expert (SME). Without the in-depth technical knowledge of the specific subject, the TRL level could be applied incorrectly.

The information described below is not intended to be exhaustive but provides an overview of current state-of-the-art technologies and their development status for particular small spacecraft subsystems. It should be noted that TRL designations may vary with changes specific to payload, mission requirements, reliability considerations, and/or the environment in which performance was demonstrated. This chapter will be reviewing state-of-the-art technology on the order of TRL 7-9, spanning early flight testing to production flight hardware. Due to the limited technical knowledge of the reviewer(s) about specific hardware, TRL assessment for RF hardware and lasercom terminals will not be provided. The technology reviewed for this chapter will all be at a certain threshold of development; therefore, it can be assumed by the reader that it is at minimum TRL 7. Hardware used in notable missions will be identified, and those devices can be assumed



to be TRL 9. Technology characterized as On-the-Horizon will be included at the end of each chapter. These devices will be on the order of TRL 4-6.

Readers are highly encouraged to reach out to companies for further information regarding the performance and TRL of described technology. There is no intention of mentioning certain companies and omitting others based on their technologies or relationship with NASA.

## 9.5 Radio Frequency Communications

A radio communication system includes a radio transmitter, a free space communication channel, and a radio receiver. At the top level, a radio transmitter system consists of a data interface, modulator, power amplifier, and an antenna. The transmitter system uses the modulator to encode digital data onto a high frequency electromagnetic wave. The power amplifier then increases the output RF power of the transmitted signal to be sent through free space to the receiver using the transmit antenna.

The radio receiver system uses a receiving antenna, low noise amplifier, and demodulator to produce digital data output from the received signal. The receiving antenna collects the electromagnetic waves and routes the signal to the receiver, which then demodulates the wave and converts the electrical signals back into the original digital message. Low noise amplifiers and filters are sometimes employed to reduce signal noise in certain frequency bands or increase the received signal strength. In many cases, the functions of the modulator and demodulator are combined into a radio transceiver that can both send and receive RF signals.

Radio frequency communications for spacecraft are conducted between 30 MHz and 60 GHz. The lower frequency bands are typically more mature for SmallSat usage, however extensive use of these bands has led to crowding and challenges acquiring licensing. Higher frequencies offer a better ratio of gain-to-aperture-size, but require higher power due to increased atmospheric attenuation at those frequencies and the higher free space loss that is directly proportional to frequency.

### 9.5.1 Frequency Bands

Satellite communications are conducted over a wide range of frequency bands. The typical bands considered for small satellites are UHF, S, X, and Ka. The most mature bands used for CubeSat communication are VHF and UHF frequencies. There has been a shift in recent years towards S and X, with Ka being NASA's intended band for future small satellite communications. The move to higher frequency bands has been driven by a need for higher data rates. At the higher frequencies there is greater atmospheric and rain attenuation adding to increased free space loss. This needs to be compensated for with higher power transmission and/or high gain antennas with narrower beamwidths. Moving to higher-gain antennas increases the pointing accuracy required for closing the link.

NASA spacecraft, which use the government bands of S-band, X-band and Ka-band, may use the NASA Near Earth Network (NEN) at no charge. The primary frequency bands of S, X, and Ka are more advantageous than using the UHF band, which has a higher probability of local interference. Satellite Tracking, Telemetry & Command (TT&C) is typically conducted over S-band. Non-NASA spacecraft have access to a wide variety of ground system options ranging from Do-It-Yourself to pay-per-pass services.

<b>Band</b>	<b>Frequency</b>
VHF	30 to 300 MHz
UHF	300 to 1000 MHz
L	1 to 2 GHz
S	2 to 4 GHz
C	4 to 8 GHz
X	8 to 12 GHz
Ku	12 to 18 GHz
K	18 to 27 GHz
Ka	27 to 40 GHz
V	40 to 75 GHz



In L-band, CubeSats can take advantage of legacy communications networks such as Globalstar and Iridium by using network-specific transponders to relay information to and from Earth. These networks remove dependence on dedicated ground station equipment. However, they can only be used at orbital altitudes below the communication constellation and require experimental frequency authorization.

Ku-, K-, and Ka-band communication systems are the state-of-the-art for large spacecraft, especially in spacecraft-to-spacecraft communications, but they are still young technologies in the CubeSat world. They are becoming more attractive to SmallSat designers as the lower frequencies become more congested. At the higher frequencies, rain fade becomes a significant problem for communications between a spacecraft and Earth (1). Nonetheless, the benefits of operating at higher frequencies have justified further research by both industry and government alike. At JPL, the Integrated Solar Array and Reflectarray Antenna (ISARA) mission demonstrated high bandwidth Ka-band CubeSat communications with over 100 Mbps downlink rate (2). The back of the 3U CubeSat was fitted with a high gain reflectarray antenna integrated into an existing solar array. The successful demonstration of the reflectarray on ISARA became the basis for the Mars Cube One (MarCO) mission to Mars. The MarCO mission uses two twin CubeSats for a communications relay between the InSight lander and Earth. Using a X-band reflectarray they were able to successfully complete their mission (3).

CubeSats have also used the unlicensed Industrial, Scientific, and Medical (ISM) bands for communications. The Ames TechEdSat team has successfully demonstrated WiFi to downlink data at 1 Mbps. Notably, a group at Singapore's Nanyang Technological University used a 2.4 GHz ZigBee radio on its VELOX-I mission to demonstrate commercial-off-the-shelf (COTS) land-based wireless systems for inter-satellite communication (4). Similarly, current investigations are looking at using wireless COTS products, such as Bluetooth-compatible hardware, for inter-satellite communications (5).

### **9.5.2 System Architecture**

A small satellite RF communications system consists of a transceiver comprised of a radio, an amplifier, and an antenna. Radios receive a message from the Command and Data Handling (CDH) subsystem, then produce and modulate an electromagnetic wave to create a signal. They are responsible for generating the signal and modulating or demodulating it. The radio is also where coding may be added to the signal. Modulation and coding are added to achieve communication efficiency and adequate performance under the conditions imposed by the satellite transmission path (6). From Shannon's Equation (6), it is known that the information capacity of a channel is related to its bandwidth and signal-to-noise ratio (SNR). The channel capacity (information flow) can be increased by increasing the SNR or the bandwidth, and many modulation and coding schemes make effective use of this tradeoff.

Radios offer some power amplification, but often the signals from small satellites require a greater boost. The power amplifier will take the signal from the radio and increase the RF output power before sending it to the transmit antenna. On the receive side, a low noise amplifier will take the weak signal from the receive antenna and increase it while reducing interference noise using a bandpass filter. The radio will then be able to process the stronger signal with higher accuracy. In RF communications the role of the antenna is to increase and focus the strength of the signal in a specific direction. The digital message encoded on the RF carrier signal will be sent to and from the antennas of each system.

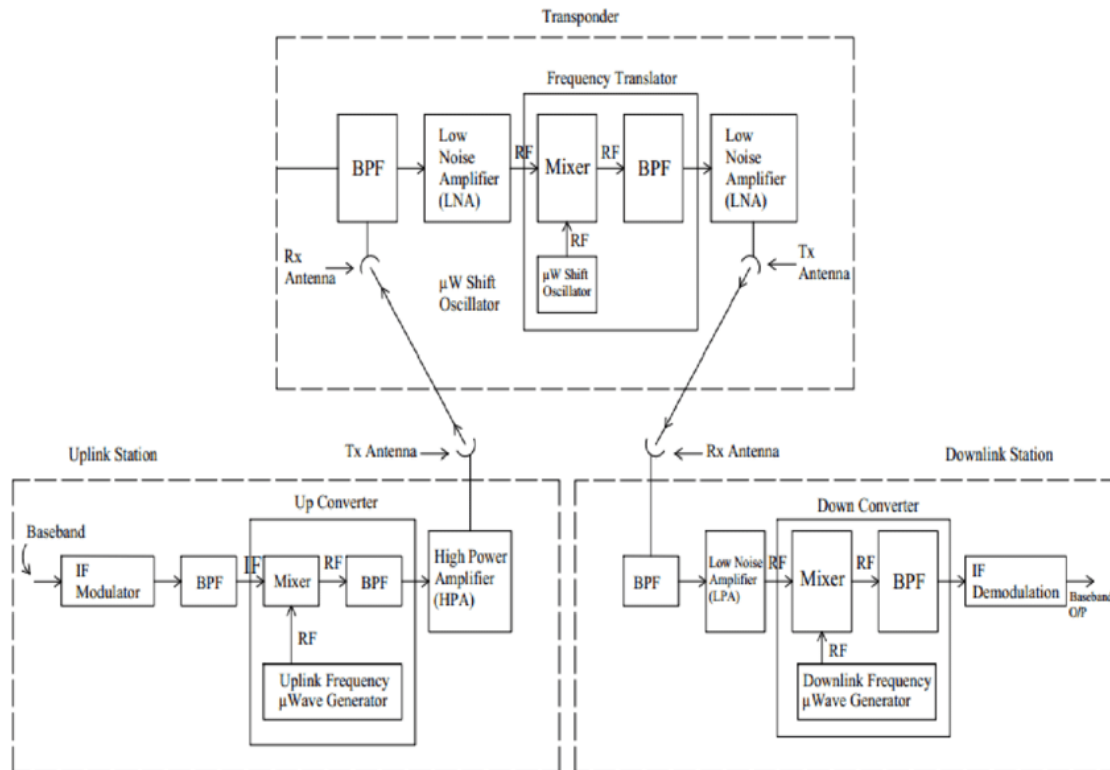


Figure 9.2: Transmit and receive block diagram. Credit: Karim et al. (2018). <http://creativecommons.org/licenses/by/4.0/>

### 9.5.3 Definitions

- Radio or Modulator: On the transmit side it produces, modulates, codes, and amplifies an electromagnetic wave to create a signal. Adds modulation and coding as needed. As a receiver it decodes and demodulates received signals.
- Filters and mixers: Bandpass filters (BPF) and RF mixers are used in communications systems to change the frequency of the signal. If the frequency generated by the radio is not the desired transmit frequency, then an upconverter will be used to convert the signal to a higher frequency for transmit. Similarly, the downconverter will down convert a receive frequency to a lower one for processing.
- Amplifier: For a transmit system, a power or gain amplifier is required. For a receive system, a low noise amplifier (LNA) is required.
- Antenna: Increases the strength of a signal in a specific direction, relative to the same signal strength without directionality. Receives signals sent towards it by the transmitter.
- Encryption: A cryptographic unit is an integrated encryptor/decryptor device that provides secure uplink, downlink, or crosslink for satellite communication links. Most small satellite designers will not require a cryptographic payload unit based on their threat level and may be able to use the communications radio for simple encryption schemes.
- Spread-spectrum communication applies a known frequency spreading function to the signal, which helps reduce interference from other transmitters and is often used for multi-way communication networks. For example, the NASA Tracking and Data Relay Satellite (TDRS) multiple-access mode requires spread spectrum signals to support multiple simultaneous communication links.



#### 9.5.4 Design Considerations

The communications subsystem is an essential part of every spacecraft. It is required to transmit important health and telemetry data down to Earth, as well as receive commands from ground operators. Additionally, the communications system is critical to transporting mission data back to Earth. As with all spacecraft subsystems, there are power and mass constraints placed on the comm system. Based on these restrictions several trade studies need to be performed to choose the optimal design.

When designing a RF comm system, the first trades performed are for data rate, power consumption, and total mass. For example, a mission with high data rate needs would select a high frequency such as X-band for downlink and a directional high-gain antenna. Based on the ground station locations available, engineers would perform link budget analyses to determine the minimum power needed for a specific ground station antenna. This analysis would factor in rain and atmospheric attenuation, as well as modulation and coding. A few different link budget trades will be run, varying antenna size, RF output power and data rate. Each link will return a different margin of decibels, representing the reliability of the system. The engineers will proceed to calculate the final mass and power for each configuration. The mission designer will have a limit on mass and power constraints for the communications subsystem. Each configuration traded will compare data rate, power, and mass. A high data rate downlink may cost a high amount of mass for the antenna and power for the amplifier and radio. Conversely, a low-power, low-mass system may have a lower data rate.

Another factor that is considered in the design phase is pointing. Depending on the orbit of the satellite and whether the link is UL/DL or XL, the system may have a specific pointing requirement. Large satellites frequently use gimbals--platforms that can pivot to point their antennas. The addition of a gimbal will increase the overall mass and power draws of the system. CubeSats frequently trade high-gain antennas for low-gain, omni-directional ones to maintain the link regardless of directionality. CubeSats may also change their attitude to point a body-mounted antenna, rather than use a gimbal.

#### 9.5.5 Policies and Licensing

Any non-Federal spacecraft with a transmitter must be licensed by the Federal Communications Commission (FCC). The types of RF licenses used by small satellites are: Amateur (FCC Part 97) and Experimental (FCC Part 5) (7). An amateur license type of authorization is limited to hobbyists and non-profit use, and comes with many FCC restrictions. Experimental Part 5 licenses are commonly used for university CubeSats and can be granted for a CubeSat operating in the amateur band (A SmallSat or SmallSat constellation can also apply under provisions of Part 25). A spacecraft with any sort of remote sensing capability must contact the National Oceanic and Atmospheric Administration (NOAA) to find out if a NOAA license is required. A NOAA license is not an RF license and conveys no authority for the radiation of RF energy for communication. For government missions the National Telecommunications and Information Administration (NTIA) is the licensing authority.

For Amateur licensing, there must be an FCC licensed amateur radio control operator. Downlink telemetry and communications cannot be obscured (encrypted). Use of science gathered via amateur radio downlink for profit ("pecuniary interest") is prohibited. Frequency "assignment" in the amateur-satellite allocations requires coordination, a process administered by the International Amateur Radio Union (IARU) (8).

In 2018, the FCC adopted a Notice of Proposed Rulemaking to develop a new authorization process tailored specifically to small satellite operations, keeping in mind efficient use of spectrum and mitigation of orbital debris. Small satellites that would qualify for the new rules include those



with 10 or lesser number of satellites under a single license. All individual satellites will have to be 10 cm or larger in the smallest dimension and weigh less than 180 kg. The maximum in-orbit lifetime of each individual satellite will be six years, including de-orbiting time, and they would have to be deployed under 600 km altitude. Each satellite will have a unique telemetry marker for tracking and will not release any debris (9).

### 9.5.6 Encryption

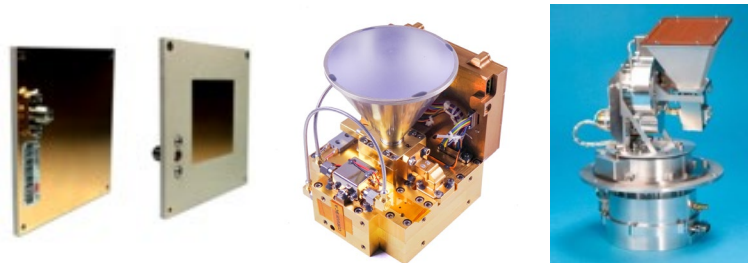
Encryption is the process of encoding information to conceal it from outside actors. Small satellites can use a cryptographic unit to encrypt or decrypt data prior to transmission. When data is being prepared for transmission, it is broken up into packets. These packets are then scrambled according to the encryption scheme being used. An encryption scheme uses an encryption key generated by an algorithm to encode the data. The authorized receiver of the encrypted data will be able to decrypt the message using the appropriate key. Without the authorized key, decrypting the data will be extremely difficult.

With the increased proliferation of small satellites in low-Earth orbit comes an increase in vulnerabilities. Many SmallSats are comprised of COTS hardware and/or open source software. While this strategy allows for a more flexible design approach, adversaries can gain insight into the design. Additionally, the improvement in propulsion technology for small satellites creates a potential collision threat for other low-Earth orbit spacecraft. Encryption of data in transit prevents other actors from commanding satellites or intercepting transmissions.

NASA requires any of its propulsive spacecraft within 2 million kilometers of Earth to protect their command uplink with encryption that is compliant with Level 1 of the Federal Information Processing Standard (FIPS) 140-3 (10). The FCC has also considered requiring encryption on the telemetry, tracking, and command communications as well as mission data for propulsive spacecraft, but decided not to incorporate a specific requirement at this time. A satellite with an amateur license cannot encrypt transmissions in any way and must consist of open information. The eligibility rules are listed in 47 CFR Part 97 (11).

### 9.5.7 Antennas

Antennas are used for propagating data through free space using electromagnetic waves. RF antennas are typically sized for their respective frequencies. This means that antennas are often chosen or designed specifically for their mission. COTS antennas are available for SmallSats and can be built to order. For missions that don't have high data rate requirements, a simple patch or monopole antenna with low gain and efficiency will suffice. Due to their low directionality, these antennas can generally maintain a communication link even when the spacecraft is tumbling, which is advantageous for CubeSats lacking good attitude and accurate pointing control. New developments in antenna design have put technologies like the deployable reflector antenna, reflectarray, and passive or active array antennas on the horizon for small satellites.



*Figure 9.3: (from left to right) CubeSat-compatible S-band patch antenna (IQ Wireless), X-band high-gain antenna and pointing mechanism (Surrey Satellite Technology, Ltd.), and Ka-band transmitter with a horn antenna (Astro Digital).*

There are two primary classifications of antenna: fixed or deployable. Fixed antennas do not require any power or triggering mechanisms. They remain stationary in the position that they are attached to the spacecraft. This includes patch antennas, array antennas, monopole antennas,





omni-directional antennas, and horn antennas, see figure 9.3. Deployable antennas require power to deploy and use mechanisms to configure into their final position. This includes whip antennas, parabolic reflectors, reflectarrays, helical and turnstile antennas, see figure 9.4.

A communications link is often characterized by the frequency and data rate. The antenna is a key design decision for meeting data rate objectives by increasing link margin. By increasing the aperture or diameter of an antenna it increases the link margin, which can allow designers to increase the data rate of the system or reduce the necessary transmit power.

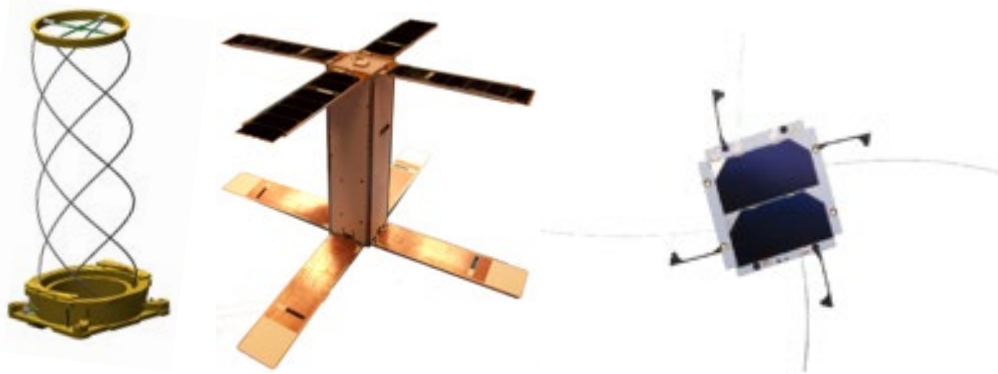


Figure 9.4: (from left to right) Example of deployable quadrifilar helical antenna (Helical Communication Technologies), SNaP spacecraft with Haigh-Farr's deployable UHF Crossed Dipole antenna (Space Missile and Defense Command), and EnduroSat UHF antenna with EnduroSat solar panels (EnduroSat).

### 9.5.8 Radios

Radios for small sat downlink are transceivers (transmitter and receiver in one). Transceivers convert digital information into an analog RF signal using a variety of modulation and coding schemes. Radios for TT&C are designed to be low data-rate, with high reliability and only need to transmit health data and receive commands. Traditional radios may be locked to a single frequency band and modulation/coding scheme based on their design and build. Software defined radios (SDR) have some or all of the radio's functions implemented in Digital Signal Processing (DSP) software rather than hardware, see figure 9.5 for an example of an SDR. Furthermore, spacecraft teams can change such characteristics in-flight by uploading new settings from the ground. By using Field Programmable Gate Arrays (FPGAs), SDRs have great flexibility that allows them to be used with multiple bands, filtering, adaptive modulation and coding schemes, without much (if any) change to hardware (12). SDRs are especially attractive for use on CubeSats, as they are becoming increasingly small and efficient as electronics become smaller and require less power. Since 2012, NASA has been operating the Space Communications and Navigation (SCaN) Testbed on the International Space Station for the purpose of SDR TRL advancement, among other things (13). Many radios can provide RF output power to the antenna directly. For higher power applications, an external RF amplifier or high gain antenna may be used.

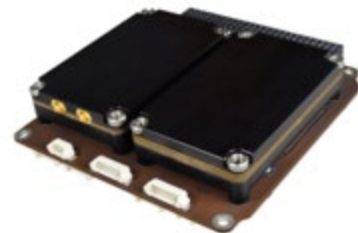


Figure 9.5: Example of software defined radio, tunable in the range 70 MHz to 6 GHz. Credit: GomSpace.



This report recommends efficient modulation and coding schemes for spacecraft power and bandwidth to increase the data rate and meet bandwidth constraints with the limited power and mass for CubeSat spacecraft. Advanced coding, such as the CCSDS Low-density parity-check code (LDPC) family, with various code rates is a powerful technique to provide bandwidth and power tradeoffs with high-order modulation to achieve high data rate requirements for CubeSat missions. Digital Video Broadcast Satellite Second Generation (DVB-S2), a significant satellite communications standard, is a family of modulations and codes for maximizing data rates and minimizing bandwidth use, along with size, weight, and power (SWaP). DVB-S2 uses power and bandwidth efficient modulation and coding techniques to deliver performance approaching theoretical limits of RF channels. NASA's NEN has conducted testing at NASA Wallops Flight Facility (WFF) to successfully demonstrate DVB-S2 over a S-band 5 MHz channel achieving 15 Mbps with 16 APSK LDPC 9/10 code (14).

### 9.5.9 On the Horizon RF Communications

As CubeSat missions employ more automation, constellations could exchange information to maintain precise positions without input from the ground. Radiometric ranging is a function recently incorporated into CubeSat transceivers. A timing signal is embedded into the radio signal and is used to determine the range to the spacecraft. Using this method along with directional vectors obtained from ground antennas allows for trajectory determination of satellites beyond low-Earth orbit. Spacecraft may relay data to increase the coverage from limited ground stations. Inter-CubeSat transponders may very well become a vital element of eventual deep space missions, since CubeSats are typically limited in broadcasting power due to their small size and may be better suited to relay information to Earth via a larger, more powerful mothership.

A CubeSat constellation may involve numerous CubeSats in the constellation (e.g., tens or hundreds). Each CubeSat is typically identical from a communication perspective. One CubeSat may be mother ship-capable while the others may be subordinate (e.g., daughterships), however, multiple CubeSats may have the ability to fulfill the role of a mothership.

CubeSat constellations optimize coverage over specific areas or improve global revisit times to fulfill mission objectives. There is growing interest among the NASA science community in using constellations of CubeSats to enhance observations for Earth and space science. NASA GSFC has conducted research on future CubeSat constellations. This includes CubeSat swarms, daughter ship/mother ship constellations, NEN S- and X-band direct-to-ground links, TDRS Multiple Access (MA) arrays, and Single Access modes. The MA array requires the use of spread-spectrum to support multiple simultaneous communications links to increase coverage and link availability.

Spacecraft routinely use transponders, however, networked swarms of CubeSats that pass information to each other and then eventually to ground, have not flown. Developing networked swarms is less of a hardware engineering problem than a systems and software engineering problem in that one must manage multiple dynamic communication links.

As of this 2021 edition, only the two MarCO SmallSats have operated beyond low-Earth orbit. Both satellites used a deployable reflectarray panel at X-band and were equipped with a full-duplex radio providing both UHF and X-band coverage. This allowed for near real-time updates of the InSight rover's landing. After this success, more SmallSats may be deployed beyond low-Earth orbit. The ability to provide crosslink relay hops for large spacecraft will prove to be critical for deep space missions.

IRIS Version 2 is a CubeSat/SmallSat compatible transponder developed by NASA Jet Propulsion Laboratory (JPL) as a low volume and mass, lower power and cost, software/firmware defined telecommunications subsystem for deep space technology demonstration missions (15). IRIS is

designed to be radiation-hardened for deep space missions and interoperable with the NASA Deep Space Network (DSN). Launch date is currently TBD.

## 9.6 Optical Communications

Optical communications or lasercom, is the use of optical wavelengths of electromagnetic radiation to transmit messages wirelessly between user terminals. Optical communication is the forefront of current wireless communication technologies for small satellites. The technology is relatively new, and as such few proven optical communications terminals exist. Most available data is produced by government laboratories.

Optical communications offer better performance than RF systems due to larger bandwidths available at sub-millimeter wavelengths. Laser communications have a low probability of intercept, are difficult to jam and encounters very little interference because of its narrow beamwidth. At the present, optical frequencies are unregulated and allow for large bandwidths and high channel throughput. Figure 9.6 displays the differences between Laser and RF link and data downlink.

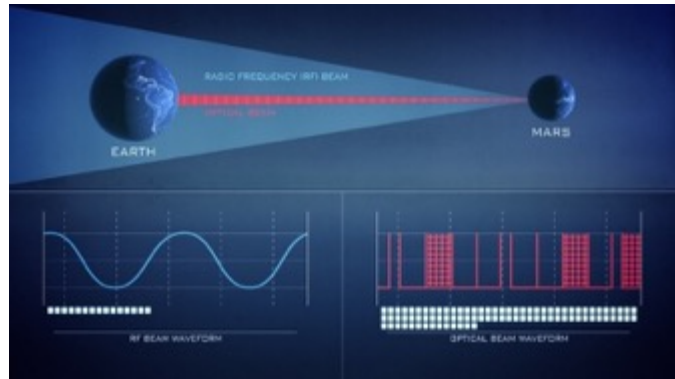


Figure 9.6: Laser vs RF link and data downlink. Credit: NASA.

CubeSats have successfully demonstrated laser communication in space, and the technology is quickly maturing. The Aerospace Corporation, in cooperation with NASA ARC, launched three CubeSats in its AeroCube Optical Communication and Sensor Demonstration; see figure 9.7. In March 2018, a systems checkout was completed, and the mission entered the operational phase. AeroCube's optical system successfully transmitted in mid-2018.

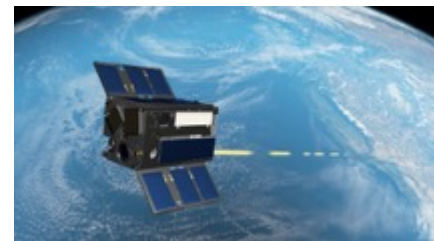


Figure 9.7: An artist rendering of laser communications for the OCSD. Credit: NASA.

### 9.6.1 System Architecture

Lasercom terminals (LCT) are comprised of an optical modem, optical amplifier, and optical head, see figure 9.8 for a laser terminal diagram. This is not always the case, as the Lunar Laser Communications Demonstration (LLCD) on NASA's Lunar Atmosphere and Dust Environment

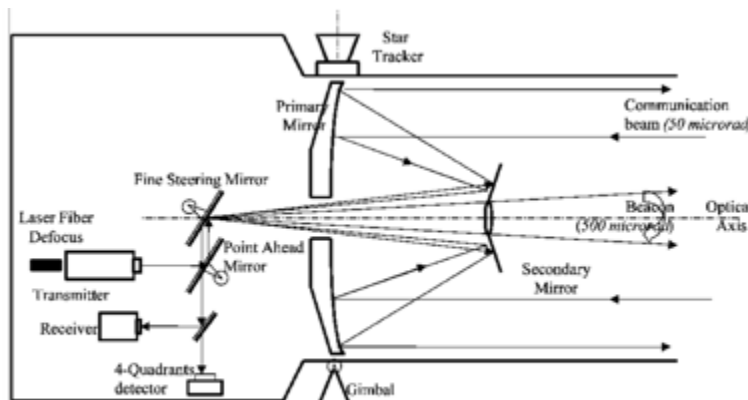


Figure 9.8: Laser terminal architecture diagram. Credit: M. Guelman et al. (2004).

Explorer (LADEE) spacecraft had the modem separated from the optical head (16). The key parameters of an optical comm system are frequency, aperture size, and range. Successful optical communications links require extremely high pointing accuracy; thus the system relies heavily on the attitude determination and control system (ADCS). Optical modems may be software defined and can support multiple modulation and coding schemes, similar to RF. The optical head is very similar to a RF



antenna, it uses optics to concentrate energy through an aperture to form a very narrow beam. The narrower the beam, the higher the power density and the higher the data rate, range, or link.

### 9.6.2 Design Considerations

Lasercom terminals offer a smaller footprint and power draw compared to the RF alternative. However, the pointing requirements are much more difficult to achieve. Current ADCS for SmallSats do not quite meet the needs of LCT pointing. This is the greatest challenge to mainstream implementation. Generally, an optical comm system on a spacecraft can provide both coarse and fine pointing. After slewing as accurately as ADCS is able, the LCT will use both fast-steering mirrors used for fine pointing. Some systems also use gimbals for coarser pointing if the spacecraft ADCS cannot provide sufficient accuracy.

Much like rain attenuation at higher bands, for optical communications cloud cover can prove difficult, even insurmountable. If the cloud coverage is too great at a specific ground station, the transmission may be held for a later time or passed off to a different ground station. Some optical ground stations have sophisticated adaptive optics to accommodate atmospheric spreading and diffusion caused by turbulence.

Lasercom crosslink development is a field of great interest for both commercial and government customers. In the past, building a high-speed crosslink space network has proven nearly impossible (18). The challenges facing inter-satellite optical communications links primarily lies with the pointing accuracy, acquisition, and tracking requirements. Satellites in orbit are traveling at high speeds and experience jitter and vibration. This poses an extreme challenge and necessitates an advanced mechanical optical system to overcome. In the last few years, impressive progress has been made in the civilian and government non-classified arenas to make inter-satellite optical links a reality (18).

### 9.6.3 Policies and Licensing

Currently there are no licensing requirements for spacecraft laser communications. As the technology is still in development, there is minimal regulation of the few terminals in use. For commercial applications, the regulatory agency that will have to be dealt with the most is the FAA. FAA coordination is relevant to lasercom only if ground terminals are transmitting. Given that the transmit or crosslink vehicles are hundreds of miles above the highest-flying aircraft, it is not necessary to coordinate with the FAA, as beam dispersion is so great it doesn't represent a risk. The American National Standard documents serve as the guiding basis from which many of the FAA requirements were derived. From ANSI Z136.6 "American National Standard for Safe Use of Lasers Outdoors": Operators of lasers that have a divergence less than 10  $\mu$ rad, or that exceed a peak irradiance greater than 1  $mWcm^{-2}$  above 18 km (60,000 feet) in altitude above sea level, should contact U.S. Space Command regarding "Laser Clearinghouse" screening. When transmitting through navigable airspace, coordination with the FAA may be required to prevent damage to eyesight or distraction to pilots (19).

The laser clearinghouse (LCH) is tasked with ensuring orbital assets are not negatively impacted by lasers. However, the LCH only considers DoD laser programs to be required to coordinate laser activities with them. Many non-DoD projects volunteer to coordinate with LCH to ensure no damage to satellites. The process of coordinating with LCH can take many months and should be started as early as possible. Establishing a new account with LCH may involve significant lead time but submitting Predictive Avoidance Requests to run a pass is only 7 days. When designing a lasercom link, ensuring that the laser system can quickly autonomously shutter itself if laser pointing drift occurs could allow for the request of a smaller Keep Out Cone from the LCH. This will reduce the number of predictive avoidance outages your mission will have during operations.



#### 9.6.4 Missions

The first attempt to demonstrate laser communication on a CubeSat was on-board FITSAT-1, a 1U system developed at the Fukuoka Institute of Technology in Japan. The satellite carried two arrays of high-power LEDs along with an experimental RF transceiver. The robotic arm of the International Space Station (ISS) deployed FITSAT-1 in October 2012. The German Aerospace Center is currently flying two lasercom terminals as part of its OSIRIS program. The Small Optical Transponder (SOTA) developed by the National Institute of Information and Communications Technology in Japan (NICT) has successfully demonstrated a laser space-ground link from a 50 kg microsatellite (20). Tesat-Spacecom offers the CubeLCT laser communication terminal (0.3U, 0.4 kg, 8 W), also known as OSIRIS4 CubeSat (21) and offers high bandwidth space-to-ground data transmissions of up to 100 Mbit/s. CubeLCT was launched in January 2021 as part of SpaceX's first SmallSat rideshare program, Transporter-1, aboard a Falcon 9 (22).

There are several up and coming laser communications technologies, all lower TRL than existing missions. Future endeavors include the NASA-sponsored Miniature Optical Communication Transmitter (23) and the CLICK mission (24). CLICK is a two-part mission, sponsored and overseen by NASA's SST Program and involving MIT, and University of Florida for the payload and BCT for the bus. CLICK-A will demonstrate a laser downlink, CLICK-B/C a laser cross-link. All CLICK spacecraft are 3U spacecraft and the payload occupies approximately 1.5U. The CubeSat lasercom module by Hyperion Technologies enables a bidirectional space-to-ground communication link between a CubeSat and an optical ground station, with downlink speeds of up to 1 Gbps and an uplink data rate of 200 Kbps.

#### 9.6.5 On the Horizon Optical Communications

Spacecraft parameters like power, mass, and volume are constrained by cost and current capability. Ground operations, on the other hand, are not subject to the same limitations. Asymmetric laser communications leverage this imbalance. Asymmetric laser communication uses a remotely generated laser (e.g., does not require an on-board signal carrier) and Modulating Retro-Reflector (MRR) to reflect and modulate a laser beam (encoding it with spacecraft data) back to Earth. The laser is located on Earth, where power and volume constraints are not as tight, while the communications payload on the spacecraft is limited to only a few watts for operation, see figure 9.9. NIWC is developing this technology using a MEMS-based MRR (20), The Navy has funded Boston Micromachines via small business innovative research (SBIR) to develop a Large Aperture Micro-Electro-Mechanical (MEMS) MRR. The goal of the project is to develop MRRs with a clear aperture of 25.4mm with packaging to survive the launch environment and operate in the vacuum of space.

Fibertek developed a 2U CubeSat lasercom system in 2018 based on work performed under a NASA ARC SBIR and continues to make substantial progress in lasercom and LiDAR technologies. Sinclair Interplanetary is developing the DCL-17 (TRL 5), a self-contained optical communications terminal that incorporates a built-in star tracker and a 1 Gbps laser downlink. CubeSat LCT are also in development by General Atomics and Hyperion Technologies. In addition to CubeSat terminals, larger terminals for SmallSats are under development by Tesat, Mynaric (26), SpaceMicro (27), and SA Photonics.



Figure 9.9: Scheme for using land-based laser to transmit data from CubeSat using on-board MRR. Credit: Salas et al. (2012).



## 9.7 Summary

There is already strong flight heritage for many UHF/VHF and S-band communication systems for CubeSats. Less common, but with growing flight heritage, are X-band systems. Higher RF frequencies and laser communication already have CubeSat flight heritage, but with limited (or yet to be demonstrated) performance. Although there are limited Ka-band systems for CubeSats today, high rate transmitters such as the Astro Digital AS-10075 demonstrated 320 Mbps in the Landmapper-BC 3 v2 mission. On the other hand, laser communication is a spaceflight-ready technology that should see future onboard laser systems with increased performance. Alternatively, a few groups are working on asymmetric laser communication, but this is still a relatively low TRL technology. Since optical communications uplink and downlink can be blocked by clouds, RF is considered complementary to maintain contact under all conditions. There is growing interest among the NASA science community in using constellations of CubeSats to enhance observations for Earth and space science.

For feedback solicitation, please email: [arc-sst-soa@mail.nasa.gov](mailto:arc-sst-soa@mail.nasa.gov). Please include a business email for further contact.



Table 9-1: Antennas

Manufacturer	Product	Type	Min Frequency	Frequency Band	Gain	Polarization	Mass	Dimensions	Flight Heritage
---	---	---	[MHz]	--	[dBi]	--	[g]	[cm]	---
Haigh-Farr, Inc.	Part Number: 17100	Crossed Dipole	307	VHF,UHF	--	RHCP	267	32x8x1	Y
GomSpace	NanoCom ANT430	Omni Canted Turnstile	400-435	VHF, UHF	1.5	Circular	30	10x10	Y
Helical Communications Technologies	Helios Deployable Antenna	Helical	400-3000	VHF, S	3	Circular	180	10x10x3.5	Y
NanoAvionics	CubeSat UHF Antenna System	Turnstile	400-500	VHF, UHF	1.37	--	33	10x10x0.7	
EnduroSat	UHF Antenna III	Whip/Burnwire	435-438	VHF, UHF	> 0	RHCP	85	10x10	Y
ISISPACE	CubeSat Antenna System for 1U/3U	Tape	--	VHF, UHF	0	Circular, Linear	89	10x10x0.7	Y
Flexitech Aerospace	600MHz - 10GHz Spiral Antenna	Spiral	600-10000	UHF, L, S, C, X	3	Circular	1283	17x17x8.5	N
NAL Research Corporation	Antenna SYN7391-A/B/C (Iridium)	Flat Mount	1610-1626.5	L	4.9	RHCP	31	4.6x4.3x1.0	Y
Flexitech Aerospace	2-2.5GHz Turnstile Antenna	Turnstile	2000-2500	S	5	Circular	173	--	N
Vulcan Wireless	ANT-S/S Unified S-Band Antenna	Patch	2025-2300	S	6.5	Circular	76	8x8x1	Y
EnduroSat	S-band Patch Antenna	Patch	2025-2110	S	7	Circular	64	10x10	Y
Syrlinks	SPAN-S-T3	Patch	2025-2290	S	4.8	Circular	117	8x8x11	Y
IQ Spacecom	S-band Patch Antenna	Patch	2100-2500	S	6	Circular	49	7x7x1	Y
ISISPACE	S-Band Patch Antenna	Patch	2200-2290	S	6.5	RHCP	50	8x8x1	N



Haigh-Farr, Inc.	S-band Patch Antenna	Patch	2245-2245	S	--	RHCP	48	4.8x6.5x6.5	Y
EnduroSat	X-band Patch Antenna	Patch	8025-8400	X	6	RHCP	2.2	--	Y
Syrlinks	SPAN-X-T2	Patch	8025-8450	X	7.6	RHCP	68	10x10x7	Y
Syrlinks	SPAN-X-T3	Patch	8025-8400	X	11.5	Circular	65	7.3x7.3x11	Y
Cesium Astro	Nightingale	Phased Array	27000-40000	Ka	30	Circular	1200	18x18x2	N
Oxford Space Systems	Helical antenna	Deployable	--	862 – 928 MHz	6.5	RHCP	~300	33	Y
Oxford Space Systems	Yagi antenna	Deployable	--	156.5 -162.5 MHz	6.5	Dual Linear	<1kg	100 x 70	Y
Oxford Space Systems	Deployable Cassegrain Wrapped Rib Antenna	Deployable	--	X-band	46 - 49	Linear	25kg to 38kg	300 - 500	N
Oxford Space Systems	Deployable Parabolic Offset Reflector	Deployable	--	C-band	42	Linear	from 12kg to 21kg	200 - 600	N
Oxford Space Systems	Deployable Hinged Rib Metal Mesh	Deployable	--	K/Ka-band	41	Linear	~2-3kg	~60	N
Redwire Space	Narwhal Antenna	Helical	100 – 4 GHz	L	6-18	Circular	0.0032	1.25U x 1.25U x 2U	N



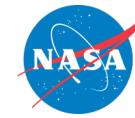


Table 9-8: Radios

Manufacturer	Product	Type	Min Frequency	Frequency Band	Data Rate	Tx Power	Mass	Dimensions	Flight Heritage
---	---	---	[MHz]	--	[kbps]	--	[g]	[cm]	---
Space Micro	MicroSDR-C	SDR	70-3000	VHF, UHF, L, S, C	42,000	0	750	10x10x8	Y
GomSpace	NanoCom SDR	SDR	70-6000	VHF, UHF, L, S, X	--	--	271	9x9x6.6	Y
NI Ettus Research	B205mini	SDR	70-6000	VHF, UHF, L, S, X	--	10 dBm	24	8.3x5.1x8	Y
AstroDev	Helium-100	Transceiver	120-150 400-450	VHF, UHF	38.4	3 W	78	9.6x9x1.6	Y
AstroDev	Lithium-1	Transceiver	130-450	VHF, UHF	9.6	0.25-4 W	48	1.0x3.3x6.5	Y
AstroDev	Beryllium-2	Transceiver	130-450	VHF, UHF	9.6	0.25-4 W	52	1x3.3x6.5	Y
GomSpace	NanoCom AX100	Transceiver	143-150 430-440	VHF, UHF	0.1-38.4	30 dBm	24.5	6.5x4x7	Y
LY3H	SatCOM TP0	FM Repeater	144-146 430-440	VHF, UHF	--	217 mW	59	--	Y
ISISPACE	TRXVU	Transceiver	145.8-150.05 400.15-440	VHF, UHF	9.6	27 dBm	75	9x9.5x1.5	Y
SpaceQuest	TRX-U	Transceiver	390-450	UHF	19.2	2	140	8.3x5.7x1.6	Y
NanoAvionics	SatCOM UHF	Transceiver	395-440	VHF, UHF	2.4-38.4	3 W	7.5	5.6x3.3x6.6	Y
EnduroSat	UHF Transceiver Type II	Transceiver	400-403 430-440	UHF	19.2	1.4 W	94	10x10x2	Y
L3 Communications, Inc./SDL	Cadet	SDR	450	VHF, UHF	3,000	--	200	6.9x7.4x1.34	Y
AAC Clyde Space	PULSAR-TMTC	SDR	--	VHF, UHF	9.6	1.5 W	100	9.6x9x1.6	Y
NearSpace Launch	EyeStar-D2	Transceiver	1610-1625 2484-2499	L	10,000	0.8 W	138	6.1x11.9x2.2	Y
sci_Zone, Inc.	LinkStar-STX3	Transmitter	1610-1625	L	0.009	--	48	8.6x5.3x2.9	Y



Qualcomm	GSP-1720	Transmitter	1610-1626.5 2483.5-2500	L, S	9.6	31 dBm	60	11.9x6.5x1.5	Y
NAL Research Corporation	NAL Iridium 9602-LP,	Iridium Satellite Tracker	1616-1626.5	L	--	1 W	136	6.9x5.5x2.4	Y
NearSpace Launch	EyeStar-S3	Transmitter	1616.25	L	600	20 dBm	22	1.5x2.6x5.5	Y
L3Harris	CXS-1000	Transponder	1700-2100	L,S	20,000	1-5 W	1360	10x10x11	Y
Tethers Unlimited	SWIFT-SLX	SDR	1700-2500	S	6,000	33 dBm	300	9x9.8x3.6	Y
Tethers Unlimited	SWIFT-XTS S Transceiver X Transmitter	SDR	1700-2500 7000-8500	S, X	6,000- 25,000	34 dBm	800	9x9.8x6	Y
SpaceQuest	TX-2400	Transmitter	2000 to 2300	S	6,000	2.5	70	6.8x3.5x1.5	Y
Syrlinks	EWC27 + OPT27- SRX S/X Transceiver	Transceiver	2025-2110	S	100,000	27-33 dBm	400	9x9.6x3.9	Y
Innoflight, Inc.	SCR-104	SDR	Tx: 2200-2300 Rx: 1760-1840 2025-2110	L, S	4500	1	290	9.8x8x3	Y
IQ Wireless GmbH	HISPICO	Transmitter	2100-2500	S	1,000	27 dBm	100	9.5x4.6x1.5	Y
Emhiser Research, Inc.	ETT-01EBA102-00	Transmitter	2200-2400	S	--	1 W	57	3x8.6x0.8	Y
Quasonix	NanoTX	Transmitter	2200.5-2394.5	S	50	1-10 W	Request	3.3x8.6x0.8	Y
IQ Wireless GmbH	SLINK-PHY	Transceiver	2200-2290 2025-2110	S	64-4,000	30 dBm	275	6.5x6.5x13.7	Y
ISISPACE	TXS	Transceiver	2200-2290	S	4.3	27-33 dBm	132	9.8x9.3x1.4	Y
Syrlinks	S-band Transponder EWC31	Transponder	2200-2290 2025-2110	S	8-2,000	27-33 dBm	--	--	Y
EnduroSat	S-band Transmitter	Transmitter	2200-2290 2400-2450	S	20,000	0.5-2 W	250	--	Y
General Dynamics	S-Band TDRSS/DSN	Transponder	Tx: 2200-2300 Rx: 2025-2220	S	12,000	0.03 W	4900	19x23x15	Y



Microhard	Nano N2420	Modem	2400-2483.5	S	230	0.1-1 W	210	5x3x0.6	Y
Honeywell	STC-MS03	Transceiver	--	S	6,250	3.16 W	1000	16x11x4.4	Y
AAC Clyde Space	PULSAR-DATA S-Band Transmitter	SDR	--	S	7,500	1 W	100	9.6x9x1.7	Y
Laboratory for Atmospheric and Space Physics (LASP)/Blue Canyon Technologies (BCT)	X-band Radio	SDR	Tx: 2200-2500 8000-8500 21000-33000 Rx: 1760-1840 2000-2110 21000-23000	Downlink: S, X, Ka Uplink: L, S, Ka	100,000	30 dBm	--	4.5x4.35x1.25	Y
Tethers Unlimited	SWIFT-XTX X Transmitter	SDR	7000-8500	X	25,000	33 dBm	300	9x9.8x6	N
General Dynamics	X-Band Small Deep Space	Transponder	7145 -7230 8400-8500	X	100,000	0.06	3200	18x17x11	Y
JPL/SDL	IRIS V2	Transponder	7200-8400	X, Ka	--	3.8 W	1200	10x10x5.6	Y
Innoflight, Inc.	SCR-106	SDR	Tx: 7900-8500 Rx: 1760-1840 2025-2110	X	150,000	0.02-2.5 W	290	9.8x8.2x2.8	N
EnduroSat	X-band Transmitter	Transmitter	7900 to 8400	X	150,000	27-33 dBm	270	9x9.6x2.6	N
IQ Wireless GmbH	XLINK	Transceiver	8025-8500 7145-7250	X	64-25,000	30 dBm	--	<1 U	Y
Symlinks	X-band Transmitter EWC27	Transmitter	8025-8400	X	140,000	27-33 dBm	225	9x9.6x2.6	Y
AAC Clyde Space	PULSAR-DATA X-Band Transmitter	SDR	--	X	50,000	2 W	130	9.6x9x1.1	Y
Tethers Unlimited	SWIFT-KTX Ka Transmitter	SDR	20200-21200 24000-27000	Ka	25,000	33 dBm	300	9x9.8x4	N
Tethers Unlimited	SWIFT-KTRX Ka Transmitter	SDR	24000-27000	Ka	1,000,000	35 dBm	1,000	16x9.6x6	N
SpaceMicro	microKaTx-300	Transmitter	25250-27250	K	1,000,000	2	1000	10x10x8	Y

**Table 9-9: Optical Communications Terminals**

Vendor/Developer	Program	Platform	Downlink Data Rate	Range	DC Power	Mass	Launch Date	Reference
---	---	---	[Mbps]	[km]	[W]	[kg]	---	---
The Aerospace Corporation	Optical Communications and Sensor Demonstration (OCSD)	Aerocube-7	200	1,000	2.3	30	11.2017	Datasheet
The Aerospace Corporation	Testbed for Optical Missions Satellite (TOMSat)	Aerocube-11	200	1,000	4.2	25	12.2018	Datasheet
Fibertek	WeatherSat AgileSat	MORPHEUS Cubesat	1,000	4,000	2.5	30	2020	Datasheet
MIT-LL	NODE (Nanosatellite Optical Downlink Experiment)	NODE (Nanosatellite Optical Downlink Experiment) Cubesat	20	2,000	1.0	15	2018	Datasheet
TESAT	NFIRE	NFIRE	n/a	4,900	30.0	130	4.2007	Datasheet
German Aerospace Center (DLR)	OSIRIS	Flying Laptop	200	600	1.3	26	7.2017	Datasheet
German Aerospace Center (DLR)	OSIRIS	BiROS	1,000	1,000	5.0	50	6.2016	Datasheet



## References

- (1) Pelton, J.N.: "The Basics of Satellite Communications." s.l.: Professional Education International, Inc., 2006.
- (2) National Aeronautics and Space Administration. Integrated Solar Array and Reflectarray Antenna (ISARA) for High Bandwidth CubeSats. NASA. [Online] 2016.
- (3) JPL. Mars Cube One (MarCO). *Jet Propulsion Laboratory California Institute of Technology | CubeSat*. [Online] <https://www.jpl.nasa.gov/cubesat/missions/marco.php>.
- (4) Xie, Shuanglong, et al. "Wireless Sensor Network for Satellite Applications: A Survey and Case Study." 2014, Unmanned Systems, Vol. 2, pp. 261-277.
- (5) Schoemaker, R. and Bouwmeester, J.: "Evaluation of Bluetooth Low Energy Wireless Internal Data Communication for Nanosatellites." 2014. Small Satellites Systems and Services Symposium. pp. 1-15.
- (6) Farrell, P. G. and Clark, A. P.: "Modulation and coding." 1984, International Journal of Satellite Communications.
- (7) Datta, Anusuya. New FCC rules make small satellite licensing easier, faster, and cheaper. Geospatial World | Advancing Knowledge for Sustainability. [Online] August 22, 2020. <https://www.geospatialworld.net/blogs/new-fcc-rules-make-small-satellite-licensing-easier-faster-and-cheaper/>.
- (8) Buxton, Jerry and Glasbrenner, Drew. AMATEUR RADIO AND EXPERIMENTAL LICENSING FOR CUBESATS.
- (9) CalPoly. CubeSat Licensing Support. CubeSat. [Online] <https://www.cubesat.org/cubesatlicensing-support>.
- (10) National Institute of Standards and Technology: "Security Requirements for Cryptographic Modules, Federal Information Processing Standard (FIPS). ISO/IEC 19790:2012; ISO/IEC 24759:2014
- (11) 47 CFR Part 97 - AMATEUR RADIO SERVICE <https://www.law.cornell.edu/cfr/text/47/part-97>
- (12) Wertz, James R., Everett, David F. and Puschell, Jeffery J.: "Space Mission Engineering: The New SMAD." Hawthorne, CA : Microcosm Press, 2015.
- (13) Johnson, S.K., Reinhart, R.C. and Kacpura, T.J.: "CoNNeCT's approach for the development of three Software Defined Radios for space application." Big Sky, MT : s.n., 2012. 2012 IEEE Aerospace Conference. pp. 1-13.
- (14) Wong, Yen, et al. "NASA Near Earth Network (NEN) DVB-S2 Demonstration Testing for Enhancing Data Rates for CubeSats." Logan : 31th Annual AIAA/USU Conference on Small Satellites, 2019.
- (15) JPL. "Iris V2 CubeSat Deep-Space Transponder (IRIS)." *Jet Propulsion Laboratory California Institute of Technology | CubeSat*. [Online] <https://www.jpl.nasa.gov/cubesat/missions/iris.php>
- (16) NASA. Lunar Laser Communication Demonstration NASA's First Space Laser Communication System Demonstration. *NASAFacts*. [Online] [https://www.nasa.gov/sites/default/files/llcdfactsheet.final\\_.web\\_.pdf](https://www.nasa.gov/sites/default/files/llcdfactsheet.final_.web_.pdf).



- (17) Kogan, A. and Guelman, Mauricio Moshe. Acquisition and pointing control for inter-satellite laser communications. 2004, IEEE Transactions on Aerospace and Electronic Systems
- (18) Panahi, Allen and Kazemi, Alex A. Optical Laser Cross-Link in Space-Based Systems used for Satellite Communications. [book auth.] Alex A. Kazemi. *Photonics in the Transportation Industry: Volume III: Auto to Aerospace*. s.l. : SPIE Press, 2010.
- (19) American National Standard for Safe Use of Lasers Outdoors": ANSI Z136.6 (2015) - Safe Use Of Lasers Outdoors (Electronic Version)
- (20) National Institute of Information and Communications Technology. World's First Demonstration of Space Quantum Communication Using a Microsatellite. *NICT*. [Online] 2017.
- (21) Tesat. CubeLC: "SmalleSt laSer CommuniCation tranSmitter" WorldWide datasheet. *Products*. [Online] 2020. [https://www.tesat.de/images/tesat/products/CubeLCT\\_Data-Sheet.pdf](https://www.tesat.de/images/tesat/products/CubeLCT_Data-Sheet.pdf).
- (22) Exolaunch. "DLR mission PIXL-1 is integrated by Exolaunch for SpaceX's Falcon 9 upcoming launch from Cape Canaveral." *Exolaunch*. [Online] <https://exolaunch.com/news-block-23.html>.
- (23) Serra, P., et al.: "*Deep Space Laser Communication Transmitter and High Precision Timing System for Small Satellites*." Logan, UT : s.n., 2016. 30th Annual AIAA/USU Conference on Small Satellites.
- (24) NASA. CubeSat Laser Infrared Crosslink. [Online] 07 31, 2020. [https://www.nasa.gov/directorates/spacetech/small\\_spacecraft/cubesat\\_laser\\_infrared\\_crosslink/](https://www.nasa.gov/directorates/spacetech/small_spacecraft/cubesat_laser_infrared_crosslink/)
- (25) Mynaric. Mynaric on track to become industry-first supplier of satellite constellation-grade laser communication. [Online] 04 03, 2020. <https://mynaric.com/news/mynaric-on-track-to-become-industry-first-supplier-of-satellite-constellation-grade-laser-communication/> .
- (26) SpaceMicro. Laser Communication Terminals. [Online] 2020. <https://www.spacemicro.com/products/lasercom.html>.
- (27) Wayne, D., et al.: "*Design and Testing of a CubeSat-Sized Retroreflector Payload* ." 2015. 29th Annual AIAA/USU Conference of Small Satellites.
- (28) Salas, A.G., Stupl, J. and Mason, J.: "*Modulating retro-reflectors: technology, link budgets and applications*." 2012. 63rd International Astronautical Congress.
- (29) Ilčev, Stojče Dimov. Ground Communication Segment. Global Aeronautical Distress and Safety Systems (GADSS). s.l.: Cham Springer, pp. 227-313.



## Chapter Contents

Glossary .....	ii
10.0 Integration, Launch, and Deployment.....	253
10.1 Introduction .....	253
10.2 State-of-the-Art – Launch Integration Role.....	253
10.2.1 Launch Brokers and Services Providers.....	254
10.3 Launch Paradigms .....	255
10.3.1 Dedicated Launches .....	255
10.3.2 Traditional Rideshare Launches .....	255
10.3.3 Dedicated Rideshare Launches.....	256
10.4 Deployment Methods .....	256
10.4.1 CubeSat Dispensers.....	256
10.4.2 SmallSat Separation Systems .....	257
10.4.3 Integration Hardware .....	258
10.4.4 Orbital Maneuvering / Transfer Vehicles.....	260
10.5 International Space Station Options.....	261
10.5.1 Deployment from ISS .....	261
10.5.2 Deployment Above ISS.....	262
10.6 On the Horizon.....	263
10.6.1 Integration.....	263
10.6.2 Launch.....	263
10.6.3 Deployment .....	263
10.7 Summary.....	263
References.....	264



## Chapter Glossary

(CBOD)	Clamp Band Opening Device
(CDS)	CubeSat Design Specification
(CSLI)	CubeSat Launch Initiative
(DPAF)	Dual Payload Attach Fittings
(EAGLE)	ESPA Augmented Geostationary Laboratory Experiment
(EELV)	Evolved Expendable Launch Vehicle
(ENRCSD)	Nanoracks External CubeSat Deployer
(ESA)	European Space Agency
(ESPA)	EELV Secondary Payload Adapter
(GEO)	Geostationary Equatorial Orbit
(HEO)	Highly Elliptical Orbit
(ISS)	International Space Station
(J-SSOD)	JEM Small Satellite Orbital Deployer
(JAXA)	Japan Aerospace Exploration Agency
(JEM)	Japanese Experimental Module
(JEMRMS)	Japanese Experimental Module Remote Manipulator System
(M-OMV)	Minotaur Orbital Maneuvering Vehicle
(MEO)	Medium Earth Orbit
(MLB)	Motorized Light Bands
(MPAF)	Multi Payload Attach Fittings
(MPEP)	Multi-Purpose Experiment Platform
(NOAA)	National Oceanic and Atmospheric Administration
(NRCSD)	Nanoracks ISS CubeSat Deployer
(OMV)	Orbital Maneuvering Vehicle
(PCBM)	Cygnus Passive Common Berthing Mechanism
(SL-OMV)	Small Launch Orbital Maneuvering Vehicle
(SSMS)	Small Spacecraft Mission Service
(SSOD)	Small Satellite Orbital Deployer
(TRL)	Technology Readiness Level





## 10.0 Integration, Launch, and Deployment

### 10.1 Introduction

Of the 1,282 total spacecraft launched in 2020, more than 1,100 were SmallSats with a mass under 600 kg (2). The last half of 2020 launched a total of 719 spacecraft where more than 230 had mass under 200 kg and 58% had mass between 201 kg and 600 kg (1). 12% of all the spacecraft launched in 2020 were containerized CubeSats. With more SmallSat and CubeSat constellations currently being planned, the demand for launch of SmallSats is expected to continually rise (2).

Since launch vehicle capability usually exceeds primary customer requirements, there is typically mass, volume, and other performance margins to consider for the inclusion of a secondary small spacecraft. Small spacecraft can exploit this surplus capacity for a relatively inexpensive ride to space. A large market of adapters and dispensers has been created to compactly house multiple small spacecraft on existing launchers. These technologies provide a structural attachment to the launcher as well as deployment mechanisms. This method, known as “rideshare,” is still the main way of putting small spacecraft into orbit. As these adapters and dispensers have become more developed, dedicated ridesharing, where an integrator books a complete launch and sells the available capacity to multiple spacecraft operators without the presence of a primary customer, has taken on more popularity. Additionally, nanosatellite form factors are increasing in dimension, which require larger dispensers to accommodate these larger CubeSat sizes.

Although not a new idea, using orbital maneuvering systems to deliver small spacecraft to intended orbits is another emerging technology. Several commercial companies are developing orbital tugs to be launched with launch vehicles to an approximate orbit, which then propel themselves with their on-board propulsion system to another orbit where they will deploy their hosted small spacecraft.

Expanding future capabilities of small satellites will demand dedicated launchers. For missions that need a very specific orbit, interplanetary trajectories, precisely timed rendezvous, or special environmental considerations, flying the spacecraft as a primary spacecraft may be the best method of ascent. Technology developers and hard sciences can take advantage of the quick iteration time and low capital cost of small spacecraft, to yield new and exciting advances in space capabilities and scientific understanding. The emergence of very small launch vehicles has altered the landscape by providing dedicated rides for small spacecraft to specific destinations on timelines more controlled by the spacecraft.

The information described below is not intended to be exhaustive but provides an overview of current state-of-the-art technologies and their development status for a particular small spacecraft subsystem. It should be noted that Technology Readiness Level (TRL) designations may vary with changes specific to payload, mission requirements, reliability considerations, and/or the environment in which performance was demonstrated. Readers are highly encouraged to reach out to companies for further information regarding the performance and TRL of described technology. There is no intention of mentioning certain companies and omitting others based on their technologies or relationship with NASA.

### 10.2 State-of-the-Art – Launch Integration Role

Launch options for a SmallSat include dedicated launch, traditional rideshare launch, or multi-mission launch, as described in the launch section below. Regardless of the approach, however, integration with the launch vehicle is a complex and critical portion of the mission. The launch integration effort for a primary spacecraft typically includes the launch service provider, the spacecraft manufacturer, the spacecraft customer, the launch range operator, and sometimes a



launch service integration contractor (3). When launching on either a multi-mission or rideshare launch, the launch integration becomes even more complex.

When flying as a secondary spacecraft on a rideshare launch, it is generally the primary spacecraft customer who decides whether secondary spacecraft will share a ride with the primary spacecraft and, if so, how and when the secondary spacecraft are dispensed. This is not always the case, however, as there are occasions where the launch vehicle contractor or a third-party integration company can determine rideshare possibilities. More flexibility may be available to secondary spacecraft that are funded through such a program, although the mission schedule is normally still determined by the primary spacecraft.

There are several options for identifying and booking a ride for a SmallSat. For rideshare and multi-mission launches, the spacecraft customer may choose to use a launch broker or aggregator to facilitate the manifesting, or work directly with the launch service provider. A launch broker matches a spacecraft with a launch opportunity whereas an aggregator provides additional services related to manifesting. In the event of a dedicated launch, the spacecraft customer generally does not use a launch broker or aggregator. In both cases, however, key aspects for integration must be managed and a launch integrator can assist or coordinate those activities for the spacecraft customer.

Whether a spacecraft customer chooses to use a launch integrator or not, certification of flight is a key spacecraft responsibility. Requirements for radio frequency licensing, National Oceanic and Atmospheric Administration (NOAA) remote sensing licensing, and laser usage approval are all the responsibility of the spacecraft operator to obtain (4) (5). The launch integrator or the launch service provider will require proof of licensure before launching the satellite. They will also require additional analyses and supporting data prior to launch. This may include safety documentation, orbital debris information, materials and venting data, and spacecraft specific models (6).

For rideshare and multi-mission launches, many satellites are subject to a “do no harm” requirement to protect the primary satellite or other satellites on a multi-mission launch. A list of do no harm requirements are imposed on the rideshare satellite by the launch provider, launch integrator, or primary mission owner. These requirements vary by launch provider and launch integrator, but usually include restrictions on transmitters, post separation mechanical deployments, and hazardous materials. A comprehensive list of typical do no harm requirements is provided in TOR-2016-02946 Rev A (7).

### **10.2.1 Launch Brokers and Services Providers**

A launch broker for small satellites is an individual or organization which matches a spacecraft with a launch opportunity, usually as a rideshare satellite or a multi-mission manifest spacecraft. Typically, a launch broker does not provide any additional launch integration services beyond coordinating the relationship between the spacecraft manufacturer or customer and the launch service provider. Their purpose is to fill excess capacity on a launch and can bolster negotiations between the launch provider and payload for scheduling, integration, safety testing, and cost (39).

Further services can include working with the satellite customer and the launch vehicle provider to ensure that the customer’s spacecraft is compatible with the launch vehicle’s mission, and by performing analyses and physical integration. This service can also provide the integration hardware, such as CubeSat dispenser, separation system, or other hardware as described below, or this hardware may be provided by either the spacecraft customer or the launch services provider. It should be noted that there is no universally accepted definition of “launch broker” and the term can be used interchangeably with “launch aggregator” and “launch integrator.”



### 10.3 Launch Paradigms

The SmallSat market has grown considerably over the past decade experiencing a 23% compound annual growth rate from 2009 to 2018 (10). From 2013 to 2017 there was an average of about 140 SmallSats (less than 200 kg) launched per year. From 2017 to 2019 this number jumped to around 300 SmallSats per year (1), and more than 300 SmallSats were launched in 2020. In Q1 2021, mini spacecraft 200-600 kg were the most numerous type of spacecraft launched (accounting for less than 50% of total launches), and micro, nano, pico and femto spacecraft were the next most launched spacecraft.

This increase in small satellite demand has caused a shift in the launch vehicle market, as well as with many companies creating or advertising launch platforms centered around small satellites. This section will detail three types of launch methods for SmallSats and the current state of these markets. While other chapters in this report cite specific companies providing “state-of-the-art” technologies, this section will provide an overview of the different types of launches available for SmallSats rather than highlighting specific companies.

#### 10.3.1 Dedicated Launches

In the context of this report, dedicated launches for SmallSats are those that use launch vehicles which are generally meant to be used to launch satellites with a mass less than 180 kg. This does not mean that the maximum mass to orbit is 180 kg or less, however. For the purposes of this report, dedicated launchers will have a maximum payload of 1000 kg, as many launch vehicles being marketed for SmallSats have masses to orbit that are higher than 180 kg. The primary orbit for this type of launch is low-Earth orbit, with very few companies currently targeting highly elliptical orbit (HEO), medium Earth orbit (MEO), or geostationary equatorial orbit (GEO). As reported in October 2019, there were 148 small launch vehicles with a maximum capability of less than 1000 kg to low-Earth orbit being tracked as current and future launch vehicles, however only eight from that list were successfully flown (11).

Dedicated launches for SmallSats have many advantages. A SmallSat on a dedicated launch controls the mission requirements in whole--what they need, when they want to launch, and where they want to go. They generally have a “go / no-go” call on launch day in case something goes wrong with their satellite pre-launch. They can also request special launch accommodations, such as a nitrogen purge or late battery charge, that are generally not available to a rideshare launch. The downside to a dedicated launch is that they are generally much more expensive than a rideshare launch.

#### 10.3.2 Traditional Rideshare Launches

Until recently, there were only a few launchers that allowed small spacecraft to ride as primary spacecraft. The majority of small spacecraft are carried to orbit as secondary spacecraft, using the excess launch capability of larger rockets. Standard ridesharing consists of a primary mission with surplus mass, volume, and performance margins which are used by another spacecraft. Secondary spacecraft are also called auxiliary spacecraft or piggyback spacecraft. For educational small spacecraft, several initiatives have helped provide these opportunities. NASA’s CubeSat launch initiative (CSLI) for example, has provided rides to a significant number of schools, non-profit organizations, and NASA centers. As of April 2021, 124 CubeSats have been launched, and the program continues to select CubeSats for launch (12). The European Space Agency (ESA) “Fly Your Satellite” program is a similar program which provides launch opportunities to university CubeSat teams from ESA Member States, Canada, and Slovenia (13).

From the secondary spacecraft designers’ perspective, rideshare arrangements provide far more options for immediate launch with demonstrated launch vehicles. Since almost any large launcher can fit a small payload within its mass and volume margins, there is no shortage of options for



craft that want to fly as a secondary spacecraft. On the other hand, there are downsides of hitching a ride. The launch date and trajectory are determined by the primary spacecraft, and the smaller craft must take what is available. In some cases, they need to be delivered to the launch provider and be integrated on the adapter weeks before the actual launch date. Generally, the secondary spacecraft are given permission to be deployed once the primary spacecraft successfully separates from the launch vehicle, but there are instances where the rideshare spacecraft separate prior to the primary satellite (14).

### 10.3.3 Dedicated Rideshare Launches

Dedicated rideshare launches, also known as multi-mission launches, are those that use launch vehicles to exclusively launch multiple SmallSats. These launches have shown the ability to hold and deploy dozens of satellites to multiple altitudes, though these orbits tend not to be vastly different. While this type of mission would seem to offer more opportunities to launch small satellites, dedicated rideshare missions are not as common as traditional rideshare missions. This is likely due to difficulties in the logistics of managing so many entities with unique visions and needs, which requires a dedicated systems integrator (15).

This type of launch is particularly important to megaconstellations, however. Megaconstellations place hundreds of satellites in orbit, and using small launchers will not allow for these constellations to be operational within a reasonable amount of time. Dedicated rideshares provide the opportunity to place large numbers of satellites into orbit on a single launch. In fact, dedicated rideshares for megaconstellations accounted for over 450 SmallSats launched in Q1 2021 (14), (17) (18).

## 10.4 Deployment Methods

The method by which SmallSats are deployed into orbit is a critical part of the launch process. The choice of deployment method depends on the form factor of the satellite. This section will discuss the deployment of CubeSats, which generally use CubeSat dispensers, and the deployment of freeflying SmallSats.

### 10.4.1 CubeSat Dispensers

The CubeSat form factor is a very common standard for spacecraft up to approximately 24 kg (12U CubeSat) but can also be extended to approximately 54 kg in a 27U configuration. The CubeSat form lends itself to container-based integration systems, or dispensers, which serve as an interface between the CubeSat and the launch vehicle. It's a rectangular box with a hinged door and spring mechanism. Once the door is commanded to open, the spring deploys the CubeSat.

Many companies currently manufacture dispensers for the CubeSat form factor which follow one of two constraint systems, the rail-type dispenser, and the tab-type dispenser. Due to the large number of dispenser manufacturers, the different companies are not listed here. Instead, a brief overview of the two types of dispensers is provided.

A rail-type dispenser (figure 10.1) supports CubeSats that have rails which extend the length of the CubeSat on four parallel edges. The rails on the CubeSat prevent it from

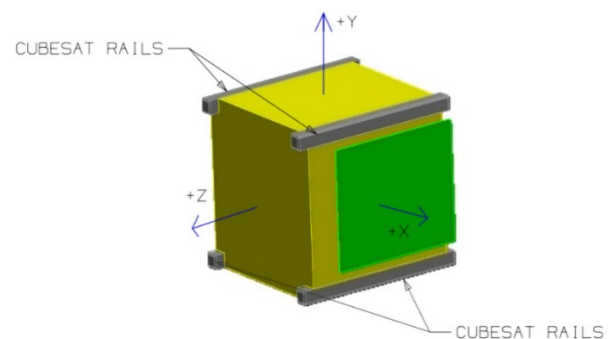
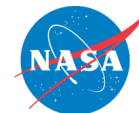


Figure 10.1: The Rail-type CubeSat. Credit: CalPoly's CubeSat Program.



rotating while inside the dispenser. After the dispenser door has been commanded to open, the rails slide along guides inside the dispenser and the CubeSat is deployed. This type of dispenser is the most widely manufactured configuration, with more than fifteen manufacturers worldwide.

A tab-type dispenser (figure 10.2) supports CubeSats with tabs which run the length of the CubeSat on two parallel edges. Typically, the dispenser grips the tabs to hold the CubeSat in place, only releasing it after the door has been commanded to open. This type of dispenser is not widely manufactured as Planetary Systems Corporation holds the patent for the design (19). There are some tab based dispensers that do not grip the tabs. Rather, they provide a slot to accommodate the tab, which slides freely within the slot.

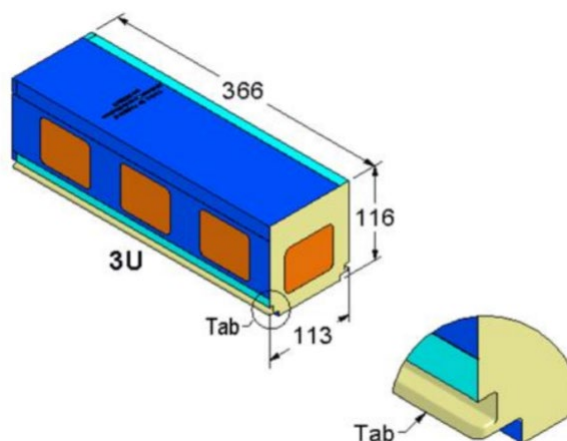


Figure 10.2: The Tab-type CubeSat. Credit: Planetary Systems Corporation.

The choice of dispenser is not always a decision made by the CubeSat. In many cases, the launch vehicle provider or launch aggregator/integrator has already determined which dispensers will be installed on the launch vehicle. As each dispenser manufacturer has slightly different volumes and requirements, it is beneficial for the CubeSat to design for as wide a range of dispensers as possible to maximize launch opportunities. Additionally, some dispenser manufacturers offer accommodations which may violate the Do No Harm requirements set forth by the launch vehicle or launch integrator, such as inhibits on deployables and transmitters. Therefore, it is beneficial for the CubeSat to evaluate Do No Harm recommendations from a variety of organizations, as these requirements can vary from flight to flight on the same LV based on the risk posture of the primary payload and/or the mission “owner” (7).

#### 10.4.2 SmallSat Separation Systems

Small satellites which do not meet the form factor of a CubeSat, or will not be using a CubeSat dispenser for integration to the launch vehicle, require a different separation mechanism. Separation systems for SmallSats generally follow either a circular pattern or a multi-point (3 or 4 point) pattern. Depending on the launch vehicle, separation systems may already be in place and available to secondary spacecraft.

Circular separation systems use two rings, held together by a clamping mechanism. One ring is attached to the launch vehicle and the other ring is attached to the spacecraft. Once the clamping mechanism is released, the two rings separate and are pushed apart by springs. Each ring then remains with the spacecraft or the launch vehicle. There are two primary types of clamping configurations, the motorized light bands (MLB) and Marman clamps.

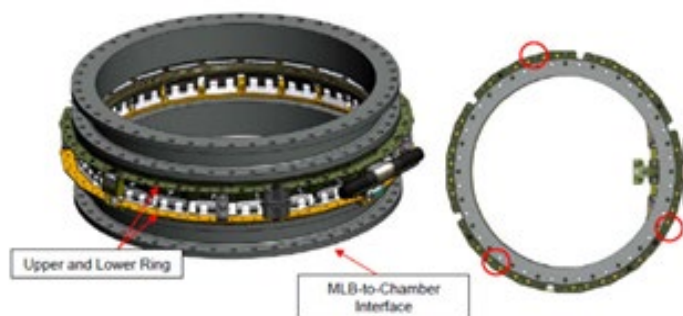


Figure 10.3: MkII Motorized Lightband. Credit: Planetary Systems Corporation.

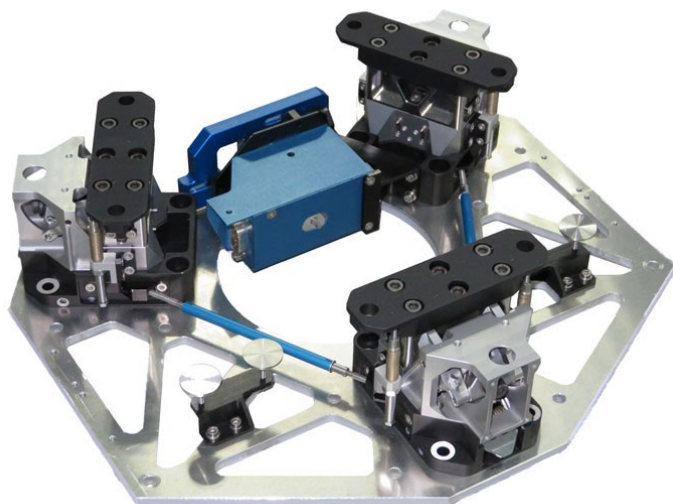
The MLB (figure 10.3) is a motorized separation system that ranges from 8 inches to 38 inches in diameter.



Smaller MLB systems are used to deploy spacecraft less than 180 kg, while larger variations may be used to separate larger spacecraft or other integration hardware such as orbital maneuvering systems, which are discussed below. The MLB's separation system eliminates the need for pyrotechnic separation, and thus deployment results in lower shock with no post-separation debris.

Marman band separation systems use energy stored in a clamp band, often along with springs, to achieve separation. The Marman band is tensioned to hold the spacecraft in place. Some Marman bands use pyrotechnic devices to cut the clamping bolt, however many companies offer a low shock release mechanism which is potentially better for the spacecraft. Sierra Nevada produces a Marman band separation system known as Qwksep, which uses a series of separation springs to help deploy the spacecraft after clamp band release. RUAG Space provides several circular separation systems which use their Clamp Band Opening Device (CBOD) release mechanism to reduce shock impact on the spacecraft (20).

Several companies are now providing multi-point separation systems instead of the circular band. Using a multi-point separation system may result in mass savings over a circular separation system. However, some systems require additional simultaneous signals from the launch vehicle provider to ensure proper release. The RUAG PSM 3/8B is a low-shock separation nut developed to fit the OneWeb satellites (21). It requires additional firing commands from the launch vehicle or a dedicated sequencing system. ISISPACE has also developed the M3S Micro Satellite Separation System, see figure 10.4, which is designed for satellites up to 100 kg but can be configured for higher masses (22).



*Figure 10.4: ISISPACE M3S Micro Satellite System.  
Credit: ISISPACE.*

### 10.4.3 Integration Hardware

A main driver for CubeSat utility is their adhesion to a standard that can be integrated into several different launch configurations. The physical hardware that attaches both a containerized and non-containerized small spacecraft and keeps it insulated from a rocket body include deployers, adapters, dispensers, and launchers. The purpose of this hardware is to eject the spacecraft safely into orbit, and most services offer different features, interfaces, connections, and designs for small spacecraft specifications. The exact configuration and standards vary by launch vehicle, and the determination of an appropriate and reliable launch option is part of the qualification launch process (39). CubeSat constellations make up an average of 50% of CubeSat launches since 2014, and the integration hardware capable of launching multiple SmallSats simultaneously and consecutively is now a standard. This section will highlight some of the existing examples of integration flight support hardware that is applicable to both SmallSats and CubeSats, and the reader is highly encouraged to identify other integration services.

### Evolved Expendable Launch Vehicle (EELV) Secondary Payload Adapter (ESPA)

The ESPA ring (figure 10.5) is a multi-payload adapter for large primary spacecraft originally developed by Moog Space and Defense Group. Six 38 cm (15") circular ports can support six auxiliary payloads up to 257 kg each. It was used for the first time on the Atlas V STP-1 mission in 2007. The ESPA Grande (figure 10.6) uses four 61 cm (24") circular ports which can carry spacecraft up to 450 kg (991 lb) (23). Although developed by Moog, several other companies now offer similar designs in different configurations.



Figure 10.5: ESPA Ring.  
Credit: Moog, Inc.



Figure 10.6: ESPA Grande Ring.  
Credit: Moog, Inc.

### Small Spacecraft Mission Service (SSMS) Dispenser

ESA has developed the Small Spacecraft Mission Service dispenser for the Vega launch vehicle (figure 10.7). This dispenser comes in a variety of different modular parts which can be configured based on the satellite launch manifest. The modularity of the dispenser provides greater flexibility for accommodating different customers (24).

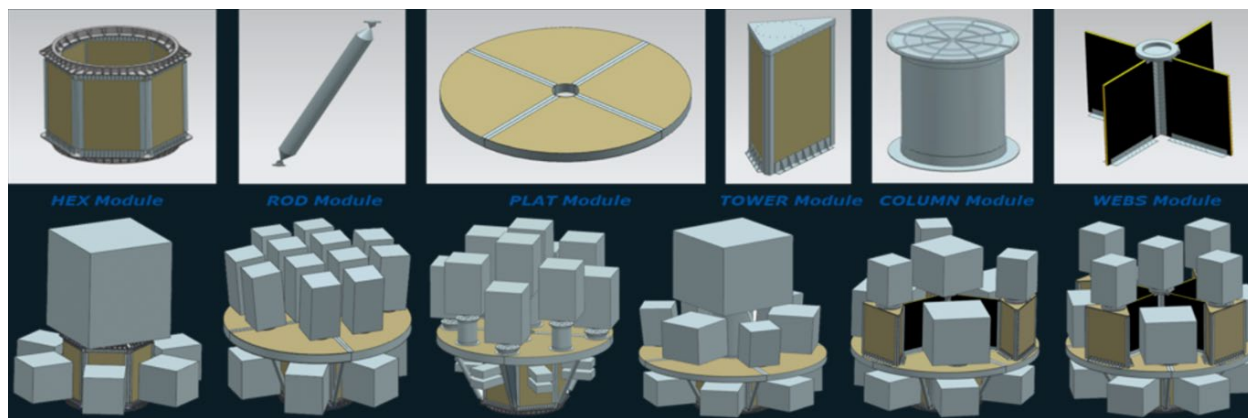


Figure 10.7: The European Space Agency Small Spacecraft Mission Service Dispenser for the Vega Launch Vehicle (24). Credit: European Space Agency.

### Dual / Multi Payload Attach Fittings (DPAF / MPAF)

Many launch vehicle providers have existing accommodations for two or more payloads which are sometimes referred to as Dual Payload Attach Fittings (DPAF) or Multi Payload Attach Fittings (MPAF). As these are generally launch vehicle specific, and occasionally mission specific, they are not discussed here.

#### 10.4.4 Orbital Maneuvering / Transfer Vehicles

One of the main disadvantages of riding as a secondary spacecraft (even on a dedicated ride-share mission) is the inability to launch into the desired orbit. The primary spacecraft determines the orbital destination, so the secondary spacecraft orbit usually does not perfectly match the customer's needs. However, by using a space tug, secondary spacecraft can maneuver much closer to their desired orbits.

##### Propulsive ESPA

The ESPA Ring, discussed above, provides the structure to which SmallSats or CubeSat dispensers are mounted. However, there are several options to add propulsion to the ESPA ring to use it as a space tug.

##### Moog OMV

Moog Space and Defense has developed the Moog Orbital Maneuvering Vehicle (OMV) line of tugs (figure 10.8) which support different mission types. COMET is the baseline OMV and it can fly with several satellites mounted to it on a multi-manifest mission. Once COMET has separated from the launch vehicle, it can maneuver to reach an orbit that is more desirable for the spacecraft mounted to it. Moog has several variations on the COMET OMV for longer duration or higher-power missions (25). Moog has also developed OMVs for launch vehicles that have spacecraft interfaces smaller than 60 inches, specifically the Minotaur Orbital Maneuvering Vehicle (M-OMV), which is packaged specifically for the Northrop Grumman Minotaur launch vehicles, and the Small Launch Orbital Maneuvering Vehicle (SL-OMV).

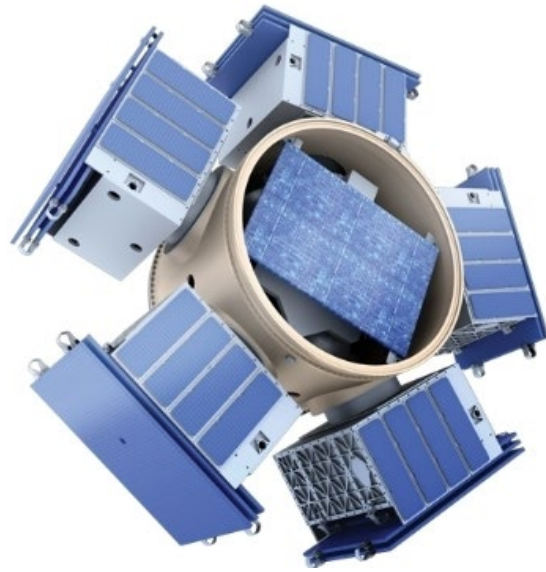


Figure 10.8: Moog OMV. Credit: Moog, Inc.

##### Northrop Grumman ESPASStar

Northrop Grumman's ESPASStar platform (figure 10.9) is similar to the Moog COMET in that it uses an ESPA ring as part of the structure. Additionally, it provides power, pointing, telemetry, command and control for the attached satellites or payloads (26). ESPASStar was developed from the ESPA Augmented Geostationary Laboratory Experiment (EAGLE), which was developed for the Air Force Research Laboratory and was launched in April 2018.



Figure 10.9: Northrop Grumman's ESPASStar Platform. Credit: Northrop Grumman.





## Spaceflight Sherpa

In addition to Moog and Northrop Grumman, Spaceflight will also offer a series of orbital transfer vehicles beginning no later than the end of 2021 (27). Spaceflight's platform, the Sherpa, is a SmallSat deployer and space tug that can host payloads. Two of the three next generation Sherpa orbital transfer vehicles are equipped with propulsion, and one is a free flyer. There is an expected launch of the Sherpa-FX2 and Sherpa-LTE1 on a SpaceX transporter-2 mission in mid-end 2021 (43).

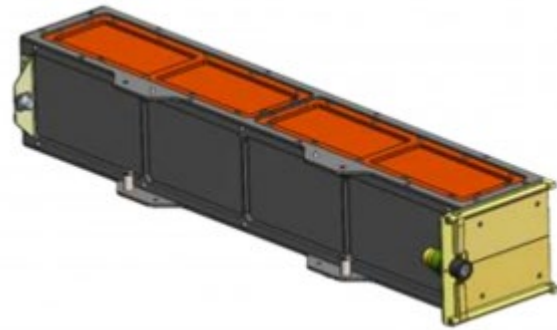


Figure 10.10: Nanoracks CubeSat Deployer.  
Credit: Nanoracks.

## ION CubeSat Carrier

D-Orbit is an Italian space company which has developed a free-flying propulsive dispenser, the ION CubeSat Carrier. This carrier can host CubeSats from 3U to 12U in size and up to a total volume of 48U. Once the dispenser has separated from the launch vehicle, it can ferry satellites around in low-Earth orbit or carry them up to medium earth orbit and release them into distinct orbital slots (28). The first launch of the ION CubeSat Carrier occurred September 3, 2020, and twelve 3U Dove CubeSats by Planet Labs were deployed from the Carrier for the first time on October 28, 2020 (41). The second mission occurred in May 2021 where the ION CubeSat Carrier deployed twenty spacecraft and performed maneuvers for the first time, with a third mission expected summer 2021 (42).

## Vigoride

Momentus Space is developing an in-space orbit transfer service for SmallSats, named Vigoride. The maximum payload mass on Vigoride is 700 kg, and it can be launched from an ESPA or ESPA Grande ring, from ISS airlocks, or a launch vehicle. It uses water plasma engines to change the orbit prior to releasing payloads at their final orbit (29). The first flight for Vigoride is planned for December 2021.

The orbital maneuvering and transfer vehicles listed here are not an exhaustive list of all those being developed, but they provide an overview of current state-of-the-art technologies and their development status. There was no intention of mentioning certain companies and omitting others based on their technologies.

## 10.5 International Space Station Options

The International Space Station (ISS) provides several methods for deploying CubeSats and SmallSats. The sections below discuss SmallSat deployment from the ISS as well as deployment above the ISS. The ISS also accommodates hosted payloads for experiments, but those accommodations are outside the scope of this chapter as they are for individual payloads themselves and are not satellites.

### 10.5.1 Deployment from ISS

The ISS also provides several options for deploying satellites. Generally, the satellites are launched below the ISS to avoid potential contact with the ISS. Below are several options available for launching from the ISS.

#### Nanoracks ISS CubeSat Deployer (NRCSD)

Nanoracks CubeSat Deployer (NRCSD) (figure 10.10) is a self-contained CubeSat dispenser system that mechanically and electrically isolates CubeSats from the ISS, cargo resupply



vehicles, and ISS crew. The NRCSD is a rectangular tube that consists of anodized aluminum plates, base plate assembly, access panels, and deployer doors. The inside walls of the NRCSD are a smooth bore design to minimize and/or preclude hang-up or jamming of CubeSat appendages during deployment, should they become released prematurely.

For deployment, the platform is moved outside via the Kibo Module's Airlock and slide table, which allows the Japanese Experimental Module Remote Manipulator System (JEMRMS) to move the dispensers to the correct orientation and provides command and control to the dispensers. Each NRCSD can hold six CubeSat units as large as a 6U (1 x 6U). The NRCSD DoubleWide can accommodate CubeSats up to 12U (2 x 6U) with Nanoracks being able to launch up to 48U per cycle. The CubeSats deploy at a 51.6° inclination, 400 – 415 km orbit 1 to 3 months after berthing at the station. Nanoracks completed its 20<sup>th</sup> mission as of June 30, 2020 (28).

### **Nanoracks ISS MicroSatellite Deployment – Kaber Deployer Program**

Nanoracks Kaber Microsat Deployer is a reusable system that provides command and control for satellite deployments into orbit from the Japanese Experimental Module Airlock Slide Table of the ISS. The Kaber supports satellites with a form factor of up to 24U and mass of 82 kg and uses a Nanoracks separation system with circular interface similar to the separation systems discussed above. Satellites are launched to the ISS on a pressurized launch vehicle, mounted to the Kaber deployer, and deployed outside the ISS (31).

### **JEM Small Satellite Orbital Deployer (J-SSOD)**

The Japanese Experimental Module (JEM) Small Satellite Orbital Deployer (J-SSOD) is a Japanese Aerospace Exploration Agency (JAXA) developed CubeSat deployer used to launch CubeSats from the ISS. The J-SSOD can launch CubeSats up to the 6U form factor (2x3 configuration). The satellites, with their dispensers, are installed on the Multi-Purpose Experiment Platform prior to Kibo's robotic arm Japanese Experiment Module Remote Manipulator System (JEMRMS) transferring the Multi-Purpose Experiment Platform (MPEP) to the release location. At that point, the CubeSats are deployed (32).

### **Bishop Nanoracks Airlock Module**

A new airlock module, Bishop, was developed for the ISS by Nanoracks, Thales Alenia Space, and Boeing, and is the first commercialized, private module for the space station (37). Bishop provides more than five times the volume of the current Japanese Experimental Module (JEM) airlock, allowing for larger satellites and payload experiments. Bishop can host satellites and payloads, as well as deploy them, based on the needs of the mission. It has been attached to the exterior of the ISS since December 21, 2020 and is expected to be operational in 2021 (40).

## **10.5.2 Deployment Above ISS**

Regular access to the ISS is very attractive for many satellite providers. However, the lower altitude of the ISS means the in-orbit lifetime for the satellite is generally shorter. This section discusses the options that have been developed to deploy CubeSats above the ISS using a cargo resupply module.

### **Nanoracks External CubeSat Deployer (ENRCSD)**

The ENRCSD is a system to deploy CubeSats into orbit above the ISS by using the Northrop Grumman Cygnus ISS Cargo Resupply vehicle. The first mission to use the ENRCSD was on the OA-6 mission in March 2016. Up to 36U of CubeSats in the 1U to 6U linear form factor may be deployed above the ISS with each Cygnus mission. CubeSats are installed in the Nanoracks deployer and mounted externally to the Cygnus vehicle before launch. They remain external to the ISS for the duration of time that Cygnus is attached to the station. The deployment altitude is



dependent upon the propellant margins remaining in the Cygnus but is and guaranteed to be between 25-500 km above the ISS altitude (33).

### **SEOPS SlingShot**

SEOPS SlingShot is a system to deploy CubeSats into orbit above the ISS using the Northrop Grumman Cygnus ISS Cargo Resupply vehicle. The first mission to use the SlingShot was in 2019. SlingShot can fly up to 72U of CubeSats per Cygnus mission; the largest CubeSat form factor it can fly is 12U. This deployment method differs from the ENRCSD in that the satellites and their dispensers are flown to the ISS as pressurized cargo on a resupply mission. Astronauts remove the satellites and install the dispensers onto the Cygnus Passive Common Berthing Mechanism (PCBM) just prior to Cygnus' departure from the station. Once Cygnus departs the ISS, it raises to an altitude of approximately 500 km and deploys the CubeSats (34). As these CubeSats are hosted in a different location and manner than the ENRCSD CubeSats, it is possible for Cygnus to carry CubeSats in both locations on a single mission.

## **10.6 On the Horizon**

### **10.6.1 Integration**

From a launch broker perspective, there are some companies hoping to develop an online booking system for launches, similar to web-based airline ticket platforms. One of these companies is Precious Payload (35). The premise is that you click on your preferred destination and timeline and the website provides you with launch options. As the supply of launches increases, there may be a larger increase in demand for this type of service.

### **10.6.2 Launch**

As discussed in the launch section above, there are always several new launch vehicles in development. The number continues to grow every year and how many become realized remains to be seen.

### **10.6.3 Deployment**

There are several emerging capabilities in the area of SmallSat deployment. They consist of CubeSat dispensers, SmallSat separation systems, and orbital maneuvering and transfer vehicles. The technologies listed below are not a comprehensive list, but simply highlight two of the more unique forthcoming capabilities.

## **10.7 Summary**

A wide variety of integration and deployment systems exist to provide access to space for small spacecraft. While leveraging excess LV performance will continue to be profitable into the future, dedicated launch vehicles and new integration systems for small spacecraft are becoming popular. Dedicated launch vehicles take advantage of rapid integration and mission design flexibility, enabling small spacecraft to dictate mission parameters. New integration systems will greatly increase the mission envelope of small spacecraft riding as secondary spacecraft. Advanced systems may be used to host secondary spacecraft in-orbit, to increase mission lifetime, expand mission capabilities, and enable orbit maneuvering. In the future, these technologies may yield exciting advances in space capabilities.

The previous few years have shown an increase in the number of available launch vehicles dedicated to small spacecraft. Additionally, the CubeSat Design Specification (CDS) has been revised to include the nanosatellite classification to 12U (38), which has led to the design of dispensers that can be accommodated on a variety of launch vehicles. Regardless of the evolution of the CDS, the dispenser and bus market is symbiotic and seems to be expanding.



For feedback solicitation, please email: [arc-sst-soa@mail.nasa.gov](mailto:arc-sst-soa@mail.nasa.gov). Please include a business email.

## References

- (1) Bryce Space and Technology. Smallsats by the Numbers 2020. [Online] [https://brycetek.com/reports/report-documents/Bryce\\_Smallsats\\_2020.pdf](https://brycetek.com/reports/report-documents/Bryce_Smallsats_2020.pdf).
- (2) ISS National Laboratory. Investment Perspectives: Charts and Thoughts from SmallSat Symposium 2020. [Online] <https://www.issnationallab.org/blog/investment-perspectives-charts-thoughts-2020smallsat-symposium/>.
- (3) AIAA. AIAA R-099-2001. *Recommended Practice Space Launch Integration*. Reston, VA, USA : American Institute of Aeronautics and Astronautics, 2001.
- (4) Sims, Eleni M and Braun, Barbara M. Navigating the Policy Compliance Roadmap for Small Satellites. s.l. : The Aerospace Corporation, November 2017.
- (5) Department of Defense. *DoD Instruction 3100.11: Management of Laser Illumination of Objects in Space*. 2016.
- (6) California Polytechnic State University, San Luis Obispo (Cal Poly) CubeSat Systems Engineer Lab. CubeSat 101 Basic Concepts and Processes for First-Time CubeSat Developers. s.l. : NASA CubeSat Launch Initiative, October 2017.
- (7) Read, Andrew, et al. Rideshare Mission Assurance and the Do No Harm Process. s.l. : The Aerospace Corporation, February 28, 2019.
- (8) Kenitzer, Stephanie. *Three, Two, One .... Liftoff - GSA Adds Commercial Space Launch Integration Services to Schedules*. [Online] March 30, 2016. <https://interact.gsa.gov/blog/three-two-one-%E2%80%A6-liftoff-gsa-adds-commercial-space-launch-integration-services-schedules>.
- (9) US General Services Administration. GSA Professional Services Schedule Space Launch Integrated Services (SLIS) Implementation Guide. March 16, 2016.
- (10) Puteaux, Maxime and Najjar, Alexandre. Analysis | Are smallsats entering the maturity stage? *SpaceNews*. [Online] August 6, 2019. <https://spacenews.com/analysis-are-smallsats-entering-the-maturity-stage/>.
- (11) Werner, Debra. How many small launch vehicles are being developed? Too many to track! *SpaceNews*. [Online] October 24, 2019. <https://spacenews.com/carlos-launch-vehicle-update-iac/>.
- (12) Hill, Denise. The CubeSat Launch Initiative Celebrates its 100th CubeSat Mission Deployment. [Online] February 19, 2020. <https://www.nasa.gov/feature/the-cubesat-launch-initiative-celebrates-its-100th-cubesat-mission-deployment>.
- (13) New CubeSat Missions Selected for the Third Cycle of Fly Your Satellite. [Online] 02 03, 2020. [https://www.esa.int/Education/CubeSats\\_-\\_Fly\\_Your\\_Satellite/New\\_CubeSat\\_missions\\_selected\\_for\\_the\\_third\\_cycle\\_of\\_Fly\\_Your\\_Satellite](https://www.esa.int/Education/CubeSats_-_Fly_Your_Satellite/New_CubeSat_missions_selected_for_the_third_cycle_of_Fly_Your_Satellite).
- (14) Erwin, Sandra. Air Force cubesat successful deployed from Atlas 5 upper stage. *Spacenews*. [Online] 08 08, 2019. <https://spacenews.com/air-force-cubesat-successfully-deployed-from-atlas-5-upper-stage/>.
- (15) *Behind the US's largest Rideshare Launch: Spaceflight's SSO-A*. Roberts, Jeffrey and Hadaller, Adam. Logan, UT : s.n., 2019. SmallSat. p. 10.



- (16) Atkinson, Ian.: "SpaceX Successfully Launches Sixth Starlink Launch Despite Engine Issue." *NASA Spaceflight*. [Online] March 18, 2020. <https://www.nasaspacesflight.com/2020/03/spacex-sixth-starlink-fifth-booster-reflight/>.
- (17) Wattles, Jackie: "The race for space-based broadband: OneWeb launches 34 more internet satellites." *CNN Business*. [Online] February 6, 2020. <https://www.cnn.com/2020/02/06/tech/oneweb-satellite-internet-launch-scn/index.html>.
- (18) Henry, Caleb: "Soyuz Launches 34 Oneweb Satellites." *SpaceNews*. [Online] March 21, 2020. <https://spacenews.com/soyuz-launches-34-oneweb-satellites/>.
- (19) Holemans, Walter and Hevner, Ryan: "*Canisterized Satellite Dispenser*." 9,415,883 B2 United States of America, 2016.
- (20) RUAG. Payload Adapter Systems for EELV. [Online] [https://www.ruag.com/sites/default/files/2016-11/payload\\_adapter\\_system\\_for\\_EELV.pdf](https://www.ruag.com/sites/default/files/2016-11/payload_adapter_system_for_EELV.pdf).
- (21) RUAG. Separation Nut PSM 3/8B. [Online] [https://www.ruag.com/sites/default/files/media\\_document/2019-03/Separation%20Nut%20PSM%2038B.pdf](https://www.ruag.com/sites/default/files/media_document/2019-03/Separation%20Nut%20PSM%2038B.pdf).
- (22) ISIS. M3S Micro Satellite Separation System. [Online] [https://www.isispace.nl/wp-content/uploads/2018/09/M3S\\_Flyer.pdf](https://www.isispace.nl/wp-content/uploads/2018/09/M3S_Flyer.pdf).
- (23) Moog. ESPA Overview. [Online] <https://www.csaengineering.com/products-services/esp.html>.
- (24) European Space Agency. SSMS modular parts. [Online] [https://www.esa.int/ESA\\_Multimedia/Images/2019/06/SSMS\\_modular\\_parts#.XuOX3YQCe7o](https://www.esa.int/ESA_Multimedia/Images/2019/06/SSMS_modular_parts#.XuOX3YQCe7o).link.
- (25) Moog. The Orbital Maneuvering Vehicle. [Online] <https://www.moog.com/markets/space/omv.html>.
- (26) Messier, Doug. Orbital ATK Awarded USAF Contract for Long-Duration Propulsion ESPA Spacecraft. *Parabolic Arc*. [Online] December 12, 2017. <http://www.parabolicarc.com/2017/12/12/orbital-atk-awarded/>.
- (27) Henry, Caleb: "Spaceflight Planning Three Sherpa Launches in 2021." *Spacenews.com*. [Online] Aug. 20, 2020. <https://spacenews.com/spaceflight-planning-three-sherpa-launches-in-2021/>.
- (28) D-Orbit. D-Orbit About Us. [Online] <https://www.dorbit.space/about-us>.
- (29) Momentus. Vigoride User's Guide V1.0. [Online] February 23, 2020. <https://momentus.space/site/wp-content/uploads/2020/02/Momentus-Vigoride-Users-Guide.pdf>.
- (30) Nanoracks. ISS CubeSat Deployment. [Online] <https://nanoracks.com/products/iss-cubesat-deployment/>.
- (31) Nanoracks. Kaber Nanoracks ISS Microsatellite Deployment System. [Online] <https://nanoracks.com/wp-content/uploads/NRMSD-overview.pdf>.
- (32) JAXA. JEM Small Satellite Orbital Deployer (J-SSOD). [Online] <https://iss.jaxa.jp/en/kiboexp/jssod/>.
- (33) Nanoracks. External Cygnus Deployment. [Online] <https://nanoracks.com/products/external-cygnus-deployment/>.



- (34) NASA. SlingShot. [Online] [https://www.nasa.gov/mission\\_pages/station/research/experiments/explorer/Facility.html?#id=7847](https://www.nasa.gov/mission_pages/station/research/experiments/explorer/Facility.html?#id=7847).
- (35) Foust, Jeff: "Options Grow For Smallsats Seeking Secondary Payload Opportunities." *SpaceNews*. [Online] August 17, 2017. <https://spacenews.com/options-grow-for-smallsats-seeking-secondary-payload-opportunities/>.
- (36) Xtenti. FANTM-RiDE Features. [Online] [http://www.fantm-ride.com/news\\_features/news\\_features.html](http://www.fantm-ride.com/news_features/news_features.html).
- (37) Natario, Nick: "Commercial Space Companies In Houston Looking Forward To SpaceX Launch." *ABC13 Eyewitness News*. [Online] May 26, 2020. <https://abc13.com/society/commercial-space-companies-looking-forward-to-spacex-launch-/6213469/>.
- (38) The CubeSat Program, Cal Poly SLO. CubeSat Design Specification (CDS) Rev 14. San Luis Obispo, California : s.n., July 14, 2020.
- (39) E. S. Nightingale, L. M. Pratt, A. Balakrishnan: "The CubeSat Ecosystem: Examining the Launch Niche(Paper and Presentation)". IDA Science and Technology Policy Institute. December 2015.
- (40) A. Thompson: "The International Space Station is now home to the world's 1st commercial airlock". December 23, 2020. Accessed July 9, 2021. URL: <https://www.space.com/nanoracks-bishop-airlock-installed-space-station>
- (41) D. Werner: "D-Orbit Satellite Carrier delivers Planet SuperDoves to desired orbits" October 28, 2020. Accessed July 9, 2021. URL: <https://spacenews.com/d-orbit-demonstrates-ion/>
- (42) D. Werner: "D-Orbit unveils third mission for ION Satellite Carrier" June 1, 2021. Accessed: July 9, 2021. URL: <https://spacenews.com/d-orbit-wild-ride/>
- (43) J. Sorensen, Spaceflight Industries: " Spaceflight Inc.'s Next-Gen Sherpa OTV Program Showcases Innovative Modular Design of its Flight-Proven Subsystems", June 7, 2021. Accessed: July 9, 2021. URL: <https://spaceflight.com/spaceflight-inc-s-next-gen-sherpa-otv-program-showcases-innovative-modular-design-of-its-flight-proven-subsystems/>



## Chapter Contents

Chapter Glossary .....	ii
11.0 Ground Data Systems & Mission Operations .....	267
11.1 Introduction .....	267
11.2 Ground Systems Architecture .....	268
11.3 Frequency Considerations .....	268
11.3.1 Frequency Licensing .....	270
11.4 Cybersecurity .....	270
11.4.1 Cybersecurity Integration .....	271
11.5 Ground Stations and Networks .....	273
11.5.1 Types of Ground Services .....	273
11.5.2 Ground Station Hardware, Software and Operation .....	274
11.5.3 RF Link Budget .....	276
11.5.4 Ground Networks .....	277
11.5.5 Space Relay Networks .....	278
11.5.6 Buying Ground Services vs. Building a Ground System .....	279
11.6 Mission and Science Operations Centers .....	280
11.6.1 Software for Mission Operations .....	282
11.7 End-to-End Communications and Compatibility Testing .....	284
11.8 Spacecraft Commissioning .....	285
11.9 State-of-the-Art – Ground Data Systems .....	286
11.9.1 Direct-to-Earth Ground Service Providers .....	286
11.9.2 Space Relay Network Service Providers .....	299
11.9.3 End-to-End Hardware for Ground Systems .....	302
11.9.4 Component Hardware for Ground Systems .....	307
11.9.5 Ground Software .....	312
11.9.6 Mission Operations & Scheduling Software .....	316
11.10 On the Horizon .....	320
11.10.1 Optical Communications .....	320
11.10.2 Phased Array Ground Stations .....	326
11.11 Summary .....	330
References .....	331



## Chapter Glossary

(API)	Application Programming Interface
(ASGS)	ASRF SmallSat Ground Station
(ASRF)	Atmospheric Sciences Research Facility
(AWS)	Amazon Web Services
(C-STIS)	Celestia Satellite Test & Simulation BV
(C2)	Command & Control
(CCSDS)	Consultative Committee for Space Data Systems
(CDMA)	Code Division Multiple Access
(CPAW)	Collection Planning and Analysis Workstation
(CRC)	Cooperative Centre
(CS)	Commercial Services
(DIU)	Department of Defense's Defense Innovation Unit
(DLR)	German Aerospace Center
(DSN)	Deep Space Network
(DSOC)	Deep Space Optical Communications
(DSS-17)	Deep Space Station-17
(DTE)	Direct-to-Earth
(DVB-S2)	Digital Video Broadcast Satellite Second Generation
(EDUs)	Engineering Development Units
(EGSE)	Electrical Ground Support Equipment
(EIRP)	Effective Isotropic Radiated Power
(ESA)	European Space Agency
(FCC)	Federal Communications Commission
(FDMA)	Frequency Division Multiple Access
(FEP)	Front End Processors
(FFRDCs)	Federally Funded Research and Development Centers
(GBESA)	Ground-Based Electrically-Steered Array
(GBPA)	Ground-Based Phase Array
(GEO)	Geosynchronous Equatorial Orbit
(GNSS)	Global navigation satellite system
(GPS)	Global Positioning System
(GSE)	Global Satellite Engineering





(GSFC)	Goddard Space Flight Center
(HEO)	Highly Elliptical Orbit
(HF)	High frequency
(I&T)	Integration and Test
(IARU)	International Amateur Radio Union
(IDL)	Interactive Data Language
(IMEI)	International Mobile Equipment Identity
(INCOSE)	International Council on Systems Engineering
(INNOVA)	IN-orbit and Networked Optical Ground Stations Experimental Verification Advanced Testbed
(ISO)	International Organization for Standardization
(ISS)	International Space Station
(ITOS)	Integrated Test and Operations System
(ITU)	International Telecommunications Union
(JPL)	Jet Propulsion Laboratory
(KSAT)	Kongsberg Satellite Services AS
(KSC)	Kennedy Space Center
(LADEE)	Lunar Atmosphere and Dust Experiment Explorer
(LCRD)	Laser Communications Relay Demonstration
(LDT)	Lowell Discovery Telescope
(LEOP)	Launch and Early Orbit Phase
(LLCD)	Lunar Laser Communications Demonstration
(LNA)	Low-Noise Amplifier
(MCS)	Mission Control Software
(MEO)	Medium Earth Orbits
(MOC)	Mission Operations Center
(MSFC)	Marshall Space Flight Center
(MSPA)	Multiple Spacecraft Per Aperture
(NEN)	Near Earth Network
(NICT)	National Institute of Information and Communications Technology
(NIMO)	Networks Integration Management Office
(NIST)	National Institute of Standards and Technology
(NORAD)	North American Aerospace Defense Command
(NTIA)	National Telecommunications and Information Administration



(OCTL)	Optical Communications Telescope Laboratory
(OGS)	Optical ground stations
(PNT)	Position Navigation and Timing
(PPM)	Pulse Position Modulation
(PPP)	Public-Private Partnership
(PPS)	Precise Positioning System
(R&D)	Research and Development
(RF)	Radio Frequency
(SA)	Single Access
(SDR)	Software Defined Radio
(SETH)	Science Enabling Technology for Heliophysics
(SFCG)	Space Frequency Coordination Group
(SMA)	S-band multiple access
(SN)	Space Network
(SNSPD)	Superconducting Nanowire Single Photon Detector
(SOC)	Science Operations Center
(SPD-5)	Space Policy Directive 5
(SSBV)	Satellite Services B.V.
(SSC)	Swedish Space Corporation
(SWaP)	Size, Weight, and Power
(TDMA)	Time-Division Multiple Access
(TDRS)	Tracking and Data Relay Satellites
(TDRSS)	Tracking and Data Relay Satellite System
(TLE)	Two-Line Element set
(TNC)	Terminal Node Controller
(TNO)	The Netherlands Organization
(TOGS)	Transportable Optical Ground Station
(TT&C)	Telemetry, Tracking and Control
(UHF)	Ultra High Frequency
(USRP)	Universal Software Radio Peripheral
(VHF)	Very high frequency
(VICTS)	Variable Inclination Continuous Transverse Stub
(VMs)	Virtual Machines
(WFF)	Wallops Flight Facility



## 11.0 Ground Data Systems & Mission Operations

### 11.1 Introduction

A typical mission is comprised of three operational components: space, ground, and user segments, as illustrated in figure 11.1.

The space segment consists of the payload and spacecraft bus system and relies on its ability to maintain operational stability to receive and transmit information. The ground segment includes all the ground-based elements that are used to collect and disseminate information from the satellite to the user. The primary elements of a ground system are summarized in table 11-1.

All small satellites use some form of a ground segment to communicate with the spacecraft, whether it be handheld radios using an amateur frequency, or a large dish pulling down data on a non-federal or federal frequency.

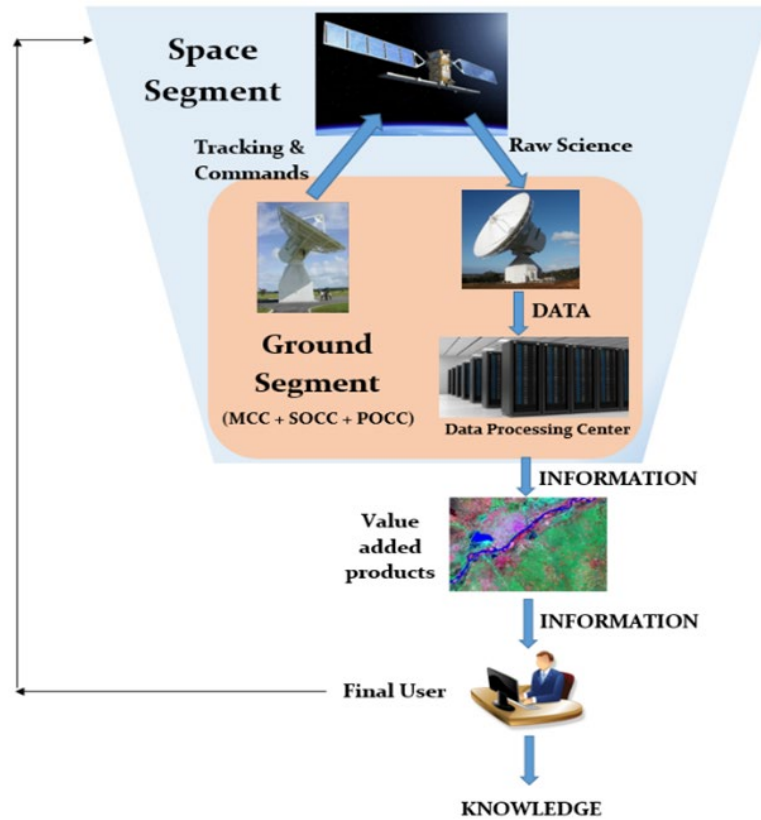
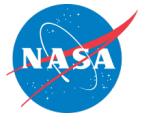


Figure 11.1: Functional relationship between the space segment, ground segment and final user for a small satellite mission. Credit: NASA.

Table 11-1: Primary Elements of a Ground System	
Element	Function
Ground Stations	Telemetry, tracking, and command interface with the spacecraft
Ground Networks	Connection between multiple ground elements
Control Centers	Management of the spacecraft operations
Remote Terminals	User interface to retrieve transmitted information for additional processing

The ground segment design can depend on several factors which may include, but are not limited, to the following:

- Data volume to satisfy mission requirements
- Location of the ground assets relative to mission orbit parameters
- Budget limitations



- Distribution of the team
- Affiliation of who controls the spacecraft (federal vs. non-federal users)
- Regulatory requirements

The ground system is responsible for collecting and distributing the most valuable asset of the mission: the data. Using the proper ground system is key to mission success. The sections to follow will discuss elements of the ground system in more detail, provide a snapshot of current ground system technologies, and touch on new technologies that can provide future advancement. The author would like to highlight that the presented tables are not intended to be exhaustive but to provide an overview of current state-of-the-art technologies and their development status. There was no intention of mentioning certain companies and omitting others based on their technologies.

## 11.2 Ground Systems Architecture

A typical small satellite mission has the following elements within the ground system architecture:

- Spacecraft Terminal: Transceiver (optical, radio frequency (RF) or other) on the spacecraft to transmit and receive information, including related hardware such as antennas
- Ground Station Terminal: Transmitter and receiver or transceiver (optical, RF or other) at the ground station to transmit and receive information, including related hardware such as antennas
- Mission Operations Center (MOC):
  - Commands the spacecraft
  - Monitors spacecraft performance
  - Requests and retrieves data as necessary
- Science Operations Center (SOC):
  - Generates and disseminates science data products
  - Determines science operations to be relayed to the MOC
- Ground Station Data Storage and Network:
  - Provides live connectivity to a MOC for commands and telemetry
  - Temporarily stores data to be retrieved by the MOC and/or SOC

Figure 11.2 shows a generic small satellite ground architecture that uses NASA's Near Earth Network (NEN) for nominal ground passes and the NASA Space Network (SN) for low-latency messaging. In this architecture, the MOC is responsible for all communication to and from the spacecraft, while the SOC and engineering teams can work both directly through the MOC to process commands. This is especially helpful during commissioning and troubleshooting instances where the engineering team needs direct access to the flight system. This architecture also provides a separate database generated from the MOC of telemetry and housekeeping data that is accessible to stakeholders.

## 11.3 Frequency Considerations

The spacecraft transceiver and ground station need to be on a coordinated frequency to communicate. Selecting transmit and receive frequencies are a critical part of the spacecraft communications system design process. Key drivers in selecting a frequency include data volume needs, ground station availability, and the number of passes required. Frequencies are divided into different bands as shown in table 11-2.

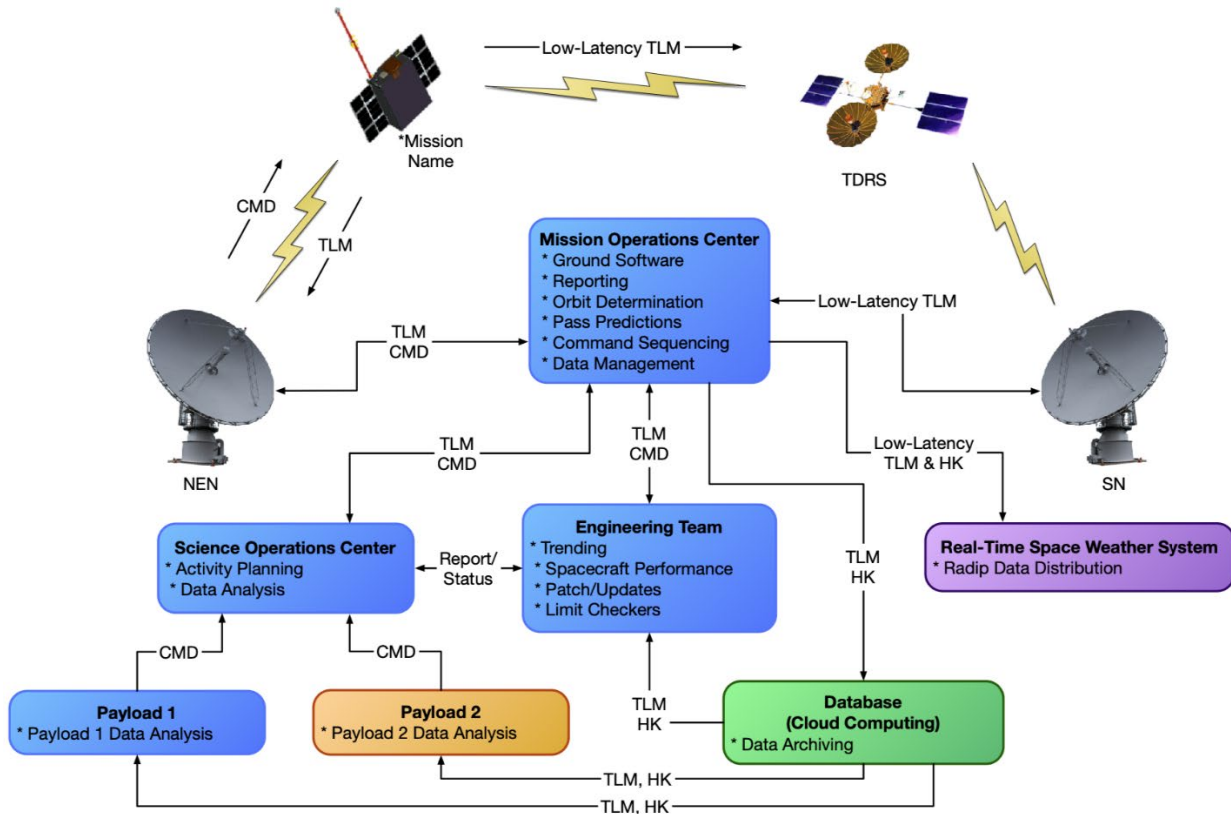


Figure 11.2: Example of a ground system architecture for a small satellite using NASA's Near Earth Network and Space Network. Credit: NASA.

Typical bands considered for small satellites are Ultra High Frequency (UHF), S, X, and Ka. UHF was the band of choice for early small satellites, but in recent years, there has been more of a shift to S and X. Ka remains on the horizon as there are current hardware limitations for small spacecraft, however, this is NASA's desired band for future small satellite missions. This shift has been driven by higher data demands and frequency control. The higher frequencies permit more data to be transmitted over a given period, but require the spacecraft and ground antennas to be more focused. UHF was appealing to early users, particularly universities, due to the lower cost of hardware for both the spacecraft and ground station, good link margins, and more omni-directional pattern capability with the spacecraft, but yields lower data rates and has a higher probability for interference as it is commonly used by local municipalities.

Band	Frequency
HF	3 to 30 MHz
VHF	30 to 300 MHz
UHF	300 to 1000 MHz
L	1 to 2 GHz
S	2 to 4 GHz
C	4 to 8 GHz
X	8 to 12 GHz
Ku	12 to 18 GHz
Ka	27 to 40 GHz
V	40 to 75 GHz
W	75 to 110 GHz
mm	110 to 300 GHz



### 11.3.1 Frequency Licensing

Satellite communication frequencies are intentionally protected. The signals from satellites in space are very weak, and if there is too much interference they cannot be heard. Within each frequency band there are government and non-government designations amongst the frequencies. Some frequencies are government use only, others are non-government only, and some are shared. Government bodies that regulate the frequency usage in the United States are the Federal Communications Commission (FCC) and the National Telecommunications and Information Administration (NTIA). Other countries may have their own national governing bodies, and all national bodies around the world must coordinate with the International Telecommunications Union (ITU), which is the governing body at the international level. The FCC is responsible for issuing communications licenses to non-government users and the NTIA handles government users. Licenses are required for both the satellite and ground station to transmit on a designated frequency or frequencies. It is becoming more common for small satellites to use multiple bands. For example, some missions have used UHF for uplink and S-band for downlink, while others have used S-band for uplink and X-band for downlink. Some of the non-government frequencies are dedicated for amateur usage.

Early university small satellites relied heavily on the use of amateur frequency bands. In recent years, there has been movement by the International Amateur Radio Union (IARU) and the FCC to significantly limit the use of amateur frequencies for small satellites. Those interested in using these frequencies are expected to first communicate their intention with the IARU and obtain a coordination letter prior to submitting an application with the FCC. It is recommended that missions with a new communication system design apply with the FCC or NTIA once an operations concept and a spacecraft design are defined, in order to verify a proper communications approach and associated hardware has been selected. Missions using a legacy communications approach can typically wait until they have been given a launch manifest. The licensing process can take several months and needs to be completed prior to launch. Some of the processing time is associated with the FCC and NTIA having to also coordinate with the ITU. Both the FCC and ITU are working to implement more streamlined small satellite licensing options. Such improvements will be necessary as constellations of small satellites become more prevalent.

### 11.4 Cybersecurity

Unauthorized access and unauthorized modifications to systems viewed as too complex for non-experts to understand, or too inaccessible, continues to be problematic across many industries. The space industry is no different and is looking closely at addressing cybersecurity challenges. Traditional cybersecurity expertise applies and can be tailored appropriately to the specifics of space systems. System engineering best practices, including attention to systems security engineering that integrates expertise in cybersecurity and other protection measures, enables a secure system to be delivered within established constraints.

Over the Summer of 2020, the US Air Force sponsored a “Hack a Sat” competition and a similar competition is expected to occur in 2021. In the 2020 “Hack a sat” competition, over a thousand teams attempted a series of structured challenges directly related to space systems. The four finalists competed to gain access to a mission operations center, leverage vulnerabilities on the spacecraft, and ultimately send a series of commands to orient the spacecraft to take an image of the Moon using the spacecraft’s optical instrument. The winning team had no prior space systems or space operations experience.



### 11.4.1 Cybersecurity Integration

Security of a space system needs to consider all aspects of the system, including the space platform, payloads, and all supporting functions. To a remote attacker, the most accessible portion of a spacecraft is the end-to-end command path as accessed through direct contact (RF link), subversion of any command path transports (space or ground networks), and subversion of the command authority (e.g., MOC). Another enticing option for an attacker is to cause a mission impact through manipulation of key space system dependencies, such as Global navigation satellite system (GNSS), ground stations, and external service or data providers. Related concerns include degrading or denying the use of the command path through jamming or denial of service of the command path and supporting functions. Finally, vulnerabilities in any system, sub-system, or component, can be exploited by an attacker in creative ways to ultimately gain the ability to affect the overall system. Supply chain risk management is needed to address some portions of these challenges.

Effective space system security efforts begin early in the lifecycle and continue through to mission termination. Early architecture and design decisions will have the most significant impact on the overall system's security outcomes and can help avoid rework in later phases. Integrating cybersecurity capabilities into a system fits well into standard system engineering practices. Many organizations are establishing a sub-discipline for systems security engineering, to serve as a focal point within the mission team to enable system security. This may overlap with or work closely with related roles such as a cybersecurity systems engineer. The International Council on Systems Engineering (INCOSE) has established a working group to support system security engineering, and NASA is actively implementing a system security engineering capability (50).

Operators need to maintain command authority over their spacecraft, preventing unauthorized access. Use of authenticated encryption, between the point where the command sequence is generated and the spacecraft, is the best method to ensure command authority and data integrity. Encryption provides confidentiality, and authentication ensures that a trusted source initiated the command. This approach generally addresses initial concerns about an attacker attempting to gain access through use or subversion of the command path to the spacecraft.

Key spacecraft external dependencies can be manipulated to cause a mission impact. Example dependencies might include the ground station and GNSS signal. Ground station impacts could disrupt data flows with the spacecraft. Jamming and measurement spoofing of GNSS signals has become common in various regions, with observed impacts in the maritime and airspace domains. Orbiting systems have detected similar effects. Space systems should be prepared to tolerate loss or interference with GNSS signals.

For the overall space system and its component parts to function properly and securely, each part must in turn be sufficiently secure. Traditional cybersecurity efforts apply well to most software and terrestrial systems. Attention to the security of each component, as well as ensuring the interplay between components is secure, will help protect the overall system. On-board security should also be considered, particularly for multi-customer and multi-payload spacecraft. Increasingly, spacecraft developers should consider that external defenses (e.g., command authentication or encryption) may be bypassed or subverted (similar to how network firewalls may be bypassed). Without further consideration, the on-board systems are likely vulnerable to further exploitation.

Supply chain risk management is an essential related discipline. Particularly for key components and software, understanding the vendor's sourcing, manufacturing approach, and cybersecurity and assurance management will help ensure any associated risk can be identified and managed. If a vendor relies on other vendors, additional scrutiny may be appropriate. Review of the sourcing may address whether the vendor is rebranding, assembling/integrating, or internally



manufacturing components, and whether there is sufficient control to deliver a trustworthy product. Reviewing the manufacturing approach, whether hardware, software, or some combination, allows the customer to determine whether the vendor uses repeatable processes that yield deterministic and trustworthy results. And understanding how the vendor addresses cybersecurity, quality, and protection topics in their components provides insight into whether or not it is appropriate to integrate the component into the overall system.

### **U.S. National Guidance and Regulations**

In September 2020, the U.S. National Space Council issued Space Policy Directive 5 (SPD-5), Cybersecurity Principles for Space Systems. Amongst other elements, the directive calls for use of “risk-based cybersecurity-informed engineering,” anticipating and adapting to evolving malicious activities, and recommending capabilities to maintain positive control of space vehicles. Another element implies that Federal agencies may issue or update guidance, rules, or regulations to adopt the principles in this directive (51).

U.S. regulatory agencies, such as the Federal Communications Commission (FCC), have considered and not yet issued rules that may require specific cybersecurity measures to be adopted. Prior proposed (and not issued) rules included requirements for encryption on the telemetry, tracking, and command communications for propulsive spacecraft.

### **U.S. Agency Guidance**

Several U.S. government agencies and their support ecosystem have made various frameworks, standards, and other guidance available to address cybersecurity and protection concerns.

### **NASA Technical Standard**

NASA requires its missions, including small satellites, to comply with NASA STD-1006 “Space System Protection Requirements.” This standard covers protection of the “command stack,” critical information, Position Navigation and Timing (PNT) sub-system resilience, and reporting detected and unexplained interference. The tailoring guidance within the standard allows for some flexibility in certain small satellite scenarios, such as non-maneuverable systems. Protecting the command stack involves use of encryption complying with FIPS 140 (level one). PNT resilience addresses the loss of or temporary interference with external PNT services, such as a GNSS (52).

### **National Institute of Standards and Technology (NIST)**

NIST has several useful publications addressing cybersecurity and system security engineering. The NIST Cybersecurity Framework is a voluntary guidance framework that can be used by organizations to manage cybersecurity risk. The framework provides a structured and tailorable approach for organizational security capabilities and includes informative references to other NIST documents (e.g., SP 800-53), as well as other standards or guidance organizations (e.g., International Organization for Standardization, ISO). NIST’s SP 800-160 Volumes I and II offer a thorough approach for system security engineering practices. In particular, SP800-160 Vol I’s Appendix F, Design Principles for Security, can be used as an effective foundation for systems security (53-55).

### **Additional Resources**

Two U.S. Federally Funded Research and Development Centers (FFRDCs), the Aerospace Corporation (56) and MITRE (57), have published guidance for space system cybersecurity. These FFRDCs are expecting to make additional recommendations widely available. Aerospace’s “Defending Spacecraft in the Cyber Domain” includes a brief survey of known cybersecurity initiatives and standards, challenges with legacy engineering approaches, emerging threats, and principles for “cyber-resilient spacecraft.” The paper also includes a section specific to small





satellites. MITRE has published a paper “Cyber Best Practices for Small Satellite” that briefly addresses cyber threats to space systems and includes a discussion on applying lessons learned from other industries to space systems.

### Consultative Committee for Space Data Systems (CCSDS)

CCSDS provides a variety of guidance documents for implementing security measures in various aspects of the mission. For an introduction to the CCSDS approach and available guidance, see CCSDS 350.7-G-2 “Security Guide for Mission Planners” that provides a perspective on approaching security in space systems (58). The CCSDS 350.0-G-3 “The Application of Security to CCSDS Protocols” informative guidance document provides an introduction and discussion on various topics, including protecting the command path (59).

## 11.5 Ground Stations and Networks

### 11.5.1 Types of Ground Services

Ground services may be either Direct-to-Earth (DTE) or space relay as illustrated in figure 11.3. DTE ground stations are located on the Earth’s surface. They provide direct point-to-point access with antennas at ground stations which are strategically located and equipped with telemetry, command, and tracking services. DTE antennas can range from simple UHF Yagi antennas to more complex high gain parabolic dish antennas used to support S, X, and Ka bands. DTE ground stations could also incorporate phased array antenna systems or equipment for optical communications. The DTE services are especially effective for missions needing frequent, short-duration contacts with high data throughput. They are also capable of handling longer latency durations due to orbital dynamics and station visibility.

Space relay services involve an intermediate satellite that communicates with a ground station on the Earth’s surface. Relay communication satellites for low-Earth orbit spacecraft can be in Geosynchronous Equatorial Orbit (GEO), about 36,000 km from Earth, or in low-Earth orbit. Relays are essential for providing communication and tracking when direct-to-ground communications are not feasible due to physical asset visibility constraints. It is common for a low-Earth orbit spacecraft to only be in a DTE ground station’s line of sight for a portion of the orbit. The addition of space-based relay assets can provide missions with full-time coverage and continuous access to communication and tracking services. They are most useful for missions that need continuous coverage, low latencies, and coverage of launch, critical events, or emergencies.

Communication with DTE ground stations can achieve much higher data rates than what is possible for space-based relays. When considering a GEO relay satellite, it can be ten times the distance from the low-Earth orbit spacecraft than the DTE ground station. With communication propagation losses being a function of the reciprocal of the distance squared, the same communications system can achieve orders of magnitude higher data rates with the DTE ground station. Achieving comparative data rates for a relay system would require a significant increase

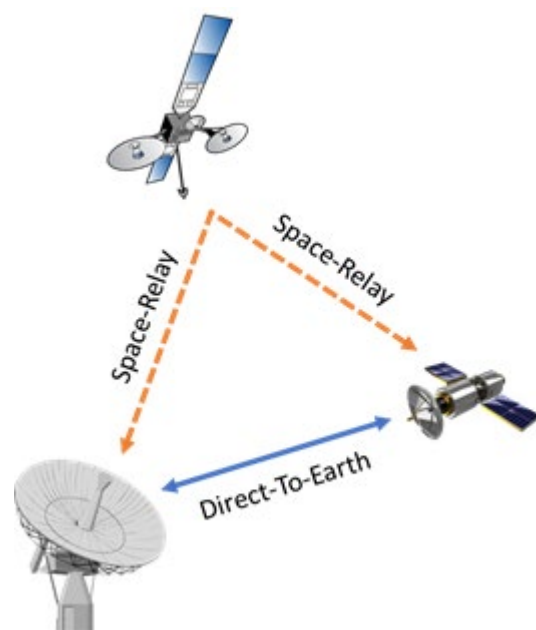


Figure 11.3: Illustration of Direct-to-Earth and Relay Concepts. Credit: NASA.

in power. The current low-Earth orbit relays have hardware limitations that permit data rates of 9.6 kbps or less, which is low relative to SmallSats being able to achieve 3 Mbps or more with DTE ground stations.

### 11.5.2 Ground Station Hardware, Software and Operation

A DTE ground station is comprised of a system of hardware and software working together to convert the RF signal from a satellite signal into digital data. The first key element of the system is the antenna. It is chosen based on the frequency and gain required to talk with a satellite. The two most common types of directional antenna are the Yagi-Uda (Yagi for short) and the parabolic reflector antenna. Dish antennas are capable of higher gain than the Yagi antennas and therefore can have a farther reach in space and achieve higher data rates.

The Yagi antennas consist of a single feed or driven element that is accompanied by parasitic elements that help reflect or transmit energy in a particular direction. The length of the feed antenna is sized relative to its resonance in the presence of parasitic elements, which are approximately a half-wavelength long at the frequency of operation. The Yagi antenna shown in figure 11.4 (left) consists of multiple parallel metal rod dipoles and is a common solution for wavelengths less than 1.5 GHz. The typical Yagi gain ranges from 6 – 20 dBi.



*Figure 11.4: (left) The California State University Northridge Yagi ground station at 437 MHz and (right) The Aerospace Corporation parabolic dish ground station in Florida at 915 MHz. Credit: California State University of California, Northridge.*

The dish antenna uses a parabolic reflector to collect signals from the spacecraft and focus them onto a feed antenna. The feed antenna is typically a horn antenna with a circular aperture. The size of a dish is at least several wavelengths in diameter at the frequency of operation and can be on the order of several 100 wavelengths for higher gains. The distance between the feed antenna and parabolic reflector can also be several wavelengths. For example, a Ka-band 34 m

deep space antenna with a feed distance of 15 m would be approximately 3,000 wavelengths for the dish diameter and 1,500 wavelengths for the feed distance relative to a 1 cm Ka-band wavelength. The gain of a dish reflector is directly related to the square of its diameter. The 1.8-meter diameter dish antenna shown in figure 11.4 (right) is used for frequencies above 915 MHz and has 19 dBi gain. Dish antennas are available in sizes from 1 meter to 70 meters in diameter.

The antenna collects RF waves and the antenna feed converts the electromagnetic waves into conducted RF electrical signals. The feed consists of a resonant pickup that is tuned to the transmit or receive frequency, a low gain low-noise amplifier, a sharp filter, and a second low noise amplifier with more gain than the first amplifier. These elements condition the signal. The signal then traverses through a coaxial cable to a nearby location where a radio demodulates the RF signal into digital data. In the uplink direction, the radio modulates the data bits onto an RF carrier which is amplified to 10 or more watts. The amplified RF resonates in the antenna feed, and the antenna amplifies the electromagnetic waves and focuses them towards the satellite.

It is desirable to have significant antenna gain, but as the gain increases, the beamwidth of the antenna decreases. There is a practical compromise where the beamwidth is so small that tracking is difficult and when the antenna gets so large that it is difficult to procure or manage. A typical antenna pattern is shown in figure 11.5. There is a center lobe where most of the transmitted energy is contained. The remaining energy is stored in the sidelobes on either side of the main lobe. The diminished side lobes are intentional so that ground noise from other emitters on Earth are not collected when receiving and so that interference to terrestrial systems is not created when transmitting. The blue arrows in the figure indicate the full-width-half-max gain point at about  $\pm 6^\circ$ , which should result in an antenna pointing error of less than  $6^\circ$  and the full-width-half-max gain of 16 dBi to be used in a link budget. If more gain is needed, then the antenna will increase in size and the beamwidth will correspondingly decrease.

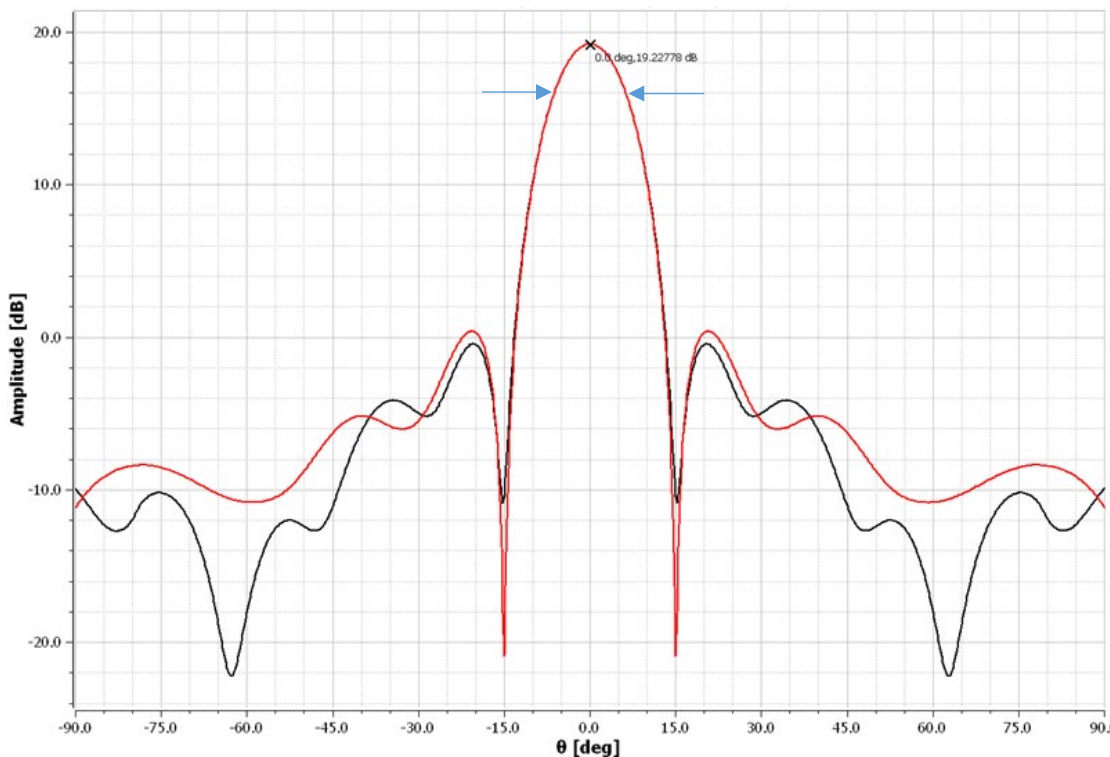


Figure 11.5: Antenna pattern from a 1.8-meter diameter parabolic dish operating at 915 MHz with a high gain center lobe and diminished side lobes. Credit: NASA.

Directional antennas point towards the satellite as it moves over the ground station. Pointing adjustments are necessary in both the vertical (elevation) and horizontal (azimuth) directions. These movements are accomplished using motors and gears. Tracking software is used to predict the satellite's future location. The satellite position and time are processed through additional software that converts this information into commands for the motor controller. Time is an important factor and Global Positioning System (GPS) time is used by the computer generating the satellite position estimate. A dedicated GPS receiver is connected to the computer for that purpose.

The cost of a DTE ground station is directly correlated with the size of the aperture, which drives the ground station foundation, pedestal, motors, and gears. The Yagi is less expensive. It sustains low wind loads and therefore can use a smaller foundation for support. In contrast, the dish antenna reflector sustains comparatively high wind loading and therefore needs a stronger concrete foundation and larger motors and gear box elements than the Yagi antenna.

### 11.5.3 RF Link Budget

Calculating the RF link budget is the first step when designing a telecommunications system. It is a theoretical calculation of the end-to-end performance of the communications link and it will determine the system margin. Maintaining a 6 dB link margin is desirable, however a 3 dB link margin is adequate for a satellite in low-Earth orbit at a slant range of 1,500 km. When considering deep space communication, a 3 dB link margin is desired, but for distant spacecraft, such as New Horizons at 7 billion kilometers from Earth, 1 dB or less margin may be all that is practically possible. The budget calculation adds and subtracts all the power gains and losses that a communication signal will experience within the system. Factors such as uplink amplifier gain and noise, transmit antenna gain, slant angles and corresponding loss over distance, satellite transceiver noise levels and power gains, receive antenna and amplifier gains and noise, cable losses, adjacent satellite interference levels, and climate related attenuation are considered. The satellite and ground antenna gains and amplifiers are then sized to provide the necessary link margin at an acceptable data rate.



Characteristic	Value
Frequency	2200 – 2400 MHz
G/T	22.8 dB/K (clear sky & 41° elevation angle)
Polarization	RHC or LHC
Antenna Beamwidth	0.85 deg
Antenna Gain	45.8 dBi
Carrier Modulation	PM/PCM, FM/PCM, BPSK, or QPSK / OQPSK
Modulation Index	PM: 0.2 – 2.8 Radians (peak)
Carrier Data Rate (High Rate Telemetry Channel)	1 Kbps – 10 Mbps (FM/PCM) 100 bps – 20 Mbps (PM/PCM, BPSK, OQPSK) 1 Kbps – 40 Mbps (QPSK) [< 20 Mbps per channel]
Carrier Data Format	NRZ-L, M or S, Biφ-L, M or S; DM-M or S; DBP-M or S; RNRZ
Subcarrier Frequency	5 kHz – 2 MHz
Subcarrier Modulation	PSK, BPSK, PCM/PM for high BW telemetry
Subcarrier Data Rate	100 bps – 600 Kbps
Subcarrier Data Format	Passes all NRZ or Biφ or DM
Decoding	Derandomization, Viterbi and/or Reed-Solomon (Ref Para 1.3 s)

Figure 11.6: S-band Telemetry Characteristics for the WG1 Antenna at NASA Wallops Flight Facility. Credit: NASA.



The test plan for the satellite and ground segments will measure the key radio parameters identified in the link budget. The ground station antenna pattern is often not verified because it is designed such that its ideal pattern is not modified by its surroundings, i.e. high up on a mast above a building or in an open field. Established service providers can provide characteristics for the ground systems and can assist customers with link margin and coverage analysis. Figure 11.6 provides an example of S-band antenna telemetry characteristics for one of NASA's NEN stations. The antenna pattern on the satellite has less flexibility and is often modified by the nearby spacecraft structure. It is best to measure the actual satellite antenna pattern in an anechoic chamber using a satellite model.

#### 11.5.4 Ground Networks

The ground station(s), MOC, SOC, and the supporting infrastructure connecting them together, make up a ground network. As more ground stations are added, a ground network becomes larger and additional considerations are required to ensure that the MOC can communicate with each of the ground stations in the network.

Understanding how many ground stations are required to support the mission is the first step in designing a ground architecture and determining if a ground network is necessary. The number of ground stations required for a mission depends upon multiple factors, including the number of satellites, the orbit regimes and inclinations, and the data latency or data volume requirements. For example, if a satellite has an orbit that regularly crosses over the same spot on the Earth (such as the poles in a sun synchronous orbit in low-Earth orbit), that mission could be supported by a single ground station at that frequently revisited spot. However, if a satellite's orbit does not frequently revisit the same spot on the Earth (as is the case with many mid-inclination low-Earth orbits), then multiple ground stations will be required to support that mission. Similarly, if a mission requires the satellite to downlink collected data as soon as possible (i.e. low data latency requirements) or if the mission will generate a large volume of data during each orbit (e.g. many



Figure 11.7: Map of NASA's Near Earth Network Service Providers & Locations. Credit: NASA.



remote sensing missions), then more ground stations will be required to support the mission. The same applies for a mission with multiple satellites as well.

Determining the number of ground stations required for the mission will dictate the size of the ground network. Missions that require only a single ground station with a co-located MOC have a very simple ground network. Missions that require multiple, geographically-dispersed ground stations will have a larger ground network with provisions to ensure that the MOC can communicate with each of those ground stations. Figure 11.7 shows an example of a large ground network, NASA's NEN, which consists of 15 geographically-dispersed ground stations that are operated by NASA and its commercial partners.

While NASA's NEN is often reserved for NASA-funded missions, there are other ground network options that exist for non-government-funded satellite operators. One common option, especially amongst amateur operators, is to take advantage of the vast amateur network around the world. This is typically done with UHF and VHF bands at low data rates and must be coordinated with the amateur user community.

Over the last few years, several options for ground networks have also become prevalent in commercial industry. Each of these commercial ground service providers offers an array of services, including various frequency bands, serviceable orbits, and ground station locations. Scheduling and data retrieval for these networks are often done through web interfaces, and pricing plans are flexible and scalable depending upon an operator's needs. Many commercial satellite operators are choosing to buy time on these networks, rather than build their own.

### 11.5.5 Space Relay Networks

Unlike a traditional ground network that goes direct from a "client" satellite to a ground station on the ground, space relay networks consist of communication satellites that relay data from the "client" satellite down to a ground station. One of the most well-known space relay networks is NASA's Tracking and Data Relay Satellite System (TDRSS), shown in figure 11.8. TDRSS relays data from the International Space Station (ISS) and the Hubble Space Telescope to NASA ground stations around the world.

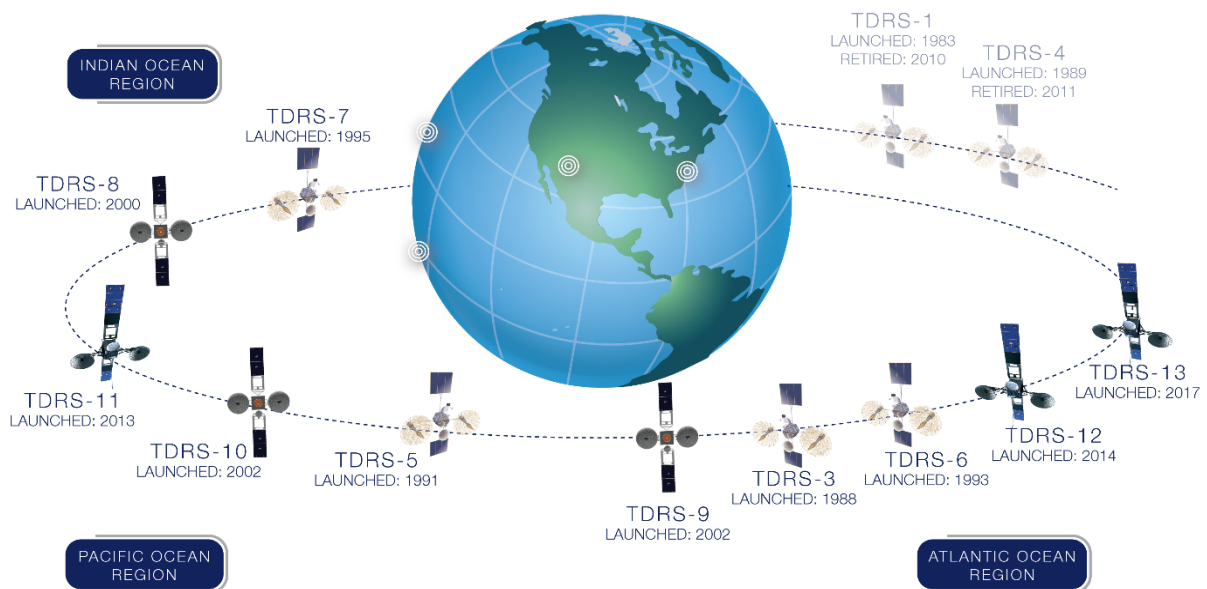


Figure 11.8: NASA's Tracking and Data Relay Satellite System. Credit: NASA.

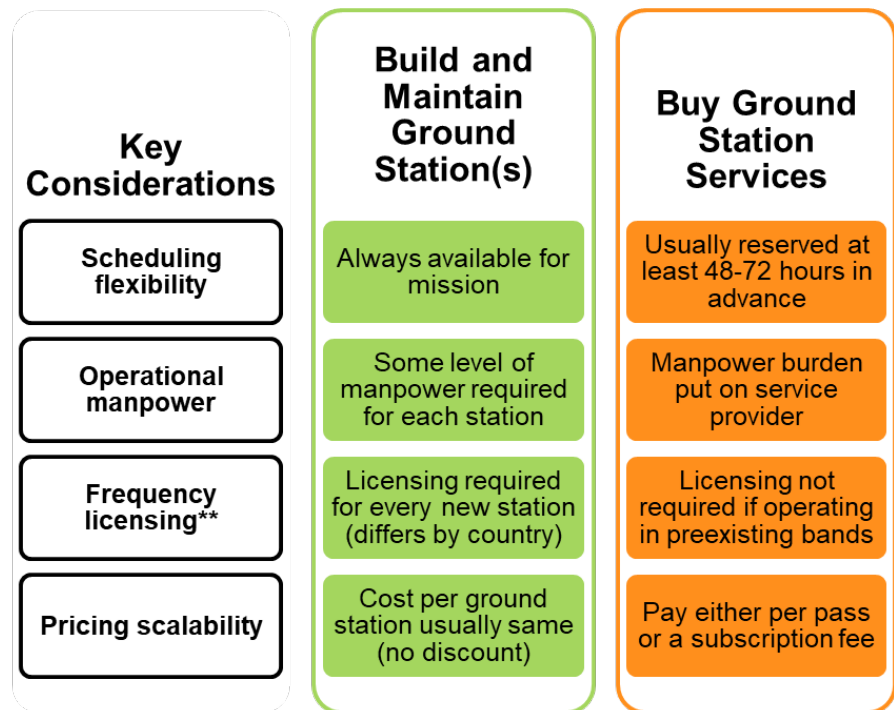


Space relay networks can be beneficial for small satellites in low-Earth orbit because those SmallSats are only in view of a ground station for a portion of their orbit. However, depending on the orbit of the relay satellites, a low-Earth orbit SmallSat could be in view of a relay satellite for most of its orbit. This makes a relay network beneficial for a SmallSat, especially right after SmallSat deployment when a ground station is still trying to locate the satellite. The space relay can transmit satellite telemetry, tracking, and control data to the ground, enabling faster satellite identification. This proves to be even more valuable when the satellite is deployed with several others for a given rideshare opportunity. This data can also contain satellite health information to give mission teams either peace of mind while awaiting acquisition by the ground station, or information for troubleshooting prior to the commissioning phase. Another benefit is the ability to obtain real-time event notifications without the need for prior scheduling. Scientists are interested in using this technology to alert the science community when certain phenomenon are observed.

Space relay networks often require special hardware or software that must be added to a satellite before launch. In general, a satellite operator will purchase a modem compatible with the relay network and fly it on their satellite to access the network. It is common for the network providers to license their proprietary chipset to developers who build the modem hardware and serve as a service broker. Because of this added hardware component, the decision to leverage a space relay network must be made before the satellite has been launched.

### 11.5.6 Buying Ground Services vs. Building a Ground System

As SmallSats have become more prevalent and prolific over the last decade, so too have ground services companies, to the point where the discussion of buying ground station services versus building and owning a ground station becomes a very relevant consideration in the ground architecture design. Key considerations would include scheduling flexibility, operational manpower, frequency licensing processes, and pricing scalability. A summary of factors relative to these considerations is shown in figure 11.9. Ultimately, the decision of whether to buy ground services versus build and own a ground station will vary depending on the mission architecture, the program budget, the potential for student learning opportunities, and many other factors.



\*\*Refers to the licensing process for the ground station, not the satellite. The satellite will still require frequency licensing regardless of the ground station used

Figure 11.9: A summary of considerations when deciding to buy service or own a ground station. Credit: NASA.



Building and owning a ground station means that the ground station is always available for the mission when the satellite is in view, allowing for maximum scheduling flexibility (it also means that there may be significant time periods where the ground station is inactive). On the other hand, most ground services companies require an operator to reserve their time on a station anywhere from 48 to 72 hours in advance of the pass, and, in the event of a conflict, mission priority-level is usually determined by the operator that has paid the highest premium.

Most ground stations require some level of effort to keep them operational, especially for routine maintenance or when an anomaly arises with the ground station itself. If the ground station is built and owned by the satellite operator, that labor burden falls to the operator. If the operator is buying time on a ground station, the ground service provider has the staffing burden.

Frequency licensing is a critical step in the ground architecture process. In addition to the satellite being licensed to transmit to the ground, any ground station must be licensed to transmit up to a satellite. When an operator buys their own ground station, they must get it licensed by the FCC (or another regulatory body/bodies if outside of the United States). If an operator buys time from a ground service provider, the licensing is performed by the service provider, and the process is usually much faster since it is an addendum to an existing license, rather than a brand new one (assuming the operator is using the same bands that the station was previously authorized to use).

Pricing scalability is also a point to consider, especially when using more than one ground station. No matter the geographic location, each new ground station must be built, licensed, tested, and maintained, and the cost for that process usually does not drop as more ground stations are built. In other words, the cost per ground station for one station or 20 stations is usually the same, and sometimes even higher due to the complexity of navigating multiple nations' licensing processes. On the other hand, ground service providers have multiple pricing scales depending on the mission need. For missions needing single ground station support, operators can pay on a per-pass basis. For missions requiring multiple ground stations, operators can pay a regular subscription fee. This variable pricing offers more flexibility for operators as their mission scales.

## **11.6 Mission and Science Operations Centers**

The MOC is where all satellite commanding is generated, ground station control is managed, and satellite telemetry is archived. It is typically a physical location where everything required to operate the satellite is located. It is often in a secure room with controlled access to protect the satellite operating equipment and prevent unauthorized satellite control. Inside the room are typically several terminals so that multiple subsystem experts can be reviewing telemetry or running their analysis programs concurrently. An example of a MOC with multiple terminals is shown in figure 11.10.

The size of the MOC is determined by the complexity of the mission. There are more experts on complex missions, and their inputs are often required during critical events or to resolve an anomaly. For a SmallSat mission, the complexity is usually lower and the MOC is a much smaller room. In addition to the terminals and telemetry analysis software are other resources for managing the satellite. These may include physical models of the satellite to study when contemplating anomalous telemetry. In the case of CubeSats, due to their small size, a functioning spacecraft engineering model may be useful to test commands and reproduce anomalies.

All tasking requests for future satellite operations are managed by the mission operations team. They will generate command plans, simulate satellite response to verify those plans, and if confidence in the simulations is not sufficient, they will run the commands on engineering model hardware prior to approving them for upload. The MOC team will also manage downloads. They will decide what data should come down next and what ground resources are available when. If



the MOC does not own its ground stations, a request for contact will be submitted to the ground station managing company. If the MOC owns its ground stations, then it will task them directly. In either case, the MOC submits data necessary for commanding the satellite for upload which includes commands and parameter settings for the payloads, a schedule of events for the flight computer, and ephemeris and pointing tables for the attitude control system along with its own timeline of events. For that same contact, the MOC will also submit commands to download specific telemetry and science data. When the contact is complete, the data will be sent back to the MOC by the ground station.



Figure 11.10: MOC at NASA Ames Research Center. Credit: NASA.

At the time of launch, the MOC will be fully populated, as this is a critical event. The satellite when it first comes online in space will likely present some anomalous telemetry that will have to be interpreted and acted upon in short order. Prior to a launch, there will be rehearsals with everyone at their stations, and simulated telemetry with anomalous readings inserted will be used to test the team. This ensures that they are ready with the proper analysis software or integration test data available to quickly diagnose the problem and propose a plan of action.

The SOC is the focal point for all mission science and data resources. The science team will use it to store and analyze the data. From that analysis, the science team generates satellite tasking requests that are sent to the mission operations team who evaluate them for feasibility and generate future satellite task plans. Negotiation is often required between the satellite operators and the scientists due to the practical limitations of the satellite and the ground segment infrastructure. External requests for additional data collection come through the science team first to assess feasibility with the instrumentation before tasking requests are made to the operations team.

The SOC is typically physically separate from the MOC. The payload for most spacecraft is produced by another company, different than the satellite bus and different from the company operating the MOC. The payload developer will have their own operations center located at their facility with easy access to supporting resources. In the past, before cloud data storage, the SOC was a physical place where data servers resided to archive the mission science data. Also,



before secure network solutions, dedicated computers were located inside the SOC that would run programs written specifically to analyze the science data. If the mission was secure and the data classified, then the physical SOC would be protected behind a locked door. Missions that do not produce classified data can take advantage of the latest technologies for considerable convenience. The SOC can be virtual instead of a physical location and the science data and special programs for analyzing data can reside in the cloud. The virtual SOC allows scientists to log on from anywhere and perform work without the need to come to a physical location and pass through secure doors. In the future, as cyber security techniques improve, it is likely that more and more secure missions will be comfortable with the virtual SOC solution and only the highest classification missions will maintain a secure physical SOC.

**11.6.1 Software for Mission Operations**

Mission operations rely on software across all the elements of the ground segment. Figure 11.11 outlines software functions for each of these elements. Software supporting the ground segment exists in the satellite, at the physical ground stations and in the MOC (server infrastructure and end-user software).

Satellite flight software not only manages state-of-health telemetry and payload data, but also software specific to the ground segment. Figure 11.12 provides an example of a command and telemetry data flow for a mission using DTE and relay services. Transmission can start autonomously by programming the satellite to know when it is

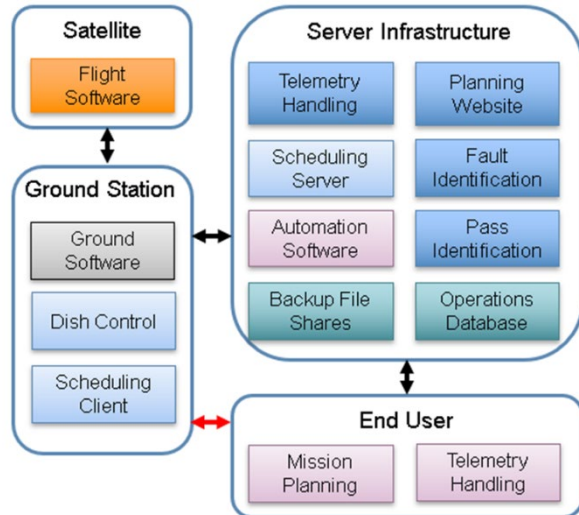


Figure 11.11: Software functions for elements within the ground segment. Credit: NASA.

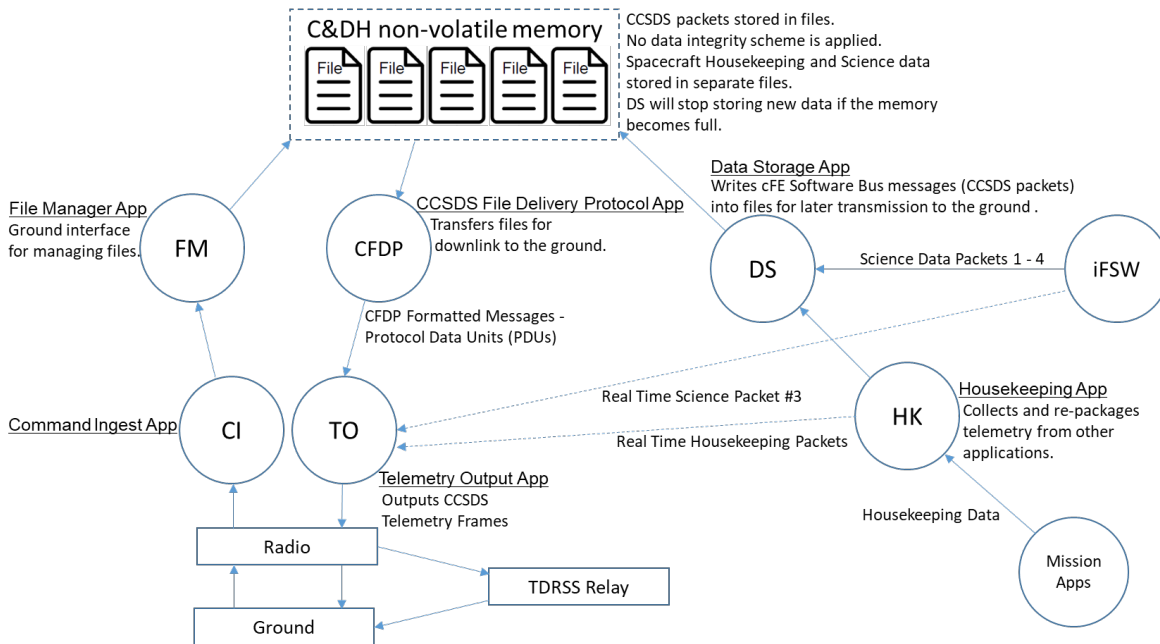


Figure 11.12: Command and telemetry data flow for a SmallSat mission using DTE and relay services. Credit: NASA.



over a ground station or within sight of a relay satellite. It can also be triggered by a command received from the ground station or relay satellite. When a communications link is established, the radio enters a higher power transmit mode and sends the data. The flight software manages the flow control of information into and out of the radio, making sure that no buffers are overflowed. It also formats the housekeeping and science data to be transmitted into a packetized file format that can be accepted by the ground station. Ground networks have specific data protocol standards developed from experience. For example, the NASA's NEN incorporates standards proposed by the CCSDS. The flight software unpacks received packets, retrieving the uploaded commands and data.

The ground station uses various software for controlling the antenna, commanding, signal formatting and encoding, scheduling passes, and interfacing with the MOC. One software computes the pointing direction by using a Two-Line Element set (TLE) to define the satellite motion, an accurate model of the pointing system mount, and GPS time. It generates motor commands as a function of time. The motor controller uses these commands to actively track the satellite during a pass. During the pass, another software suite is used to monitor the link, process and encode commands for transmission, handle any signal formatting or encryption, and demodulate and decode the received transmissions. This software also manages the network connection with the MOC over which the TLE is passed, as well as data for uploading and requests for data to be downloaded. When the contact is complete, the data received from the satellite is transferred back to the MOC. The ground station may also have its own telemetry for that contact. That data is used to trend its performance. Trending the performance of each contact provides insight and notice of degradation for both the satellite and the ground station. The ground station may also use scheduling software when handling multiple missions. This software uses orbit simulation and current TLE information to determine when the contacts are expected. It will indicate when there are conflicts between contact opportunities and can assist with schedule optimization. A schedule is generated for a given period and then programmed into the ground station control system for execution. This process can be automated, but there is typically an operator on staff to monitor the system.

For the MOC, mission planning software is necessary for missions that require complex satellite behavior such as pointing at a target during science data collection. The software will include a model of the satellite dynamics and the capability of its components. The event is planned by listing a series of actions that must occur in a certain order and are spaced out by times that are approximated. The software will simulate the satellite response and then the times and actions are iteratively adjusted as needed to optimize the plan and not cause a satellite fault condition. The output of the plan is all the commands and databases that are required by the satellite. This output is submitted to the ground station ingest software for upload at a time prior to the planned event.

A more mature MOC will include a "lights out" or fully automated option. This requires software on the ground station side to run the antenna automatically. Automation software will receive a list of times that the antenna should track the satellite and it will manage that list. It will send TLEs and data to the antenna with no one present, receive downlinked telemetry, and archive it. As the number of satellites that a MOC serves increases, the software managing the antenna becomes more capable. It can identify when two requests conflict and choose one over the other. With no one at the ground site, a feedback mechanism is required to alert the team of a satellite fault condition. For that, software is needed to automatically parse the telemetry, compare key watch items to defined limits, and alert the team via email or phone text message.

The SOC uses software to handle the receipt, unpacking, reconstruction and post processing of the mission science data. Using an ISS payload as an example, the science data is downlinked



via TDRSS to NASA Marshall Space Flight Center (MSFC) where it is separated into different science streams and piped to the correct payload SOC. At the SOC, but outside the company firewall, a computer is constantly running and ready to receive the data from MSFC. On that computer, the TReK software provided by NASA is running and it properly handshakes with the MSFC software assuring the data transfer. The science team periodically retrieves the data and safely brings it through the corporate firewall into the SOC. The science team writes parsing software to unpack the data which is stored in CCSDS format. They write another software to arrange the data back into the original image seen by the payload. Still more custom software will process the image to produce post-processed data products that are stored in the SOC archive and distributed to interested customers. The computer languages vary but Interactive Data Language (IDL) and Python are common choices for this type of software.

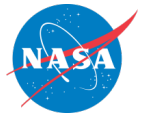
### **11.7 End-to-End Communications and Compatibility Testing**

A SmallSat undergoes various tests through its development cycle to verify proper functionality. For the communication subsystem, end-to-end communication and compatibility testing with the selected ground network is its most critical test. Compatibility testing verifies that the ground station can properly communicate with the satellite on the uplink and downlink RF channels. Ideally, compatibility would be validated by testing the flight spacecraft with the actual ground station that will be supporting the mission. This may not be practical for larger or high-cost satellites, due to logistics associated with shipping and risk of damage. Two alternatives to shipping the satellites are typically used. One includes sending a replicate set of ground station hardware to the satellite facility for testing. A second option is to test with only the flight or an ETU radio (also common to include the flight computer) at the ground station or at a test lab configured with the ground station hardware. Drawbacks to the alternative options would include not testing the exact command path or determining whether ground sensitivity is sufficient.

For CubeSats, it is commonly feasible to bring the CubeSat to the ground station for testing. If that is not feasible, then at a minimum, the radio and flight processor (or Engineering Development Units [EDUs]) should be used. Testing at the ground station allows for the entire equipment chain to be part of the test, including the low-noise amplifier (LNA) and transmit/receive switch, if used. It is desirable to first test in a closed-loop configuration, where the satellite is connected to the ground system at the antenna port via a cable (with appropriate attenuators in line). If the satellite is fully integrated, disconnecting the flight antenna may not be feasible. In this case, a small monopole antenna located indoors near the CubeSat can be connected to the ground system. The monopole antenna connection to the ground system may vary depending on the ground antenna configuration but should include as much of the ground system electronics as practical.

Some missions elect to include an outdoor open-loop test with the CubeSat and ground antenna. This method allows for the entire ground system, including the ground antenna, to be included in the test. However, the ground antenna typically cannot point directly at the CubeSat due to mechanical limitations or to limit the received signal so the ground system RF components will not be overdriven. Off-pointing and reflections from the ground and local structures can also make it difficult to achieve a valid test.

End-to-end network testing primarily validates the ground station to MOC interface. This test verifies that the MOC can properly receive downlink data from the ground station and verifies that the ground station can receive and process uplink command data from it. Initial end-to-end testing will validate network connectivity, showing that network connections can be established and firewall rules at the ground station and MOC are in place. Once network connectivity is established, the MOC can transmit commands to the ground station for capture. The ground station can then transmit simulated or recorded data to the MOC for validation.



It is preferable to conduct initial end-to-end network testing prior to compatibility testing. In cases where the satellite can be brought to the ground station, a full end-to-end test can be conducted. Command transmissions from the MOC, through the network and ground system to the satellite can be validated. A complete end-to-end telemetry data flow from the satellite to the control center can also be validated.

## 11.8 Spacecraft Commissioning

Spacecraft commissioning is a critical mission stage. During this period the MOC is fully staffed and there is heightened interaction with the ground network. It is not uncommon for spacecraft anomalies to arise and require troubleshooting. Communication challenges have been prevalent for SmallSats during the commissioning period. The following discusses the commissioning process and identifies how these challenges can be addressed.

The spacecraft commissioning phase consists of early operations to establish the proper baseline functionality and performance of a spacecraft and ground system. In general, this is a 2-step process: establish a reliable communication link between the ground station and the spacecraft and establish proper baseline performance of the spacecraft (bus and payloads).

The first step involves trying to point the ground station antenna towards the satellite. This step is simplified when using low data-rate communication with omnidirectional capability at the ground and satellite terminals. Challenges associated with initial satellite-to-ground station link closure are generally related to ground antenna pointing predictions. Typically, TLEs or state vectors are established and shared by the launch provider after deployment. This information can be used to create an initial orbit solution for the ground station antenna pointing. Sometimes this method is not successful because the TLEs are either mislabeled or have become outdated within days of deployment and the satellite has moved out of the predicted location, usually a few seconds ahead or behind. Operators can adjust the time offset in their tracking software to search for the satellite. Missions will then rely on North American Aerospace Defense Command (NORAD) TLE data (see <https://www.space-track.org>) for the satellite location. However, it could take up to a week or more for NORAD to add the new object to their tracking list. This process could be delayed further if multiple spacecraft are ejected in close proximity, and it is not clear which NORAD element set corresponds to which spacecraft. It is not uncommon to spend weeks attempting different NORAD-tracked objects until the correct one is found. The position prediction accuracy based on the NORAD TLE also diverge over time and a new TLE will be needed to maintain data link. This is typically not an issue since the TLE is updated regularly, but on-board GPS data (if equipped) can help determine the orbital parameters for the ground station to define latest orbital parameters.

Another method to locate the satellite includes using the slant range as they rise from the horizon. The uncertainty of the satellite position in an orbit is greatest in the in-track position. This is equivalent to a time error and often satellites being tracked are considered “early” or “late” with respect to their expected position at a specific time. Ground station operators usually point their directional antenna to just above the horizon to “hang” in one place for a time that is sufficient to detect the satellite and synchronize with the radio, provided that the link budget closes at that range. Some antenna tracking software will allow the operator to begin the track after this initial acquisition is successful. The pointing is most critical at the shortest range and if a link is lost, one can gain insight into the magnitude of the time error (number of seconds behind or ahead of the predicted position). This technique of waiting on the horizon will work regardless of the quality or proper tagging of the TLE.

A half-duplex or full-duplex system could make a difference as well. Program track instead of auto-track is used for half-duplex. With a full-duplex system, the ground antenna attempts to



acquire the downlink first. Predicts (NORAD or state vectors) are still used to initially acquire the spacecraft. If the predicts are off, the antenna can initiate a mechanical scan to increase the search area. Once the downlink is acquired, the ground antenna can auto-track and automatically point at the satellite for the duration of the pass.

No responses from a satellite could be due to reasons other than bad antenna pointing, such as spacecraft anomalies, ground system anomalies, or spacecraft trajectory. Periodic automated downlink bursts (beacons) or secondary commercial vendor space relay networks could help understand the health of the satellite in these cases. Reduced GPS data, if equipped, may be included in addition to basic housekeeping data to help diagnose possible communication issues.

Spacecraft commissioning will commence once a good link has been established. Typically, the satellite is in a safe mode or sun pointing mode until ground commands a different operating mode. The first step is to verify the basic health of the satellite such as correct pointing, voltages, temperatures, power consumption, and proper battery charge. At this time the payloads are likely off until spacecraft bus checks are performed. A set of housekeeping data is collected over multiple passes to observe trends in behavior over time. Subsystem leads will perform an assessment to verify nominal performance. In addition, the trended data is used to establish a baseline performance for the system. Many assumptions, mostly conservative assumptions, were used during the development of the mission and now is the time to compare predictions with reality. Power, thermal, and pointing performance are some examples of technical baselines to be established. If issues do arise, engineers may desire an increased housekeeping data polling cadence or a higher level of data within a specific mission mode for troubleshooting. It is important to consider how housekeeping data will be handled in the development phase to prepare for commissioning activities. The spacecraft may transition to other operating modes once the safe or sun pointing mode has been shown to be stable.

Payload commissioning will start once the spacecraft bus is operating nominally or the baseline performance has been determined. The mission may elect to test the instruments while sun pointing if power could be a problem. Otherwise, instrument commissioning can commence using the science pointing mode. The payload will perform a series of tests determined by the science team. Instrument commissioning will include verifying proper functionality of the software and hardware. It may also include the validation of science data and calibration activities.

The information described below is not intended to be exhaustive but provides an overview of current state-of-the-art technologies and their development status for a particular small spacecraft subsystem. It should be noted that Technology Readiness Level (TRL) designations may vary with changes specific to payload, mission requirements, reliability considerations, and/or the environment in which performance was demonstrated. Readers are highly encouraged to reach out to companies for further information regarding the performance and TRL of described technology. There is no intention of mentioning certain companies and omitting others based on their technologies or relationship with NASA.

## **11.9 State-of-the-Art – Ground Data Systems**

Ground data systems are complex systems and how they are used is highly dependent on the needs of the mission. There are several established service solutions that can meet mission needs. There is also an array of hardware and software options that can be considered for those that intend to be a bit more hands-on. This section presents a preview of available services, hardware, and software solutions.

### **11.9.1 Direct-to-Earth Ground Service Providers**

The following section provides an overview of DTE Ground System Network Service Providers. These are ground services, meaning that the satellite operator does not own the ground station(s),



but instead buys time with a ground service provider for their ground architecture needs (see 11.5.6 for a discussion on the considerations of buying ground services versus building and owning a ground station).

While the specific and unique qualities of each service provider are discussed below, there are some common features across their services (see table 11-3). In general, they have ground networks that span the globe and can service multiple frequency bands in almost any orbit in low-Earth orbit, and some may be able to service medium Earth orbits (MEO) or GEO orbits as well.

Using these services will generally require some degree of pre-coordination (or “onboarding”) between the operator and provider, which is usually done before launch. This will vary between providers but may include: contracting mechanisms; frequency licensing and coordination between the operator and the provider; compatibility testing; and the sharing of mission and vehicle specific information to ensure the ground stations are properly configured for the operator to use.

Once the onboarding process is complete, satellite operators can schedule passes between their satellite(s) and desired ground station(s) in advance (the time window varies for each provider), usually through a web-based platform of some kind. The schedules for each ground station are deconflicted based on scheduling priority, and all frequency and modulation adjustments for the satellite are completed in advance of the pass by the service provider.

Most of the ground service providers in this section are TRL 9, since most of them are either currently flying or have previously flown multiple missions. Because so many of these networks are highly advanced, the distinguishing features between them is not their TRL level, but rather the frequency bands, ground station locations, and other unique services and attributes that they offer to operators. TRL 7 – 8 indicates that they have capable systems but have served a limited number of customers.

<b>Table 11-2: Service Providers for DTE Ground System Networks</b>			
<b>Product</b>	<b>Manufacturer</b>	<b>TRL</b>	<b>Services</b>
ATLAS Global Network	Atlas Space Operations	9 for ground infrastructure TRL 8 for software integration	S-band, X-band, UHF (Ka-band in 2017) Built on AWS cloud infrastructure
KSATlite	Kongsberg Satellite Services	9	X-band and S-band D/L and S-band U/L. VHF, UHF, Ka-band D/L Designed specifically for SmallSats
Tyvak Ground Network	Tyvak Nano-Satellite Systems, Inc.	9	Global UHF network with S, X, Ka-bands being added, partner with other providers for an expanded network



SSC Infinity	Swedish Space Corporation	9	Designed specifically for SmallSats Uses standardized HW and configurations to help keep costs low
RBC Signals Global Ground Station Network	RBC Signals	9	VHF, UHF, S, C, X, Ku, and Ka-bands
AWS Ground Station	Amazon	7 for ground infrastructure 9 for software integration	Built on AWS cloud infrastructure Using third-party ground stations
UHF Ground Station	NASA	9	18 m dish, operating in UHF (400 – 470 MHz)
Near Earth Network	NASA	9	Global network operating in S, X, and Ka-bands that can reach LEO, GEO, HEO, and Lunar orbits
Deep Space Network	NASA/JPL	9	34 m and 70 m antennas, operating at S, X, K, Ka bands, 8 m optical receive aperture starting in second half of 2020s
DSS-17	Morehead State University	9	21 m operating in X band, serves as a Class D Station for NASA Interplanetary Class D CubeSat missions

### Atlas Global Network

ATLAS Space Operations, Inc. is a U.S. owned, non-traditional small business that provides satellite RF communications services to the government and commercial sectors. Through geographical dispersion and cloud services, ATLAS Space Operations provides a resilient capability that delivers low latency data. Integral to the ATLAS mission success model is a global network of operational ground sites, which work together as a mission architecture to meet customer requirements.

All ATLAS ground stations are built upon the Freedom™ Software Platform, which facilitates dynamic demand and scalable growth. Once integrated into the ATLAS Network, a single secure VPN enables access and load balancing of network resources. Freedom™ Core Services advance operations beyond legacy constructs and enable users the freedom and flexibility to reliably schedule satellite passes with minimal human interaction. Entire data processing and forwarding workflows can be automated within the cloud to ensure your data is ready for use as soon as it arrives at the Mission Operations Center.

Through its worldwide ground station network, ATLAS Space Operations provides cloud-based services to support satellite launch and mission operations. ATLAS can provide VHF, UHF, S-band, and X-band capabilities. The existing and planned ATLAS antenna systems support RF



connectivity for low-Earth orbit, MEO, GEO, and L1 orbits, and ATLAS is actively pursuing technology development for deep space capabilities. Figure 11.13 shows the ATLAS Space Operations network map for current and future sites.

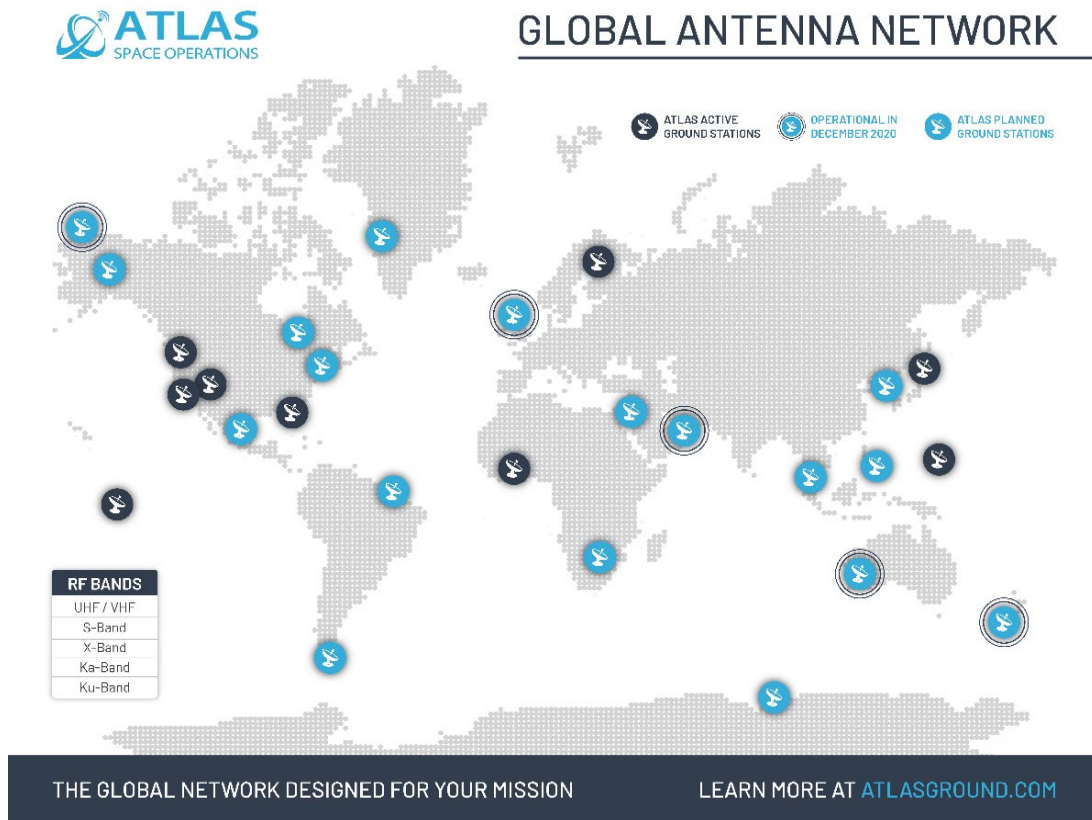


Figure 11.13: ATLAS Space Operations ground network map. Credit: ATLAS Space Operations.

### KSAT<sup>LITE</sup>

KSAT<sup>LITE</sup> is a low-cost, high-reliability ground station antenna network designed to support missions operating in Low-Earth orbit. Kongsberg Satellite Services AS (KSAT) operates 50+ KSAT<sup>LITE</sup> antennas at 12+ ground station sites across the globe (figure 11.14) and is expanding the network with additional antennas and sites to accommodate the expanding market for missions to low-Earth orbit. KSAT<sup>LITE</sup> is an extension of the existing KSAT ground station antenna network with lower costs, increased flexibility, and improved availability and pass selection. The KSAT network has uniquely located polar stations in the Arctic and Antarctic regions, providing 100% availability on passes for spacecraft in polar orbit. The network also includes mid-latitude ground stations, providing access for diverse orbits and mission profiles. The baseline KSAT<sup>LITE</sup> 3.7-meter antennas provide X-band and S-band for downlink and S-band for uplink. In addition, KSAT<sup>LITE</sup> offers Ka-band downlink and VHF and UHF capacities to support a variety of system configurations (Kongsberg Satellite Services AS, 2020). Together with the ESA- European Space Operations Centre, KSAT<sup>LITE</sup> is integrating a network of optical ground stations, and the first station of the Optical Nuclear Network was installed in Greece in January 2021 (60). These stations will support both SmallSats and larger missions that demand a higher throughput or more secure downlink solutions.



Figure 11.14: 2021 KSAT<sup>LITE</sup> ground network map. Credit: KSAT.

### Tyvak Nano-Satellite Systems, Inc. Ground Network

Headquartered in Irvine, California, Tyvak is an industry leader, delivering optimized, end-to-end nano and microsatellite solutions for civil and defense organizations. Tyvak specializes in spacecraft development, launch integration services, and managing in-orbit operations for critical missions across a variety of applications, including technology demonstrations and bring-into-use spacecraft, communications, earth observation, interplanetary science, proximity operations, and space situational awareness. With a dedicated commitment to making space accessible and providing mission assurance for its customers, Tyvak's global ground station network also provides worldwide coverage for in-orbit operations around the clock.

Tyvak currently operates a worldwide network of UHF ground stations, operating in the 400 MHz band. These stations are used to operate spacecraft in-orbit and have accumulated thousands of passes with a variety of spacecraft in several different orbital planes. The network offers at minimum one pass per orbit for a polar orbiting spacecraft, as well as substantial coverage for other inclinations. Tyvak is in the process of upgrading its towers to a new generation, including advanced features such as unlimited rotation, weatherproofing for harsher environments, and increased system gain. Tyvak is also expanding its network to include several 3.7 m S/X-band ground stations and is planning for additional antennas in the Ka-band. The first of these have already been installed and are supporting in-orbit assets. In addition to the Tyvak network, Tyvak has maintained its partnerships with commercial ground station providers, such as KSAT and Amazon Web Services (AWS), to offer its customers access to a diverse set of antenna assets beyond those owned by Tyvak.

### Swedish Space Corporation

Swedish Space Corporation (SSC) is a global provider of ground station services, including support to launch and early operations, on-orbit Telemetry, Tracking and Control (TT&C) and data downlink, and even lunar services. The SSC Infinity Network is specifically designed for



constellations of small satellites in low-Earth orbits. The global network provides TT&C and data download and delivery services to SmallSat operators, and customer interfaces consist of web-based portals for pass scheduling on 5-meter and smaller antennas. SSC Infinity also uses standard configurations and standardized ground system hardware, limiting the number of mission configurations to help keep costs lower for satellite operators.

### RBC Signals

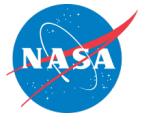
RBC Signals is a global space communications provider serving government and commercial satellite operators in GEO, low-Earth orbit, & MEO with an improved model for the delivery and processing of data from satellites in orbit. The company's worldwide network includes both company-owned and partner-owned antennas, capitalizing on the sharing economy model, for best-in-class services offering affordability, flexibility, and low latency. Their team has deep relationships across the entire space value chain and decades of experience building, operating, and maintaining ground stations for the direct reception and processing of Earth observation satellite data.

For customers needing turnkey access to existing antennas, RBC Signals offers ground station antenna-as-a-service, with the flexibility to secure unlimited satellite passes or 'pay-by-the-pass/minute/GB'. This is made possible through a combination of their own network of highly capable systems and the unique 'sharing economy' model, wherein they leverage the unused excess capacity of dozens of partner-owned antennas worldwide. This amounts to a growing network of over 70 antennas in nearly 50 locations worldwide offering unmatched capabilities. A map of these locations is shown in figure 11.15.

RBC Signals also offers turnkey bring-your-own-antenna hosting solutions that pair customer-owned equipment with reliable, high-end ground infrastructure almost anywhere in the world.



Figure 11.15: RBC Signals ground network map. Credit: RBC Signals.



They also use a distributed compute architecture where most processing will occur at a data center/cloud, with some processing on the satellite or at the terrestrial edge at the ground station. RBC Signals can host AWS and Microsoft on premise cloud infrastructure, as well as virtual servers at the ground station.

### **AWS Ground Station**

AWS Ground Station enables operators to control and ingest data from orbiting satellites without having to buy or build satellite ground station infrastructure. AWS Ground Station does this by integrating the ground station equipment like antennas, digitizers, and modems into AWS Regions around the world. Operators onboard their satellites and schedule time to communicate with them. There is the option of conducting all satellite operations on the AWS Cloud, including the storing and processing of satellite data with results delivered using AWS services, or the AWS Ground Station can downlink the satellite data and transport it to the user's processing center.

AWS Ground Station antennas are located within fully managed AWS ground station locations, and are interconnected via Amazon's low-latency, highly reliable, scalable, and secure global network backbone. Operators can connect with any satellite in low-Earth orbit and MEO operating in X-band and S-band frequencies, including: S-band uplink and downlink, X-band narrowband and wideband downlink. Data downlinked and stored in one AWS Region can be sent to other AWS Regions over the global network for further processing.

AWS Ground Station provides an easy-to-use graphical console that allows operators to reserve contacts and antenna time for their satellite communications. They can review, cancel, and reschedule contact reservations up to 15 minutes prior to scheduled antenna times. Access can be scheduled to AWS Ground Station antennas on a per-minute basis, so operators only pay for the scheduled time. They can access any antenna in the ground station network, and there are no long-term commitments.

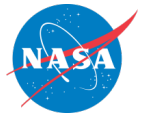
AWS Ground Station provides satellite antennas direct access to AWS services for faster, simpler, and more cost-effective storage and processing of downloaded data. This allows operators to reduce data processing and analysis times for use cases like weather prediction or natural disaster imagery from hours to minutes or seconds. This also enables operators to quickly create business rules and workflows to organize, structure, and route the satellite data before it can be analyzed and incorporated into key applications such as imaging analysis and weather forecasting. Key AWS services include Amazon EC2, Amazon S3, Amazon VPC, Amazon Rekognition, Amazon SageMaker, and Amazon Kinesis Data Streams (1).

### **NASA UHF Ground Station**

The Atmospheric Sciences Research Facility (ASRF) SmallSat Ground Station (ASGS) supports a range of small satellite operators with a UHF ground station operating 24/7 at NASA Wallops Flight Facility (WFF). ASGS uses the 18 m UHF antenna shown in figure 11.16 that was originally brought online in 1959 and used as a radar. With this large high-gain antenna (36 dbi gain, 2.9° beamwidth at 450 MHz) operating in the 380 to 480 MHz UHF band, the ground station provides a 3.0 Mbps high data rate capability for CubeSats, which is 300 times the typical 9.6 Kbps. The ground system uses a software defined radio and front-end processing software. Service includes



*Figure 11.16: 18-meter UHF ground station antenna at NASA Wallops Flight Facility. Credit: NASA.*



support for downlinking telemetry and/or uplink commanding, monitor & control capability, scheduling, and data storage. The scheduling process provides operators with a deconflicted schedule based on user requirements. This is being accomplished with minimal documentation, pre-mission testing and cost-per-pass. As of March 2020, the station supports eleven NASA funded CubeSats. An affiliation with NASA is required to use the system. This would include being a NASA sponsored mission through means such as a grant or having either an interagency or reimbursable agreement with WFF.

### NASA Near Earth Network

The NASA NEN provides direct-to-earth telemetry, commanding, ground-based tracking, and data and communications services to a wide range of customers. The NASA NEN Project consists of NASA, commercial, and partner S-band, X-band, and Ka-band ground stations supporting spacecraft in low-Earth orbit, GEO, Highly Elliptical Orbit (HEO), Lunar orbit, and Lagrange point L1/L2 orbit up to one million miles from Earth. The NEN supports multiple robotic and launch vehicle missions with NASA-owned stations and through cooperative agreements with interagency, international, and commercial services. The NEN is adding additional Ka-band capability, and recently added two 6.1-meter S-band ground stations in Florida. The Ka-band and Florida ground stations augment NEN small satellite orbital tracking and communications capacity. Table 11-4 shows the radio frequencies that the NEN supports via the NTIA.

<b>Band</b>	<b>Function</b>	<b>Frequency Band (MHz)</b>
S Uplink	Earth to Space	2,025 – 2,110
X Uplink	Earth to Space	7,190 – 7,235 (Two NEN sites to 7,200)
S Downlink	Space to Earth	2,200 – 2,300
X Downlink	Space to Earth, Earth Exploration	8,025 – 8,400
X Downlink	Space to Earth, Space Research	8,450 – 8,500
Ka Downlink	Space to Earth	25,500 – 27,000

The NEN has been ready to provide TT&C services for CubeSats ever since they were introduced over a decade ago. Since the NEN supports primary frequency bands of S, X, and Ka it is more advantageous than using UHF bands, which are allocated as secondary frequencies and have an increased probability of local interference. The NEN provided service to its first CubeSat mission, the SeaHawk-1 CubeSat, in March 2019. It was tracked by the NEN Wallops 11-m antenna (WG1) at a data rate of 3 Mbps over X-band. This was accomplished through the small X-band antenna shown in figure 11.17. The WG1 detected good signal strength, autotracked, locked-on to collect data, and successfully completed file delivery. In June 2019, the spacecraft transmitted at 50 Mbps, which is a very high data rate for a CubeSat. There are currently

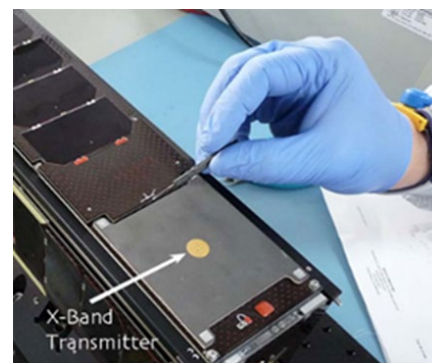


Figure 11.17: SeaHawk-1 CubeSat X-band antenna. Credit: NASA.



five in-house 6U CubeSat missions at NASA Goddard Space Flight Center (GSFC) planning to use the NEN for S-band uplink and downlink.

The NEN is exploring how to provide higher data rates for CubeSat missions with techniques such as Digital Video Broadcast Satellite Second Generation (DVB-S2). Higher data rates either increase science return or reduce the number of minutes per day of required ground station contacts. Reducing the number of minutes per day increases the number of small satellite spacecraft that the NEN may accommodate with its existing ground stations. Higher data rates also enable mother-daughter small satellite constellations, where the mother spacecraft handles the communication with Earth for multiple daughter spacecraft. The NEN is also exploring the addition of Multiple Spacecraft per Aperture (MSPA) for constellations of CubeSats and arraying of antennas for higher performance. Future larger satellite missions are planned to be supported by the NEN at 4 Gbps via Ka-band.

The NEN facilitates Commercial Services (CS) and negotiated a bulk-buy discount for all NASA missions. This allows for contacts on the NEN Contractor/University Operated and CS apertures to be at no-cost for NASA missions. The NEN does schedule CS in accordance with NASA mission-defined priority. The Networks Integration Management Office (NIMO) at NASA GSFC is the liaison for customers that wish to use NEN services. NIMO has a variety of services and capabilities available and can coordinate support from providers throughout NASA, other US agencies, US commercial entities, and foreign governments. Some of the services that NIMO can provide include:

- Requirements Development
- Communications Design Support & Guidance
- Optical Communications Analysis
- Network Feasibility Analysis
- Spectrum Management
- RF Compatibility Testing
- Launch Support

Network Feasibility Analysis includes determining NEN station loading as a function of the mission's priority and determining the availability of planned stations for the contacts requested. Prior to the mission deployment, the NEN commits to providing the requested stations and contact time as outlined in the network feasibility analysis.

If interested in more information on using the NEN, please contact NIMO's Jerry Mason.

Jerry Mason, Chief  
Networks Integration Management Office, Code 450.1  
Exploration and Space Communications Projects Division  
Goddard Space Flight Center, Greenbelt, MD 20771  
Phone: (301) 286-9515  
Email: [jerry.l.mason@nasa.gov](mailto:jerry.l.mason@nasa.gov)

### **NASA Deep Space Network**

The Deep Space Network (DSN) is optimized to conduct telecommunication and tracking operations with space missions in GEO. This includes missions at lunar distances, the Sun-Earth LaGrange points, and in highly elliptical Earth orbits, as well as missions to other planets and beyond. The DSN has supported, or is currently supporting, missions to the Sun as well as every



planet in the Solar System (including dwarf planet Pluto). Two missions (Voyager I and Voyager II) have reached interstellar space and still communicate with the DSN.

For more information, please see:

<https://www.nasa.gov/directorates/heo/scan/services/networks/dsn>

<https://deepspace.jpl.nasa.gov/about/commitments-office/>

<https://deepspace.jpl.nasa.gov>

The DSN offers services to a wide variety of mission customers, as shown in table 11-5.

<b>Table 11-4: DSN Customers, Mission Characteristics, Frequencies, and Services</b>	
<b>Customers</b> <ul style="list-style-type: none"> <li>• NASA</li> <li>• Other Government Agencies</li> <li>• International Partners</li> </ul>	<b>Mission Phases</b> <ul style="list-style-type: none"> <li>• Launch and Early Orbit Phase (LEOP)</li> <li>• Cruise</li> <li>• Orbital</li> <li>• In-Situ</li> </ul>
<b>Mission Trajectories</b> <ul style="list-style-type: none"> <li>• Geostationary or GEO</li> <li>• HEO</li> <li>• Lunar</li> <li>• LaGrange</li> <li>• Earth Drift Away</li> <li>• Planetary</li> </ul>	<b>Frequency Bands</b> – Includes Near-Earth and Deep Space Bands, Uplink and Downlink, Command, Telemetry, and Tracking Services <ul style="list-style-type: none"> <li>• S-Band (2 GHz)</li> <li>• X-Band (7, 8 GHz)</li> <li>• Ka-Band (26, 32 GHz)</li> </ul>

DSN services include:

- Command Services
- Telemetry Services
- Tracking Services
- Calibration and Modeling Services
- Standard Interfaces
- Radio Science, Radio Astronomy and Very Long Baseline Interferometry Services
- Radar Science Services
- Service Management

Custom and tailored DSN services can also be arranged for missions and customers. DSN-provided data services are accessed via well-defined, standard data and control interfaces:

- The CCSDS
- The Space Frequency Coordination Group (SFCG)
- The ITU
- The International Organization for Standardization (ISO)
- De facto standards widely applied within industry
- Common interfaces specified by the DSN

The use of data service interface standards enable interoperability with similar services from other providers.



Figure 11.18: DSN antennas and their locations. Credit: NASA.

Figure 11.18 shows the DSN antennas and their locations. Each DSN ground station in California (United States), Madrid (Spain), and Canberra (Australia) currently (June 2021) is operating four 34 m Beam Wave Guide antennas and one 70 m antenna. By the late 2020s, this is planned to increase to include one 70 m plus four 34 m antennas at each DSN site.

The DSN can track multiple spacecraft per antenna (MSPA) (up to four) if they are all within the scheduled antenna's beam. The 34 m antennas at each complex can be combined into an array, with or without the co-located 70 m antenna. The combined G/T depends on several factors but is approximately increased by the sum of the antenna areas from the arrayed apertures minus approximately 0.3 dB combining loss. For instance, arraying four 34-meter antennas results in an increase of 5.72 dB.

The DSN supports RF testing using the following facilities:

- Development and Test Facility (DTF-21), located near NASA Jet Propulsion Laboratory (JPL)
- Compatibility Test Trailer (CTT-22), able to come to the spacecraft site



- DSN test facility (MIL-71), located at NASA Kennedy Space Center (KSC), Florida

### **Morehead State University CubeSat Ground Station**

Morehead State University, as an early CubeSat technology adopter, has developed ground station technologies to support low-Earth orbit and interplanetary CubeSat missions. The Morehead State University Space Science Center team developed a 21-meter antenna system that has provided telemetry, tracking, ranging and commanding services for low-Earth orbit, MEO and “near-Earth” deep space CubeSat missions since it came on-line in 2006. The 21-meter antenna, shown in figure 11.19, is a unique educational tool that provides an active laboratory for students to have hands-on learning experiences with the intricacies of satellite telecommunications and radio astronomy.

From its inception, it was anticipated that the 21 meters would provide TT&C services for small, low power satellites performing research in the lunar vicinity, at Earth-Sun Lagrange points, at near-Earth Asteroids, and potentially out to Mars at low data rates. It was not envisioned that these small satellites would be CubeSats since the form factor was evolving simultaneously with the planning and design of the 21-meter dish. The proliferation of CubeSats and other SmallSats investigating interplanetary destinations, however, has begun to provide unique opportunities for the students and staff at Morehead State University to gain valuable experience in space operations and to vet performance of the 21-m antenna as an operational deep space station.

An upgrade supported by NASA’s Advanced Exploration Systems in 2016 turned the 21-meter antenna into Deep Space Station 17 (DSS-17), an affiliated node on NASA’s DSN. The upgrade, that was undertaken in partnership with JPL, improved the performance of the station to meet DSN standards for operations. Performance metrics of DSS-17 are listed in table 11-6. This arrangement has provided another level of real-world experience to students in the space science programs at MSU who primarily operate the station. The operating philosophy is that DSS-17 serves as a Class D Station for NASA Interplanetary Class D CubeSat missions.

Students and staff at the Space Science Center at Morehead State University are developing a full motion 12-meter class antenna system that will serve as an Earth Station for low-Earth orbit satellite mission support as well as a training facility for university students to gain experience in space mission operations. The instrument was needed to fill the role previously held by the 21-meter station that is now devoted to interplanetary SmallSats. The 12-meter ground station will be staffed by university students. It will be available for a wide variety of TT&C services at S-band



*Figure 11.19: The Morehead State University 21-meter Ground Station has been upgraded with support from NASA’s Advanced Exploration Systems, to become the first non-NASA affiliated node on the DSN. Referred to as DSS-17, the station will support NASA Interplanetary CubeSat missions. Credit: Morehead State University.*

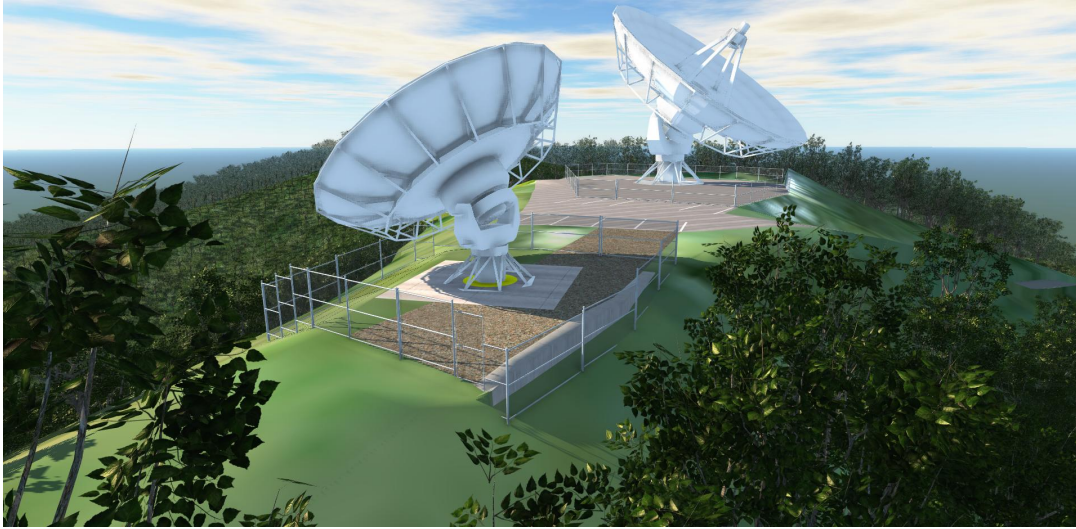


Figure 11.20: Artist's Concept of the 21-meter Ground Station (DSS-17 back) and the 12-meter low-Earth orbit Ground Station (front) under development at Morehead State University. Credit: Morehead State University.

and X-band when it becomes operational in 2022. Figure 11.20 illustrates both 21- and 12-meter ground stations at Morehead State University.

<b>Table 11-6: DSS-17 Performance Characteristics (X-Band)</b>	
<b>Performance Measure</b>	<b>Performance Value</b>
<b>X-Band Frequency Range*</b>	7.0 – 8.5 GHz
<b>X-band Uplink Range*</b>	7.145 – 7.235 GHz
<b>X-band Downlink Range*</b>	8.400 – 8.500 GHz
<b>LNA Temperature</b>	< 20 K
<b>System Temperature <math>T_{sys}</math></b>	<100 K
<b>Antenna Gain</b>	62.7 dBi (@8.4 GHz)
<b>System Noise Spectral Density</b>	<-178 dBm/Hz
<b>G/T at 5° Elevation</b>	40.4 dBi/K
<b>Time Standard</b>	H- MASER (1ns/day)
<b>EIRP</b>	93.7 dBW
<b>HPBW</b>	0.1150 deg
<b>SLE Compliant</b>	Yes
<b>CCSDS Capable</b>	Yes
<b>Radiometric</b>	Angle, Doppler, Sequential Tone and PN Ranging
<b>Ranging Precision</b>	+/-1 range unit (0.94 ns)



### 11.9.2 Space Relay Network Service Providers

Space relay solutions are less common than traditional direct-to-Earth solutions, but there are a few options that exist for small satellites (see table 11-7). To access the space relay, a satellite operator purchases a modem from the relay manufacturer and flies that on their satellite in order to access the relay services. In general, space relays are ideal for obtaining satellite TT&C data (health and safety of the vehicle) rather than for large data downlinks.

<b>Table 11-7: Service Providers for Space Relay Networks</b>			
<b>Product</b>	<b>Manufacturer</b>	<b>TRL</b>	<b>Specifications</b>
Simplex Data Network	Globalstar	9	LEO relay requiring either simplex or duplex data modems onboard the satellite
TDRSS Network	NASA	9	GEO relay providing S-band downlink
Fast Pixel Data Transport Network	Analytical Space	6 – 7	Developing LEO relay with hybrid RF and optical downlink
Iridium Global Network	Iridium	9	LEO relay requiring 9600 series transceivers onboard the satellite

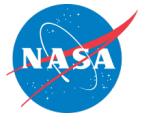
#### Simplex Data Network

The Simplex Data Network by Globalstar operates with a low-Earth orbit satellite constellation that small satellites can communicate with via simplex and duplex data modems. The constellation of 48 satellites is spread on eight orbital planes with an altitude of 1,414 km and an inclination of 52°. Coverage is provided between 70° South latitude and 70° North latitude, so it does not have coverage over the poles. The satellites serve as a bent pipe for communication and do not have crosslink capability between satellites. The Globalstar system uses Code Division Multiple Access (CDMA) for its communication waveforms, which can provide a secure connection. The constellation satellites receive user spacecraft signals at L-band (1610-1626.5 Mhz) and converts it to C-band for relay to the ground station or gateway. Once the data is downlinked to the gateway, it is stored in a cloud-based network, and users can directly access the cloud to retrieve their data. Data plans are purchased monthly for this service. Data coverage is 24/7 and can be received in near real-time. If using the duplex modem configuration, commanding can also be done 24/7 unlike a traditional ground station where the satellite needs to be within its line of sight. The modem data rates are at 9.6 kbps.

The primary benefit of this service has been the ability to receive satellite health telemetry. This is particularly helpful post-deployment while the ground station is searching for the spacecraft. The ability to command the spacecraft with the system has been met with mixed results. Significant lag has been experienced between the time when the command is sent and when the satellite receives it. For missions with low data requirements, this is an option to consider for the ground solution. Missions with high data rate requirements can still consider it as a backup option for keeping track of satellite health when the satellite is not in contact with a ground station (2).

#### Tracking and Data Relay Satellite System Network

The NASA TDRSS is a communication signal relay system that provides tracking and data acquisition services. The TDRSS space segment consists of six in-orbit Tracking and Data Relay



Satellites (TDRS) located in GEO. Three TDRS are available for operational support at any given time. The operational spacecraft are located at 41°, 174° and 275° west longitude. The other TDRS in the constellation provide ready backup in the event of an operational spacecraft failure and, in some specialized cases, resources for target of opportunity activities. The system can transmit to, and receiving data from, spacecraft over at least 85% of the spacecraft's orbit. The TDRSS ground segment is located near Las Cruces, New Mexico, known as the White Sands Complex. Forward data is uplinked from the ground segment to the TDRS and from the TDRS to the spacecraft. Return data is downlinked from the spacecraft via the TDRS to the ground segment and then on to the designated data collection location.

TDRSS provides S-band and Ku-band services through the single access (SA) antennas and S-band services through the S-band multiple access (SMA) phased array. TDRSS can support coherent range and two-way Doppler tracking as well as noncoherent one-way return-link and one-way forward-link Doppler tracking of user spacecraft. Accurate one-way return-link tracking, which can use SMA, the most available TDRSS resource, requires a stable oscillator onboard the user spacecraft as the source of frequency. Two-way and one-way return-link tracking measurements are used for ground orbit determination for navigation and precise positioning; one-way forward-link tracking is used for autonomous onboard navigation with achievable accuracies better than those of the GPS Precise Positioning System (PPS).

The NASA GSFC BurstCube 6U CubeSat mission is applying modifications to a Vulcan S-band radio to communicate with TDRSS. The mission is using TDRSS to obtain real-time alerts of science events captured by the spacecraft (3) (4).

### **Fast Pixel Data Transport Network**

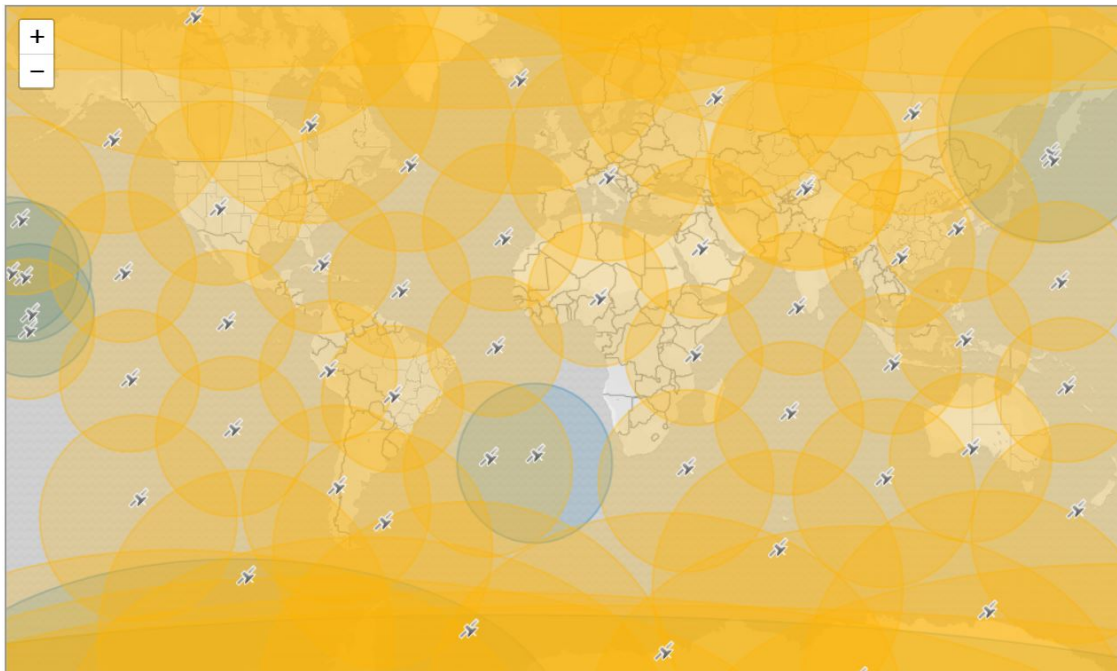
Analytical Space's Fast Pixel Data Transport Network will consist of a constellation of relay satellites in low-Earth orbit to provide high-speed data connections for client satellites. Client satellites will transmit the data to the relay satellite via RF, and the relay satellite will downlink that data through a combination of optical and RF communications. The network will be backward compatible with a variety of radio frequencies, meaning no additional hardware will be required onboard a client satellite. The network will also use a combination of optical and RF communications for the relay downlink, allowing for higher throughput through the system than a traditional RF system. This network is not yet fully operational; a technology demonstration was launched in 2018, putting this system at a TRL level of 6 – 7 (5).

### **Iridium Global Network**

The Iridium Global Network is a constellation of low-Earth orbit satellites that provide global communications to both users on the ground and other satellites in space. The 66 cross-linked satellites are spaced evenly on 6 orbital planes that are near polar at an 84.6 inclination and have an altitude of approximately 780 km. The service provides global coverage, including the polar regions. Due to its proximity to other low-Earth orbit "client" satellites, satellite operators can relay data through the Iridium network faster than a GEO relay network. The Iridium network uses a combination of Frequency Division Multiple Access (FDMA) and Time-Division Multiple Access (TDMA) for its communication waveforms. L-band (1616 – 1626.5 Mhz) is used for uplink and downlink between the user spacecraft and the Iridium spacecraft. Inter-satellite communication links between Iridium satellites is accomplished through Ka-band (23.18 – 23.28 GHz). Operators install an Iridium transceiver (9600 series) onboard their spacecraft to communicate with the Iridium network. Messages are relayed through Iridium's Short Burst Data Service, which is hosted on Iridium's cloud platform for easy user operation. For each transceiver unit, a data plan must be chosen and purchased, much like cellular phone data plans, and the plan details are linked to the unit's ID, which is referred to as International Mobile Equipment Identity (IMEI). The special feature of this system is that it has as an option for "IMEI-to-IMEI" transmission. When an



Iridium IMEI is activated, five output destinations may be specified. Most vendors allow for a combination of emails addresses, fixed IP address, or another device with an IMEI ID. Other vendor service options would include the real-time satellite tracking tool called GSatTrack by Global Satellite Engineering (GSE). This tool allows users to know when an Iridium satellite is approaching overhead and its coverage area. An example screenshot is shown in figure 11.21.



*Figure 11.21: Screenshot of GSatTrack showing locations of Iridium Gen-1 satellites (blue circles) and Iridium NEXT satellites (orange circles). The size of the circle represents the coverage area. Credit: Global Satellite Engineering [www.gsat.us](http://www.gsat.us).*

As an application example, testing was completed at NASA WFF to evaluate the usefulness of short burst messages for tracking GPS location over the Iridium Network. Two transceivers were setup with one set to command and the other set in “tracking mode.” The command unit sent messages containing GPS data (attitude, longitude, elevation, and velocity) and the messages were received by the tracking unit within 2 – 10 minutes of transmission. This served as a successful demonstration of being able to receive short burst, low latency messages between two units without the need for scheduling. Such an application can be valuable for missions of opportunity such as SmallSat constellations.

In January 2019, Iridium deployed the last of its 75 NEXT satellites in conjunction with Thales Alenia Space and SpaceX. As a Public-Private Partnership (PPP), the NEXT satellites also carry hosted payloads limited to 50 kg and ~50 W of power. The satellites are replacements for the first generation and maintain interconnection with a crosslink architecture. Also in 2019, Iridium unveiled the Certus 9770 transceiver (which technology partners are beta testing and further developing), designed for speeds from 22 Kbps to 88 Kbps. It is capable of transferring IP data more than 35 times faster than previous devices (6) (7).



### 11.9.3 End-to-End Hardware for Ground Systems

A complete ground system can be provided as a kit with all the necessary components bundled together and setup to work seamlessly. These end-to-end solutions include the antenna, its controller, and the RF feed with all the necessary filtering and low noise amplification for the particular wavelength of interest. They use a software defined radio or a dedicated transceiver to convert between digital packets and RF waveforms. Software is included to process the satellite position and direct the antenna to track it. Additional software is used to archive and display the information within the digital packets. Three vendors, GAUSS, Innovative Solutions In Space (ISISPACE) and GomSpace, listed in table 11-8 provide solutions for the low-cost CubeSat and small satellite market. One vendor, Surry Satellite Technology Limited, offers a higher end system, installation service, and personnel support. The final vendor listed, Kratos, offers a different end-to-end solution that begins with the digitized RF waveform. The Kratos Quantum software then demodulates, filters, unpacks, parses, displays, and archives the data (8).

<b>Table 11-8: End-to-End Hardware for Ground Systems</b>			
<b>Product</b>	<b>Manufacturer</b>	<b>TRL</b>	<b>Type of Product</b>
Complete Ground Solution	GAUSS	9	Small satellite provider offering a complete ground solution. UHF, VHF, and S-band
Complete Ground Solution	ISISpace	9	Small satellite provider offering a complete ground solution. UHF, VHF, and S-band
Complete Ground Solution	GomSpace	9	Small satellite provider offering a complete ground solution. UHF, VHF, and S-band
Surrey Ground Segment	Surrey Satellite Technology Ltd.	9	Major contractor who will install ground stations capable of S-band for U/L and D/L and X-band for D/L.
Quantum	Kratos	9	Major contractor with a complete ground solution

#### **GAUSS Ground Station Kit**

The GAUSS ground station is a turnkey solution. It can be configured with UHF, VHF and S-band on the same pointing system. An example of the associated hardware is shown in figure 11.22.

Hardware features of the systems offered include (49):

- High gain Yagi-Uda VHF and UHF antennas (>16 dBi for UHF)
- Low-noise amplifiers and band-pass filters for VHF and UHF bands
- Low-loss RF coaxial cables
- 1.5-meter parabolic dish for higher frequencies downlink (up to 6 GHz, default feed is for S-band)
- VHF: uplink and downlink up to 100 W using radio and Terminal Node Controller (TNC), software defined radio (SDR) optional



- UHF: uplink and downlink up to 70 W, using radio and TNC, SDR optional
- TX using ICOM-9100 hardware, RX recording and decoding via SDR



Figure 11.22: (left) GAUSS ground station hardware, transceiver and (right) tracking antenna. Credit: GAUSS Srl.

- Several RF and electrical fuses for lightning protection
- S-Band: downlink using SDR for recording and post-processing of I/Q RF data
- Az/EI rotor for high-torque maneuvering
- Hardware components power switch on/off to minimize power consumption
- Full HD camera for instant antenna monitoring and picture logging

The features of the software that accompanies the system include:

- Automatic TLE download from publicly available repositories
- SGP4 propagator as suggested by USAF NORAD's Space-Track
- Rotor control (*compatibility with several rotor controllers, e.g. Yaesu, RF Hamdesign*)
- Assisted rotor pointing calibration and verification using Sun position
- Fully compatible with ICOM-9100 satellite radio and GAUSS USB ground dongle
- Separated Doppler shift corrections for uplink and downlink frequencies
- DUPLEX TX/RX mode
- Instant weather check and logging to operate the ground station safely
- Lightning detection for safe antennas operation
- Instant logging of all subsystems operation
- Ground map with live Earth clouds
- Compatible with several TNCs (*Kantronics, Symek, Paccomm, Kenwood*)
- Email report to ground station operators
- Instant email alerts for non-nominal conditions of the satellite or GS hardware components
- Session programming for weeks of unattended ground station operations
- GUI command recording for easy session programming
- One button programming to include a whole set of commands in the session
- Manual override during pass for last-minute command addition
- Control and handling of multiple satellites using configurable priorities
- Satellite TLM decoding, graphing, and archiving into a database accessible by web

- Integrated satellite payload data handling and decoding (e.g. for image file processing)
- TCP/IP connections for remote ground station & TNC operations

### Innovative Solutions In-Space Ground Station Kit

The ISISPACE small satellite ground station is a low-cost, turnkey solution that is designed to communicate with satellites in low-Earth orbit that operate in either amateur frequency bands or commercial bands. The frequency bands covered are S-band, UHF, and VHF. The ground station consists of an antenna and a 19" rack which houses the transceiver, rotor control and computer which make the system very compact. Examples of these components are shown in figure 11.23. The transceiver makes use of a SDR that provides flexibility to swiftly reconfigure modulation/coding/data-rate on the run. Most of the commonly used modulation schemes and coding methods are already implemented, and any customization requests can also be handled (9).



Figure 11.23: (left) ISISPACE ground station hardware, transceiver rack and tracking antenna (right). Credit: ISISPACE.

### GomSpace Ground Station Kit

The GomSpace end-to-end solution is unique from other vendor offerings because a generic software defined radio is replaced with their AX100 or TR-600 radios, depending on the type of radio the in-orbit satellite uses to communicate. Using the same transceiver hardware on both sides of the link simplifies the configuration and validation testing steps in the integration and test (I&T) phase of the project. While the GomSpace solution does not work with satellites that do not use the GomSpace transceivers, the benefit is lower cost and simpler ground segment equipment. Figure 11.24 provides a graphic representation of the ground station architecture and defines its critical components (10).

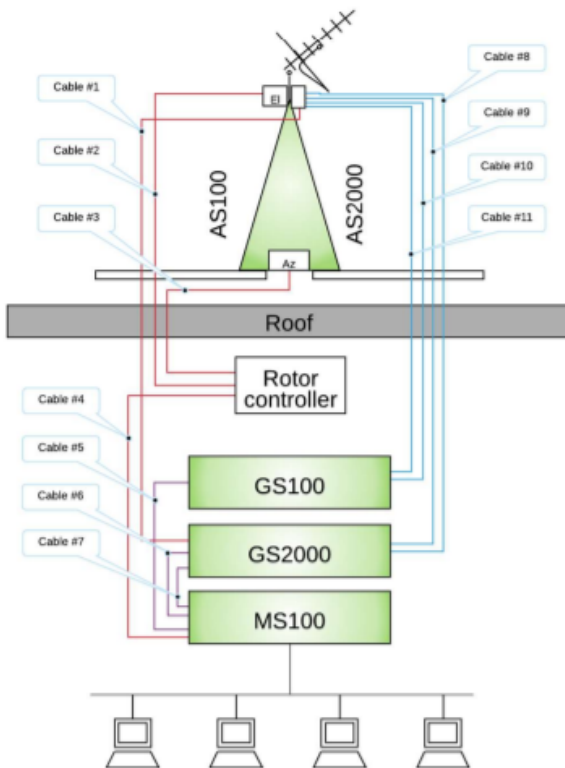
### Surrey Satellite Technology Ltd. Ground Station Kit

Surrey can provide complete turnkey ground segment solutions for a range of space platforms, including all the hardware and software necessary to operate, maintain, process and archive data. Services provide by Surrey include:

- S- and X-band ground stations with full motion antenna systems from 2.4 meter to 7.3 meter in diameter, with radome options available for harsh climates
- SSTL Pilot Satellite Control Software
- Mission planning systems
- Radiometric and geometric image processing
- Catalogue and data storage solutions



- Site surveys, ground segment installation and training
- Technical and maintenance support packages



#### NanoCom AS100 or AS2000

GomSpace has two rooftop antennas, the AS100 with VHF and UHF and the AS2000 with UHF and S-Band

#### NanoCom GS100 and GS2000

Each of the rooftop antennas has their own 19" rack mounted radio unit that contains two none flight qualified NanoCom AX100 or two TR-600 radio modules, placed on a special carrier board.

#### NanoCom MS100

A 19" rack mounted PC containing software relevant to controlling and communicating with a satellite. The unit has ethernet interface for remote access.

#### Software includes:

- Linux OS
- Rotor controller
- GSweb – tools for housekeeping (optional)
- Tracker software to control antenna movement
- Doppler compensation for the radio
- SDK

Figure 11.24: GomSpace ground station block diagram. Credit: GomSpace.

In addition, Surrey can work with customers to integrate their ground segment solutions with existing ground infrastructure or with 3rd-party ground station networks (11).

### Kratos Ground Station Solutions

The Kratos unique ground solution begins with their SpectraNet modem Digital IF product that converts analog signals at RF frequencies up to S-band into digital IF packets. It is the start of the Kratos digital processing product line chain. Kratos Quantum software operates on a fully digitized RF waveform. For example, a ground station service company would maintain the antennas and modems and use a very good internet connection to ship huge amount of data either into the cloud for storage and processing with the Kratos Quantum software, or to the customer MOC.

Kratos provides quantum as an integrated virtualized system supporting a satellite ground infrastructure architecture that is cloud and platform agnostic. Figure 11.25 provides a visualization for the system concept. All components are available separately to support an existing C2 solution or third-party ground network with existing signal processing and antenna resources. The quantum system includes:

- (1) quantumCMD for small spacecraft C2;



(2) quantumFEP that connects C2 systems to RF signal processing equipment: handling command and telemetry stream formatting, encryption/decryption devices, CCSDS processing, and network interfaces to either quantumRadio or third-party ground antenna networks;

(3) quantumRadio, the signal processing solution when C2 and digital front-end processing are already addressed;

(4) quantumMR, a mission receiver with dual wideband receive chains, DVB-S2 and CCSDS enabled, tunable, independent IFs, LDPC/Reed-Solomon Convolutional;

(5) quantumDRA for data recording, processing and routing application supporting CCSDS/non-CCSDS header and channel data routing with IP-based interfaces;

(6) quantumRX for wideband processing specifically tuned to streaming Earth observations in near-real time with 500 MHz bandwidth using Digital IF digitizers.

QuantumRadio is a purely software modem for RF signal processing on the ground or in the cloud. It can be accessed from anywhere via the web with no client software to maintain or install. QuantumRadio supports a wide range of uplink/downlink frequency bands at low to high data rates and has been tested for compatibility on a variety of widely used space radios.

By 2021, Kratos will be introducing a virtualized architecture solution called OpenSpace. As an enterprise level, end-to-end system, it will provide the SmallSat community the flexibility to scale on-demand as their operations grow in size and capability. By leveraging Digital IF over IP with time deterministic latency and software defined networks, OpenSpace will allow virtualized functions such as modems, channelizers, recorder and combiners to be orchestrated in a cloud environment. The virtual architecture will easily lend itself to upgrades and/or updates automatically, ensuring ongoing reliability and security. In addition, there will be the ability to test software releases in real-time, allowing ground equipment strings to be included in continuous integration and continuous delivery cycles. Software defined architectures are more agile, programmable, and automated, enabling the ground system to work in tandem with dynamic satellite payloads. By shifting from RF signals and analog equipment to a virtualized, IP-based infrastructure, orchestration can occur on the fly. Figure 11.26 provides an illustration of the OpenSpace architecture concept.



Figure 11.25: Visualization for the Kratos quantum system concept. Credit: Kratos.

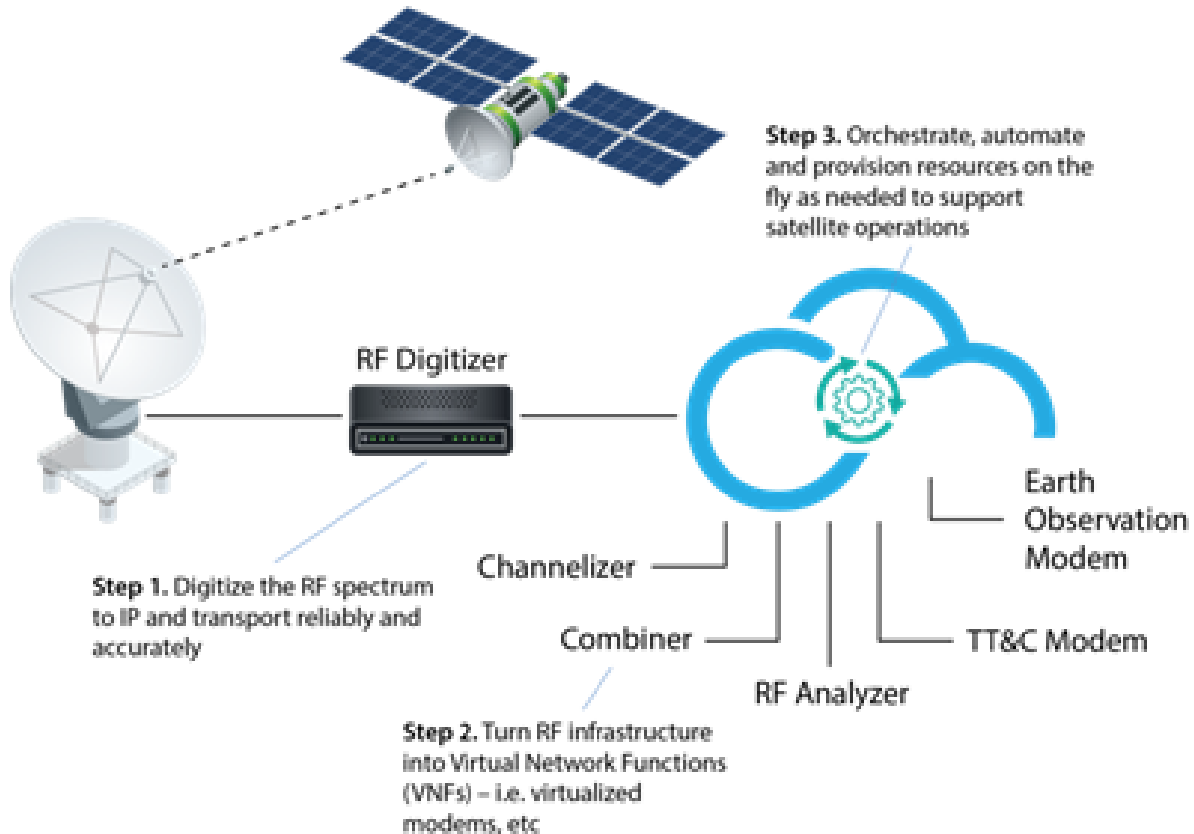
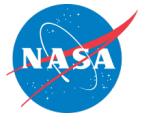


Figure 11.26: Kratos OpenSpace architecture concept. Credit: Kratos.

#### 11.9.4 Component Hardware for Ground Systems

The hardware for ground stations consists of the tracking antenna, its feed, and the modem that converts the RF waveform into digital packets and vice versa. This section lists additional options for purchasing these components and some supporting equipment. The antennas are deferred to the prior “end-to-end” solution section because the same companies that provide a complete solution also sell the individual subsystems such as the tracking antenna. The antenna feed which consists of the RF pickup, LNA and mechanical filters is located directly on the antenna. A radome is an RF transparent enclosure that protects the antenna from weather. While there are several component hardware providers in the market, table 11-9 lists example products in each category. Often overlooked is ground compatibility testing. The GAUSS ground station dongle is a USB low-power board that integrates both a low-power UHF transceiver and a TNC, thus miniaturizing common ground station rack systems. This is useful during the satellite I&T phase to exercise commands through the satellite radio.



<b>Table 11-9: Component Hardware for Ground Systems</b>			
<b>Product</b>	<b>Manufacturer</b>	<b>TRL</b>	<b>Type of Product</b>
Tracking Antenna	See End-to-End Hardware Section 11.9.3	9	Antennas for small satellites in UHF, VHF, and S-band frequencies
Antenna Feed	See End-to-End Hardware Section 11.9.3	9	RF pickup, mechanical filters, low noise amplifier
USRP X310	NI Ettus Research	9	Open source software defined radio. DC-6 GHz with up to 120 MHz of baseband bandwidth, multiple high-speed interfaces
SpectraNet	Kratos	9	Digital IF product that converts analog signals at RF frequencies up to S-band into digital IF packets. It is the start of the Kratos digital processing product line chain.
Radome	Infinite Technologies	9	Antenna radomes
Ground Station Dongle	GAUSS	9	A USB low-power board to simulate your ground station safely in laboratory conditions. The USB dongle integrates both a low-power UHF transceiver and a TNC, thus miniaturizing common ground station rack systems
Integrated Testing Systems (EGSE) & Ground Station TT&C Modems	Celestia Satellite Test & Simulation	9	Hardware and software elements all operating within a single reference platform and environment

### **USRP X310 Open-Source Software Defined Radio for SatCom Applications**

The NI Ettus Research brand is the world's leading supplier of software defined radio platforms, including the Universal Software Radio Peripheral (USRP™) family of products. The USRP is one of the most popular open platforms for small satellite communications with options from high-performance to low-cost to highly deployable. One of the most popular hardware units for satellite communication applications is the USRP X310 with the UBX RF daughterboard. The USRP X310 is a high-performance software defined radio with the ability to transmit and receive modulated signals. With up to 160 MHz of instantaneous bandwidth and a frequency tuning range up to 6 GHz, the X310 with UBX has the raw hardware performance to cover many ground station satellite communication needs. In addition to the wideband UBX daughterboard, many narrower band options are available. The USRP family supports a wide range of software tool chains from

LabVIEW to GNU Radio, with many existing IP modules for modulation and demodulation. The USRP X310 is intended for lab environments, however, it can be built in rugged weatherproof configurations. Many small satellite researchers are using the USRP as their ground station equipment for its adaptability with open-source software and its embedded FPGA pre-processing capability. With a vibrant and active community around software tool chains such as GNU Radio, USRPs are being used by home hobbyists and many of the largest space vehicle developers today.

### Kratos SpectraNet

SpectraNet is the only commercially available product of its kind that eliminates the distance constraints of RF transport by digitizing RF signals for transport over IP networks in a way that preserves both frequency and timing characteristics, and then uniquely restores the RF signals at their destination. By eliminating the distance constraints between antennas and signal processing equipment, this technology enables operators to deploy new ground architectures with numerous advantages, such as the ability to mitigate the effects of rain fade for Ku/Ka satellites, reduce costs by centralizing operations, simplify disaster recovery and system maintenance, optimize antenna placement, and develop a migration path toward virtual ground systems. SpectraNet does all of this while protecting the operator's current investment in existing equipment. Figure 11.27 illustrates the advantage of the SpectraNet over the conventional approach.

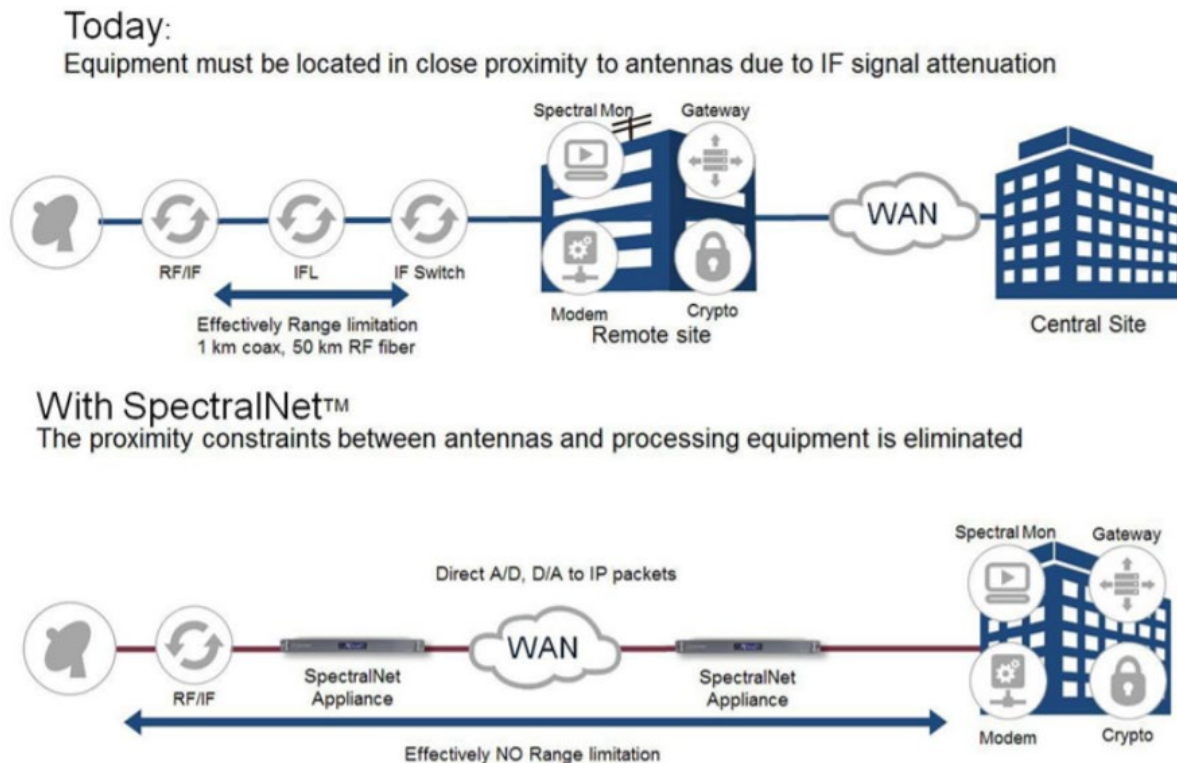


Figure 11.27: Kratos SpectraNet keeps most of the RF ground equipment remote from the ground station. Credit: Kratos.



## Infinite Technologies Radomes

A successfully designed radome provides a protective cover and has minimal effect on the electrical functionality of the antenna. Figure 11.28 provides an example of a radome supplied by Infinite Technologies. Radomes provide the antenna system with a controlled environment, shielding sensitive equipment from weather related stresses such as wind, snow, ice, salt spray, etc. A radome can increase the useful life of the antenna and decrease overall maintenance costs for the system. Consideration for a radome should be given early in the design phase of the system, as a radome will allow for lighter duty and less expensive components such as drive motors and foundations due to the elimination of wind loads on the antenna. Also, the controlled environment inside the radome provides greater system availability allowing the antenna to operate in more adverse environmental conditions with minimal signal degradation. A radome will also provide maintenance personnel protection from weather during antenna maintenance (12).

For a radome to be a benefit, the unique attributes of the system being protected must be taken into consideration. A well-designed radome addresses these factors and can avoid negatively affecting the performance of the antenna system. Careful selection of a radome can improve overall system performance and readiness by:

- Allowing operation in severe weather by protecting the antenna from wind, rain, snow, hail, sand, salt spray, insects, animals, UV damage, windblown debris, and wide temperature fluctuations
- Providing security for the antenna system and protecting it from observation, vandalism etc.
- Providing a controlled environment which minimizes downtime, extends component and system operating life
- Permitting the use of more economical antenna pedestals, foundations, and drive system components



Figure 11.28: Infinite Technologies small radome. Credit: Infinite Technologies.



### GAUSS UHF Mini Ground Dongle

GAUSS UHF Mini Ground Dongle, shown in figure 11.29, is a USB low-power board to simulate a ground station safely in laboratory conditions and expedite assembly, integration, and test procedures. The USB dongle integrates both a low-power UHF transceiver and a TNC, thus miniaturizing common ground station rack systems. It was designed to have easy access to TT&C testing during final verifications and pre-integration periods, but it can also be used on a ground station if an external power amplifier is added. It is fully compatible with the GAUSS UHF Radios. The dongle comes with multi-platform software and can be used with any PC/Mac. A special bundle includes both the radio and the Mini Ground Dongle for quick system deployment (13).



Figure 11.29: GAUSS UHF USB Mini Ground Dongle. Credit: GAUSS.

### Integrated Testing Systems & Ground Station TT&C Modems

Celestia Satellite Test & Simulation BV (C-STs) provides ground-based solutions in the domains of satellite simulation, testing, communication, and data processing. Established in 1985, Satellite Services B.V. (SSBV) was acquired by Celestia Technologies Group in 2016 and re-branded to Celestia Satellite Test & Simulation B.V. to continue as a competence center for Electrical Ground Support Equipment (EGSE) and TT&C solutions. Celestia STS has more than 30 years of experience in the space industry. More than 300 EGSEs and TT&C modems were delivered to space agencies, large system integrators, and specialized flight-equipment manufacturers around the world.

On-board computers, mass memory units, and transponders are tested every day with C-STs equipment. Celestia EGSE solutions have been used in more than 80% of all European Space Agency (ESA) missions. Celestia STS testing equipment is available in standard functionality or configured to meet specific customer needs. System options include:

- Telemetry and Telecommand Processing System
  - TM acquisition and simulation
  - TC generation and acquisition
  - Bit error rate tester
  - TC authentication
  - TM/TC deciphering (API/DLL/LAN)
  - Includes control and monitor software for data processing and visualization
- Wizardlink High-Rate Interface System
  - Up to 4 Wizardlink channels in parallel
  - Up to 2Gbps data rate per channel
  - Includes software for high speed ingest, processing, data archiving, and export
- LVDS High-Rate Interface System
  - Up to 4 parallel LVDS inputs and outputs
  - 8-bit parallel up to 1Gbps per channel
  - Teaming of 2 LVDS input and output channels to 16-bits



- 16-bit parallel up to 2Gbps per channel
- Includes software for high speed ingest, processing, data archiving, and export
- TT&C Integrated Modem and Baseband unit
  - Single or dual channel modulation and demodulation
  - Ranging measurement
  - Doppler simulation
  - Bit error rate tester
- Level Zero Processor Software for High-Speed Data Processing
  - Data directly from the local disk drive or shared network drive
  - Processing of TM data from bitstream to frame and packet level
  - Configurable frame and packet checking rules
  - Configurable frame and packet output data storage and sorting
  - Live frame and/or packet distribution via LAN
  - Real-time statistical analysis, error checking, and reporting
- Optical Digital Converter
  - Processing of optical detector signals to simulate optical communications

Efforts are on-going to improve product capability with a focus on modular, flexible, scalable multichannel systems that take advantage of the latest technologies. In June 2021, an agreement between the Netherlands Organization (TNO), Celestia, and the Netherlands Organization for Applied Scientific Research to commercialize optical modems (61).

#### 11.9.5 Ground Software

Software dominates the ground segment, replacing hardware solutions wherever possible. Advancements have been enabled by the speed of personal computers, the bandwidth of the internet, and the security and availability of cloud storage and cloud computing. The remaining essential hardware for ground stations are the tracking antennas, feeds, modem, and data storage drives. Everything else in between can be software. For example, computers are sufficiently capable that the front-end processors (FEP) can be software, as can the radio. Software outside the RF chain perform significant supporting tasks. They include visualizing and calculating the satellite location in orbit and controlling the tracking antenna. Command and control software manages command scripts to be sent to the satellite and can display and analyze telemetry. Many software options are open source and free. Other software are purchased from companies with a long history in ground segment solutions who had previously provided hardware products to do these tasks (table 11-10).

<b>Table 11-10: Software for Ground Systems</b>			
<b>Product</b>	<b>Manufacturer</b>	<b>TRL</b>	<b>Type of Product</b>
softFEP	AMERGINT	9	Emulation ground systems software
quantumFEP	Kratos	9	Software that performs data formatting and interface conversion for commands and telemetry, with full support for NSA Type 1 and AES encryption/decryption devices





Gpredict	Alexandru Csete	9	Open source software that tracks satellites and provides orbit prediction in real-time. Radio and antenna rotator control for autonomous tracking
GNU Radio	GNU Project	9	Free software development toolkit that provides signal processing blocks to implement software-defined radios and signal processing systems
HWCNTRL	DeWitt & Associates	9	Ground station control program with an automation software package

### **AMERGINT softFEP**

AMERGINT softFEP applications are deployed virtually on cloud architectures or hosted on dedicated servers. The applications perform control center data formatting and interface conversion for commands and telemetry, with full support for NSA Type 1 and AES encryption/decryption devices. SoftFEP applications are built on a proven library of more than 1,000 software devices. This allows each softFEP application to be tailored to the requirements specific to the ground system. Processing chains configured via Python scripts move satellite downlink data from Earth receipt for processing and uplink data to the radiating site. Deploying softFEP on multiple virtual machines (VMs) or within the cloud is inherent in the product architecture. Virtualized softFEP deployments support a wide range of ground system architectures while taking advantage of cloud-computing benefits. When applications are deployed in VMs, they can be hosted locally or run remotely in a cloud and interoperate across network connections. Customers have deployed their softFEP applications as independent network gateways, black front-end processors, red front-end processors, and data recorders, flowing data between the VMs as a satellite contact is processed (14).

### **Kratos quantumFEP**

The quantum FEP satellite front-end software provides the digital processing and network connectivity needed between the Command & Control (C2) system and the RF signal processing equipment. All the digital processing functions in a typical small satellite ground system are included: command and telemetry processing, recording, AES COMSEC security, CSSDS processing, packet level FEC, and network gateway interface support. Monitoring and control can be done using the HTML5 user interface or using REST or application programming interface GEMS APIs. Figure 11.30 provides an illustration for quantumFEP system architecture (15).

Key features of quantumFEP are:

- Can be used on bare metal machines, a private cloud, or with cloud provider
- Suitable for all types of SmallSat programs – SmallSats, CubeSats, NanoSats, and MicroSats
- Compatibility tested with widely used ground modems
- Built-in test functions reduce Integration and Test (I&T) effort – ultimately reducing cost
- Configurable as mission requirements change or as new missions come online
- Commercial AES Encryption/Decryption standard feature with built in AES Key Manager
- Standard TCP/IP, GEMS, REST and VITA-49 interfaces make integration a snap
- Pure Software Implementation for signal processing functions
- Access and control from anywhere through the web with no client software to install or maintain

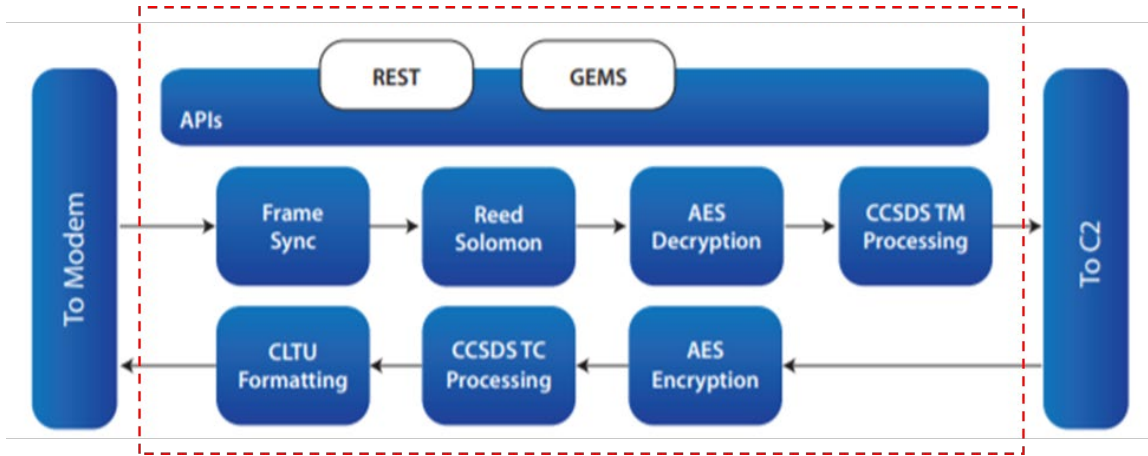


Figure 11.30: Kratos quantumFEP system architecture. Credit: Kratos.

## Gpredict

Gpredict is a real-time satellite tracking and orbit prediction application. It can track a large number of satellites and display their position and other data in lists, tables, maps, and polar plots (radar view) as shown in figure 11.31. It can also predict the time of future passes for a satellite and provide detailed information about each pass. Gpredict is different from other satellite tracking programs in that it allows the satellites to be grouped into visualization modules. Each of these modules can be configured independently from others, allowing unlimited flexibility in the look and feel of the modules. It will also allow satellite tracking relative to different observer locations at the same time (16).

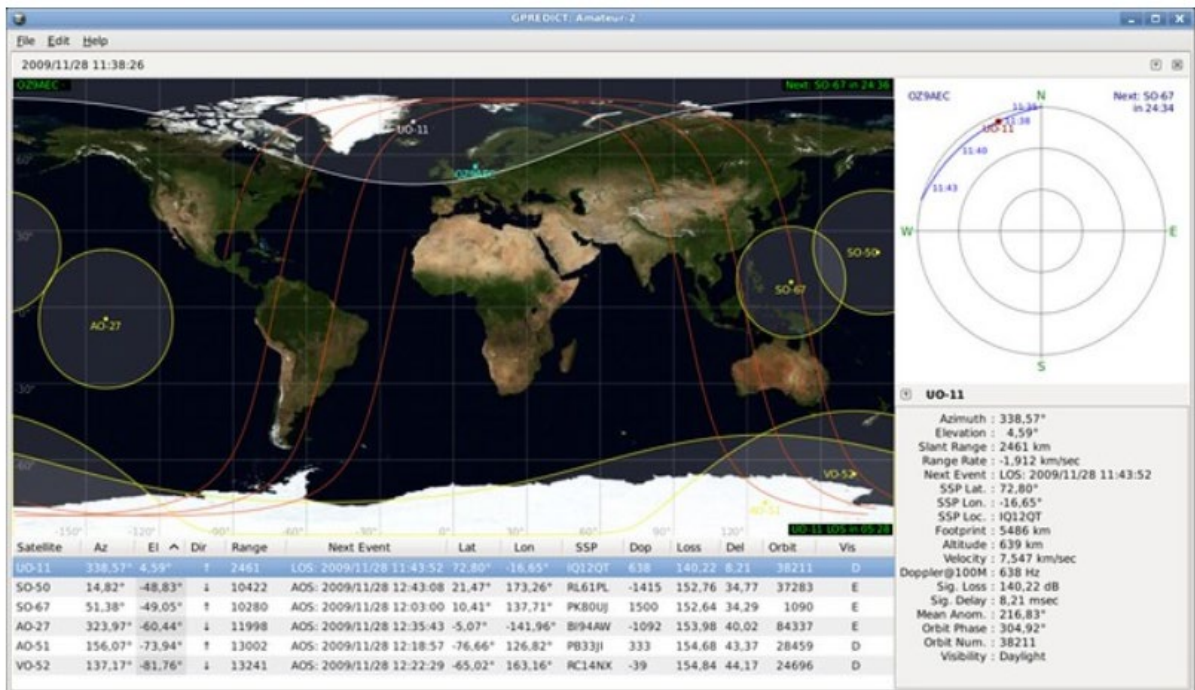


Figure 11.31: Gpredict graphical display with multiple satellites. Credit: Gpredict.



The following are key features of the software:

- Fast and accurate real-time satellite tracking using the NORAD SGP4/SDP4 algorithms
- No software limit on the number of satellites or ground stations
- Appealing visual presentation of the satellite data using maps, tables and polar plots (radar views)
- Allows satellites to be grouped into modules, each module having its own visual layout, and being customizable on its own. Of course, several modules can be used at the same time
- Radio and antenna rotator control for autonomous tracking
- Efficient and detailed predictions of future satellite passes. Prediction parameters and conditions can be fine-tuned by the user to allow both general and very specialized predictions
- Context sensitive pop-up menus allow future passes to be quickly predicted by clicking on any satellite
- Exhaustive configuration options allowing advanced users to customize both the functionality and look & feel of the program
- Automatic updates of the Keplerian Elements from the web via HTTP, FTP, or from local files
- With a robust design and multi-platform implementation, Gpredict can be integrated into modern computer desktop environments, including Linux, BSD, Windows, and Mac OS X
- As free software licensed under the terms and conditions of the GNU General Public License, it can be freely used, learned from, modified, and re-distributed

## GNU Radio

GNU Radio is a free & open-source software development toolkit for developing radio systems in software as opposed to completely in hardware. It can be used with readily available low-cost external RF hardware and runs on most modern computers to create software-defined radios. It can also be used without hardware in a simulation-like environment.

GNU Radio performs all the signal processing. It can be used to write applications to receive data out of digital streams or to push data into digital streams, which are then transmitted using

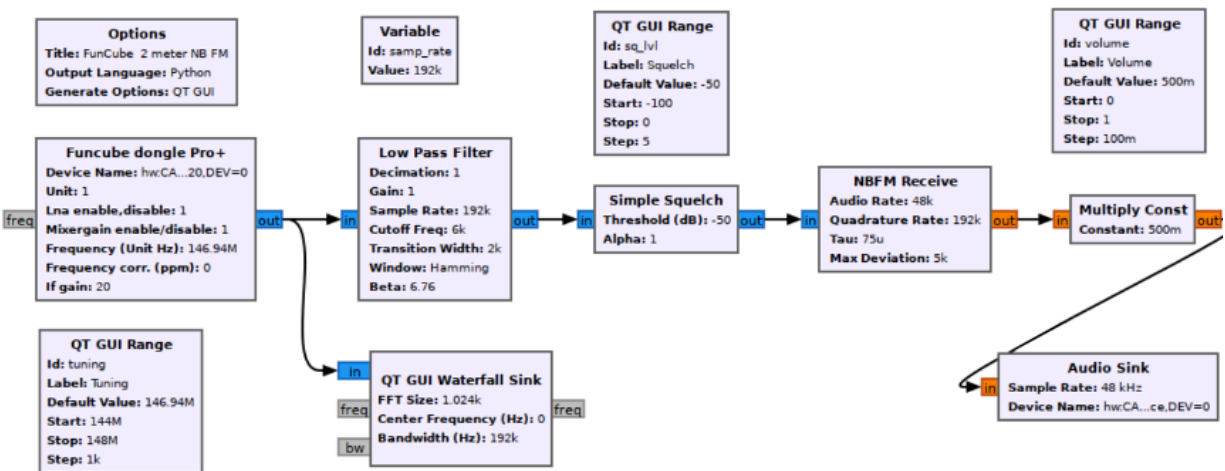


Figure 11.32: GNU Radio block diagram example for a 2-meter NBFM receiver. Credit: GNU Radio.



hardware. GNU Radio has filters, channel codes, synchronization elements, equalizers, demodulators, vocoders, decoders, and many other elements (referred to as *blocks*) typically found in radio systems. More importantly, it includes a method of connecting these blocks and then manages how data is passed from one block to another. Extending GNU Radio is also quite easy; if a specific block is found to be missing, it can be quickly created and added.

Since GNU Radio is software, it can only handle digital data. Usually, complex baseband samples are the input data type for receivers and the output data type for transmitters. Analog hardware is then used to shift the signal to the desired center frequency. That requirement aside, any data type can be passed from one block to another—be it bits, bytes, vectors, bursts, or more complex data types. Figure 11.32 shows an example GNU Radio block diagram (17).

## HWCNTRL

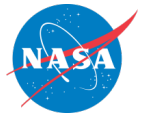
HWCNTRL is a satellite ground station control program that is installed in more than 30 sites throughout the world. This automation software package can support multiple antennas and instruments simultaneously. Satellite passes are generated by user request based on the ephemeris set, and users can select specific passes to be added to the schedule. Scheduled events can be single-use or reoccurring on a daily or weekly basis. A control/status screen is accessible for each instrument in the system, and the user can view and change the settings of any instrument through these screens (18).

### 11.9.6 Mission Operations & Scheduling Software

The following section provides an overview of mission operations and scheduling software products that can be integrated into a MOC (see table 11-11). While the specific aspects of each of these products is discussed below, they all have some common features. In general, these software applications cover functions related to mission scheduling and tasking, commanding and telemetry, and monitoring and control. Many of them also have automation features that enable “lights-out” operations or reduced manpower requirements.

All these products are highly customizable. They can not only adapt to multiple missions, satellites, and ground stations, but these products also allow for customized visualizations, analyses, and user interface views. Additionally, many of these products are cloud-based or have a web interface to enable easier access for an operator from almost anywhere.

<b>Product</b>	<b>Manufacturer</b>	<b>TRL</b>	<b>Type of Product</b>
COSMOS	Ball Aerospace	9	Open-source command and control system that can be used in all phases of testing and operations
Galaxy	The Hammers Company	9	Command and telemetry system that has been available since 2000
Major Tom	Kubos	8+	Cloud-based command and telemetry system that can interface with some COTS flight software



Orbit Logic Family of Products	Orbit Logic	9	Group of mission planning and scheduling products for both aerial and satellite imaging applications
ACE Premier Family of Products	Braxton Technologies	8+	Group of hardware and software components for end-to-end Satellite Operations Center (SOC)
Mission Control Software	Bright Ascension	8+	Monitoring and control interface with “lights-out” automation features built-in

**COSMOS**

COSMOS is a free, open-source command and control system providing commanding, scripting, and data visualization capabilities for embedded systems and systems of systems. COSMOS is intended for use during all phases of testing (board, box, and integrated system) and during operations. COSMOS is made up of 15 applications that can be grouped into four categories: real-time commanding and scripting; real-time telemetry visualization; offline analysis; and utilities. Figure 11.33 shows how all of the applications relate to one another and to the targets that are being controlled. Any embedded system that provides a communication interface can be connected to COSMOS. All real-time communications flow through the command and telemetry

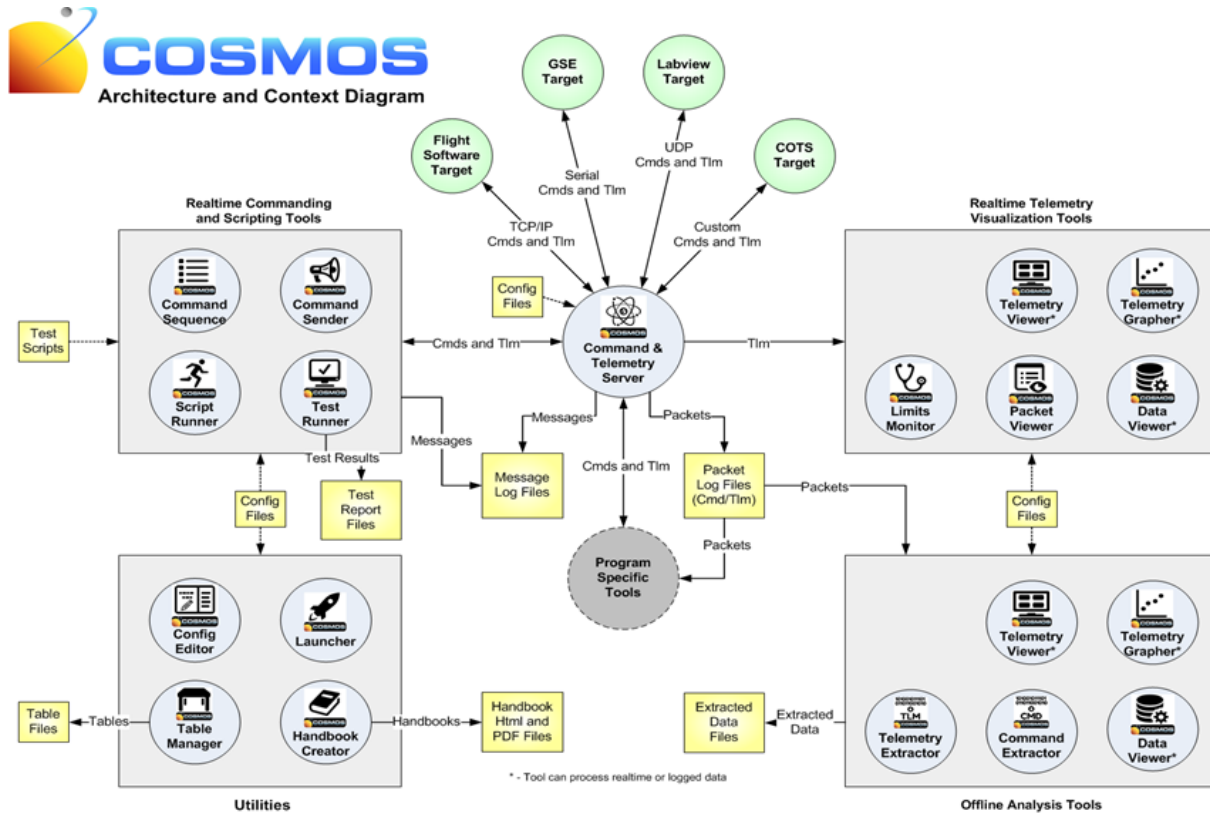


Figure 11.33: COSMOS architecture and context diagram. Credit: Ball Aerospace. <https://cosmosc2.com/>

server, ensuring all commands and telemetry are logged. Additionally, program specific tools can be written using the COSMOS libraries, and these tools can interact with the command and telemetry server as well (19).

## Galaxy

Galaxy is a command and telemetry system that is derived directly from the Integrated Test and Operations System (ITOS) telemetry and command system developed by the Hammers Company with NASA GSFC. It has been available commercially since 2000. Galaxy can accept telemetry from, and send commands to, multiple spacecraft and ground stations simultaneously. Users can customize Galaxy for a particular mission via a database in which they provide telemetry and command specifications. Users can design telemetry displays, plots, sequential prints, configuration monitors, and spacecraft commands and table loads in simple text files stored on the computer's file system. Most displays can be viewed remotely over the web or by using remote Galaxy instances. Additionally, Galaxy is CCSDS compliant, and it can communicate over a wide variety of transports and protocols including TCP/IP networking, synchronous and asynchronous serial ports, SpaceWire, military standard (MIL-STD-1553), and the GMSEC message bus (20).

## Major Tom

Major Tom is a commanding and telemetry system that allows operators to use the same tool, workflow, and processes during development, testing, and operations. Key features include simplified dashboards for commanding and telemetry data; an API that allows an operator to build custom automation; and the ability to support multi-satellite operations. Major Tom leverages a cloud-based deployment for simplicity and can be integrated with some COTS ground stations and flight software, including Kubos' own KubOS open-source flight software. Figure 11.34 provides a screenshot of the user interface (21).

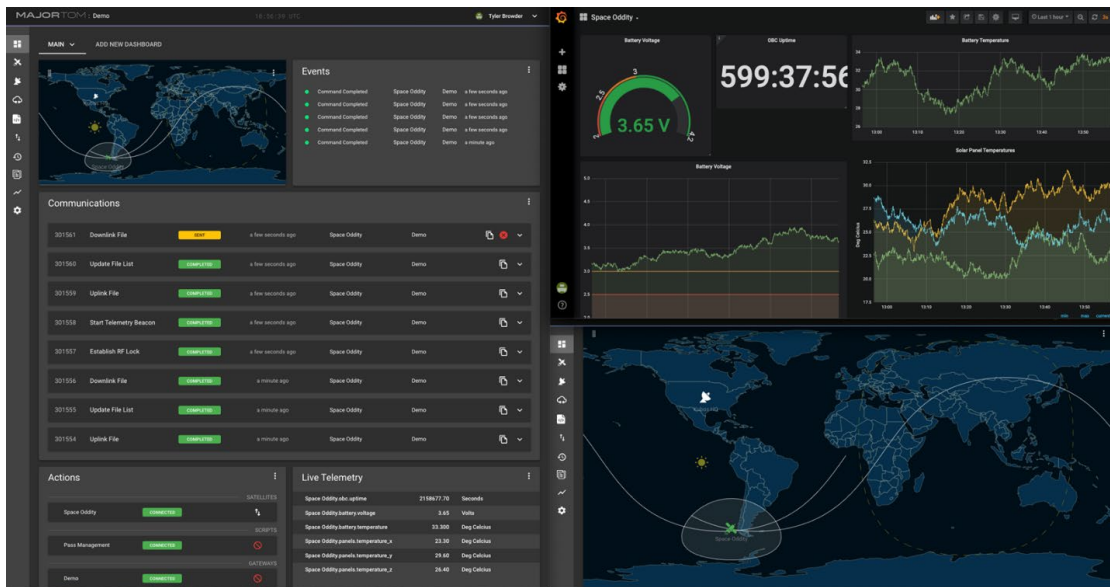


Figure 11.34: Major Tom user interface screenshot. Credit: Kubos.



## Orbit Logic Family of Products

Orbit Logic specializes in mission planning, scheduling, and space situational awareness software. The software suite consists of multiple applications that support analysis and operations for aerial and satellite imaging and space-to-ground networking. The mobile, web, desktop, and onboard scheduling applications have a variety of features, including: configurable systems, constraints, and goals; high performance algorithms; deconflicted scheduling plans; visualizations and animations on the user interface, and flexible process flows and automation. Figure 11.35 provides a screenshot for Orbit Logic's Collection Planning and Analysis Workstation (CPAW) (22).

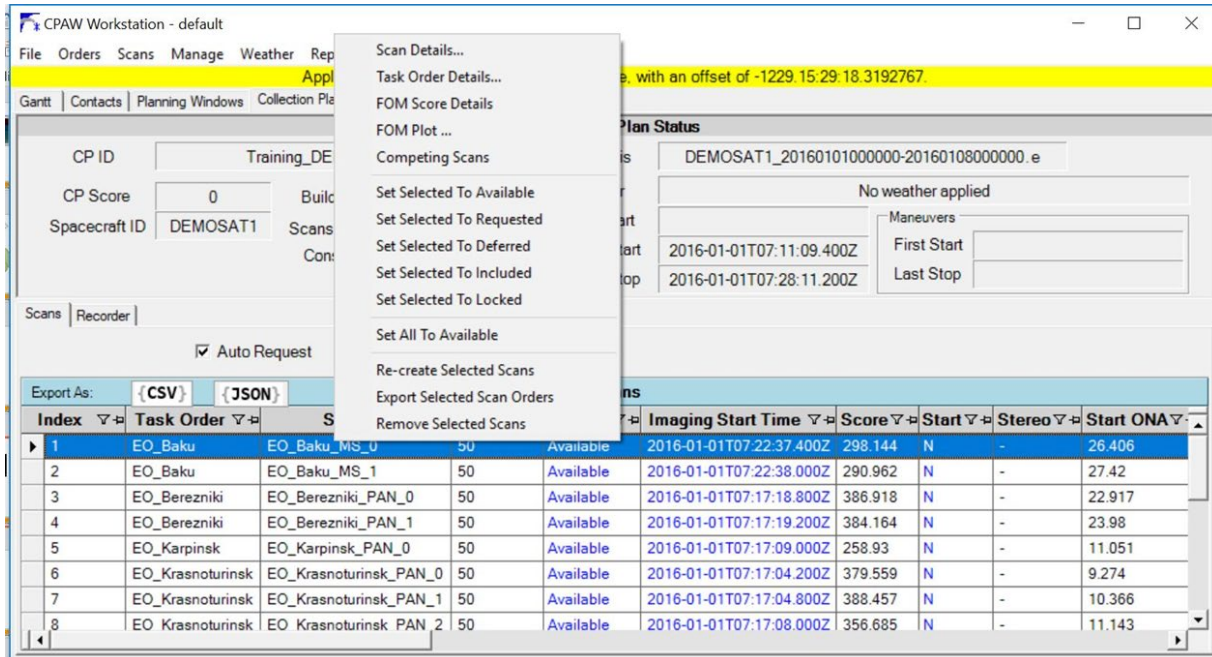


Figure 11.35: Orbit Logic CPAW couples spacecraft model and scheduling features to optimize data collection plans. Credit: Orbit Logic.

## ACE Premier Family of Products

The ACE Premier family of products from Braxton Technologies includes the hardware and software components necessary for a satellite MOC. Key applications include command and control, scheduling and resource optimization, flight dynamics and mission planning, situational awareness, factory compatibility testing, front-end communications processors, crypto integration and controllers, and spacecraft and ground simulation. These products can be delivered through COTS point solutions with mission-unique plug-ins, or as a turn-key system (23).

## Bright Ascension Mission Control Software

Bright Ascension's Mission Control Software (MCS) ground software provides a monitoring and control interface to implement changes during development and flight. An example of the interface is shown in figure 11.36. MCS consists of an integrated graphical environment with dedicated views and layouts that can be created, saved, and customized for different stages of the mission. MCS also supports a wide range of ground station interfaces and protocols to fit both in-house and commercial ground stations. Additionally, MCS includes automation features to enable unattended (or "lights-out") operations (24).

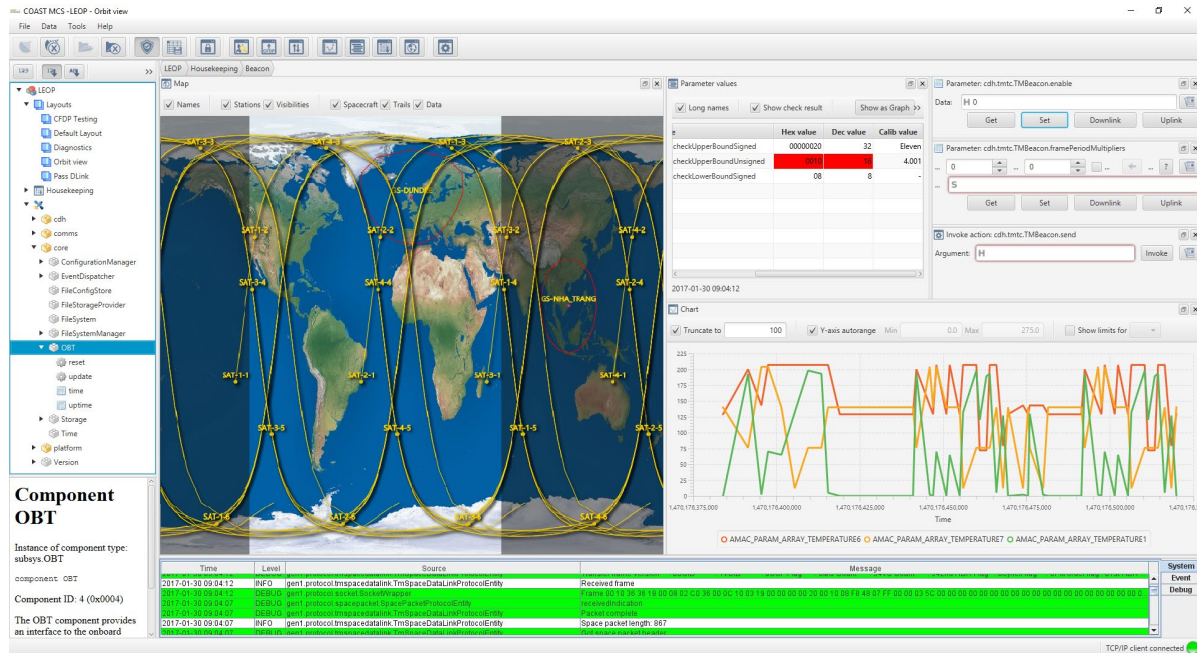


Figure 11.36: Bright Ascension Mission Control Software interface screenshot. Credit: Bright Ascension.

## 11.10 On the Horizon

Ground data systems must continue to evolve to keep up with the furious pace of small satellite technology. Advancements in onboard processing and data storage will demand more capability in getting data to the ground. Mass production of small satellites is quickly becoming a reality and large constellations are now starting to find their way to orbit. This will require ground system technology that can communicate with multiple satellites simultaneously. Optical communications and phased array ground systems are emerging solutions to these needs. While both technologies have seen years of investment, they are now just starting to find their way into the ground networks. While it may still be years before becoming a staple for these networks, the following sections provide insight to the state of these technologies and where they are headed in the future.

### 11.10.1 Optical Communications

Increasing demand for data from NASA missions has led to a migration over the past few decades to increasingly higher RF bands (X, K, and Ka) and ultimately to the optical and near-infrared regime. Optical communications are expected to increase data rates by two orders of magnitude (or more) over traditional RF links. The next generation systems will incorporate optical communications, and several early flight demonstrations and uses of optical communications in the coming decade are expected to be transformational for NASA and other space organizations. Whereas Ka-band frequencies go up to 40 GHz frequency, the optical signal reaches up to 200,000 GHz. Higher frequencies have the potential for huge increases in data rates, theoretically proportional to frequency-squared if all other factors are equal. At optical wavelengths, other factors, such as atmospheric losses, receiver sensitivity, aperture, and power, must also be considered, but nonetheless, optical communications offer the potential for orders of magnitude improvement in data throughput.





The term “optical communication” refers to the use of light as a medium for data transmission. For space applications, lasers are being used as the light source. Laser systems with dynamic systems such as fast-steering mirrors are used to accurately point the laser on the spacecraft to the ground terminal. Other methods using laser arrays for beam pointing are also being developed to reduce the need for complex dynamic systems. Data is transmitted in the form of hundreds of millions of short pulses of laser light every second. The light is made of photons and the optical ground terminals are setup to collect the light at the photon level. In fact, the ground terminals are designed for an environment where relatively few photons may be received from the transmitter spacecraft, especially from deep space. Direct photon detection with Pulse Position Modulation (PPM) is used instead of the common RF technique of direct carrier coherent modulation to convey information. PPM modulation uses a time interval that is divided into a number of possible pulse locations, but only a single pulse is placed in one of the possible positions, determined by the information being transmitted. To detect extremely faint optical signals with relatively few photons through the atmosphere, optical ground stations can use a superconducting nanowire single photon detector (SNSPD), which, to increase the sensitivity of the nanowires, uses a 1-Kelvin cryocooler. A real-time signal processing receiver uses time-stamped photon arrivals to synchronize, demodulate, decode, and de-interleave signals to extract information code-words. Hence, while the specific technologies employed differ in some respects from those used in radio frequency ground terminals, the higher-level functions performed by the optical communication ground terminal are similar.

Optical communication is attractive for mission designers using small, resource-constrained spacecraft, because it offers a path to relatively high data rates with relatively small, low-power spacecraft equipment. The same volume and power savings can be experienced on the ground terminal side as well. This is driven by the size of the wavelengths. Because RF wavelengths are longer, the size of their transmission beam covers a wider area, therefore, the capture antennas for RF data transmissions must be very large. Laser wavelengths are 10,000 times shorter, allowing data to be transmitted across narrower, tighter beams. This results in the ability to deliver the same amount of signal power to much smaller collecting areas. The reduction in antenna size applies for ground and space receivers, which allows for size and mass reductions on the spacecraft side.

In 2013, NASA made great strides with its optical communication demonstration on the Lunar Atmosphere and Dust Experiment Explorer (LADEE) mission. The pivotal NASA Lunar Laser Communications Demonstration (LLCD) was able to achieve 622 Mbps from a lunar distance. This success created a need for low size, weight, and power (SWaP) optical flight terminals for SmallSats and a ground infrastructure of Optical Ground Stations (OGS).

### **Optical Ground Stations and Future Demonstrations**

OGS contain notably different equipment than RF stations, including an optics assembly, photon counter assembly (usually involving a photon counting nanowire detector and cryostat), and signal processing assembly with a time-to-digital converter. Since optical communications use a frequency higher than RF, (e.g. 1,550 nm downlink and 1,065 nm uplink wavelengths), the optical dishes can be smaller than RF antennas. To receive optical signals from a low-Earth orbit, 40 – 60 cm telescopes are sufficient. For successful deep space optical communications, calculations show that 3 m, 4 m, or even 8 m diameter ground apertures are required, depending on the distance from Earth. For these size apertures, when a dedicated 3 – 8 m OGS is not available, partnerships can be formed with large astronomy telescopes. For example, the Deep Space Optical Communications (DSOC) demonstration launches in 2022, and JPL-designed OGS equipment is being housed at the Palomar Observatory (Hale 5-m telescope). It is also important

for OGS to have spatial diversity. Weather, atmospheric conditions, turbulence, and aerosols in the air can degrade laser propagation. Because certain types and depth of cloud covers can cause signal loss, probability of link success increases with multiple diverse locations.

For interoperability between SmallSats and public and private optical ground stations, a common communications standard is key. The Consultative Committee for Space Data Systems (CCSDS) is a member driven international organization, which provides recommendations for communications standards, including optical communications. Adhering to these standards by both SmallSats and ground stations allows the bring-your-own-receiver model to work.



Figure 11.37 JPL's OCTL showing a 1-meter optical aperture. Credit: NASA JPL.

JPL is operating the Optical Communications Telescope Laboratory (OCTL) at Table Mountain, CA, with a 1-m telescope, as shown in figure 11.37. This dish was used for the LADEE mission and offered great performance from a lunar distance.

ESA has a 1-m OGS with a  $0.7^\circ$  field of view at the Teide Observatory in Tenerife, Spain that was originally built for the observation of space debris. Figure 11.38 shows the ESA-OGS and its telescope.



Figure 11.38: (left) ESA-OGS at the Teide Observatory and (right) its 1-meter telescope on an English equatorial mount. Credit: (left) European Space Agency/D. Lopez and (right) European Space Agency.

The National Institute of Information and Communications Technology (NICT) operates several OGS that collectively form the IN-orbit and Networked Optical Ground Stations Experimental Verification Advanced Testbed (INNOVA). The INNOVA testbed includes a 1.5 m telescope and three 1-m telescopes. The 1.5 m was first constructed in 1988 in Koganei, Tokyo, Japan, and has a focal ratio of  $f/1.5$  and a 1.5 arcminute detector field of view. The 1 m telescopes have a focal ratio of  $f/12$ , multiple focus options, and have demonstrated closed-loop tracking for low-Earth orbit satellites to within 10 arcseconds. The three stations are in Koganei, Kasima, and Okinawa. Figure 11.39 shows an image of the 1 m OGS in Koganei, Japan.

The Deutsches Zentrum für Luft- und Raumfahrt (DLR) German Aerospace Center is another organization active in optical communications. About 25 km west of Munich, Germany is their Optical Ground Station Oberpfaffenhofen (OGS-OP) that houses a 40 cm Cassegrain telescope. The German Aerospace Center has also developed a transportable optical ground station (TOGS). It has a 60 cm deployable telescope in a Ritchey-Chretien-Cassegrain configuration with a focal ratio of  $f/2.5$ . The telescope is supported by an altazimuth mount on a structure with four adjustable legs for leveling the mount and compensating for rough terrain. It has been successfully used to track the OPALS instrument on the ISS and serves as the primary ground station for the OSIRIS payload on the BiROS satellite. The German Aerospace Center OGS-OP and TOGS are shown in figure 11.40.



Figure 11.39: NICT 1 m OGS in Koganei, Japan. Credit: NICT.

The Aerospace Corporation has an optical ground terminal in El Segundo, CA. It is a 40 cm diameter, 3 m focal length Ritchey-Chretien telescope with a Si-APD detector. The OGS and associated telescope are shown in figure 11.41. This ground



Figure 11.40: (left) OGS-OP and (right) TOGS. Credit: German Aerospace Center. <https://creativecommons.org/licenses/by/3.0/de/legalcode>.

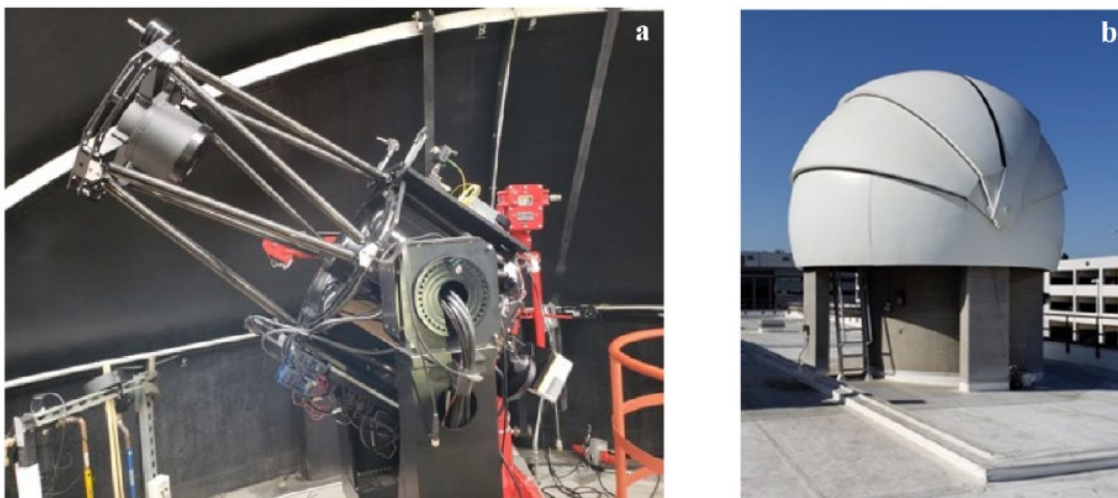


Figure 11.41: (left) The Aerospace Corporation manned OGS and (right) 40 cm telescope located in El Segundo, CA. Credit: The Aerospace Corporation.



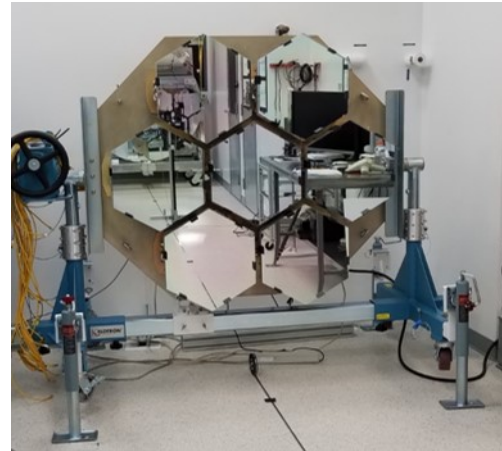
station is fully operational and validated, as a CubeSat optical link from low-Earth orbit to Earth of 200 Mbps was demonstrated in 2017 by the NASA sponsored OCSD mission. The 1.5U, 2.5 kg satellite used a 2 W, 1,064 nm laser transmitter 8 x 8 x 2 cm in size with a 0.06° FWHM beamwidth. While many optical communications demonstrations use a ground laser beacon to meet stringent pointing requirements, Aerospace demonstrated beaconless optical communications by body-steering the satellite open-loop at the optical ground station. Designing the laser transmitter with twice the divergence of the OCSD pointing capability eliminated the cost and complexity of a ground reference beacon. The optical communication typically lasted 2 – 3 minutes and engagements were optimized by limiting to 30° – 70° elevation. The best engagement on this mission demonstrated 200 Mbps and an average range of 725 km, lasted 115 seconds, and had a BER of  $\leq 1E-6$  for 92% of the time. This same CubeSat optical transmitter on the AeroCube-11 mission in 2019 demonstrated a 1 GB data transfer in a single optical pass. As of 2020, the El Segundo station must be manned during operation, which is inconvenient. For that reason and for geographic diversity, an unmanned station is being developed and is planned for deployment in Hawaii and New Mexico in 2021. The unmanned optical ground station has an automated dome that protects the telescope.

NASA has several exciting optical communications demonstrations in the pipeline, including O2O and the Laser Communications Relay Demonstration (LCRD). LCRD is supported by OGS1 at OCTL, and OGS2 in Hawaii. Currently, the Science Enabling Technology for Heliophysics (SETH) deep space demonstration mission is being proposed. The mission plans to transmit optically from an ESPA class SmallSat and yield data rates greater than 10 Mbps from 15 million km. The OGS in this case will be the 4.3-m Lowell Discovery Telescope (LDT), housing the transportable optical ground receiver elements designed for DSOC.

### **Optical Ground Stations in Development**

Internationally, optical ground station nodes in Australia and New Zealand are being funded as of 2020. The plan is to tie these stations together to produce a communication network that can support optical, RF, and future quantum communications. Kongsberg Satellite Services AS (KSAT) announced in April 2020 plans for a commercially available optical ground station with a 50 cm telescope, selecting Nemea, Greece as the site due to its moderate weather in the summer with 95% availability. In spring 2021, Thales Australia signed a research extension with SmartSat Cooperative Centre (CRC) for the development of advanced optical communications technologies building upon the initial feasibility work performed since early 2020 (62).

In the United States, NASA's JPL operates the DSN infrastructure, supporting 2-way RF communications and ranging services. Therefore, a novel design idea was approved to augment a DSN RF antenna by installing optical segments at its center, making it a dual-purpose, RF-Optical hybrid antenna. The operational RF-Optical hybrid will ultimately include 64 mirrors each of diameter 1.3 m, installed as a segmented 8 m optical receive aperture/mirror physically inside one of the new DSN 34-m radio frequency ground terminals (DSS-23, in California). The installation is being implemented in several phases.



*Figure 11.42: Prototype 7-segment mirror in lab testing at JPL. Credit: JPL.*

**First Phase:** before building the operational terminal, JPL is first developing a 7-mirror prototype, shown in figure 11.42, for field testing on the DSN research and development (R&D) 34 m antenna (DSS-13) at Goldstone, California. Each of the prototype's seven mirrors is 0.5 m diameter, for a combined equivalent area of about 1.3 m. The complete 7-element prototype system will be installed in the second half of FY20 in DSS-13 with the field testing carried out through end of FY21.

**Second Phase:** this phase includes procurement and assembly of the first 16-segment portion of the 64-segment operational system. This 16-segment portion will use 16 full-size 1.3 m mirrors, for an equivalent receive optical area of 4 m. The 16-segment system will be installed into DSS-23, a new operational 34 m radio antenna under development now in Goldstone, California. It will be ready for a year of field tests on DSS-23 starting in mid-FY24.

**Third Phase:** this phase includes completion of the full 64-segment aperture on DSS-23, as illustrated in figure 11.43, including a full year of field tests. This 8 m equivalent optical ground aperture will be operational in October 2027.

DSS-23 will then be capable of a full set of RF services with the 34 m antenna in addition to high-rate optical communications with its 8-m optical assembly. The RF services on DSS-23 will be operational starting in late 2024. Before the full operational readiness dates for optical communications, the above partial optical systems will be usable at various times for best effort demonstration optical communications passes in the near-Earth or Lunar regimes, as well as for deep space missions, such as Psyche, which will carry a full-fledged DSOC flight terminal.



*Figure 11.43: Artist overlay of built DSN RF antenna and planned optical segments at its center. Credit: NASA.*

The approach of using the R&D DSS-13 antenna for the early optical ground terminal prototyping and field testing, followed by deployment and final testing in the operational DSN aperture, enables a cost-effective implementation that minimizes schedule as well as development risk for the entire effort. There will be a single operational optical receiver on DSS-23 as the prototype



system on the R&D antenna is very limited in capability. The DSS-23 optical receiver is the same design that JPL is delivering to the Palomar Observatory for use with the DSOC optical communications technology demonstration on the NASA Psyche mission. This receiver is also being installed in ground terminals at White Sands and other locations for other near- and deep-space missions, as well as Artemis. One exciting implication of this 8 m equivalent optical aperture is that it meets the 230 Mbps downlink data rate requirement for human exploration of Mars.

### **11.10.2 Phased Array Ground Stations**

Phased array ground stations use phased array antennas consisting of multiple smaller antenna elements that are electronically connected at a site. These antenna elements each have computer-controlled phase delays that can be manipulated to increase the overall antenna gain in one or more specified directions. A phased array can be “electronically steered,” as opposed to mechanically pointed. In addition to optimizing antenna gain (for transmit or receive, or both) in specified directions, phased arrays can communicate with multiple spacecraft at once, and at multiple frequencies. Phased arrays have a long tradition of use for military applications, where the ability to rapidly point, steer, or scan can be essential. Past and current generations of GPS have transmit phased arrays of a dozen or more elements to optimally control their Earth-directed beams. Phased arrays on the ground can be optimized to increase gain in the direction of one or more SmallSats, which may be very resource constrained and hence can benefit from the increase in sensitivity of relatively small ground antenna system elements.

The number of NASA sponsored SmallSat missions is expected to continue to grow rapidly in the next decade and beyond. In response to this trend, the NASA NEN is working to better understand the characteristics and requirements of these missions and how it can evolve its service offerings to provide effective and efficient support with reduced network loading and lower cost to customers. The NEN and collaborating universities are investigating whether new service offerings such as multiple spacecraft per aperture (MSPA), ground-based phased array antennas, ground-based antenna arraying, and other emerging capabilities are cost effective and could be technically supported to benefit these SmallSat missions.

According to the NEN’s investigation, some mission planners are moving towards formation flying SmallSats for multiple reasons, including lower cost per launch, the inherent redundancy multiple spacecraft provide, and for specific scientific objectives. The use of MSPA and/or ground-based phased array antennas could instead be used to support multiple SmallSats simultaneously from a single asset. Additional ground-based antenna arrays could increase the achievable data rate by two times or more for longer distances from Earth.

The NEN is currently considering partnerships with industry and universities to conduct future demonstrations of Ground Based Phase Array (GBPA) technology. Similar to MSPA technology, GBPA could afford the NEN the ability to support multiple spacecraft simultaneously from a single system. The goal of a future demonstration would be to develop a GBPA that is equivalent to at least a 6-m antenna and capable of supporting five to six satellites simultaneously. Future demonstrations can begin to investigate a comparison between a GBPA and the traditional multiple aperture approach in the areas of performance, capability, cost, and operations.

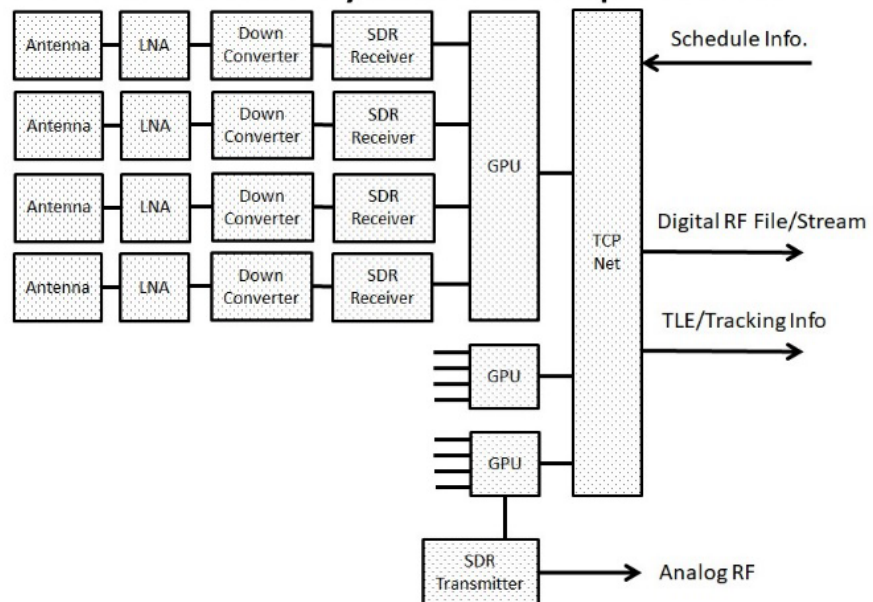
ATLAS Space Operations, Inc. has designed a mobile, rapidly deployable, ground-based electrically-steered array (GBESA) RF antenna system for satellite communications applications, as shown in figure 11.44. ATLAS LINKS array technology consists of an array of receivers, each with multiple antennas that can receive signals from multiple sources across the entire sky without requiring moving parts or phase shift hardware. In a GBESA, phase shifts and gain changes due to spatial effects are compensated for in software. When configured as an array, the ATLAS LINKS system can process multiple satellite signals simultaneously. The array has overlapping views of the entire sky which are then combined using spatial filters to reconstruct a signal as if the array were electrically pointed at a target. The number of digitally formed beams depends upon the computing power rather than the number of antennas and phase shift hardware. It is the algorithm combination of phase and gain diversity that distinguishes a GBESA from a phased array, where the former has the potential to match the performance of parabolic dish antennas. The lack of moving parts and the ease of assembly gives LINKS antenna array a distinct advantage over large dish antennas. COTS components were used for its manufacturing, which makes it highly cost competitive as well.



Figure 11.44: ATLAS ground based electrically steered array antenna system. Credit: NASA.

As shown in figure 11.45, each antenna unit consists of log-periodic antennas, software defined radios, and a down converter for processing of higher frequency signals. A four-antenna unit along with a CPU/GPU box with power and USB cables makes up one element. Mechanically, the arrangement is compact, enabling whole sky coverage from a human-portable unit. The design follows the computing-at-the-edge paradigm by combining the signals from all four antennas into a single output stream that is then fed as digital data to the next 4-antenna element. Each element holds its own schedule and can record satellite passes even if the network is down.

### ATLAS Links: System components



A two-radio system was tested at the NASA Goddard Compatibility Test

Figure 11.45: ATLAS LINKS single element system components diagram. Credit: ATLAS Space Operations.



Lab in early 2018. Signal strength and noise levels were varied to emulate a wide range of satellite/ground ranges and geometries. A PRN BERT signal was generated and split using two channel simulators that provide delay and attenuation to match the properties of a satellite signal traveling to two ground antennas. The two outputs of the channel simulators, collectively termed “reference” signals, were independently measured for BER and  $E_b/N_0$ . The one output of the LINKS array was also assessed, with comparison results shown in figure 11.46.

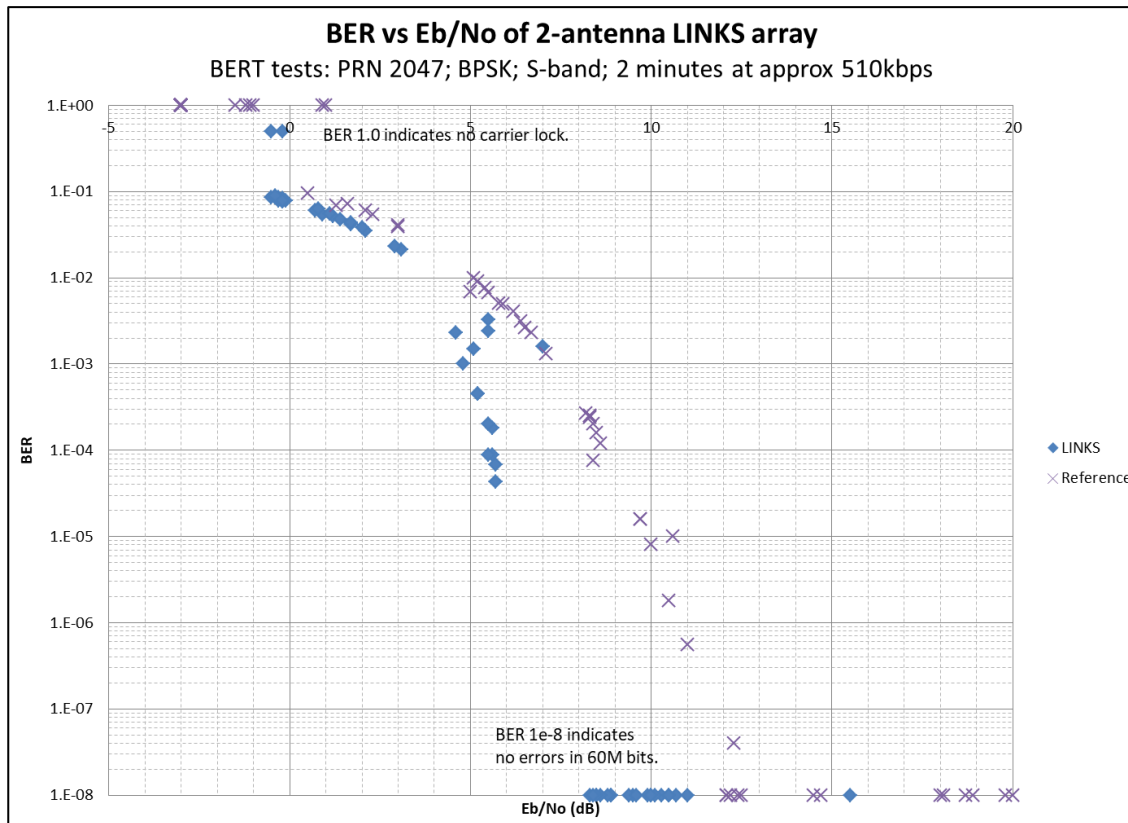
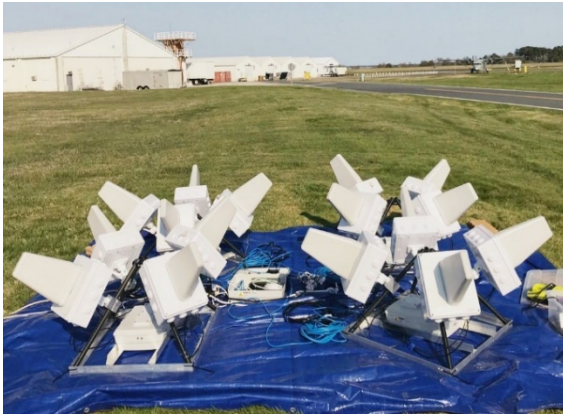


Figure 11.46: BER vs  $E_b/N_0$  chart of ATLAS LINKS for S-band coded downlink. Credit: ATLAS Space Operations.

Each of the two reference signals are plotted with X's. Their shape adheres well to the theoretical BPSK BER curve (not shown). The LINKS results, displayed as diamonds, shows a different curve as opposed to the observed reference. The LINKS system combines power, as does a phased array, and reshapes the noise distribution. The spatial filter process inherent to LINKS redistributes the random noise power giving it an asymmetrical, non-Gaussian distribution. Further, the LINKS time alignment algorithm works holistically to both align signals and cancel noise. Redistribution removes energy between the I/Q constellation points, reducing false positive bit assignments, improving BER. Evidence of the reshaping is seen where LINKS achieved a perfect BER with 4 dB lower  $E_b/N_0$  (a nominal value of  $1 \times 10^{-8}$  is chosen for plotting purposes) than any reference signal. LINKS is a GBESA, being unlike a phased array in that it brings not only phase but also gain information to the combining process resulting in an improved BER vs  $E_b/N_0$  curve.

ATLAS performed a demonstration at NASA WFF in April 2018 with a four-element (16 radio) array, as shown in figure 11.47, where it successfully downlinked satellite passes from four



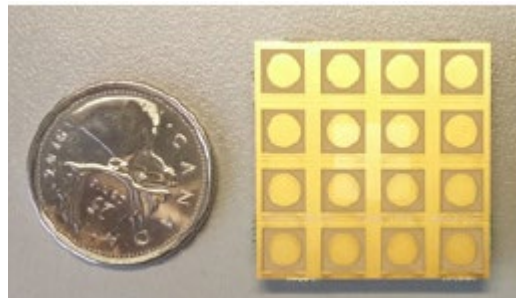


*Figure 11.47: (left) ATLAS LINKS Demonstration at NASA Wallops Flight Facility and (right) ATLAS T2 Array. Credit: ATLAS Space Operations.*

representative satellites. ATLAS is currently working with the Department of Defense's Defense Innovation Unit (DIU) to further test and develop LINKS. The competitively awarded rapid prototyping program occurred in the summer of 2020.

In addition to ATLAS, there are a number of other companies working to lead the way in phased array technology development. ALCAN Systems is developing a fully electronically steerable flat panel antenna. The main advantage of the technology is the use of liquid crystal within the antenna. This enables the product to be lower cost and perform at lower power. The current focus is to accommodate Ka-band for supporting satellite constellations in low-Earth orbit and MEO, but other bands are possible. The antenna is a modular design such that it can be combined and achieve higher gain/throughput based on customer needs. The single antenna can achieve throughputs in excess of 400 Mbps. It has a size of 55 x 99 x 9 cm, weighs less than 20 kg, consumes less than 100 W, and can operate across a wide scan angle of +/- 55°. ALCAN is working with its partners to build a mass-production supply chain and assembly capability for the antenna, targeting first customer deliveries by Q4 2021.

C-COM Satellite Systems is also developing a Ka-band flat panel antenna that is fully electronically steered. Their solution uses 4 x 4 groups of modular antennas, which can be scaled up to 16 x 16 or larger arrays of antennas. Their objective is to be able to replace a mechanically steered parabolic antenna of 70 – 75 cm in diameter. This would require a flat panel to be constructed of 4,000 elements for Tx and Rx. The advantage of their technology is that it is modular and can be scaled to any size depending on application requirements. It is also conformal and can follow the shape of the surface from which it's intended to operate. The antennas are also smaller, lighter, and can easily be used on the move. 4 x 4 sub arrays, as shown in figure 11.48, have been tested successfully and C-COM has recently received a patent for their unique method of calibrating the arrays. Successful tests were performed over Telesat Anik F3 satellite in spring 2021 (63).



*Figure 11.48: C-COM 4x4 Rx module with 16 elements. Credit: C-COM.*



Phasor, who was recently acquired by Hanwha Systems, is working towards the commercial introduction of its “Release One” technology-based products that showcase flat panel electrically steered arrays. Their systems are designed for the enterprise-grade SATCOM mobility markets in the commercial Ku-band. Their electrically steered arrays will work with satellites in any network configuration and support traditional GEO and nontraditional low-Earth orbit and MEO satellite constellations. Their technology is solid-state with no moving parts. The arrays use a unique and patented ASIC-based beam-forming technology and software defined systems approach that allows for very high performance, a very low profile, and a scalable, modular aperture to accommodate aperture sizes of various dimensions. The design can match the performance of a 2.4-m dish or greater and deliver gain-to-noise-temperatures greater than 20 dB/K and effective isotropic radiated power (EIRP) greater than 70 dBW.

ThinKom Solutions Inc has a patented phased array technology called Variable Inclination Continuous Transverse Stub (VICTS). VICTS delivers all the benefits of conventional mechanical and electrically steered phased array antennas but without their well-known drawbacks and limitations. This technology provides gap-free pole-to-pole coverage, high



*Figure 11.49: ThinKom Ku-band ThinAir Ku3030. Credit: ThinKom.*

beam agility for network flexibility, a low profile antenna radome, low prime power consumption, and a high spectral efficiency. The VICTS antennas are fully proven with over 5,000 daily commercial flights on 1,300+ commercial aircraft. They are also interoperable with low-Earth orbit, MEO, and GEO satellite constellations. In the first quarter of 2020, ThinKom completed a series of interoperability tests that demonstrated compatibility of its VICTS technology on their Ku-band Ku3030 system, shown in figure 11.49, with a low-Earth orbit satellite network. The switch time between individual satellite beams was less than 100 milliseconds and handoffs between satellites were completed in less than one second. Switches between low-Earth orbit and GEO satellites were also achieved with similar results. The measured terminal performance showed throughput rates in excess of 350 Mbps downlink and 125 MBps uplink at latencies of less than 50 ms. Tests have also been successfully conducted over the past 12 months with their Ku- and Ka-band COTS phased array aero antennas across commercial and military bands and a wide range of GEO and non-geostationary satellites. In all cases, the antennas have consistently demonstrated high throughput operation and rapid reliable handoffs, including both intra- and inter-satellite switching.

### **11.11 Summary**

The ground segment serves as the gateway to getting valuable data collected by the satellite into the hands of the user. It is a critical component of the satellite system that requires attention at the earliest stages of mission planning. Understanding what ground solution best meets the needs of the mission has a direct impact on the spacecraft design, concept of operations, launch schedule, mission operations cost, and expected data volume for processing. Much effort also goes into preparing for the interaction between the satellite and ground network. Developing software and simulations, drafting operations manuals, conducting operations rehearsals, and performing compatibility tests are all par for the course. Post launch, the ground station also plays a key role in locating and commissioning the spacecraft.



The primary ground system options to consider are either operating your own ground station and managing its legal, maintenance, and labor factors, or purchasing time on an established turnkey network that shares resources amongst users. The former may best serve a professional institution that has a consistent influx of satellite missions to manage, or the university environment because it is an excellent learning platform for students, while the latter may best serve a customer solely interested in obtaining data. The two options can also be combined to meet broader mission needs. With the sharp increase in small satellites and the possibility of thousands more, the market for turnkey solutions is plentiful and competitive with companies like Amazon getting into the mix. This environment is favorable to the community as it drives down cost, provides an array of service options, and spurs innovation.

In looking forward to the future of ground systems, the clear objective is how to bring the data down more efficiently. Great strides are being made with optical communications where it is possible to have increases in data per pass that are orders of magnitude above what can be achieved with RF communications. Optical communication technology is now being infused into ground system architectures, and flight hardware is becoming miniaturized enough to fit within small satellites. Phased array antenna technologies continue to advance with the goal of becoming more affordable. The ability of these systems to quickly change beam directions and acquire multiple targets will be critical for communicating with constellations of small satellites.

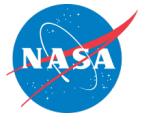
Even with the implementation of these advanced technologies, RF systems are expected to continue being part of the architecture. Optical communications have precise pointing requirements, sensitivity to weather, and other operational considerations that present risk to a mission. RF systems are a suitable mitigation to support emergency situations and safe modes. They can provide a path to transmitting critical commands even if the spacecraft is not capable of orienting itself, as long as there is a low gain antenna-radio system onboard and a large ground antenna with a high-power transmitter available.

While the tried and true RF ground system solution remains the workhorse for small satellites, the innovative nature of the small satellite platform will soon challenge the community to adapt to systems capable of handling hundreds of satellites and high data volumes. Efforts are ongoing to keep pace, but only time will tell whether ground systems will advance or impede the small satellite revolution.

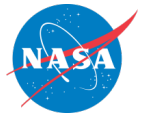
For feedback solicitation, please e-mail: [arc-sst-soa@mail.nasa.gov](mailto:arc-sst-soa@mail.nasa.gov). Please include a business e-mail so someone may contact you further.

## References

- (1) Amazon. AWS Ground Station Features. AWS. [Online] 2020. <https://aws.amazon.com/ground-station/features/>.
- (2) Globalstar. GLOBALSTAR SATELLITE IoT. *Globalstar*. [Online] 2020. <https://www.globalstar.com/en-us/>.
- (3) Teles, J., Samii, M. V. and Doll, C. E.: "Overview of TDRSS." *Advanced Space Res.* Vol. 16. pp. 1267-1276, s.l. 1995.
- (4) NASA. Tracking and Data Relay Satellite (TDRS). *Tracking and Data Reply*. [Online] 09 17, 2017. [https://www.nasa.gov/directorates/heo/scan/services/networks/tdrs\\_main](https://www.nasa.gov/directorates/heo/scan/services/networks/tdrs_main).
- (5) Analytical Space. UNLOCK THE POWER OF DATA FROM SPACE. *Analytical Space*. [Online] 2020. <https://www.analyticalspace.com/>.



- (6) Iridium. Global Network. *Iridium*. [Online] <https://www.iridium.com/network/globalnetwork/>.
- (7) GSAT. Iridium Satellite Location Map Tool . [Online] 2020. <https://www.gsat.us/tools/iridium-satellite-location-map-tool>.
- (8) GAUSS SRL. Ground Station. *Group of Astrodynamics for the Use of Space Systems (G.A.U.S.S. Srl)*. [Online] 2020. <https://www.gaussteam.com/services/ground-station/>.
- (9) Innovative Solutions in Space. Ground Stations. *Innovative Solutions in Space: Ground Stations*. [Online] 2020. <https://www.isispace.nl/products/ground-stations/>.
- (10) GomSpace. Ground Systems. *GomSpace*. [Online] 2020. <https://gomspace.com/shop/subsystems/ground-systems/default.aspx>.
- (11) Surrey Satellite Technology Ltd. Ground Segment. [Online] 2020. <https://www.sstl.co.uk/media-hub/featured/ground-segment>.
- (12) Infinite Technologies Incorporated. RADOMES FUNCTION. *Radomes & Composite Structures*. [Online] 2020. <https://compositeradomes.com/radomes/what-is-a-radomes-function/>.
- (13) GUASS SRL. GAUSS UHFMini Ground Dongle Datasheet. 2020.
- (14) Amergint Technologies. softFEP Datasheet. 2020.
- (15) Kratos. Software Front End Processer Datasheet. 2020.
- (16) Csete, Alexandru. About Gpredict. [Online] <http://gpredict.oz9aec.net/>.
- (17) GNU Radio. GNU Radio - Main Page. *Wikipedia*. [Online] [https://wiki.gnuradio.org/index.php/Main\\_Page](https://wiki.gnuradio.org/index.php/Main_Page).
- (18) DeWitt, Henry. Satellite Ground Station Control. *DeWitt & Associates*. [Online] 2020. <http://www.dewitt-assoc.com/groundStation.html>.
- (19) Ball Aerospace. The User Interface for Command and Control of Embedded Systems. *COSMOS*. [Online] 2020. <https://cosmosrb.com/>.
- (20) The Hammers Company. Galaxy. [Online] 2020. <https://hammers.com/galaxy>.
- (21) Kubos. Major Tom. [Online] 2020. <https://www.kubos.com/majortom/>.
- (22) Orbit Logic. Orbit Logic. [Online] 2020. <https://www.orbitlogic.com/index.html>.
- (23) Braxton. ACE Premier™ Family of Products. [Online] 2020. <https://www.braxtontech.com/products-services>.
- (24) Bright Ascension. Mission Control Software. [Online] 2020. <https://www.brightascension.com/products/ground-control-software/>.
- (25) IceCube — 874 GHz submillimeter wave radiometer mission on a 3U CubeSat. [Online]. <https://directory.eoportal.org/web/eoportal/satellite-missions/i/icecube>



- (26) Near Earth Network (NEN) CubeSat Communications. NASA Technical Reports Server. [Online] January 1, 2017, <https://ntrs.nasa.gov/search.jsp?R=20170000974>.
- (27) Shannon Terry, A.I. Solutions, Inc. What are Space Ground Systems. [Online] <https://ai-solutions.com/about-us/news-multimedia/what-are-space-ground-systems/>.
- (28) Streamlining Ground Station Network Compatibility Test for Small Satellites. <https://ntrs.nasa.gov/archive/nasa/casi.ntrs.nasa.gov/20180003437.pdf>
- (29) Important Questions and Answers: Satellite Access. Satellite Communication, Chapter: Satellite Communication - Satellite Access. [Online] [http://www.brainkart.com/article/Important-Questions-and-Answers--Satellite-Access\\_11944/](http://www.brainkart.com/article/Important-Questions-and-Answers--Satellite-Access_11944/) [Accessed: 2020]
- (30) "Real-time Earth: A Hybrid Ground & Space Communications Network for SmallSats". Viasat. [Online] 2018. [https://www.viasat.com/sites/default/files/media/documents/viasat\\_real-time\\_earth\\_brochure.pdf](https://www.viasat.com/sites/default/files/media/documents/viasat_real-time_earth_brochure.pdf) [Accessed: 2020]
- (31) antenna-theory.com. Yagi-Uda Antenna. [Online] 2018. <http://www.antenna-theory.com/antennas/travelling/yagi.php> [Accessed: 2020]
- (32) "The Parabolic Reflector Antenna (Satellite Dish)" (2011). <http://www.antenna-theory.com/antennas/reflectors/dish.php> [Accessed: 2020]
- (33) Bill Sepmeier. "Understanding and Performing Satellite Link Budgets". NSN Network Services. <http://tjj.org/issues/issues/spring97/communications/nsn/linkbudget.html>
- (34) Bernardo Schneiderman. Industry Trends - News Analysis - Market Intelligence and Opportunities Executive Roundtable: Flat Panel Antennas. September 3, 2019. <http://satellitemarkets.com/people/executive-roundtable-flat-panel-antennas> [Accessed 2020]
- (35) 15 June 2020 by Alcan Systems. ALCAN announces electronic beam steering ground antenna for LEO and MEO satellite service use at a low price of EUR 1,500. Spacewatch.global: Space: Entrepreneurship. <https://spacewatch.global/2020/06/alcan-announces-electronic-beam-steering-ground-antenna-for-leo-and-meo-satellite-service-use-at-a-low-price-of-eur-1500/> [Accessed: 2020]
- (36) ThinKom PR, April 30, 2020 In Press Releases, ThinAir ThinKom Completes Successful Antenna Interoperability Demonstrations on Ku-Band LEO Satellite Constellation <https://www.thinkom.com/ku-band-leo-interoperability/> [Accessed: 2020]
- (37) Craig Bamford January 8, 2020. C-COM Finding its Place in Phased Array Satellite Communications Market.



<https://spaceq.ca/c-com-finding-its-place-in-phased-array-satellite-communications-market/>

[Accessed: 2020]

- (38) Florian Moll, Amita Shrestha, Christian Fuchs. Ground stations for aeronautical and space laser communications at German Aerospace Center. Publisher: Proc. SPIE 9647, Advanced Free-Space Optical Communication Techniques and Applications.

<https://core.ac.uk/reader/31021696>

- (39) ESA Optical Ground Station. Lasted updated: 13 November 2019. Accessed: 2020

[https://en.wikipedia.org/wiki/ESA\\_Optical\\_Ground\\_Station](https://en.wikipedia.org/wiki/ESA_Optical_Ground_Station)

- (40) NASA. Lunar Laser Communication Demonstration: NASA's First Space Laser Communication System Demonstration Fact Sheet

[https://www.nasa.gov/sites/default/files/llcdfactsheet.final\\_web.pdf](https://www.nasa.gov/sites/default/files/llcdfactsheet.final_web.pdf)

- (41) Space Optical Communications Using Laser Beams. NASA Fact Sheet.

<https://technology.nasa.gov/patent/TOP2-248>

- (42) NASA. July 15, 2018. "LLCD: 2013-2014". [Accessed: 2020]

<https://www.nasa.gov/directorates/heo/scan/opticalcommunications/llcd/>

- (43) Fuchs, Christian & Giggenbach, Dirk: "Optical Free-Space Communication on Earth and in Space Regarding Quantum Cryptography Aspects." 10.1007/978-3-642-11731-2\_11. 2009.

[https://www.researchgate.net/publication/225003843\\_Optical\\_Free-Space\\_Communication\\_on\\_Earth\\_and\\_in\\_Space\\_Regarding\\_Quantum\\_Cryptography\\_Aspects?enrichId=rgreq-4e72ce313bd72420b09642379fcbc0f9-XXX&enrichSource=Y292ZXJQYWdlOzlyNTAwMzg0MztBUzoxMDQ4MTA5OTcwOTIzNTNAMTQwMjAwMDI5NzQ1OA%3D%3D&el=1\\_x\\_2&esc=publicationCoverPdf](https://www.researchgate.net/publication/225003843_Optical_Free-Space_Communication_on_Earth_and_in_Space_Regarding_Quantum_Cryptography_Aspects?enrichId=rgreq-4e72ce313bd72420b09642379fcbc0f9-XXX&enrichSource=Y292ZXJQYWdlOzlyNTAwMzg0MztBUzoxMDQ4MTA5OTcwOTIzNTNAMTQwMjAwMDI5NzQ1OA%3D%3D&el=1_x_2&esc=publicationCoverPdf)

- (44) Kathleen Michelle Riesing, Portable Optical Ground Stations for Satellite Communication. Doctor of Philosophy in Aeronautics and Astronautics, MASSACHUSETTS INSTITUTE OF TECHNOLOGY. June 2018.

<https://dspace.mit.edu/bitstream/handle/1721.1/119269/1061557727-MIT.pdf?sequence=1&isAllowed=y>

- (45) Scott Schaire, Serhat Altunc, Yen Wong, Obadiah Kegege, Marta Shelton, George Bussey, Marcus Murbach, Howard Garon, Yudhajeet Dasgupta, Steve Gaines, Edward McCarty, Sean McDaniel, Wesley Faler, Peter Celeste. Trish Perrotto, Booz Allen Hamilton, Matt Batchelor: "Investigation into New Ground Based Communications Service Offerings in Response to SmallSat Trends." 32nd Annual AIAA/USU Conference on Small Satellites. 2018.

- (46) Khan, Khudeja: "Data Communication With A Nano-satellite Using Satellite Personal Communication Networks (s-pcns)." Electronic Theses and Dissertations, 2004-2019. 3588. 2008.



- (47) Samuel Sanders Visner: "Cyber Best Practices for Small Satellites." International Astronautical Congress (IAC), Washington D.C., United States, 21-25 October 2019.
- (48) Kul Bhasin, Pete Vrotsos, Eli Naffah: "Commercial Communication Services for Nasa Space Missions: Capability Assessment, Opportunities and Challenges."  
[https://www1.grc.nasa.gov/wp-content/uploads/Ka-Band-Conference\\_-\\_Commercial-Communication-Services-for-NASA-Space-Missions.pdf](https://www1.grc.nasa.gov/wp-content/uploads/Ka-Band-Conference_-_Commercial-Communication-Services-for-NASA-Space-Missions.pdf)
- (49) GAUSS Srl. "Ground Station & Software." [https://www.gaussteam.com/wordpress/wp-content/uploads/2018/01/Flyer\\_GroundStation\\_Software\\_1.pdf](https://www.gaussteam.com/wordpress/wp-content/uploads/2018/01/Flyer_GroundStation_Software_1.pdf)
- (50) INCOSE - International Council on Systems Engineering: "Systems Security Engineering: Mission and Objectives." [Online] [Cited July 12, 2021].  
<https://www.incose.org/incose-member-resources/working-groups/analytic/systems-security-engineering>
- (51) National Security and Defense: "Memorandum on Space Policy Directive-5— Cybersecurity Principles for Space Systems" [Online] September 4, 2020. [Cited July 12, 2021]. <https://trumpwhitehouse.archives.gov/presidential-actions/memorandum-space-policy-directive-5-cybersecurity-principles-space-systems/>
- (52) NASA: "SPACE SYSTEM PROTECTION STANDARD" NASA-STD-1006 w/Change 1. [Online] October 29, 2019. [Cited July 12, 2021].  
<https://standards.nasa.gov/standard/nasa/nasa-std-1006-wchange-1>
- (53) R. Ross (NIST), V. Pillitteri (NIST), R. Graubart (MITRE), D. Bodeau (MITRE), R. McQuaid (MITRE): "Developing Cyber Resilient Systems: A Systems Security Engineering Approach." SP 800-160 Vol. 2. November 2019.
- (54) Ron Ross (NIST), Michael McEvilley (MITRE), Janet Oren (Legg Mason): "Systems Security Engineering: Considerations for a Multidisciplinary Approach in the Engineering of Trustworthy Secure Systems." NIST SP 800-160 Vol. 1, November 2016 (Updated March 21, 2018). [Cited July 12, 2021]. <https://csrc.nist.gov/publications/detail/sp/800-160/vol-1/final>
- (55) National Institute of Standards and Technology : "Cybersecurity Framework" [Online] Cited July 12, 2021]. <https://www.nist.gov/cyberframework>
- (56) The Aerospace Corporation: "Defending Spacecraft in the Cyber Domain." [Online] [Cited July 30, 2021]. <https://aerospace.org/paper/defending-spacecraft-cyber-domain>
- (57) S. Visner and S. C. Kordella, The MITRE Corporation: "Cyber Best Practices for Small Satellites." (November 2020). <https://www.mitre.org/publications/technical-papers/cyber-best-practices-for-small-satellites>
- (58) Consultative Committee for Space Data Systems: "Report Concerning Space Data System Standards." CCSDS 350.7-G-2, Green Book, Issue 2. April 2019.
- (59) Consultative Committee for Space Data Systems: "Report on the Application of Security to CCSDS Protocols." CCSDS 350.0-G-3, Green Book, Issue 3. March 2019.



- (60) KSAT: Kongsberg Satellite Services: “Optical Communications: ESA-ESOC Optical Nucleus Network for Direct-to-Earth communications services up to Lunar distances.” [Online] [Cited July 30, 2021]. <https://www.ksat.no/ground-network-services/new-technologies/optical-comms/>
- (61) Celestia STS: “TNO and Celestia STS sign agreement to commercialize Optical Modem.” June 30, 2021. [Online] [Cited July 18, 2021]. <https://celestia-sts.com/2021/tno-and-celestia-sts-sign-agreement-to-commercialise-optical-modem/>
- (62) Thales: “Beam me up! Thales & Goonhilly Earth Station collaborate on research into laser beams as data pipes.” June 8, 2021. [Online]. [Cited July 23, 2021]. <https://www.thalesgroup.com/en/australia/press-release/beam-me-thales-goonhilly-earth-station-collaborate-research-laser-beams>
- (63) “C-COM Announces Successful Satellite Test of Its Ka-band Phased Array Antenna.” May 11, 2021. [Online]. [Cited July 23, 2021]. <https://www.newsfilecorp.com/release/83468/CCOM-Announces-Successful-Satellite-Test-of-Its-Kaband-Phased-Array-Antenna>





Chapter Contents

Glossary ..... ii

12.0 Identification and Tracking Systems ..... 337

    12.1 Introduction ..... 337

    12.2 Identification and Tracking Ground Systems..... 337

    12.3 Tracking Aids ..... 339

    12.4 Devices that Communicate Position and ID via Radio ..... 340

    12.5 Devices that use Coded Light Signals..... 341

        12.5.1 Van Atta Arrays and RF Interrogation Receivers ..... 342

        12.5.2 Laser-Interrogated Corner Cube Reflectors..... 343

        12.5.3 Passive Increase in Albedo ..... 344

    12.6 Future Efforts ..... 344

    12.7 Summary..... 344

References ..... 344



## Chapter Glossary

(AGI)	Analytical Graphics, Inc.
(CARA)	Conjunction Assessment Risk Analysis
(CCR)	Corner Cube Reflectors
(CNES)	French Space Agency
(COTS)	Commercial-off-the-Shelf
(CUBIT)	CubeSat Identification Tag
(D/T/I)	Detection, Tracking and Identification
(EGTN)	ExoAnalytic Global Telescope Network
(ELROI)	Extremely Low Resource Optical Identifier
(FCC)	Federal Communications Commission
(GEO)	Geosynchronous Equatorial Orbit
(GPS)	Global Positioning System
(GUI)	Graphical User Interface
(HEO)	Highly Elliptical Orbit
(HUSIR)	Haystack Ultrawideband Satellite Imaging Radar
(IDs)	Identification
(ILRS)	International Laser Ranging Service
(JSpOC)	Joint Space Operations Center
(LEDs)	Light Emitting Diodes
(MEO)	Medium Earth Orbit
(NTE)	Nanosatellite Tracking Experiment
(NTIA)	National Telecommunications and Information Administration
(PNT)	Positioning, Navigation, and Timing
(RF)	Radio Frequency
(SRI)	Stanford Research Institute
(SSA)	Space Situational Awareness
(SSN)	Space Surveillance Network
(SWaP)	Size, Weight, and Power
(TLE)	Two-Line Element
(USIR)	Ultrawideband Satellite Imaging Radar



## 12.0 Identification and Tracking Systems

### 12.1 Introduction

In the past, most launches involved a single, large satellite launching on a dedicated launch vehicle. Small satellites as secondary payloads were sometimes ‘dropped off’ along the way to the primary payload’s orbit or rode along to the final orbit with the primary payload. In either case, it typically was not that difficult to distinguish between primary and secondary payloads via size and operational parameters.

Recently, however, multi-manifest or “rideshare” launches have become more common, and consolidators (1 – 3) are launching multiple CubeSats, or bundling CubeSats and other smaller payloads with larger payloads to fill up the excess capacity of almost any given launch vehicle. For technical and cost reasons, such launches generally deploy small satellites and CubeSats into very similar orbits over a short time window. Such “batch” launches give rise to “CubeSat confusion” (4); by launching CubeSats close in space, they are hard to distinguish from each other; by launching them close in time, existing space traffic management and space situational awareness systems do not have time to react to the addition of so many new space objects all at once (5, 6). At times it can take weeks to months to sort out which object is which, and some may never be uniquely identified at all.

Due to their standardized shape and size, CubeSats look very similar to one another, especially when they are in orbit hundreds of kilometers away. If there are unidentified objects from a launch, then the possible number of associations of object identifications (IDs) to tracked objects scales as  $n$  ( $n$ -factorial, where  $n$  is the number of unidentified space objects from the launch)! For example, if there are just two objects, say a payload and an upper stage, there are two ways in which you can associate the IDs with the tracked objects, and even that can be a challenge (7). However, if there are ten unidentified objects, there are 3,628,800 possible combinations; with 20 this rises to  $2.4 \times 10^{18}$  combinations. The magnitude of the problem gets big quickly.

Small satellites can improve their chances of being identified and tracked through good coordination with tracking agencies pre-launch, through community sharing of Two-Line Element (TLE) sets and other position data in clearly defined, consistent formats, and through careful consideration of deployment direction and timing (8). Good design choices can also improve the chances of small satellites surviving launch and early orbit (9) and can even make use of in-space commercial radio networks as a “back-up” method of communicating should primary systems fail (10). However, despite improvements in both design and coordination, many small satellites still go unidentified. This has led to the introduction of tracking aids – independent systems that help owners and trackers identify small satellites and CubeSats, in some cases even if the satellite itself is malfunctioning.

The information described below is not intended to be exhaustive but provides an overview of current state-of-the-art technologies and their development status for a particular small spacecraft subsystem. It should be noted that Technology Readiness Level (TRL) designations may vary with changes specific to payload, mission requirements, reliability considerations, and/or the environment in which performance was demonstrated. Readers are highly encouraged to reach out to companies for further information regarding the performance and TRL of described technology. There is no intention of mentioning certain companies and omitting others based on their technologies or relationship with NASA.

### 12.2 Identification and Tracking Ground Systems

Initially established in 2005, the Joint Space Operations Center (JSpOC) was performing space surveillance and providing foundational Space Situational Awareness (SSA) for the US



Department of Defense as well as for other agencies and space entities. Since July 2016, that role is provided by the 18th Space Control Squadron (18 SPCS) which assumed all functions including detection, tracking and identification (D/T/I) of artificial objects in Earth orbit and maintaining a space catalog which is publicly available on [space-track.org](http://space-track.org). 18 SPCS is co-located with the Combined Space Operations Center at Vandenberg Air Force Base in Southern California. As part of their activities, they provide launch support and conjunction assessment (which identifies close approaches between launch and other catalogued in-orbit objects), collision avoidance and reentry assessment. This is achieved via the US Space Surveillance Network (SSN) that is formed by several sensors around the world (29). 18 SPCS is capable of tracking more than 23,000 objects in orbit and of providing data and analytics of pieces as little as 10 cm. They issue TLEs that are updated on a regular basis and can be used to compute predicted orbit ephemeris and conjunction analyses.

The US Air Force next generation SSA system, known as the Space Fence, provides higher resolution for tracked objects. It was declared operational in March 2020 and can track objects below the previous 10 cm limit. It is located in Kwajalein Island, in the Republic of the Marshall Islands and consists of a S-band radar system to track objects primarily in low-Earth orbit, although it can track objects in medium Earth orbit (MEO) and geostationary equatorial orbit (GEO) as well. Data obtained with the Space Fence will feed the US SSN. The 20<sup>th</sup> Space Control Squadron based in Huntsville (Alabama) manages the Space Fence and provides data to the 18 SPCS to complete the space catalogue (30). Another major antenna in the SSN is the Haystack Ultrawideband Satellite Imaging Radar (HUSIR), which is the highest-resolution, long-range sensor in the world. HUSIR simultaneously generates X- and W-band images that can provide valuable information about the size, shape and orientation of Earth orbiting objects (31).

The NASA Goddard Conjunction Assessment Risk Analysis (CARA) team acts as an important intermediary between CSpOC and the satellite missions. CARA usually gathers daily orbit ephemeris and covariance files from the teams and provides the data to CSpOC for screening and close approach assessment. CARA provides capabilities to NASA missions beyond the CSpOC level of support, including operations concept development, probability of collision computation, high interest event notification, or conjunction geometry analysis among other functions. Since 2012, the French Space Agency (CNES) use the equivalent CAESAR team for their missions (32) (33).

Besides government assets, several commercial entities are providing tracking information to stakeholders. Those include Analytical Graphics, Inc. (AGI) which provides data from a network of commercial sensors through its Commercial Space Operations Center. ExoAnalytic has a global telescope network (EGTN) consisting of over 25 observatories and 275 telescopes tracking orbiting objects in GEO, highly elliptical orbit (HEO), and MEO. The EGTN can collect angles and brightness measurements. They also maintain a proprietary catalog of satellites and space debris that are regularly tracked and cataloged. This includes a historical archive of over 100 million object measurements (26).

LeoLabs is another important commercial entity providing detailed information for spacecraft tracking. They use a group of distributed Earth-based, phased-array radars to make a commercial-off-the-shelf (COTS) satellite tracking service targeted to the specific requirements of low-Earth orbit SmallSat operators. They currently have two radar stations in the United States and radar sites in New Zealand, Costa Rica, and the Azores. The planned capability for 2020 – 2021 includes six radars strategically located around the world, which would have the capability to robustly track objects down to 2 cm in size. The predicted performance also includes a revisit time of over 10 observations per day for specific objects, and a low-Earth orbit catalog of over 250,000 pieces. Through their LeoTrack platform, they can use their radar data to perform precision tracking and curate orbit information products for satellites as small as 1U. Their system



includes an open-source graphical user interface (GUI) capable of displaying all the catalog in real time, as well as fundamental orbit information about each individual object. They recently announced a commercial Launch and Early Orbit service, with SpaceX as their initial customer (37).

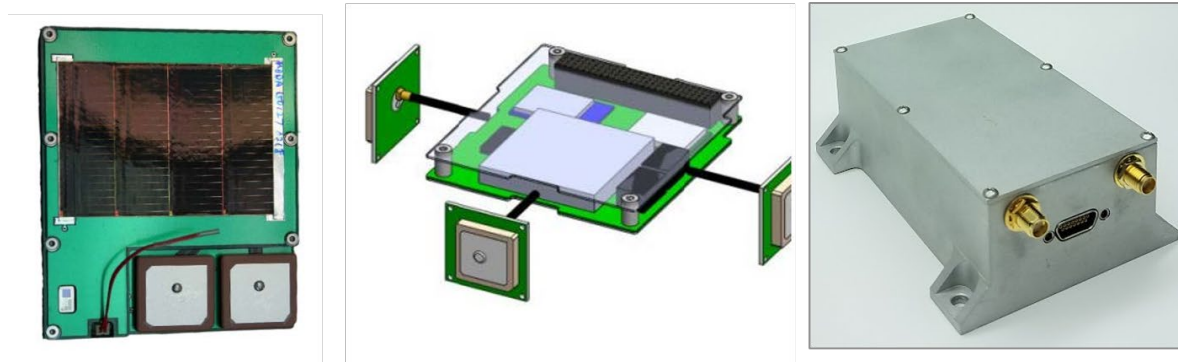
### 12.3 Tracking Aids

Tracking aids come in several categories, each with benefits and drawbacks (11). Table 12-1 discusses the broad categories available, with representative examples discussed below. Size, weight, and cost vary for each of the examples, but all can be considered compatible with a CubeSat mission; see the references for detailed information on size, weight, and power (SWaP) and cost.

<b>Technology scheme</b>	<b>Description and reference mission</b>	<b>TRL</b>	<b>Citation</b>
CubeSat position and ID via radio	A position, navigation, and timing (PNT) receiver is attached to a CubeSat, along with a radio to transmit the information via a LEO communications provider (or directly to the ground); example: BlackBox, Blinker.	7-9	(12) (13)
Coded light signals from light source on exterior of CubeSat	Exterior-mounted LEDs with large-aperture telescopes to receive the signal or diffused LED lasers with ground-based photon-counting cameras.	6-7	(14) (15)
Radio Frequency interrogation of an exterior Van Atta array	For example, exterior mounted radio frequency identification (RFID) tag & commensurate radar.	7-9	(16)
Laser interrogated corner cube reflectors (CCR)	One or several small CCRs can be attached to CubeSat exterior; ground-based laser and receiver telescope needed to distinguish number of CCRs.	7-9	(17)
Passive augmentations to visibility	Use of high-albedo paint or tape or other methods to increase visibility.	7-9	

## 12.4 Devices that Communicate Position and ID via Radio

The most comprehensive (but also potentially the most complex and SWaP-intensive) option involves equipping a small satellite with an independent positioning, navigation, and timing (PNT) receiver and independent radio capable of transmitting that data to an independent communications provider. An example technology is the Black Box system (figure 12.1), described by NearSpace Launch, Inc., in a recent conference paper (18). This system comes in



*Figure 12.1: (left) Thin Patch or Stamp Black Box for side mounting. (Middle) PC104 Black Box for internal stack mounting. (Right) Standard Black Box for larger satellites. TRL 9: flown on spaceflight launch. Solar array and antennas not shown. Credit: NearSpace Launch, Inc.*

several form factors for mounting internally or externally to a small satellite or CubeSat. The patch antenna shown in the first image is approximately 10 cm by 8 cm and can weigh as little as 22 grams; larger systems such as the one shown in the third image of figure 12.1 have flown and are considered TRL 9. These systems combine a low-power Global Positioning System (GPS) receiver with a low-power radio capable of communicating with a low-Earth orbit communication provider (in the case of Black Box, the Global Star network) and operate independently from the spacecraft's regular command and telemetry links. Externally mounted versions often include solar cells for independent power generation. A Black Box system is currently flying on Spaceflight Sherpa-FX orbital transfer vehicle, launched on January 24, 2021, and is returning GPS fixes to the developer. The GPS fixes are being analyzed and a report is expected to be given at the October 2021 International Astronautical Congress.

A similar concept under development is The Aerospace Corporation's 'Blinker' (13), in which a GPS receiver and low-power radio are externally mounted to a CubeSat. GPS positions ("tags") are recorded, stored, and then radioed when the satellite is over an Aerospace Corporation ground station (which is separate and independent from the CubeSat's mission ground station). Research and development are being conducted to automatically convert the GPS tags into ephemeris information that can be directly ingested by space situational awareness centers (in this case the 18<sup>th</sup> Space Control Squadron via Space-Track.org).

The advantages to such a system are that it provides the most complete data on a satellite's position and requires no specialized ground equipment (other than the equipment used by the communications provider). Some such systems are independently powered and can provide data even if the host satellite never powers up, though others are dependent on spacecraft power to function. These systems are the most complex of the tracking aids described, however, and despite their relatively small size, are still the most SWaP-intensive of the options examined. Systems that rely on power from the host vehicle are also useless if the host vehicle suffers a power anomaly. Having an additional onboard radio that communicates with other space assets necessitates additional Federal Communications Commission (FCC) (or National

Telecommunications and Information Administration (NTIA) for US Government missions licensing and coordination).

## 12.5 Devices that use Coded Light Signals

Slightly less complex are devices that make use of coded light signals for identification. An example of such a device is the Extremely Low Resource Optical Identifier (ELROI) beacon shown in figure 12.2, under development by Los Alamos National Lab (19). Devices such as ELROI use exterior-mounted light-emitting diodes or diode lasers that blink in a prescribed sequence that uniquely identifies the satellite. The ELROI system is designed to be independently powered by a small solar cell and battery, and packaged into a system as small as a Scrabble tile, though only larger systems – with power provided by the host satellite – have flown (ironically, the CubeSat on the initial test flight was never identified along with several co-manifested

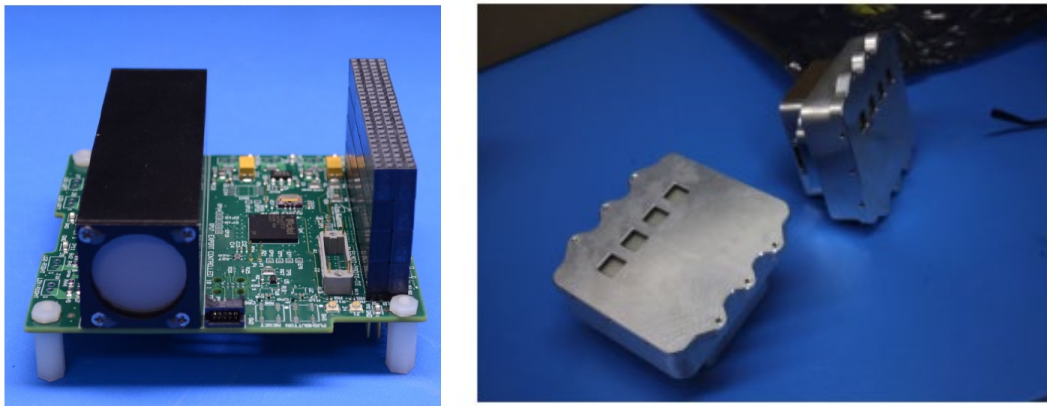


Figure 12.2: (left) ELROI PC104 beacon unit that was installed on NMTSat.d (right) Two ELROI beacon units delivered for a launch in 2021. Credit: Los Alamos National Laboratory.

CubeSats, and ELROI was able to be activated). The next ELROI test flight is co-manifested with the September 2021 LandSat launch, with a follow-on test flight for early-mid 2022.

The emitters on such devices can be regular light emitting diodes (LEDs) or diffused diode lasers, but require specialized ground equipment – either a large-aperture telescope or a photon-counting camera – and the ability to track the object as it passes overhead. Figure 12.3 shows how the system works for ELROI. A photon-counting camera attached to a telescope tracks the signal from a diode laser and decodes the ID of the host satellite from the on/off pattern of the flashes.

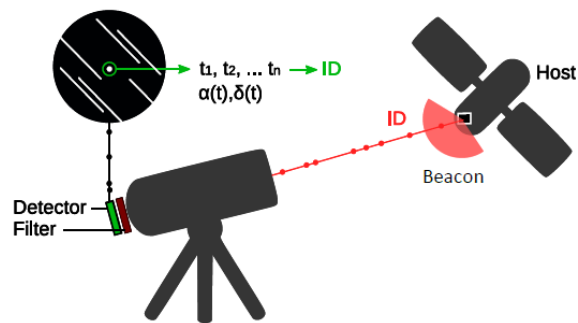


Figure 12.3: ELROI Optical Detection System. Credit: Los Alamos National Laboratory.

Another similar system (34), proposes to use red, blue, and green LED lights on specific faces of the satellite, which blink in a unique pattern, and standard astronomical optical telescopes to track and identify the LED flash pattern (14). LEDSAT, a CubeSat to test this concept on-orbit, launched in August 2021 (35). A test of an exterior-mounted blue LED on a CubeSat was attempted in March 2021 though was indeterminate due to a lengthy period of bad weather at the single designated telescope site.

LED-based identification systems have the advantage of being relatively simple and capable of identifying satellites uniquely. However, all systems flown to date have required power from the host satellite, leading to issues with detection (19) if the host satellite does not power up. Current implementations are also relatively large, though future systems are expected to be much smaller and may include independent power. LED-based systems require relatively clear night-time skies for identification, and dedicated ground equipment (telescope and sensor). The light sources are too faint to allow blind searching of the sky for the satellite; orbital information from a SSA provider is also required to find and track the CubeSat, although the process of tracking the satellite via an optical telescope allows the orbital ephemeris to be updated. Issues with attitude control on the host satellite can also complicate the identification process. In addition, using LEDs or other light sources on a satellite while in Earth shadow should be done carefully to minimize interference with astronomical observations. The SatCon1 report (36) on page 6 lists several recommendations to be followed: 1) assure the light source is fainter than apparent magnitude of  $V \sim 7$  (and the fainter the better), and 2) advance notice of any illumination times, including accurate orbital elements.

### 12.5.1 Van Atta Arrays and RF Interrogation Receivers

Another method for increasing the ability to track and possible identification of small satellites involves devices that respond when interrogated by a radio frequency (RF) signal of appropriate wavelength. One such system, the CubeSat Identification Tag (CUBIT) shown in figure 12.4, is similar to the RFID devices used in proximity badges (16). Built by SRI International and partnered with NASA Ames, CUBIT responds with a short burst of information when interrogated by a radio signal of the correct frequency. CUBIT is relatively small and designed to be independent of host vehicle power. The implementations that have flown contain a small battery suitable for 30 days of in-orbit life, which covers the most critical early orbit identification period. The device is separated into an internally mounted electronics unit attached to an exterior antenna to minimize the exterior footprint of the unit. Two units have flown and been successfully demonstrated in space on board TechEdSat-6 in 2017 and TechEdSat-7 in 2020. A relatively large ground architecture (in CUBIT's case, a 30 m antenna and an array of antennas) are required to interrogate the system and successfully acquire the low-power response. CUBIT is patent-pending, and SRI has reached commercialization agreements with potential vendors. Future research will continue with a recently awarded AFWERX Phase 1 study.

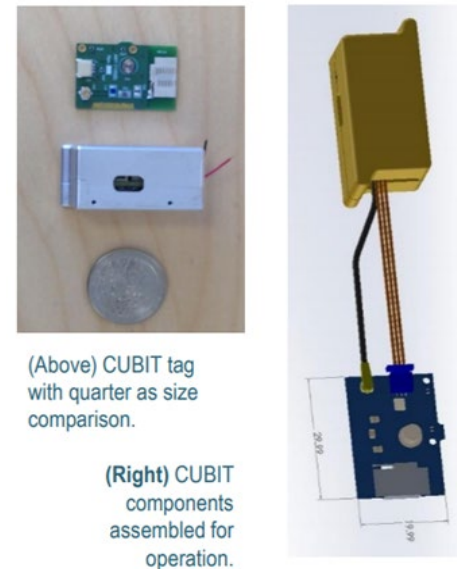


Figure 12.4: CUBIT. Credit: SRI International.

Another example of an RF-interrogated device is a Van Atta array, a passive device which re-radiates RF energy back toward the source of that energy (20). One such device, the Nanosatellite Tracking Experiment (NTE) consists of a 64-element Van Atta array of tiny, paired antennas tuned to a Ku-band RF frequency, as shown in figure 12.5 (21). When interrogated at the proper frequency range, the incident RF field received by each antenna is fed to a corresponding antenna via a passive transmission line, where it is re-radiated. This significantly increases the radar cross-





section of the object, allowing it to be more easily tracked. Unique identification is difficult, however, and requires specialized ground stations which tend to be expensive to operate. A satellite carrying a Van Atta array device will be distinguishable from one not carrying such a device, or from one carrying a device tuned to a different frequency band, but two satellites carrying the same Van Atta array will return the same signature. The RF interrogation also requires a ground source of the appropriate frequency. However, Van Atta array devices are entirely passive and extremely low SWaP, making them easy to include on small satellites and CubeSats. NTE devices have flown in space but results from those flight experiments have not been published to date. A unique identification capability is presently under development, with in-orbit testing anticipated in 2021 (22).

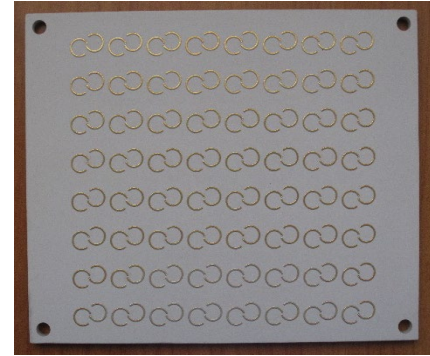


Figure 12.5: NTE Van Atta array retro-reflector in the Ku-band, fits standard 1U panel, tuned to HAX RADAR frequency. Credit: Naval Information Warfare Center.

**12.5.2 Laser-Interrogated Corner Cube Reflectors**

Corner cube reflectors, long used in the space industry, are special mirrors designed to reflect laser light back in the direction from which it arrived. They require no internal energy source. When illuminated by a laser, they provide a return signal that can be detected on the ground by a fast camera, as seen in figure 12.6. Putting a different number of CCRs on a set of CubeSats allows the ground station to differentiate between the CubeSats (i.e., a CubeSat with one CCR will produce a different return signal from another with two CCRs or three CCRs, etc.). One can use a laser and telescope system like those employed by the International Laser Ranging Service (ILRS) (23), which are high TRL and have been operating for decades. Precise orbital information

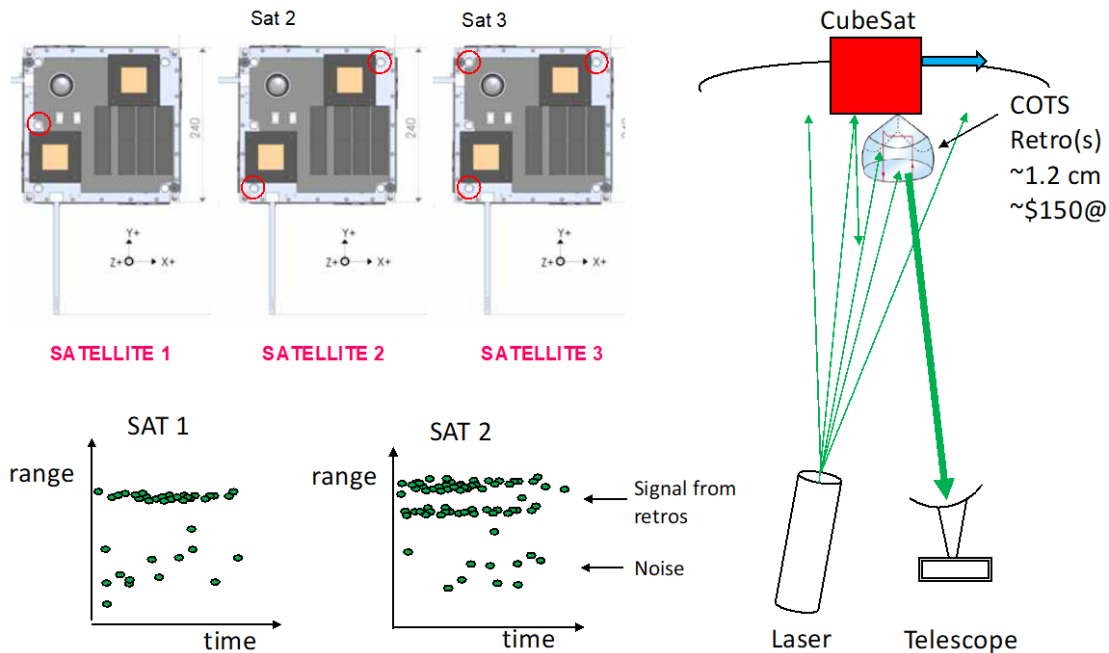


Figure 12.6: Corner Cube Reflectors. Credit: The Aerospace Corporation.

is required to lase the CubeSat and receive a return, and the number of satellites that can be uniquely identified is limited by the number of corner cube reflectors that can be attached. Details and results of an on-orbit laser demonstration were recently presented at an Industry Day (23-2).



### 12.5.3 Passive Increase in Albedo

The simplest method of increasing trackability of satellites involves using high-albedo paint, special tape, or other simple methods to increase the optical or radar visibility of a small satellite, allowing it to be more easily detected by ground-based systems (24). White-colored thermal paint has been used for years to increase the ability of satellites to reject heat, which also helps make the satellites more visible and more trackable. Additionally, CubeSats often deploy a mission-specific configuration of wire antennas and/or cylindrical boom structures which can serve as unique identifiers using ground-based optical or radar characterization (25). Such approaches are simple, require little to no SWaP, and are readily available, but don't uniquely identify the satellite, and are limited in their effectiveness.

## 12.6 Future Efforts

Many in the community are aware of the "CubeSat confusion" issue, and there is a ground-swell of desire to make progress with mitigating this problem. Regulators have recognized the issue (27), and one of the consolidators, SpaceFlight, Inc., has announced their Sherpa orbital transfer vehicle will take tracking and identification technologies into space as hosted payloads aboard some of their upcoming dispenser satellite flights to increase their TRLs (28). The Aerospace Corporation conducted a virtual "Industry Day" January 12-13, 2021, and brought together regulators, consolidators, CubeSat owner/operators, and industrial and academic technology solution providers to discuss this matter and try to affect a solution (39).

On the horizon, High Earth Robotics plans to create the Argus constellation – twelve optical 6U HERO-1 nanosatellites with space telescope payloads in GEO that can identify objects, take high resolution images of damaged satellites, and help identify solutions to avoid further decomposition. The constellation is intended to be resilient to interference and communications link interruption (38).

## 12.7 Summary

Small satellites and CubeSats are likely to continue increasing in popularity, and multi-manifest launches provide a very cost-effective way to get large numbers of satellites to space. Improving the ability to identify and track similar satellites in space – especially those deployed in batches from a single launch vehicle – can help both small satellite owners and the entire space enterprise avoid the pitfalls of "CubeSat confusion."

For feedback solicitation, please email: [arc-sst-soa@mail.nasa.gov](mailto:arc-sst-soa@mail.nasa.gov). Please include a business email so someone may contact you further.

## References

- (1) Spaceflight (2021). [Online] [Accessed March 3, 2020]. <https://spaceflight.com>
- (2) Nanoracks (2019). "Nanoracks Books CubeSat Rideshare and Habitat Building Demonstration in Single SpaceX Falcon 9 Launch". [Online] [Accessed March 3, 2020] <https://nanoracks.com/rideshare-habitat-building-demonstration/>
- (3) Kirtland Airforce Base (2007). "Space Test Program". [Online] [Accessed April 8, 2020]. <https://www.kirtland.af.mil/About-Us/Fact-Sheets/Display/Article/826059/space-test-program/>,
- (4) Skinner, M.A.: "*CubeSat Confusion: how to avoid 'dead on arrival'.*" IAC-20-A6.7.9, International Astronomical Congress 71st meeting, 12-14 October 2020, The CyberSpace edition.



- (5) Klotz, Irene: "SpaceX Rideshare Mission Spawns 12 Orphan CubeSats." Aerospace Daily and Defense Report, 8/12/2019.
- (6) Grush, Loren: "Why the Air Force Still Cannot Identify more than a Dozen Satellites from One December Launch: The case of the unknown satellites." The Verge, <https://www.theverge.com/2019/4/2/18277344/space-situational-awareness-air-force-tracking-ss0-a-spaceflight-CubeSats>
- (7) Bloch, J. et al.: "The ALEXIS Mission Recovery." 17<sup>th</sup> annual American Astronomical Society (AAS) guidance and control conference, Keystone, CO (United States), <<https://www.osti.gov/biblio/142518>>, 1994.
- (8) Braun, B. & S. Herrin: "The More, the Messier: ORS-3 lessons for multi-payload mission deployments." 1-10. 10.1109/AERO.2016.7500582. 2016.
- (9) Venturini, C.C.: "Improving Mission Success of CubeSats." Aerospace Report number TOR-2017-01689, June 12, 2017, [https://www.nasa.gov/sites/default/files/atoms/files/improving\\_mission\\_success\\_of\\_CubeSats\\_-\\_tor-2017-01689.pdf](https://www.nasa.gov/sites/default/files/atoms/files/improving_mission_success_of_CubeSats_-_tor-2017-01689.pdf), accessed May 15, 2019.
- (10) Voss, H.D., et al.: "Globalstar Communication Link for CubeSats: TSAT, GEARRS1, and GEARRS2." 29th AIAA/USU Conference on Small Satellites, Logan UT, August 9, 2015.
- (11) Skinner, M.A.: "Making Small Satellites Visible: Nanosat tracking and identification techniques and technologies." IAC-19-A6.7.5, International Astronomical Congress 70th meeting, October 21-25, 2019, Washington DC, United States.
- (12) Voss, H.D., Dailey, J.F., Orvis, M.B.: "'Black Box' Beacon for Mission Success, Insurance, and Debris Mitigation." SSC18-PII-11, 32nd Annual AIAA/USU Conference on Small Satellites, Logan UT. 2018.
- (13) Abraham, A.J.: "GPS Transponders for Space Traffic Management." Center for Space Policy & Strategy, Aerospace Corporation, April 2018.
- (14) Cutler, J., Seitzer, P., Lee, C.H., et al.: "Improved Orbit Determination of LEO CubeSats: Project LEDsat." AMOS Technologies Conference, 19 – 22 September 2017, Maui, Hawai'i.
- (15) Palmer, D.M., Holmes, R.M.: "ELROI: A License Plate for Your Satellite." Journal of Spacecraft and Rockets, Vol. 55, No. 4. pp. 1014-1023. 2018.
- (16) Phan, Samson: "'Spaceflight Industries' SSO-A Flight Launches with SRI International's CUBIT Technology Onboard, Developed to Track and Identify Low Earth Orbit Satellites." <https://www.sri.com/blog/spaceflight-industries-ss0-flight-launches-sri-internationals-cubit-technology-onboard>, retrieved 10/30/2019.
- (17) Kirchner, G., Grunwaldt, L., Neubert, R., Koidl, F., Barschke, M., Yoon, Z., Fiedler, H., Hollenstein, C.: "Laser Ranging to Nano- Satellites in LEO Orbits: Plans, Issues, Simulations." 18th International Workshop on Laser Ranging, Fujiyoshida, Japan. 2013.
- (18) Voss, H.D. et. al.: "'Black Box' RF Sat-Link for Space Debris, Mission Success and Risk Mitigation." First International Orbital Debris Conference, Sugar Land, TX. 2019.
- (19) Palmer, D.M., et. al.: "Progress Towards the ELROI™ Satellite License Plate." SSC20-VI-05, 34<sup>th</sup> Annual Conference on Small Satellites, Logan, UT. 2020.
- (20) Bird, Dudley: "Design and Manufacture of a Low-Profile Radar Retro-Reflector." Paper presented at the RTO SCI Symposium on "Sensors and Sensor Denial by Camouflage, Concealment and Deception", held in Brussels, Belgium, April 19-20, 2004, and published in RTO-MP-SCI-145.
- (21) Lane, D. et. al.: "Nanosatellite Tracking using Passive Retro-Reflectors." SSC20-WKIV-04, 34<sup>th</sup> Annual Conference on Small Satellites, Logan, UT. 2020.
- (22) Lane, ibid.
- (23) ILRS, <https://ilrs.gsfc.nasa.gov/technology/laserRanging/index.html>, accessed April 14, 2020.



- (24) Hall, D.: "*Optical CubeSat Discrimination.*" AMOS Technical Conference, September 2008.
- (25) Chong, Chee-Yee, and Shozo Mori: "*Metrics for feature-aided track association.*" 2006 9th International Conference on Information Fusion. IEEE. 2006.
- (26) ExoAnalytics Solutions. Space Domain Awareness (SDA). ExoAnalytic. [Online] 2020. [Cited: 03 18, 2020.] <https://exoanalytic.com/space-domain-awareness>
- (27) US Federal Communications Commission, "*Orbital Debris in the New Space Age, Report and Order and Further Notice of Proposed Rulemaking.*" FCC-20-54, paragraph 62, April 24, 2020.
- (28) Sorensen, J.: "*SpaceFlight Inc. Unveils Next-gen Orbital Transfer Vehicle to Fly Aboard Next SpaceX Rideshare Mission.*" July 15, 2020. <https://spaceflight.com/spaceflight-inc-unveils-next-gen-orbital-transfer-vehicle-to-fly-aboard-next-spacex-rideshare-mission/>
- (29) Launch Conjunction Assessment Handbook. LAUNCHCONJUNCTION ASSESSMENT HANDBOOK VERSION 1.0, DECEMBER 2018. 18 SPCS Process for Launch Conjunction Assessment, JFSCC, 18th Space Control Squadron Combined Space Operations Center (CSpOC) Vandenberg Air Force Base, California, [www.space-track.org](http://www.space-track.org)
- (30) Erwin, S. (2020). "Space Fence surveillance radar site declared operational". [Online] [Accessed September 29, 2020] <https://spacenews.com/space-fence-surveillance-radar-site-declared-operational/>
- (31) <https://www.ll.mit.edu/r-d/projects/haystack-ultrawideband-satellite-imaging-radar> [Accessed]
- (32) David Murakami, Sreeja Nag, Miles Lifson, Parimal Kopardekar: "Space Traffic Management with a NASA UAS Traffic Management (UTM) Inspired Architecture." AAIAA SciTech Forum, 7-11 January 2019, San Diego, California.
- (33) <https://satellitesafety.gsfc.nasa.gov/CARA.html> [Accessed 29th September]
- (34) Paolo Marzioli , Andrea Gianfermo , Lorenzo Frezza , Diego Amadio , Niccolò Picci , Federico Curiano <sup>a</sup>, Maria Giulia Pancalli <sup>a</sup>, Eleonora Vestito <sup>a</sup>, Justin Schachter <sup>b</sup>, Matt Szczerba <sup>b</sup>, Daniel Gu <sup>b</sup>, Anny Lin <sup>b</sup>, James Cutler <sup>b</sup>, Simone Pirrotta <sup>c</sup>, Fabio Santoni <sup>d</sup>, Patrick Seitzer <sup>e</sup>, Fabrizio Piergentili: "Usage of Light Emitting Diodes (LEDs) for improved satellite tracking." *Acta Astronautica* 179 (2021) 228–237.
- (35) [https://www.esa.int/Education/CubeSats\\_-\\_Fly\\_Your\\_Satellite/LEDSAT\\_passes\\_Flight\\_Acceptance\\_Review\\_and\\_now\\_has\\_a\\_ticket\\_to\\_orbit](https://www.esa.int/Education/CubeSats_-_Fly_Your_Satellite/LEDSAT_passes_Flight_Acceptance_Review_and_now_has_a_ticket_to_orbit)
- (36) <https://aas.org/sites/default/files/2020-08/SATCON1-Report.pdf>
- (37) Boggett, M. (2020) "LeoLabs Partners with SpaceX to Track Starlink Satellite Deployments". [Online] [Accessed June 16, 2021] [https://medium.com/@leolabs\\_space/leolabs-partners-with-spacex-to-track-starlink-satellite-deployments-4e579052546f](https://medium.com/@leolabs_space/leolabs-partners-with-spacex-to-track-starlink-satellite-deployments-4e579052546f)
- (38) HEO Robotics. HEO Robotics engages in space demonstration with Royal Australian Air Force. *HEO Robotics: Achievements*. [Online] 2019. [Cited: 03 18, 2020.] <https://www.heo-robotics.com/post/heo-robotics-engages-in-paid-demonstration-with-royal-australian-air-force>
- (39) <https://www.dropbox.com/sh/wyke423rvh8gpmr/AAD7vWzfgSjmLOcuqg4pMwqva?dl=0&lst=>
- (40) Bennett, James: "Lasers to support satellite identification", 2021 CubeSat ID and Tracking Industry Day Technical Workshop, Jan. 12-13 2021, [https://www.dropbox.com/sh/wyke423rvh8gpmr/AAAO\\_S39p3jJiqRh1yhY1t1ya/Day%201%20-%20January%2012%2C%202021?dl=0&preview=Bennett\\_Lasers+to+support+satellite+identification.pdf&subfolder\\_nav\\_tracking=1](https://www.dropbox.com/sh/wyke423rvh8gpmr/AAAO_S39p3jJiqRh1yhY1t1ya/Day%201%20-%20January%2012%2C%202021?dl=0&preview=Bennett_Lasers+to+support+satellite+identification.pdf&subfolder_nav_tracking=1)



## Chapter Contents

Glossary .....	ii
13.0 Deorbit Systems .....	347
13.1 Introduction .....	347
13.2 State-of-the-Art – Passive Systems .....	349
13.2.1 Main High TRL Drag Devices .....	349
13.2.2 Deployable Booms .....	353
13.2.3 Electromagnetic Tethers .....	354
13.3 State-of-the-Art – Active Systems .....	355
13.3.1 TechEdSat Series Exo-Brake .....	355
13.3.2 RemoveDebris Consortium Partners .....	356
13.3.3 Astroscale .....	356
13.3.4 ClearSpace .....	357
13.3.5 Momentum .....	357
13.3.6 D-orbit .....	357
13.3.7 Altius Space Machines .....	358
13.5 Summary .....	358
References .....	359



## Chapter Glossary

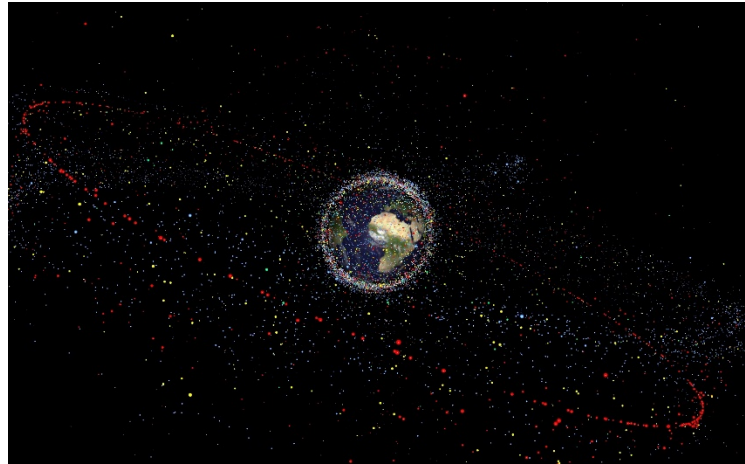
(ADCS)	Attitude Determination and Control System
(AEOLDOS)	Aerodynamic End-of-Life Deorbit system for CubeSats
(AFRL)	Air Force Research Laboratory
(ARC)	Ames Research Center
(CRD2)	Commercial Removal of Debris Demonstration
(D3)	Drag Deorbit Device
(DOM)	De-orbit Mechanism
(EOL)	End-Of-Life
(FURL)	Flexible Unfurlable and Refurlable Lightweight
(GCD)	Game Changing Development
(GTO)	Geosynchronous Transfer Orbit
(HSC)	High Strain Composite
(IADC)	Inter-Agency Space Debris Coordination Committee
(ISS)	International Space Station
(JAXA)	Japan Exploration Space Agency
(MSFC)	Marshall Space Flight Center
(RODEO)	Roll-Out DeOrbiting Device
(SBIR)	Small Business Innovation Research
(SSO)	Sun-synchronous orbit
(STMD)	Space Technology Mission Directorate
(TRL)	Technology Readiness Levels
(UTIAS-SFL)	University of Toronto Institute for Aerospace Studies Space Flight Laboratory
(VESPA)	Vega Secondary Payload Adapter

## 13.0 Deorbit Systems

### 13.1 Introduction

The threats of space debris are increasing due to the launch of several multi-satellite constellations, particularly in low-Earth orbit. The lifetime requirement for any spacecraft in low-Earth orbit is 25 years post-mission, or 30 years after launch if unable to be stored in a graveyard orbit (1).

The rate of decay of these spacecraft depends on several factors. In particular, the orbit allocation and the ballistic coefficient play a fundamental role on the ability to comply with regulations. Estimates of the accumulation of orbital debris suggest more than 900,000 particles with a diameter 1 – 10 cm, and over 34,000 pieces with diameters >10 cm, are in orbit between geostationary equatorial and low-Earth orbit altitudes (2). Of the 11,370 satellites that have been placed in orbit 60% are still in orbit and only 35% are still operational. As of April 2021, it is estimated that all of the space debris

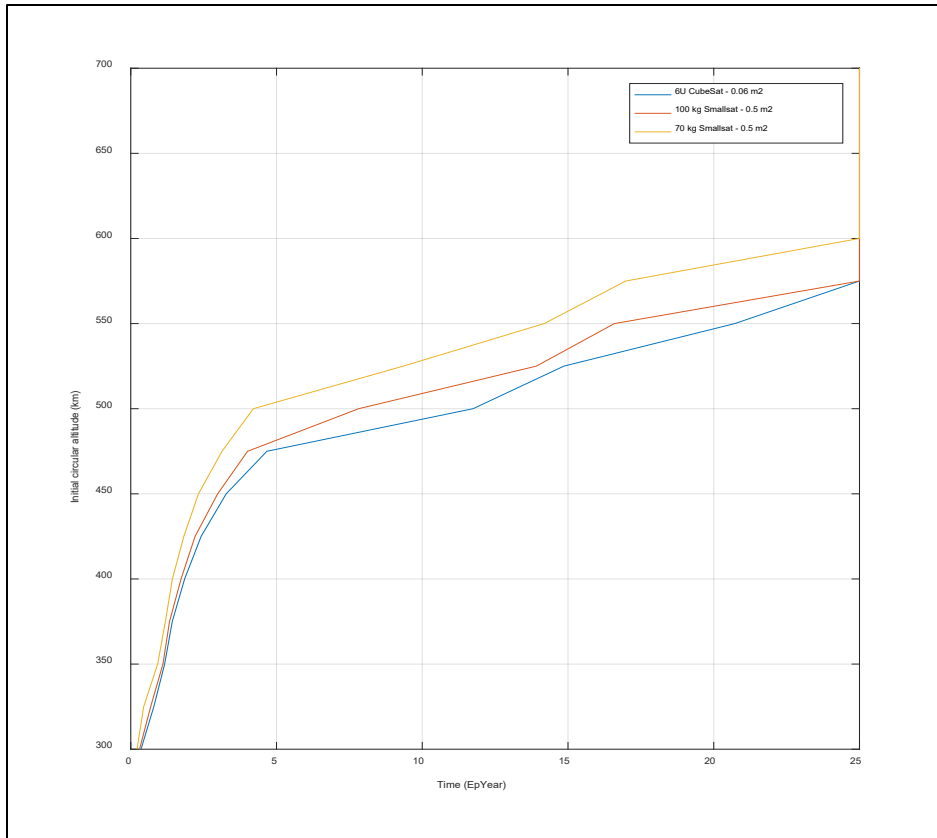


*Figure 13.1: Distribution of space debris. Credit: European Space Agency.*

in orbit have a collective mass of 9,300 metric tons (2). Figure 13.1 is a representation of the debris around Earth. The objective of the NASA Orbital Debris Program along with the Inter-Agency Space Debris Coordination Committee (IADC) is to limit the creation of space debris. They have mandated that all spacecraft must either deorbit within a given amount of time or move into a graveyard orbit for safe storage (3). Small spacecraft missions typically stay in low-Earth orbit, as it is a more accessible and less expensive orbit to reach. There are lots of rideshare opportunities to low-Earth orbit through several commercial launch providers. The close proximity to Earth can relax spacecraft mass, power and propulsive constraints. Additionally, the radiation environment in low-Earth orbit is relatively benign for altitudes below 1000 km. Small spacecraft launched at or around the International Space Station (ISS) altitude (400 km) naturally decay in well under 25 years. However, at orbital altitudes beyond 800 km, there is no guarantee that a small spacecraft will naturally decay in 25 years due to uncertainties in atmospheric density and the differences in ballistic coefficient, as seen in figure 13.2.

In this image, a representative 6U CubeSat with 0.06 m<sup>2</sup> drag area and 14 kg of dry mass decays at different rates depending on several initial circular orbits. The results differ from those achieved with another representative spacecraft of 100 kg and 0.5 m<sup>2</sup> of drag area, showing the important effect the ballistic coefficient plays in the orbit propagation. The majority of launched small spacecraft do not carry on-board propulsion, making them unable to achieve graveyard orbits for decommissioning. Therefore, they need to rely on deorbit techniques such as increasing the drag area by rotating the spacecraft with their Attitude Determination and Control System (ADCS) module if they are in low altitudes. For some spacecraft, their exposed drag area is not enough to meet the 25-year requirement. They can use deorbit devices such as drag sails (passive systems) or even hire external deorbit services (active systems) to deorbit.

Passive deorbit systems have gained maturity since the last iteration of this report, and there are more devices with high Technology Readiness Levels (TRL  $\geq$  8) that are guaranteed to satisfy



*Figure 13.2: Initial orbit altitudes yield different lifetimes depending on the ballistic coefficient of the spacecraft. Three representative area-to-mass ratios are shown. Note that the propagation stops at 25 years, but the initial altitudes yield even longer times. Credit: NASA.*

the 25-year requirement. Several missions have demonstrated the capability of some of these devices, and an increasing number of small spacecraft have been carrying them.

Traditionally passive systems were the main option for deorbiting due to their increased simplicity. However, recently active methods are gaining traction. On one hand, active deorbiting requires attitude control and, in some case, also surplus propellant post-mission, such as a steered drag sail that relies on a functioning attitude control system, or on actuators for pointing the sail. On the other hand, some of the new active deorbiting solutions include a separate spacecraft that can attach to the defunct satellite to bring it down to lower orbits where the satellites can complete the deorbit using their own drag decay. Some recent small spacecraft like the European RemoveDebris mission have even implemented a variety of active and passive deorbit systems within the same mission. This technology demonstration mission included both active and passive systems such as a net experiment, a harpoon, and a more traditional drag sail. The mission tested these systems to prove feasibility of such technologies in space by deploying two separate 2U CubeSats from the main spacecraft to simulate space debris. After the mission was completed, the passive system was deployed and is currently deorbiting the main satellite to burn in the atmosphere.

Propulsive devices have also been used for deorbiting techniques, however this approach is still considered risky due to potential failure or malfunction of either the spacecraft (up until its final stage of decommission) or the propulsive capability itself. Even if the spacecraft carries enough





excess propellant for its own active decay approach, it also needs adequate attitude control capability after the mission. This method requires continuous operation until the reentry takes place, making it inconvenient and costly for a small spacecraft mission (4). Overall, active deorbiting methods are still challenging for small spacecraft, as this demand increases design complexity and uses valuable mass and volume. This report studies the state-of-the-art for both systems, excluding spacecraft that carry their own propulsive means. For those systems, please refer to the Propulsion chapter of this report.

The information described below is not intended to be exhaustive but provides an overview of current state-of-the-art technologies and their development status for a particular small spacecraft subsystem. It should be noted that TRL designations may vary with changes specific to payload, mission requirements, reliability considerations, and/or the environment in which performance was demonstrated. Readers are highly encouraged to reach out to companies for further information regarding the performance and TRL of described technology. There is no intention of mentioning certain companies and omitting others based on their technologies or relationship with NASA.

## **13.2 State-of-the-Art – Passive Systems**

Passive deorbit methods require no further active control after deployment. Recent developments have increased the number of available options with flight heritage. This chapter will emphasize recent developments rather than past missions. In addition, the chapter aims to discuss devices used exclusively for deorbit purposes, excluding technologies such as solar sails that are used for other propulsive applications.

### **13.2.1 Main High TRL Drag Devices**

Drag devices represent the most common deorbit device for satellites orbiting in low-Earth orbit. They present an advantage due to simplicity and by not occupying large volumes while stowed. For certain area-to-mass ratios in altitudes equal or lower than 800 km, drag devices can be deployed to increase the drag area for faster deorbiting in compliance with the 25-year requirement. Recently, this technology has been implemented in several small spacecraft missions, and several companies and institutions are developing prototypes that are increasingly more mature, providing solutions to the space debris problem for missions that do not have resources for an active system. Table 13-1 displays current state-of-the-art technology for passive deorbit systems. These are the most developed technologies for deorbiting systems as of 2021.



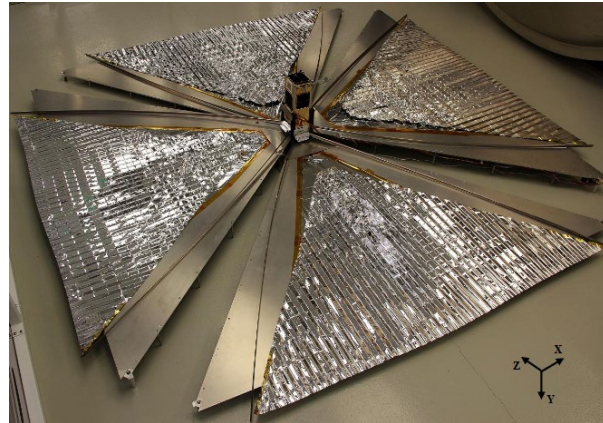
Table 13-1: Launched Drag Devices Deorbit Systems

Product	Manufacturer	Mission host and launch mass (kg)	Device mass (kg)	Initial orbit	Launch Year	Deployment Year	Drag area (m <sup>2</sup> )	TRL	Citation
NanoSail-D2	NASA MSFC/ARC	FASTSAT (4.2)	N/A	650 km 72 deg inc	2010	2011	10	7-9	(1)
Drag-Net	MMA Design	ORS-3 Deployed a Minotaur Upper Stage (100)	2.8	N/A	2016	2016	14	7-9	(5)
Icarus-1	Cranfield Aerospace Solutions	SSTL TechDemoSat-1 (157)	3.5	635 km	2014	2019	6.7	7-9	(6)
Icarus-3	Cranfield Aerospace Solutions	Carbonite-1 (80)	2.3	650 km 98 deg inc	2015	Future (in-orbit)	2	7-9	(6)
DOM	Cranfield Aerospace Solutions	ESEO (45)	0.5	572 km × 588 km 97.77 deg	2018	Future (in-orbit)	0.5	7-9	(6)
Terminator Tape	Tethers Unlimited, Inc.	Prox-1 (71)	0.808	717 km 24 deg	2019	2019	10.5	7-9	(7)
DragSail	Surrey Space Centre	InflateSail (3.2)	N/A	505 km 97.44 deg	2017	2017	10	7-9	(8)
Exo-Brake	NASA	TechEdSat 5 (3.4)	TBC	405 km 51.5 deg	2014	2015	0.35	7-9	(9)
removeDebris	Surrey Space Centre	100	N/A	405 km 51.5 deg	2018	2019	16	7-9	(10)
CanX-7	UTIAS-SFL	3U CubeSat (3.6)	0.800 (4 modules of 0.200)	688 km 98 deg	2016	2017	4	7-9	(11)

Several small spacecraft missions have built and launched passive deorbit technologies in the past using a drag sail or boom. The NanoSail-D2 mission, which was deployed in 2011 from the minisatellite *FASTSat-HSV* into a 650 km altitude and 72° inclined orbit, demonstrated the deorbit capability of a low mass, high surface area sail. The 3U spacecraft, developed at NASA Marshall Space Flight Center (MSFC), reentered Earth's atmosphere in September 2011.

CanX-7, still in orbit at an initial 800 km Sun-synchronous orbit (SSO), deployed a drag sail in May 2017. The sail was developed and tested at University of Toronto Institute for Aerospace Studies Space Flight Laboratory (UTIAS-SFL) figure 14.3).

The CanX-7 deorbit technology consists of a thin film sail that is divided in four individual modules that each provide 1 m<sup>2</sup> of drag area. These sail sections are deployed mechanically with spring booms, which help to preserve the geometry. Each module also has electronics for individual telemetry and command. This feature allows different sections to be controlled separately to mitigate risk of a single failure, and to allow custom adaptability to various spacecraft geometries and ballistic coefficient requirements for other missions. For the 2017 deployment, all four segments functioned successfully. The deorbit performance was measured after a month. The deorbit profile showed that the effects of the sail segments accounted for an altitude decay rate at the time of measurement of 20 km s<sup>-1</sup> per year, which results in a significant increase from the previous 0.5 km s<sup>-1</sup> per year. These rates are expected to increase as the atmospheric density increases exponentially with lower altitudes (11).



*Figure 13.3: CanX-7 deployed drag sail during testing. Credit: Cotten et al. (2017).*

The Technology Educational Satellite, TechEdSat-n, program at NASA Ames Research Center (ARC) has contributed significantly to the development of drag devices. It consists of a series of nanosatellite technology demonstrations in collaboration with several universities including San Jose State University and the University of Idaho. One of the main goals of the program is to test and improve deorbiting techniques, and develop a unique targeting capability with their own drag device design known as the Exo-Brake. The Exo-Brake deorbit system is an atmospheric braking system that distinguishes itself from other drag devices since it is more akin to a parachute instead of a solar sail due to its primary tension-based elements. This becomes fundamental for accurate deorbit targeting since the device must retain its shape without collapsing during those critical reentry moments occurring at the atmosphere interface altitude of 100 km, known as the Von Karman line (12).

The Exo-Brake was first implemented as a passive deorbit device on the TechEdSat missions TES 3, TES 4, and TES 5. Recent CubeSats have also used it for controlled mission deorbiting. The exo-brake development is funded by the Entry Systems Modeling project within the NASA Space Technology Mission Directorate's (STMD) Game Changing Development (GCD) program. Two of the four TechEdSat spacecraft using a passive Exo-Brake are TechEdSat-5 and TechEdSat-7, with TechEdSat-12 and TechEdSat-13 also planned to use variations of the TechEdSat-7 design. TechEdSat-5 was deployed from the ISS in 2017 and demonstrated this deorbiting capability after 144 days in orbit with the Exo-Brake deploying at 400 km. TechEdSat-

7 is a 2U CubeSat that launched on January 17, 2021, onboard Virgin Orbit's LauncherOne rocket and placed into orbit at 500 km (13).

The Surrey Space Centre based in the United Kingdom has developed the DragSail technology, which was implemented in a family of missions. The Inflatesail 3U CubeSat first demonstrated this technology. The European Commission QB50 program and the DEPLOYTECH partnership that included DLR and NASA Marshall Space Flight Center, among others, funded it. This mission was launched in 2017 and included a mast/drag-sail technology that successfully deorbited the satellite in just 72 days. This achievement was the first time a spacecraft has deorbited using European inflatable and drag-sail methods (8).



Figure 13.4: TechEdSat-10 deployment from the ISS in July 2020. Credit: NASA.

The RemoveDebris mission was developed under the European Commission FP7 program by a consortium of several institutions such as Airbus and the Surrey Space Centre. The mission consisted of a small spacecraft of 100 kg that was deployed from the ISS in 2018. One of the experiments it carried was a passive drag augmentation device consisting of a sail. The sail was deployed in March 2019, however, trajectory data showed it only partially deployed since no significant altitude change was measured. The lessons learned from this incident were implemented in another version for the Space Flight Industries' SSO-A mission that incorporated two of these sails. In that case, the assembly did not include an inflatable boom (10).

As part of the ESA CleanSat program, Cranfield Aerospace Solutions in the United Kingdom has also developed a variety of drag augmentation systems. The first demonstrated technology was the Icarus-1, which flew in the TechDemoSat-1 mission from SSTL, launched in 2014 (see figure 13.5). Another version also flew in the Carbonite-1 spacecraft, launched in 2015. The concept is similar to other drag devices in which the drag increases by deploying a membrane sustained by rigid booms. The Icarus technology consists of a thin aluminum structure located around the satellite side panel that contains four stowed Kapton trapezoidal sails and booms. The mass of the system is 3.5 kg for about 5 m<sup>2</sup> of sail area for the Icarus-1, and 2.3 kg for 2 m<sup>2</sup> for the Icarus-3. Both sails deployed successfully and are expected to deorbit both spacecraft in less than 10 years. The second technology developed by Cranfield Aerospace Solutions is a De-orbit mechanism (DOM) device which consists of a version of the drag sail presented in a smaller cuboid outline. The mechanical system varies from Icarus since the sails are triangular and the booms work as tape springs themselves. This system flew in the European Student Earth Orbiter on a 45 kg satellite that carried several student payloads. Among them, the

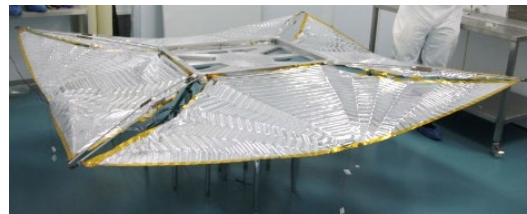


Figure 13.5: Icarus-3 drag sail implemented in the Carbonite-1 mission. Credit: Cranfield Aerospace Solutions.

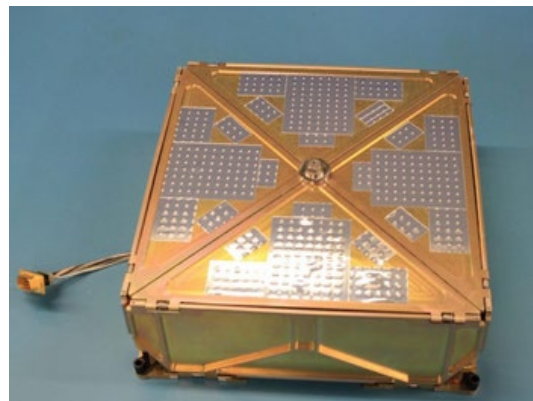


Figure 13.6: DragNet module. Credit: MMA Design LLC.



Cranfield University DOM module will deorbit the spacecraft after decommissioning. The sail has an area of 0.5 m<sup>2</sup> with a mass of 0.5 kg (6).

MMA Design LLC, a company from Colorado, has patented the dragnet deorbit system. The 2.8 kg module (figure 13.6) deorbited the ORS-3 Minotaur Upper Stage in 2.1 years after launch in November 2013. DragNet features four stowed thin membranes that deploy through a single heater-powered actuator. The sail has an area of 14 m<sup>2</sup> that can effectively deorbit a 180 kg spacecraft at an altitude of 850 km in less than 10 years (5).

Redwire Space holds an exclusive license for the Flexible Unfurlable and Refurlable Lightweight (FURL) solar sail developed and tested by the Air Force Research Laboratory (AFRL). FURL extends and retracts with four booms stored around a common hub. Small satellites can employ solar sails to control attitude, change planes or remain in their proper orbits and then retract the sail once it reached its deep space destination.

### 13.2.2 Deployable Booms

Deployable booms, while not strictly a deorbit device themselves, compose a vital part of most deorbit systems. They are structural components that can stowed during launch, then deployed once in space to provide the support structure required for various drag sail designs. More specific information regarding deployable booms can be found in the Chapter 6: Structures, Materials, and Mechanisms.

In 2019, the first ROC-FALL drag-based deorbit device was launched on the General Atomics OTB-1 spacecraft (38). Built by Redwire Space, the ROC-FALL device consists of a rectangular sail supported by a High Strain Composite (HSC) boom that is co-wrapped on a spool and restrained with a strap for stowage. The ROC-FALL system is scalable both in width and length to accommodate a variety of spacecraft sizes, and the heritage system sail measures 3.8 x 0.45 m in deployed area and rolls to a 0.04 x 0.45 m tube + supporting mechanism. The ROC-FALL is tip-rolled and passively deployed from the spacecraft. Redwire Space offers a variety of deployable boom technologies with a wide range of applications on small spacecrafts including open lattice mast, rollable tubes, and telescopic booms that can be applied on small spacecraft.

Composite Technology Development, Inc. has developed the Roll-Out DeOrbiting device (RODEO) that consists of a lightweight film attached to a simple, ultra-lightweight, roll-out composite boom structure (figure 13.7). This is a self-deploying system where the stored strain energy of the packaged boom provides the necessary deployment force. It was successfully deployed on suborbital RocketSat-8 (138 kg) on August 13, 2013 (14).



Figure 13.7: RODEO stowed. Credit: Composite Technology Development, Inc.

### 13.2.3 Electromagnetic Tethers

In addition to drag sails, an electromagnetic tether has proven to be an effective deorbit method (figure 13.8). This technology uses a conductive tether to generate an electromagnetic force as the tether system moves relative to Earth's magnetic field. Tethers Unlimited developed Terminator Tape that uses a burn-wire release mechanism to actuate the ejection of the Terminator's cover, deploying a 70 m long conductive tape at the conclusion of the small spacecraft mission (7). There are currently two main modules. The first, NSTT for NanoSats has a mass of 0.808 kg. The second, CSTT, is made for CubeSats and has a mass of just 0.083 kg. Figure 13.9 shows an image of both systems respectively (16). The 70 m long NSTT has been implemented in the 71 kg Prox-1 satellite, launched in mid-2019 by AFRL. Tethers Unlimited is also working with Millennium Space Systems, RocketLab, and TriSept Corp. on an experiment called DragRacer, which will consist of a satellite with the Terminator Tape, and another without, in order to characterize the tape performance (17). The AeroSpace Corporation 2 kg and 1.5 AeroCube 5A and 5B CubeSats, launched in 2015, also incorporated a version of the Terminator Tape and are still on orbit as of June 2021.

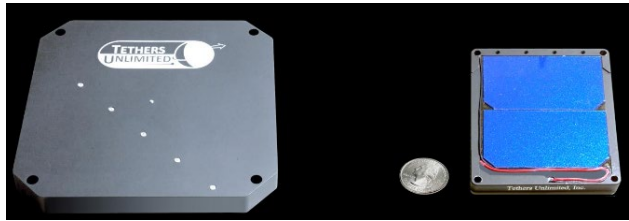


Figure 13.8: Image of the NSTT (left) and the CSTT modules. Credit: Tethers Unlimited.

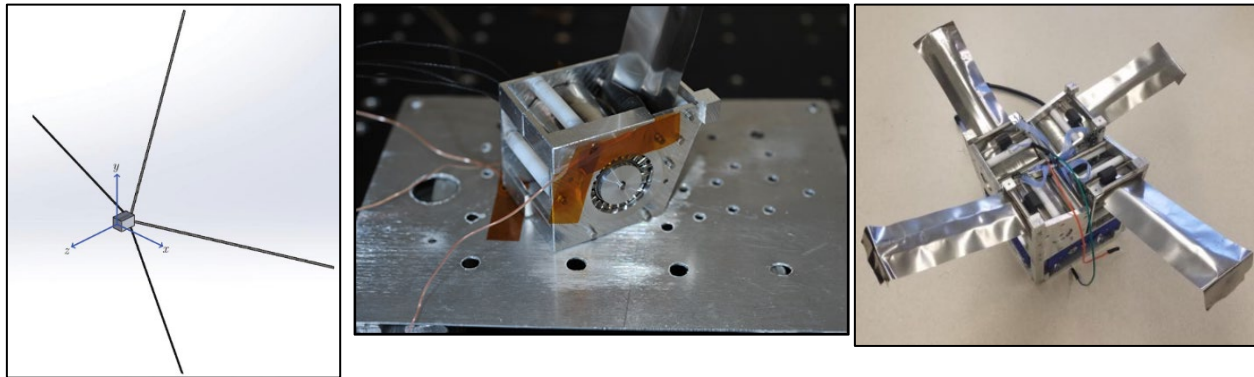


Figure 13.9: D3 CAD design (left), boom inside thermal vacuum chamber (center), and prototype design (right). Credit: Omar et al., 2019, and Martin et al., 2019.

On the horizon, two universities are developing innovative new drag devices for upcoming missions. The University of Florida is developing the Drag Deorbit Device (D3) 2U CubeSat which provides attitude stabilization and modulation of the satellite drag area at the same time, making the overall solution an alternative to regular ADCS units. Four 3.7 m long tape spring booms form the D3, which can deorbit a 15 kg satellite from an altitude of 700 km. A final design has already been tested and simulated, including thermal vacuum and fatigue testing (18) (19). Figure 13.9 shows two images of the final design. The mission has been selected by NASA through the CubeSat Launch Initiative, which includes eligibility for placement on a launch manifest (20). As of June 2021 it is going through final assembly and testing, and is expected to launch to the ISS in early December.

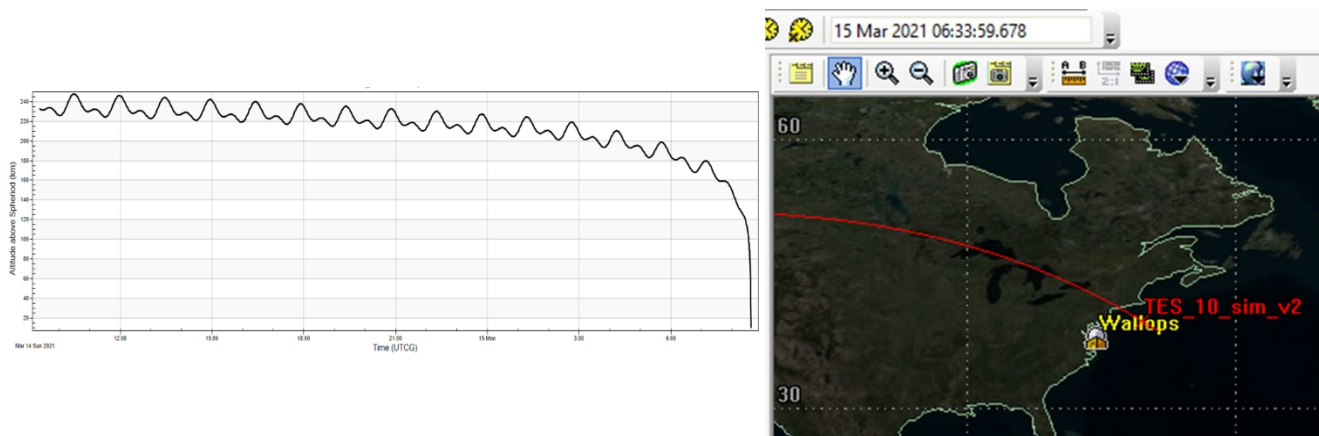
Purdue University has developed a drag device with a pyramid geometry that can deorbit a satellite placed in a geosynchronous transfer orbit (GTO). The Aerodynamic Deorbit Experiment will be the technology demonstration of this concept, and it will consist of a 1U CubeSat. It will be deployed from a Centaur upper stage in a future Atlas V rocket from United Launch Alliance. Once

deployed, the device will occupy an area of about one  $\text{m}^2$  to decrease the ballistic coefficient of the spacecraft and reduce the perigee altitude during each pass. Consequently, the expected lifetime of the ADE mission will be 50 – 250 days instead of the estimated seven years (21). The technology has been licensed to Vestigo Aerospace which is commercializing the drag device with their Spinnaker series of drag sails and has been awarded funding from NASA's Phase II Small Business Innovation Research (SBIR) Program (37).

### 13.3 State-of-the-Art – Active Systems

Several companies have been increasingly offering active spacecraft-based deorbit systems. Space startups such as AstroScale, ClearSpace, and D-orbit have long-term plans and have already started initial technology demonstrator missions. These systems consist of separate, dedicated spacecraft that attach to decommissioned satellites to place them into decaying or graveyard orbits. In December 2019, Iridium stated that they would like to pay for an active deorbit system to remove 30 of their defunct satellites (22). In addition, NASA STD-8719.14A stipulates that all spacecraft using controlled reentry processes must be within 370 km of the target when landing (10). Therefore, future concepts such as sample return missions are going to need active reentry devices to satisfy these requirements.

This section covers some of the main stakeholders in the industry that are working towards the implementation of active space debris removal, as well as some other promising technologies that can potentially be used for actively deorbiting spacecraft in the future.



*Figure 13.10: Targeting of the TES 10 Exo-brake is achieved by modifying the drag area of the modulating Exo-brake. (Left) the plot includes actual GPS readings and the approximate ballistic coefficient achieved at different parts of the mission. Credit: Jose Alvarellos et al 2021. (Right) the simulated reentry location of TES 10. Credit: Sanny Omar. The spacecraft overshoot but still demonstrated the capability to target a particular location by modifying its ballistic coefficient. Credit: NASA.*

#### 13.3.1 TechEdSat Series Exo-Brake

The Exo-Brake introduced earlier in the passive systems also has active control capability. The TechEdSat-6 mission was the first one implementing this technology, on a 3.5U CubeSat with a mass of 3.51 kg that deployed its Exo-Brake from the rear of the satellite. It targeted a reentry over Wallops Flight Facility by modulating the drag device to adjust the ballistic coefficient as orbital determination about the satellite state became available over time. The Iridium gateway enabled the command of the brake, which proved to significantly affect the reentry time and consequently, the location of the Wallops target area. The spacecraft overshoot the intended target range slightly as shown in the second image, since it could not achieve a lower  $4 - 5 \text{ kg m}^{-2}$



ballistic coefficient configuration, which would have yielded suitable results if placed at 300 km. However, the mission successfully demonstrated the reentry experiment and the command/control capability by overflying Wallops right before reentering. This technology was going to be demonstrated again in the TechEdSat-8 mission, and although a power system failure occurred before the targeting process. It should be noted that the Exo-Brake was successfully deployed on TES 8, and was an improved version of the previous TES 5 and TES 6 devices. The ballistic coefficient range was larger ( $6 - 18 \text{ kg m}^{-2}$ ) which allows better control authority for targeting. TES 10 and upcoming TES 11 are also incorporating this design (12). TES 10 marked the second targeted deorbit flight test and successfully overflow NASA Wallops Flight Facility much like TES (33). There was insufficient control over the ballistic coefficient and the re-entry occurred an orbit later than expected. TES 11 will be using the modulated drag device to perform a GTO aero-pass maneuver and perigee tailoring.

### **13.3.2 RemoveDebris Consortium Partners**

The RemoveDebris mission carried two 2U CubeSats that were ejected from the mothership to simulate space debris and demonstrate active deorbit capabilities. The first CubeSat, known as DebrisSat-1, deployed at a very low velocity from the main spacecraft and subsequently inflated a balloon that provided a larger target area. A 5 m diameter net was ejected from the main spacecraft just 144 seconds after deployment, capturing the CubeSat at a distance of  $\sim 11$  m from the mothercraft. The object, once enveloped in the net, re-entered the atmosphere in March 2019 (10). The RemoveDebris mission also carried another active debris technology consisting of a harpoon. In this scenario, a target platform attached to a boom was deployed from the main spacecraft. The mothership then released the harpoon at 19 m/s to hit the platform in the center. Once that occurred, the 1.5 m boom that connected the two objects snapped on one end. However, a tether secured the target in place, avoiding the creation of new debris. This resulted in the first demonstration of a harpoon technology in space. The harpoon target assembly had a dry mass of 4.3 kg (10).

### **13.3.3 Astroscale**

Astroscale is a company founded in Japan with offices in the UK, the US, and Singapore. Their two main objectives are to provide services to address the end-of-life (EOL) scenario of newly launched satellites, and to proactively remove existing space debris. They collaborate with a variety of governmental and international organizations around the world (such as the US government, ESA, the European Union, or the United Nations) in order to position themselves as leaders of a more sustainable low-Earth orbit environment.

As part of the EOL campaign, the ELSA-d mission, which launched on March 23, 2021, consists of two spacecraft, with one acting as a 'servicer' and the other as a 'client' (29). They have launch masses of  $\sim 175$  kg and  $\sim 17$  kg respectively. The concept of operations is to perform rendezvous maneuvers by releasing the client from the servicer repeatedly to demonstrate the capability of finding and docking existing debris. The technology demonstrations will include search and inspection of the targets, as well as rendezvous of both tumbling and non-tumbling cases (30).

Regarding their active debris removal campaign, Astroscale is also working with national space agencies to incorporate solutions to remove critical debris such as rocket upper stages or defunct satellites. This campaign started with a partnership with the Japanese Space Agency (JAXA) in February 2020. This collaboration will result in the implementation of the Commercial Removal of Debris Demonstration project (CRD2) which consists of the removal of a large space debris object performed in two mission phases. Astroscale will be involved in the first part, with a satellite that identifies and acquires data from an upper stage rocket object from Japan. The company is responsible for manufacturing and operating the satellite to complete these tasks, with a planned demonstration in 2022 (23) (24).





Astroscale announced in May a \$3.5 million funding award from OneWeb, the global communications network, to further develop their technology with the goal of commercial services starting in 2024. The next iteration consists of the ELSA-M satellite which will be capable of deorbiting multiple satellites per mission. One Web has also committed to including a docking plate on their satellites that would facilitate future deorbit missions (31).

#### 13.3.4 ClearSpace

ClearSpace is a Swiss company founded as a spin-off from the Ecole Polytechnique Federale de Lausanne research institute. Their plans also include service contracts for active debris removal. One of their proposed missions, ClearSpace One, which has been backed by ESA, will find, target, and capture a non-cooperative, tumbling 100 kg Vega Secondary Payload Adapter (VESPA) upper stage. The chaser spacecraft will be launched into a 500 km orbit for commissioning and initial testing before raising its altitude to 660 km where the VESPA is located, where it will attempt rendezvous and capture. ClearSpace One will use a group of robotic arms to grab the upper stage and then both spacecraft together will be deorbited to a lower orbit for a final disintegration in the atmosphere. The mission is planned to launch in 2025 to help establish a market for in-orbit servicing and debris removal (25).

#### 13.3.5 Momentum

Momentum is a company founded in 2017 and based in California that operates space transportation systems that can propel or deorbit other spacecraft. Their Vigoride platform can carry satellites with masses up to 250 kg. With a wet mass of 215 kg, it can provide up to 1.6 km s<sup>-1</sup> for 50 kg payload, through a water plasma propulsion system (26). Although the main objective of this system is to provide enhanced propulsive capability to their customers, the platform is suitable for active deorbiting. Momentum has booked several Vigoride missions on Falcon 9 launches through 2021 and 2022 with the first operational mission delayed until later in 2021 (32).

#### 13.3.6 D-orbit

D-orbit is a space transportation company founded in 2011 in Italy, with subsidiaries in Portugal, the United Kingdom, and the United States. It provides transportation services onboard their ION CubeSat carrier platform that can provide precision deployment and is able to host satellites from 1 to 12U. The first mission Origin released 12 SuperDove satellites from the Earth-observation company Planet, deploying the first in September 2020 with the last SuperDove deployed about a month later (34). The most recent Pulse mission finished deploying 20 satellites May 11, 2021 (35). Future versions of this technology will consider other applications such as retrieving orbiting spacecraft to deorbit them. In addition, D-orbit provides an external solid motor booster specifically for deorbiting purposes. This independent module, known as D-Orbit Decommissioning Device (D3) shown in figure 13.11, is a proprietary solution that is optimized for end-of-life maneuvers (27).

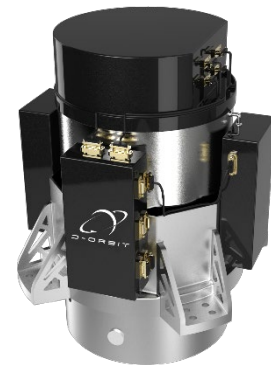
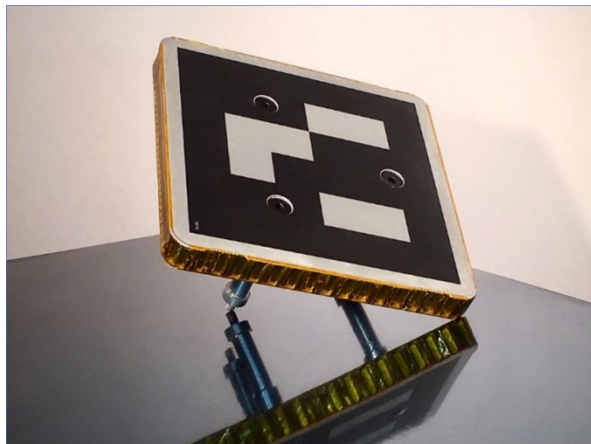


Figure 13.11: D-Orbit D3 module. Credit: D-orbit.

### 13.3.7 Altius Space Machines

In 2019, the satellite constellation company OneWeb signed a partnership with Altius Space Machines from Boulder, Colorado, to include a grappling fixture on all their future launched satellites in an effort to make space more sustainable. On January 14, 2021, it was announced that the first batch of DogTags were launched into space on OneWeb satellites (36). The Altius DogTag consists of a universal interface for small satellites that is inexpensive and lightweight. The fixture design enables various grappling techniques to enable servicing or decommissioning. It uses magnetic capabilities as its primary capture mechanism but is also compatible with other techniques in an effort to accommodate other potential customers and act as a standard interface (28). More specifically, it is compatible with magnetic attraction, adhesives, mechanical, and



Bounding Volume	150mm x150mm x 65mm
Total Mass	250g
Mounting Interface	3x M5x0.8 threaded inserts on an 84.5mm bolt-hole circle
Compatible Gripping Methods	Magnetic Capture Adhesive Capture - Electrostatic - Gecko - Hot-Melt - Chemical Mechanical Capture - Pinch-Grasp - Snare Penetrating Capture (Harpoon)

Figure 13.12: DogTag prototype. Credit: Altius Space Machines.

harpooning captures. Figure 13.12 includes an image of the prototype and a table with DogTag main features.

## 13.5 Summary

The new space paradigm and the increasing population of spacecraft in low-Earth orbit requires deorbiting systems that can satisfy space debris requirements. Small spacecraft deorbit systems have matured significantly over the past few years. Several passive systems have flown on various missions and increased to TRL 9 after successful technology demonstrations. Drag sails are the main technology, and several companies have already commercialized and sold these products. Other systems such as electromagnetic tethers, deployable booms, or the NASA Exo-brake have also already been prototyped and demonstrated in space. In addition, active systems that include commanded and modulated systems, as well as independent servicing spacecraft, are also maturing and will play a fundamental role in the upcoming years. A version of the Exo-Brake with pointing capabilities has been demonstrated in the TechEdSat-10 mission, while the RemoveDebris mission has successfully tested two different active methods, a net and a harpoon, for future implementation in active debris removal operations. Companies such as Astroscale, Momentus, D-Orbit, or ClearSpace are already developing and planning to launch servicing spacecraft that can attach to decommissioned satellites to bring them down to a graveyard orbit or disintegrate in the atmosphere. In conclusion, this technology has increased significantly in maturity since the last iteration of this report and is expected to grow as the demand for deorbiting services increases with additional launches.

For feedback solicitation, please email: [arc-sst-soa@mail.nasa.gov](mailto:arc-sst-soa@mail.nasa.gov). Please include a business email so someone may contact you further.



## References

- (1) NASA. Process for Limiting Orbital Debris. *standards.nasa.gov*. [Online] 2012.
- (2) ESA. Space Debris by the Numbers. [Online] April 15, 2021. [Cited: May 26, 2021.] [https://www.esa.int/Safety\\_Security/Space\\_Debris/Space\\_debris\\_by\\_the\\_numbers](https://www.esa.int/Safety_Security/Space_Debris/Space_debris_by_the_numbers).
- (3) NASA. *Process for Limiting Orbital Debris*. s.l.: NASA-STD-8719.14B, 2019.
- (4) Bonin, G., et al.: "*The CanX-7 Drag Sail Demonstration Mission: Enabling Environmental Stewardship for Nano- and Microsatellites*." 2013, 27th Annual AIAA/USU Conference on Small Satellites.
- (5) MMA Design. dragNET™ De-Orbit System. *MMA Design: Products*. [Online] 2020. <https://mmadesignllc.com/product/dragnet-de-orbit-system/>.
- (6) Palla, Chiara, Kingston, Jenny and Hobbs, Stephan. Damstadt: "Development of Commercial Drag-Augmentation for Small Satellites." ESA Space debris Office, Ed. T. Flohrer & F. Schimtz, 2017.
- (7) 7. *The Terminator Tape: A Cost-Effective De-Orbit Module for End-of-Life Disposal of LEO Satellites*. R. P. Hoyt, I. M. Barnes, N. R. Voronka, and J. T. Slostadin. 2009. AIAA Space 2009 Conference.
- (8) 8. *InflateSail de-orbit flight demonstration results and follow-on drag-sail applications*. Underwood, Craig, et al. s.l.: Acta Astronautica, 2019, Vols. 162, pages 344-358. ISSN: 0094-5765.
- (9) 9. *TechSat 5/PhoneSat 5 (T5/P5)*. Murbach, M. , et al. Logan: Conference on Small Satellites, 2016.
- (10) 10. *The active space debris removal mission RemoveDebris. Part 2: in orbit operations*. Aglietti, Guglielmo, et al. s.l.: Acta Astronautica, Elsevier, 2020, Vols. 168, pp. 310-322.
- (11) 11. *On-Orbit Results from the CanX-7 Drag Sail Deorbit Mission*. Cotten, Brad, Bennett, Ian and Zee, Robert E. s.l.: 131stAnnual AIAA/USUConference on Small SatellitesSSC17-X-06 , 2006.
- (12) 12. *The Exo-Brake as an Inexpensive Means of Achieving Sample Return from Low Earth Orbit – Recent Flight Tests*. Murbach, M., et al. Washington, D.C.: 70th International Astronautical Congress (IAC), 2019.
- (13) 13. Figliozzi, Gianine. TechEDSat-7's Flight Mission Begins. NASA. [Online] January 27, 2021. [Cited: May 26, 2021.] <https://www.nasa.gov/image-feature/ames/techedsat-7-s-flight-mission-begins>.
- (14) 14. "*Flight Testing of a Low Cost De-Orbiting Device for Small Satellites*." Turse, D., et al. 2013. Proceedings of the 42nd Aerospace Mechanisms Symposium.
- (15) 15. P. Harkness, M. McRobb, P. Lutzkendorf, R. Milligan, A. Feeney, and C. Clark. *Development status of AEOLDOS: A deorbit module for small satellites*. 2014.
- (16) 16. Hoyt, Robert, et al. *The Terminator Tape: A Cost-Effective De-Orbit Module for End-of-Life Disposal of LEO Satellites*. 2020.
- (17) 17. Caleb Henry. Tethers Unlimited says early results of deorbit hardware test promising. *Space News*. [Online] 01 23, 2020. <https://spacenews.com/tethers-unlimited-says-early-results-of-deorbit-hardware-test-promising/>.



- (18) 18. *CubeSat Mission to Demonstrate Aerodynamically Controlled Re-Entry using the Drag De-Orbit Device (D3)*. Omar, Sanny, et al. Logan: 32nd Annual AIAA/USU Conference on Small Satellites, 2018.
- (19) 19. *Controlled Spacecraft Re-Entry of a Drag De-Orbit Device (D3)*. Martin, Tanya, Omar, Sanny and Bevilacqua, Riccardo. 1, s.l.: University of Florida, Journal of Undergraduate Research, 2019, Vol. 21.
- (20) 20. NASA. NASA Announces Tenth Round of Candidates for CubeSat Space Missions. [Online] 03 14, 2019. <https://www.nasa.gov/feature/nasa-announces-tenth-round-of-candidates-for-cubesat-space-missions>.
- (21) 21. Purdue University: Missions: "ADE (Aerodynamic Deorbit Experiment)." [Online] 2017. [Cited July 1, 2021]. <https://engineering.purdue.edu/CubeSat/missions/ade>
- (22) 22. Caleb Henry. Iridium would pay to deorbit its 30 defunct satellites — for the right price. *Spacenews*. [Online] 12 30, 2019. <https://spacenews.com/iridium-would-pay-to-deorbit-its-30-defunct-satellites-for-the-right-price/>.
- (23) 23. *The ELSA-d End-of-life Debris Removal Mission: Preparing for Launch*. Blackerby, Chris, et al. Washington D. C. : 70th International Astronautical Congress (IAC), 2019.
- (24) 24. Astroscale. End of Life (EOL). *Astroscale*. [Online] 10 2019.
- (25) 25. ClearSpace One. Find: How do we locate satellites or debris? *ClearSpace Today*. [Online] 2020. [Cited: 03 28, 2020.] <https://clearspace.today/546-2/>.
- (26) 26. Momentus. Vigoride User Guide. 2020.
- (27) 27. *Controlled Spacecraft Re-Entry of a Drag De-Orbit Device (D3)*. Martin, Tanya, Omar, Sanny and Bevilacqua, Riccardo. 1, University of Florida : Journal of Undergraduate Research, 2019, Vol. 21.
- (28) 28. *The development of commercially viable ADR services: Introduction of a small-satellite grappling interface*. Maclay, Timothy, et al. s.l. : First International Orbital Debris Conference, 2019.
- (29) 29. Astroscale Press Release. Astroscale Celebrates Successful Launch of ELSA-d. *Spacenews*. [Online] 03 23, 2021. [Cited: June 1, 2021.] <https://astroscale.com/astroscale-celebrates-successful-launch-of-elsa-d/>
- (30) 30. Astroscale ELSA-d Launch Press Kit. 2021.
- (31) 31. Astroscale Press Release. "Astroscale UK Signs £2.5 Million Agreement to Develop Space Debris Removal Technology Innovations with OneWeb." [Online] May 24, 2021. <https://astroscale.com/astroscale-uk-signs-2-5-million-agreement-to-develop-space-debris-removal-technology-innovations-with-oneweb/>
- (32) 32. J. Foust: "Momentus delays first Vigoride launch." [Online] January 7, 2021. <https://spacenews.com/momentus-delays-first-vigoride-launch/>
- (33) 33. Tavares, Frank. TechEDsat-10 Deploys from the Space Station. NASA. [Online] August 5, 2020. [Cited: May 26, 2021.] <https://www.nasa.gov/image-feature/ames/techedsat-10-deploys>.
- (34) 34. D-Orbit Press Release. "D-Orbit announces successful ORIGIN mission." [Online] October 20, 2020. [Cited July 1, 2021]. [D-Orbit announces successful ORIGIN mission \(spaceref.com\)](https://spaceref.com/d-orbit-announces-successful-origin-mission/)
- (35) 35. D-Orbit Press Release. "D-Orbit Successfully Completes Deployment Phase of Ongoing PULSE Mission,



- (36) Deploys 20 Satellites In-Orbit, and Executes Orbital Maneuvers." [Online] May 18, 2021. [Cited July 1, 2021].
- (37) 36. Altius Space Machines: "Voyager Subsidiary, Altius Space Machines, Inc. Announces Successful First Orbital Launch of DogTags Aboard OneWeb's Satellites." [Online] January 14, 2021. [Cited June 28, 2021]. <https://www.altius-space.com/blog/voyager-subsubsidiary-altius-space-machines-inc-announces-successful-first-orbital-launch-of-dogtags-aboard-onewebs-satellites/>
- (38) 37. Vestigo Aerospace: "Vestigo Aerospace Awarded NASA Phase II SBIR." [Online] 2021. [Cited July 3, 2021]. <https://www.altius-space.com/blog/voyager-subsubsidiary-altius-space-machines-inc-announces-successful-first-orbital-launch-of-dogtags-aboard-onewebs-satellites/>
- (39) (38) Davis., B., Tomchek, A., Turse, D., VanHalle, R., Medina, K., Francis, W., Person, C., "Planning for End-of-Life Satellite Disposal; The Story of a High Strain Composite Tip-Rolled De-Orbit Sail", 22nd Annual AIAA/USU Conference on Small Satellites, [SSC18-XII-6, pp. 1-7], Logan, Utah, 2018



## Summary

This report provides an overview and assessment of the state of the art (SoA) for small spacecraft technology publicly known or available as of June 2021. However, the reader should be aware that the pace of technology advancement for SmallSats in general is rapidly accelerating and varies per subsystem. As CubeSats become larger and SmallSats decrease in their form factors, both technology maturation and miniaturization will continue to expand their capabilities. While still fairly dominated by the CubeSat platform, the SoA report is starting to reflect increased interest in larger SmallSat systems. This is due in part to an increase in the number of launch opportunities and increased launch vehicle capabilities, as rideshares and small dedicated launchers further reduce the cost of access to space.

Small spacecraft that are larger and more capable than traditional CubeSats that can use rideshares and small dedicated launchers are receiving more attention from space scientists and mission designers. Several SmallSat missions are actively working on rideshares (or dedicated rides) through ESPA-class platforms to their destinations in 2022 – 2024. Rideshares will greatly enhance the deep space presence and science data collection of SmallSats. Commercial companies are beginning to use SmallSats for planet monitoring to observe areas of geographic interest, discover patterns, track infrastructure, and identify changes as they happen. From space, planet monitoring is helping to equip NASA, as well as state and local governments with the ground-truth data needed to make timely, informed decisions.

The launch of Artemis I will not only expand our knowledge of the lunar surface and provide a foundation for deep space human exploration, it will also contribute to bridging major SmallSat technology gaps, such as in-space propulsion, long distance communications, optical communications, and controlled landing on the lunar surface. In addition to performing technology demonstrations, most of the Artemis I six-unit (6U) payloads also have a science objective that will study the Moon or perform deep space biological or space weather experiments. The continued presence of SmallSats into deep space will foster the continuation of SmallSat technology growth and available launch opportunities.

NASA is working with several American companies to deliver science and technology to the lunar surface through the Commercial Lunar Payload Services (CLPS) initiative. Under the Artemis program, these commercial deliveries present SmallSat designers with opportunities to perform science experiments, test technologies and demonstrate capabilities to help NASA explore the Moon and prepare for human missions. NASA has initially selected 14 companies to deliver payloads for NASA, including payload integration and operations and launch services to the surface of the Moon. The NASA CLPS program will begin delivering science payloads to the Moon in 2022. CLPS contracts are indefinite delivery, indefinite quantity contracts with a cumulative maximum contract value of \$2.6 billion through 2028. Companies of varying sizes can work with selected vendors and are encouraged to fly commercial payloads in addition to the NASA payloads. For more information about NASA's Commercial Lunar Payload Services initiative, visit: <https://www.nasa.gov/clps>.

This report will be updated regularly as emerging technologies mature and become state of the art. Any current technologies that were inadvertently missed may be included in subsequent versions. This report is also available online at: <https://www.nasa.gov/smallsat-institute/sst-soa-2021>. Technology inputs, updates, or corrections can be made by reaching out to the editor of this report at [arc-sst-soa@mail.nasa.gov](mailto:arc-sst-soa@mail.nasa.gov).



## Master Acronym List

(ABS)	Acrylonitrile Butadiene Styrene
(AC)	Alternating Current
(ACE)	Apollo Constellation Engine
(ACO)	Announcement for Collaborative Opportunity
(ACS3)	Advanced Composite Solar Sail project
(ADC/DAC)	Analog to Digital/Digital to Analog
(ADCS)	Attitude Determination and Control System
(ADN)	Ammonium Dinitramide
(AE)	Aerospace Corporation Electron
(AEOLDOS)	Aerodynamic End-of-Life Deorbit system for CubeSats
(AFRL)	Air Force Research Laboratory
(AGI)	Analytical Graphics, Inc.
(AM)	Additive manufacturing
(AMODS)	Autonomous On-orbit Diagnostic System
(AOCS)	Attitude and Orbit Control System
(AP)	Aerospace Corporation Proton
(APG)	Annealed Pyrolytic Graphite
(API)	Application Programming Interface
(AR)	Aerojet Rocketdyne
(ARC)	Ames Research Center
(ASGS)	ASRF SmallSat Ground Station
(ASICs)	Application Specific Integrated Circuits
(ASIST)	Advanced Spacecraft Integration and System Test
(ASRF)	Atmospheric Sciences Research Facility
(ATA)	Active Thermal Architecture
(AWS)	Amazon Web Services
(BIRD)	Bi-Spectral Infrared Detection
(BMS)	Battery Management System
(BOL)	Beginning-of-Life
(BPF)	BandPass Filters



(BSPs)	Broadband Service Providers
(C-STs)	Celestia Satellite Test & Simulation BV
(C&DH)	Command and Data Handling
(C2)	Command & Control
(CAM)	Computer Aided Manufacturing
(CAPSTONE)	Cislunar Autonomous Positioning System Technology Operations and Navigation Experiment
(CARA)	Conjunction Assessment Risk Analysis
(CBOD)	Clamp Band Opening Device
(CCD)	Charge Couple Devices
(CCR)	Corner Cube Reflectors
(CCSDS)	Consultative Committee for Space Data Systems
(CDH)	Command and Data Handling
(CDMA)	Code Division Multiple Access
(CDS)	CubeSat Design Specification
(cFE)	core Flight Executive
(CFRPs)	Composite Fiber Reinforced Panels
(cFS)	core Flight System
(CI)	Continuous Integration
(CIGS)	Cu(In,Ga)Se <sub>2</sub>
(CM)	Configuration Management
(CMNT)	Colloid MicroNewton Thrusters
(CMOS)	Complementary Metal Oxide Semiconductors
(CNAPS)	Canadian Nanosatellite Advanced Propulsion System
(CNES)	French National Center for Space Studies
(COBRA)	Compact On-Board Robotic Articulator
(CoCom)	Coordinating Committee for Multilateral Export Controls
(COTS)	Commercial-off-the-Shelf
(CPAW)	Collection Planning and Analysis Workstation
(CPOD)	CubeSat Proximity Operations Demonstration
(CRAM)	Chalcogenide Random Access Memory
(CRC)	Cooperative Centre
(CRC)	Cyclic Redundancy Check





(CRD2)	Commercial Removal of Debris Demonstration
(CS)	Commercial Services
(CSE, USU)	Center for Space Engineering at Utah State University
(CSLI)	CubeSat Launch Initiative
(CTD)	Composite Technology Deployment
(CUA)	CU Aerospace LLC
(CUBIT)	CubeSat Identification Tag
(D/T/I)	Detection, Tracking and Identification
(D3)	Drag Deorbit Device
(DCB)	Deployable Composite Boom
(DDD)	Displacement Damage Dose
(DFMR)	Design for Minimum Risk
(DIU)	Department of Defense's Defense Innovation Unit
(DLP)	Digital Light Projection
(DLR)	German Aerospace Center
(DOF)	Degrees of Freedom
(DOM)	De-orbit Mechanism
(DPAF)	Dual Payload Attach Fittings
(DRAM)	Dynamic Random Access Memory
(DRM)	Design Reference Mission
(DSAC)	Deep Space Atomic Clock
(DSN)	Deep Space Network
(DSOC)	Deep Space Optical Communications
(DSP)	Digital Signal Processing
(DSS-17)	Deep Space Station-17
(DSSP)	Digital Solid State Propulsion LLC
(DTE)	Direct-to-Earth
(DVB-S2)	Digital Video Broadcast Satellite Second Generation
(EAGLE)	ESPA Augmented Geostationary Laboratory Experiment
(EAR)	Export Administration Regulations
(ECC)	Error-Correcting Code
(EDAC)	Error Detection and Correction



(EDUs)	Engineering Development Units
(EEE)	Electrical, Electronic and Electro-mechanical
(EELV)	Evolved Expendable Launch Vehicle
(EGSE)	Electrical Ground Support Equipment
(EGTN)	ExoAnalytic Global Telescope Network
(EIRP)	Effective Isotropic Radiated Power
(ELROI)	Extremely Low Resource Optical Identifier
(EMC)	Electromagnetic Compatibility
(EMI)	Electromagnetic Interference
(ENRCSD)	Nanoracks External CubeSat Deployer
(EOL)	End-of-Life
(EP)	Electric Propulsion
(EPS)	Electrical Power System
(EPSS)	Enabling Propulsion System for Small Satellites
(ES)	Executive Services
(ESA)	European Space Agency
(ESD)	Electrostatic Discharge
(ESPA)	EELV Secondary Payload Adapter
(ESPs)	Electrically Controlled Solid Propellant
(ESSI)	Enhanced Synchronous Serial Interface
(FASTSAT)	Fast, Affordable, Science and Technology Satellite
(FCC)	Federal Communications Commission
(FDM)	Fused Deposition Modeling
(FDMA)	Frequency Division Multiple Access
(FEC)	Forward Error Correction
(FEED)	Field Emission Electric Propulsion
(FEP)	Front End Processors
(FEP)	Fluorinated Ethylene Propylene
(FERAM)	Ferro-Electric Random Access Memory
(FETS)	Folding Elastic Thermal Surface
(FFF)	Fused Filament Fabrication
(FFRDCs)	Federally Funded Research and Development Centers



(FIPS)	Federal Information Processing Standard
(FOGs)	Fiber Optic Gyros
(FOX)	Flat-Plate Heat Pipe On-Orbit Experiment
(FPGA)	Field Programmable Gate Array
(FPPT)	Fiber-Fed Pulsed Plasma Thruster
(FSO)	Free Space Optical
(FST)	Flame, Smoke, and Toxicity
(FSW)	Flight Software
(FURL)	Flexible Unfurlable and Refurlable Lightweight
(GaN)	Galium Nitride
(GBESA)	Ground-Based Electrically-Steered Array
(GBPA)	Ground-Based Phase Array
(GCD)	Game Changing Development
(GCD)	Game Changing Development
(GEO)	Geosynchronous Equatorial Orbit
(GEVS)	General Environmental Verification Standard
(GFTS)	Graphite Fiber Thermal Straps
(GIT)	Gridded-ion Thrusters
(GNC)	Guidance, Navigation & Control
(GNSS)	Global navigation satellite system
(GOCE)	Gravity Field and Steady-State Ocean Circulation Explorer
(GOX)	Gaseous Oxygen
(GPIM)	Green Propellant Infusion Mission
(GPIO)	General Purpose Input/Output
(GPS)	Global Positioning System
(GPUs)	Graphics Processor Units
(GRC)	Glenn Research Center
(GSE)	Global Satellite Engineering
(GSFC)	Goddard Space Flight Center
(GSO)	Geo-stationary Orbit
(GTO)	Geosynchronous Transfer Orbit
(GUI)	Graphical User Interface



(HAN)	Hydroxylammonium Nitrate
(HCI)	Horizon Crossing Indicators
(HDT)	Heat Deflection Temperature
(HEC)	High Efficiency Cooler
(HEO)	Highly Elliptical Orbit
(HET)	Hall-effect Thruster
(HF)	High frequency
(HIL)	Hardware-in-the-Loop
(HSC)	High Strain Composite
(HTP)	High Test Peroxide
(HTPB)	Hydroxyl-terminated Polybutadiene
(HUSIR)	Haystack Ultrawideband Satellite Imaging Radar
(I/O)	Input & Output
(I&T)	Integration and Test
(I&T)	Integration and Testing
(IADC)	Inter-Agency Space Debris Coordination Committee
(IARU)	International Amateur Radio Union
(IDL)	Interactive Data Language
(IDs)	Identification
(IEEE)	Institute of Electrical and Electronics Engineers
(ILRS)	International Laser Ranging Service
(IMA)	Integrated Mission Architectures
(IMEI)	International Mobile Equipment Identity
(IMUs)	Inertial Measurement Units
(INCOSE)	International Council on Systems Engineering
(INNOVA)	IN-orbit and Networked Optical Ground Stations Experimental Verification Advanced Testbed
(IoT)	Internet-of-Things
(IPS)	Integrated Propulsion System
(IR)	Infrared
(ISARA)	Integrated Solar Array and Reflectarray Antenna
(ISM)	Industrial, Scientific, and Medical
(ISO)	International Organization for Standardization



(ISS)	International Space Station
(ITOS)	Integrated Test and Operations System
(ITU)	International Telecommunications Union
(J-SSOD)	JEM Small Satellite Orbital Deployer
(JAXA)	Japanese Aerospace Exploration Agency
(JEM)	Japanese Experimental Module
(JEMRMS)	Japanese Experimental Module Remote Manipulator System
(JHU ERG)	Johns Hopkins University Energetics Research Group
(JPL)	Jet Propulsion Laboratory
(JSpOC)	Joint Space Operations Center
(KGS)	Kaneka Graphite Sheets
(KSAT)	Kongsberg Satellite Services AS
(KSC)	Kennedy Space Center
(LADEE)	Lunar Atmosphere and Dust Environment Explorer
(LaRC)	Langley Research Center
(Lasercom)	Laser Communications
(LCH)	Laser ClearingHouse
(LCRD)	Laser Communications Relay Demonstration
(LCT)	LaserCom Terminals
(LDPC)	Low-Density Parity-check Code
(LDT)	Lowell Discovery Telescope
(LEDs)	Light Emitting Diodes
(LEOP)	Launch and Early Orbit Phase
(LFPS)	Lunar Flashlight Propulsion System
(Li-ion)	Lithium-ion
(LiCF <sub>x</sub> )	Lithium carbon monofluoride
(LiPo)	Lithium polymer
(LISA)	Laser Interferometer Space Antenna
(LiSO <sub>2</sub> )	Lithium sulfur dioxide
(LiSOCl <sub>2</sub> )	Lithium thionyl chloride
(LLCD)	Lunar Laser Communications Demonstration
(LMRST)	Low Mass Radio Science Transponder



(LNA)	Low Noise Amplifier
(LVDS)	Low-Voltage Differential Signaling
(M-OMV)	Minotaur Orbital Maneuvering Vehicle
(MA)	Multiple Access
(MAPS)	Modular Architecture Propulsion System
(MarCO)	Mars Cube One
(MBSE)	Model-Based Systems Engineering
(MCD)	Micro-cavity Discharge
(MCS)	Mission Control Software
(MEMS)	Microelectromechanical System
(MEO)	Medium Earth Orbit
(MIL)	Military
(MLB)	Motorized Light Bands
(MLI)	Multi-Layer Insulation
(MMH)	Monomethyl Hydrazine
(MOC)	Mission Operations Center
(MOSFETs)	Metal Oxide Semiconductor Field Effect Transistors
(MPAF)	Multi Payload Attach Fittings
(MPEP)	Multi-Purpose Experiment Platform
(MPFL)	Mechanically Pumped Fluid Loop
(MPUC)	Monopropellant Propulsion Unit for CubeSats
(MRAM)	Magnetoresistive Random Access Memory
(MRR)	Modulating Retro-Reflector
(MSFC)	Marshall Space Flight Center
(MSPA)	Multiple Spacecraft Per Aperture
(MTBF)	Mean Time Between Failures
(MVP)	Monofilament Vaporization Propulsion
(MWIR)	Midwave Infrared
(N <sub>2</sub> O)	Nitrous Oxide
(NEA)	Near-Earth Asteroid
(NEN)	Near Earth Network
(NiCd)	Nickel-cadmium



(NICT)	National Institute of Information and Communications Technology
(NiH <sub>2</sub> )	Nickel-hydrogen
(NIMO)	Networks Integration Management Office
(NIST)	National Institute of Standards and Technology
(NLAS)	Nanosatellite Launch Adapter System
(NMF)	NanoSat MO Framework
(NMF)	NanoSat MO Framework
(NOAA)	National Oceanic and Atmospheric Administration
(NODIS)	NASA Online Directives Information System
(NORAD)	North American Aerospace Defense Command
(NRCSD)	Nanoracks ISS CubeSat Deployer
(NRHO)	Near Rectilinear Halo Orbit
(NSTAR)	Naval Academy Satellite Team for Autonomous Robotics
(NSTT)	Nanosat Terminator Tape
(NTE)	Nanosatellite Tracking Experiment
(NTIA)	National Telecommunications and Information Administration
(OCTL)	Optical Communications Telescope Laboratory
(OGS)	Optical ground stations
(OMV)	Orbital Maneuvering Vehicle
(OPV)	Organic Photovoltaic
(OSAL)	Operating System Abstraction Layer
(OSCAR)	Optical Sensors based on carbon materials
(OTS)	Orbital Transfer System
(OTV)	Orbital Transfer Vehicle
(P-POD)	Poly-Picosatellite Orbital Deployer
(PacSci EMC)	Pacific Scientific Energetic Materials Company
(PAEK)	Polyaryletherketone
(PBM)	Plasma Brake Module
(PC)	Polycarbonate
(PCB)	Printed Circuit Board
(PCBM)	Cygnus Passive Common Berthing Mechanism
(PCM)	Phase Change Memory



(PEASSS)	Piezoelectric Assisted Smart Satellite Structure
(PEEK)	Polyetheretherketone
(PEI)	Polyetherimide
(PEKK)	Polyetherketoneketone
(PET)	polyethylene terephthalate
(PFL)	Pumped Fluid Loop
(PGF)	Pyrovo Pyrolytic Graphite Film
(PGS)	Pyrolytic Graphite Sheets
(PIL)	Processor-in-the-loop
(PLA)	Polylactic Acid
(PLEO)	Polar Low-Earth Orbit
(PMAD)	Power management and distribution
(PMD)	Propellant Management Device
(PMI)	Progress toward Mission Infusion
(PMMA)	Polymethyl Methacrylate
(PMSM)	Permanent-magnet Synchronous Motor
(PNT)	Positioning, Navigation, and Timing
(PPM)	Pulse Position Modulation
(PPP)	Public-Private Partnership
(PPS)	Precise Positioning System
(PPT)	Pulsed Plasma Thrusters
(PPU)	Power Processing Unit
(PRISM)	Portable Remote Imaging Spectrometer
(PSA)	Payload and Subsystems Avionics
(PSC)	Planetary Systems Corporation
(PTD)	Pathfinder Technology Demonstration
(PTFE)	Polytetrafluoroethylene
(PUC)	Propulsion Unit for CubeSats
(PZT)	Lead-Zirconium-Titanium Oxide
( $q_{\text{albedo}}$ )	Solar heating reflected by the planet
( $Q_{\text{gen}}$ )	Heat generated by the spacecraft
(QML)	Qualified Manufacturers List





( $Q_{out,rad}$ )	Heat emitted via radiation
( $q_{planetshine}$ )	IR heating from the planet
( $q_{solar}$ )	Solar heating
( $Q_{stored}$ )	Heat stored by the spacecraft
(R&D)	Research and Development
(rad-hard)	radiation-hardened
(RAM)	Random Access Memory
(RECS)	Robotic Experimental Construction Satellite
(RF)	Radio Frequency
(RHUs)	Radioisotopic Heater Units
(ROC)	Roll Out Composite
(RODEO)	Roll-Out DeOrbiting Device
(ROMBUS)	Rapid Orbital Mobility Bus
(ROS)	Robot Operating System
(RSat-P)	Repair Satellite-Prototype
(RTEMS)	Real-Time Executive for Multiprocessor Systems
(RTGs)	Radioisotope Thermoelectric Generators
(RTOS)	Real Time Operating System
(SA)	Single Access
(SAA)	Space Act Agreement
(SABER)	Solid-state Architecture Batteries for Enhanced Rechargeability and Safety
(SADA)	Solar Array Drive Actuator
(SBIR)	Small Business Innovation Research
(SCaN)	Space Communications and Navigation
(SCAPE)	Self Contained Atmospheric Protective Ensemble
(SCFW)	SpaceCloud Framework
(SDK)	Software Development Kit
(SDL)	Space Dynamics Laboratory
(SDR)	Software Defined Radio
(SDST)	Small Deep Space Transponder
(SEEs)	Single Event Effects
(SEL)	Single Event Latch-up



(SEP)	Solar Electric Propulsion
(SETH)	Science Enabling Technology for Heliophysics
(SEU)	Single Event Upsets
(SFCG)	Space Frequency Coordination Group
(SI)	International System of Units
(SL-OMV)	Small Launch Orbital Maneuvering Vehicle
(SLA)	Stereolithography
(SLS)	Selective Laser Sintering
(SMA)	S-band multiple access
(SMAP)	Soil Moisture Active Passive
(SMART-1)	Small Missions for Advanced Research in Technology
(SME)	Subject Matter Expert
(SMP)	Symmetric Multiprocessing
(SN)	Space Network
(SNR)	Signal-to-Noise Ratio
(SNSPD)	Superconducting Nanowire Single Photon Detector
(SOC)	Science Operations Center
(SOTA)	Small Optical Transponder
(SPD-5)	Space Policy Directive 5
(SPEs)	Solar Particle Events
(SPOT)	Standard Passive Orbital Thermal-control
(SRAM)	Static Random Access Memory
(SRI)	Stanford Research Institute
(SSA)	Small Spacecraft Avionics
(SSA)	Space Situational Awareness
(SSBV)	Satellite Services B.V.
(SSC)	Swedish Space Corporation
(SSMS)	Small Spacecraft Mission Service
(SSN)	Space Surveillance Network
(SSO)	Sun-synchronous orbit
(SSOD)	Small Satellite Orbital Deployer
(SST)	Small Satellite Technology



(SSTL)	Surrey Satellite Technology Ltd.
(SSTP)	Small Spacecraft Technologies Program
(STELOC)	Stable Tubular Extendable Lock-Out Composite
(STMD)	Space Technology Mission Directorate
(SWaP)	Size, Weight, and Power
(TAFTS)	Two Arm Flexible Thermal Strap
(TCMs)	Trajectory Correction Maneuvers
(TDMA)	Time-Division Multiple Access
(TDO)	Technology Demonstration Orbiter
(TDRS)	Tracking and Data Relay Satellite
(TDRSS)	Tracking and Data Relay Satellite System
(TEC)	Thermoelectric Coolers
(TID)	Total Ionizing Dose
(TLE)	Two-Line Element
(TMA)	Technology Maturity Assessment
(TMR)	Triple Modular Redundancy
(TMT)	Thermal Management Technologies
(TNC)	Terminal Node Controller
(TNO)	The Netherlands Organization
(TOGS)	Transportable Optical Ground Station
(TPV)	Thermophotovoltaic
(TR)	Thermoradiative
(TRAC)	Triangle Rollable and Collapsible
(TRL)	Technology Readiness Level
(TSU)	Thermal Storage Unit
(TT&C)	Telemetry, Tracking and Control
(UAM)	Ultrasonic additive manufacturing
(UHF)	Ultra High Frequency
(ULA)	United Launch Alliance
(ULP)	Ultra-Low Power
(USAF)	U.S. Air Force
(USB)	Universal Serial Bus



(USIR)	Ultrawideband Satellite Imaging Radar
(USRP)	Universal Software Radio Peripheral
(UTIAS-SFL)	University of Toronto Institute for Aerospace Studies Space Flight Laboratory
(UTIAS)	University of Toronto Institute for Aerospace Research
(VAT)	Vacuum arc thrusters
(VENuS)	Vegetation and Environment monitoring on a New Microsatellite
(VESPA)	Vega Secondary Payload Adapter
(VHF)	Very high frequency
(VICTS)	Variable Inclination Continuous Transverse Stub
(VMs)	Virtual Machines
(WFF)	Wallops Flight Facility
(Wh kg <sup>-1</sup> )	Watt hours per kilogram

## Appendix E. Technology Readiness Levels

T R L	Definition	Hardware Description	Software Description	Success criteria
1	Basic principles observed and reported.	Scientific knowledge generated underpinning hardware technology concepts/applications .	Scientific knowledge generated underpinning basic properties of software architecture and mathematical formulation.	Peer reviewed documentation of research underlying the proposed concept/applicati on.
	<p><b>Examples:</b></p> <ul style="list-style-type: none"> <li>a. Initial Paper published providing representative examples of phenomenon as well as supporting equations for a concept.</li> <li>b. Conference presentations on concepts and basic observations presented within the scientific community.</li> </ul>			
2	Technology concept and/or application formulated.	Invention begins, practical application is identified but is speculative, no experimental proof or detailed analysis is available to support the conjecture.	Practical application is identified but is speculative; no experimental proof or detailed analysis is available to support the conjecture. Basic properties of algorithms, representations, and concepts defined. Basic principles coded. Experiments performed with synthetic data.	Documented description of the application/conc ept that addresses feasibility and benefit.
	<p><b>Examples:</b></p> <ul style="list-style-type: none"> <li>a. Carbon nanotube composites were created for lightweight, high-strength structural materials for space structures.</li> <li>b. Mini-CO<sub>2</sub> Scrubber: Applies advanced processes to remove carbon dioxide and potentially other undesirable gases from spacecraft cabin air.</li> </ul>			

	Analytical and experimental proof-of-concept of critical function and/or characteristics.	Research and development are initiated, including analytical and laboratory studies to validate predictions regarding the technology.	Development of limited functionality to validate critical properties and predictions using non-integrated software components.	Documented analytical/experimental results validating predictions of key parameters.
3	<p><b>Examples:</b></p> <ul style="list-style-type: none"> <li>a. High efficiency Gallium Arsenide solar panels for space application is conceived for use over a wide temperature range. The concept critically relies on improved welding technology for the cell assembly. Samples of solar cell assemblies are manufactured and submitted to a preliminary thermal environment test at ambient pressure for demonstrating the concept viability.</li> <li>b. A fiber optic laser gyroscope is envisioned using optical fibers for the light propagation and Sagnac Effect. The overall concept is modeled including the laser source, the optical fiber loop, and the phase shift measurement. The laser injection in the optical fiber and the detection principles are supported by dedicated experiments.</li> <li>c. In Situ Resource Utilization: Demonstrated the application of a cryofreezer for CO<sub>2</sub> acquisition and microwave processor for water extraction from soils.</li> </ul>			
4	Component and/or breadboard validation in a laboratory environment.	A low fidelity system/component breadboard is built and operated to demonstrate basic functionality in a laboratory environment.	Key, functionality critical software components are integrated and functionally validated to establish interoperability and begin architecture development. Relevant environments defined and performance in the environment predicted.	Documented test performance demonstrating agreement with analytical predictions. Documented definition of potentially relevant environment.

	<p><b>Examples:</b></p> <ul style="list-style-type: none"> <li>a. Fiber optic laser gyroscope: A breadboard model is built including the proposed laser diode, optical fiber and detection system. The angular velocity measurement performance is demonstrated in the laboratory for one axis rotation.</li> <li>b. Bi-liquid chemical propulsion engine: A breadboard of the engine is built and thrust performance is demonstrated at ambient pressure. Calculations are done to estimate the theoretical performance in the expected environment (e.g., pressure, temperature).</li> <li>c. A new fuzzy logic approach to avionics is validated in a lab environment by testing the algorithms in a partially computer-based, partially bench-top component (with fiber optic gyros) demonstration in a controls lab using simulated vehicle inputs.</li> <li>d. Variable Specific Impulse Magnetosphere Rocket (VASIMR): 100 kW magnetoplasma engine operated 10 hours cumulative (up to 3 minutes continuous) in a laboratory vacuum chamber.</li> </ul>			
5	Component and/or brassboard validated in a relevant environment.	A medium-fidelity component and/or brassboard, with realistic support elements, is built and operated for validation in a relevant environment so as to demonstrate overall performance in critical areas.	End-to-end software elements implemented and interfaced with existing systems/simulations conforming to target environment. End-to-end software system tested in relevant environment, meeting predicted performance. Operational environment performance predicted. Implementations.	Documented test performance demonstrating agreement with analytical predictions. Documented definition of scaling requirements. Performance predictions are made for subsequent development phases.

**Examples:**

- a. A 6.0-meter deployable space telescope comprised of multiple petals is proposed for near infrared astronomy operating at 30K. Optical performance of individual petals in a cold environment is a critical function and is driven by material selection. A series of 1m mirrors (corresponding to a single petal) were fabricated from different materials and tested at 30K to evaluate performance and to select the final material for the telescope. Performance was extrapolated to the full-sized mirror.
- b. For a launch vehicle, TRL 5 is the level demonstrating the availability of the technology at subscale level (e.g., the fuel management is a critical function for a re-ignitable upper stage). The demonstration of the management of the propellant is achieved on the ground at a subscale level.
- c. ISS Additive Manufacturing Facility: Characterization tests compare parts and material properties of polymer specimens printed on ISS to copies printed on the ground.



	System/sub-system model or prototype demonstration in a relevant environment.	A high-fidelity prototype of the system/subsystems that adequately addresses all critical scaling issues is built and tested in a relevant environment to demonstrate performance under critical environmental conditions.	Prototype implementations of the software demonstrated on full-scale, realistic problems. Partially integrated with existing hardware/software systems. Limited documentation available. Engineering feasibility fully demonstrated.	Documented test performance demonstrating agreement with analytical predictions.
6	<p><b>Examples:</b></p> <ul style="list-style-type: none"> <li>a. A remote sensing camera includes a large 3-meter telescope, a detection assembly, a cooling cabin for the detector cooling, and an electronics control unit. All elements have been demonstrated at TRL 6 except for the mirror assembly and its optical performance in orbit, which is driven by the distance between the primary and secondary mirrors needing to be stable within a fraction of a micrometer. The corresponding critical part includes the two mirrors and their supporting structure. A full-scale prototype consisting of the two mirrors and the supporting structure is built and tested in the relevant environment (e.g., including thermo-elastic distortions and launch vibrations) for demonstrating the required stability can effectively be met with the proposed design.</li> <li>b. Vacuum Pressure Integrated Suit Test (VPIST): Demonstrated the integrated performance of the Orion suit loop when integrated with human-suited test subjects in a vacuum chamber.</li> </ul>			

7	System prototype demonstration in an operational environment.	A high-fidelity prototype or engineering unit that adequately addresses all critical scaling issues is built and functions in the actual operational environment and platform (ground, airborne, or space).	Prototype software exists having all key functionality available for demonstration and test. Well integrated with operational hardware/software systems demonstrating operational feasibility. Most software bugs removed. Limited documentation available.	Documented test performance demonstrating agreement with analytical predictions.
<p><b>Examples:</b></p> <ul style="list-style-type: none"> <li>a. Mars Pathfinder Rover flight and operation on Mars as a technology demonstration for future micro-rovers based on that system design.</li> <li>b. First flight test of a new launch vehicle, which is a performance demonstration in the operational environment. Design changes could follow as a result of the flight test.</li> <li>c. In-space demonstration missions for technology (e.g., autonomous robotics and deep space atomic clock). Successful flight demonstration could result in use of the technology in a future operational mission</li> <li>d. Robotic External Leak Locator (RELL): Originally flown as a technology demonstrator, the test article was subsequently put to use to help operators locate the likely spot where ammonia was leaking from the International Space Station (ISS) External Active Thermal Control System Loop B.</li> </ul>				

8	Actual system completed and “flight qualified” through test and demonstration.	The final product in its final configuration is successfully demonstrated through test and analysis for its intended operational environment and platform (ground, airborne, or space). If necessary*, life testing has been completed.	All software has been thoroughly debugged and fully integrated with all operational hardware and software systems. All user documentation, training documentation, and maintenance documentation completed. All functionality successfully demonstrated in simulated operational scenarios. Verification and Validation completed.	Documented test performance verifying analytical predictions.
<p><b>Note:</b>  **“If necessary” refers to the need to life test either for worn out mechanisms, for temperature stability over time, and for performance over time in extreme environments. An evaluation on a case-by-case basis should be made to determine the system/systems that warrant life testing and the tests begun early in the technology development process to enable completion by TRL 8. It is preferable to have the technology life test initiated and completed at the earliest possible stage in development. Some components may require life testing on or after TRL 5.</p> <p><b>Examples:</b></p> <ol style="list-style-type: none"> <li>a. The level is reached when the final product is qualified for the operational environment through test and analysis. Examples are when Cassini and Galileo were qualified, but not yet flown.</li> <li>b. Interim Cryo Propulsion Stage (ICPS): A Delta Cryogenic Second Stage modified to meet Space Launch System requirements for Exploration Mission-1 (EM-1). Qualified and accepted by NASA for flight on EM-1.</li> </ol>				

9	Actual system flight proven through successful mission operations.	The final product is successfully operated in an actual mission.	All software has been thoroughly debugged and fully integrated with all operational hardware and software systems. All documentation has been completed. Sustaining software support is in place. System has been successfully operated in the operational environment.	Documented mission operational results.
	<p><b>Examples:</b></p> <ul style="list-style-type: none"> <li>a. Flown spacecraft (e.g., Cassini, Hubble Space telescope).</li> <li>b. Technologies flown in an operational environment.</li> <li>c. Nanoracks CubeSat Deployer: Commercially developed and operated small satellite deployer on-board the ISS.</li> </ul>			

*Note: In cases of conflict between NASA directives concerning TRL definitions, NPR 7123.1 will take precedence.*