



Invited talk at Manchester Metropolitan University, England

Wireless Power Transmission (WPT) Technology *Past and Now*

Dr. Sang H. Choi

Advanced Materials and Processing Branch
Research Directorate
NASA Langley Research Center
Hampton, Virginia

January 26, 2023

All Image credits: NASA



Why Wireless Power Technology (WPT)?

- Power accessibility in extended distance is readily available by WPT since power-grid system serves limited areas only
- WPT enables power feed for mobile systems and imbedded or implanted devices
- WPT alleviates or reduces the onboard power infrastructure
- WPT can change the conventional power modulators into different and much simpler modulation concepts
- WPT is a proven technology but still requires refinements



Energy and Workable Energy

Energy

- Quantum Energy: Wave and Particle, Quantum Ontology
- Nuclear Energy: Fission and Fusion
- Chemical Energy: Reactive Potential
- Mechanical Energy: Potential and Kinetic

Manipulative Energy → Harnessable Energy → Power

Grade of Energy is defined by the harnessability

- Low Grade
- Mid Grade
- High Grade
- Extreme High Grade

Customary Band (Wave) Energy and Grade



Band	Frequency	Wavelength	Energy	Color Temperature	Grade
HF	3 ~ 30 MHz	10 ~ 100 m			Extremely Low
VHF	30 ~ 300 MHz	1 ~ 10 m			
UHF	0.3 ~ 3 GHz	0.1 ~ 1 m			
L	1 ~ 2 GHz	0.15 ~ 0.3 m			
S	2 ~ 4 GHz	0.075 ~ 0.15 m			
C	4 ~ 8 GHz	0.037 ~ 0.075 m			
X	8 ~ 12 GHz	0.025 ~ 0.037 m			
Ku	12 ~ 18 GHz	0.017 ~ 0.025 m			
K	18 ~ 27 GHz	0.011 ~ 0.017 m			
Ka	26.5 ~ 40 GHz	0.0075 ~ 0.0113 m			
Q	33 ~ 50 GHz	0.006 ~ 0.0091 m			
U	40 ~ 60 GHz	0.0075 ~ 0.005 m			
V	50 ~ 75 GHz	0.004 ~ 0.006 m			
W	75 ~ 110 GHz	0.0027 ~ 0.004 m			
F	90 ~ 140 GHz	0.00214 ~ 0.00333 m			
D	110 ~ 170 GHz	0.00176 ~ 0.00273 m			
Tera (TH)	700 ~ 1700 GHz	42.8 ~ 17.6 μ m	0.003 eV ~ 0.007 eV	35 ~ 80 K	Lowest Grade
Far IR (FIR)	6 ~ 15 THz	50 ~ 20 μ m	0.025 eV ~ 0.06 eV	300 ~ 700 K	Low Grade
Mid IR (MIR)	15 ~ 30 THz	20 ~ 10 μ m	0.06 eV ~ 0.12 eV	700 ~ 1400 K	Low Grade
IR	30 ~ 100 THz	10 ~ 3 μ m	0.12 eV ~ 0.3 eV	1400 ~ 3500 K	Low Grade
Near IR (NIR)	100 ~ 430 THz	3 ~ 0.7 μ m	0.3 eV ~ 1 eV	3500 ~ 11600 K	Low Medium Grade
Visible (Vis)	430 ~ 1000 THz	0.7 ~ 0.3 μ m	1 eV ~ 4 eV	11600 ~ 46420 K	Low Medium Grade
UV (UV)	750 ~ 1000 THz	0.4 ~ 0.3 μ m	3 eV ~ 4 eV	34800 ~ 46420 K	Low Medium Grade
Deep UV (DUV)	850 ~ 1200 THz	0.35 ~ 0.25 μ m	4 eV ~ 6 eV	46420 ~ 69600 K	Medium Grade
Vacuum UV (VUV)	1.2 ~ 3 PHz	0.25 ~ 0.1 μ m	6 eV ~ 12 eV	69600 ~ 139200 K	Medium Grade
Extreme UV (EUV)	3 ~ 300 PHz	100 ~ 1 nm	12 eV ~ 300 eV	139200 ~ 3480000 K	Medium Grade
Soft X-ray (SXR)	300 ~ 600 PHz	1 ~ 0.5 nm	300 eV ~ 2 keV	3.48 ~ 23.2 MK	High Grade
Hard X-ray (HXR)	0.6 ~ 24 EHz	0.5 ~ 0.0125 nm	2 keV ~ 100 keV	23.2 ~ 1160 MK	High Grade
Gamma ray (γ -ray)	> 25 EHz	< 0.0125 nm	> 100 keV	> 1.16 BK	Extreme High Grade



Energy Harvesting and 'Green'

Energy Sources	Technology	Development	Waste/Efficiency	Green	Power Density	Energy Grade
Nuclear Fusion	ITER or experimental	Long way to go	?	Small Radioactive	Small (~0.05 kW/kg)	Extremely High
Nuclear Fission	Major or stopgap	10 yrs to Build	70% / 30%	Large Radioactive	Small (~0.02 kW/kg)	Extremely High
Nuclear α -Decay	RTG Thermal	2 yrs to Build	40% / 60%	Small Radioactive	Very Small (0.005 kW/kg)	Medium
Nuclear Thermionics	β particles, γ rays	5 yrs R&D	40% / 60%	Small Radioactive	Extra Large (~ 1 kW/kg)	Extremely High
Fossil Fuels	Steam Turbine	3 yrs to Build	70% / 30%	Pollution Gases	Small	Low
Solar Thermal	Sterling/ Rankine	4 yrs to Build	75% / 25%	Green	Small	Low
Solar Photovoltaic	Bandgap Energy	1 yrs to Build	70% / 30%	Green	Small to Medium	Low
Solar Thermoelectric	Seebeck Potential	5 yrs R&D	60% / 40%	Green	Small to Medium	Low
Wind	Wind Turbine	1 yrs to Build	85% / 15%	Green	Small	Low
Wave	Wave Stroke	3 yrs to Build	85% / 15%	Green	Small	Low
Ocean Thermal	Thermal Distribution	5 yrs to Build	80% / 20%	Green	Small	Very Low
Thermal Recovery	Regenerative TE	5 yrs R&D	60% / 40%	Green	Small	Low
Hydro Power	Hydro-Potential	7 yrs to Build	50% / 50%	Green	Small	Low
Space Wireless Power	Wireless Transmission	20 yrs to Build	85% / 15%	Green	Small	Low
Hydrogen	Fuel Cell	5 yrs to Use	70% / 30%	Green	Small to Medium	Medium
Bio-mass	Methane	1 yr to Build	70% / 30%?	Semi Green	Small	Low
Geothermal	Rankine Cycle	5 yrs to Build	70% / 30%	Green	Very Small	Very Low

ITER: International Thermonuclear Experimental Reactor
 RTG: Radioisotope Thermoelectric Generator
 TE: Thermoelectric



Energy-Releasing Reactions

Energy Source	Chemical	Nuclear Fission	Nuclear Fusion	γ -Photoionic
Sample Reaction	$C + O_2 \rightarrow CO_2$	$n + {}^{235}\text{U} \rightarrow {}^{143}\text{Ba} + {}^{91}\text{Kr} + 2n$	${}^2\text{H} + {}^3\text{H} \rightarrow {}^4\text{He} + n$	X-ray, γ -ray, β
Typical Inputs	Coal or Oil	UO_2 (3% ${}^{235}\text{U}$ + 97% ${}^{238}\text{U}$)	Deuterium & Tritium	Photons
Typical Reaction Temp (K)	700	1000	10^8	Any Temp
Energy Released (J/g)	3.3×10^4	2.1×10^9	3.4×10^{11}	1.4×10^8
Harnessable Efficiency (E/mc ²)	3×10^{-8} %	0.002 %	0.4 %	~ 30 %

http://electron6.phys.utk.edu/phys250/modules/module%205/nuclear_energy.htm

Energy Grade	Poorest	High	Highest	Highest
Specific Power (kW/kg)	< 0.01	< 0.025	> 0.1	> 1
System α (kg/kW)	> 100	> 40	< 10	< 1
Refueling Cycle (years)	Frequently	> 10 years	> 10 years	2.5 ~ 30 years
Challenges & Readiness	Pollution	γ & Neutron Shielding	Plasma Fusion (???)	Radioisotopes



NASA Lunar Power- KRUSTY: A **40 kW_e** system with **4-m** diameter, **6-m** length and **> 6,000 kgs** weight

(KRUSTY: Kilowatt Reactor Using Sterling TechnologY)



Scenario of Laser Beam Power Transmission

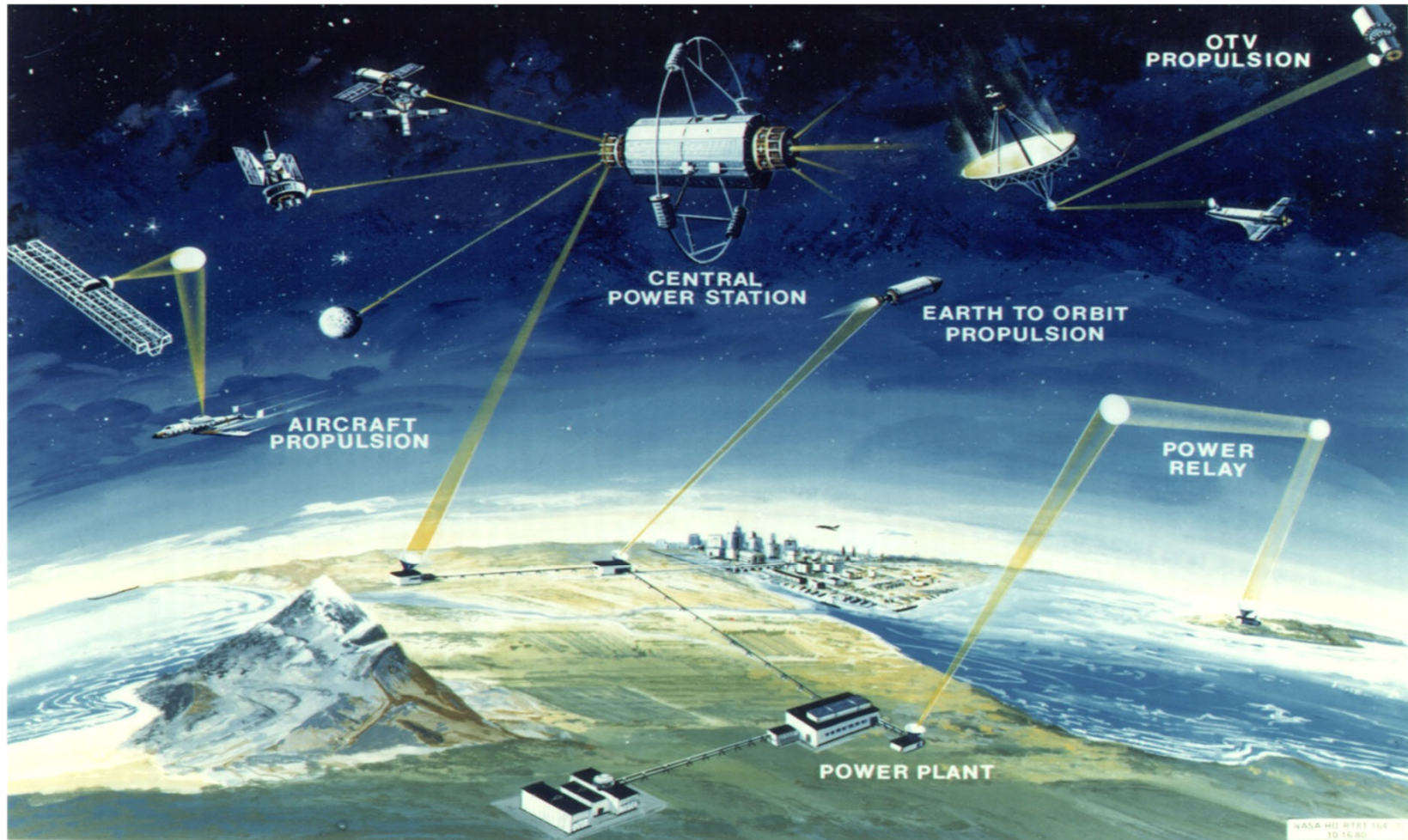

Williams, M. D., R. J. DeYoung, G. L. Schuster, S. H. Choi, J. E. Dagle, E. P. Coomes, Z. I. Antiniak, J. A. Bamberger, J. M. Bates, M. A. Chiu, R. E. Dodge, and J. A. Wise: "Power Transmission by Laser Beam from Lunar-Synchronous Satellites", NASA TM-4496, November 1993.



Advanced Thermoelectric Power Generation and Transmission System

Three Subsystems:

- Radioisotope Power (RIP) subsystem
- Advanced Thermoelectric Generator (ATEG) subsystem
- Wireless Power Transmission (WPT) subsystem

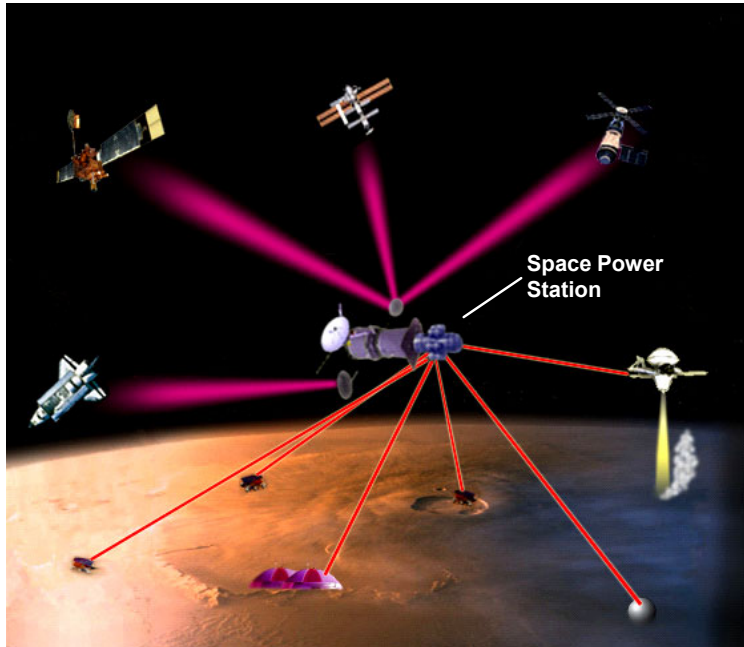

Power Satellite System

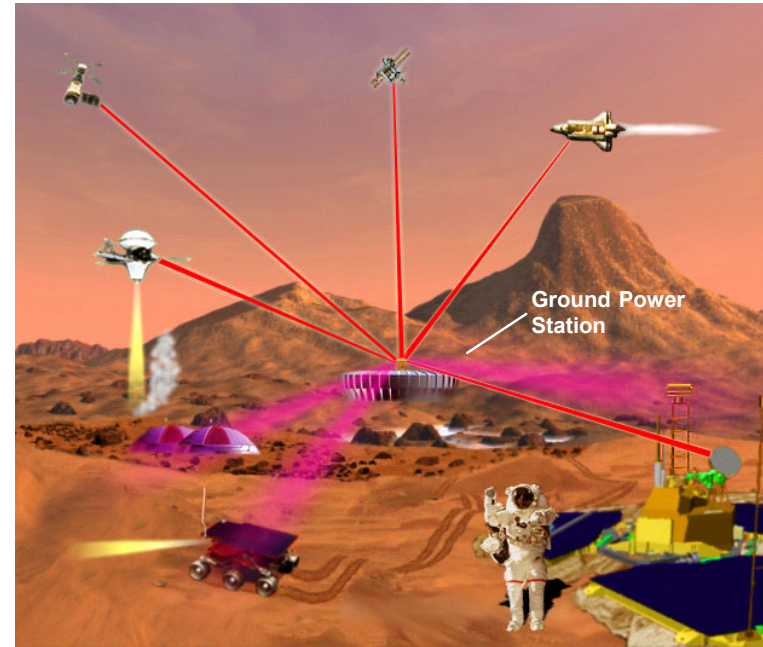

Surface Power System



Energy Sources in Space

Solar Energy

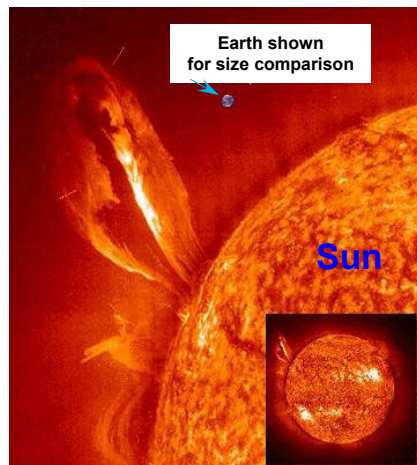

- Burns 660 million tons/sec of H_2
- Leaves 600 million tons/sec of He
- Gives off the rest as radiation

d = 1



174,000 TW of
sunlight hit the
Earth every day

AM0 = 1370 W/m²
AM1 = 1353 W/m²

d = 1.52



21,000 TW of
sunlight hit the
Mars every day

AM0 = 593 W/m²
AM1 = 588 W/m²

AM0: Air Mass 0 (no air) solar flux
AM1: Solar flux on Earth or Mars surface



50-kW Directly Solar-Pumped Iodine Laser (DSPIL) Power Satellite Module

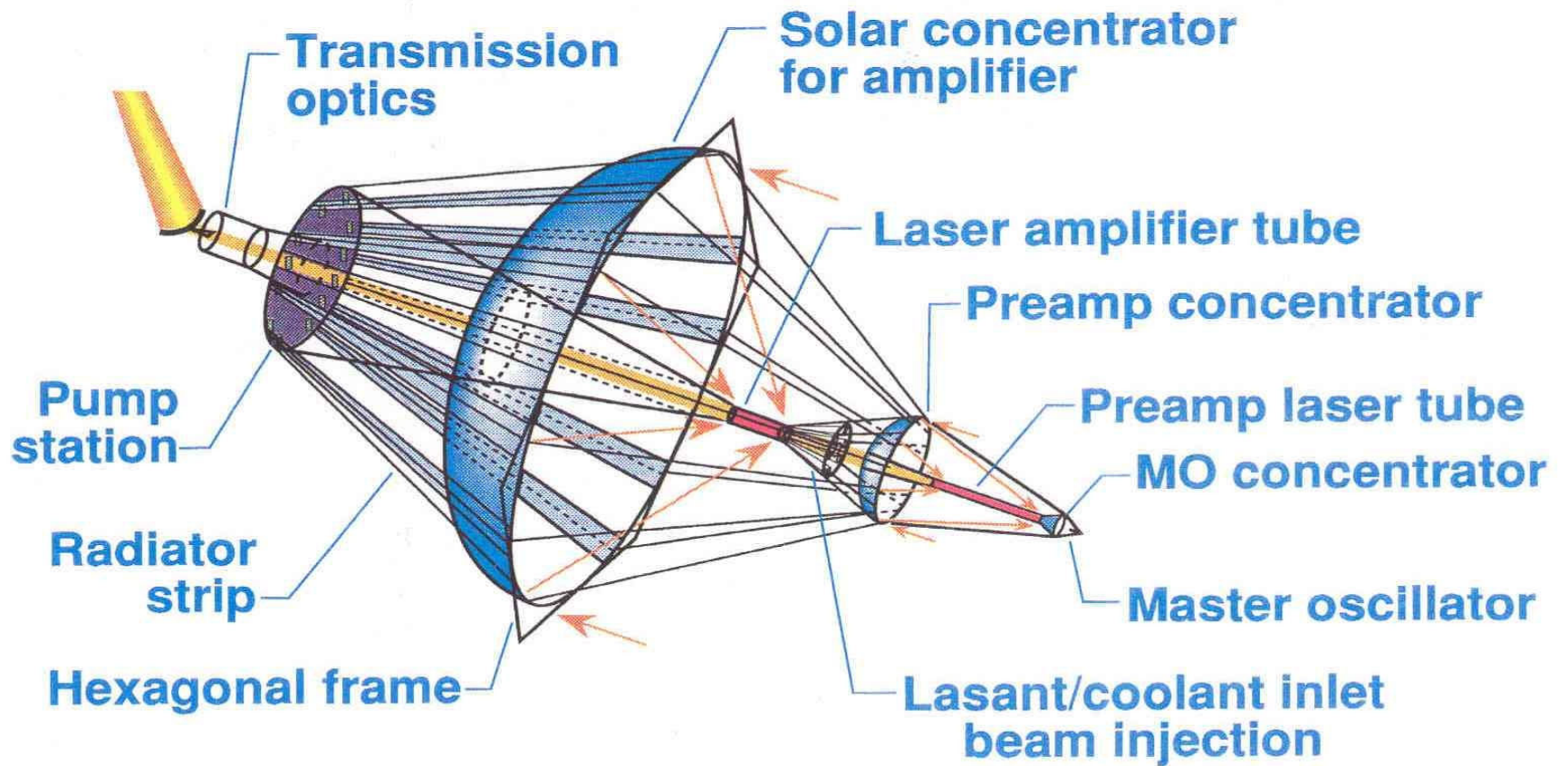



Laser Power Satellite Concept

COMBINED DSPIL POWER MODULE SYSTEM

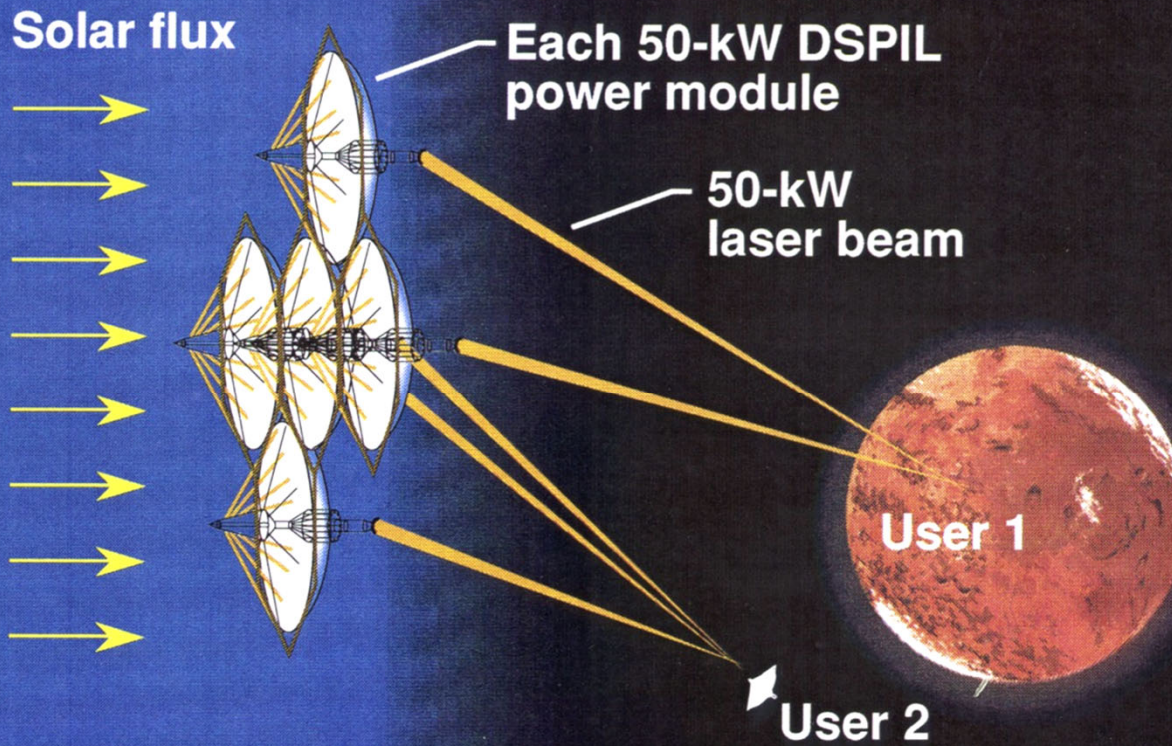

Choi, S. H.; Lee, J. H.; Meador, W. E.; and Conway, E. J.: "A 50-kW Module Power Station of Directly Solar Pumped Iodine Laser," *Journal of Solar Energy Engineering, ASME*, Vol. 119, p.304, Nov. 1995.



Laser Beam Power Transmission

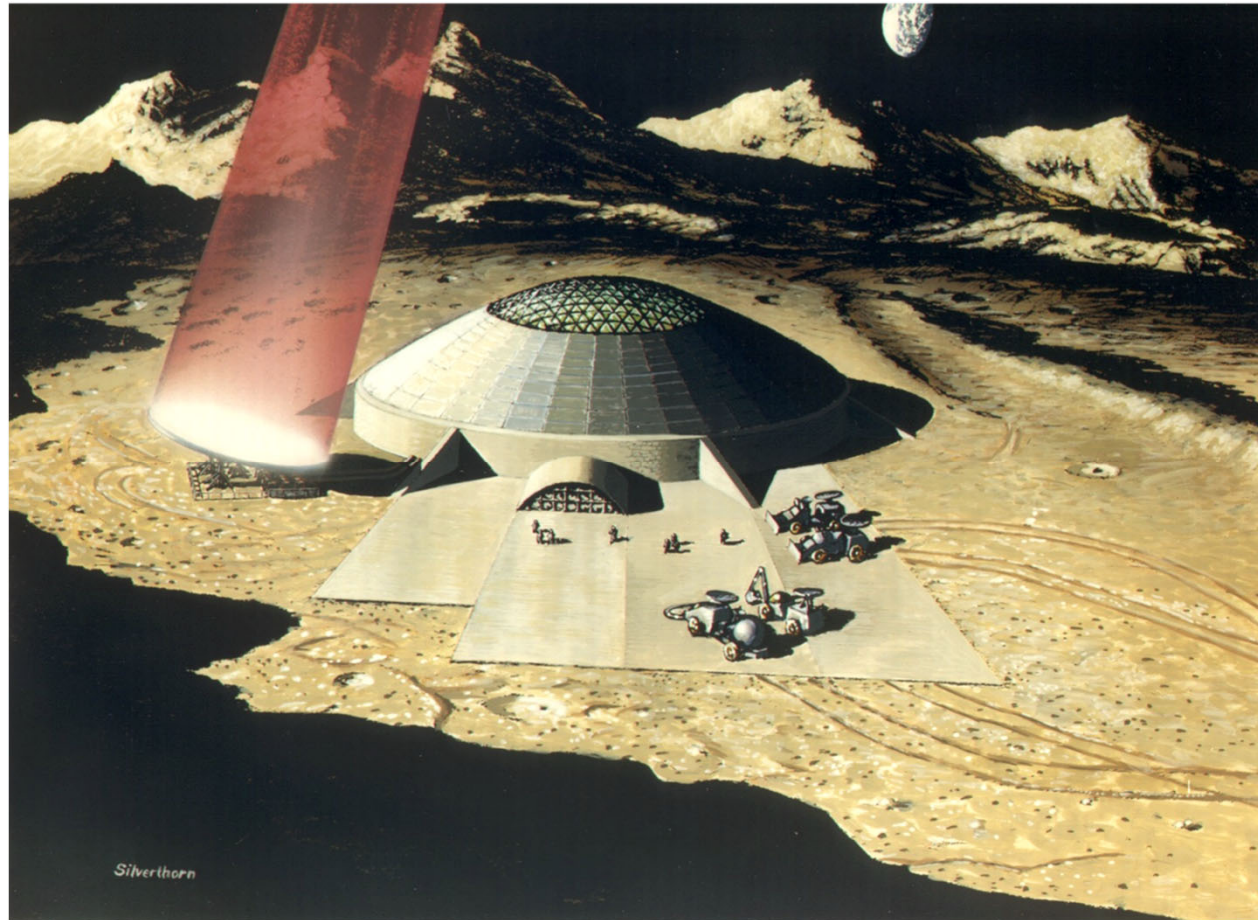

Choi, S. H., M. D. Williams, J. H. Lee, and E. J. Conway: "Diode Laser Power Module for Beamed Power Transmission," Proceedings of the 26th IECEC, Boston, MA, Aug. 4-9, 1991.



Laser Beam Power Transmission to Rover

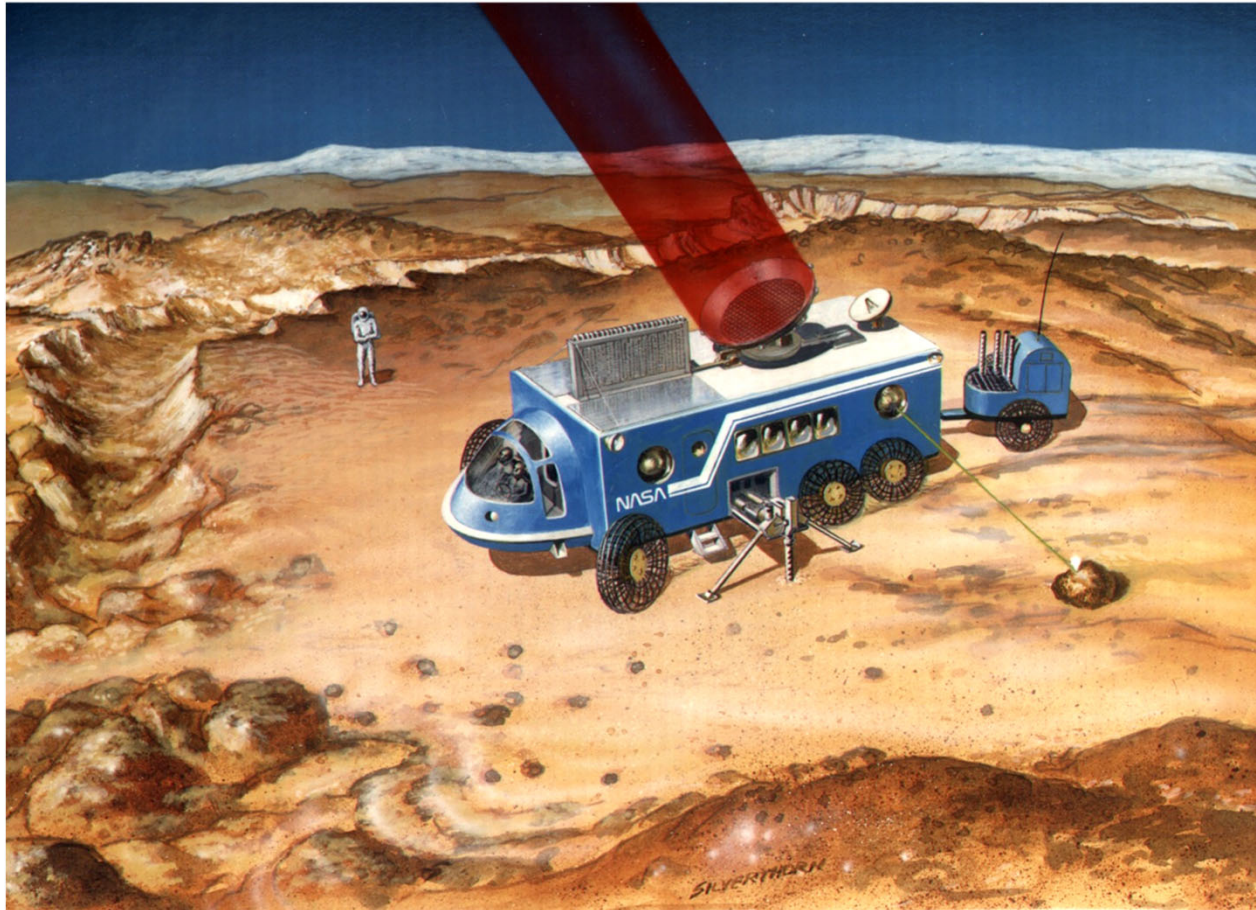

Williams, M. D., R. J. DeYoung, G. L. Schuster, S. H. Choi, J. E. Dagle, E. P. Coomes, Z. I. Antiniak, J. A. Bamberger, J. M. Bates, M. A. Chiu, R. E. Dodge, and J. A. Wise: "Power Transmission by Laser Beam from Lunar-Synchronous Satellites to a Lunar Rover", Proceedings of the 27th IECEC, Vol. 2, Paper 929437, p2-299, San Diego, CA, Aug. 3-7, 1992.



Microwave (MW)-driven Power Feed

Concept

Microwave-driven Power Transmission

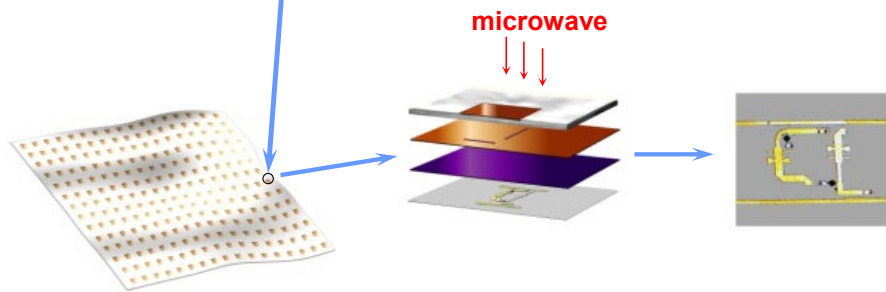
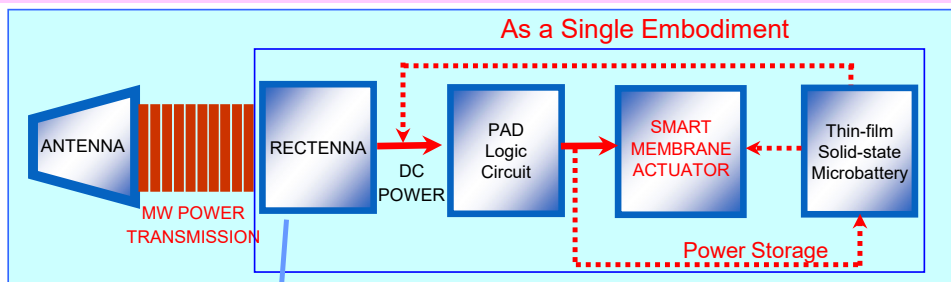

Flexible Smart Membrane

- Distributed piezoelectric actuators with rectenna patches.
- Control algorithm carried on MW signal enables actuators to be tuned for shape control.
- Power allocation and distribution (PAD) circuit imbedded actuators array allows smart power use.



Solar Power

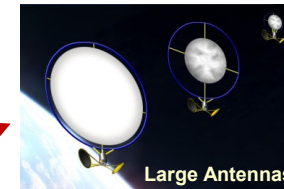

Large Antennas



Solar Sail

Applications

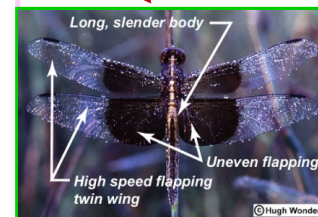

Smart Wing

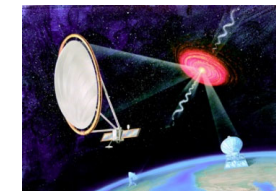

Large Space Telescope



Thin-film Dipole Rectenna Array

Thin-Film Rectenna Dipole Element

Capacitors for filter

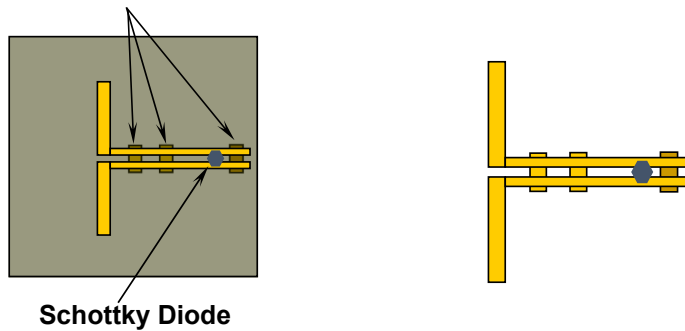

Circuit of Thin-Film Rectenna Dipole Element

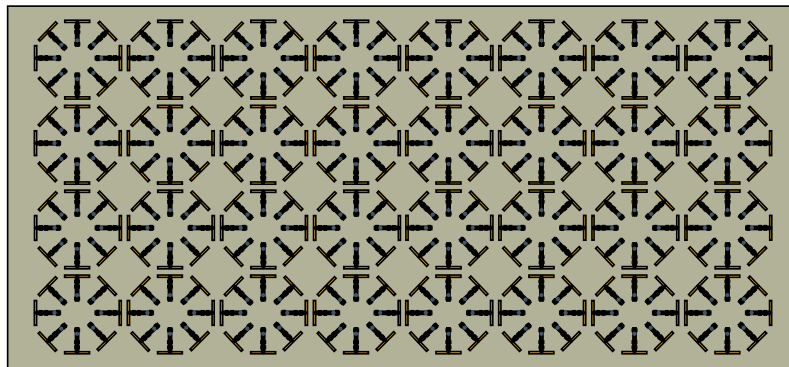
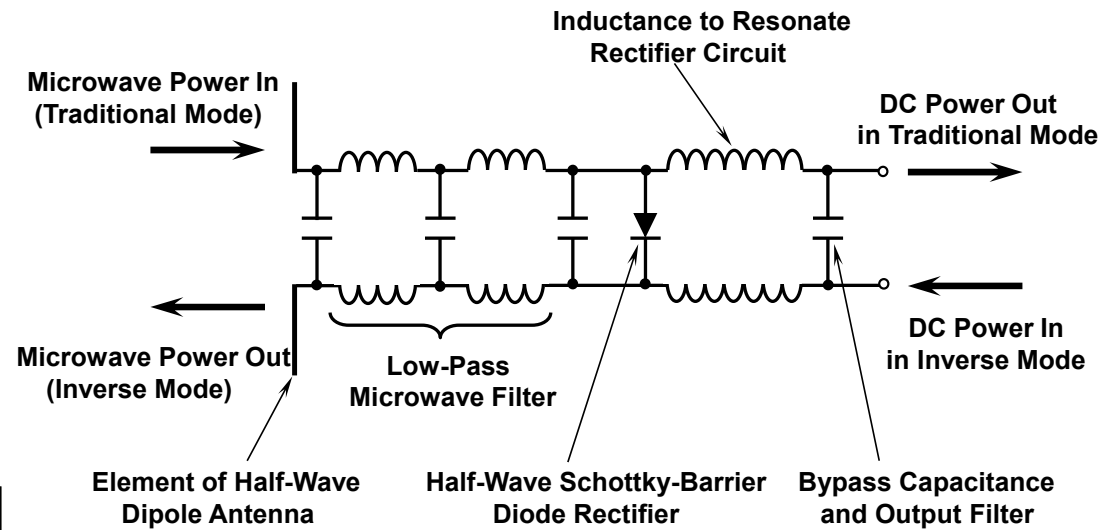

Densified Thin-film Membrane Dipole Rectenna Array
(designed by NASA Langley Research Center)



High Density Rectenna Design and Fab

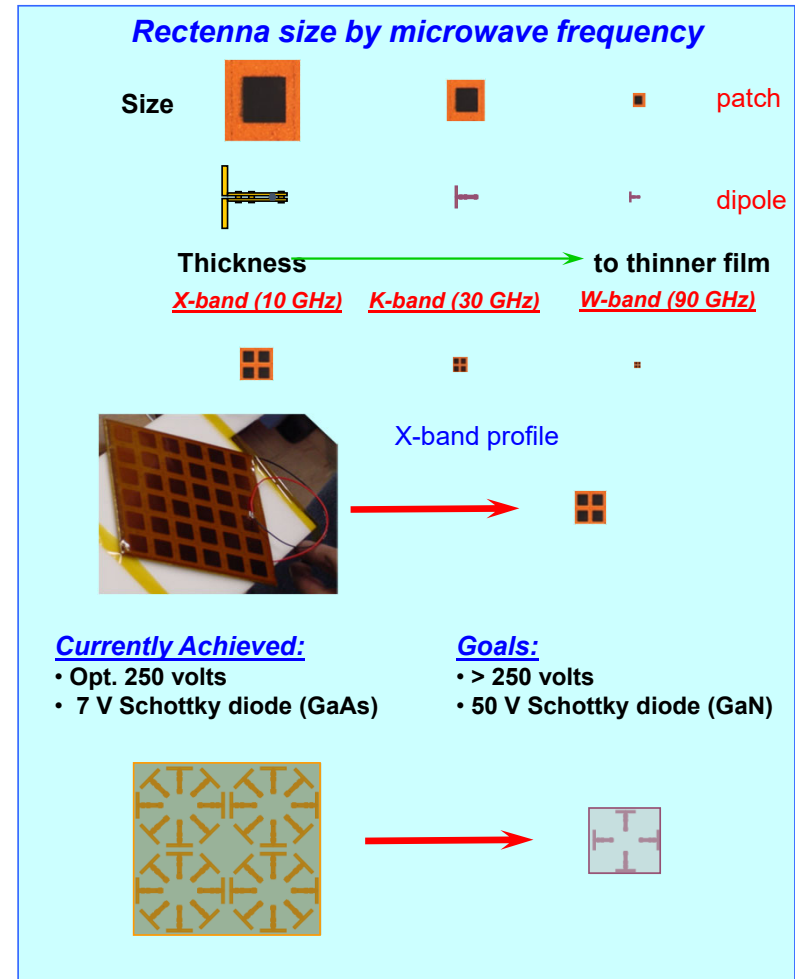
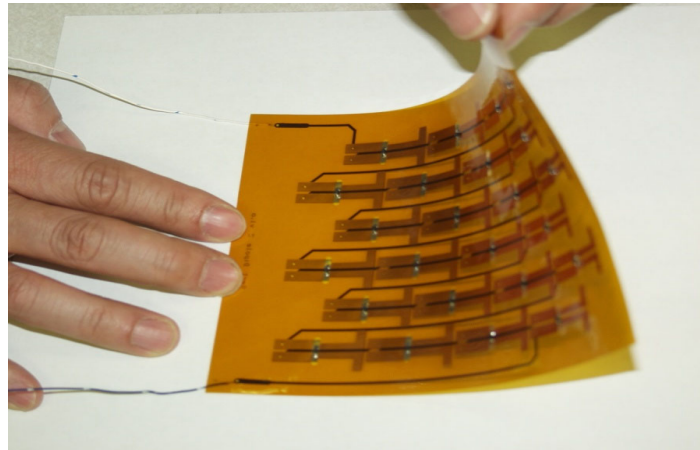
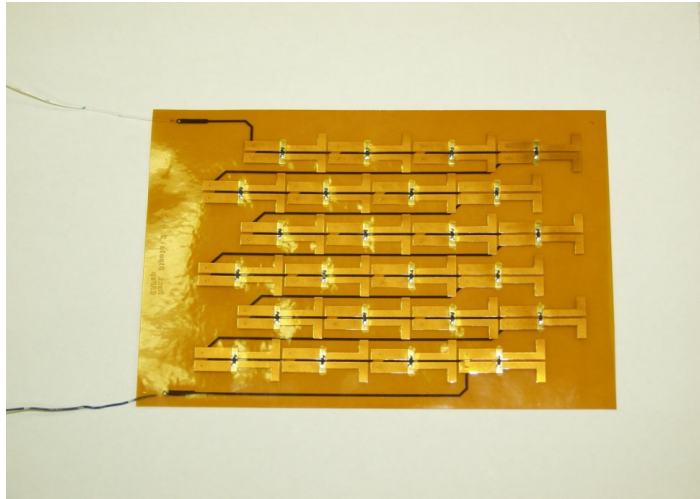



Compact and Polarity-free Enhanced Dipole Rectenna Array

Polarization-free Rectenna

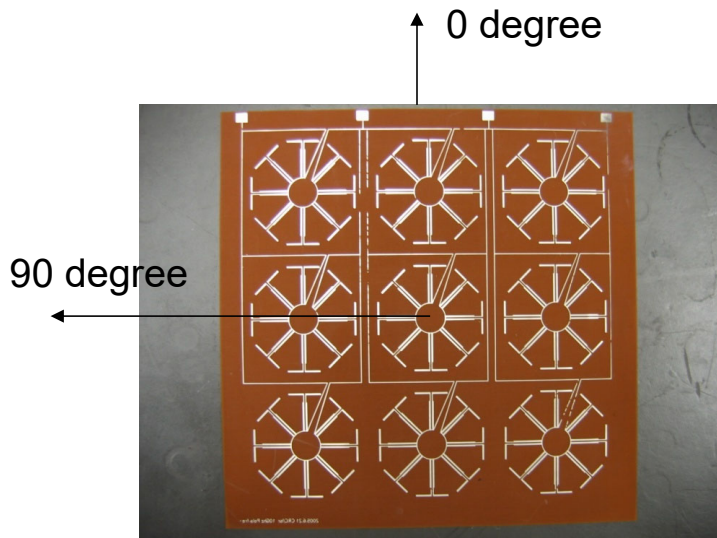

3 x 3 Flexible Rectenna

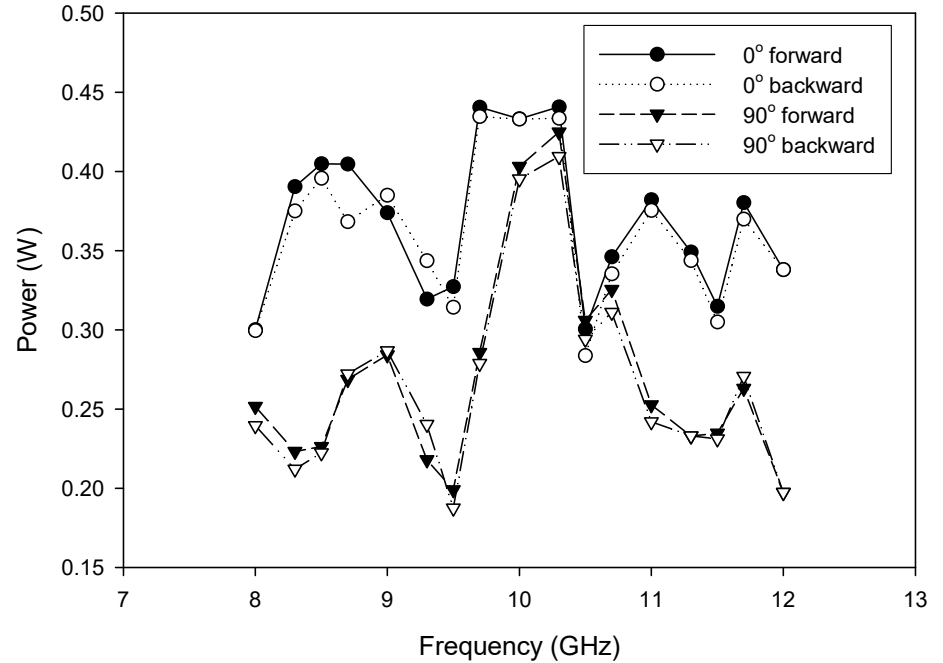



Rectenna Efficiencies

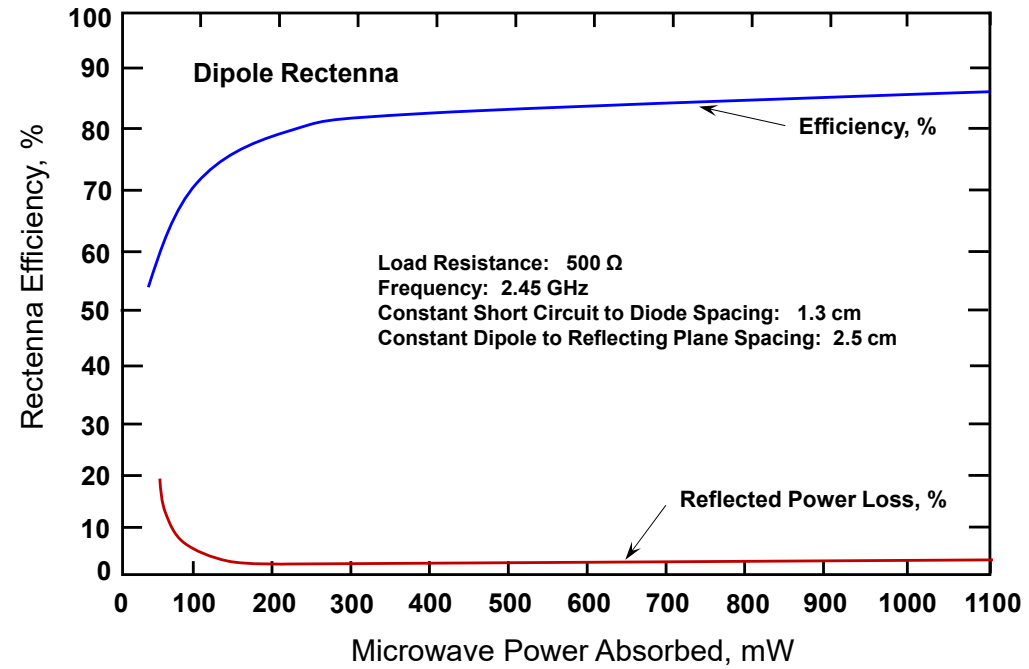
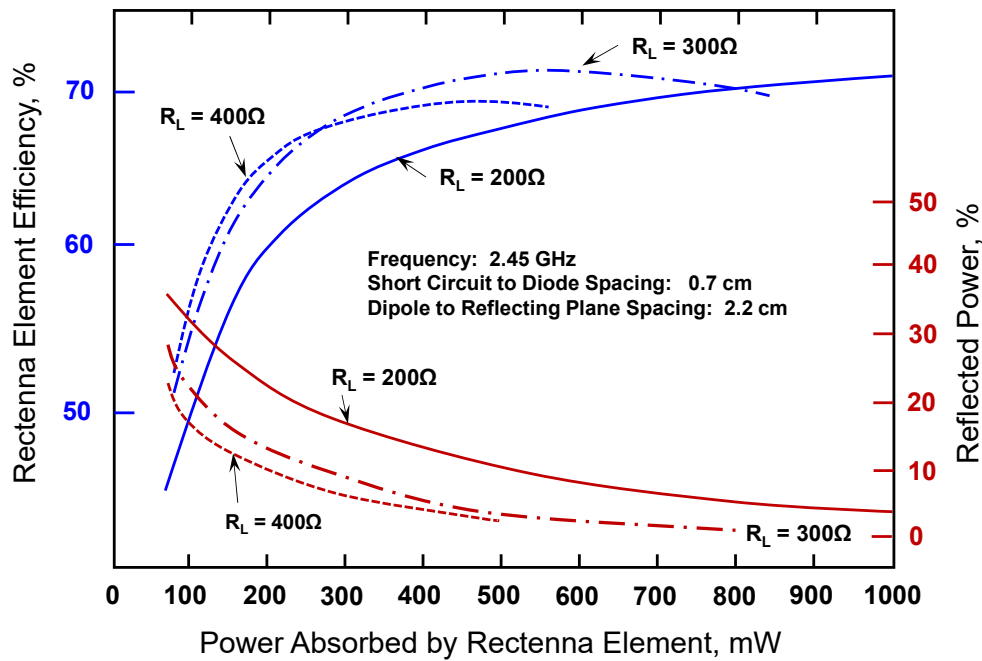

Dipole Rectenna Test Results: reported by William C. Brown, NASA CR179558, March 11, 1987



Microwave Receiving Antenna Size

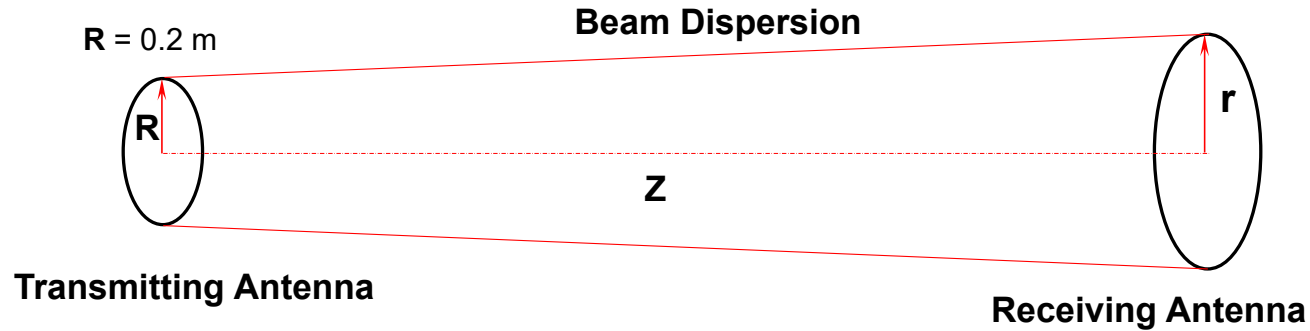

Goubau Relationship

$$\tau = \frac{\sqrt{A_t A_r}}{\lambda Z}$$

- τ = 3.0 for 100% transfer efficiency
- A_t = Transmitting antenna aperture area
- A_r = Receiving antenna aperture area
- λ = MW wavelength
- Z = Distance between two antennas

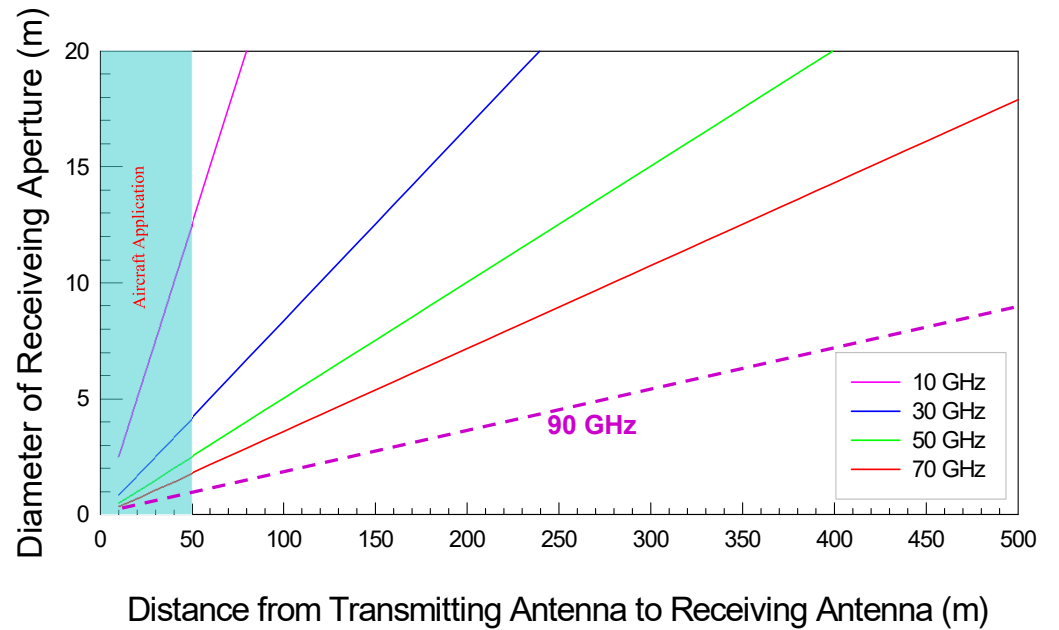



Helium-Filled Microwave-Powered Aerial Vehicles (MPAV) – Mars Airplane

- ~ 1 MW Power Beam from:
- High Altitude Airship (HAA) or
 - Power Satellite or
 - Ground Power Station

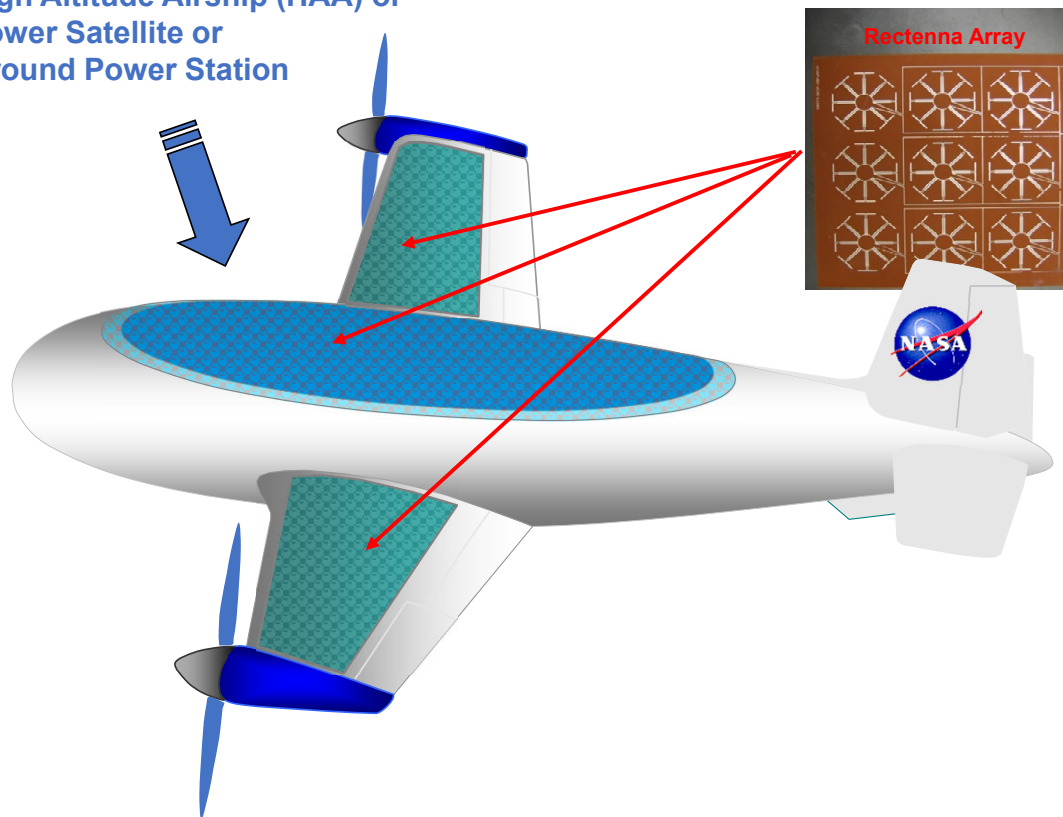

- Size: 3-m long by 3-m wide
- Transmission Distance ~ 20 km
- W-band MW ~ 90 GHz
- Power Flux Density ~ 60 mW/cm²
- Power Received ~ 6 kW
- Propulsion ~ 4 kW
- Operation ~ 2 kW



MW-driven Model Aero-vehicle

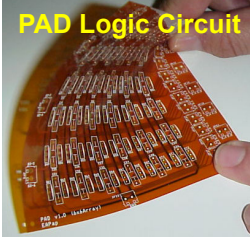

Wirelessly powered MAV

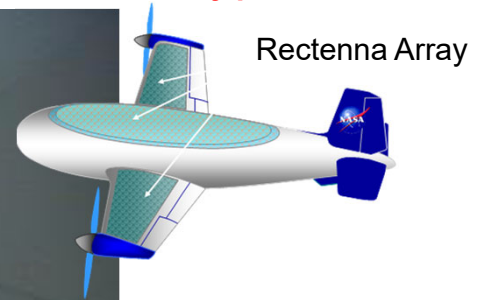

MAV: Micro-Aero-Vehicle

PAD: Power Allocation & Distribution

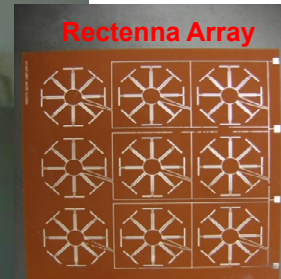

Goal: Wirelessly Powered MAV



Sensor Deployment by MAV

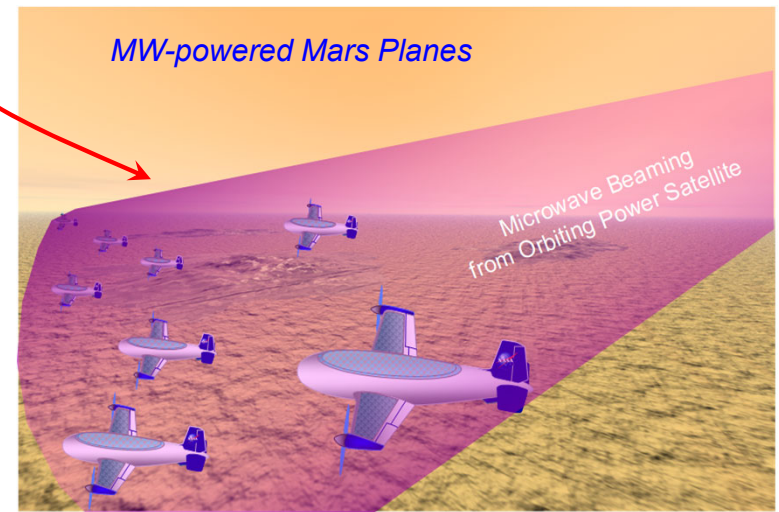
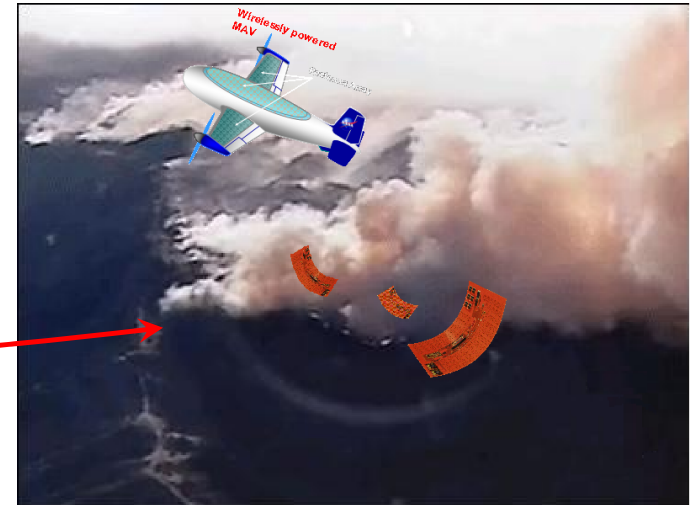
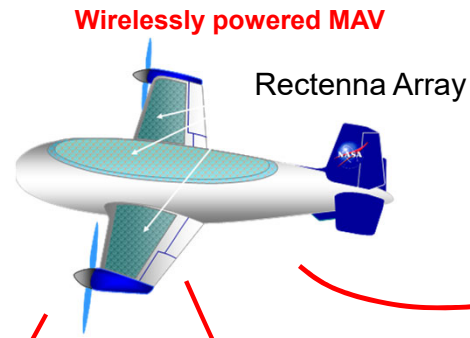
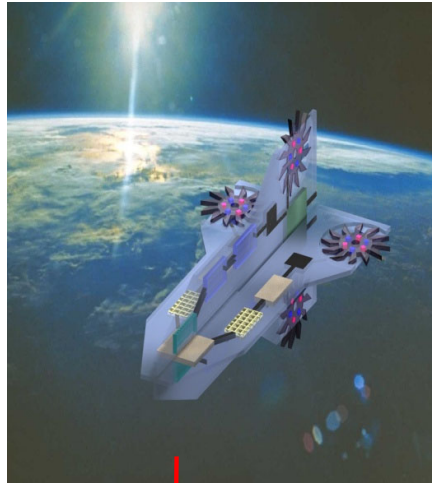

MAV: Micro-Aero-Vehicles



Power for Airship

Without onboard power source – “with **Green Power**”

- Solar Energy: Solar Photo-voltaic (PV) or Solar Thermoelectric (TE)
- Wireless Power Transmission: Microwave or laser

Airship Size vs. Power for Propulsion

- Boosted Power:
 - More propulsion power to reduce airship size
 - High power density without conventional fuels (0.1 ~ 1 kW/cm³)
- Nuclear Thermionic Battery:
 - Promising but requires new materials for electron avalanche process and collection
 - Better for space exploration applications



Power Technology Assessment for Wirelessly Powered Airship Transportation

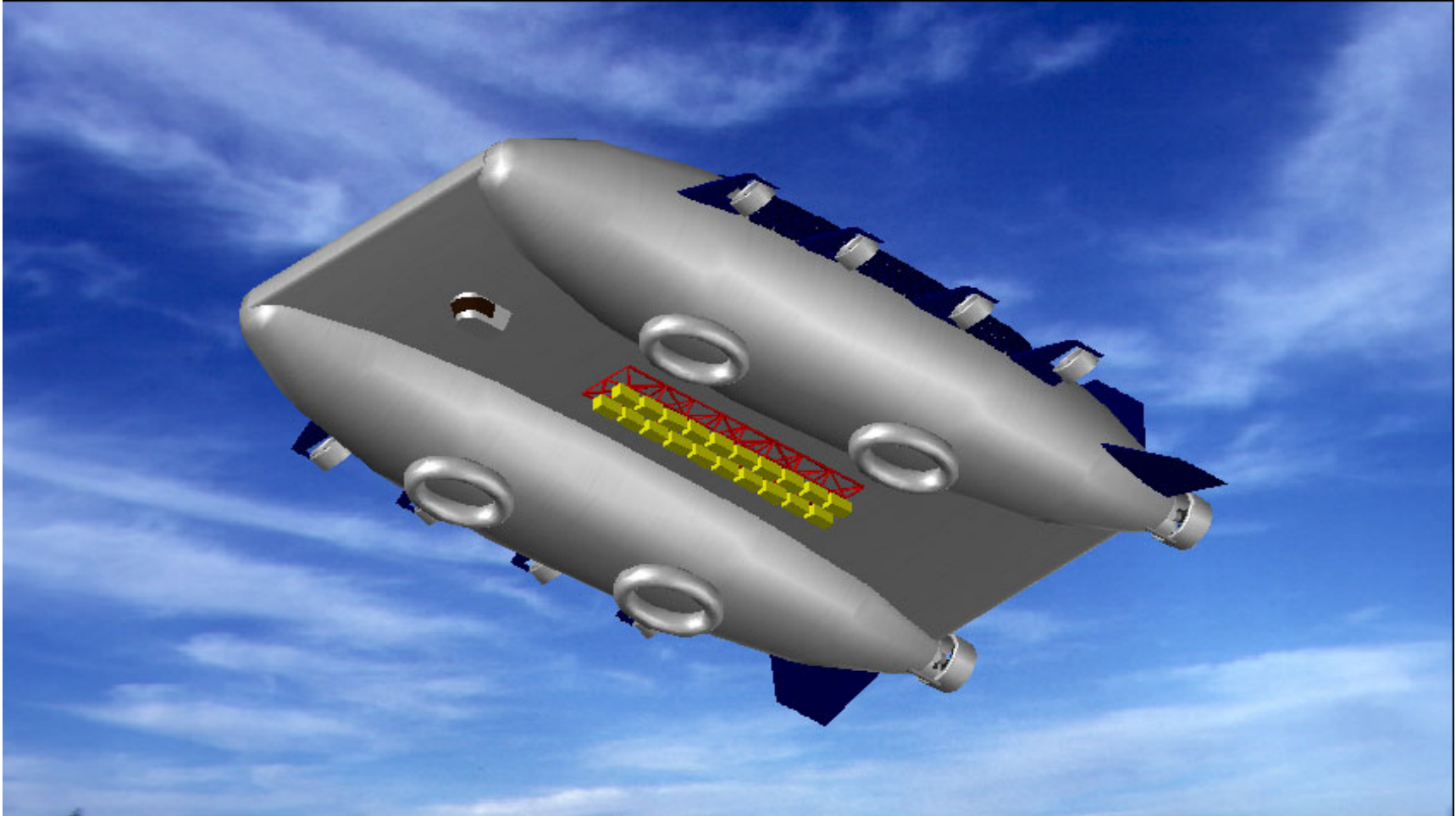



Power Harvesting for Day & Night

Night time (all membrane surface)

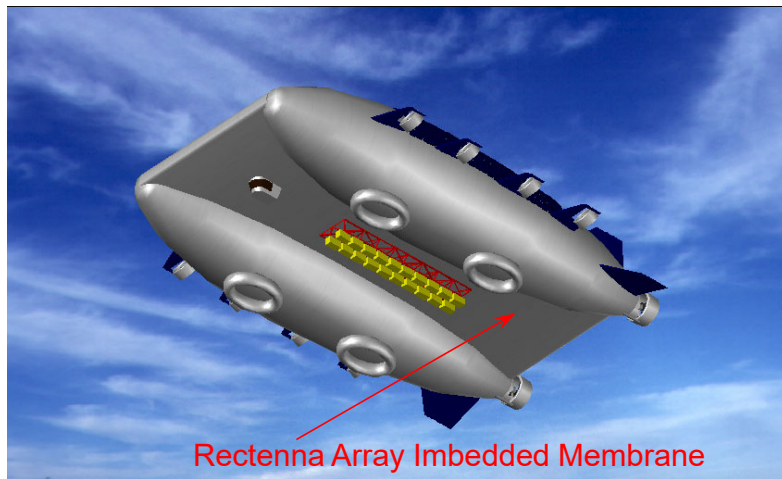

Nighttime Power:

- Rectenna arrays imbedded into all membrane structures
- Microwave beamed up from ground station
- Station-to-station switch while advancing

Daytime (upper surface)

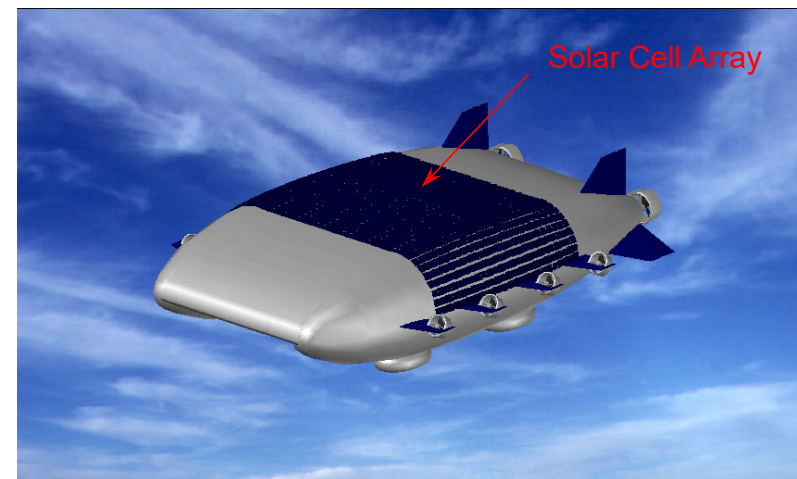

Daytime Power:

- Solar cell arrays covered over upper surface
- PV efficiency made out of SiGe is 30 ~ 40 %
- Long life of PV cells over 30 years



Night time Power

Microwave Power from Ship-board or Ground Station

- 1 MW Transmission
- 0.85 MW received by Multi-Purpose Airship

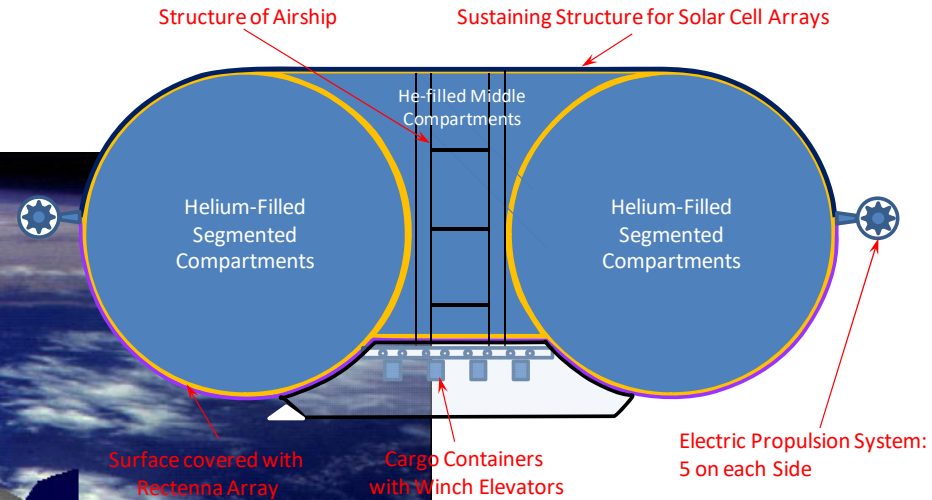
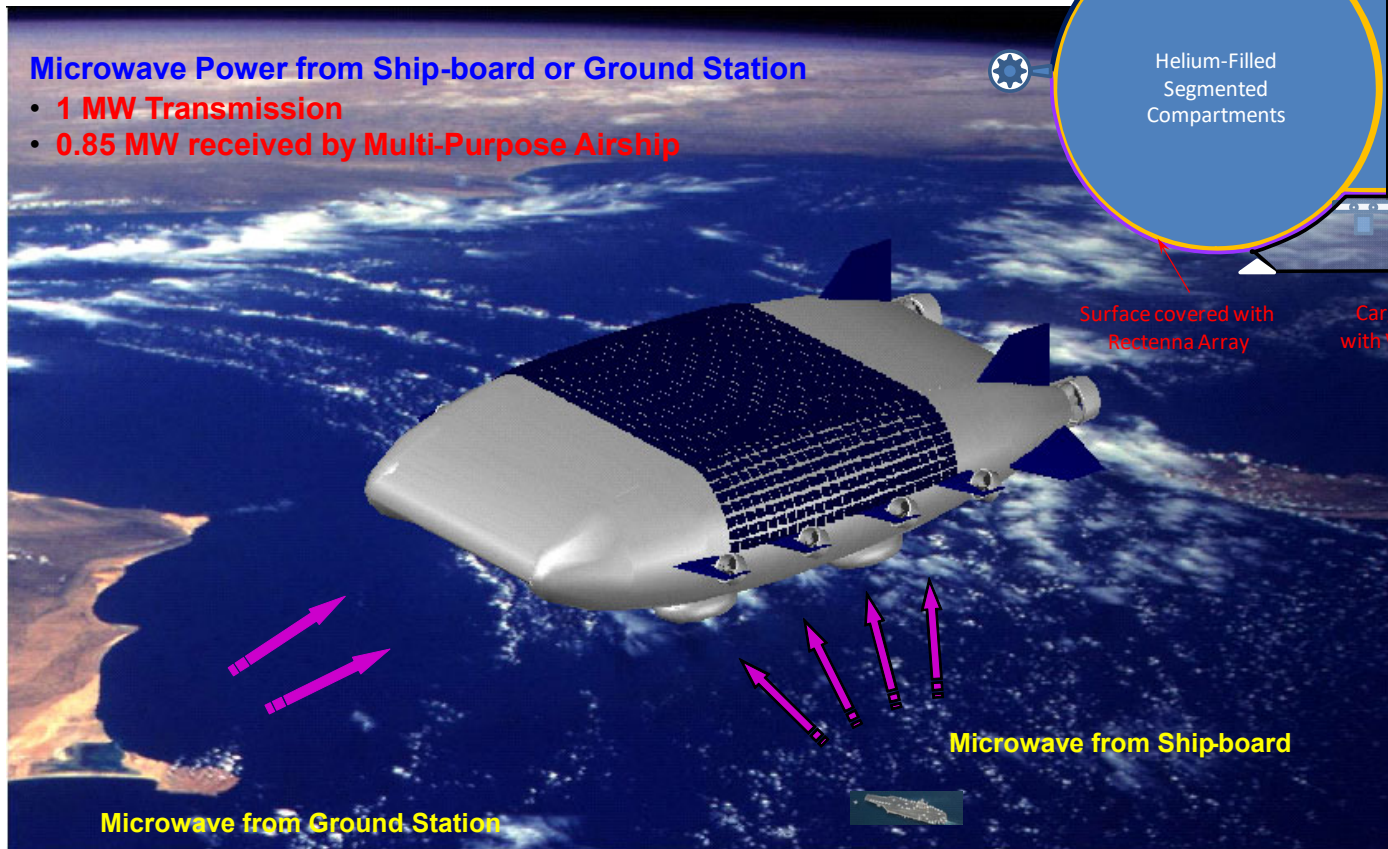



Key Features of Airship

- ❖ Worthiness study of advanced thermoelectric generators as a new power conversion device for airship.
- ❖ New and high efficient solar cell technology is being developed for daytime power source of airship.
- ❖ X-band rectenna technology has been used for demo purpose. A 40-GHz rectenna may be suitable for airship application.
- ❖ Size reduction of airship requires a high density power source, such as a nuclear thermionic battery ($\sim 1 \text{ kW/cm}^3$).
- ❖ Helium-filled airship that is currently developed at NASA LaRC will have broad applications on terrestrial applications.



Wireless Power for Implanted Medical Devices

Needs of Wireless Power System in Neural Sensing and Modulation Applications

- Batteryless and long-term operation
- Provide necessary power for neural sensing devices through wireless power transmission
- Analysis of power budget and safety issues in a human body

Wireless Power Transmission (WPT) System and Safety Concerns

- Flexible and biocompatible materials and design
- Implanted electronics in the body
- Power absorption in the human body (The threshold limit value (TLV) should be less than 10 mW/ cm² at 10 GHz)
- Assessment of safety concerns of wireless power transmission system based on IEEE standard of radio-frequency (RF) safety

Devices	Power Requirement	Remarks
Wireless, bluetooth	20 mW	Transmission and feedback
Laser Diode (LD)	70 mW	Light source for excitation
Micro-controller	50 mW	Operation
Image Sensor	100 mW	Micro-spectrometer
Total	240 mW	



***Flexible and Highly Efficient
WPT Device Development and
Safety Concerns Assessment***



WPT: Development of Various Rectenna Devices for Deep Brain Stimulation (DBS)

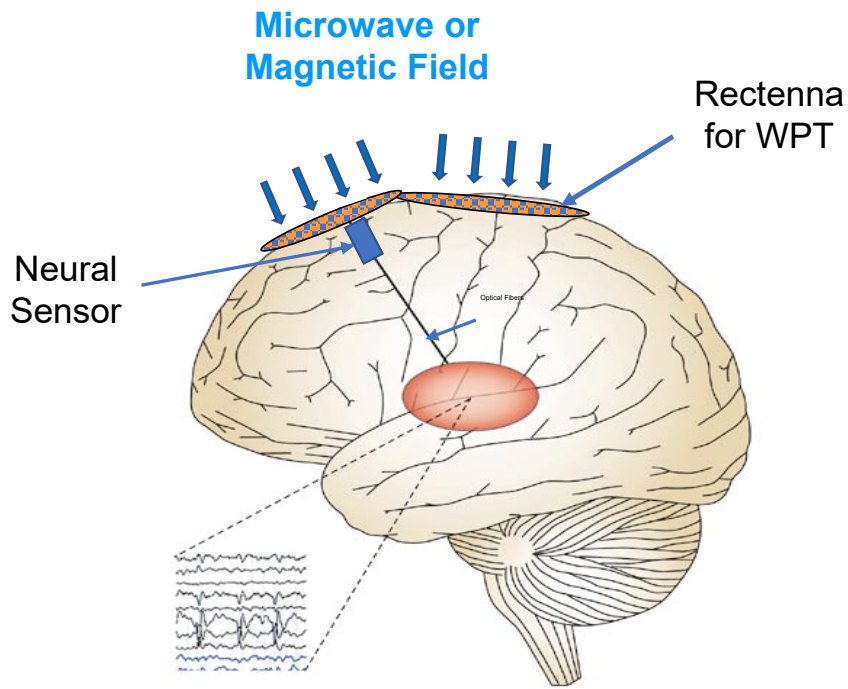

Rectenna Circuits fabricated for WPT





WPT: Rectenna Test

Output Power of Polyimide Rectenna vs Distances

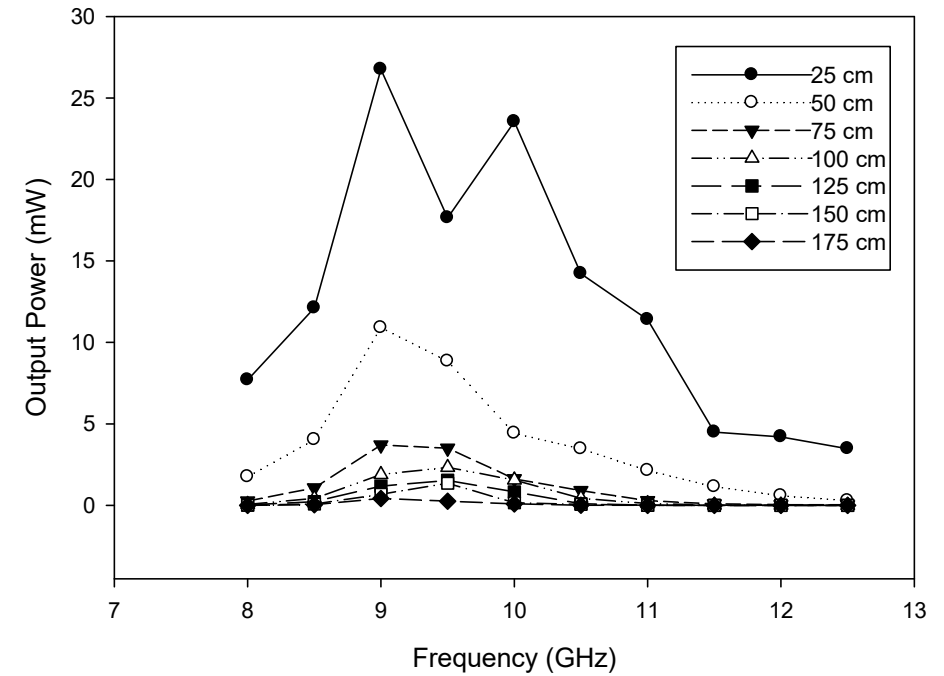
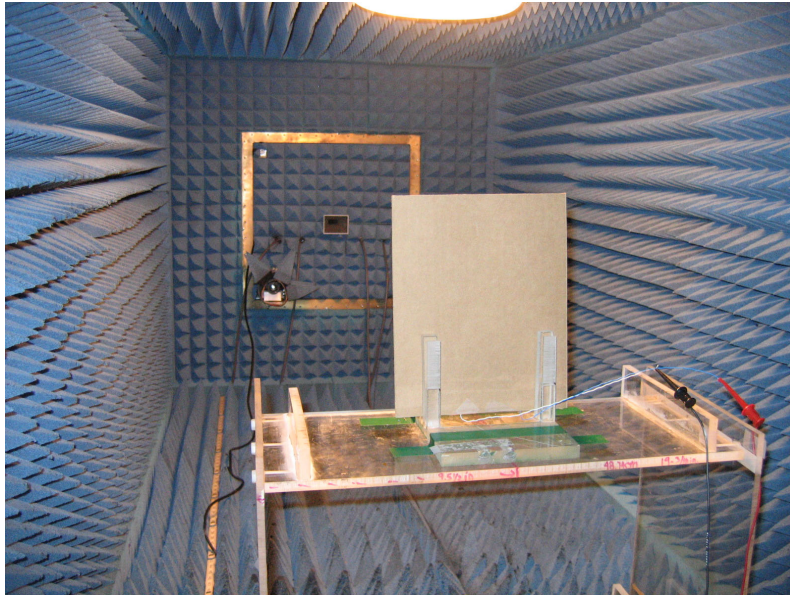



Passivation of Rectenna with Parylene-C and High Density Rectenna Array

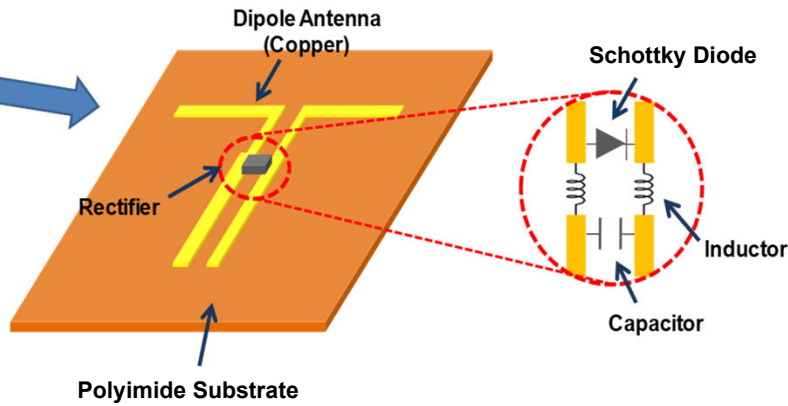
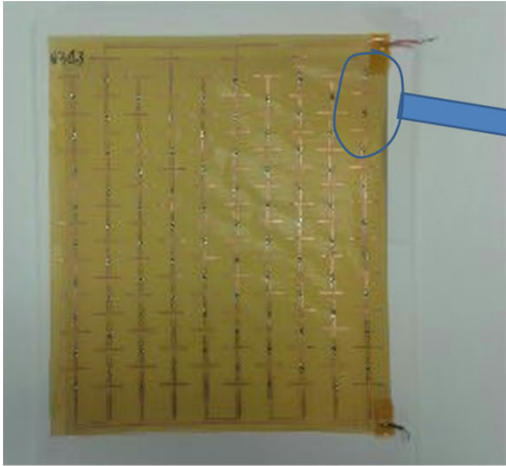

Output Power of Rectenna vs Frequency

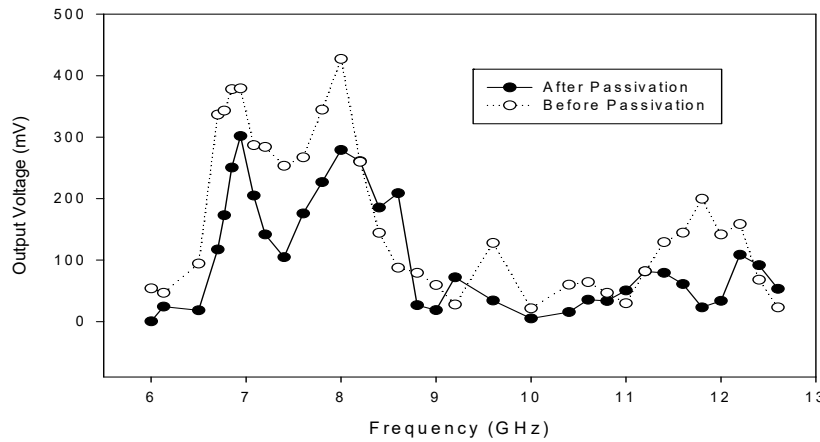
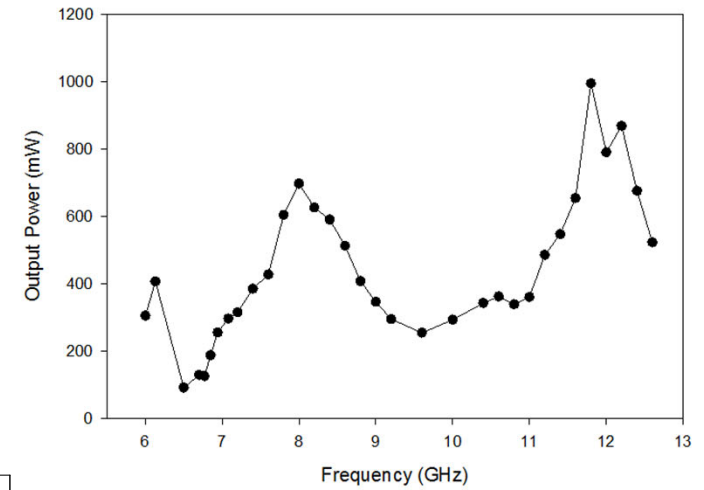



Micro-spectrometer for Neural Probe

For adaptive DBS, Medtronic announced the first implant of a deep brain stimulation (DBS) system that enables the sensing and recording of select brain activity while providing targeted DBS therapy. (Aug. 7, 2013)



Micro-spectrometer for *In-Vivo* Optical Neural Sensing

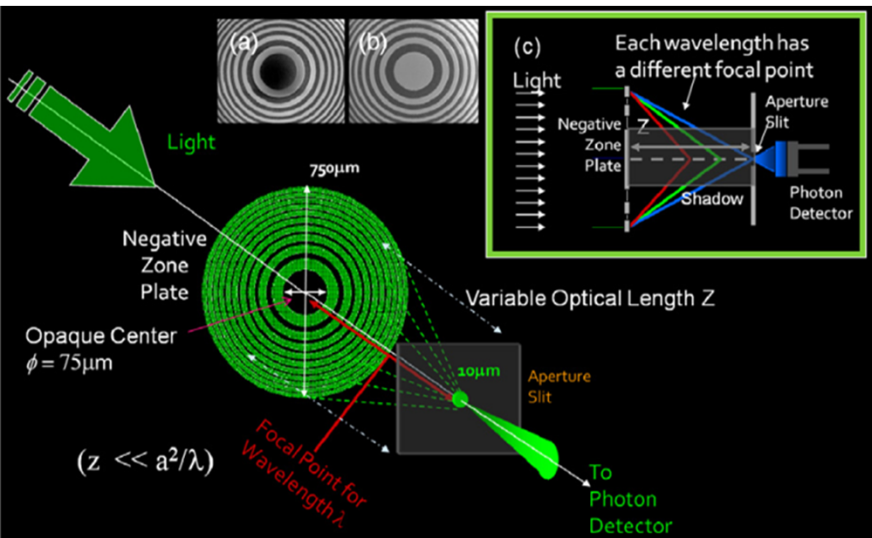

J. Opt. A: Pure Appl. Opt. 10 (2008) 095301

Y Park et al

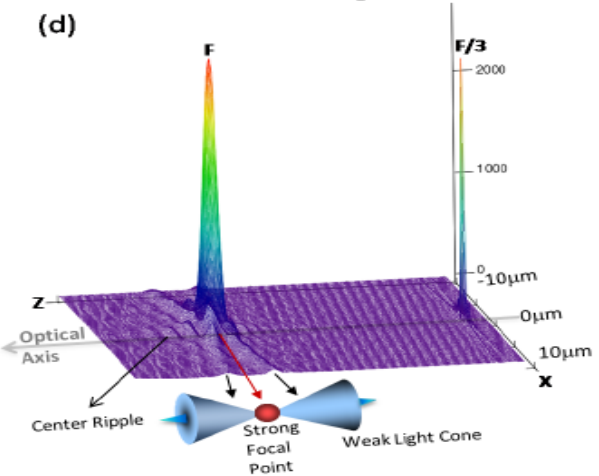
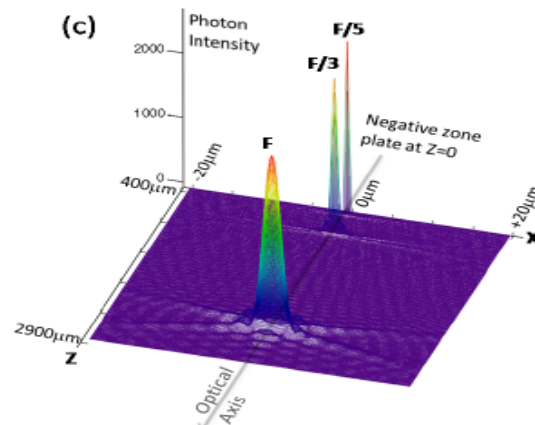
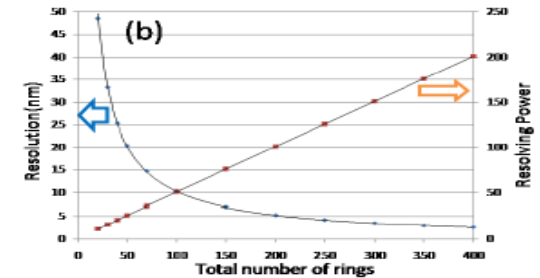
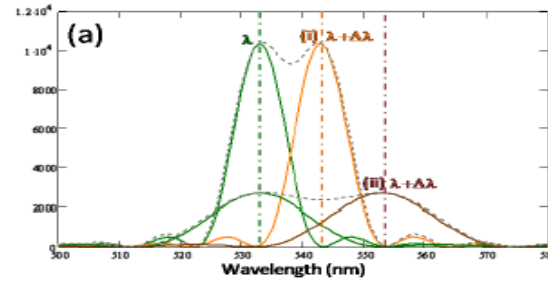



Neural Probe: Probe-Pin Device

by Norfolk State University under NASA Grant (NNX12AH22A)

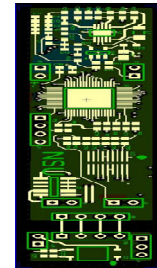
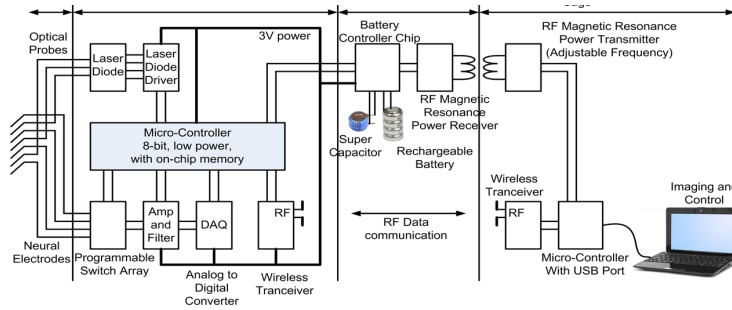
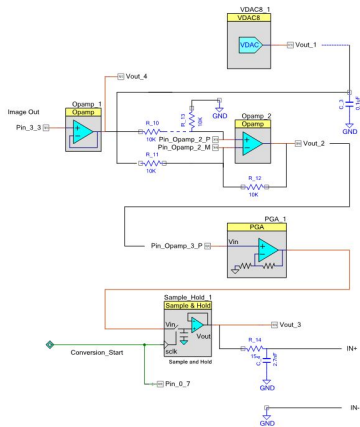
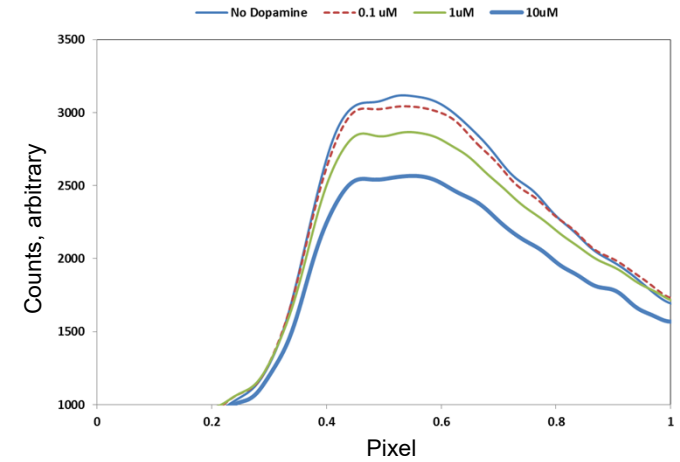
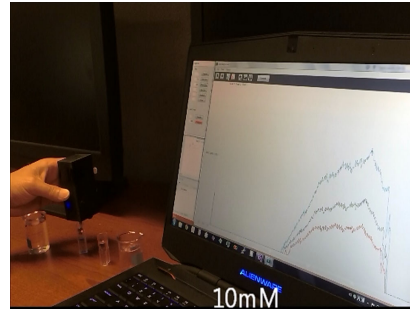
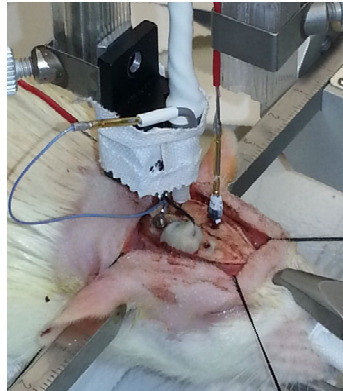
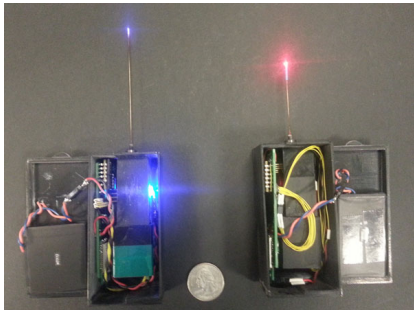

Stimulation at central Tegmental Area (VTA) (5.2 mm posterior, 1.0 mm lateral, 7.5 mm ventral)

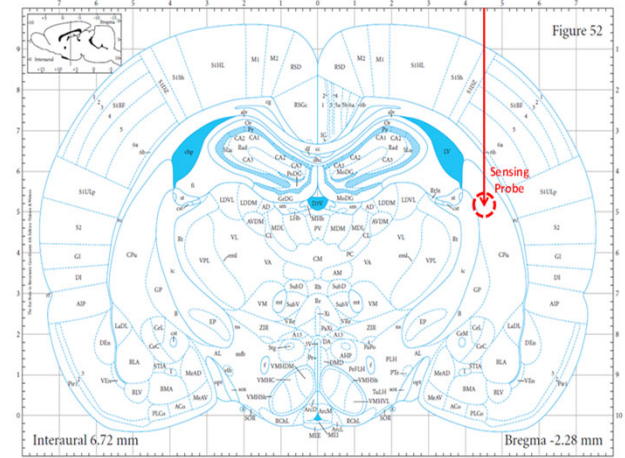



Hat Unit: Magnetic Resonance Coupled WPT System

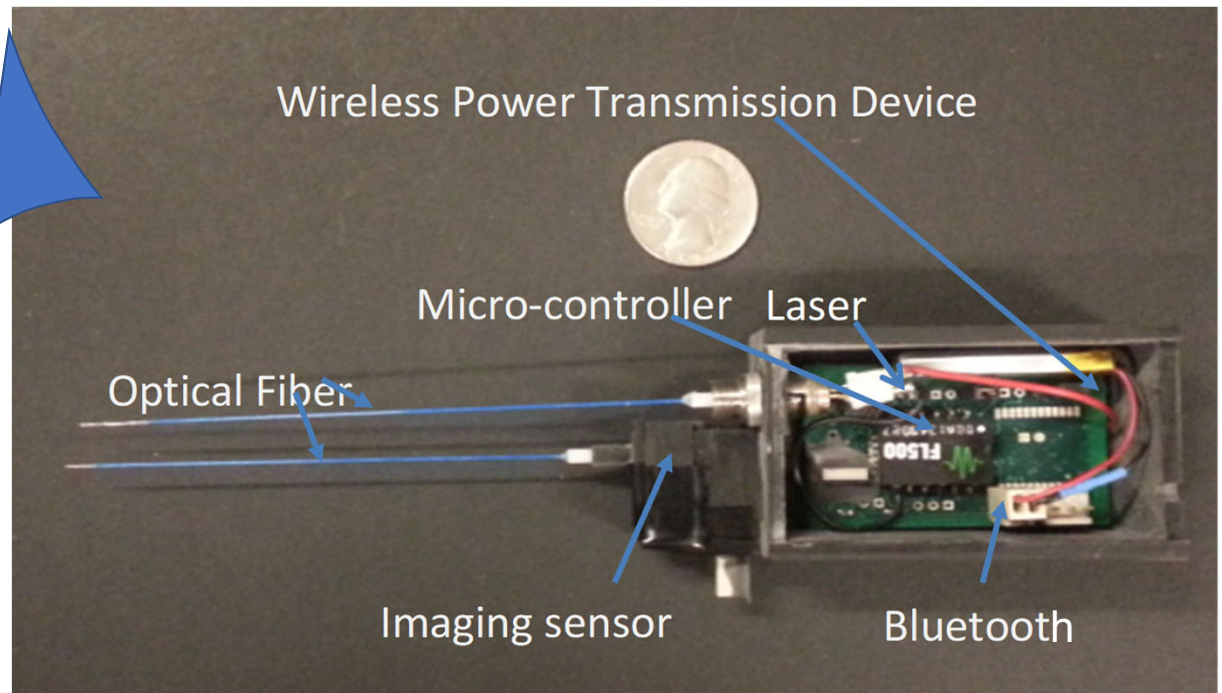
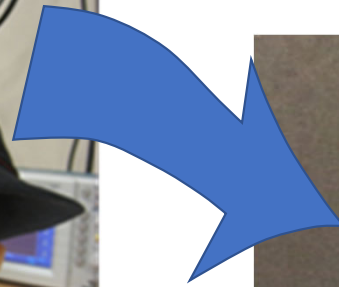



Electronics for Rectification and Voltage Regulation

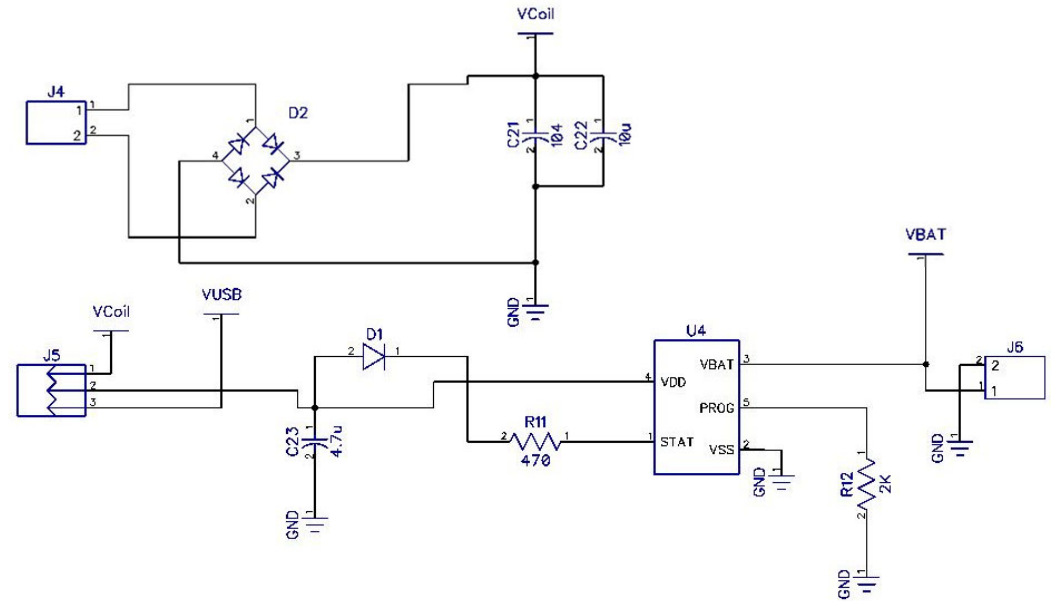
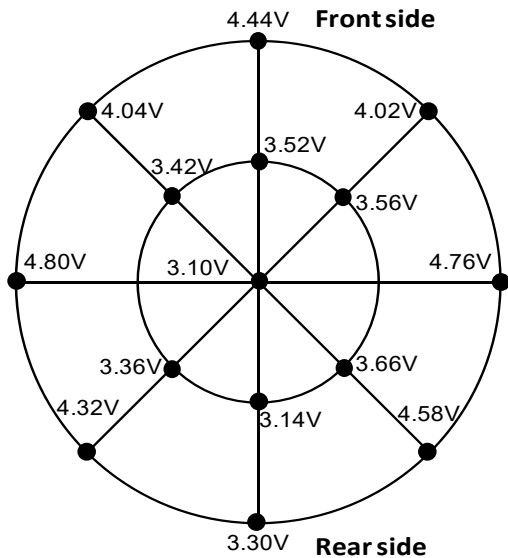
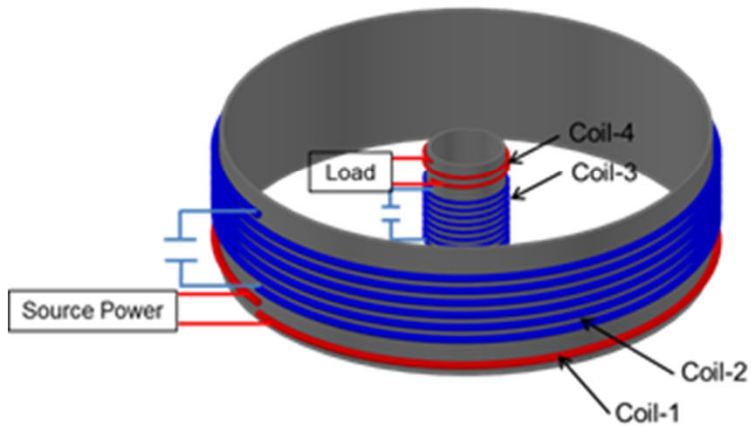



Concluding Remarks

- Laser and microwave devices for WPT have been under development at NASA LaRC since the late 1970s.
- WPT enables power beaming for short (by microwave) and long-distance (by laser) transmission.
- Wireless power systems are suitable for powering airships and continuous operation of deep brain stimulation systems without implanting batteries.
- Two different types of WPT modules (rectenna and magnetic resonance coupling devices) were developed for micro-spectrometer operation.
- Electronic circuits were developed for a WPT module which can control the high frequency of source signals and optimize power transfer efficiency.
- AC power signal rectification and voltage regulation circuits were also embedded in main system electronics.