



SPACE LAUNCH SYSTEM

Structural Dynamics Observations in Space Launch System Green Run Hot Fire Testing

Richard Moore¹, John Wall¹, Abran Alaniz¹,
Steve Ryan², Colter Russell¹, Jeb S. Orr¹
AAS Breckenridge

Feb 2-8th, 2023

1. McLaurin/ESSCA, 2. MTC/CPSS





Overview

The time and frequency domain response of the engines as controlled by the TVC system on the Core Stage are critical to SLS performance

The Simplex model for the mechanical feedback hydraulic actuator was extended to represent multiple coupled actuators and structural modal response from Core Stage and RS25 finite element models

- This formulation is used in the MASV and FRACTAL models

The Green Run test campaign provided opportunities to validate the models and verify as-built hardware performance

After analyzing test data, models were updated to:

- Incorporate finite gimbal stiffness
 - Critical to representing friction dynamics
- Account for actuator, gimbal, and vehicle stiffness reductions under ambient conditions
 - Critical to interpreting TVC measurements on the ambient vehicle

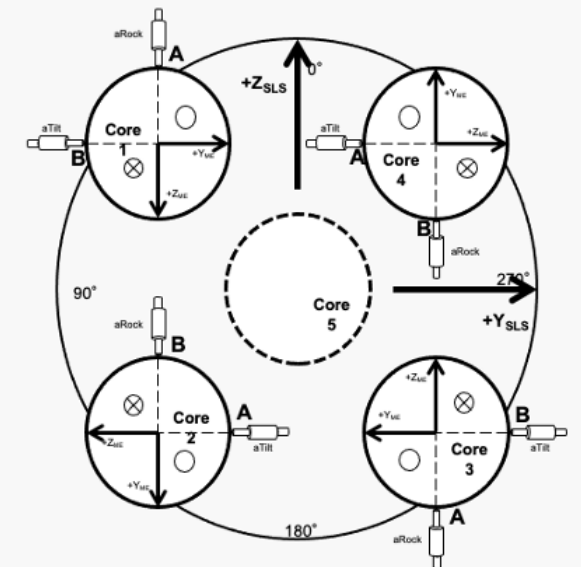
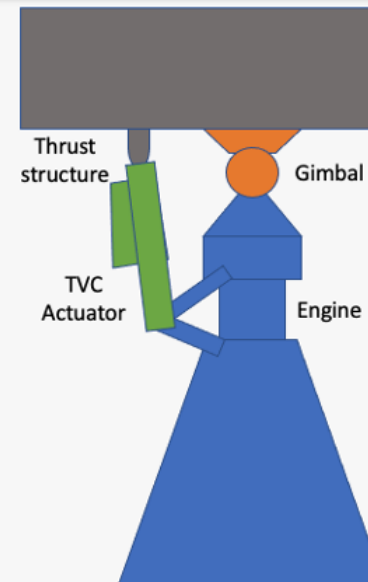
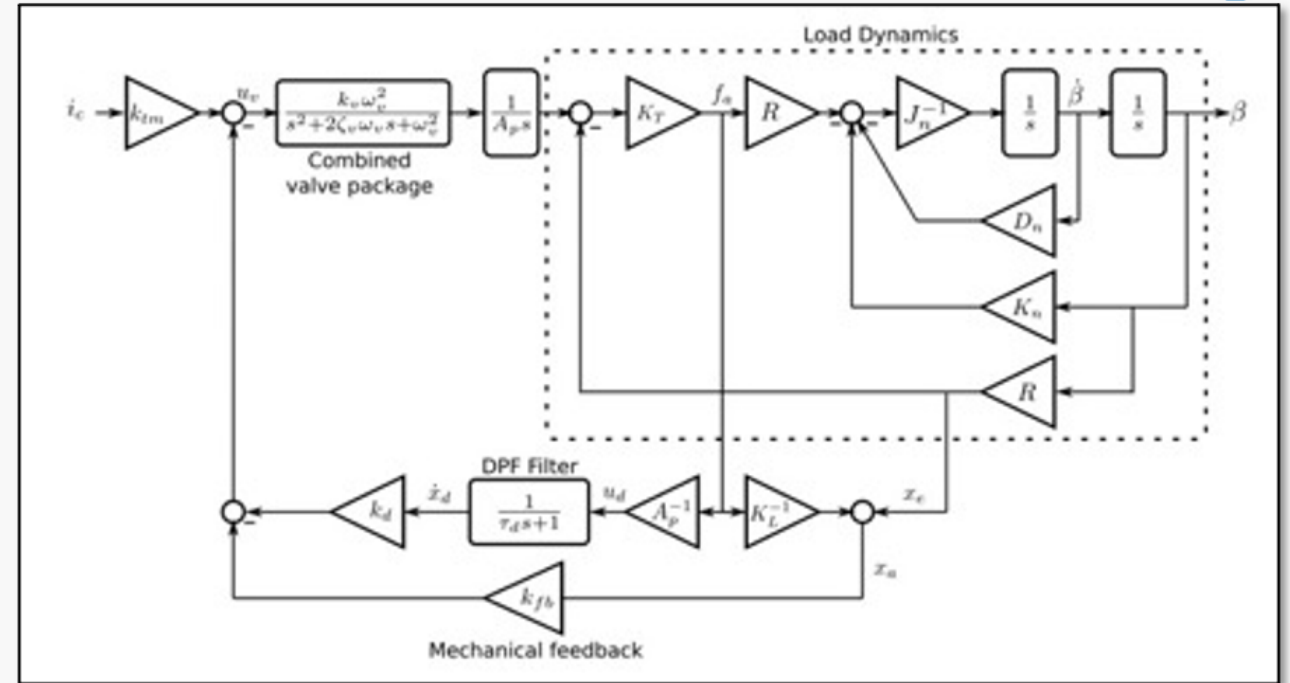

SLS Core Stage Structure-Coupled TVC Performance Overview

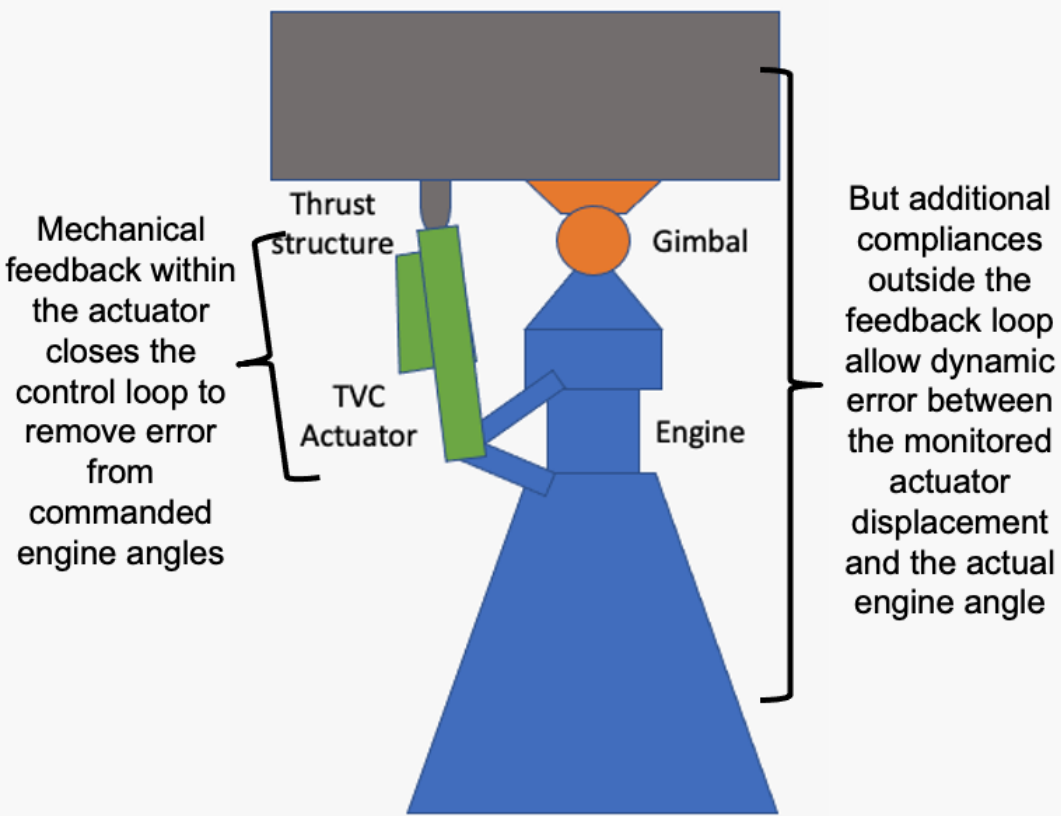

Despite a dense population of varying vehicle modes, the total stiffness that the actuator encounters is the term most critical to SLS CS system performance

- This places the load resonance notch in the frequency domain response of the actuator displacement feedback

$$\omega_l = \sqrt{\frac{K_L R^2}{J_n}}$$

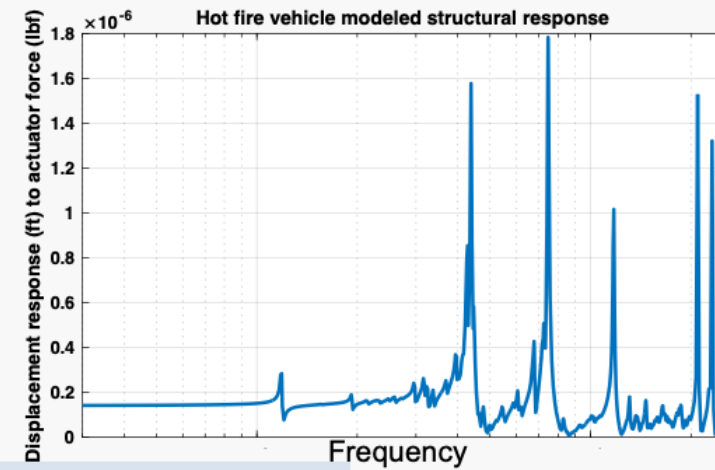
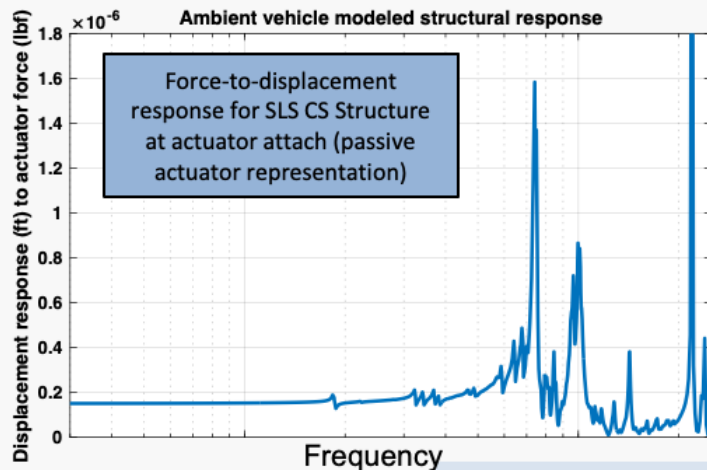

The number, amplitude, and frequency of the modes varies for different vehicle conditions

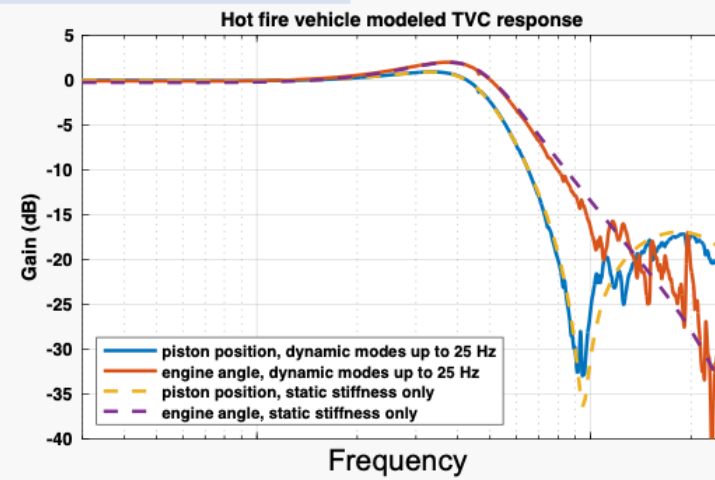
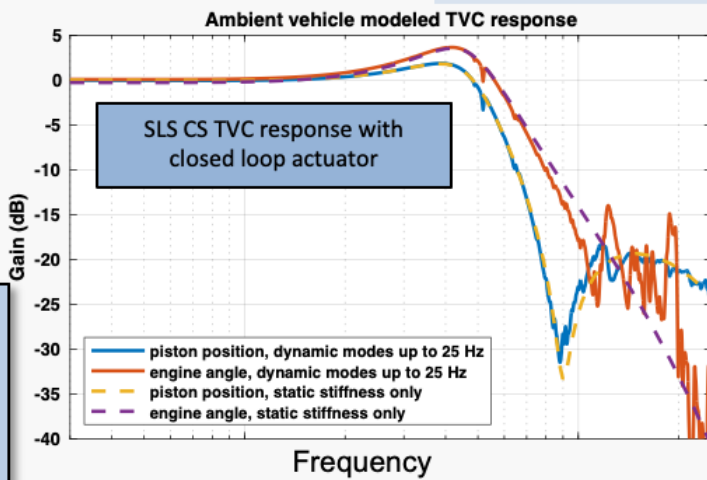



Test Environments Relevant to Structure-Coupled TVC Model V&V

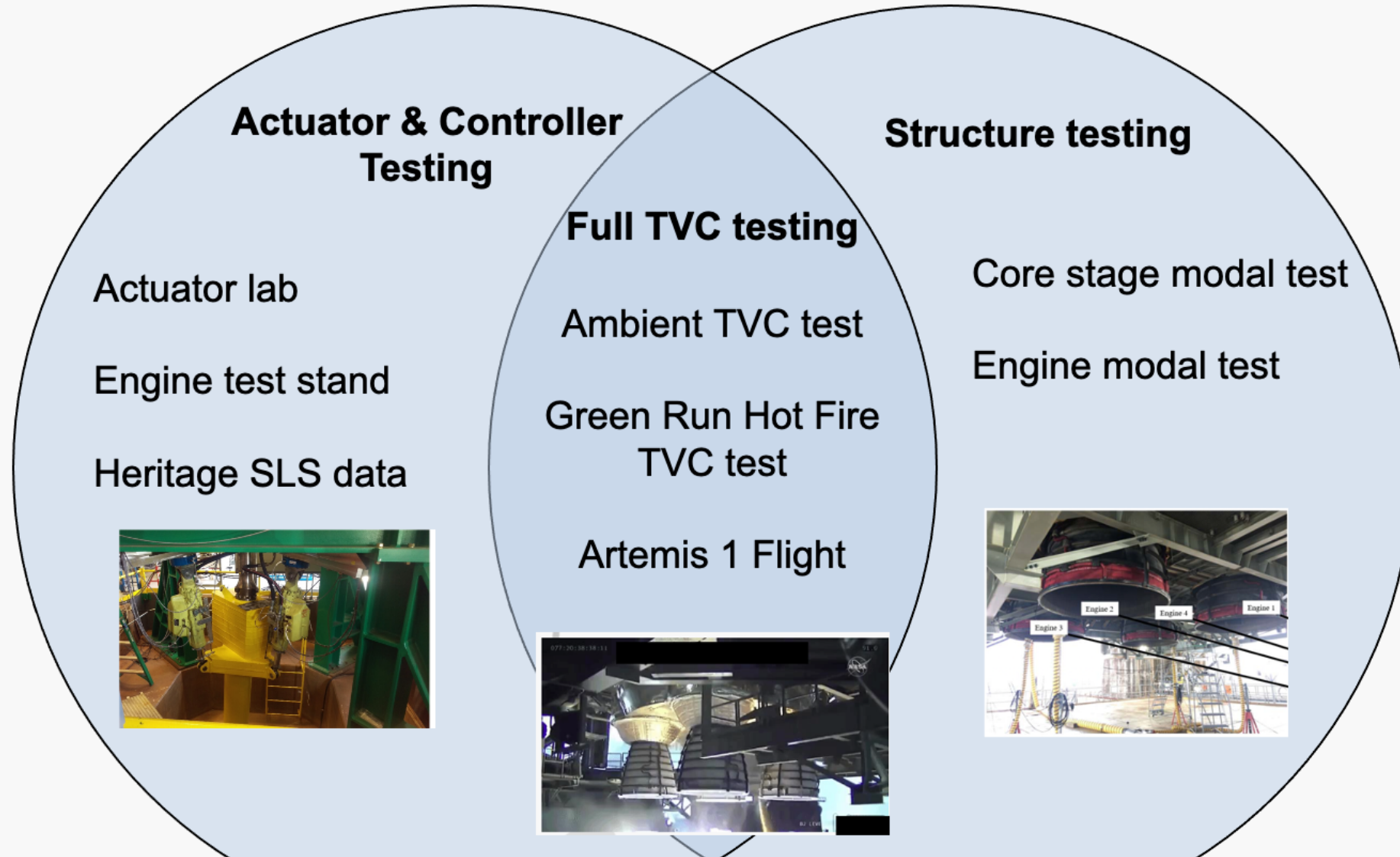

A complementary set of test environments and conditions allowed the actuators and structure to be investigated separately and together.

Different TVC Performance Measured at Ambient and Hot Fire

Very different damping and apparent load stiffness were observed in the ambient and hot fire tests

- Prior actuator and structure models had not predicted this
- Ambient performance violated requirements

This motivated an investigation to identify what differences between these tests drove the difference in observed performance

- Gimbal friction and friction-induced gimbal torsion under engine thrust
- Anomalously low actuator and gimbal stiffness in the absence of engine thrust

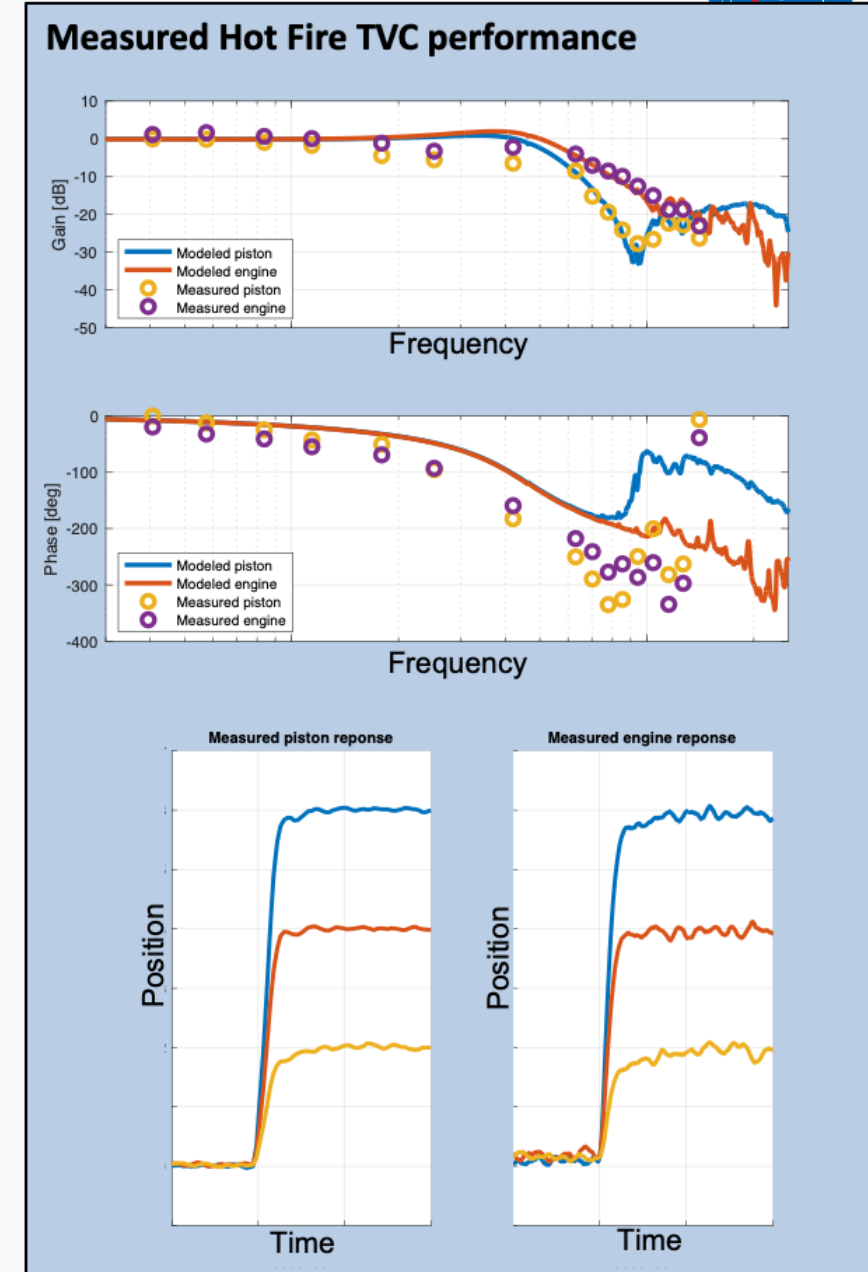
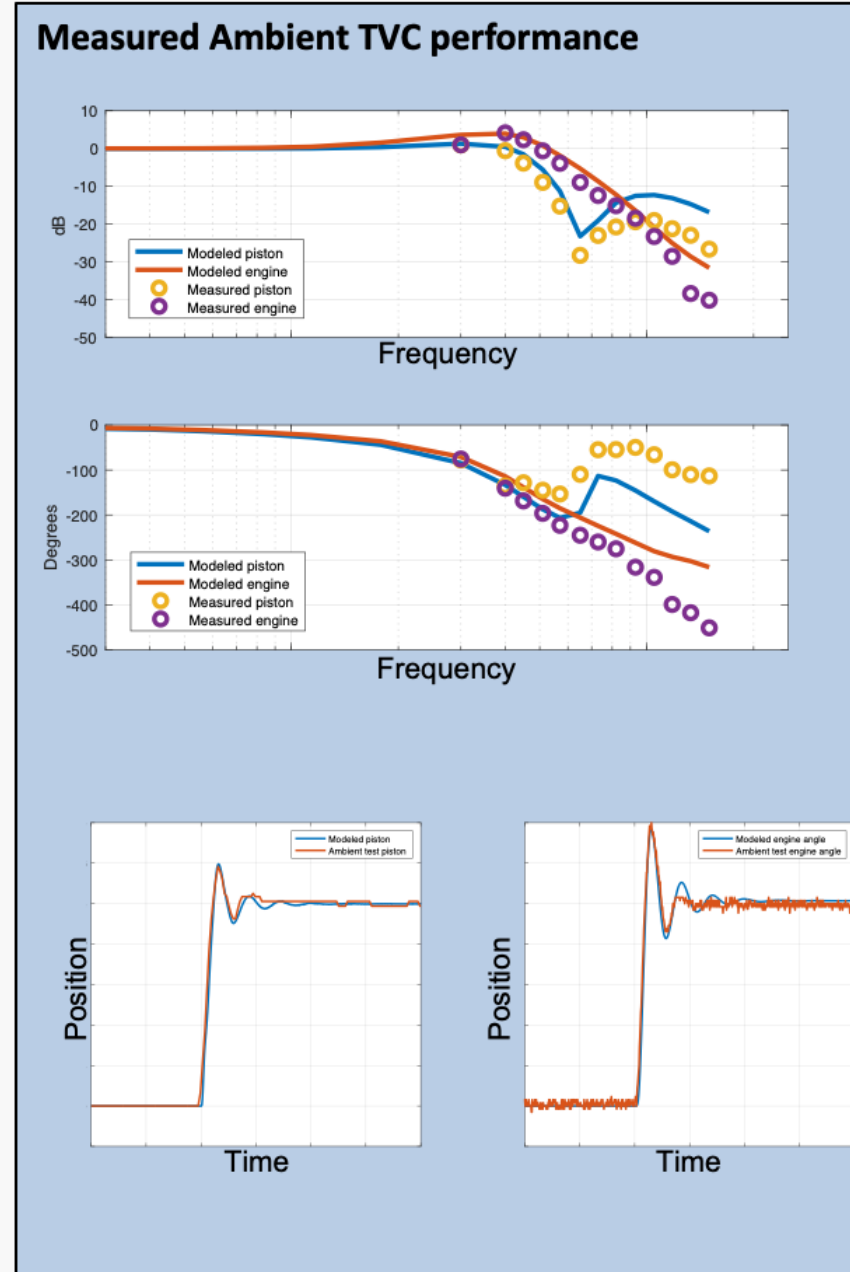



Actuator lab testing

Sine response runs in the actuator lab demonstrated that low command amplitudes moved the load resonance notch

- Lower amplitudes resulted in lower notch frequencies demonstrating lower overall system stiffness

Separate vendor data for static actuator testing showed that its stiffness is much lower for small loads

- The vendor attributes this to multiple factors including rod end spherical bearing loading and within-dead-band oil stiffness

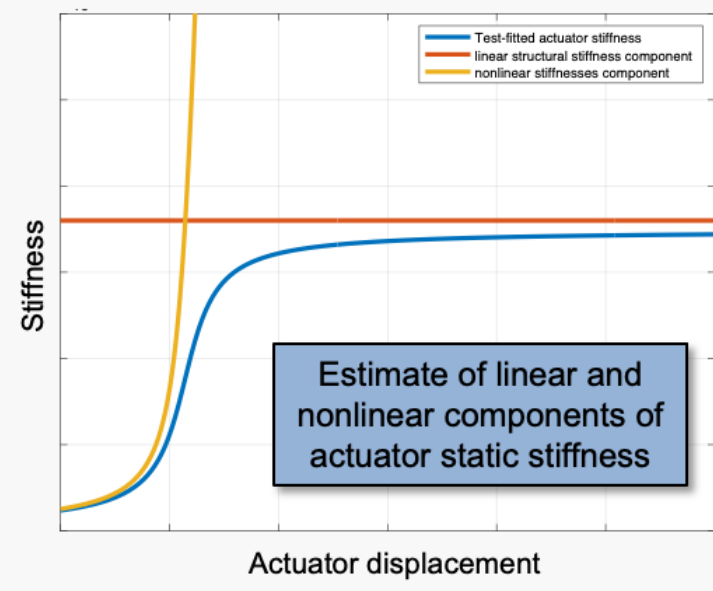
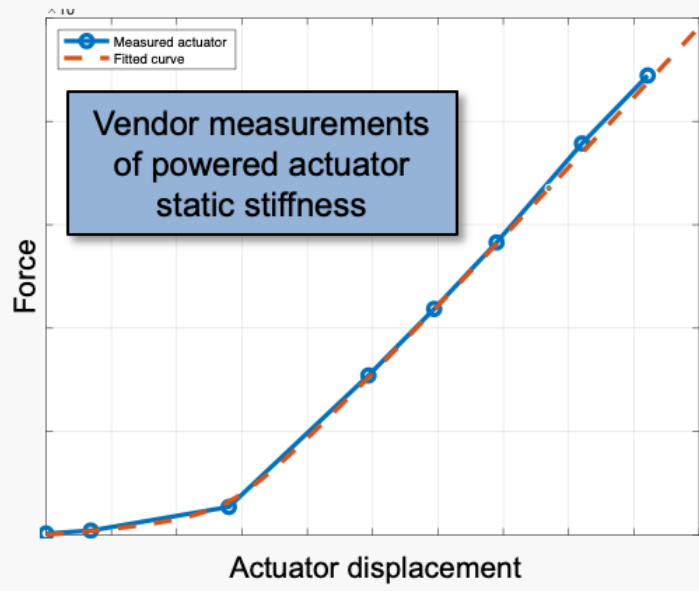
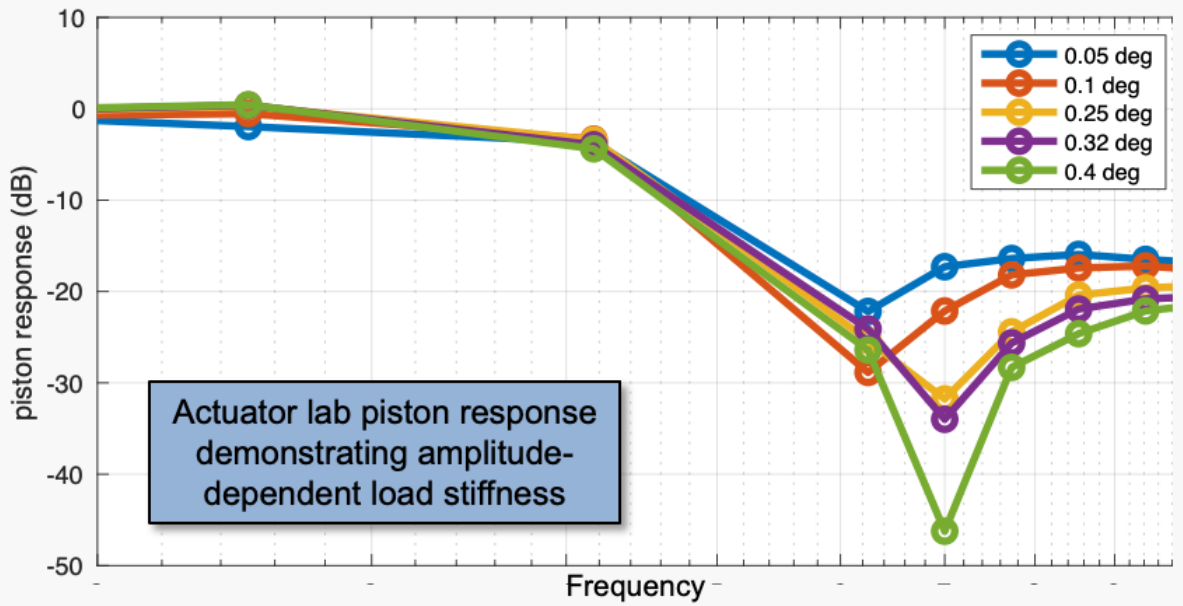
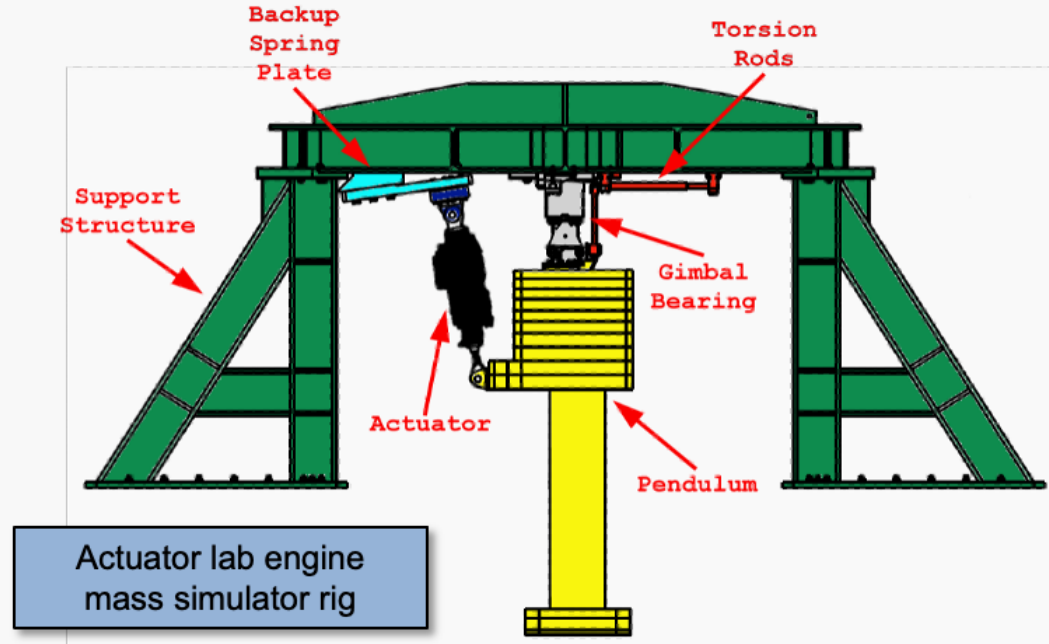



Model updates with nonlinear actuator stiffness

A stiffness curve was fit to the actuator stiffness test data

A Simulink implementation of the Simplex actuator model was updated to place the nonlinear actuator stiffness in series with the load

An ODE solver was run for the system with this nonlinear stiffness at different command amplitudes

- The load resonance notch was observed to drift as in the lab

Separately, it was found that for the simple sinusoidal case a weighted average of the exercised portion of the actuator stiffness curve yields an effective stiffness suitable for use in the linear Simplex model

Effective stiffness estimation

$$\omega_l = \sqrt{\frac{K_L R^2}{J_n}} \quad K_L = \frac{1}{\frac{1}{K_{ES}} + \frac{1}{K_{act}}}$$
$$\alpha = \frac{d^2}{dt^2} (a \sin bt) = -ab^2 \sin bt$$
$$f_{max}(a, b) = \frac{J_n \alpha_{max}(a, b)}{R}$$
$$\int_0^{x_{max}} f(x) dx = \int_0^{x_{max}} K_{act} x dx$$
$$\bar{K}_{act} = \frac{2}{x_{max}^2} \int_0^{x_{max}} f(x) dx$$

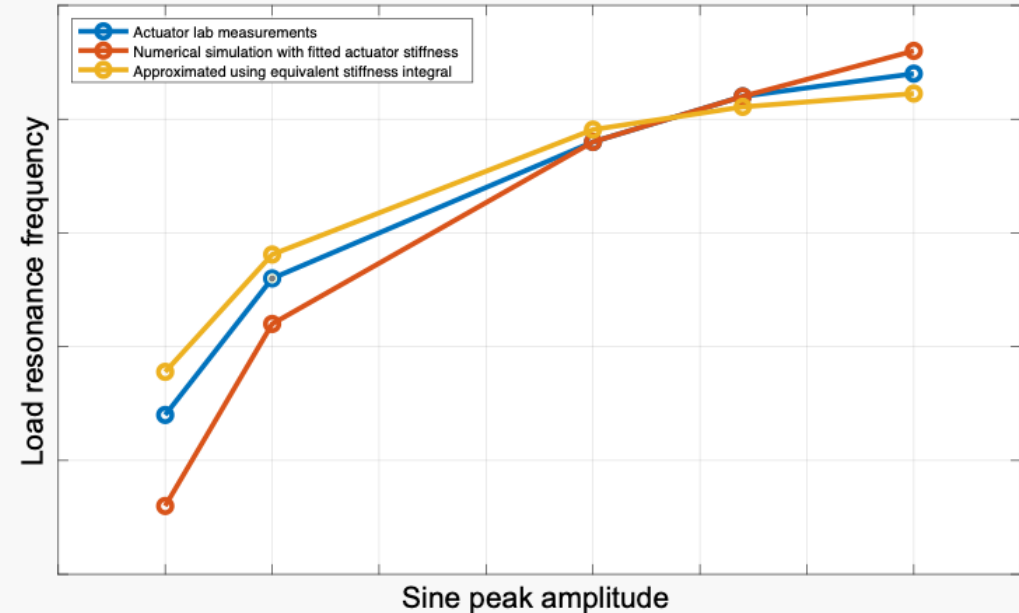
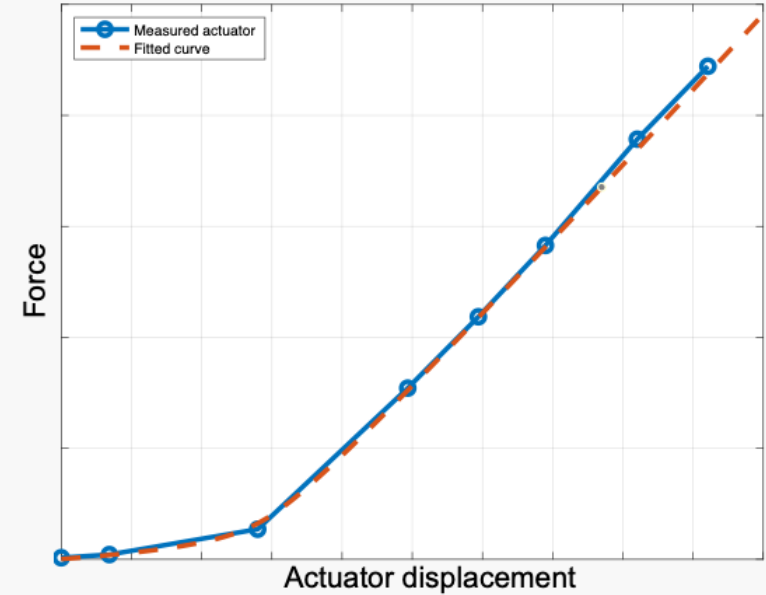

Modal testing



Pendulum mode:

- There had been a notion that a single engine pendulum mode with a defined relationship to the overall load stiffness could be observed during modal testing.
- This did not prove to be the case

Many engine modal peaks

- A variety of frequencies were identified as possible engine pendulum modes, each with very different effective load stiffnesses

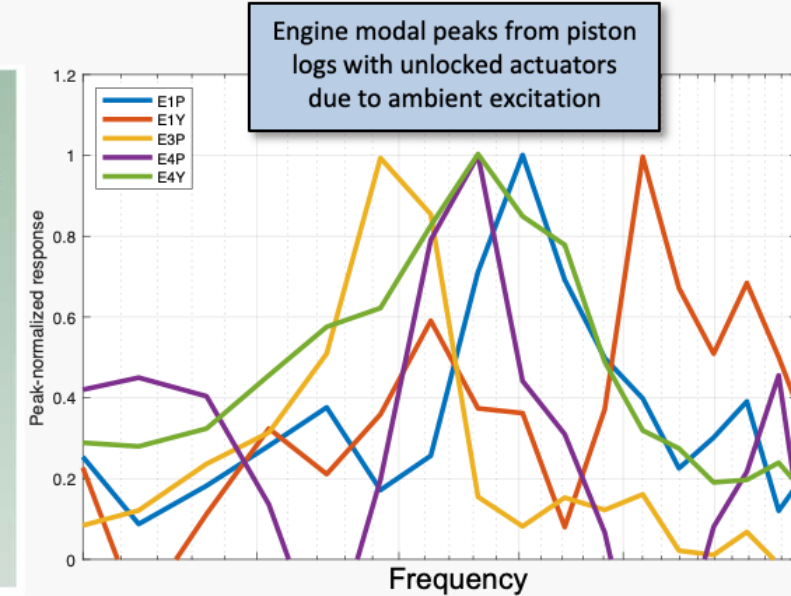
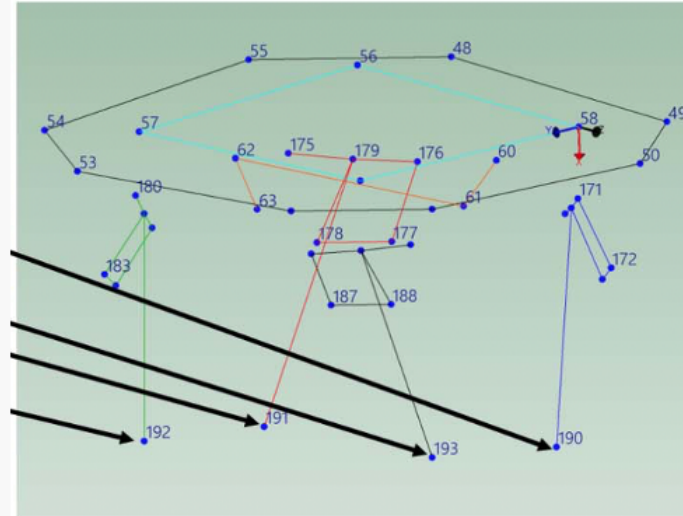

Ambient piston log frequency content

- Even without deliberate excitation, motion was noted in the logs of uncommanded actuators
- These also spanned across a large apparent stiffness range
- These observations are consistent with the actuator lab and vendor test data which also show a small region close to zero where actuator stiffness varies greatly.

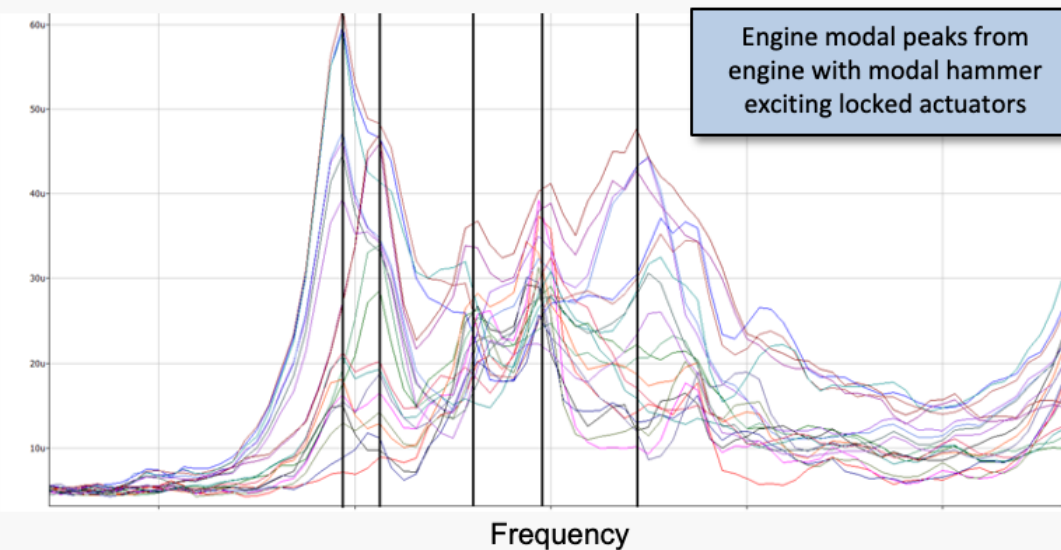

Ambient TVC testing

Under ambient test conditions, several factors contribute to the actuator encountering a lower load stiffness:

- Actuators operating in the nonlinear low-stiffness portion of their stiffness curve without thrust loading
- A lower gimbal stiffness for the downward gravity loading than for the upward thrust loading
- A lower overall vehicle stiffness when it is empty, uncooled, and only lightly pressurized

The Simplex model with the nonlinear actuator stiffness and updated vehicle & gimbal stiffnesses predicts engine and piston response in the frequency and time domains close to those observed in test

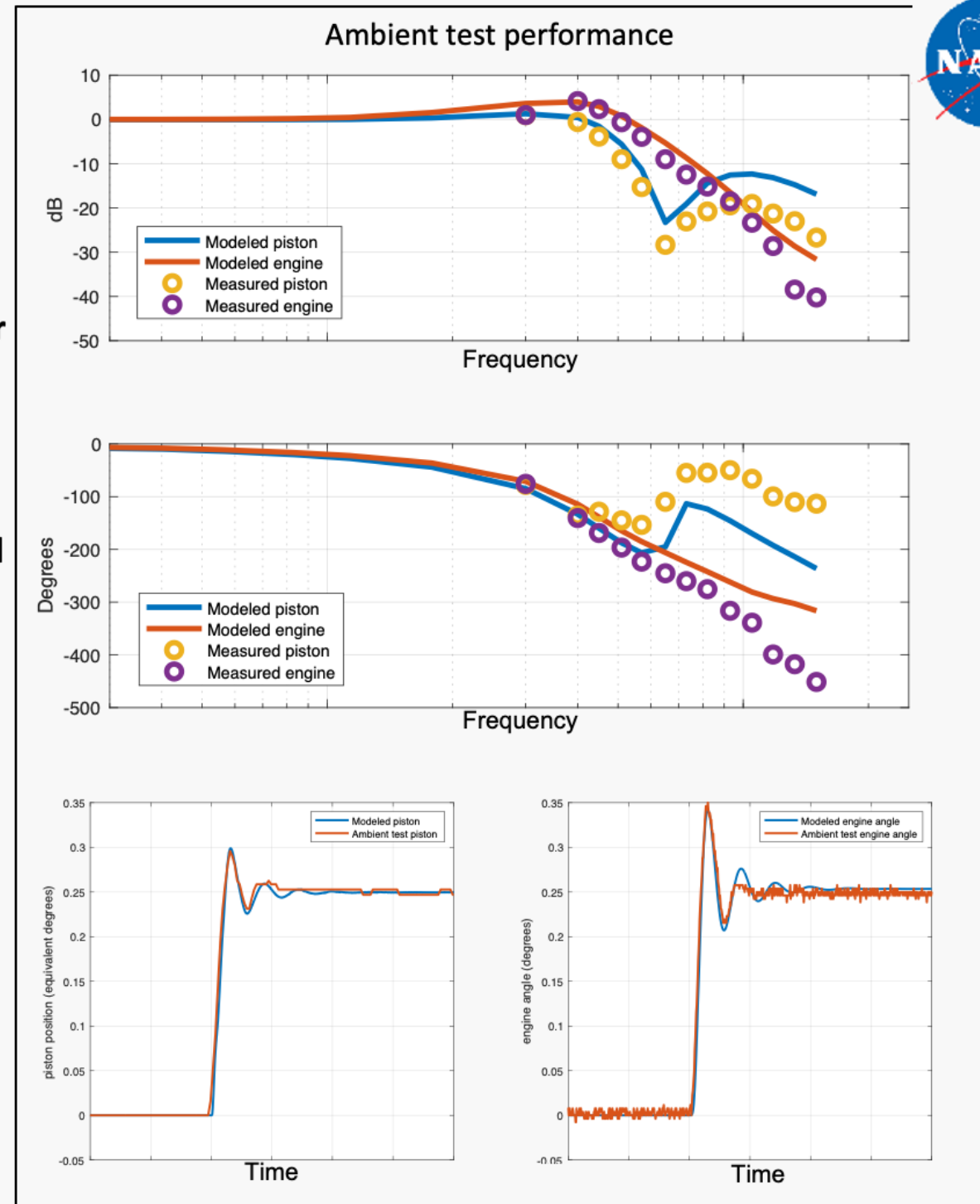
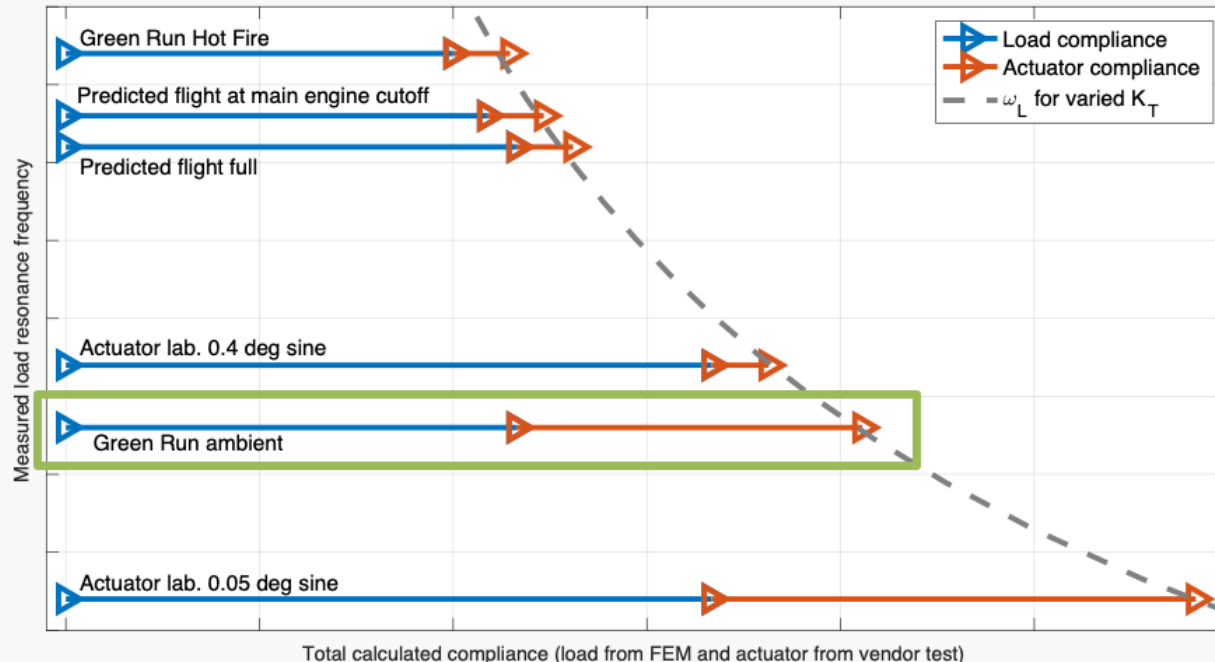

Green Run Hot Fire TVC Testing

With engine thrust loading the actuators and gimbals, the apparent load resonance notch is consistent with MASV predictions

- Overall stiffness in this case is dominated by vehicle and engine stiffnesses

Gimbal friction also eliminated the overshoot noted during ambient TVC testing

- Identifying an appropriate friction model and determining parameter values proved to be a significant effort

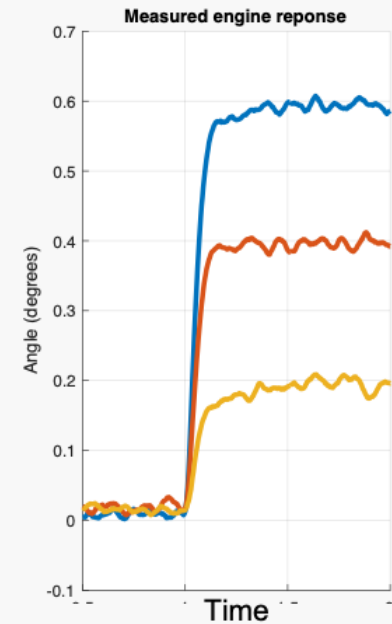
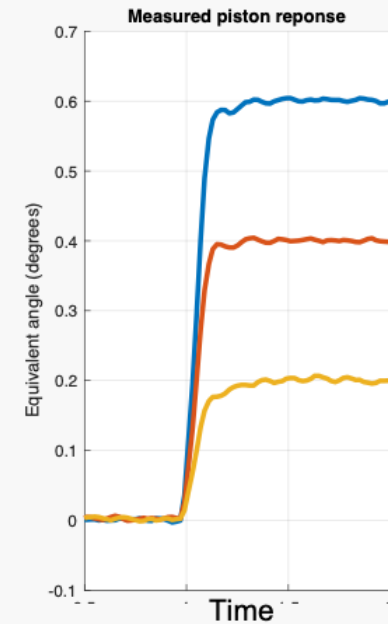
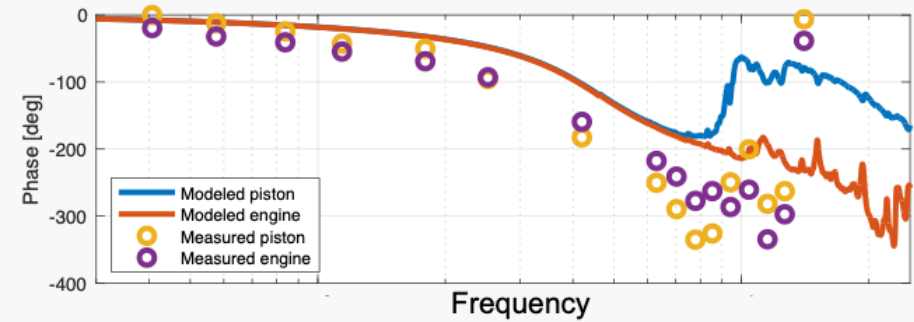
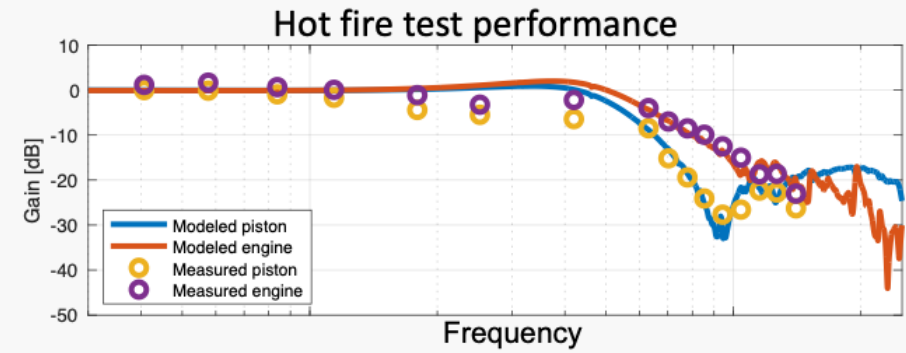
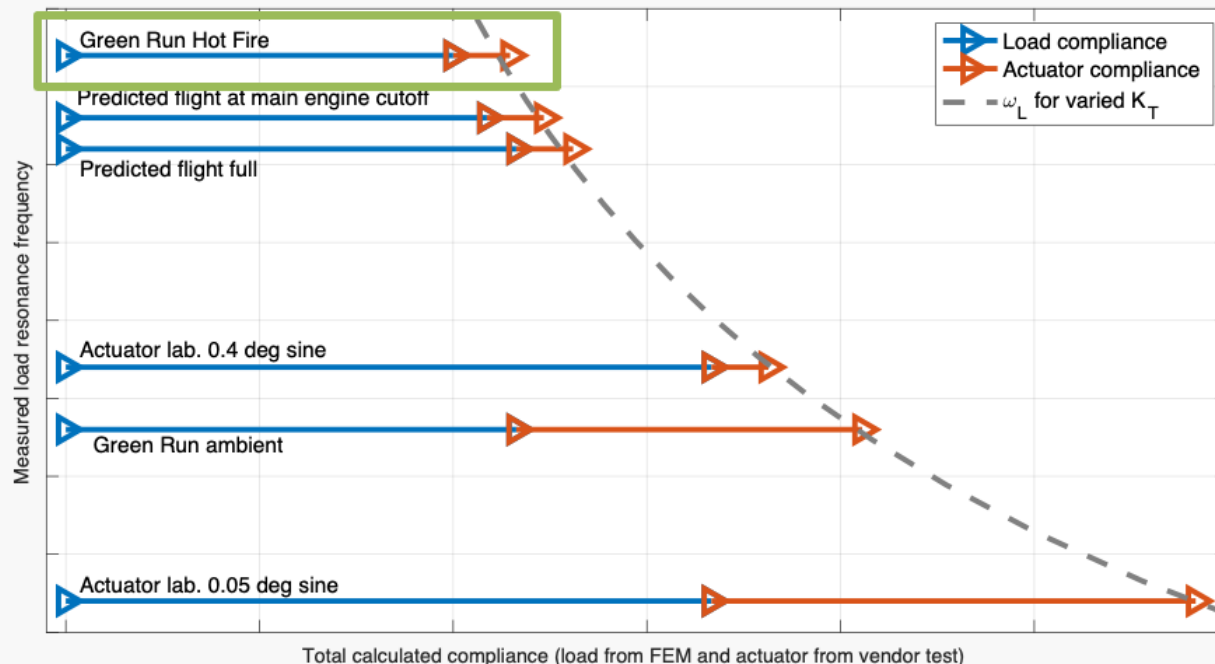



A Closer Look: Model-Predicted vs Test-Demonstrate Load Stiffnesses

The FEM-predicted overall stiffnesses from modal integrals vary somewhat for the 8 actuator locations on SLS CS

$$C_{stat} = \frac{x_{stat}}{f_a} = \sum_{i=J+1}^K \frac{\gamma_k^2}{\Omega_k^2}$$

Difference in mode shapes at actuator ends

Mode frequencies

Stiffness $\rightarrow K_{stat} = 1/C_{stat}$

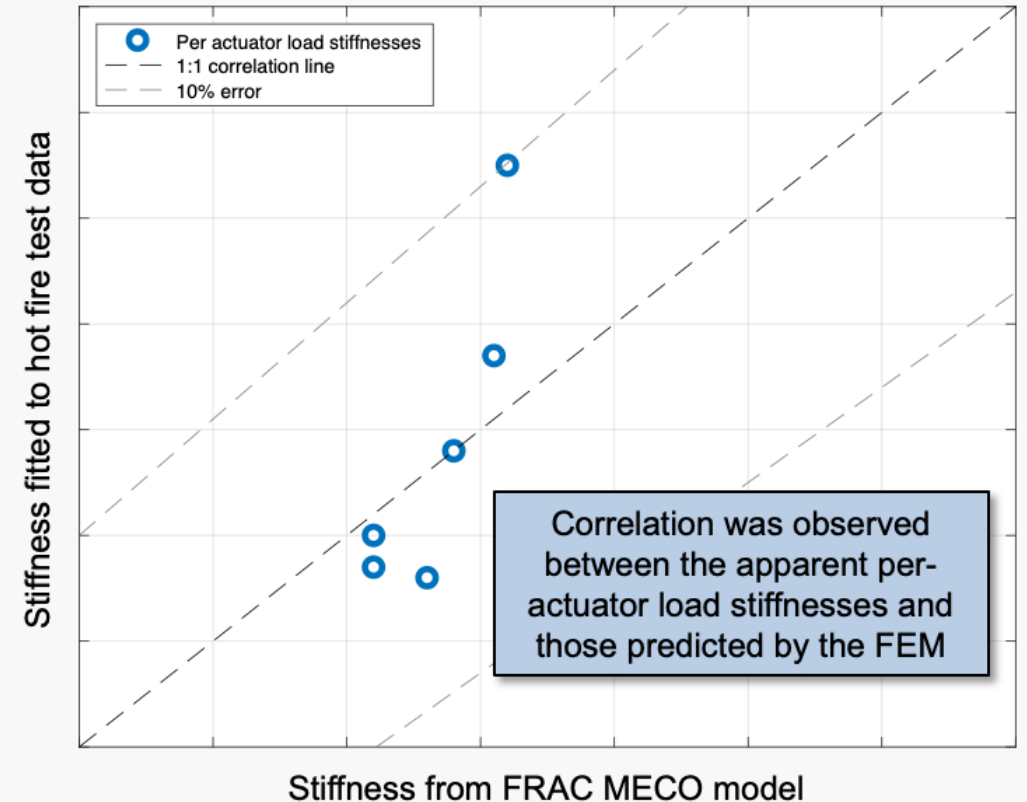
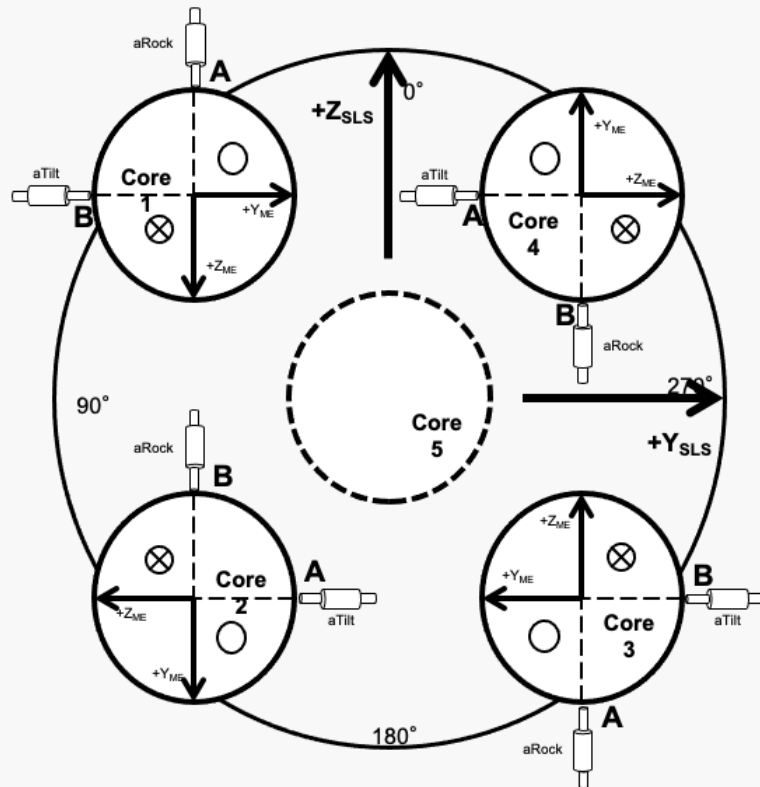

Gimbal torsion dynamics coupled by friction

GRHF step responses demonstrated that TVC damping was greater than during ambient TVC testing

But incorporating appropriate levels of friction damping in models eliminated the actuator piston notch

GRHF engine section accelerometers indicated greater than expected gimbal motion

Earlier FEM had assumed the gimbal to be stiff

The gimbal structure was analyzed and 6DOF stiffness was added to the FEM

Friction forces coupled to the gimbal stiffness allowed both damping and piston null to be simultaneously represented

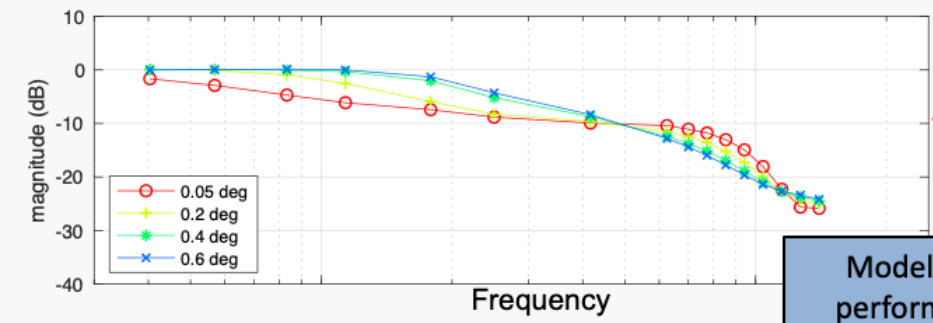
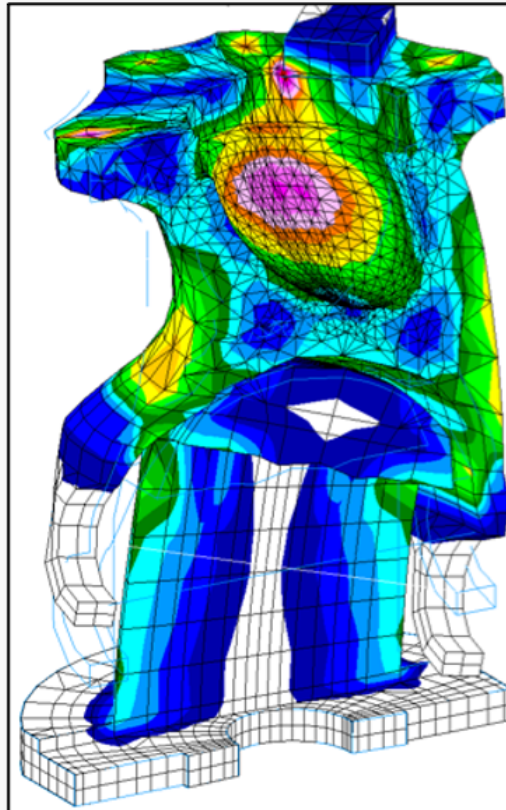

Modeled CS TVC performance with friction and rigid gimbal

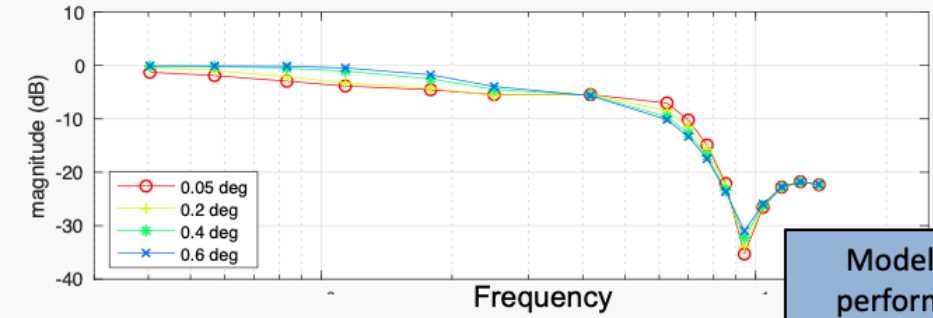
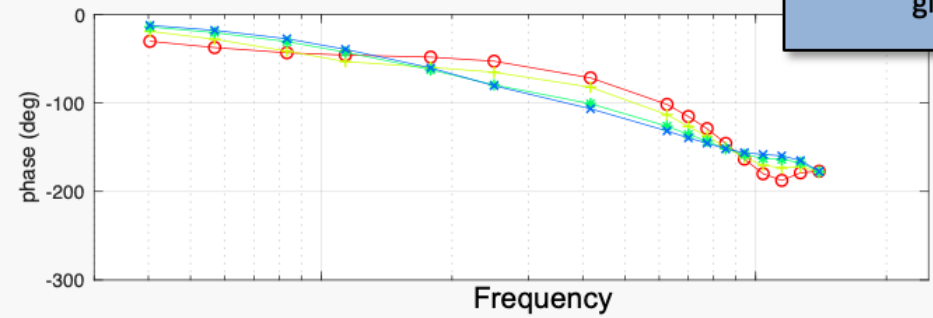

Modeled CS TVC performance with friction and 6DOF gimbal stiffness

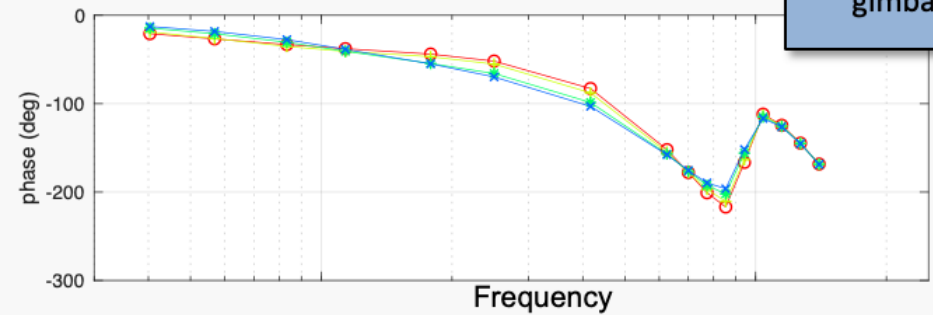



Conclusion

- **Total stiffness dominates the structural impact on TVC performance for SLS Core Stage**
 - Actuators are anomalously soft under light loads
 - Gimbal and vehicle stiffnesses are lower under ambient conditions than during hot fire conditions
- **Gimbal stiffness is critical to friction modeling**
 - Despite being stiff relative to other structures, the gimbal surfaces receive the friction forces
- **After accounting for gimbal and actuator interface phenomena, structure-coupled actuator model results agree well with measurements of the TVC on the Artemis 1 vehicle**