



**National Aeronautics
and Space Administration**

NASA Passive Thermal Control
Engineering Guidebook

Revision: 4.0

Date: 9/25/2023

Page 1 of 202

Distribution Restrictions:
Publicly available

Security Classification: Unclassified

NASA Passive Thermal Control Engineering Guidebook

Developed with support from the NASA Engineering and Safety Center (NESC) Passive Thermal Technical Discipline Team (TDT)

Compiled by:

Kaitlin Liles and Ruth Amundsen

Version: 4.0

Date: September 25 2023

Approved by representatives from each NASA Center:

AFRC	Tim Risch
ARC	Kamrul Choudhury
GRC	Brian Motil
GSFC	Veronica Otero and Juan Rodriguez
JPL	Jose Rivera
JSC	Ron Lewis
KSC	Cindy Fortenberry
LaRC	Ruth Amundsen and Kaitlin Liles
MSFC	John Sharp
SSC	Richard Wear
WFF	Lindsey Seo
NESC	Steve Rickman

TABLE OF REVISIONS

REVISION	DESCRIPTION	DATE
0.1	Draft for LaRC review	2/20/2018
0.2	Draft for Steve Rickman review	3/11/2018
0.3	Changes accepted for clean copy to send to Steve Rickman	4/16/2018
0.4	With clean-up edits to post for Thermal TDT/CLT members	4/20/2018
0.8	After editing on SharePoint by all NASA Centers	8/15/18
1.0 draft	Post-TFAWS clean-up edits, additions to model & tool tables	9/7/2018
1.0	Final small edits including "To be added" section, JPL and AFRC added to Table 1	9/17/18
2.0	Edits since version 1.0 collected and added to release	8/19/19
3.0	Edits by thermal users	Not released
3.1	Edits from Legal and thermal users, sanitize links for public release PDF version	4/28/22
4.0	Edits from several users: equation corrections, link to Lunar Guidebook, clarification on heater over-taping, SpaceClaim section, PID controller description, model run time troubleshooting, MLI blanket attachment details.	9/25/23

 National Aeronautics and Space Administration	NASA Passive Thermal Control Engineering Guidebook	Revision: 4.0
	Date: 9/25/2023	Page 3 of 202
	Distribution Restrictions: Publicly available	Security Classification: Unclassified

Note on links: This document was originally developed for internal NASA use only. In an effort to share this knowledge with the wider thermal engineering audience, as part of NASA’s mission, the decision was made to have a publicly available version of the document. Since the live version of this document is still used for capture of NASA knowledge and best practices, some internal NASA sources and links are listed for NASA users only, which may not be available to the general public. Where a website or source is available to the public, the web site is spelled out in text form, rather than as an embedded link. The authors hope that having this general thermal knowledge available in a public format is beneficial irrespective of these safeguards.

For NASA/JPL users, contact Kaitlin Liles or Ruth Amundsen with suggested revisions, or edit living document on SharePoint.

General. *Trade names and trademarks are used in this guidebook for identification only. Their usage does not constitute an official endorsement, either expressed or implied, by the National Aeronautics and Space Administration (NASA).*

Trademarks. Trademarks and trade names that are used herein are the sole property of their respective owners. A non-comprehensive list of trademarks and trade names is set forth below:

- The brand names “C&R Thermal Desktop®,” “RadCAD®,” “FloCAD®,” “Thermal Desktop™,” “SINDA/FLUINT™,” “CRTECH TD DIRECT®,” “TD Direct™,” “C&R Technologies®,” and “Cullimore & Ring Technologies” are trademarks and trade names of Cullimore & Ring Technologies, Inc.
- The brand names “Autodesk®,” “AutoCAD®,” and “Autodesk CFD” are trademarks and trade names of Autodesk, Inc.
- The brand name “SpaceClaim®” and “ANSYS®” are trademarks and trade names of Ansys, Inc.
- The brand names “SimApps™,” “Abstract Engineering Model™,” and “Comet Solutions™” are trademarks and tradenames of Comet Solutions, Inc.
- The brand names “COMSOL Multiphysics®,” and “COMSOL®,” are trademarks and tradenames of Comsol, Inc.
- The brand names “Windows®,” “Excel®,” “PowerPoint®,” “SharePoint®,” “Word,” “Office 365®,” “Microsoft 365,” Outlook®, “OneNote®,” “Skype®,” and “Microsoft®” are trademarks and trade names of the Microsoft Corporation.
- The brand names “MATLAB®,” and “MathWorks®” are trademarks and tradenames of The MathWorks, Inc.
- The brand names “MSC Nastran,” “Patran,” “MSC Software®,” and “Marc®” are trademarks and tradenames of MSC Software Corporation.
- The brand names “Simcenter™,” “STAR-CCM+™” and “Femap™” are trademarks and trade names of Siemens Aktiengesellschaft.
- The brand names “Dragon®” and “SpaceX®” are trademarks and trade names of Space Exploration Technologies Corp.
- The brand name “Creo®” is a trademark and trade name of the PTC, Inc.
- The brand name “SOLIDWORKS®” is a trademark and trade name of Dassault Systemes SolidWorks Corporation.

 National Aeronautics and Space Administration	NASA Passive Thermal Control Engineering Guidebook	Revision: 4.0
	Date: 9/25/2023	Page 4 of 202
	Distribution Restrictions: Publicly available	Security Classification: Unclassified

- The brand name “CODE V®” is a trademark and trade name of Synopsys, Inc.
- The brand name “Zemax®” is a trademark and trade name of Zemax, LLC.
- The brand name “Kapton®” is a trademark and trade name of DuPont Electronics, Inc.
- The brand names “3M®” and “Scotch-Brite®” are trademarks and trade names of the 3M Corporation.
- The brand name “Gap Pad®” is a trademark and trade name of Henkel IP & Holding Limited Liability Company.
- The brand name “NuSil®” is a trademark and trade name of Nusil Technology, LLC.
- The brand name “CHO-THERM®” is a trademark and trade name of Parker Intangibles LLC.
- The brand name “Teflon®” is a trademark and trade name of the Chemours Company FC, LLC.
- The brand name “Chemglaze®” is a trademark and trade name of the Lord Corporation.
- The brand name “Linux®” is a trademark and trade name of Linus Torvalds.
- The brand name “Altair HyperMesh®” is a trademark and trade name of Altair Computing, Inc.
- The brand name “I-deas™,” is a trademark and trade name of the Siemens Industry Software Inc.
- The brand name “Rust-Oleum®” is a trademark and trade name of the Rust-Oleum Corporation.
- The brand name “Hentzen Coatings” is a trademark and trade name of Hentzen Coatins, Inc.
- The brand name “Acryshield®” is a trademark and trade name of the National Coatings Corporation.
- The brand name “ASHRAE®” is a trademark and trade name of the American Society of Heating, Refrigerating and Air-Conditioning Engineers, Inc.
- The brand name “ASTM®” is a trademark and trade name of the American Society for Testing and Materials Corporation.
- The brand names “Stycast®” and “Loctite®” are trademarks and trade names of the Henkel Corporation.
- The brand name “Arathane®” is a trademark and trade name of the Huntsman Advanced Materials Americas LLC.
- The brand name “Heat-Spring®” is a trademark and trade name of the Indium Corporation of America.
- The brand name “Cytec®” is a trademark and trade name of the Cytec Technology Corporation.
- The brand name “Conathane®” is a trademark and trade name of the Cytec Olean Corporation.
- The brand name “Imperx™” is a trademark and trade name of Imperx Inc.
- The brand name “VELCRO®” is a trademark and trade name of VELCRO BVBA.
- The brand name “KNOWLEDGENOW®” is a trademark and trade name of the Electronic Knowledge Corporation.
- The brand name “InControl™” is a trademark and trade name of L3Harris Technologies, Inc.
- The brand names “Google®” and “Google Docs™” are trademarks and trade names of Google LLC.

The above, and any other third-party trademarks, trade names, or brand names that may be referred to herein are for identification only of goods and services, and such trademarks, trade names, or brand names are the trademarks or registered trademarks of their respective holders.

 National Aeronautics and Space Administration	NASA Passive Thermal Control Engineering Guidebook	Revision: 4.0
	Date: 9/25/2023	Page 5 of 202
	Distribution Restrictions: Publicly available	Security Classification: Unclassified

No Representations or Warranties.

This is an internal working paper for NASA thermal control engineering consideration and comment. Information contained in this guidebook is subject to change, and no reliance on any of the information contained should be made without independent verification. NASA makes no representations or warranties concerning this publication and any data or information, or its fitness for any particular use. Use of the information in this guidebook is at your own risk.

THIS PUBLICATION AND ITS CONTENTS ARE PROVIDED “AS IS” WITHOUT ANY WARRANTY OF ANY KIND, EITHER EXPRESSED, IMPLIED, OR STATUTORY, INCLUDING, BUT NOT LIMITED TO, ANY WARRANTY THAT IT WILL CONFORM TO SPECIFICATIONS, ANY IMPLIED WARRANTIES OF MERCHANTABILITY, FITNESS FOR A PARTICULAR PURPOSE, OR FREEDOM FROM INFRINGEMENT, ANY WARRANTY THAT THE NASA PUBLICATION OR CONTENTS WILL BE ERROR FREE, OR ANY WARRANTY THAT IT WILL CONFORM TO ANY STANDARDS, THIRD PARTY INSTRUCTIONS, OR SPECIFICATIONS. IN NO EVENT SHALL THE UNITED STATES GOVERNMENT, OR ITS CONTRACTORS OR SUBCONTRACTORS, BE LIABLE FOR ANY DAMAGES, INCLUDING, BUT NOT LIMITED TO, DIRECT, INDIRECT, SPECIAL OR CONSEQUENTIAL DAMAGES, ARISING OUT OF, RESULTING FROM, OR IN ANY WAY CONNECTED WITH THE PUBLICATION AND/OR CONTENTS WHETHER OR NOT BASED UPON WARRANTY, CONTRACT, TORT, OR OTHERWISE, WHETHER OR NOT INJURY WAS SUSTAINED BY PERSONS OR PROPERTY OR OTHERWISE, AND WHETHER OR NOT LOSS WAS SUSTAINED FROM, OR AROSE OUT OF THE RESULTS OF, OR USE OF, THIS PUBLICATION AND/OR ITS CONTENTS.

IF THIRD PARTY INFORMATION OR COMPUTER SOFTWARE, DATA, OR DOCUMENTATION IS REFERENCED IN THIS PUBLICATION, THE UNITED STATES GOVERNMENT DISCLAIMS ALL WARRANTIES AND LIABILITIES REGARDING SUCH INCLUDED THIRD PARTY INFORMATION OR COMPUTER SOFTWARE, DATA, OR DOCUMENTATION. ANY SUCH REFERENCES TO THIRD PARTY INFORMATION OR COMPUTER SOFTWARE, DATA, OR DOCUMENTATION IS PROVIDED “AS IS.”



 National Aeronautics and Space Administration	NASA Passive Thermal Control Engineering Guidebook	Revision: 4.0
	Date: 9/25/2023	Page 6 of 202
	Distribution Restrictions: Publicly available	Security Classification: Unclassified

TABLE OF CONTENTS

1.0	Scope and Objectives.....	14
2.0	Sources.....	14
3.0	Thermal Engineering Responsibilities.....	15
3.1	General Thermal Responsibilities.....	15
3.2	Thermal Interfaces with Other Disciplines.....	16
3.3	Design Documentation.....	17
4.0	Thermal Analysis.....	18
4.1	General Approach to Conducting Thermal Analysis.....	18
4.1.1	Modeling Process Checklist.....	20
4.1.2	Look at the Hardware.....	22
4.1.3	Modeling Legacy Hardware.....	22
4.1.4	Collaborative Modeling.....	23
4.1.5	Tool Selection.....	23
4.1.6	Units.....	25
4.1.7	Steady-State and Transient Analysis.....	26
4.1.8	What to Include.....	26
4.1.9	Materials.....	26
4.1.10	Non-Grey Analysis.....	27
4.1.11	Mesh Type.....	27
4.1.12	Mesh Density.....	27
4.1.13	Orbits.....	28
4.1.14	Spacecraft Attitude.....	35
4.1.15	Inclusion of Multiple Scenarios in a Single Model.....	37
4.1.16	Inclusion of Convection for Ground Scenarios.....	37
4.1.17	Definition of Worst-Case Conditions.....	38
4.1.18	Creating Reduced Models.....	38
4.1.19	Analysis Limits and Margins.....	39
4.2	Quick Guides for Various Types of Analysis.....	42
4.2.1	Conduction.....	42
4.2.2	Convection.....	43
4.2.3	Radiation.....	44

 National Aeronautics and Space Administration	NASA Passive Thermal Control Engineering Guidebook	Revision: 4.0
	Date: 9/25/2023	Page 7 of 202
	Distribution Restrictions: Publicly available	Security Classification: Unclassified

4.2.4	Contact	45
4.2.5	MLI	47
4.2.6	Electronics.....	48
4.2.7	Satellites	51
4.2.8	International Space Station (ISS) Payloads	51
4.2.9	Aeroheating.....	52
4.2.10	Thermal/Structural Mapping.....	55
4.2.11	STOP Analysis.....	58
4.3	Model Naming and Documentation	60
4.3.1	Overall Model Name.....	60
4.3.2	Symbols.....	60
4.3.3	Versioning.....	62
4.3.4	Analysis Logs.....	63
4.3.5	Archiving	64
4.4	Commonly Used Inputs.....	65
4.4.1	Air/Ground/Sky/Solar/Lunar Data.....	65
4.4.2	Thermo-Physical Material Properties	66
4.4.3	Optical Properties.....	66
4.4.4	Correlated Contact Conductances.....	68
4.4.5	Bolt Diameters and Wire Sizes	69
4.5	Model Correlation	69
4.5.1	General Approach	69
4.5.2	Files.....	70
4.5.3	Heater Correlation.....	71
4.5.4	TEC Correlation.....	71
4.5.5	General Correlation to Test.....	72
4.5.6	Correlation to Tests which use Lamps.....	73
4.5.7	Correlation to Flight.....	75
4.5.8	Determination of Error.....	76
4.6	Analysis Reporting and Review Process.....	79
4.6.1	Analysis Review Process	79
4.6.2	Analysis Team Responsibilities	79
4.6.3	Model Peer Review.....	80
4.6.4	Analysis Report Review	82

 National Aeronautics and Space Administration	NASA Passive Thermal Control Engineering Guidebook	Revision: 4.0
	Date: 9/25/2023	Page 8 of 202
	Distribution Restrictions: Publicly available	Security Classification: Unclassified

4.6.5	Recommended Report Formats.....	82
4.7	Tool-Specific Tips.....	83
4.7.1	Thermal Desktop™ Software Suite	83
4.7.2	Comet Solutions™ SimApps™ Authoring Workspace.....	109
4.7.3	COMSOL® Physics Simulation Software.....	110
4.7.4	BPMapper	113
4.7.5	Efficient Global Optimization (EGO) Tool	114
5.0	Thermal Hardware Selection and Integration	114
5.1	Temperature Sensors	115
5.1.1	Telemetry Definition.....	115
5.1.2	Selection.....	115
5.2	Thin-Film Heaters	116
5.2.1	Sizing	117
5.2.2	Procurement	120
5.2.3	Installation.....	120
5.3	Thermostats	122
5.3.1	Selection.....	123
5.3.2	Procurement	124
5.3.3	Installation.....	124
5.4	Thermal Interface Materials	124
5.4.1	Printed Circuit Board Assemblies and Components.....	124
5.4.2	Installation of Electronics Boxes	128
5.5	Thermal Straps	129
5.5.1	Selection/Design	129
5.5.2	Lessons Learned.....	131
5.6	Thermal Tapes.....	131
5.6.1	Selection.....	131
5.6.2	Procurement	132
5.6.3	Installation.....	132
5.7	Thermal Control Surface Treatments.....	132
5.8	Multi-Layer Insulation (MLI)	133
5.8.1	Materials	133
5.8.2	MLI Design.....	134

 National Aeronautics and Space Administration	NASA Passive Thermal Control Engineering Guidebook	Revision: 4.0
	Date: 9/25/2023	Page 9 of 202
	Distribution Restrictions: Publicly available	Security Classification: Unclassified

- 5.8.3 Procurement 135
- 5.8.4 Fit Checks 135
- 5.8.5 Inspection and Repair 136
- 5.8.6 Installation..... 137
- 5.9 Thermo-electric Coolers..... 138
 - 5.9.1 Procurement 138
 - 5.9.2 Installation..... 138
 - 5.9.3 Operation..... 138
- 5.10 Heat Sinks 138
- 5.11 Fans 139
- 5.12 Thermal Switches/Shape Memory Alloys..... 139
- 5.13 Cryocoolers 141
- 5.14 Sunshade Design 141
- 5.15 Geometry Design for Thermal Resistance 142
- 5.16 High Temperature Devices..... 145
 - 5.16.1 Furnace and Cartridge Design 145
- 5.17 Measurement and Lab Devices 145
- 6.0 Thermal Testing (Thermal Control System Verification and Validation)..... 146
 - 6.1 Thermal Vacuum Testing..... 146
 - 6.1.1 Standards..... 146
 - 6.1.2 Planning 146
 - 6.1.3 Environment Definition 152
 - 6.1.4 Test Profile..... 152
 - 6.1.5 De-Scope Options 156
 - 6.1.6 Procedure Development..... 156
 - 6.1.7 Test Setup..... 157
 - 6.1.8 Quartz Lamp Spectrum 161
 - 6.1.9 Thermal Limits and Margins for Testing..... 161
 - 6.1.10 Communication..... 163
 - 6.1.11 Test Reports 164
 - 6.2 Ambient Pressure Thermal Testing..... 165
 - 6.3 Burn-in Thermal Testing..... 165

 National Aeronautics and Space Administration	NASA Passive Thermal Control Engineering Guidebook	Revision: 4.0
	Date: 9/25/2023	Page 10 of 202
	Distribution Restrictions: Publicly available	Security Classification: Unclassified

6.3.1	Component Level Testing.....	166
6.3.2	Unit Level Testing	166
6.3.3	Other Considerations	168
6.3.4	Further Reading	168
7.0	Flight Operations	168
7.1	Thermal Limits for Flight.....	168
7.2	Data Monitoring	169
8.0	Expectations for Project Milestone Reviews	169
8.1	System Requirements Review (SRR)	170
8.2	Preliminary Design Review (PDR).....	170
8.3	Critical Design Review (CDR)	171
8.4	Pre-Environmental Review	172
8.5	System Acceptance Review / Pre-Ship Review.....	172
8.6	System Integration Review	172
8.7	Mission Operations Review	172
8.8	Flight Readiness Review/ Launch Readiness Review	173
9.0	Knowledge Sharing.....	173
10.0	Appendix A: Acronyms	175
11.0	Appendix B: Contributors.....	179
12.0	Appendix C: References	181
13.0	Appendix D: Useful Links.....	182
14.0	Appendix E: Materials Databases	184
15.0	Appendix F: Center Capabilities.....	186
16.0	Appendix G: Tools Developed In-House	186
17.0	Appendix H: Model Archives.....	189
18.0	Appendix I: Center-Specific Guidance	198
18.1	LaRC-Specific Guidance.....	198
18.2	KSC/Launch Services Program Guidance	198
18.3	KSC Engineering Guidance	201

 National Aeronautics and Space Administration	NASA Passive Thermal Control Engineering Guidebook	Revision: 4.0
	Date: 9/25/2023	Page 11 of 202
	Distribution Restrictions: Publicly available	Security Classification: Unclassified

TABLES

Table 1. Contributing Organizations.....	15
Table 2. Interfaces between Thermal and Other Disciplines.....	16
Table 3. Suggested Prefixes for Symbols and Registers.....	61
Table 4. Examples of Air Mass Properties used on Ares I-X.....	68
Table 5. Descriptions and Equations for Error Types.....	78
Table 6. Submodel Name Definition Example.....	86
Table 7. Guidance on Maximum Watt Density.....	118
Table 8. Interface Materials Used in the SAGE III IAM.....	125
Table 9. Lessons Learned on Thermal Straps.....	131
Table 10. Summary of Turn Down Devices.....	139
Table 11. Example Leadership Roles and Responsibilities.....	147
Table 12. Example Test Personnel Roles and Responsibilities.....	149
Table 13. Unit Burn-In Test Parameter Comparison (Gilmore, 2002).....	167
Table 14. Acronym List.....	175
Table 15. Contributors.....	179
Table 16. Useful Links.....	182
Table 17. Testing Links.....	183
Table 18. Tools Developed In-House.....	187
Table 19. List of Archived Models.....	189

 National Aeronautics and Space Administration	NASA Passive Thermal Control Engineering Guidebook	Revision: 4.0
	Date: 9/25/2023	Page 12 of 202
	Distribution Restrictions: Publicly available	Security Classification: Unclassified

FIGURES

Figure 1. Example heat flow map.....	19
Figure 2. Overly coarse mesh.	28
Figure 3. Anatomy of an orbit.....	30
Figure 4. The celestial inertial coordinate system.	31
Figure 5. Beta angle.	32
Figure 6. Representative beta angle vs. time profile.....	33
Figure 7. Representative fraction of orbit spent in sunlight.....	33
Figure 8. Space shuttle orbit body coordinate system.	35
Figure 9. Margin example.....	40
Figure 10. Electronics limit definitions.	41
Figure 11. Parallel conduction.	42
Figure 12. In series conduction.....	43
Figure 13. Resistance network for bolted interface.	47
Figure 14. Calculation of PCB material properties.....	50
Figure 15. STOP analysis process.	59
Figure 16. Air mass illustration.	67
Figure 17. Air mass geometry.....	67
Figure 18. Sample spectrum (from NASA-STD-3000).....	68
Figure 19. Screenshots of solar/IR fraction method for lamp analysis.....	74
Figure 20. Sample error types.....	77
Figure 21. Sample of SAGE III assemblies.	90
Figure 22. Center nodes vs. edge nodes.....	93
Figure 23. Insufficient mesh density for correct contact (yellow lines indicate contactors).	93
Figure 24. Correct (left) and incorrect (right) selection of “From” and “To” surfaces.	94
Figure 25. Use of scaling along distance.	94
Figure 26. Samples of transient planetary/solar data.	96
Figure 27. Example of issue with using registers in restart files.	103
Figure 28. Example of importance of selection of restart time.....	103

 National Aeronautics and Space Administration	NASA Passive Thermal Control Engineering Guidebook	Revision: 4.0
	Date: 9/25/2023	Page 13 of 202
	Distribution Restrictions: Publicly available	Security Classification: Unclassified

Figure 29. STOP analysis process with Comet..... 110

Figure 30. Encapsulation of COTS Camera from Imperx, Inc. (Cheetah SDI-2010 camera)..... 127

Figure 31. Encapsulation of EFILMRS Camera..... 128

Figure 32. Sample TVAC test profile for SAGE III Instrument Payload..... 155

Figure 33. Sample TVAC test profile for electronics box. 156

Figure 34. Bathtub curve (Wikipedia, 13 March 2018)..... 166

Figure 35. Sample PDR-level model (SAGE III on ISS, 1700 nodes in payload model, 4000 nodes in ISS model). 171

Figure 36. Sample CDR-level model (SAGE III on ISS, 10,000 nodes in payload model, 4000 nodes in ISS model). 172

 National Aeronautics and Space Administration	NASA Passive Thermal Control Engineering Guidebook	Revision: 4.0
	Date: 9/25/2023	Page 14 of 202
	Distribution Restrictions: Publicly available	Security Classification: Unclassified

1.0 Scope and Objectives

The NASA Passive Thermal Control Engineering Guidebook (referred to as the Guidebook for the remainder of this document) provides recommendations, including best practices and lessons learned, related to the passive thermal control engineering discipline. Topics include analysis (including documentation and review), thermal hardware (design/selection, vendors, and integration), testing, and flight operations.

The passive thermal discipline includes thermal control and thermal protection systems. The passive thermal control discipline, which is addressed in this Guidebook, is broad and covers internal and external systems, component passive thermal analysis, vehicle on-orbit attitude timeline analysis, integrated thermal analysis, various thermal control apparatus (heaters and controls, coatings, blankets and insulations, isolators, geometric design for view factors, materials emissivity/absorptivity properties), passive cooling of avionics, purge, vent, and drain for vehicle cavities and compartments, thermal model development and correlation, thermal cycle and thermal-vacuum testing. Topics related to thermal protection systems (TPS) are not within the scope of this document. However, some discussion of aeroheating is included in section 4.2.9.

The Guidebook provides a consolidated reference for early career as well as experienced engineers embarking on a new task. Leveraging the experience of the group minimizes the learning curve that exists at the start of new projects, reduces the risk of repeating mistakes, and improves the organization's ability to deliver high-quality products efficiently. In addition, the Guidebook serves to codify the group's expertise on thermal engineering topics such that the knowledge can be readily shared within NASA.

The intent of this document is to provide guidance based on collective experience, and is not intended impose constraints on project work. Best practices can vary substantially and it is important to apply judgment wisely based on careful consideration of the specific design and requirements. Implementation of the methods described will vary from project to project and should be applied in conjunction with the judgment of the thermal engineers performing and reviewing the work. The recommendations in this document are not intended to replace program, project, branch, Center, or NASA requirements and/or policies.

Several thermal analysis tools are mentioned or discussed in this document for illustrative purposes; however, it is important to note that inclusion of guidance for use of a specific tool does not imply endorsement or preference by NASA. Links to vendors' catalogs, design guides and other information are intended for reference only. No NASA endorsement, preference, fitness for a particular use, or other representation for any particular product should be implied.

The approved and released PDF will be a static document; a current copy of the Guidebook will also be maintained as a living document, which will be available for editing by all NASA Centers. At least once per year, the edits will be reviewed and approved and a new version of the document will be released.

2.0 Sources

The content is based on the knowledge and experience of members of several NASA organizations, shown in Table 1. Specific contributors are listed in Appendix B: Contributors. Given the diversity of activities from Center to Center, it is inevitable that practices will vary in some cases. Where there is not general agreement, it is noted and each Center's best practice is described so that each viewpoint may be considered by the reader. *It is ultimately the responsibility of the reader to determine the best technical approach. Information in this Guidebook is considered advisory-only.*

 National Aeronautics and Space Administration	NASA Passive Thermal Control Engineering Guidebook	Revision: 4.0
	Date: 9/25/2023	Page 15 of 202
	Distribution Restrictions: Publicly available	Security Classification: Unclassified

Table 1. Contributing Organizations

Center	Org Code	Branch/Organization Name
Langley Research Center (LaRC)	D206	Structural and Thermal Systems Branch
Johnson Space Center (JSC)	WE	NASA Engineering and Safety Center (NESC)
Ames Research Center (ARC)	RE	Mechanical Systems and Analysis
Johnson Space Center (JSC)	ES3	Thermal Design Branch
Stennis Space Center (SSC)	EA32	Mechanical Design and Analysis Branch
Marshall Space Flight Center (MSFC)	EV34	Thermal Analysis & Control Branch
Kennedy Space Center (KSC)	VA-H3 NE-XY	Launch Services – Environments & Launch Approval Exploration Division – Engineering Analysis
Glenn Research Center (GRC)	LTT	Thermal Systems and Transport Processes Branch
Goddard Space Flight Center (GSFC)	Code 545	Thermal Engineering Branch
Jet Propulsion Laboratory (JPL)	353F	Instrument and Payload Thermal Engineering
Armstrong Flight Research Center (AFRC)	Code 560	Aerostructures Branch

The information in the Guidebook was collected from a variety of sources. Much of the information was gathered from unofficial sources (emails, project reports or lessons learned, branch OneNote® digital notebook archives, branch best practices documents, etc.), although some was collected from published documents. Where information was collected from published documents, it is cited as such. In an effort to create a single consolidated reference, information from these sources has been duplicated in some cases. Citations are not provided for information collected from unofficial sources.

An extremely valuable resource for all thermal engineers is the *Spacecraft Thermal Control Handbook* (STCH) by Aerospace Corporation. In general, information from that reference is not duplicated here, so engineers may want to use that guide as an additional resource as needed. The information in the STCH is more general, whereas guidance in this document strives to be more focused to specific NASA thermal engineering tasks, with specifics on software and hardware tips.

Throughout this document, there are links to additional information available to NASA users on the NASA Agency-Wide shared thermal drive. Readers from within NASA may go through the NAMS request to obtain access. Readers from outside NASA may contact Kaitlin Liles if they wish to obtain a specific document; these requests will be approved on a case-by-case basis depending upon the document in question.

3.0 Thermal Engineering Responsibilities

3.1 General Thermal Responsibilities

The following are general overall responsibilities for thermal engineers:

 National Aeronautics and Space Administration	NASA Passive Thermal Control Engineering Guidebook	Revision: 4.0
	Date: 9/25/2023	Page 16 of 202
	Distribution Restrictions: Publicly available	Security Classification: Unclassified

- Work with the supervisor to advocate for early participation in the program lifecycle to assist in formulating an effective thermal plan and to ensure that relevant thermal products are effectively implemented in the design or planning phases.
- When assigned to a project, proactively search out schedule information, and determine if there is sufficient time to implement thermal recommendations after completion of analysis.
- Review and revise thermal requirements to satisfy the top-level project requirements. Ensure thermal considerations are properly represented in the development of Concept of Operations (CONOPS) document.
- Perform appropriate and accurate analysis, with the appropriate level of review as agreed upon with the supervisor and/or discipline lead.
- Perform a systems approach trade study for the thermal design and perform analysis to optimize cost, mass, reliability and operations.
- Document the model building and revision process in enough detail that the model can be understood if the work is transferred.
- Present product results in a meaningful format to facilitate appropriate utilization by the program.
- Ensure thermal products are appropriately used in the program design and mission formulation. Actively advocate for proper consideration of results in finalizing design/mission/test.
- Document thermal design decisions such that lessons learned can be leveraged by team members and future engineers who may be looking for examples of successful projects.
- Perform integration and testing duties as required by the project, including planning, procedure development, test execution, and reporting.
- Communicate with other thermal analysts to share knowledge and lessons learned; see details in section 9.0.

Share information in a timely manner to ensure that knowledge is not lost and each engineer gains from the knowledge of others in the group. Whenever possible, an experienced engineer should be paired with a new engineer when the new engineer is assigned to a project. This is not always possible, particularly if funding is limited or if the organization has a high workload; however, the mentoring relationship is much more beneficial if the mentor is involved with the day-to-day activities of the project along with the mentee. This arrangement often works well when the senior person has the majority of responsibility at the start of a project and is able to gradually transfer responsibilities to the junior person as he or she becomes ready.

3.2 Thermal Interfaces with Other Disciplines

The thermal engineer is somewhat unique in that the thermal discipline has interfaces with so many other disciplines. The thermal engineer must keep these in mind and establish good communication with the relevant discipline leads on a project, and ensure there is a reliable process for information sharing. An example of the disciplines that most commonly interact with thermal are shown in Table 2.

Table 2. Interfaces between Thermal and Other Disciplines

Discipline	Thermally Pertinent Information
Thermal Control Design	Thermal requirement definition, thermal isolation, thermal conductance, heat pipe sizing, insulation selection, insulation

 National Aeronautics and Space Administration	NASA Passive Thermal Control Engineering Guidebook	Revision: 4.0
	Date: 9/25/2023	Page 17 of 202
	Distribution Restrictions: Publicly available	Security Classification: Unclassified

Discipline	Thermally Pertinent Information
	configuration, instrumentation location, heater selection, thermal device selection (heaters, thermoelectric coolers, thermostats, cryocoolers, thermal switches, shape memory alloys, phase change materials), alpha/epsilon selection
Thermal Protection Design	Ablation analysis, hot structures analysis, thermal protection system sizing, material selection, thermal requirement definition, seal material selection and design
Structures	Peak and minimum temperatures, temperature fields for thermo-mechanical stress analysis, dominant modes of heat transfer, thermal gradient, stability requirements
Aerosciences	Pressures and ascent/entry heating rates.
Materials	Peak and minimum temperatures, material selection, emissivity, catalycity, environmental interactions (oxidation, thermo-oxidative stability, recession/ablation)
Power	Heater power requirements, heater duty cycles, component/subsystem power dissipation at defined voltage and load levels
Optics	Temperature fields for structural-thermal-optical (STOP) analysis, peak temperature, minimum temperatures, temperature gradients
Instrumentation	Temperature measurement type, pressure measurement, temperature measurement location, instrument ranges
Test	Thermal-vacuum test configuration, thermal test profiles, arc jet test article design, arc jet test profiles, radiant heat test article design, radiant heat test profiles
Electronics	Board and component thermal analysis, box heat rejection, chip case and junction temperature limits, board material stack-up, chip to board conductance
Systems Engineering and Integration	Heater power profiles, duty cycles, integrated thermal analysis
Mission Planning	Temperature results from attitude timeline analysis, heating to spacecraft components, orbit definitions, eclipse durations, keep out zones (for EVAs as an example)

3.3 Design Documentation

On any project, it is very important to document final design decisions, part numbers, installation procedure numbers, why certain decisions were made about integration, etc. Projects may want to define

 National Aeronautics and Space Administration	NASA Passive Thermal Control Engineering Guidebook	Revision: 4.0
	Date: 9/25/2023	Page 18 of 202
	Distribution Restrictions: Publicly available	Security Classification: Unclassified

the location and format used for design documentation. However, even if it is not defined or required by the project, it is still critical to document all thermal decisions and hardware selections. This can be done in a spreadsheet or Word® document, or a shared file area.

The best practice is to write up all design decisions as they are made. This allows the knowledge to be captured while still fresh. Formal documentation is best, e.g., a project report, but if this is not feasible due to schedule constraints then a short informal memo can be written, stored, and also emailed to the relevant parties for the record. This is immensely helpful later on when it becomes necessary to explain why decisions were made or to provide guidance to colleagues in similar situations. This practice can also help to avoid re-work or having to learn the same lesson twice. Having design decisions well-documented also makes it simple to provide justification to reviewers. Some examples from the thermal discipline are selection of thermal interface materials, design of multi-layer insulation (MLI) blankets, heater sizing, thermostat test results (set points and deadband), test profile development, and development of ground support equipment (GSE) for thermal vacuum (TVAC) testing.

Many projects have ongoing schedule constraints, such that an engineer may not feel they have the flexibility or time to properly document design decisions. Rest assured that the time taken to document the design properly will save much more time than that in the end. Committing to document thermal decisions well also serves as an example to others, such that other disciplines will ensure their design decisions are also well-documented.

It is also important to take pictures at every stage of fabrication and integration – there can never be too many pictures. Pictures can serve as a record of how parts are attached, the order of integration steps, the placement of thermal sensors, hardware condition, etc. They will allow future engineers on the project to more clearly understand the configuration. They can also be a valuable resource for the engineer performing a correlation of the thermal model. After a payload has been completely assembled, it is sometimes hard to understand the geometry of the interior that is no longer visible, and model it correctly. Having pictures at each stage of assembly makes this visualization much easier. That said, it can take considerable effort to name picture files and catalog them in a meaningful manner, but time invested here may also pay dividends later in the project timeline.

4.0 Thermal Analysis

4.1 General Approach to Conducting Thermal Analysis

Thermal analysis is an essential part of thermal design. It is often carried out in the beginning phase of a design. In the entire life cycle of a hardware development, thermal analysis occupies only a fraction of the total activities it takes to design, build, test and certify space hardware. Through analysis, the operational and non-operational environment of the hardware is determined. However, since the space environment is dynamic over a given period—which could be a day, season, or the life-time of the hardware—thermal analysis is essentially all about bounding the maximum and the minimum temperatures for the life of the hardware. During an on-orbit anomaly resolution, the focus of thermal analysis is to match given telemetric temperatures under a given orbit condition. Otherwise it normally focuses on identifying the limiting thermal conditions. Hence, thermal analysis is the basis upon which a hardware is tested and qualified for the entire mission.

In conducting thermal analysis, one must complete the required preparatory work. First, it is important to understand the conditions in which the hardware will be operational. Thermal analysis may be required for all mission phases including storage, transportation, prelaunch, ascent on-orbit operations, planetary

surface operations, entry, descent and landing, and post-landing periods. Conditions such as orbital conditions or solar beta angles must be understood. Second, the concept of operation needs to be understood clearly, which most projects painstakingly document in detail. If no concept of operation exists during the early phase of a project, reviewing the top level and the lower level requirements for each sub-system can provide insight into how the hardware must perform to meet the requirements. Along with the geometric information, all material and optical properties should be collected before developing the thermal model. Power profiles for each modeled component in all operating conditions will be necessary.

Once the environment and the operational conditions are understood, which also includes the non-operational conditions, it is beneficial for a thermal engineer to carry out hand calculations to determine the average and/or extreme temperatures of the hardware. Such calculations may not be fully accurate, primarily due to lack of precise environmental heat loading, but it can provide a first-cut temperature prediction for a detailed numerical analysis to follow. Such analysis provides a good starting point in selecting the radiator size or the surface finish which would help to move the detailed analysis in the right direction. Radiation equilibrium temperatures under hot and cold conditions can be used to bound the problem—and can sometimes be a “good enough” answer.

Early in the design phase, it is good practice to create heat flow maps as a tool to understand the energy balance of your system. A heat flow map allows the thermal engineer to quickly point out the main heat paths and understand areas that are most sensitive to changes. In addition, these heat flow maps can be used to check against detailed analysis results as a sanity check. A generic example of a heat flow map is shown in Figure 1.

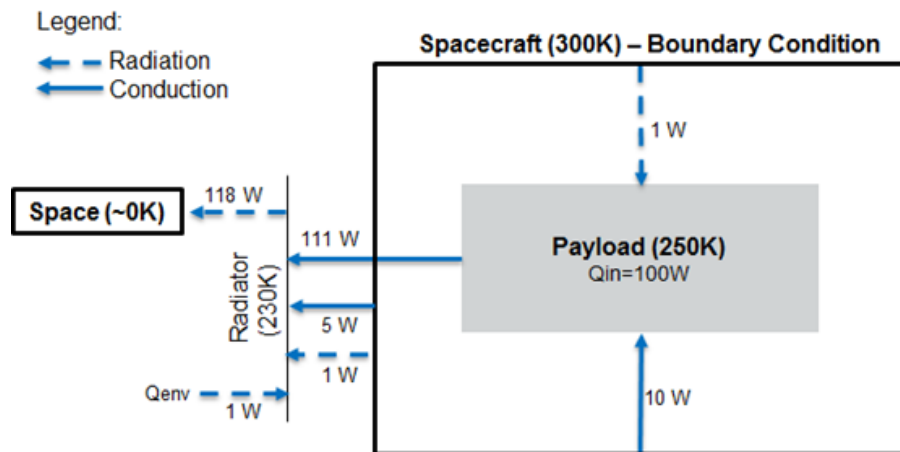



Figure 1. Example heat flow map.

References [1] through [3] were used to assist in the development of much of the information in this section. Specific references are included in some subsections as appropriate.

Readers may find the following NESC Academy short courses helpful for additional insight into general modeling practices:

 National Aeronautics and Space Administration	NASA Passive Thermal Control Engineering Guidebook	Revision: 4.0
	Date: 9/25/2023	Page 20 of 202
	Distribution Restrictions: Publicly available	Security Classification: Unclassified

- Common Thermal Modeling Mistakes – Part 1 (Ruth Amundsen), <https://mediaex-server.larc.nasa.gov/Academy/Play/e496742590e044cf803644e744c7c4441d?catalog=8b40998b-9b64-4987-a2b6-75dc6af48d1e>
- Common Thermal Modeling Mistakes – Part 2 (Ruth Amundsen), <https://mediaex-server.larc.nasa.gov/Academy/Play/3a60a62b347c4afd8f4afa64a137a5af1d?catalog=8b40998b-9b64-4987-a2b6-75dc6af48d1e>

4.1.1 Modeling Process Checklist

The list below provides a high-level overview of the analysis process. The modeling process will be different for different levels of analysis (observatory, spacecraft, instrument, component).

- Utilize previous experience
 - Review this guidebook for applicable information and best practices
 - Consult relevant resources, including the NASA Engineering Network (NEN) website (for NASA users), lessons learned database(s), and applicable standards (Appendix D: Useful Links)
 - Consult co-workers
 - Perform a literature search
- Select appropriate tools (Section 4.1.5)
- Ensure that material/component temperature limits are understood, or that reasonable assumptions have been made. Document this information when reporting results. (Section 4.1.19)
- Be sure to understand the purpose and goals of the thermal model. What question(s) will it answer? This helps guide the tool selection and level of fidelity.
- Will this model become part of a larger model? Will common logic and symbol conventions be used? Will the model(s) use share optical and material properties databases?
- Consult with other discipline stakeholders (e.g., stress engineer, avionics engineer, principal investigator, etc.) to ensure the modeling will address their needs.
- Gather information required to generate the model:
 - Obtain the geometry and ensure that it reflects the current design; consult drawings/CAD/consultation with the project team, and look at the actual hardware, if possible (Section 4.1.2).
 - What units should be used? Exercise caution when converting within a model and avoid combining unit systems if possible. Confirm consistency of units before running model. (Section 4.1.6)
 - Consult with the project team to ensure that the materials used in the model are correct.
 - Obtain material properties from reliable sources. (Section 4.4.3.1 and Appendix E: Materials Databases)
 - Confirm that data for the material properties covers the appropriate temperature range and, if applicable, pressure range, and decide whether or not temperature- or pressure-dependent properties should be used. (Section 4.1.9)
 - Consider whether isotropic or orthotropic material properties should be used. (Section 4.1.9)

 National Aeronautics and Space Administration	NASA Passive Thermal Control Engineering Guidebook	Revision: 4.0
	Date: 9/25/2023	Page 21 of 202
	Distribution Restrictions: Publicly available	Security Classification: Unclassified

- Ensure that appropriate degradation [Beginning of Life (BOL) and End-of-Life (EOL)] is taken into account for optical properties. (Section 4.4.3)
- Establish initial estimates for contact conductance/resistance for bolted or brazed joints.
- Perform initial model set up:
 - What approximations should be made for the geometric model? What types of surfaces/solids should be used? (Section 4.1.11)
 - What type of meshing will be used [Finite Element (FE), Finite Difference (FD) or a combination], and how fine does it need to be? (Section 4.1.12)
 - Ensure that reasonable approximations are made wherever there is a conductive interface. (Section 4.2.1, 4.4.4, and 4.8.1.12)
 - Set up radiation analysis groups to reflect configuration(s) being analyzed. (Section 4.7.1.21)
 - Apply heat loads to the model as appropriate (component power dissipation, heaters, aeroheating, etc.). (Section 4.7.1.18)
 - Apply orbital conditions to the model as appropriate (orbit geometry, attitude, solar flux, albedo, Earth IR). The *Spacecraft Thermal Control Handbook* [Ref. 4] is a good reference for this. (Sections 4.1.13, 4.7.1.23, and 4.7.1.24)
 - Apply convection or fluid flow to the model as appropriate. (Section 4.2.2)
 - Apply timelines to the model, as appropriate (operational timelines, variations in inputs over time, etc.). (Sections 4.7.1.24 and 4.7.1.26)
 - Set up bounding hot and cold cases. Use steady-state or transient cases as appropriate – Sections 4.1.7 and 4.1.17)
 - Consider all non-operational and operational phases, which may require multiple cases and boundary conditions.
- Confirm that initial results are reasonable:
 - Check all caution, warning, and error messages issued by the analysis program and determine the cause.
 - Did the analysis solution converge?
 - Perform basic model checks
 - Connect a heat source to one corner and look at the gradient
 - Change the environment temperature and check response
 - Change the time step and look for differences in results
 - Assess the reasonableness of the results by performing a simple hand calculation, if possible (radiation equilibrium, total heat load, flow rates—see Section 4.2).
 - Compare the results to the thermal limits and margin requirements. Are design changes likely to be necessary?
 - Investigate heat flows. At a minimum, look for a decrease in temperature along the path from sources to radiators or sinks. Computation of heat flows to sinks from radiators should also serve as a reasonableness check.
- Perform sensitivity analyses as needed:
 - Consider the reasonable range of values for parameters for which assumptions have been made (contact conductance, emissivity, etc.).

 National Aeronautics and Space Administration	NASA Passive Thermal Control Engineering Guidebook	Revision: 4.0
	Date: 9/25/2023	Page 22 of 202
	Distribution Restrictions: Publicly available	Security Classification: Unclassified

- Is probabilistic/robustness analysis necessary?
- Is a mesh sensitivity study necessary?
- Are design changes in progress? If so, can trades be performed to provide an early assessment of the impact to thermal performance?
- Consider what low-cost development/breadboard testing could be proposed to your project to address areas of uncertainty in the modeling (i.e., interface contact conductance test, etc.)
- Document initial results and provide to concurrent reviewer.
- Provide reviewed initial results to project.
- Update analysis and reporting as necessary due to:
 - Design changes and refinements.
 - Better definition of unknowns (power dissipation, interfaces, materials, etc.).
 - Changes in environments.
 - Changes in the operations concept (attitudes, timelines, etc.).
 - Additional analysis cases to cover scenarios other than bounding hot/cold (nominal, special scenarios, test configurations, contingencies, etc.).
 - Upcoming project milestone reviews.
 - Upcoming testing.

4.1.2 *Look at the Hardware*

If the hardware being modeled is already built (development or flight unit), it is essential to take the time to look at the actual hardware to make sure the model is as representative as possible. When a model is created based on documentation alone, it is easy to miss details and become complacent in the belief that what is in the model is real. Looking at the hardware may reveal basic inconsistencies in the model that would otherwise be missed.

Similarly, if a model is being created to represent a test setup, it is critical for the analyst to be involved in defining the test setup and in verifying that the setup is completed as expected. If changes are made to the test setup prior to the start of the test, it is critical for the analyst to update the model accordingly. Inconsistencies between the model and the actual test setup can lead to inaccuracies in model correlation. Some simple differences to look for are ground support equipment (GSE) that is blocking the field of view in the test setup, the condition of multi-layer insulation (MLI) blankets (which may be crushed or crumpled and thus have different effective optical properties than in the model), and the condition of surface paints and treatments.

4.1.3 *Modeling Legacy Hardware*

Using a model developed for a previous project can be difficult. Software versions will almost certainly be different from those used when the model was originally developed, and many times the tools used for the legacy project are no longer in use. In this scenario, it is likely that a new model may need to be developed using more current software. In addition to reviewing legacy documents in detail and taking a look at the actual hardware, it is highly valuable to have access to the person/people who developed the original model, if possible. If the original model is being converted to a new and/or improved tool, and if the original tool is still available, it can be valuable to run a validation case with the new tool. The validation case may need to use a coarser grid and similar assumptions to produce comparable results.

 National Aeronautics and Space Administration	NASA Passive Thermal Control Engineering Guidebook	Revision: 4.0
	Date: 9/25/2023	Page 23 of 202
	Distribution Restrictions: Publicly available	Security Classification: Unclassified

4.1.4 Collaborative Modeling

For large projects, it is common for a model to be shared among a group of analysts. Below are some tips to keep in mind when a model will be developed and used by multiple people.

- Ensure that everyone working on the model has the same software versions.
- Set up clear rules for model development including naming conventions for submodels, symbols, materials, radiation groups, analysis cases, units, and coordinate systems. Provide guidance for how comments, expressions, logic blocks are to be used. Working from a common database of material and optical properties is also critical.
- Agree upon a firm timeline for development of submodels early. This can be re-negotiated if needed, but failure to set a deadline can make it very difficult for the model integrator to bring all parts of the model together in a timely manner.
- When it is necessary to communicate about model details, either use screen sharing, collaborative meeting tools or video conferencing to look at the model during the discussions or include screenshots in email to convey details such as steps to take in correcting an error. The email/screenshot approach is particularly useful for communications with overseas partners (due to time zone differences).
- Versioning and record-keeping for model development is essential. Using a spreadsheet to capture notes, version changes, and a snapshot of results over time can work very well. (Section 4.3)
- During the design/development phase, have one analyst assigned to each subsystem if at all possible. However, consideration should be given to allowing access by a designated alternate so that work may continue in the event the primary analyst is unavailable. The number of total people on the analysis team can decrease once designs are complete and models are integrated. A good time for this transition can be following the project Critical Design Review (CDR).

4.1.5 Tool Selection

Several thermal analysis tools are mentioned in this document for illustrative purposes; however, it is important to note that inclusion of guidance for use of a specific tool does not imply endorsement or preference by NASA.

These are general guidelines for selecting what software to use for a new modeling effort. There will always be cases where a different method will be used for reasons of experience, previous history, collaboration with other entities, requirements to interface with other tools, etc. However, these are things to consider when selecting a tool at the initiation of a modeling effort. Many analyses will be a combination of two or more of these analysis types, so a combination of tools may be used. Every project will have different needs for modeling, simulation, and testing, and decisions will be unique to that project. However, the thermal engineer should ensure that when major decisions such as the selection of the simulation tool are made, the decisions are made on an objective basis that includes all necessary factors, and not solely on the analyst's knowledge or comfort level with a single tool. This ensures that the analyst considers all tools, and justifies the selection with the guidance of the concurrent reviewer.

The tool selected must have the capabilities required to perform the job. For a very simple problem amenable to hand-calculation, a spreadsheet can be used. "Don't use a sledge hammer to swat a fly" – for

 National Aeronautics and Space Administration	NASA Passive Thermal Control Engineering Guidebook	Revision: 4.0
	Date: 9/25/2023	Page 24 of 202
	Distribution Restrictions: Publicly available	Security Classification: Unclassified

example, a 16-million node Computational Fluid Dynamics (CFD) model should not be used for simple air flow in a duct. For a space mission where the orbit and solar/planetary flux will be important, the tool selected should include orbital analysis capability or be capable of ingesting pertinent orbital data for analysis. For a scenario where thermal radiation is critical, the tool selected should have robust radiative capability. For a situation where convection is important, ensure the tool selected can handle that. If thermal-specific hardware elements are present (thermoelectric coolers, heaters, MLI, cryocoolers, pumps, etc.), the tool should be able to handle those without resorting to crude approximations.

A partial lists of thermal tools with associated capabilities includes:

- C&R Thermal Desktop® suite/RadCAD® analysis software/SINDA/FLUINT™ modeling software—most spacecraft and orbital work
- Autodesk® CFD™ (computational fluid dynamics) software—fluid flow simulation
- Patran Thermal™ modeling software can be used for detailed parts but has no orbital capability
- FIAT v3 (Fully Implicit Ablation and Thermal Analysis Program) software
- COMSOL Multiphysics®—multi-physics simulation software

A simple analysis for which a closed form solution exists can always be done with a hand-calculation or spreadsheet. It is often useful to bound a more complex problem by doing a hand-calculation of a simplification of the problem. Some simple calculations are heat flow across a boundary where the temperature difference and thermal resistance are known, calculation of a radiation equilibrium temperature, and temperature difference caused by a known heat flow along a simple shape. Users inside of the NASA firewall can see examples of hand calculations on a shared drive.

If the analysis includes fluid flow, such as air flow or water flow, the tool to evaluate that should be considered. With extremely simple fluid flow in a duct, it is possible to model this without using a fluid code at all. The heat flow from one place to another can be approximated with a one-way conductor that goes from the incoming flow node to the destination. This might be from one air volume node to another, and then the convection from that air to the model surfaces would, in Thermal Desktop™, be modeled using contactors. A more accurate approach would be to include a FloCAD® fluid flow module loop in the model, so the fluid flow can be modeled directly, the transfer of heat from the fluid to the duct walls can be modeled, and convection can be represented more accurately, in a way that captures the velocity of the fluid.

If the fluid cannot be represented as being in a duct, a CFD tool could be considered for the analysis. Air flow through an electronics box can be thought of as a duct, because the fluid is fairly constrained, and its travel direction and velocity are relatively well-understood. Thus, the FloCAD® module would be appropriate for that scenario. But, if there is more open flow of air, such as outside wind hitting the outer surface of a standing structure, or a duct flow opening out into a large volume and impinging on many components, a CFD tool may be necessary. One relatively simple way to accomplish this for a thermal engineer who is already using the AutoCAD® computer-aided design (CAD) software and C&R Thermal Desktop® analytical suite would be to use the AutoDesk® CFD™ suite available through AutoDesk, Inc. There are also many other CFD tools that can be utilized, and selection would be driven by the ability to input the heat transfer coefficients back into the thermal code that is being used. This could be as simple as, for a flow impinging on several boxes, determining the heat transfer coefficient on each box side for several flow rates using a CFD package, and then coding those coefficients and their dependence on air flow velocity into the thermal model.

 National Aeronautics and Space Administration	NASA Passive Thermal Control Engineering Guidebook	Revision: 4.0
	Date: 9/25/2023	Page 25 of 202
	Distribution Restrictions: Publicly available	Security Classification: Unclassified

When developing a model, the means of geometry creation is an important decision that can impact the model's complexity and ease of use. The C&R Thermal Desktop® analytical suite provides two main methods of mesh creation, Thermal Desktop™ suite's native geometry and SpaceClaim® modeling software/CRTech TD Direct® meshing software, each with its own attributes and drawbacks. SpaceClaim® software and CRTech TD Direct® software (the link between the two) allow for complex geometry from CAD models to be meshed and imported to the Thermal Desktop™ suite, when Thermal Desktop™ native geometries are too simple to fully capture the part's thermal response. Imports into the Thermal Desktop™ suite are further discussed in Sections 4.7.1.10 and 4.7.1.11. SpaceClaim® modeling software is conveniently setup to synchronize material/optical properties, surface insulation, and submodels with the Thermal Desktop™ software model being linked; notably, this does require that the user open the SpaceClaim® software any time a change to the geometry is desired. In many cases, modeling with Thermal Desktop™ native surfaces and solids is sufficient to provide the desired results for an analysis. This approach is generally preferred as geometry creation, definition, and manipulation occurs within the same software package. As a result, the analysis setup is simpler, less time consuming, and allows the full breadth of the Thermal Desktop™ suite features to be utilized. An exterior tool such as Simcenter™ FEMAP™ Finite Element Analysis (FEA) software can be used for meshing, but the disadvantage is that the link to the native geometry is normally lost, so that if the part changes, the mesh must be re-done.

4.1.6 Units

Units should be coordinated in advance (at the start of a project) among all engineers working an analysis. It is useful to include any engineers who will be providing input to, or accepting output from, the thermal model, such as aeroheating analysts, structural analysts, electronics engineers (for definition of power dissipations and profiles), trajectory engineers, and mechanical designers. The reason is that if there will be any transfer processes in the analysis, such as aero giving results to thermal, thermal giving results to structural, design giving dimensions to thermal, etc., sometimes planning the proper units in the beginning can save a lot of time. In addition, the test or science group may have needs for the production of data in certain units that should be considered in model development and output format. See section 3.2 for the types of discipline interfaces that may be encountered.

Maintaining one consistent set of units for the life of the model/project is the best approach; however, if a change is required then it is important to document it well and verify that corrections have been made to model logic as well as simply toggling unit preferences.

At times, it may be necessary to mix SI and English units. A common example is that a project may work in English units for geometry (inches) and SI units for temperature and power (Watts). While this is not desirable, as long as the model is set up properly, it is not a show-stopper. In many cases, it is easier to create symbols that use SI values and have the model convert to the project's units (since many engineers think better in Watts than BTU/sec).

It can be very useful to create functionality which changes model units via a symbol value (for example, to run a model in either °F or °C, depending on how the symbol/flag is set); however, it is important to note that the model and results must be thoroughly checked to avoid unit conversion errors.

In particular, for interfaces with the mechanical design engineers and structural engineers, it is valuable to lock down the coordinate systems that will be used, so the need for movement of geometry after import will be minimized.

 National Aeronautics and Space Administration	NASA Passive Thermal Control Engineering Guidebook	Revision: 4.0
	Date: 9/25/2023	Page 26 of 202
	Distribution Restrictions: Publicly available	Security Classification: Unclassified

There are many on-line tools available for unit conversion. One useful application that is free and downloadable is the Convert unit conversion software (<https://joshmadison.com/convert-for-windows/>) which runs on Windows® and Linux® brand operating systems. Also, the Excel® application has a built-in CONVERT function which will do basic conversions of mass, temperature, energy, power, length, etc. Users inside of the NASA firewall can see a description and sample file in an Agency shared drive.

4.1.7 *Steady-State and Transient Analysis*

Steady-state analysis can be valuable for an initial quick-look at analysis results or to set a reasonable initial condition for transient simulations; transient analyses are normally more accurate and robust, but can take longer to set up and run. Steady-state analysis is often used to bound the thermal designs. The steady-state results represent the extreme cases for the particular thermal design. If active components are present in the model (heaters, thermoelectric coolers, pumps), then steady-state results will often be misleading. Also important to note is that heat capacity is only relevant in transient cases, so differences in results due to variations in heat capacity will not be uncovered using steady-state analysis. A pitfall of the steady state model with radiation: the heat flux is calculated at an average condition between the initial and the final temperatures, and can result in large errors. If the radiation environment doesn't change with time, the fix is to run a short transient before the steady state.

4.1.8 *What to Include*

When determining what should be included in a model versus what is unimportant, look for items that could in general make more than a 5% difference in the results, as far as (absolute) temperatures, heat flows, or heater duty cycles. This 5% value is obviously one that needs to be considered on a case-by-case basis, as some designs (such as cryogenic), may have extreme needs as far as accuracy. Also the analyst needs to ensure that percentage difference in temperatures is calculated using absolute temperature values. It is a good idea to perform sensitivity studies early in model development to identify the most important variables, and to reconsider necessary trade studies as things change in the design, environments, or model fidelity.

As an example, consider the case of modeling a launch vehicle. from the Ares I-X project, which was a tall, thin launch vehicle modeled on the Earth surface at Kennedy Space Center. Buildings 3 miles away are not included in the model because they don't appreciably affect radiation. Ground optical properties differences aren't required because the mobile platform shielded the vehicle from views of the local ground surface. The basic mass must be correct because that affects the transient behavior of the vehicle. Solar flux, Earth, and sky radiation are required because those have a big effect on both on-pad temperatures, and temperatures at the beginning of ascent

If in doubt about whether something is worthwhile to include, consider a hand-calculation to get a rough idea if it makes a difference in the results. The analyst can also run a quick what-if in the model to look at elements that make a substantial difference in the results. It is a good idea to take a big-picture approach by considering what elements in the analysis are the most powerful forces in changing the results, and make sure those are included. Sections 4.1.1 and 4.1.2 include the main categories to consider.

4.1.9 *Materials*

Some useful sources for material properties are provided in Appendix D: Useful Links. Below are some items to consider when defining material properties to use in a model:

- Use properties for the correct alloy / heat treatment

 National Aeronautics and Space Administration	NASA Passive Thermal Control Engineering Guidebook	Revision: 4.0
	Date: 9/25/2023	Page 27 of 202
	Distribution Restrictions: Publicly available	Security Classification: Unclassified

- Measure optical properties of surfaces whenever possible (As an example, aluminum emissivity values can range from 0.02 to 0.8 and solar absorptivity values can range from 0.1 to 0.9, depending on the specific treatment). Optical properties can be highly dependent upon the condition of the material (presence of scratches or other degradation)
- Consider whether to use isotropic or anisotropic material properties. This will largely depend on the type of material being used and how much that material varies in each principal direction.

4.1.10 *Non-Grey Analysis*

For surfaces at substantially different temperatures with emissivity that changes as a function of temperature, the radiative analysis should be done with a non-grey analysis. Non-grey radiation can be calculated through banded-wavelength radiation calculations, with optical properties defined as wavelength-dependent. Temperature-dependent emissivity should not be used as a substitute for a non-grey analysis. See Section 4.2.3 for additional information. Readers may find the following short course from the 2005 Thermal and Fluids Analysis Workshop (TFAWS) useful: Non-Grey and Temperature Dependent Radiation Analysis Methods (<https://tfaws.nasa.gov/TFAWS05/Website/files/Non-Grey%20Radiation%20Short%20Course.pdf>).

4.1.11 *Mesh Type*

The type of element used in a model should depend on the geometry and the level of detail needed. If a geometry consists of thin-walled aluminum (i.e., highly conductive) parts, those can normally be modeled with 2D surfaces (or shell elements in the case of finite element analysis (FEA)) since there is little gradient expected through the thickness. A thicker part, or one with a complex geometry, may necessitate a 3D solid. Even thin-walled parts, if the material is low conductivity, may necessitate a 3D solid, or a surface with separate nodes on each side to capture the gradient through the thickness. 1D element types (bars, struts, flexures, etc.) may also be appropriate for certain applications where the gradients are primarily in one direction. See also section 4.7.1.10 on recommendations for working with geometry.

4.1.12 *Mesh Density*

The mesh density should be such that all of the necessary detail is accounted for. Items to consider include the following:

- Contact between surfaces
 - In Figure 2 of a Thermal Desktop™ model, the mesh of the plate is too coarse because the place where the contactors (shown in yellow) attach to the plate does not actually represent where the box is mounted.
- Heat load application
 - Where a heat load is applied, the mesh must be fine enough that the area over which the heat is actually applied is correct.
- Expected gradients
 - In areas where a steep gradient is expected, it is important to make sure the mesh is fine enough to capture it. The required mesh density will depend on the thermal conductivity of the material; i.e. a lower conductivity material may require a finer mesh.
- Radiation view factors

 National Aeronautics and Space Administration	NASA Passive Thermal Control Engineering Guidebook	Revision: 4.0
	Date: 9/25/2023	Page 28 of 202
	Distribution Restrictions: Publicly available	Security Classification: Unclassified

- Complex shapes require a finer mesh to ensure that the radiation view factors can be properly calculated. In addition, depending on the modeling approach and tool used, radiative surfaces may need to be broken up such that a single surface does not extend into two entirely different view enclosures.

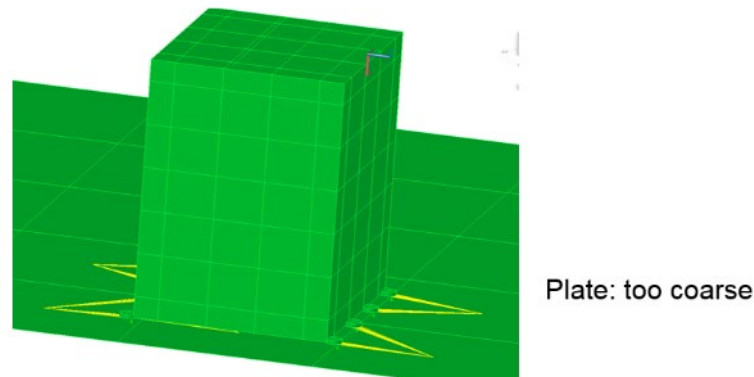

Figure 2. Overly coarse mesh.

When developing a model, it is important to always do a mesh sensitivity study to ensure that the mesh is satisfactory. As the mesh becomes finer, the results should reach a point where they no longer change with increases in mesh density. A tradeoff exists between the accuracy provided by a fine mesh and the increase in modeling run time; the appropriate compromise must be determined by the analyst based on the mesh sensitivity study.

4.1.13 *Orbits*

Orbiting spacecraft are subject to a number of environmental heating components which must be considered by the thermal engineer. For orbits about a planet or moon, spacecraft experience direct solar heating, albedo flux (i.e., solar spectrum heating reflected from the planet or moon), and outgoing longwave radiation (OLR) which arises from infrared spectrum heating radiating from a planet or moon. For heliocentric orbits (i.e., orbits about the sun) that are sufficiently far from a planet or moon, only solar flux is present. All orbits should be considered, especially for deep space missions with flybys. While a deep space mission may be cold for 95% of the time, any gravity assists may well represent cases that should be analyzed to ensure the design works over the entire mission.

While calculation of these flux components is relatively straightforward, the environment experienced by an orbiting spacecraft is determined by where the spacecraft is with respect to the heating source and how the position changes over time. To calculate this, an understanding of orbits is required.

There are many good references available to provide foundational knowledge to the reader [Refs. 4-6]. This section is not an attempt to shortcut the process gaining an in depth understanding of orbits. However, a summary of key points is provided here.

Readers may find the following NESC Academy short courses on the on-orbit thermal environment and an introduction to orbital mechanics at:

- Introduction to On-Orbit Thermal Environments, Part 1 (Steve Rickman), <https://mediaex-server.larc.nasa.gov/Academy/Play/00cba053bf4e432db8f51a870d69edeed?catalog=8e500782-c73d-4bc2-ad69-cf59aec8420c>

 National Aeronautics and Space Administration	NASA Passive Thermal Control Engineering Guidebook	Revision: 4.0
	Date: 9/25/2023	Page 29 of 202
	Distribution Restrictions: Publicly available	Security Classification: Unclassified

- Introduction to On-Orbit Thermal Environments, Part 2 (Steve Rickman), <https://mediaex-server.larc.nasa.gov/Academy/Play/db97047cadcb4c2994d59022b7c2166a1d?catalog=8e500782-c73d-4bc2-ad69-cf59aec8420c>
- Introduction to On-Orbit Thermal Environments, Part 3 (Steve Rickman), <https://mediaex-server.larc.nasa.gov/Academy/Play/ec22d75a55464d3798fb25cb1d4eab3a1d?catalog=8e500782-c73d-4bc2-ad69-cf59aec8420c>
- Introduction to On-Orbit Thermal Environments, Part 4 (Steve Rickman), <https://mediaex-server.larc.nasa.gov/Academy/Play/9f9103c01f4547e7aa425d350369cf801d?catalog=8e500782-c73d-4bc2-ad69-cf59aec8420c>
- 5 part course for Introduction to Orbital Mechanics and Spacecraft Attitudes for Thermal Engineers, starting with Part I:
<https://nescacademy.nasa.gov/video/1c1967ae7f524f62a82f456b6b9b88da1d>

4.1.13.1 Orbit Fundamentals

For a two-body system such as a planet and an orbiting spacecraft, the governing differential equation is:

$$\ddot{\vec{r}} + \frac{\mu}{r^3} \vec{r} = 0$$

where...

r is the orbit radius (measured from the center of the orbited body)

\vec{r} is the radius vector

$\ddot{\vec{r}}$ is the acceleration

μ is the product of the central body mass and the universal gravitation constant, $G = 6.6743 \times 10^{-11} \text{ Nm}^2 \text{ kg}^{-2}$

Solution of this equation can lead to both closed and open orbits that are described by the conic sections: circle, ellipse, parabola and hyperbola. The open orbits are the parabola and hyperbola and place the spacecraft on a trajectory that departs the planet after a close approach. The closed orbits are the circle and the ellipse and, as the name suggests, allow repeat passage by the central body along a closed path. For the purposes of this discussion, only closed orbits will be considered further.

Solution of the governing differential equation yields six constants of motion. Five of these parameters can be used to determine the shape of the orbit, namely:

a Semi-major axis

e Eccentricity

i Inclination

ω Argument of periapsis

Ω Right ascension of the ascending node

The sixth parameter, time-of-flight, is replaced here by an angular measure of the spacecraft location along the orbit trajectory:

 National Aeronautics and Space Administration	NASA Passive Thermal Control Engineering Guidebook	Revision: 4.0
	Date: 9/25/2023	Page 30 of 202
	Distribution Restrictions: Publicly available	Security Classification: Unclassified

ν True anomaly.

The orbit parameters are depicted in Figure 3.

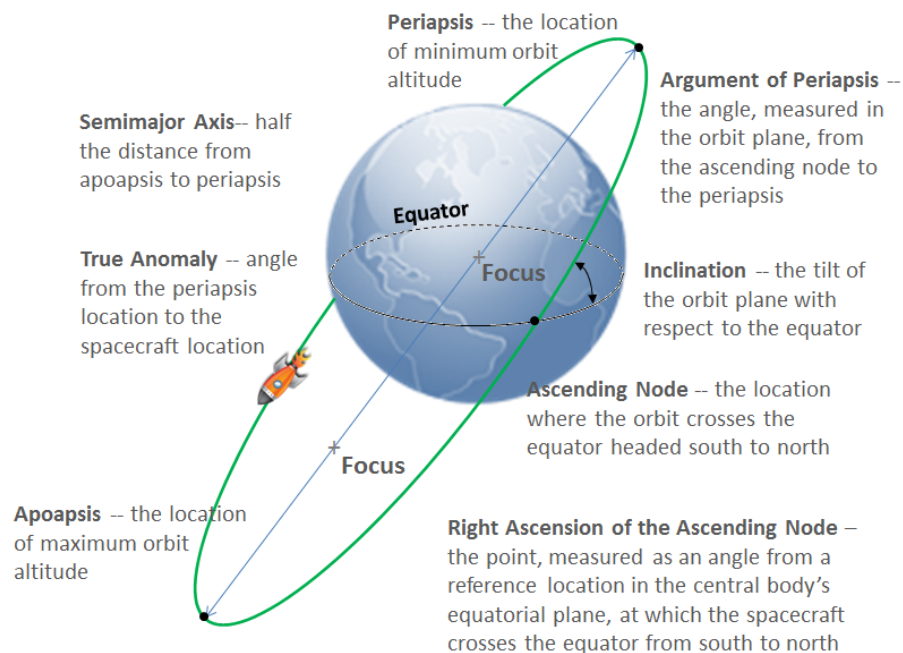

Figure 3. Anatomy of an orbit.

Figure 3 also depicts the locations of the minimum and maximum orbit altitudes above the central body. These are referred to as the periapsis and apoapsis, respectively.

The parameters discussed above may be used to describe the shape of an orbit to be considered for a spacecraft thermal analysis. Different orbit parameters result in orbits of different shapes, periods and, as we will see, progression of the orbit.

However, in order to understand the orientation of the orbit with respect to heating sources such as the sun, we must establish a coordinate system in which we can describe, both, the location of the sun and the orientation of the orbit.

For orbits about a central body such as Earth, we can establish a coordinate system with the origin at Earth's center. If we orient this coordinate system such that the x-y plane lies in the planet's (in this case Earth's) equatorial plane, the z-axis will point due north. While these constraints fix the direction of the z-axis, we see that any orientation of the x-y axis in the equatorial plane is possible. Another constraint must be established to make the coordinate system useable.

Since our analysis will require us to know the location of the sun, it will be convenient to affix our coordinate system to "inertial space." In other words, we establish our coordinate system so that it remains fixed to an assumed universe that is not moving. We can establish this by envisioning a celestial sphere whose origin is at the central body's (i.e., Earth's) center and has an equatorial plane shared with the central body (called the "celestial equator"). Similarly, the z-axis of our coordinate system extends to the celestial sphere and points to the "celestial north pole." We will call this our "celestial inertial coordinate system."

With our coordinate system established, let's now fix the x-axis to a convenient location on the celestial equator. We do this by noting that in the celestial coordinate system, the sun will complete one circuit of about the celestial sphere in one year (for Earth). And since the Earth's equator is tilted with respect to its orbit about the sun by an amount ϵ (called the obliquity of the ecliptic), we expect the path of the sun around the celestial sphere to be inclined, also by ϵ . Because of this tilt, the path of the sun about the celestial sphere intersects the celestial equator in two locations. The location at which the sun's path crosses the celestial equator going from south to north is referred to as the *vernal equinox* and, for Earth, marks the beginning of spring in the northern hemisphere. When we aim the x-axis of our celestial coordinate system toward the vernal equinox and affix its orientation, we now have a sufficiently constrained coordinate system which can be used for our analyses (see Figure 4).

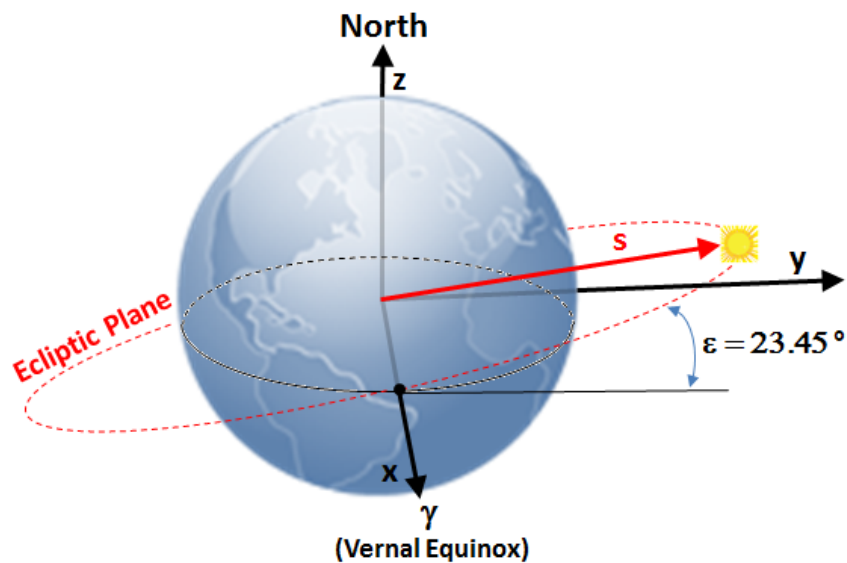



Figure 4. The celestial inertial coordinate system.

And we can now properly orient our orbit with respect to the celestial coordinate system by noting that the orbit right ascension of the ascending node, Ω is measured in the equatorial plane from the vernal equinox.

4.1.13.2 Beta Angle

A key parameter in the understanding of the on-orbit thermal environment is the beta angle, β which is defined as *the angle between the solar vector, \hat{s} and its projection onto the orbit plane*. This is depicted in Figure 5.

 National Aeronautics and Space Administration	NASA Passive Thermal Control Engineering Guidebook	Revision: 4.0
	Date: 9/25/2023	Page 32 of 202
	Distribution Restrictions: Publicly available	Security Classification: Unclassified

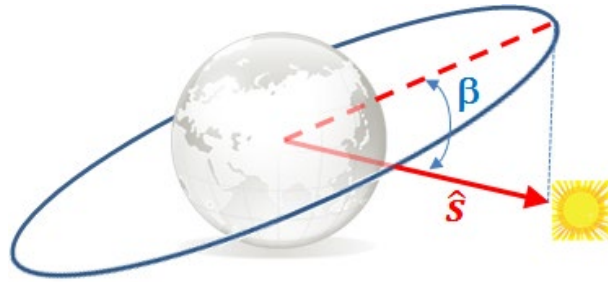

Figure 5. Beta angle.

Figure 5 depicts the beta angle at a given instant. It is important to note that beta angle varies with time due, primarily, to two effects. First, as the central body moves about the sun, the angle at which the sunlight strikes the body changes due to the tilt of the central body with respect to its path about the sun which is referred to as the obliquity of the ecliptic, ϵ . For a planet, this results in movement of the sun from the northern to southern hemisphere and back in a cycle that repeats annually.¹ Second, the orbit itself changes over time due to perturbations arising from the central body's non-spherical shape, etc. As a result, the right ascension of the ascending node, Ω moves over time. The rate of change of Ω is a function of the oblateness of the central body, the orbit semi-major axis, a and the orbit inclination. And, for central bodies with atmospheres, drag affects the spacecraft altitude which in turn increases the rate of change of Ω . These factors give rise to the change in beta angle over time. A representative² beta angle versus time profile for a spacecraft in a 408 km circular orbit is shown in Figure 6. The corresponding fraction of the orbit spent in sunlight is shown in Figure 7.

¹ The reference to “annually” here refers to the duration of the year which is different for each planet.

² Earth's motion about the sun assumed constant for this simplified example. Perturbation of Ω assumed to be due to J2 only.

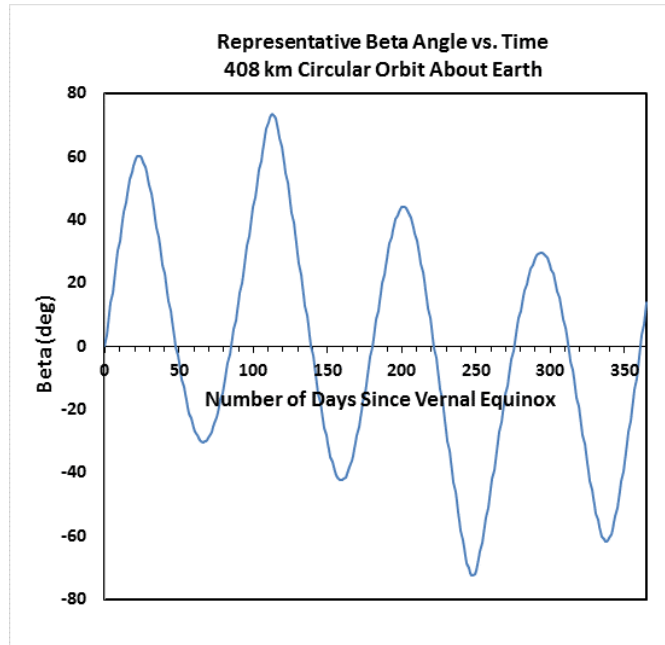

Figure 6. Representative beta angle vs. time profile.

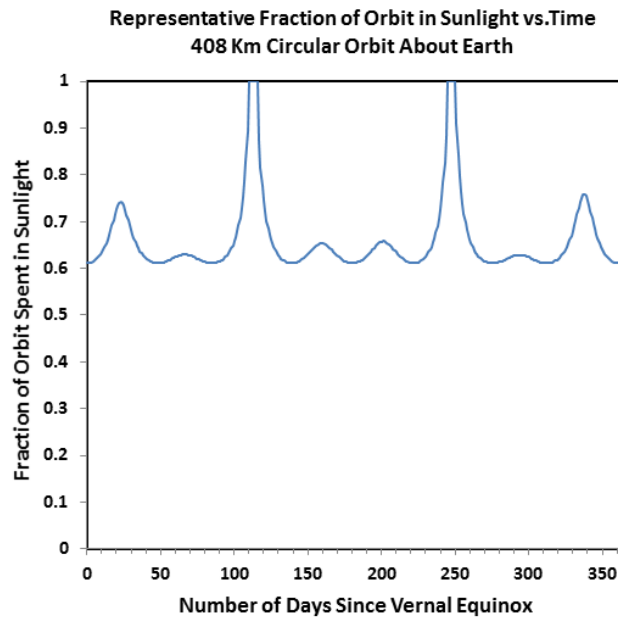



Figure 7. Representative fraction of orbit spent in sunlight.

The extent of the beta angle is limited by, both, the maximum solar declination for the central body and the inclination of the spacecraft orbit with respect the central body's equator. There are aspects of the

 National Aeronautics and Space Administration	NASA Passive Thermal Control Engineering Guidebook	Revision: 4.0
	Date: 9/25/2023	Page 34 of 202
	Distribution Restrictions: Publicly available	Security Classification: Unclassified

orbit progression that may prevent the beta angle from reaching these extremes.³ As beta angle varies, two predominant effects on the spacecraft thermal environment arise:

1. As the magnitude of the beta angle (i.e., $|\beta|$) increases, the amount of time the spacecraft spends in eclipse during each orbit decreases. Dependent on circular orbit altitude, h orbits at or above a critical beta angle experience no eclipse.
2. For a constant spacecraft attitude, varying beta angle results in a variation of thermal environment experienced on the spacecraft.⁴

As part of the design and analysis process, thermal engineers must assess the conditions that will provide the worst case cold and hot environments for the spacecraft.

4.1.13.3 Keplerian Orbit Specification

Orbit definition for elliptical orbits requires specification of the aforementioned shape parameters. However, given that thermal analysts are usually interested in the entire orbit, true anomaly, ν need not be specified unless a particular orbit location is of interest.

A Keplerian specification is complicated by the need to establish the right ascension of the ascending node, Ω as this parameter is measured in the central body's equatorial plane and varies with time. Unless Ω is specified, only general studies can be performed (i.e., analysts may analyze a variety of orbits with various Ω values assumed). The problem is further complicated by noting that both, Ω and ω will vary with time, the rate of change of both are functions of the semi-major axis, a and the orbit inclination, i .

4.1.13.4 Basic Orbit Specification

The Keplerian orbit specification described in the previous section is useful for non-circular, closed orbits where date dependent information such as the location of the location of the vernal equinox is known as such information is required when determining the orbit right ascension of the ascending node. In many instances, though, thermal engineers will need to consider more generic analysis cases. This is especially true early in the design process which typically occurs years in advance of the availability of any mission-specific orbit information.

For circular orbits, the parameter set required to describe the orbit is considerably reduced. In this case, the orbit eccentricity, $e = 0$ and the semi-major axis, a is constant and will be replaced with circular orbit altitude, h which is measured from the central body's surface. Due to the circular nature of the orbit, the argument of the periapsis, ω is undefined. Additionally, orbits are usually analyzed in their entirety so all true anomalies, ν will be studied.

Further simplification of the orbit specification is possible if orbit inclination, i , is replaced by the beta angle, β .

³As an example, consider the case of spacecraft in sun synchronous orbit about the Earth. One such orbit has a circular orbit altitude, $h = 705 \text{ km}$ and an orbit inclination, $i = 98.2^\circ$. The resulting orbit precesses at a rate that matches the average motion of the sun and limits the extent of the beta angle.

⁴ As an example, consider a north-facing plate at $\beta = 0^\circ$. At this beta angle, the plate experiences zero direct solar flux. At $\beta = +75^\circ$ for an $h = 408 \text{ km}$ orbit, the solar vector will be 15° off of normal to the plate and cone around the plate normal during the entire orbit with no eclipse period.

 National Aeronautics and Space Administration	NASA Passive Thermal Control Engineering Guidebook	Revision: 4.0
	Date: 9/25/2023	Page 35 of 202
	Distribution Restrictions: Publicly available	Security Classification: Unclassified

The complete orbit specification may be made using only circular orbit altitude, h , and beta angle, β .

4.1.14 Spacecraft Attitude

In addition to the orbit, the attitudes flown by a spacecraft must also be known if the thermal response is to be calculated. Specification of the attitude as well as the reference frame (such as local vertical local horizontal or celestial inertial) orients the spacecraft surfaces with respect to the key heating sources: solar, albedo and outgoing longwave radiation. These characteristics of reference frames will be discussed in the following subsections. However, the reader is cautioned that different programs may define the reference orientation or rotation sequences differently than those described here.

4.1.14.1 Euler Angle Sequences

Spacecraft attitudes are often expressed in terms of a sequence of rotations from some specified reference orientation. Different spacecraft programs may specify these rotations in different order but are usually specified through an Euler angle rotation sequence.

Consider the Space Shuttle Orbiter body coordinate system. As depicted in Figure 8:

“The x-axis is parallel to the orbiter structural body x-orbiter axis, and is positive toward the nose.

The z-axis is parallel to the orbiter plane of symmetry, is perpendicular to the x-axis, and is positive down with respect to the orbiter fuselage.

The y-axis completes the right-handed orthogonal system.”

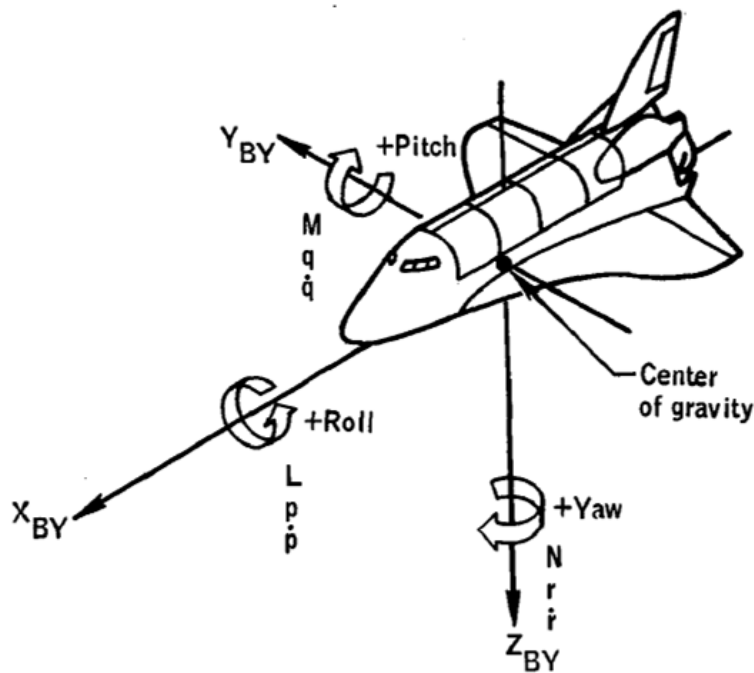



Figure 8. Space shuttle orbit body coordinate system.

In this example, the y-axis is called the pitch axis, the z-axis is the yaw axis and the x-axis is the roll axis. If an attitude is specified, the rotations must be performed in an agreed-to order where each successive

 National Aeronautics and Space Administration	NASA Passive Thermal Control Engineering Guidebook	Revision: 4.0
	Date: 9/25/2023	Page 36 of 202
	Distribution Restrictions: Publicly available	Security Classification: Unclassified

rotation is performed about the axis resulting from the previous combination of rotations. In other words, rotations are order dependent. This is called an Euler angle sequence.

The Euler sequence is easy to implement computationally and involves multiplication of a series of 3×3 matrices that describes the type and order of rotations to be performed with respect to an initial reference orientation. For example, if it is desired to orient the Space Shuttle Orbiter using a pitch, yaw and roll sequence (rotations of P, Y, and R about the y-axis, z-axis and x-axis, respectively), the rotation matrices are:

$$[P] = \begin{bmatrix} \cos P & 0 & -\sin P \\ 0 & 1 & 0 \\ \sin P & 0 & \cos P \end{bmatrix}$$

$$[Y] = \begin{bmatrix} \cos Y & -\sin Y & 0 \\ \sin Y & \cos Y & 0 \\ 0 & 0 & 1 \end{bmatrix}$$

$$[R] = \begin{bmatrix} 1 & 0 & 0 \\ 0 & \cos R & -\sin R \\ 0 & \sin R & \cos R \end{bmatrix}$$

$$[PYR] = [P][Y][R]$$

When the resulting transformation matrix is multiplied with a unit vector (or a matrix of unit vectors) describing a surface normal on the spacecraft, the resulting vector (or matrix) represents the transformed surface normal(s).

Attitude sequences are executed with respect to a reference frame. Two common reference frames to consider are the local vertical local horizontal (LVLH) and celestial inertial (CI) reference frames. They are discussed in the following sections.

4.1.14.2 Local Vertical Local Horizontal (LVLH)

A spacecraft orbiting in a constant LVLH attitude maintains the same orientation with respect to the orbited central body. In other words, an observer at the center of the central body would always see the same side of the spacecraft as it orbited above. Therefore, for a circular orbit, the view factor to the central body for each spacecraft surface remains constant. But since the spacecraft is maintaining the same orientation with respect to the central body, the apparent position of the sun as seen from the spacecraft will move throughout the orbit.

Spacecraft orientation in the LVLH reference frame begins with a reference orientation (where all rotations are zero) and the desired Euler sequence is executed as explained in the previous section. As an example, if the reference position is such that the spacecraft +z-axis is pointing toward the center of the orbited planet (i.e., it is pointing in the nadir direction) and the +x-axis is pointed in the direction of the velocity vector, a rotation about the +y-axis of +90 degrees (i.e., the +z-axis rotates *towards* the +x-axis), the resulting rotation now orients the +z-axis into the velocity vector, the +x-axis points away from the planet (i.e., toward the zenith direction), and the +y-axis remains unchanged.

 National Aeronautics and Space Administration	NASA Passive Thermal Control Engineering Guidebook	Revision: 4.0
	Date: 9/25/2023	Page 37 of 202
	Distribution Restrictions: Publicly available	Security Classification: Unclassified

4.1.14.3 Celestial Inertial (CI)

A celestial inertial (CI) coordinate system, as was depicted in Figure 3, remains inertial to the celestial sphere. If the spacecraft axes are co-aligned with the CI coordinate system axes, the spacecraft +x-axis will point toward the vernal equinox and the +z-axis will point toward the celestial north pole. In this orientation, the spacecraft orientation remains fixed with respect to the stars but its orientation with respect to the central body changes during the orbit. It is also important to note that, over time, the sun also moves within the CI coordinate system. For Earth orbits, on the first day of northern spring, the sun is located at the vernal equinox and the +x-axis will point directly at the sun. However, half a year later, at the autumnal equinox, the -x-axis will point directly at the sun.

4.1.14.4 Other Considerations

Different spacecraft may define their body axes differently and may consider different orientations to be their zero rotation reference position within a reference frame. And, as stated before, each spacecraft may specify their rotational sequences differently.

It is important to note that spacecraft geometry also affects the heating experienced by a spacecraft surface because geometric features may produce shadowing and reflections onto spacecraft surfaces. These effects are readily modeled using commercial spacecraft thermal analysis tools and is beyond the scope of this discussion.

4.1.15 *Inclusion of Multiple Scenarios in a Single Model*

Ideally, models should be set up such that all configurations (ground testing, launch pad, free-flying, berthed, installed on orbit, etc.) can be analyzed within a single model file. This is extremely valuable because it avoids duplication, re-work, and errors when translating changes from one model to another. It also allows for accurate pre-test predictions to be made, because the most current version of the model is always that used for test predictions, which provides confidence that the test target conditions can be reached and allows for an accurate time estimate to be generated. This approach also expedites correlation since thermal vacuum (TVAC) chamber models are in place prior to the start of testing. This can be accomplished using assemblies and by creating a variable which is set up to control things like payload position, power levels, and which submodels are built. Consider adding a convection submodel to simulate ground testing that will occur before TVAC, as this allows for early quick-look correlation. Details can be found in References 1 and 2. See section 4.7.1.27 for how to accomplish this in Thermal Desktop™ software. For users inside the NASA firewall, see the SAGE III webinar.

4.1.16 *Inclusion of Convection for Ground Scenarios*

Addition of a convection submodel that is only built for certain cases has proved useful for several situations, including functional testing performed at ambient conditions or to evaluate on-pad thermal response. In this scenario, the convection submodel includes air nodes and convection conductors which are activated by flags and are not built for flight cases.

Some examples of the application of this method for the SAGE III on ISS project are listed below:

- A component underwent testing in both air and in vacuum; incorporating the convection submodel allowed for correlation of all cases to occur in a single model.
- Following completion of payload integration, several functional tests were completed in a clean room environment; incorporating the convection submodel allowed for early quick-look correlation work to be completed prior to TVAC testing.

 National Aeronautics and Space Administration	NASA Passive Thermal Control Engineering Guidebook	Revision: 4.0
	Date: 9/25/2023	Page 38 of 202
	Distribution Restrictions: Publicly available	Security Classification: Unclassified

- An air convection model was used to show that a setup for electromagnetic interference (EMI) testing with the payload bagged would not result in thermal limit exceedances.

4.1.17 *Definition of Worst-Case Conditions*

A Design of Experiments (DoE) approach [see Ref. 7 and Section 4.7.5] can be very useful in defining a matrix of cases to run for determining the worst-case beta angle and attitude combination (see Sections 4.1.13.2 and 4.1.14 for descriptions of beta angle and attitude). While a more typical approach of running combinations of minimum and maximum beta angle and attitude is reasonable in some scenarios (such as free-flying spacecraft), it may not yield the true worst hot and cold cases for all payloads (such as ISS payloads that experience shading from articulating solar arrays and neighboring payloads). A full factorial approach would be effective at identifying the worst cases; however, the number of analysis runs required for this approach may be prohibitive. Using DoE, a large matrix of cases can be defined so that the entire design space can be explored while running considerably fewer cases (100s instead of 1000s).

As an example, the worst-case hot beta angle for the SAGE III on ISS payload is 41° based on flight data. Since the beta angle range is -75° to $+75^\circ$, a min/max approach would not have properly identified the worst-case scenario for this payload. Using a DoE approach, the SAGE III thermal team predicted that the worst-case hot beta angle would be 47° , which was very close to the actual worst-case beta angle [Ref. 3 & 7].

A DoE approach can also be used to define a matrix to determine worst-case combinations of other variables, including heat flux, boundary temperatures, contact conductance, and material properties.

The process of running a large set of cases can be automated in Thermal Desktop™ software using the Excel®-driven symbol function (see Section 4.7.1.27).

4.1.18 *Creating Reduced Models*

Below are some tips for creating reduced versions of detailed thermal models:

- Allow plenty of time for developing models. The amount of time required will vary depending upon the complexity of the high-fidelity model and the requirements for the reduced model; a very general rule of thumb for model reduction and associated documentation would be 1 week for an extremely simple small payload (such as a smallsat), 2 months for a fairly complex instrument, and 4 months for a large and interconnected model such as an entire spacecraft.
- When reducing a model, set goals upfront (match radiator temperatures, duty cycle, chassis, etc.) and allow plenty of time for completion. Make sure to focus on what is most important based on what the reduced model will be used for (such as whether its primary purpose is to evaluate survival or operational cases) and which components are likely to reach limits first.
- It is necessary to balance the desire to minimize the number of nodes and complexity of the reduced model with the importance of the model retaining the capability to produce accurate results.
- Maintaining open communication with the next-level integrator throughout the development of the reduced model is critical and can greatly reduce the amount of time it takes to come to agreement on what is sufficient for the final reduced model.
- Providing clear and concise documentation is critical to ensure that the next-level integrator clearly understands how the model works, particularly with respect to analyzing different mission phases.

 National Aeronautics and Space Administration	NASA Passive Thermal Control Engineering Guidebook	Revision: 4.0
	Date: 9/25/2023	Page 39 of 202
	Distribution Restrictions: Publicly available	Security Classification: Unclassified

- Following the delivery of the reduced model, it is critical to keep the reduced model in mind as further changes are made to the high-fidelity model and make updates to the reduced model when necessary. As previously stated, the key point is to keep in mind what the purpose of the reduced model is (which cases it is used for) and what model changes will have impacts on those scenarios.

4.1.19 Analysis Limits and Margins

Having a clear understanding of a system's thermal limits is essential for guiding the thermal design, using analysis to provide confidence that the system will operate and survive its flight environments, and defining test parameters. It is also essential to clearly define an approach to thermal margins (for analysis and testing) and obtain agreement from project team members and stakeholders. In some cases, margin policy is pre-defined by a requirements document; however, in many cases the thermal engineer on a project will be asked to provide input on an appropriate approach. There is no single approach that is best. The most appropriate approach depends on many things including the mission type (Earth-orbiting, deep space, etc.), project risk posture, heritage, and amount of documentation available. Many times, limits are specified by vendors or heritage documentation, but sometimes it is necessary for projects to conduct developmental testing in order to determine component/system limits. The *Spacecraft Thermal Control Handbook* [Ref. 4] provides several examples of how to approach margins and is a good resource to start with. For users inside the NASA firewall, another example is the thermal margins used at MSFC/EV34 as defined in section 5.1.2 of Organizational Work Instruction EV34-OWI-001D.

Figure 9 provides an illustration of one approach to thermal margin definition. In this example, $\pm 5^{\circ}\text{C}$ is added to the predicted temperature range for analysis uncertainty (sometimes referred to as allowable flight temperature), and an additional $\pm 10^{\circ}\text{C}$ is applied in order to determine the appropriate protoflight/qualification temperature range. Ideally, the true hardware limits would be at least $\pm 5^{\circ}\text{C}$ from the qualification temperature range; however, this is not always possible. Margin and limits for testing is discussed in Section 6.1.9.

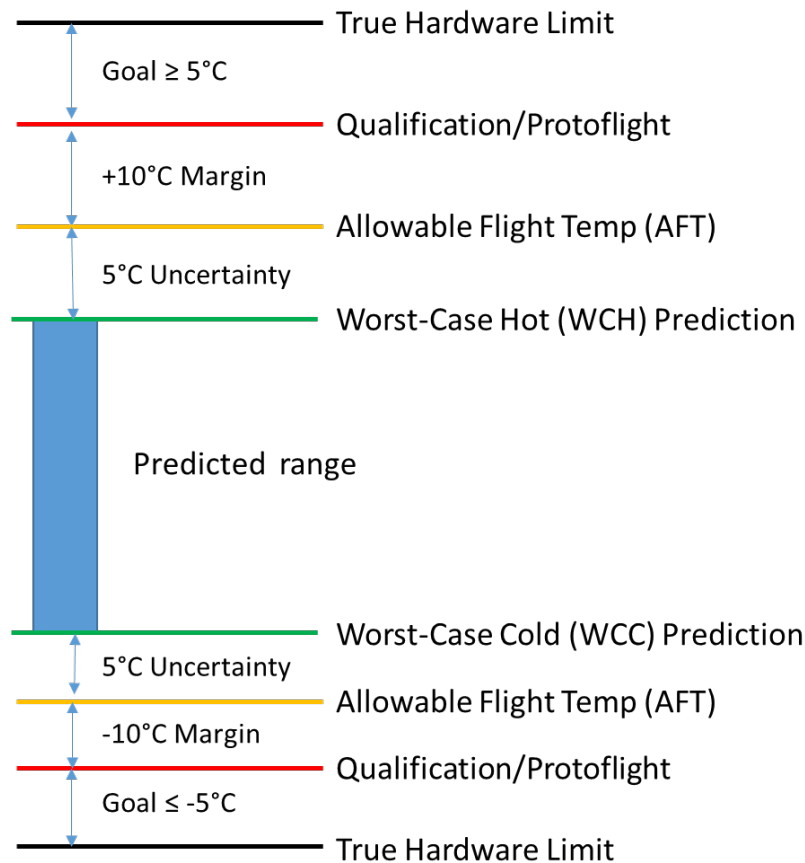

Figure 9. Margin example.

Creation of a thermal limits and margins document early in the project and putting it under project configuration management is good practice. This is a living document that is ideally created prior to Preliminary Design Review (PDR) and updated periodically as needed (at a minimum, prior to each major project review). Initially, this document should define the thermal margin approach and overall thermal limits for a system at a high-level, to provide something to compare initial analyses against and to support selection of hardware and materials that are appropriate for the expected environments. Over time, the document should develop to include limits for each component along with justifications for those limits. The process of developing this document provides a way to double-check that all selected components can survive and operate in the expected environment, and helps the project to identify any items that may need to go through additional screening or qualification testing prior to being included in the final design. Having component-level limits also provides a basis for comparison for thermal analysis results which is critical for verifying the viability of a design. Note that limit definitions may depend on the analyst's role: if an electronics box is designed and analyzed by their organization, component level limits will be needed, but if the box is designed and provided by another organization, the interface requirement provided at the box interface may be all that is available to the analyst.

Below is a guideline for what such a document should include at various stages in a flight project:

- Preliminary Design Review (PDR) or earlier: overall limits for each subsystem (operational and non-operational) and approach for defining acceptable margin between predictions and limits

- Critical Design Review (CDR): same as previous, but with component-level limits (for parts, including case or junction limits for electronics components) that can be compared with a detailed thermal model
- Pre-Environmental Review (PER): same as previous, with the addition of yellow and red alert limits to be used in testing
- System Acceptance Review (SAR): same as previous, with the addition of yellow and red alert limits to be used for flight

Different organizations within and outside of NASA may have varying definitions of thermal limits. It is important to have discussions with team members and stakeholders to ensure that everyone has the same understanding as early in the project as possible. Below are some items to keep in mind when writing a thermal limits document or having discussions with teams regarding thermal limits.

- Differentiate between operational and survival limits
- Different limits may exist for short-term and continuous use
- Operational limits can sometimes be split into two categories – one for optimal performance and another for safe operation (also called power-on or turn-on temperature)
- For electronics, it is necessary to differentiate between box/chassis limit, board limit, chip limit, and junction limit (see Figure 10)
- Make sure the limits are defined for the appropriate environment (vacuum vs. air, moist air vs. dry air, etc.)
- Sometimes limits need to be specified at a particular interface (conductive or radiative)

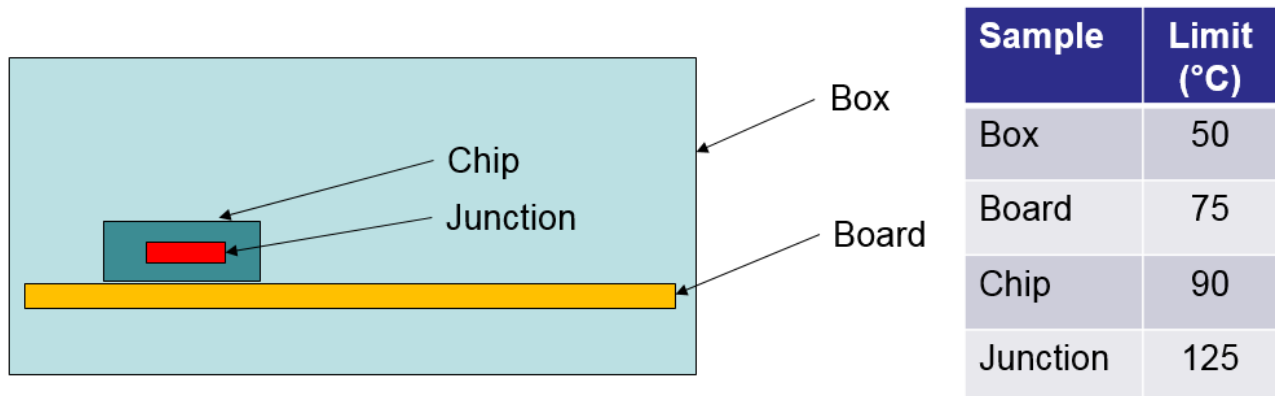



Figure 10. Electronics limit definitions.

Chassis limits for electronics boxes can be initially defined by using the thermal model to determine the chassis temperature at which the first internal component (chip or junction) temperature reaches a limit (based on component datasheet). Later in the project development cycle, it is often advisable to make limits more conservative based on as-tested temperatures (see Section 6.1.9).

When developing thermal models, it is important to ensure that the model has nodes (or measurements points) at locations consistent with where thermal limits are defined.

 National Aeronautics and Space Administration	NASA Passive Thermal Control Engineering Guidebook	Revision: 4.0
	Date: 9/25/2023	Page 42 of 202
	Distribution Restrictions: Publicly available	Security Classification: Unclassified

4.2 Quick Guides for Various Types of Analysis

4.2.1 Conduction

Conduction is the flow of heat through a solid, driven by a temperature gradient across the material. This is handled well by many thermal codes as it is the simplest form of heat transfer. If a thermal problem is being solved or verified with a hand calculation, the following discussion may be of value.

The heat flow Q in thermal conduction between two points may be calculated using Fourier's equation of heat conduction:

$$Q_{cond} = k * \frac{A}{l} * (T_1 - T_2)$$

where k is the thermal conductivity of the material, A is the cross-sectional area, l is the length between the two points, and T_1 and T_2 are the temperatures at the end points. For a constant thermal conductivity, the temperature along the intermediate material will be a linear slope between two end points of different temperatures. However, in thermal analysis, it usually best to define the thermal conductivity as a function of temperature, if the material has any variation with temperature, since the model may at some point be used over a temperature range over which that variation is important.

When two objects are connected between the end points in parallel, as in Figure 11, the thermal conduction of the two legs is added directly to determine the total conduction between the endpoints.

Thus, the equation for total conduction becomes:

$$Q_{TOT} = k_1 * \frac{A_1}{l_1} * (T_1 - T_2) + k_2 * \frac{A_2}{l_2} * (T_1 - T_2)$$

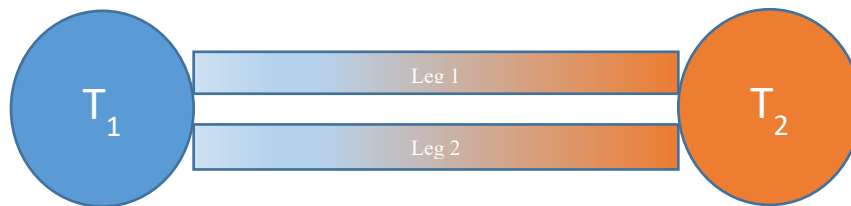



Figure 11. Parallel conduction.

When two objects are connected between the end points in series, as in Figure 12, the thermal conduction of the two legs is added as a double inverse fraction to determine the total conduction between the endpoints.

Thus, the equation for total conduction becomes:

$$Q_{TOT} = \frac{1}{\frac{1}{k_1 * A_1 / l_1} + \frac{1}{k_2 * A_2 / l_2}} * (T_1 - T_2)$$

 National Aeronautics and Space Administration	NASA Passive Thermal Control Engineering Guidebook	Revision: 4.0
	Date: 9/25/2023	Page 43 of 202
	Distribution Restrictions: Publicly available	Security Classification: Unclassified

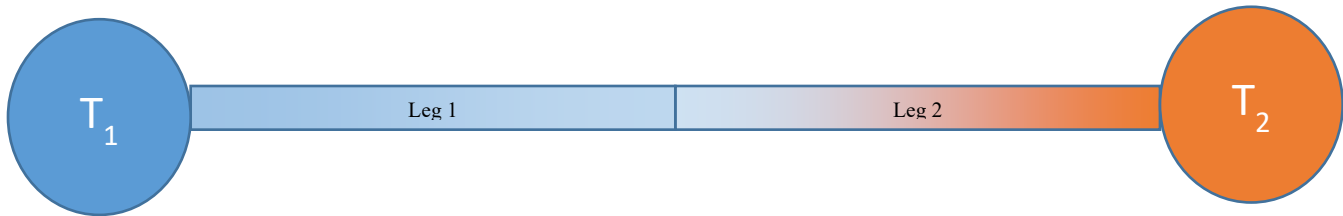

Figure 12. In series conduction.

This is the effect that allows effective insulation of an object by inserting an insulator in line with a higher contact.

The reader may find the information in the Thermal Network Modeling Handbook (<http://www.tak2000.com/data/handbookx.pdf>) useful. Thermal resistance, discussed in section 4.2.4.3, is the inverse of thermal conductance.

4.2.2 Convection

If air or another gas or liquid (i.e., any fluid) is present, convection should be considered in the thermal model. Natural convection is the process of heat transfer between a fluid and solid surface, driven only by gravity and the buoyancy of the heated fluid. Forced convection is normally much stronger and is the heat transfer between a moving fluid and a surface. These two should be treated separately. If forced convection is present, natural convection can sometimes be ignored since it is often much weaker, and also the natural buoyancy convection currents will be broken up by the forced air flow. But the analyst should assess each situation since natural convection can be stronger than forced convection for low Reynolds number flows (i.e., laminar or transitional flow) and at low pressure. Natural convection will be different on vertical and horizontal surfaces and will also vary depending on the shape and orientation of the surface. Engineering approximations exist for many regular shapes and can be used within many of the commercially available thermal analysis codes. If the software is used to calculate the convective values, it can be useful to do a rough estimation of the expected value to ensure that the software calculation is correct. On Earth, natural convection should be on the order of 5 W/m²-K in air; forced convection may be in the range 10-300 W/m²-K depending on the speed and temperature of the moving air.

If the fluid being modeled is contained within separate volumes (e.g., air within separate electronics boxes), then each one should be treated separately, with an internal fluid node for each, and convective connections from the internal surfaces to the appropriate fluid node. Fluid nodes and convection conductors should be kept separate for the convection on the inside and outside of a box.

The basic equation of convection, Newton’s Law of Cooling, is similar in form to that for conduction in that heat transfer is proportional to the temperature difference as well as the heat transfer area:

$$Q_{conv} = h_c * A * (T_1 - T_2)$$

where Q_{conv} is the heat transfer by convection per unit time, h_c is the convective heat transfer coefficient, A is the surface area for convective heat transfer, and $T_1 - T_2$ is the temperature difference between surface and fluid.

There are many good online references on convection, as well as tutorials -- a sampling is given here:

 National Aeronautics and Space Administration	NASA Passive Thermal Control Engineering Guidebook	Revision: 4.0
	Date: 9/25/2023	Page 44 of 202
	Distribution Restrictions: Publicly available	Security Classification: Unclassified

- Wikipedia on convection (https://en.wikipedia.org/wiki/Convective_heat_transfer) and heat transfer coefficient (https://en.wikipedia.org/wiki/Heat_transfer_coefficient)
- Engineering Toolbox tutorial (https://www.engineeringtoolbox.com/convective-heat-transfer-d_430.html)
- MIT tutorial (<http://web.mit.edu/16.unified/www/FALL/thermodynamics/notes/node123.html>)
- Electronics cooling estimate (<https://www.electronics-cooling.com/2001/08/simplified-formula-for-estimating-natural-convection-heat-transfer-coefficient-on-a-flat-plate/>)
- Thermal Network Modeling Handbook (<http://www.tak2000.com/data/handbookx.pdf>)

4.2.3 Radiation

Radiative heat transfer is the transfer of heat from one surface to another via only electromagnetic radiation, without contact, due to the difference in temperature between the two bodies and their external optical surface properties.

The following are some important considerations in modeling radiation:

- Transfer of heat by radiation will be proportional to the difference in the surface temperatures where each are taken to the 4th power (in absolute temperature units). So with very similar surface temperatures there will be little heat transfer through radiation, but as the temperature difference increases the heat transfer will increase in a non-linear fashion.
- Transfer of heat will also be directly proportional to how much the surfaces can see each other, or the view factor. Closed form view factor solutions exist for simple shapes (see example here <http://www.thermalradiation.net/tablecon.html>). However, most geometries are too complex to allow for a closed form solution, and thus must be solved using thermal radiation analysis software to compute view factors and the resulting radiation conductance network. Using the wrong assumed view factor is an easy way to build a huge inaccuracy into the model.
- If convection is present, it will often cause greater heat transfer than radiation, unless the surfaces are at substantially different temperatures. However, the analyst should evaluate the relative effects of convection and radiation before discarding either.
- Simplify the radiation problem as much as possible by separating volumes that are distinct (e.g. have one radiation group for the interior of an electronics box, and another for the exterior, where the exterior one will include externals of other components).
- Bound radiation transfer by making assumptions about temperatures and view factors. For example, to evaluate the potential highest temperature that a surface could be at in a high heating condition, assume it is in “radiation equilibrium”, which means that the surface reaches a steady state temperature where the energy radiated is equal to the energy absorbed. Radiation heat transfer is calculated using the Stefan-Boltzmann equation:

$$Q_{rad} = A * \sigma * \epsilon * (T_1^4 - T_2^4)$$

where Q_{rad} is heat transfer via radiation per unit time, A is area, σ is Stefan-Boltzmann constant, ϵ is surface emissivity, T_1 is the surface temperature and T_2 is the temperature it is radiating to (with temperature in absolute units).

 National Aeronautics and Space Administration	NASA Passive Thermal Control Engineering Guidebook	Revision: 4.0
	Date: 9/25/2023	Page 45 of 202
	Distribution Restrictions: Publicly available	Security Classification: Unclassified

Rearranging and solving for T_1 yields:

$$T_1 = \left(\frac{Q_{rad}}{A * \sigma * \epsilon} + T_2^4 \right)^{0.25}$$

- Most of the time, optical properties of a surface can be represented using just the absorptivity/emissivity in the solar and IR wavebands (plus any specularly or transmissivity in each). Note that optical properties can vary with temperature (e.g., such as the James Webb Space Telescope radiation shields, where the same materials may be at 20K, 150K and 300K). In that case, surfaces can no longer be assumed to be “grey bodies”, i.e. have no change in their emissivity with temperature. In that case, the radiation analysis should be done using non-grey methods (see Section 4.1.10).

Readers within the NASA Agency may find the following short course useful for gaining a better understanding of radiation:

- Aero Radiation Heat Transfer Short Course (Eugene K. Ungar, 5/3/91)

These short courses are also available.

- Form Factors, Grey Bodies and Radiation Conductances, Part 1 (Steve Rickman), <https://mediaex-server.larc.nasa.gov/Academy/Play/a554b20088f04569a7fa1c98247b65291d?catalog=8b40998b-9b64-4987-a2b6-75dc6af48d1e>
- Form Factors, Grey Bodies and Radiation Conductances, Part 2 (Steve Rickman), <https://mediaex-server.larc.nasa.gov/Academy/Play/c6c25c1ea2764e77b50a240ada49161a1d?catalog=8b40998b-9b64-4987-a2b6-75dc6af48d1e>
- Form Factors, Grey Bodies and Radiation Conductances, Part 3 (Steve Rickman), <https://mediaex-server.larc.nasa.gov/Academy/Play/f6c13f91a32644c4b4a46c6bcdffd96f1d?catalog=8b40998b-9b64-4987-a2b6-75dc6af48d1e>
- Form Factors, Grey Bodies and Radiation Conductances, Part 4 (Steve Rickman), <https://mediaex-server.larc.nasa.gov/Academy/Play/f8517c2d375d4fb6a6ebe3d126a442271d?catalog=8b40998b-9b64-4987-a2b6-75dc6af48d1e>

4.2.4 Contact

4.2.4.1 Contact Conductance

Contact conductance is the mechanism to transfer heat across an interface of contacting surfaces. The contact conductance is dependent on many different variables: surface material, surface roughness, surface flatness, machining method, ambient gas pressure, contact pressure in joint, interface materials (if present) such as thermal grease, etc. In some situations, it can be more effective to simply bound the possible values of contact to evaluate whether it makes a difference in the model. Contact values can vary at least over the range of 10 to 5000 W/m²K, with a fairly nominal value for metal-to-metal contact being about 250 W/m²K.

When modeling contact, it is important to use only the area that is in contact – in other words, if there is a smaller area in contact with a larger surface, the contact is determined by multiplying the area contact conductance by the area of the smaller surface, if all of that area is in contact.

 National Aeronautics and Space Administration	NASA Passive Thermal Control Engineering Guidebook	Revision: 4.0
	Date: 9/25/2023	Page 46 of 202
	Distribution Restrictions: Publicly available	Security Classification: Unclassified

There are several references to look at for contact conductance values. Very good data is available in the Genium Publishing *Data Books on Heat Transfer and Fluid Flow*, for many materials at many different contact pressures. The *Spacecraft Thermal Control Handbook* [Ref 4] also has a good deal of information on the mechanisms and data on material combinations. When selecting data from a reference, it is important to ensure that the data represents a similar contact geometry and condition as the one being modeled, in all these areas but in particular contact pressure and level of ambient air pressure/vacuum:

- Material types
- Surface roughness
- Contact pressure
- Air pressure/vacuum
- Gap filler/grease

4.2.4.2 Bolted Interfaces

When modeling a bolted interface, it is important to understand that the contact pressure will vary across the surface, being the highest at the locations closest to the fastening bolts. Thus, the thermal contact conductance will also vary across the surface, normally being highest near the bolts. Normally, an average contact is defined for a bolted interface, that is then applied in the thermal model across the entire surface that is in contact. It is important not to apply the thermal conductance that applies only to an area near the bolts, across the entire surface. The average contact for a bolted interface will vary with the contact pressure, and also with the number or density (i.e. number of bolts per unit area) of bolts applying pressure to the joint. Thus, the value for a bolted joint with six bolts over a 1 ft² plate should not be used for a bolted joint with six bolts of a 4 in² plate. The two references above, the Genium books and *Spacecraft Thermal Control Handbook* [Ref 4] both have valuable data on bolted joints.

4.2.4.3 Resistance Networks

Often, when modeling the conductance from one object to another, it is preferable to use a calculated conductance value rather than to model the geometry of items such as fasteners, pins of electronics components, or interface materials. The calculated conductance value can then be applied to the interface in the thermal model as described in Section 4.8.1.12 (for Thermal Desktop™ software). Thermal resistance, which is the inverse of thermal conductance, is defined as:

$$R = \frac{L}{k * A}$$

Total thermal conductance, the inverse of the total resistance of a configuration of parts, is:

$$G_{total} = \frac{1}{R_{total}}$$

Where L is the distance over which heat is being conducted (length of the bolt, thickness of the interface material, etc.), k is the thermal conductivity of the material, and A is the contact area. As with electrical resistance, thermal resistances in series are added to determine total resistance and thermal resistances in parallel are added as the inverse of the sum of the inverses, as follows:

$$R_{total,series} = R_1 + R_2 + R_n$$

$$R_{total,parallel} = \frac{1}{\frac{1}{R_1} + \frac{1}{R_2} + \frac{1}{R_n}}$$

When calculating a total thermal resistance, it is often necessary to include the effects of contact conductance (Section 4.2.4.1). To determine the thermal resistance due to contact at an interface, use the inverse of the areal contact conductance value (G_{flx}) multiplied by the area:

$$R_{contact} = \frac{1}{G_{flx} * A}$$

An example of a resistance network for a bolted interface with washers and a thermal standoff is provided in Figure 13.

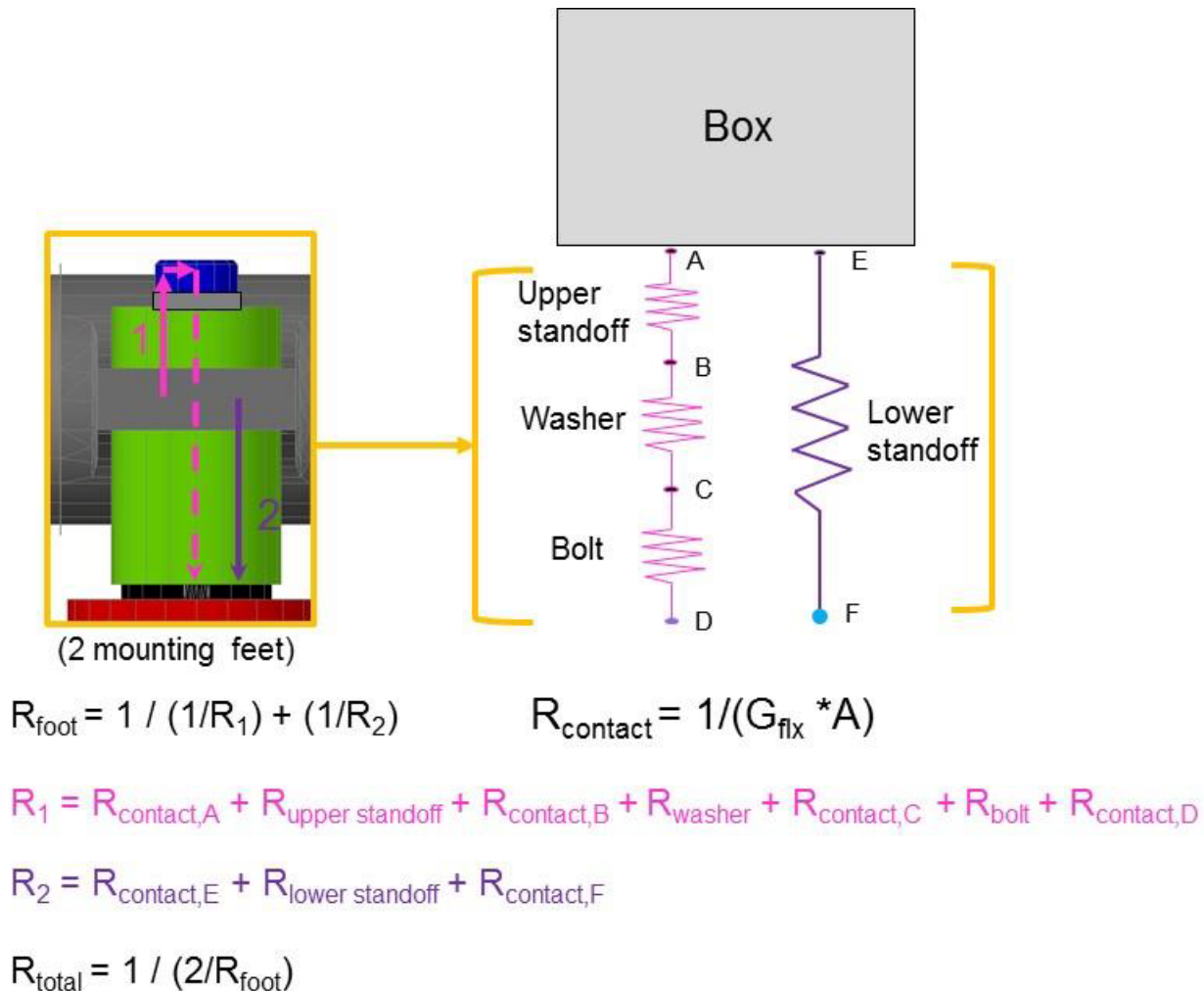



Figure 13. Resistance network for bolted interface.

4.2.5 MLI

Multi-Layer Insulation (MLI) blankets allow good insulation in a vacuum environment by blocking the radiative heat transfer. Note, in an environment where gas such as air is present, MLI blankets are much

 National Aeronautics and Space Administration	NASA Passive Thermal Control Engineering Guidebook	Revision: 4.0
	Date: 9/25/2023	Page 48 of 202
	Distribution Restrictions: Publicly available	Security Classification: Unclassified

less effective since they block some but not all of the convective and gaseous conduction transfer; in this case, the radiative element is normally less important. Because blankets are designed to minimize the physical contact between the two sides, blankets are normally modeled as radiative transfer only. The ϵ^* (ϵ -star) of a blanket is the effective emittance between the base surface that the blanket is mounted to, and the top or outer surface of the blanket. Normal ϵ^* values are in the range 0.005 for extremely effective blankets to 0.05 or 0.1 for smaller blankets or those with fewer layers or more penetrations. Some common values used in a thermal model are 0.01 for the best-case blanket and 0.05 for the worst-case blanket; however, this should be evaluated on a case-by-case basis, depending on factors such as the blanket size, number of layers, number of penetrations, materials, temperature range, and level of vacuum.

For blankets at cryogenic temperatures, the contacts and residual gas effects lead to enough direct thermal transfer, that blankets may be modeled as a combination of thermal conduction and radiation. In particular, some organizations (commonly those in Europe) may choose to model all blankets with a combination of thermal conduction and radiation. Depending on the blanket spacing and pressure, residual gas effects may be manifested as continuum conduction or transitional/free molecular heat transfer as quantified by the Knudsen number. At cryogenic temperatures, heat transfer via non-radiative effects (i.e., incidental contact and residual gas) may be significant compared to radiation due to the low emissive power at those temperatures.

In most of the thermal analysis codes that have MLI as an option, the blanket should be defined with a thickness of 0 if it is desired to treat the blankets as radiation-only. In Thermal Desktop™ software, if the MLI has a positive thickness and conductivity, then a linear conductor will be created in addition to the radiative conductor. Also, a thickness and density can be defined for the MLI, to allow mass calculations, without creating a linear conductor.

It is important in the model to verify that the outer optical properties used in the radiative case are those of the external surface, whether that is a blanket or a bare surface. A visual check should be made in the model to ensure that MLI is placed on the correct surfaces, and on the correct sides. Do not model radiation between the inner surface of the blanket and the underlying surface – that is normally captured in the ϵ^* value of the blanket.

An exception to this method of modeling is if a single MLI blanket extends over separate surfaces that are at substantially different temperatures. In that case, use of a “check box” to simply apply MLI to one side of those surfaces will not lead to a good representation of the situation. The reason is that in the physical scenario, there will be radiation from the underlying hot surface that bounces off the inner surface of the MLI (normally highly reflective) and hits the cold underlying surface. Applying MLI separately to each of those surfaces will eliminate that radiative effect from the model. In this case, the MLI should be modeled as a separate physical surface, with both sides active, to allow the internal radiation to occur in the model.

4.2.6 *Electronics*

When creating a board-level model of an electronics box, it is not typically necessary to model all components. Things to consider when determining which components should be modeled include:

- Power dissipation
- The junction to case thermal resistance (θ_{JC}). This is specified by the manufacturer and represents the thermal resistance from the electronic elements inside the chip to the case.

 National Aeronautics and Space Administration	NASA Passive Thermal Control Engineering Guidebook	Revision: 4.0
	Date: 9/25/2023	Page 49 of 202
	Distribution Restrictions: Publicly available	Security Classification: Unclassified

- The case to board thermal resistance (θ_{CB}), which represents the thermal resistance of the component to the board. This may be specified by the manufacturer; however it is highly dependent on how the chip is mounted, and the published value may not match the design:
 - Conduction may be through pins/leads only, or there may be an interface material present such as a pad or epoxy (the presence of interface materials is often driven by early thermal analysis, see Section 5.4 for more information on interface materials)
 - Conductance is typically calculated using a resistance network (Section 4.2.4.3)
- Materials of the component's case, including coatings (impacts the amount of heat that can be dissipated via radiation)
- Size of the component (impacts the amount of heat that can be dissipated via radiation and via convection if air flow is present)
- Component design. Some parts are designed with heat sinks (usually placed on the part; can be on the side facing the board or on the other side) that should be accounted for in the thermal design.

Even if all components are not explicitly modeled, it is important to account for the total power dissipation of the board. The power dissipation that is not accounted for in the modeled components is typically spread evenly across the rest of the board for the purposes of the thermal analysis.

Work with the electronics designers early to get temperature sensors installed on as many of the modeled components as possible, even if these are test-only sensors that will not be measured in flight. Having component temperature measurements is critical for a good model correlation, and it can be difficult to add such measurements after the final design is complete.

If at all possible, use measured power values in the model. This is not often possible until later in the development process, so it is typical for conservative power estimates to be used for initial analyses. If power is being calculated using $I \cdot V$ (current * voltage), it is important to make sure the current and voltage are the values actually reaching the part. In other words, the full bus voltage may not necessarily reach the part in question, if, for example, the part is controlled via voltage level. If there is any motion, transmission, or mechanical action (such as motors and actuators), it is important to determine how much of the input power load is actually lost to heat dissipation. It is best to consult with the project's electrical engineers when determining power dissipations to use in the thermal model. For detailed transient modeling, it may be necessary to use a transient power dissipation timeline, if any components have large changes in their power dissipation while operating. For a power distribution or voltage converter unit, the power in the model can be set as proportional to the total power within the components supplied by the unit, as will actually be the case in the hardware.

Electronics boards (printed circuit boards, or PCBs) are typically made up of a combination of polyimide and copper. Board designers include copper planes to assist with heat transfer. To model the board material properties, one can either build the actual stack-up in the model using individual surfaces, or a single surface can be used that has aggregate material properties based on the mass fractions of polyimide and copper. Figure 14 provides a description of the latter approach.

A critical factor in determining the thermal behavior of an electronics board is the mechanical connection to the housing or case. Normally, boards are mounted via card guides (wedgelocks), and these usually have thermal conductance per unit length specified. If the card guide being used in the design does not have a specification, the thermal conductance for a similar card guide type can be used. If the electronics box will be used in a vacuum, radiation within the box is normally included in the model, as a separate

radiation group. If air is present, the convection or conduction within the box should be included; normally the air node within the box is considered as isolated from the outside air as there will not be effective air transfer in and out of the box unless there is a defined vent path and fan. Note that if there is air within a box at zero-gravity (i.e., in orbit), convection will not be present unless air motion is forced with a fan, so if there is no forced air motion, only gas conduction should be considered. When modeling the boards, any conformal coating on the boards should be included.

In a high-level model, an entire electronics box is sometimes modeled as a single node, where the temperature of that node will represent the case temperature of the box, and there will be no predictions at the component or board level. This approach would only be used if the box has already been tested and there is confidence that the components will not overheat when the case is within acceptable thermal limits. In this method, the entire mass of the electronics box, including boards and components, is assigned to the box, as is the total power dissipation. A single-node representation may not always be suitable; for example, the box may be designed to have heat dissipation from one side to allow effective cold-plate; in that case, the box model may necessitate more than that single node.

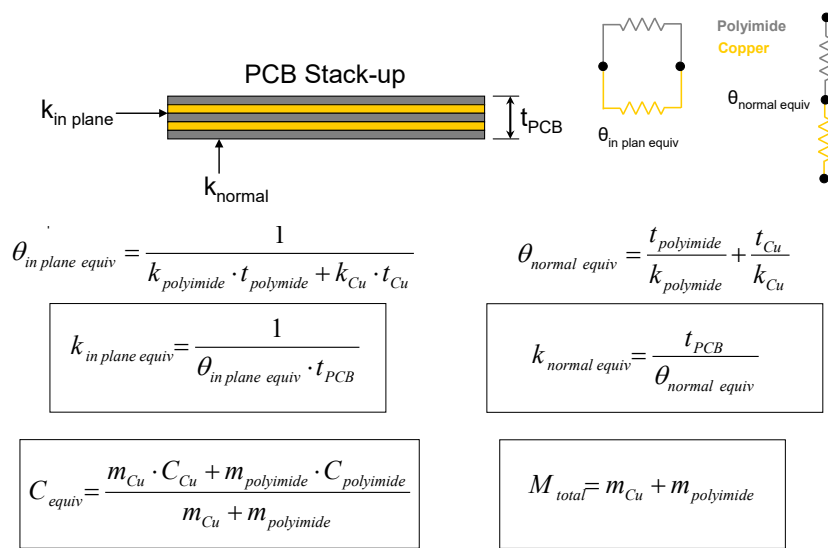

Note that thermal conductivity calculations are independent of board length and width

- $t_{polyimide}$ = total polyimide thickness in the normal direction
- t_{Cu} = total copper thickness in the normal direction
- m_{Cu} = total copper mass
- $m_{polyimide}$ = total polyimide mass
- M_{total} = total board mass
- C_{equiv} = equivalent board heat capacity

Figure 14. Calculation of PCB material properties.

4.2.6.1 Cable/Wire Bundle Analysis

Normally, wire bundles are sized by the electronics or cabling designer using standards that allow derating of the bundle to a maximum specified current per wire.

There is some current exploratory work on explicitly including the effects of self-heating within the cable bundle, as described in this NESCA Academy short course:

 National Aeronautics and Space Administration	NASA Passive Thermal Control Engineering Guidebook	Revision: 4.0
	Date: 9/25/2023	Page 51 of 202
	Distribution Restrictions: Publicly available	Security Classification: Unclassified

- Wire and Wire Bundle Thermal Analysis (Steve Rickman), <https://mediaex-server.larc.nasa.gov/Academy/Play/55a18994638a4b0696ab350526efadb81d?catalog=8b40998b-9b64-4987-a2b6-75dc6af48d1e>

Cables are often not modeled explicitly in a payload or instrument thermal model, but they should be included if they have a significant effect in terms of either blocking radiation, or thermal connection between items that are at different temperatures.

4.2.7 Satellites

For a payload that will be mounted on a satellite, the items to consider are the range of possible orbits, and the sides of the spacecraft that can be used for radiating heat. The *Spacecraft Thermal Control Handbook* [Ref. 4] is an excellent reference to get started and understand some of the issues in flying on a satellite. The primary consideration is normally the ability to radiate enough heat to keep the payload within the required temperature range and protecting it from direct solar exposure that could overheat it, as well as constant unblocked deep space exposure that could cool it excessively.

One of the first things to do is determine the worst-case beta angles and orbit altitudes that will occur during the lifetime of the payload. These can be used to set up the worst case hot and cold cases, in conjunction with the hot and cold case planet and solar parameters (see Appendix C: References for relevant papers). From those, if the payload has the choice of what side(s) of the spacecraft to use, the selection of the best side can be made by doing a simple run of the spacecraft in the worst case orbits and looking at deep space view factor and solar/planetary flux. The effect of articulating solar arrays should be considered. Then, the needs of the payload should be considered: e.g., if there is a passive radiator present, that will need an unobstructed deep space view.

The ability of the spacecraft to provide survival heaters should be considered, as well as the fact that the variation in voltage from the spacecraft may lead to worst cases for high and low voltage for survival heater power. Transfer of heat around the spacecraft may be necessary, using heat pipes or structure. Note that the use of heat pipes may introduce ground testing constraints due to gravity. The spacecraft may have requirements on heat transfer from the payloads, or optical surface specularity, which will need to be followed.

4.2.8 International Space Station (ISS) Payloads

Specific lessons learned and tips for thermal engineers working on an ISS payload can be found in Reference [3]. Below are a few key points:

- Communication
 - Communicate with the ISS Passive Thermal Control Systems (PTCS) team early and often
 - Communication is critical for analysis case definition, model exchange (definition of what is important for reduced models and how to use the reduced ISS/Dragon® system models), approach for analysis of transfer scenarios, and general roles and responsibilities of the ISS PTCS and payload teams
- Availability of temperature telemetry
 - In the Dragon® spacecraft system unpressurized trunk, payload temperature telemetry is not available. Telemetry from the Dragon trunk sensors is available but it is minimal. During transfer from Dragon® system to final location on ISS, no temperature telemetry is available.

 National Aeronautics and Space Administration	NASA Passive Thermal Control Engineering Guidebook	Revision: 4.0
	Date: 9/25/2023	Page 52 of 202
	Distribution Restrictions: Publicly available	Security Classification: Unclassified

- It is critical to develop a thermal model that accurately predicts cool-down / time-to-limit
 - Potential for model correlation to these scenarios is very limited
 - While mounted on the ISS, only a few of the payload’s telemetry channels are available through the ISS data stream when the payload is in survival mode or unpowered.
 - Consider where these sensors will be placed, keeping in mind which systems turn on first and which are expected to reach limits first
- Analysis cases
 - Analysis is required for many configurations, including Dragon® spacecraft system free-flying, Dragon® system berthed, transfer, survival on ISS, and operation on ISS
 - Dragon® system cases are defined by SpaceX® launch services and communicated via ISS PTCS; be prepared for the possibility of last-minute contingency scenarios that require quick-turnaround analysis
 - Parameters for transfer cases are defined by ISS PTCS and worked with the payload developer in the months leading up to launch
 - Requirements (beta angle, attitude, and environments) are defined by ISS PTCS for survival and operation on ISS
 - Work with PTCS to ensure a common understanding of the approach
 - Definition of worst-case combination of variables can be complex (see Section 4.1.17)

4.2.9 Aeroheating

Performing a thermal analysis that includes aeroheating loads is a complex process, and very sensitive to the “garbage-in, garbage-out” rule. It is important to fully understand the inputs and process of applying aeroheating in order to make sure the results are accurate. This section will give a quick summary of aspects to consider, but fuller treatments of the issue can be found in other references, such as those on the shared drive for users inside the NASA firewall, and John Anderson’s text *Hypersonic and High Temperature Gas Dynamics*.

The most important issue in doing aeroheating analysis is to understand the aeroheating loads. Aeroheating loads in a given case will vary based on some or all of the following:

- Distance over the surface geometry
- Elapsed time in an entry or ascent trajectory
- Surface temperature
- Material surface properties such as catalyticity and emissivity
- Air or fluid properties and equilibrium versus non-equilibrium chemistry
- Surface state: char, pyrolysis
- Turbulent versus laminar flow assumptions
- Shock wave impingement and shock-on-shock interactions (which may move with time)
- Shock layer radiation (which can be significant in very high-speed atmospheric entries)

 National Aeronautics and Space Administration	NASA Passive Thermal Control Engineering Guidebook	Revision: 4.0
	Date: 9/25/2023	Page 53 of 202
	Distribution Restrictions: Publicly available	Security Classification: Unclassified

Questions to ask of provided aeroheating loads include:

- Are the loads cold-wall or hot-wall? In other words, does the aeroheating assume the surface is at the actual predicted temperature, or does it assume that the entire surface is at some constant and relatively cold temperature such as 300K?
 - Note that if the load is applied as a convective condition, no assumption need be made regarding surface temperature
- Is radiation included, or are the loads convection-only? In some cases, radiation may provide the dominant heat load, and may need to be added into the model as a separate heat load to be accounted for correctly.
- In almost all cases of aerothermal heating of a vehicle, the heated surface will also be re-radiating to a colder environment. It is critical that this boundary condition be applied appropriately. Re-radiation often accounts for the largest portion of the surface energy balance.
- What assumptions were made regarding turbulence, and do these loads envelope the worst-case, or do multiple possible scenarios need to be run to bound the problem?
- Are the loads enthalpy-based or temperature-based? This will determine how they would be implemented in the model (using temperature or enthalpy to interpolate).

Temperature-based heating will have this form, and the transfer coefficient will have units like W/m^2-K :

$$q = h_c * (T_{fluid} - T_{surface})$$

Enthalpy-based heating will have this form, and the transfer coefficient will have units like kg/m^2-s :

$$q = h * (H_{recovery} - H_{wall})$$

The analyst must take into consideration that T_{fluid} and $H_{recovery}$ may vary in time and around the surface or vehicle.

- What units are the heat loads provided in? The analyst should never assume how the units in the heating conditions are defined but instead should always get documentation. Some conversion factors between typical units for heat flux are close to 1. For instance, the conversion factor from W/cm^2 to Btu/ft^2-s is about 0.88. So the magnitude of a heat flux value in one units system may seem like a reasonable value in another system, in the absence of defined units, but an incorrect assumption about units would still lead to an invalid analysis.
- Can accurate interpolation be done in orthogonal axes, or do the loads change abruptly enough in some other direction (such as the direction normal to a highly swept leading edge) that non-orthogonal interpolation (i.e., interpolation not done along orthogonal x-y axes) should be considered? This paper, Hyper-X Hot Structures Comparison of Thermal Analysis and Flight Data (https://tfaws.nasa.gov/TFAWS04/Website/program/paper/TFAWS04_RAmundsen_Aero_CFD.pdf) describes a vehicle, Hyper-X, with highly swept wings which required non-orthogonal interpolation.
- Does the aeroheating vary with some parameter other than time (such as atmospheric density in an aerobraking pass)? This paper, Aeroheating Mapping to Thermal Model For Autonomous

 National Aeronautics and Space Administration	NASA Passive Thermal Control Engineering Guidebook	Revision: 4.0
	Date: 9/25/2023	Page 54 of 202
	Distribution Restrictions: Publicly available	Security Classification: Unclassified

Aerobraking Capability (<https://tfaws.nasa.gov/TFAWS10/Proceedings/Aerothermal/RuthAmundsen.pdf>) describes a method for using aeroheating that is dependent on the atmospheric density instead of time.

- Aeroheating analyses, such as for atmospheric entry, often result in very large temperature variations such that the effects of temperature dependence of material properties, e.g., thermal conductivity and specific heat, become significant. If available, the temperature-dependent material properties should be included in the analysis. Care must be taken to ensure that the temperature range of the properties encompasses the possible temperature range in the analysis. If not, the analysis tool may extrapolate the data and calculate an unrealistic value.

In general, the analyst should make sure that aeroheating load sets used are fully documented to answer all of these questions.

There are many software packages that can be used to analyze a problem that includes aeroheating. Since the heat load will vary with distance, time and surface temperature, it is normally important to choose a software tool that will allow those interpolations to be done accurately.

Some general methods for input of heat flux include:

- Apply cold wall heating with a correction factor for actual surface temperature, as in the following equation. This method accounts for the direct dependence of heat flux on surface temperature, but ignores the dependence of h_c on temperature).

$$Q_{actual} = Q_{cold\ wall} * \left\{ \frac{(T_{fluid} - T_{surface})}{(T_{fluid} - T_{cold\ wall})} \right\}$$

- Interpolate between heating values given for different wall temperatures. In other words, aeroheating load sets would be supplied for each of several possible wall temperatures (for example 300, 500, 1000, 1500, 2000K), and each set would contain the dependence on location and time. Then the program would interpolate to the correct heating at a point for a given predicted surface temperature, as well as location and time.
- Aeroheating loads can be supplied as a convective boundary condition with h_c and T_{fluid} rather than heat flux (Q). This allows interpolation with actual predicted surface temperature.
- An iterative process can be followed with hot wall heat flux and surface temperature, where the aeroheating loads are predicted for the expected surface temperature, those are fed into the thermal model, and yield a better prediction of surface temperature, which is fed back into the aeroheating code to provide a better predict of hot wall heating, and the iteration continues between hot wall Q and surface temperature until they converge.
- An integrated software tool that applies heat loads based on surface temperature can be used
 - e.g., Boundary Condition Mapper in the C&R Thermal Desktop® suite, Transient Thermal Analysis Software (TTAS) in ANSYS®, MSC Marc® design software, and others

No matter how the aeroheating loads are applied, the following aspects should be considered:

- Heat loads should be verified graphically before and after applying them; otherwise they may be found later to have invalid assumptions or incorrect geometry. This course (<https://mediaex-server.larc.nasa.gov/Academy/Play/e496742590e044cf803644e744c7c4441d?catalog=8b40998b>)

 National Aeronautics and Space Administration	NASA Passive Thermal Control Engineering Guidebook	Revision: 4.0
	Date: 9/25/2023	Page 55 of 202
	Distribution Restrictions: Publicly available	Security Classification: Unclassified

-9b64-4987-a2b6-75dc6af48d1e) gives examples of errors that have been found with graphical heat load modeling.

- The heat loads produced should use a method that accounts for geometry breaks and protuberances, since those can cause sharp changes in heating levels. This paper from Ares I-X ([https://tfaws.nasa.gov/TFAWS10/Proceedings/Passive Thermal/Ruth Amundsen.pdf](https://tfaws.nasa.gov/TFAWS10/Proceedings/Passive%20Thermal/Ruth%20Amundsen.pdf)) describes some of those issues.

There are two general methods for analysis of an aeroheating scenario in which TPS material response is involved. The aeroheating, ablation and thermal analysis can be integrated in a single model, such that analysis of the TPS behavior and thermal analysis of the underlying vehicle are performed together. This has the inherent simplicity that the bondline temperature is predicted at each time point using the effects from both the TPS response and the vehicle internal thermal effects, and also model configuration control is simplified since there is only a single model. Another method is to separate the TPS analysis and the underlying vehicle thermal analysis into two models, with the break point being at the TPS bondline. In this method, normally the TPS analysis is used to predict the bondline temperature timeline for a variety of cases, and those temperatures are mapped onto the bondline as a boundary condition for the vehicle model (which may have a different mesh on the bondline).

A NASA standard (NASA-STD-5021) has recently been released which covers TPS design, development, manufacture, and testing.

4.2.10 *Thermal/Structural Mapping*

This section describes an effective method for determining thermal stress and thermal-related deformations. Actions from the structural side are described, followed by actions taken by the thermal analyst to produce mapped files, and finally, the use of those files by the structural analyst. This process is described for the Patran™ modeling software/NASTRAN structural application, and Thermal Desktop™ (TD) software suite for the thermal analyst. A very similar flow is possible using SpaceClaim® application on the structural side, and many of the general notes will also apply when using other codes. These instructions are current for Thermal Desktop™ 5.8 suite, MSC Patran™ 2017.1 software and MSC Nastran™ 2017.1.0 application.

4.2.10.1 Structural Analyst: Provide Bulk Data Files

The structural analyst provides bulk data file(s) for the component(s) or assembly to be mapped. Common suffixes for bulk data files are .dat, .bdf, .nas, and .blk.

It can be helpful to create a separate group for each component of the structure for which a thermal map is desired. In Patran™ modeling software, under the “Analysis” menu, select “Analyze, Selected Group, Analysis Deck” to create a NASTRAN bulk data file (BDF) for each group. There should be a separate BDF for each component for which a thermal map is desired. In general, for contacting parts, it will be more accurate to create a separate BDF for each component; this avoids the problem of high temperatures smearing across to a lower temperature component during the mapping.

At GSFC a single Simcenter™ FEMAP™ software Neutral file is used with all the mapping groups defined. Then within a single Mapper object, each TD group is associated with the FEM group. Care must be taken to ensure that FEM grid points do not appear in multiple groups.

 National Aeronautics and Space Administration	NASA Passive Thermal Control Engineering Guidebook	Revision: 4.0
	Date: 9/25/2023	Page 56 of 202
	Distribution Restrictions: Publicly available	Security Classification: Unclassified

4.2.10.2 Thermal Analyst (Thermal Desktop™ software suite): Map Thermal Results to Structural Mesh

1) Create AutoCAD® software groups to limit what Thermal Desktop™ software entities map

This step is optional, but very helpful in limiting mapping to the correct parts, especially in the case of close contacting parts. Select Thermal > Modeling Tools > Make AutoCAD® software group, and select the TD entities that are desired to provide temperatures for a given component. Repeat this for each desired component that will be provided from the structural model. The best mapping is achieved if the mapping is limited to the desired AutoCAD® software group within the TD model, so that thermal parts are not included which are not part of the structural model. The thermal data can be mapped at either one point in the time set or all times. Domain tag sets can also be used here, as they will transfer into higher models if that is desired.

2) Create a coordinate system for each structural model

This step is also optional but helpful for repeated mappings. An issue with the large file size of the structural models is that they are unwieldy when maintained within the model, since they can be more than triple the thermal model size. Also, there are sometimes several different structural models on a project that are used for mapping. Maintaining all of them inside the thermal model uses a large amount of space, as well as slowing the model down in terms of graphics display. However, since they must be resized and moved into location each time they are imported, it is a substantial investment of time to remove them after each mapping and then re-import them. The solution to this is to create a coordinate system for each structural model. When any given structural model is to be imported for mapping, the user coordinate system is set to the appropriate one, and thus the import can be easily accomplished in a single step. The unit conversion from the structural model length units to the thermal model units is accomplished within the import form itself.

3) Import NASTRAN structural meshes

Import all NASTRAN meshes created by the structural analyst. Confirm the length units that are being used by the structural analyst (these will be used below in the input form), and what temperature unit is preferred in output. In TD, do Thermal > Export > Post-Processing Data Mapper. Browse to the NASTRAN file provided (this must be done separately for each file). The filter for browsing can be set to .bdf, .nas, or .dat files. The NASTRAN BDF file must have a BEGIN BULK card. If the analysts are using the same coordinate system, use the world coordinate system (WCS) option. Otherwise, create a User Coordinate System (UCS) in the TD model that is identical to the structural one. In the form, set the output file name and the units, set output format to either NASTRAN or ANSYS® software file, set times to either a single one or all in a transient as desired, set the data mapping to the AutoCAD® software group desired. The mapping tolerances are very important. The current version of TD does automatic tolerancing using the Advanced Mapping selection to automatically find the closest object. If that is not successful for some reason, the Mapping Tolerances can be defined in the form. In general, for the most accurate mapping, a sequence of values is used that start at zero, and increase by small amounts. Tolerances should be as small as possible while still yielding a successful mapping for all structural nodes. Tolerances can be set to larger values if a smearing of thermal results is desired for some reason. The TD manual also has a good description of performing mapping.

4) Exporting Temperatures from the Thermal Desktop™ software model to an MSC NASTRAN™ software model

For this to work, the two meshes MUST be in the same location.

 National Aeronautics and Space Administration	NASA Passive Thermal Control Engineering Guidebook	Revision: 4.0
	Date: 9/25/2023	Page 57 of 202
	Distribution Restrictions: Publicly available	Security Classification: Unclassified

There are a few methods which make this mapping easier. First, the structural model file size is often very large (>50GB). Thus, mapping of multiple points along a timeline creates extremely large files. It is normally very difficult to determine from a thermal timeline where the maximum stress or deflection will occur, and so it is difficult to select just a single best point to map for the worst case stress. Mapping each time point of a transient in order for a structural person to find peak stress/displacement is extremely time-consuming for both analysts. Instead, create a variable that defines the peak temperature gradient and only map temperatures to the structural model when that variable is at its extremes. One way to do this is to create registers for the gradient along each axis of the part in question, then defining the time point for worst case stress based on when those registers reach a peak. The register showing the magnitude of thermal gradient across the parts can be plotted as a transient in time. By mapping several time points to the structural model, the variables which best predict the stress level in the parts can be determined. Then, after a timeline is run, those registers can be plotted, and the temperatures only mapped to the structural model at the time point where those registers were at their extremes. In short, identify timesteps where the stresses are likely to be high due to larger thermal gradients and map only those points for thermal stress analysis.

To map temperatures, the desired thermal results set should be posted. It is not important what thermal entities are posted in the window. Open the Post Processing Data Mapper form for each structural mesh for which mapping is desired, adjust times and file name as necessary, and select Exit & Map. Single time points or transients can be done (transients, where a map at each time point is created, will obviously have larger file sizes). There are two structural file formats created when the mapping is done: a two-column format that simply lists node, temperature in two columns, and a .dat format that gives temperatures in NASTRAN format. The .dat format is a standard NASTRAN .dat file with the name assigned in the BCM form (normally easier for the structural analyst to use), and the two column is a .txt file which will have the assigned name with ‘Transient’ added for transient maps, and ‘TwoColumn’ added for single time point maps. There are other files created that can be useful. One is the mapping roadmap, which shows the multiplication factors and thermal nodes that map to each FEM gridpoint. This can be very useful to see what thermal nodes go into a particular FEM mapped value if inconsistencies are observed.

After mapping, the temperatures can be viewed on the structural mesh alone (select the structural mesh in the model browser and select ‘O’ to view that part only). An image of that should be taken (Thermal > Utilities > Capture Graphics Area), and compared to the thermal map on the thermal entities, to verify the thermal map has been done correctly. It can be useful to compare the thermal temp field and the mapped temp field for every group on a single case as a “pipecleaner” image before processing multiple files. This can highlight any areas where the models differ by significant amounts.

The output thermal mapped file and associated image files can then be transferred to the structural analyst. The image files can be used by the structural analyst to ensure that the mapping in the structural model is the same as that provided by the thermal analyst.

4.2.10.3 Structural Analyst: Analysis using Thermal Map Files

The thermal map file generated by the Thermal Desktop™ software suite will have TEMP (and/or TEMPP1) entries the structural grids (and/or elements) for each case. The map file can be imported to a pre/post processor and used as a load case, or the map file can be directly included into a Nastran solution

 National Aeronautics and Space Administration	NASA Passive Thermal Control Engineering Guidebook	Revision: 4.0
	Date: 9/25/2023	Page 58 of 202
	Distribution Restrictions: Publicly available	Security Classification: Unclassified

deck. The default suffix for the thermal map is .dat. The .dat file generated by Thermal Desktop™ software is known to be compatible with all versions of MSC Nastran™ applications up to 2017.

The mapped thermal *.dat file received from the Thermal Analyst will only have grid point temperature fields (TEMP) assigned to the nodes from the model provided. The TEMP card assigns a temperature to each node for each time point of the orbit that is to be analyzed.

In Patran™ software, the steps are as follows:

File → Import → Object:Model; Source: MSC.NASTRAN Input; Select file; Apply

Since none of the nodes (GRID) are defined in the file that is provided by the Thermal Analyst, Patran™ will ask the following question:

The node ID offset has been set to XXX and the element ID offset has been set to XXX, but no nodes or elements were found in the input file. References to node IDs and element IDs by LBCs will be offset by these amounts. Do you want to reset the node and element ID offsets to 0 before importing the LBCs?

Click “Yes”.

Patran™ software has now imported the mapping and created a LOAD set for each time point of the orbit. Each mapping now needs to be incorporated into a separate Load Case by the Structural Analyst with the correct Boundary Conditions. The contours for each time plot can be created using Load/Boundary Condition → Plot Contours and selecting the case, temperature and group. This contour can be verified with an image provided by the thermal analysis that the import was completed successfully. Once completed, proceed to “Analyze” and prepare the analysis for MSC Nastran™ software.

4.2.11 STOP Analysis

Structural Thermal Optical Performance analysis (STOP analysis) is used to ensure the optical performance of a system will meet requirements in all expected environments over the course of the mission. The purpose of the analysis is to determine how the optical components move and deform with temperature changes, and to quantify the effect these changes will have on the overall optical system. Performing a full STOP analysis requires at least three discipline engineers, and requires a substantial amount of coordination, and data handoffs. Figure 15 shows a typical process for performing the analysis. As with any project, the system is first defined, and an optical layout is created to meet the requirements of the instrument. An optical tolerance analysis is performed at this stage to determine the sensitivity of the final optical performance metrics to small motions of the optical components. This can be converted into an overall optical error budget, and a part of this budget can be assigned to thermal and structural effects on the system. Best practices are then used for designing the optical mounts to hold the optics in the system, and simple checks (such as length changes with temperature) should be performed to ensure the design will meet the error budget at a high level. Once this is complete, the geometry of the system can be converted into thermal and structural models. Thermal analysis is performed for worst case environmental conditions to determine the expected temperature range of the system. These temperatures are then used in the structural analysis to determine the displacements, rotations, and deformations of the optics due to thermal expansion. The deformations are mapped to the optical model, as well as any changes in lens refractive index due to the calculated temperatures. Optical analysis is then performed

 National Aeronautics and Space Administration	NASA Passive Thermal Control Engineering Guidebook	Revision: 4.0
	Date: 9/25/2023	Page 59 of 202
	Distribution Restrictions: Publicly available	Security Classification: Unclassified

using the structural and thermal disturbances to determine if the system meets the overall error budget, or specific optical requirements.

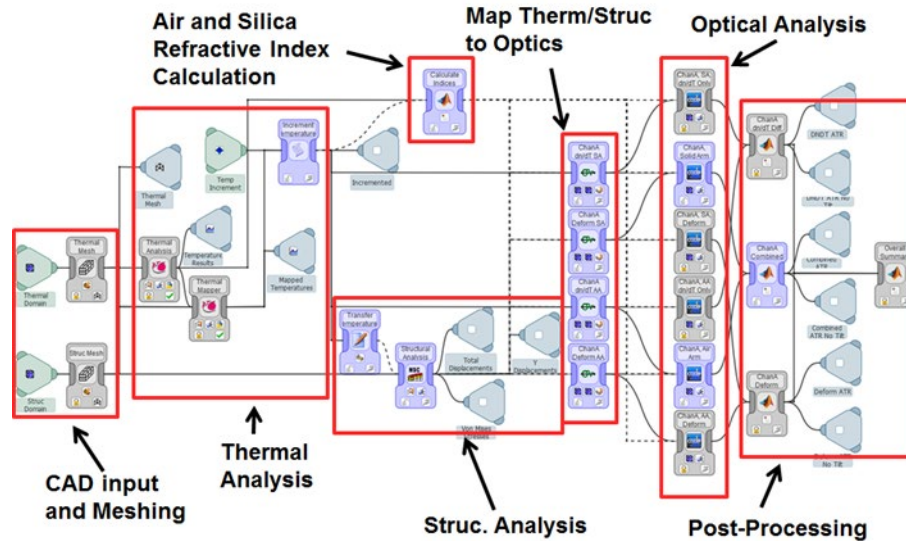

Figure 15. STOP analysis process.

The process shown in Figure 15 can be performed manually, which each engineer passing the results of their analysis to the next, or in a more automated fashion, where the entire STOP model is built in one place. At LaRC, the Comet Solutions™ software package has been used to do this, and more detail is provided in section 4.7.2.

General practices to consider when performing STOP analysis:

- Use a consistent set of units across disciplines
- Use a common coordinate system
- Ensure all analysts are working to the same design version
- Ensure all analysts are using the same materials for all components
- Meet as a team regularly during the process to ensure everyone is moving in the same direction
- Perform test runs of the analysis process when possible to ensure it is yielding accurate results.

This can be done in several ways:

- Move an optical component in the structural model by a fixed amount, and make sure the resulting STOP analysis using this motion matches an optical analysis with the same motion applied directly to the lens.
- If refractive index changes are important, ensure that the optical path length through the system, when calculated through the thermal portion of the STOP process, matches the expected path length change for the temperature change applied.
- Set the coefficient of thermal expansion (CTE) for all parts to the same value in the structural model and configure the boundary conditions so that stress free expansion should be possible. Perform a static analysis for a uniform temperature change and verify that no stresses exists in the model. This will ensure there are no elements or boundary conditions causing artificial stresses on the optical components.

 National Aeronautics and Space Administration	NASA Passive Thermal Control Engineering Guidebook	Revision: 4.0
	Date: 9/25/2023	Page 60 of 202
	Distribution Restrictions: Publicly available	Security Classification: Unclassified

Thermal engineer responsibilities and tips:

- Determine the extreme environments that the system will encounter over its mission life. Include testing environments as well as operational environments.
- Determine which operational procedures may affect the temperatures of the components and should therefore be included in the analyses. An example may be a calibration mode where the instrument is pointed toward the sun for certain amount of time.
- If the system is sensitive to changes in the refractive index of lenses due to temperature change, ensure that the lenses are meshed with enough fidelity to capture the internal temperature gradient. The level to which this must be done will depend on how strong the expected gradient is in the lens, and how sensitive the results are to thermal lensing effects.
- Work with the structural engineer to ensure temperatures are being accurately mapped between the thermal and structural models. This may also mean defining how to model components before mapping. What may be a simple conductor to a thermal engineer, might be a 10000-node mesh to the structures engineer. For areas that are mapped, sufficient detail needs to exist in both models.
- Guidelines for the use of Model Uncertainty Factors (MUF) can be found in this document.

4.3 Model Naming and Documentation

References [1] through [3] were used to assist in the development of much of the information in this section. Additional guidance on naming on documentation that is specific to the Thermal Desktop™ suite is provided in Section 4.7.1.

4.3.1 *Overall Model Name*

The thermal model file name should include what it is for (e.g., CLARREO Bus) as well as a version number (e.g. 'CLARREO Bus v3.dwg'). If applicable, consider naming the thermal model so that it reflects the CAD version that is consistent with the geometry.

4.3.2 *Symbols*

Symbols should be used whenever possible, and certainly for any value that could feasibly change throughout model development. Define in advance symbols that can be used in a model and what units they are in, such that there is a common understanding between all model developers. An initial checklist for items that should be defined as symbols is:

- All thicknesses
- All defined flow rates
- All masses (in particular, for electronics boxes)
- All defined temperatures (may link to array)
- All powers and switches for electronics
- All hold times
- All time periods (time on or off for avionics sequencing, etc)
- All contact conductances
- All ambient pressures
- Any assumed (not calculated) convection coefficients
- Defined times

 National Aeronautics and Space Administration	NASA Passive Thermal Control Engineering Guidebook	Revision: 4.0
	Date: 9/25/2023	Page 61 of 202
	Distribution Restrictions: Publicly available	Security Classification: Unclassified

- Case definition (Hot, cold, nominal, max gradient, pre-day of flight, day of flight).
- Location definition (for models with varying locations)
- Orbit parameters (altitude, solar flux, albedo, etc.)
- Run start time
- Run length

An example of standard naming conventions for symbols is provided in Table 3. Some general rules for usage are below:

- The names of all symbols and registers must be prefixed by type
- All prefixes should end with an underscore
- Try to keep prefixes general to reduce the number of prefixes
- If a desired symbol does not fit into the listed types, define a new prefix with a new definition and unit set
- UNITS: [L] - Length, [T] - Temperature, [P] - Power, [E] - Energy, [t] - time, [m] - mass
- Why is this called Hungarian? See http://en.wikipedia.org/wiki/Hungarian_notation

There may be groups of symbols that are desired to be kept together (such as all values related to a certain yaw maneuver), where the symbols would begin with, say, “yaw_” rather than with the abbreviation normal for that particular item. Sometimes, symbols may be grouped by organization, if the model is being modified by several organizations.

Table 3. Suggested Prefixes for Symbols and Registers

PREFIX	MEANING	UNITS
thk_	Thickness of a solid or surface	[L]
dim_	Arbitrary linear geometric dimension	[L]
A_	Geometric area	[L ²]
T_	Temperature	[T]
t_	time	[t]
Qflx_	Heat Flux	[P/L ²]
Q_	Heat rate	[P]
Gflx_	Conductance per area	[P/L ² /T]
G_	Total Conductance	[P/T]
Gdim_	Conductance per linear dimension	[P/L/T]
flag_	An integer variable used to change some logic/geometry/case/BC/etc. in the model	none
switch_	A flag_ having only "ON" (1) or "OFF" (0) values	none
case_	A flag specifically for changing analysis cases	none
loc_	A flag specifically for changing environmental location	none
num_	An integer count, total number of something	none
fac_	a multiplication factor	none

PREFIX	MEANING	UNITS
R_	Electrical resistance	[electrical resistance]
V_	Voltage	[electrical potential]
pres_	Pressure (like air pressure)	Force/L ²
mass_	Mass	[m]
Cp_	Specific heat	[E/m-T]
FR_	Mass flow rate (for a fluid)	[m/t]
Hc_	Film coefficient (convective)	[P/L ²]
prop_	a material property such as ϵ^* , density, conductivity, etc.	various
const_	a constant like pi, or conversion from in to m	various
v_	Velocity	[L/T]
vol_	Volume	[L ³]

Beware of using place holders when initially setting up a model. If a value is unknown, it is better to make a rough estimate than put a generic placeholder value (such as 1.0) because of the danger that the analyst will forget to go back and change it. It is always best to include a comment to explain the rationale for the value.

Additional guidance on the use of symbols that is specific to the Thermal Desktop™ suite is provided in 4.7.1.1.

4.3.3 Versioning

At the start of a modeling effort, it is essential to determine a versioning scheme that can be used throughout the model development. This is extremely important when modeling collaboratively with other analysts, but is also critical for individual analysts in order to maintain traceability and clarity on the impact of changes made to a model over time. Below are some tips related to model versioning:

- Models should be named appropriately, and then versioned by ending with `_v#` (e.g. SAGE3_ISS_v1.dwg). Optical and thermophysical property files should be named with the same `_v#` suffix.
- As minor model changes are made (changes to symbols, contactors, conductors, orbits, cases, etc.), a letter is added to the name and incremented as versions are released (e.g. SAGE3_ISS_v14c.dwg).
- When more major changes are made to the model, including substantial changes to changes to number of surfaces, number of submodels—such that .sav files or radks will no longer be valid—or any changes to optical or thermophysical property files, the number should be incremented and letters removed (e.g., SAGE3_ISS_v20.dwg). The suffix for the property files should be incremented along with each major model version update. Each major version of the model should be stored in its own subfolder, along with its optical and thermophysical property files and any results files.
- Version history, including model name/version, date, person who made the updates (if working with multiple analysts), and a summary of the changes, must be kept with the model. Keeping this in the overall analysis log (Section 4.3.4) works well.

 National Aeronautics and Space Administration	NASA Passive Thermal Control Engineering Guidebook	Revision: 4.0
	Date: 9/25/2023	Page 63 of 202
	Distribution Restrictions: Publicly available	Security Classification: Unclassified

- If the model is being shared among multiple analysts, then the official “production” version should be housed in a shared location along with the analysis log (Section 4.3.47). A system must be put in place for how the model will be checked in and out, and how team members will be notified. This allows teams to avoid the problem of multiple changes occurring in parallel which must later be merged. One simple, though less elegant way to do this is to use email and a text file in the shared directory to indicate who has the model checked out.
- With each version update (minor or major), a set of check cases must be run so that the impact of changes can be assessed. This provides a way for the analyst to make sure the impacts are as expected. Check cases should be defined at the start of model development, and should be kept as consistent as possible as the model progresses. Results of check cases should be kept in the analysis log (Section 4.3.4) to facilitate easy review of changes over time.

4.3.4 Analysis Logs

The value of detailed logging during model development cannot be overstated. An analysis log is a vitally important communication tool when a model is shared by multiple engineers; however, such record-keeping is equally important if a model is being developed by a single analyst. Below are some of the reasons why keeping notes on day-to-day modeling activities is essential:

- Having a record of model development greatly decreases the amount of time necessary to generate thorough documentation of a model development effort.
- Having the ability to look back over what has been done in a model (what worked vs. what didn’t, what variables the results are most sensitive to, how each change impacted the results, etc.) greatly decreases the chances that the analyst will miss something important when developing predictions.
- If an analyst has to return to working on a model after a gap of time, it can be difficult to recall what has been done and where the work was left off; having documentation of model development is a good way to increase efficiency in this scenario.
- If another analyst needs to take over someone else’s work or pick up a model in the future, the existence of an analysis log is invaluable for the new analyst to gain an understanding of the model and to ensure longevity of the knowledge associated with the model.
- Many times an error or trick experienced on one model can be useful for another, so documenting experiences allows the analyst to take quick advantage of what worked on a similar problem before.

Analysis logs can be done in a variety of formats but electronic formats are best since they are searchable and easier to share than hand-written records. Excel spreadsheets work well. The analysis log should always be stored with the model. Using the Thermal>Utilities>Notes in TD allows the text to be kept with the model at all times. Multiple tabs allow varying organizations to keep their own lists relevant to their own subsystems. However, normally more detail than this text form is necessary, to store run results, images, etc. When using TD, at least a summary of model development (starting point and current version) should be kept in Thermal>Utilities>Notes.

The log should include the following:

- Detailed notes on changes made to the model

 National Aeronautics and Space Administration	NASA Passive Thermal Control Engineering Guidebook	Revision: 4.0
	Date: 9/25/2023	Page 64 of 202
	Distribution Restrictions: Publicly available	Security Classification: Unclassified

- Include date and analyst (if model is shared)
- Include reminders if “what-if” changes are made to the model
- Notes should be raw (“warts and all”)—it is not necessary to take the time to perfect the language since the goal is simply to have a thorough record and not to create a formal document
- Version history (including date, summary of changes, and context such as versions that correspond to reports, reviews, or tests)
- Notes on general approach (units, boundary condition application, orbital parameters/environments, meshing, numbers for special nodes such as thermocouples)
- List of major assumptions
- List of open items / to-do’s for later
- Calculations, if not performed within the thermal model (such as conductance and power dissipation)
- Materials and property sources (if not captured within the thermal model)
- Results
 - At a minimum, a small set of check cases that represent the major configurations of the model should be run and recorded each time the model version is updated
 - Ideally, the log should include results from all analysis runs
 - The results sheet should include thermal limits so that analysts can easily see if a new version of the model predicts that limits will be reached
 - Summaries of trade studies should be included for future reference (including the reason for the trade, methodology, range of values, and decisions made based on results)

Examples of model logs can be found on the shared drive within the Agency firewall.

A related tip is that in order to make sure colleagues’ notes can be found after they leave the organization, it is helpful to document the method/location each engineer uses for note-taking. This information should be stored on a shared drive and updated at least once a year.

4.3.5 Archiving

Good practices for model archiving are listed below:

- Notes should always be included wherever a model is archived so that the model is usable in the future (see Section 4.3.4).
- Come to agreement with all analysts working on a model regarding which results files should be archived/stored with each model version when updates are made at the shared location. At a minimum, results from check cases should be recorded and saved; however, it may also be beneficial to record results from all significant trade studies so that they can be easily reviewed later.
- When a formal report is written, the version(s) of the model used to generate the results in that report should be archived with the report.
- The model documentation should clearly identify the usage limits for the model and to what extent it was verified (i.e., credibility). One finding from the Columbia Accident Investigation Board was models were used outside of known limits. In other words, there was an intended use of the

 National Aeronautics and Space Administration	NASA Passive Thermal Control Engineering Guidebook	Revision: 4.0
	Date: 9/25/2023	Page 65 of 202
	Distribution Restrictions: Publicly available	Security Classification: Unclassified

model when it was created, then it was used in a different manner years later. Keep in mind that a different engineer could be the user, so identifying the key assumptions, uncertainties and limitations/concerns with a model will help prevent unintended use in the future. An example Model Description Sheet utilized by MSFC/EV34 to accompany each archived model can be found within the Agency firewall in EV34-OWI-002.

- Upon project completion:
 - The final version of the model (at a minimum) should be archived with the project and branch.
 - All major versions should be archived on bulk file storage that is accessible indefinitely to the analyst.

4.4 Commonly Used Inputs

4.4.1 *Air/Ground/Sky/Solar/Lunar Data*

Data for near-Earth orbits are well compiled in NASATM-2001-211221, Guidelines for the Selection of Near-Earth Thermal Environment Parameters for Spacecraft Design, available on the Agency share and also here <https://ntrs.nasa.gov/archive/nasa/casi.ntrs.nasa.gov/20020004360.pdf>. An older reference is also available at the Agency share link, and additional information for other planets can be found in the *Spacecraft Thermal Control Handbook* [Ref. 4].

For modeling on the Earth surface, which requires air and sky temperatures, as well as solar flux, there are several sources. The National Solar Radiation Database (NSRD), provides modeled hourly values of direct beam incident, diffuse horizontal, and total horizontal insolation (NSRD data provided by the National Renewable Energy Laboratory, Golden, Colorado, USA, from their web site, <https://www.nrel.gov/grid/solar-resource/renewable-resource-data.html>. Sky temperature data can be obtained from the North American Regional Re-analysis (NARR) database (POR 1979-2006), which contains downward longwave radiation at the earth's surface, measured eight times per day, on an approximately 32 km grid surrounding the North American continent (NARR data provided by the NOAA/OAR/ESRL PSD, Boulder, Colorado, USA, from their web sites at <http://www.cdc.noaa.gov/> and <https://www.esrl.noaa.gov/psd/data/gridded/data.narr.html>).

Many of the environmental variables are also defined for NASA use in an SLS document, SLS SPEC-159 Cross-Program Design Specification for Natural Environments (DSNE), at <https://ntrs.nasa.gov/citations/20170008140> and in NASA TM-2016-218229, Natural Environments Definition for Design (NEDD), at <https://ntrs.nasa.gov/citations/20170003920> (which also encompasses Earth and lunar orbit environments). See also section 4.7.1.22 for use of the data in analysis.

The University of Colorado's Laboratory for Atmospheric and Space Physics (LASP) has collected and compiled a wealth of solar data (solar spectral irradiance, total solar irradiance, etc.) from various missions. The data is available to the public and posted on the LASP Interactive Solar Irradiance Data Center (LISIRD) website, <https://lasp.colorado.edu/lisird/>.

For lunar environments, an excellent resource is the Lunar Thermal Analysis Guidebook, available as a PDF and with explanatory slides on NTRS: <https://ntrs.nasa.gov/citations/20210010030> and <https://ntrs.nasa.gov/citations/20210019919>.

 National Aeronautics and Space Administration	NASA Passive Thermal Control Engineering Guidebook	Revision: 4.0
	Date: 9/25/2023	Page 66 of 202
	Distribution Restrictions: Publicly available	Security Classification: Unclassified

4.4.2 *Thermo-Physical Material Properties*

As part of an NESC effort, for those inside the NASA firewall, commonly used material thermophysical properties are available on the NESC NEN site. Other good references are shown in section 14.0 Appendix E: Materials Databases.

4.4.3 *Optical Properties*

4.4.3.1 NESC Reference Database

As part of an NESC effort, for those inside the NASA firewall, commonly used material optical properties are available on the NESC NEN site. Other good references are shown in section 14.0 Appendix E: Materials Databases.

4.4.3.2 Air Mass Values for Solar Absorptivity

Most references for space-flight thermo-optical properties are given for the space environment. This assumes the normal solar spectrum as measured outside of Earth’s atmosphere. If the analysis case is on Earth or a planetary surface, the solar spectrum will be different because of the preferential absorption of parts of the solar spectrum by the air as the sunlight passes through on the way to the surface. This can lead to substantial change in the solar absorptivity of the surface material that should be used in a normal thermal radiation software package. The reason is that the spectrum of the sunlight that is actually striking the surface is different than the normal solar spectrum assumed by most thermal radiation software. Thus, a modified solar absorptivity value must be used in the software, to account for the difference in how much solar flux will be absorbed by the surface based on the actual solar spectrum. The absorptivity value corresponding to sunlight that has passed through a certain amount of air is indicated by the “air mass” value ([https://en.wikipedia.org/wiki/Air_mass_\(solar_energy\)](https://en.wikipedia.org/wiki/Air_mass_(solar_energy))). As a simplistic example in Figure 16, air mass 0 means there is no air present and it is a standard in-space solar spectrum. Air mass 1 properties indicates properties for a solar spectrum using solar noon at sea level. Figure 17 indicates how the amount of air passed through, depending on the location of the sun relative to the surface on the earth, changes the air mass value. An excellent image reference for this is at https://www3.nd.edu/~kamatlab/images/AM_15_Solar_spectrum.jpg. Air mass 1.5 (<http://rredc.nrel.gov/solar/spectra/am1.5/>) is often used as an average value for a surface at the surface of the Earth, to indicate the amount of atmosphere that sunlight passes through averaged over a day. Figure 18 shows a sample of how the solar spectrum changes due to air absorption, and Table 4 shows some example white paint property changes. The important takeaway is to include this effect whenever doing an analysis under a planetary atmosphere, and ensure correct optical properties are used. Many of the commercially available solar absorptivity measurement devices will allow output of the data for various air mass values.

Air mass 0

Air mass 1

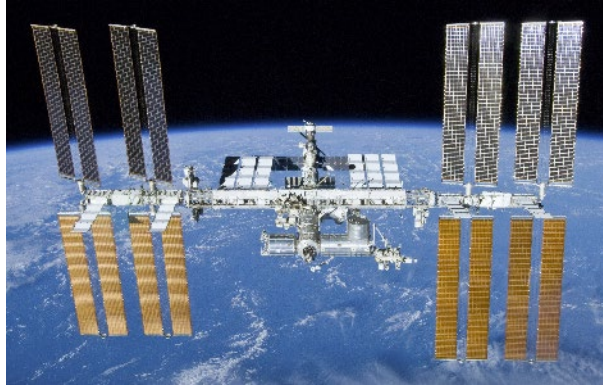

Figure 16. Air mass illustration.

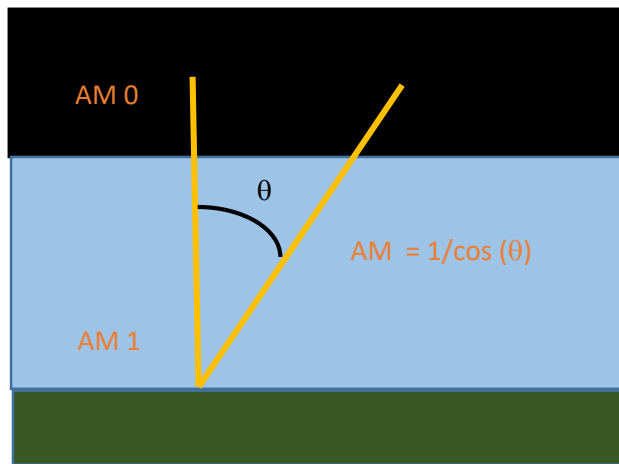

Figure 17. Air mass geometry.

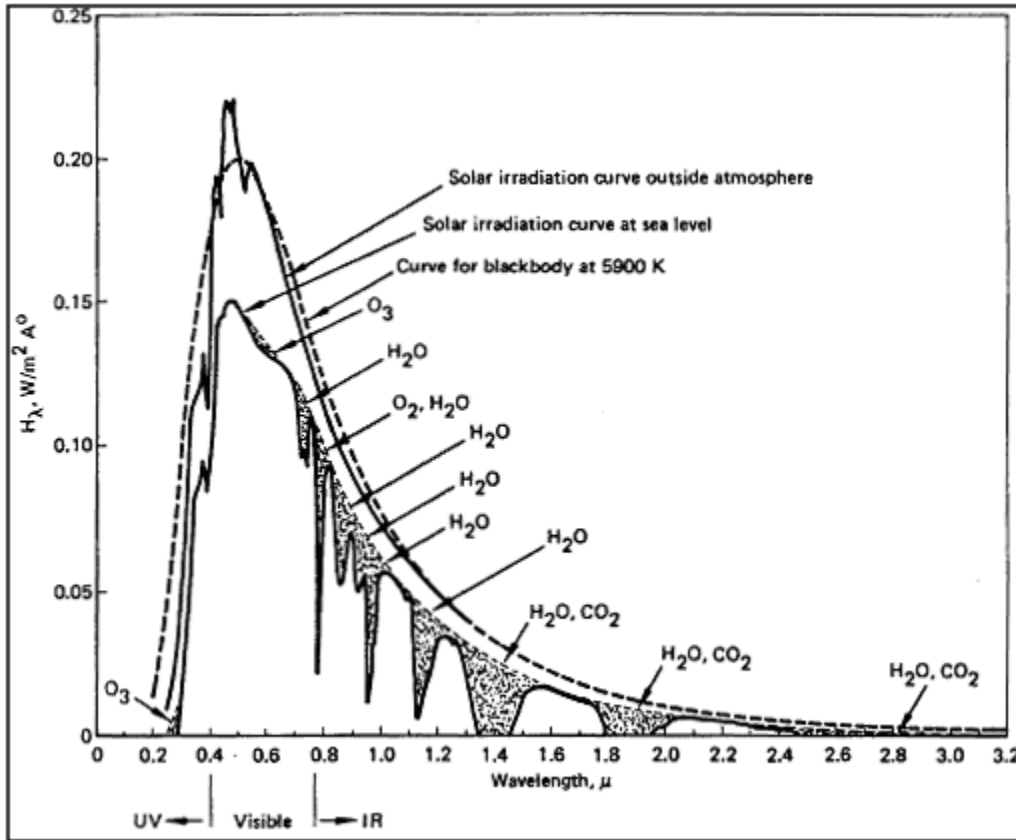

Figure 18. Sample spectrum (from NASA-STD-3000).

https://msis.jsc.nasa.gov/sections/section05.htm#_5.7_RADIATION

Table 4. Examples of Air Mass Properties used on Ares I-X

Examples	α AM 0	α AM 1.5
White Rust-oleum® coating	0.34	0.29
Hentzen™ white coating	0.23	0.18
Acryshield® A590 coating	0.30	0.26

4.4.4 Correlated Contact Conductances

This section currently has minimal content, but the intention is to include a full listing of correlated contact conductance values from previous projects, which can be used as ball-park estimates for analysts creating new models. Information from the following projects will be included in future revisions:

- SAGE III: Contact conductance values for metal-to-metal large part contact (not chip-to-board) ranged from 1000 to 5000 W/m²K.
- Ares I-X: Correlated contact conductances for avionics boxes which were edge-bolted with thermal grease interface were found to be 150 to 600 W/m²K, with the smaller values for larger

 National Aeronautics and Space Administration	NASA Passive Thermal Control Engineering Guidebook	Revision: 4.0
	Date: 9/25/2023	Page 69 of 202
	Distribution Restrictions: Publicly available	Security Classification: Unclassified

boxes (greater than roughly 1 ft² in contact area), and smaller values for boxes larger than that. The original units in report AIX-TAR-THM0004 were British, 27 to 104 Btu/hr-ft²-°F.

- Mars Science Laboratory Entry Descent and Landing Instrument (MEDLI) and MEDLI2: Data to come in next version.
- NDL: Early tests of prototype hardware found correlated contact conductance values for chips pressed against a pedestal utilizing a thin thermal pad of 2200 to 2800 W/m²K.

4.4.5 Bolt Diameters and Wire Sizes

Thermal engineers will sometimes need wire diameters (to estimate the thermal conductance of a cable), and bolt sizes when they are computing the thermal resistance of a complex joint. These can be found in simple Web searches at locations such as https://www.engineersedge.com/screw_threads_chart.htm for bolt sizes and https://en.wikipedia.org/wiki/American_wire_gauge for wire sizes. There is also a simple calculation workbook available on the Agency share drive to do these calculations. For more in-depth discussion of wire and cabling analysis, see section 4.2.6.1.

4.5 Model Correlation

Reference [8] was used to assist in the development of much of the information in this section. Specific references are included in some subsections as appropriate.

A list of models created by contributors to this document is provided in Section 17.0, along with notes about the level of correlation that was completed.

See also specific current advice and files here on the Agency share drive, and accompanying folders of example files.

4.5.1 *General Approach*

Thermal models are most useful when they can be shown to represent physical reality correctly; this is accomplished by correlating the models to one or more real-world scenarios (test or flight). In general, what this means is to create a configuration in the model that represents a test or flight scenario, run predictions, conduct the test or flight and obtain data, compare the data with the predictions, and make step-wise changes to the model to bring the predictions closer to the actual data. While data in a flight-like configuration is best, analysts should make use of any test data available to improve the accuracy of their models. This may mean creating multiple scenarios in a model to represent various test configurations (see Section 4.1.15), but any correlation is valuable.

The specific approach to correlation will depend on what the main goal of the model is (component peak temperature, transient behavior over a given timeline, thermal gradient and/or stability), so it is important to determine the primary goal prior to beginning correlation efforts.

Transient cases provide more accurate predictions of behavior, even for quasi-steady-state scenarios (see Section 4.1.7). Aside from initial quick-looks, correlation cases should almost always be run as transients, since even thermal balance tests are not the same as analytical steady-state. If the system's mass is sufficiently low that true equilibrium was reached, then it may be possible to use steady-state analysis runs, but using transient runs is likely to be the best method.

When correlating, it is best to proceed from simple to complex. Consider unpowered cases first. Since there are fewer variables than powered cases, the analyst can fine-tune things like conductance values and interactions between the hardware and environment without being concerned about power dissipation. An

 National Aeronautics and Space Administration	NASA Passive Thermal Control Engineering Guidebook	Revision: 4.0
	Date: 9/25/2023	Page 70 of 202
	Distribution Restrictions: Publicly available	Security Classification: Unclassified

unpowered cool-down case (where the system power is removed and data is taken for several hours while the environment remains constant) will allow for a good correlation of the system's thermal mass. If there is a case where the operational power is off and heaters are on, correlating to that case next allows the analyst to match heater behavior. Finally, correlate to cases where the system is fully powered.

Analysts are typically aware of which items in their model have the most uncertainty. When correlating, consider where assumptions were made and start by making adjustments to values that are not well-known. Examples often include contacts between parts, optical properties (if not measured), and component dissipated power (if not measured).

Determination of when a correlation is successful is highly dependent upon the goal of the correlation. A good general goal for a correlation that intends to capture component peak temperatures is to have an overall root-mean-square (RMS) error (see section 4.5.8) of 5°C or less. When correlating for thermal gradients and/or stability, the goal varies based on the project's requirements but typically requires much closer matching.

Below are a few additional general tips for correlation:

- If the initial conditions are incorrect in the model, correlation can be performed to the change in temperature rather than absolute temperature
- If the data is available with fine enough differentiation of time and temperature, the measured slope (rate of change of temperature with time) can be effectively used for correlation. This is a very sensitive measure of behavior, but often the granularity of the data either with respect to time or temperature will make the measured slope not valuable for correlation.
- Having data where something behaves unexpectedly is useful (such as a TEC going out of the control range, see Section 4.5.4)

4.5.2 Files

The following is a checklist of items to consider when developing files for evaluating model correlation:

- Before beginning any correlation runs, a template file should be developed (normally in Excel) which will show error calculations against the test (or flight) data. This can be used to evaluate the quality of the original model as well as to evaluate the on-going quality of correlation.
- Each time a new correlation run is made, the correlation file should be refreshed to show the results of the changes made to the model for that run.
- It is important to keep a log that shows progress of correlation and results of each run as far as RMS error for the most critical nodes and overall RMS error.
- If possible, it is best to maintain all runs made separately in the model, so they are always available for references. Sometimes even geometry changes can be maintained within the model by use of symbols for geometry sizing. However, if a change involves substantial changes to geometry, it may not be possible to maintain them all within a single model.
- It can be valuable to place multiple correlation runs for the same node on a single plot so the analyst can see if the change made between one correlation and the next has the desired effect.
- In addition to evaluating progress from the Excel file and RMS error, it is also important to look at the run results graphically on the model periodically to ensure things are making sense.

 National Aeronautics and Space Administration	NASA Passive Thermal Control Engineering Guidebook	Revision: 4.0
	Date: 9/25/2023	Page 71 of 202
	Distribution Restrictions: Publicly available	Security Classification: Unclassified

- There are sample files available on the Agency shared thermal drive.

4.5.3 Heater Correlation

Below are some tips for correlations involving heaters:

- If the center of the deadband is incorrect, then either heater deadband is wrong or the gradient between sensor and heater is wrong. Note: the deadband of the heater is the temperature difference between the on and off set point temperatures.
- If the range of the deadband is incorrect, then either the thermal mass is wrong or the sensor is the wrong distance from the heater.
- If the slope of spikes is incorrect, then the thermal mass or connection of the heater to the part is wrong.

4.5.4 TEC Correlation

Correlation of Thermoelectric Cooler (TEC) behavior can be a complicated process. Correlation should be started using the known TEC parameters from the vendor, assuming the software used for modeling has a TEC option that allows input of TEC parameters such as material, number of couples, and area/thickness per couple. Careful attention should be given to modeling the TEC with the correct control option (control via current, voltage or power) and the correct input power variable. Most TEC behavior will be best modeled in a transient run rather than a steady-state run. If the standard parameters are not providing a good match to the TEC behavior, it may mean that the TEC has degraded in performance, normally due to damage or contamination. In TD modeling specifically, the checkboxes for generating back conductors for couples (which allows a direct contact between the TEC sides when off) and deep solution method can be utilized. If there is substantial degradation of the TEC (which can be caused by contamination of the base material, or extraneous material present that adds an undesirable thermal conduction between the hot and cold surfaces), an additional contact between the hot and cold sides can be generated in the model to approximate the conduction.

On a recent spaceflight program (SAGE III), correlation to the behavior of an extremely old TEC necessitated use of this additional contact. However, with the use of this, the control of the TEC within the software was not effective. This modeling was done in Thermal Desktop™, which outputs registers that show details of the operation of the TEC within the run (these are described in the TD manual). The CC_ register in this case showed that the TEC was “fluttering” – turning on and off rapidly during the thermal modeling analysis run. This led to extremely long run times. To resolve this, the control mechanism for the TEC within the model was altered. Normally, the control variable applied to the TEC (such as voltage for a voltage-controlled TEC) is applied in the model in a linear manner, proportional to the difference in temperature between the actual cold side temperature and the desired set point. In this case, it was found that using a square of the temperature difference (rather than a linear proportion) to drive the TEC was effective in stopping the flutter. To do this, the control variable itself was made proportional to the temperature difference, so that when that variable was multiplied by temperature difference within the software, the effect was driving it proportional to the square of temperature difference.

One thing that can be extremely valuable in correlating the model of a TEC is to have test data for the situation where the TEC goes out of its control range. In other words, it can be worthwhile to change the conditions for the TEC during a test, either setting a lower cold side temperature or increasing the heat

 National Aeronautics and Space Administration	NASA Passive Thermal Control Engineering Guidebook	Revision: 4.0
	Date: 9/25/2023	Page 72 of 202
	Distribution Restrictions: Publicly available	Security Classification: Unclassified

dissipation at the cold side, until the TEC can no longer maintain control. Modeling that same situation in the thermal model can show if the modeled TEC loses control at the same point as the physical test set up.

In correlating the TEC behavior, it is extremely helpful to use registers for all TEC parameters (power input, set point temperature, number of couples, etc.), so that they can be easily modified in the case set manager for different runs.

4.5.5 *General Correlation to Test*

When creating a model to represent a test scenario, it is critical to make sure the actual test setup is properly reflected in the model (see Section 4.1.2). At a minimum, the analyst should compare the model against photographs of the test setup; however, going to the facility to view the test setup in person is best. Items to consider include:

- Environmental conditions (air pressure, humidity, temperature, etc.)
- Location of temperature sensors (ensure that model includes specific placement of sensors, see Section 4.7.1.25 for how to do this in Thermal Desktop™ software)
- View from hardware to chamber or other surroundings (including blockages from shroud penetrations, cables, ground support equipment, etc.)
- Accuracy of facility controls (shroud gradients, lamp spectrum, heater power dissipation, etc.)

Another item to consider when correlating is making sure the analyst has clear records of the timing of critical events such as functional testing and power cycling. These phenomena are often discernible from a review of test data, but having a good as-run test procedure in which times for critical operations are recorded is extremely helpful. It is critical that the time zone or format for time data used in all logs, event registers, and recorded data is well understood. It is preferred if there is a general agreement before test that a single time format will be used by all personnel and facilities involved in the test.

Whenever possible, it is best to use measured values for model inputs such as component power dissipations and emissivities of the surrounding surfaces. This is particularly important for systems which have transient power behavior that significantly impacts temperature (as can be the case with motors). In these cases, it is also important to exercise the system as it will be exercised in flight, to the extent possible. Power is generally the largest driver of temperatures and the thermal engineer should insist on getting this data – vendor specification sheets may not be sufficient. Careful planning at the beginning of a program can allow for the inclusion of current monitors which can be used to get the powers, but the thermal engineer may need to speak up early to claim those resources.

If new ground-support equipment is required for a test, or if the environmental controls are complex, it is critical to perform a characterization test and correlate models to that characterization test data prior to beginning flight hardware correlation. A recent example for the SAGE III on ISS project is that a new system of heater plates was created for the payload-level TVAC test. Prior to performing that test, a characterization test was performed to ensure that the heater plates would provide the required environmental controls. Data from that characterization test was used to correlate the behavior of the heater plates. Performing heater plate correlation prior to attempting to correlate the flight payload's response greatly reduced the uncertainty involved in the correlation of the latter.

Good practices for thermal vacuum test setup, which help to provide good data for model correlation, are described in Section 6.1.7.

 National Aeronautics and Space Administration	NASA Passive Thermal Control Engineering Guidebook	Revision: 4.0
	Date: 9/25/2023	Page 73 of 202
	Distribution Restrictions: Publicly available	Security Classification: Unclassified

At a minimum, correlation to a thermal vacuum test must be performed to two test points; however, three points are better (cold, nominal, and hot – or, hot op, cold op and cold non-op). Ideally, correlation can be performed for balance points as well as transient power-on and power-off scenarios. Developing a good thermal vacuum test profile, including conditions necessary for model correlation, is discussed in Section 6.1.4. The optimal order for performing correlation is discussed in Section 4.5.1.

4.5.6 *Correlation to Tests which use Lamps*

If the test being correlated to used quartz lamps (or other lamps which are “near-IR”, or CalRods) to achieve thermal settings, there are some issues that need to be understood to achieve correlation. The lamps can create an issue for the thermal analysis because a portion of their flux output is in the visible (solar) spectrum, and a portion is in the IR spectrum. The lamps will have an output spectrum that is a Planck curve, and the peak of the output will vary in wavelength as the power to the lamps is changed. Thus, the fraction in the solar and IR varies as the lamp power changes. Normally, lamps will have a specification giving their spectrum at various power levels. If there are materials in the chamber or on the component under test that have a very different emissivity in the IR waveband than the solar waveband (such as silver Teflon® material), their absorption level of the lamp output will be very different depending on the lamp power level. Thus, if the materials are being specified only with IR and solar properties, to model the true behavior within the chamber, a different set of optical properties would be needed for each lamp setting. A higher lamp setting moves the peak of the spectrum farther into the solar range, and changes the material’s absorption of that flux.

There are several different ways to handle this in the thermal model. All of these will depend on knowing accurately the power level of the lamps, and thus the spectrum, for all test conditions that are to be correlated to. One way is to model the lamps explicitly in the model, and perform radk runs in both the solar and IR wavebands. Depending on the power level and spectrum of the lamps, the output would be divided into solar and IR fractions.

Figure 19 shows screen shots from a model that used a fraction for the visible spectrum of the lamps. This model had three different lamp control zones, so there are three lamp runs, one for each zone, with different power levels, and rays shot only from the lamps in that zone. Notice that the lamp can be set to have a time-dependent power (either with a register or within the form), which would allow running a transient. In this example the IR output of lamps was included in the normal IR radk run—a better method would be to have separate additional IR runs where rays are shot only from the lamps.

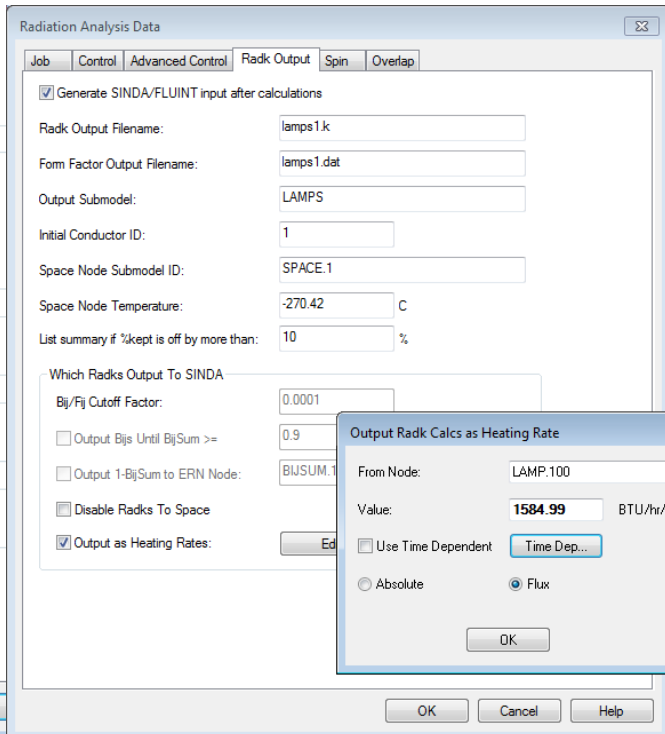
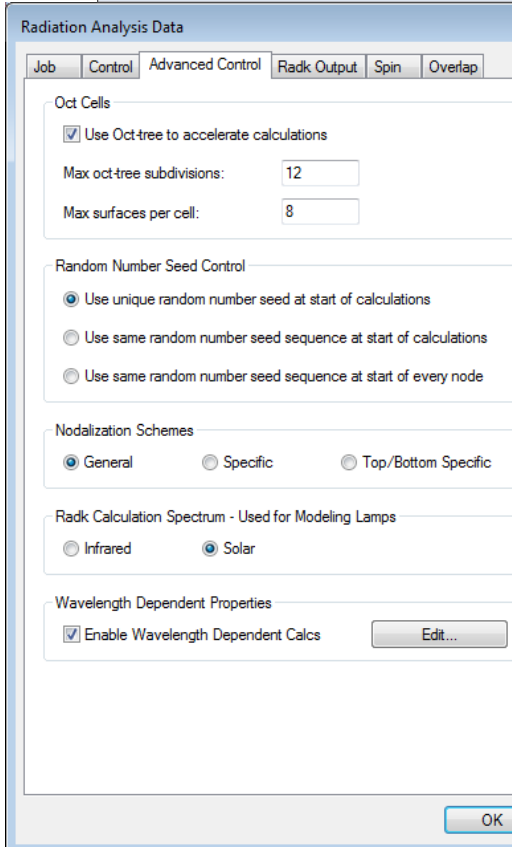
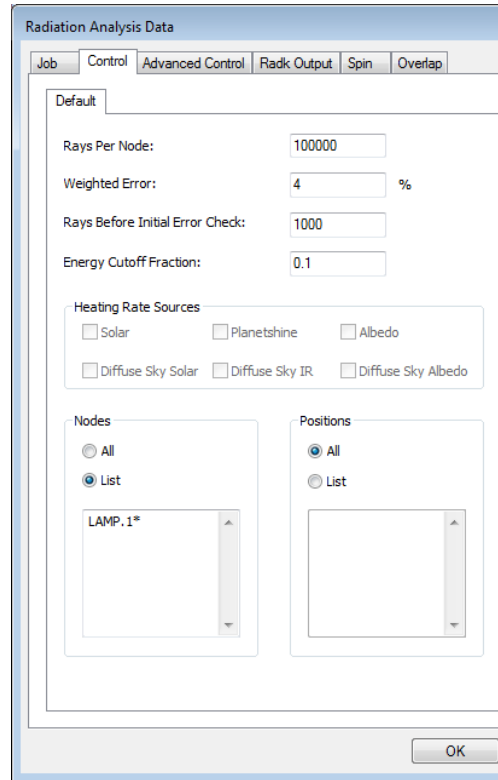
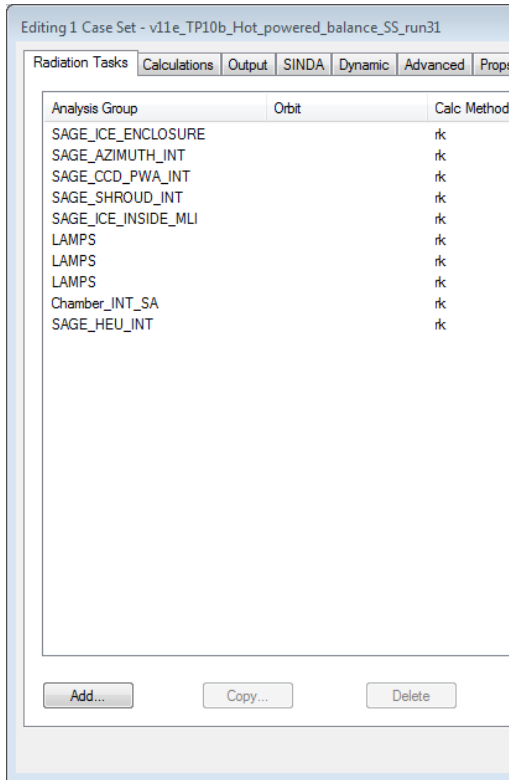



Figure 19. Screenshots of solar/IR fraction method for lamp analysis.

 National Aeronautics and Space Administration	NASA Passive Thermal Control Engineering Guidebook	Revision: 4.0
	Date: 9/25/2023	Page 75 of 202
	Distribution Restrictions: Publicly available	Security Classification: Unclassified

When the lamps are modeled explicitly, several different radiation cases must be run, one for each lamp bank, for each flux waveband fraction. To be accurate, each radiation case with a different lamp setting should use different material optical properties. In addition to requiring more model development time and more model uncertainty, the run times for the model will be several times longer since there will be more radiation runs necessary. Runs of transients if the lamp powers vary become problematic, since the material optical properties will change with the lamp power, which substantially impacts the modeling capability. These issues were discussed in a paper, ICES-2017-171 Correlation of the SAGE III on ISS Thermal Models in Thermal Desktop™ (Ref 8) software.

It is possible to change the test execution so that correlation to transients is more feasible. Normally the spectrum would change as the power to the lamps is increased. However, it would be possible to change the test operation, so that when the control temperature setting is increased, instead of changing the power level to each lamp, more lamps would be activated, each at the same power level. In other words, each individual lamp holds constant power (i.e., temperature and thus waveband) when on, and to change temperatures on the payload the number of powered lamps is changed. Depending on lamps and desired temperatures, it could be possible to keep the lamps at relatively low settings, by having more of them, or by increasing the shroud temperature slightly, and in that way keep the lamps substantially in the IR band. This method could be used to keep the lamp spectrum in a range that the IR properties of the materials would yield a satisfactory analysis.

A completely different method is to run with wavelength dependent properties, and then do the radiation analysis with wavelength bands. For different power levels in the lamps, there would be different wavebands in the lamp output. This method is documented in the Thermal Desktop™ software manual.

It is extremely important to have an accurate power measurement into the lamps, to use the performance curve of the lamps to determine their solar/IR fraction. The lamp control method must allow the lamps to change power steadily and slowly; if the control sensor is too close to the lamps to too light, it will change temperature rapidly when the maps change power, and thus not allow stable control.

In addition to the modeling difficulties described above, the lamp intensity is also variable (lamp to lamp) and it is difficult to get a continuous intensity over a multi-lamp illuminated area. One practical option to assist in characterizing the critical incident heating areas for a test article is to utilize a water cooled pyrheliometer to measure the normal incident radiation (solar spectrum) pre-test at various voltage levels.

4.5.7 Correlation to Flight

When correlating to flight data, one important consideration is to correlate to all the data available. One example is from the Mars Reconnaissance Orbiter (MRO) project; the main intent of the LaRC MRO thermal analysis was to evaluate the heating of the solar arrays during aerobraking at Mars. However, there were trajectory correction maneuvers performed during the voyage to Mars, done for guidance and navigation purposes, which also provided extremely valuable data for thermal correlation. The orientation and thermal data from those maneuvers were used to partially correlate the thermal model well before arrival at Mars. Similarly, many projects do on-pad operations, on-orbit pre-deployment operations and commissioning, and other operations for which some thermal data may be available. Even if the payload or instrument is unpowered, and even if only a limited set of thermal sensor data is available, any events like this provide data that can be used for thermal model correlation.

Another aspect of correlation to flight is that primary consideration should be given to parts of the analysis model that are different between test and flight. In other words, if the payload was correlated to a TVAC test, it should be assumed that differences in flight predictions to flight data are related to orbital and flight

 National Aeronautics and Space Administration	NASA Passive Thermal Control Engineering Guidebook	Revision: 4.0
	Date: 9/25/2023	Page 76 of 202
	Distribution Restrictions: Publicly available	Security Classification: Unclassified

conditions that were not present in TVAC. Only if evaluation of all effects of those on the model have failed to produce a reasonable correlation should there be changes made to the model that would worsen the TVAC correlation.

4.5.8 *Determination of Error*

An important part of any correlation is the determination of error. The determination of error will also depend on the original purpose of the model – whether it is meant to accurately predict physical behavior, or just bound the worst case. A measure of the model correlation quality is necessary, to show how well correlated the model is, or how well it corresponds to what was modeled.

It is normally useful to calculate error in two ways; first, as a root-mean-square (RMS) value over time and second, as an average. The RMS value demonstrates how well the model matches the real data (test or flight), while the average value provides a general feeling of whether the model over- or under-predicts. To generate one simple metric for model quality, the errors (RMS and/or average) can be calculated for each sensor, then averaged for all sensors and to generate a single measure of model quality. Care should be used in using the average value as a measure of model quality, since high and low values can average out to produce a misleadingly low average error value. The RMS error is a more true measure of the ability of the model to predict real-world behavior.

An NESC class, “Determination of Thermal Model Error in Correlation” (<https://mediaex-server.larc.nasa.gov/Academy/Play/a5aebda2422046b9809edd25ec93a5ba1d?catalog=8b40998b-9b64-4987-a2b6-75dc6af48d1e>) is available to view. As a quick summary, some error types are shown in Figure 20. Table 5 shows the description and equation for each type.

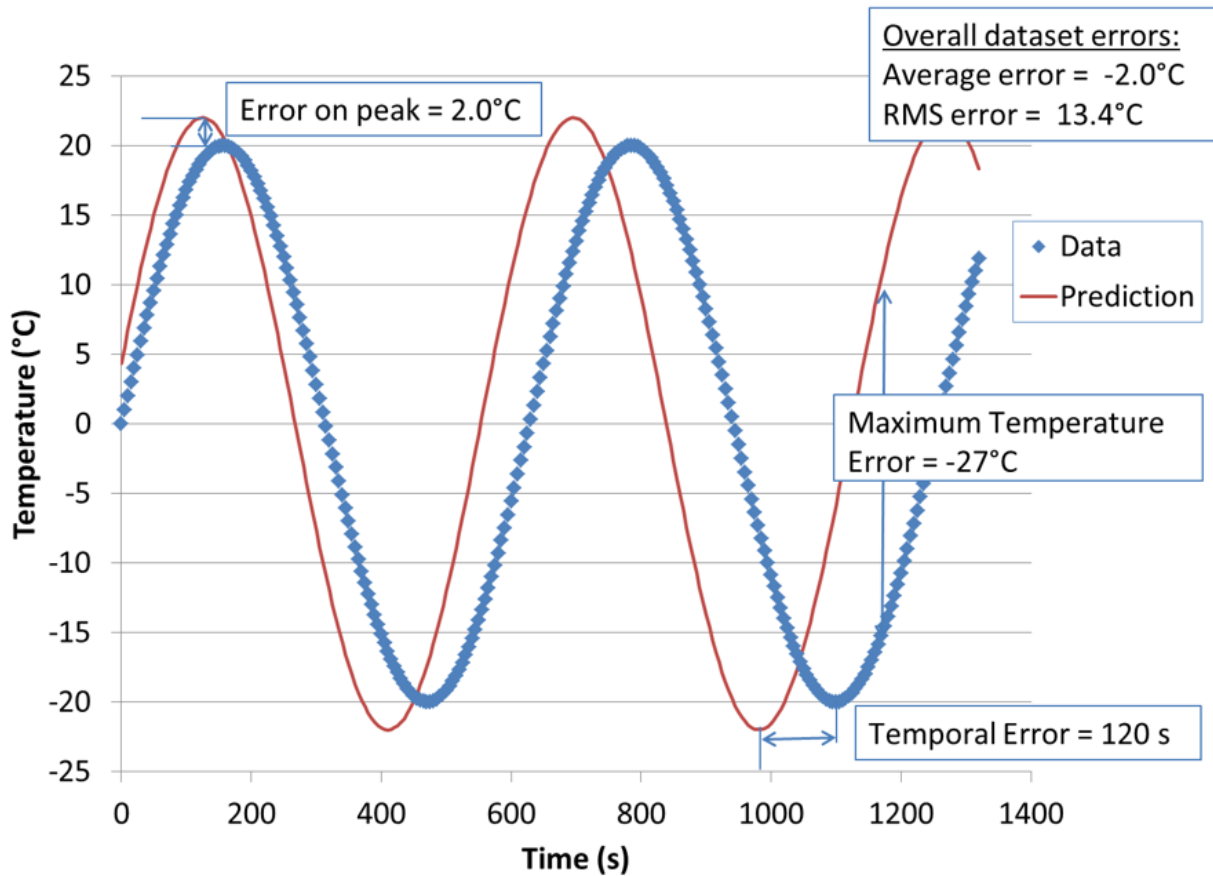

Figure 20. Sample error types.

Definitions of error types are as follows:

- RMS error: the difference between the flight/test data and model prediction, taken at each time point, and averaged using a root-mean-square method. Gives the best overall single measure of the realism of the model over a timeline; the average variation of the prediction from reality.
- Average error: the difference between the flight/test data and model prediction, taken at each time point, and averaged. Can result in unrealistically low values since positive and negative errors will cancel out.
- Error on Peak: difference between the maximum temperature observed in test (or flight) and the maximum temperature predicted by the model. Used in a case where only the maximum temperature is of interest, for example to evaluate a maximum use limit on a component or material.
- Maximum temperature error: maximum difference between the data and the model prediction at any point in time. Used when the ultimate deviation of the model from data is of the most importance.
- Temporal error: the error of the model in time, in other words, how far off it is in the time scale in predicting the response time of the system or component.

- Error in temperature change or temperature delta: the difference between the change in data over a certain event and the change in temperature predicted by the model for that event. Useful where the absolute temperature is not considered of high importance, only the response of the model temperatures to an event.
- Error in temperature difference: the difference between the predicted difference or thermal gradient between two components and the actual difference between those components seen in the data. Useful where the central model criteria is a thermal difference between two components.

Table 5. Descriptions and Equations for Error Types

Error Type	Comment	Equation
Error on peak	For max temperature limit of interest	$\Delta T_{peak} = (T_{test})_{max} - (T_{pred})_{max}$
Maximum temperature error	Worst case difference at any time point	$\Delta T_{max} = (T_{test}(t) - T_{pred}(t))_{max}$
Average error	Misleading due to positive and negative cancelling	$\Delta T_{avg} = \frac{\sum_{i=1}^n (T_{test}(i) - T_{pred}(i))}{n}$
RMS error	Best single measure of model realism	$\Delta T_{rms} = \sqrt{\frac{\sum_{i=1}^n (T_{test}(i) - T_{pred}(i))^2}{n}}$
Average absolute error	Similar to RMS but can be more difficult to work with absolute value	$\Delta T_{abs} = \frac{\sum_{i=1}^n T_{test}(i) - T_{pred}(i) }{n}$
Temporal error	Error in timeline	$\Delta t_{max} = (t_{test} - t_{pred})_{max}$
Error in temperature change (transient)	Temporal response of model to an event	$\Delta T_{chg} = (\Delta T_{test}(t) - \Delta T_{pred}(t))_{max}$
Error in temperature difference (gradient)	Difference between two parts or over a gradient	$\Delta T_{gradient} = \left\{ \begin{array}{l} [T_{test}(x_1) - T_{test}(x_2)] - \\ [T_{pred}(x_1) - T_{pred}(x_2)] \end{array} \right\}_{max}$

To compute error, thermal predictions and data need to be compared at the same time points (and same location in the model). The Thermal Desktop™ Measures software features (see 4.7.1.25) are useful to simulate the thermal sensors in the model, so that the location is correct. Since data and prediction are often not be taken at the same time points, one of them (usually the prediction) must be interpolated to generate the prediction at the required time points. Excel® spreadsheet functions such as VLOOKUP (or, MATCH and INDEX, or TREND) can be used to find the interpolated prediction at each time point where data is available. Some sample correlation files are available on the Agency shared thermal drive. Specifically, in the file Sample_Predict_to_Flight_data_error_determination.xlsm, the ‘Errors’ tab shows the calculation of average and RMS error by computing the predicted temperatures for each sensor at the available flight data time points. This file also shows the example of setting up all the necessary plots in the template document, with the test data, such that when a new prediction is run, the prediction can be instantly refreshed and a new RMS error calculated. FilePlottingTools was used to accomplish this, see section 4.7.1.29.

 National Aeronautics and Space Administration	NASA Passive Thermal Control Engineering Guidebook	Revision: 4.0
	Date: 9/25/2023	Page 79 of 202
	Distribution Restrictions: Publicly available	Security Classification: Unclassified

4.6 Analysis Reporting and Review Process

The processes outlined in this section provide an example of best practices for reviewing and reporting thermal analyses, and are not intended to impose requirements on or to supersede the existing practices of any organization. Formal center processes, where they exist, are listed in center-specific appendices. Note that very general guidance for NASA modeling and simulation can be found in NASA-STD-7009.

4.6.1 *Analysis Review Process*

The analysis review process provides checks on the analysis as the work is being completed, so that errors and/or exclusions can be caught and reworked as the analysis matures. This process should enable analysts to provide a timely and accurate response to the customer's analytical needs. At the initiation of each task, the analyst and supervisor should decide whether to implement all or part of this process, depending on the applicability of the process to a particular analysis.

For minor analyses, the supervisor may waive the need for the process described in this section.

The core of the review process is a two- or three-person team jointly responsible for the quality of the analysis. The team consists of:

- **Analyst** - performs work and documents efforts
- **Concurrent reviewer** - consults with analyst throughout the task and reviews final product
- **Independent reviewer** - is not involved with background decisions and performs an independent review after work is complete. Only used for large or critical projects.

At the initiation of a task, the supervisor and analyst should discuss how the work will be completed. Specifically, the analyst and supervisor should decide whether having two reviewers would add value to the analysis; for an analyst who is competent in a given type of analysis, having two checkers may be redundant.

4.6.2 *Analysis Team Responsibilities*

Each member of the team has parts of the task for which he or she is responsible. The responsibilities of each person will vary depending on how the review process is implemented for a particular analysis.

The analyst is the backbone of the team. In cases where more than one analyst is assigned to a task, the lead analyst on the task would be responsible for making sure that all the tasks listed below are supported.

The **analyst's responsibilities** are:

- Attends initial briefing with the customer where customer needs and expectations are established
- Confers with concurrent reviewer early and often as to analysis approach and assumptions
- Completes the analysis for the customer
- Keeps customer and concurrent reviewer informed on the progress of the task
- Validates models / calculations using some or all of the checks suggested in this document
- Documents final analyses using an appropriate adaptation of the recommended format
- Incorporates comments from reviewers into final documentation and endorses the analysis.

The concurrent reviewer is also responsible for ensuring the quality and accuracy of the analysis. The degree to which the concurrent reviewer is involved in an analysis will vary from project to project, depending upon the analyst's level of experience and the agreement between the supervisor, concurrent

 National Aeronautics and Space Administration	NASA Passive Thermal Control Engineering Guidebook	Revision: 4.0
	Date: 9/25/2023	Page 80 of 202
	Distribution Restrictions: Publicly available	Security Classification: Unclassified

reviewer, and analyst. The concurrent reviewer is most effective when he or she remains engaged on an ongoing basis, rather than only being brought in for a crisis situation. The concurrent reviewer shall discuss concerns directly with the analyst. For projects where the concurrent reviewer does play a large role, he or she may wish to keep track of the time spent reviewing the analysis, and may also want to periodically check the status of the project against deadlines. The concurrent reviewer should not in general be asked to be the formal reviewer at design reviews, because this would leave that person in a situation of critiquing their own work and recommendations.

For all analyses, the **concurrent reviewer's responsibilities** include:

- Confers and concurs with the analyst's approach and initial assumptions
- Is available for questions throughout the task and provides a "second opinion"
- Ensures completeness of analysis to make sure that nothing is overlooked, and
- Reviews final documentation and endorses the analysis.

If the analyst is inexperienced in the thermal field, the concurrent reviewer will also act as mentor and assist in the analysis as necessary. This additional responsibility shall be discussed with the branch head and analyst. The independent reviewer is the third person who is responsible for the quality of the analysis. This reviewer provides the independent check for the analysis by providing a fresh point-of-view. This reviewer would be brought on after the final analysis was completed, and does not need in-depth knowledge of the analysis until beginning the review. The independent reviewer is an optional member of the team, depending on the magnitude and schedule of the project, who may be included at the discretion of the supervisor and the analyst. If project constraints allow, the independent reviewer may be included on the team as a means of training an analyst in a new type of analysis.

If the analysis warrants this third team member, the **independent reviewer's responsibilities** would include:

- Performs independent checks
- Reviews documentation and endorses the analysis.

4.6.3 *Model Peer Review*

Model reviews are very helpful in catching errors and ensuring that the model is at an appropriate level of development. Model reviews should be conducted by an independent reviewer prior to major project milestone reviews such as the Preliminary Design Review (PDR) and Critical Design Review (CDR), prior to integrating a subsystem model with a system-level model, and/or when major modifications to the model are made. It is beneficial, though not required, for the same reviewer to perform model reviews throughout the development of a particular model.

Model review may be customized depending on the type of model and level of complexity; however, listed below are some general actions to take when reviewing a model for accuracy. Instructions specific to Thermal Desktop™ software suite users are shown in parentheses. The recommended method is to compile notes and questions throughout the review in OneNote® notebook or a Word™ word-processing application, and then the model developer can embed answers to any questions within the same document. The document should include the date, name/version of model being reviewed, and name of reviewer. Notes from the peer review should be kept by the reviewer and the project analyst for future reference.

- Check units (in Thermal Preferences) and ensure consistency throughout model.

 National Aeronautics and Space Administration	NASA Passive Thermal Control Engineering Guidebook	Revision: 4.0
	Date: 9/25/2023	Page 81 of 202
	Distribution Restrictions: Publicly available	Security Classification: Unclassified

- Review material properties to ensure reasonableness and check for duplicates (view by material property in Model Browser).
- Check output files for runtime warnings and cautions. Sometimes a model will execute, but warnings/cautions indicate modeling issues that should be addressed.
- View only surfaces that have multi-layer insulation (MLI) and ensure that it looks correct (using that material property in Model Browser).
- Review optical properties to ensure reasonableness and check for duplicates (view by optical properties in Model Browser).
- Ensure that correct symbols are used and that symbols are defined consistently (view model by symbols in Model Browser).
- Check overrides and multipliers for density and conductivity on surfaces and solids.
- Check nodes over-ridden for thermal mass, especially as boundary or arithmetic.
- Perform a model mass check.
- Check for duplicate nodes (unintentionally repeated node numbers).
- Check overlapping surfaces.
- View all contactors, and show contactor markers (Thermal > Model Checks). Note: This may be necessary to do in subsets of the model for a large model with many contactors.
- Check heaters and heatloads; make sure to verify consistent units here, as power is normally input in Watts, but model may be in alternate units.
- Verify that the value input for heat is actually heat dissipation and not power consumption by the unit. These two values are not the same as in the examples of power supply unit or transponder unit.
- Check assemblies/trackers and ensure that the surfaces included are what was intended (view by assemblies/trackers in Model Browser). Check operation of trackers by viewing the model around orbit.
- View model by radiation analysis groups (in Model Browser) and look at the active surfaces in each. Ensure that no extraneous surfaces are present by performing ‘Zoom Extents’ each time. If there are assemblies or trackers driven by symbols, it may be a good idea to place the assembly in one of its potential locations and verify that the radiation groups are still intact (that some part of it did not get left out of the assembly).
- Check logic blocks, including logic used in enable blocks, to ensure they are set up as intended.
- Check orbits for valid parameters.
- In Case Set Manager:
 - Check for reasonable values on A/DRLXCA, DTIMEI (should be 0 except in exceptional circumstances, such as very large models where CSG differences may drive time steps to very small values).
 - Check radiation case sets – radks to space disabled where applicable, space node temperature, space submodel and node number is set as desired, reasonable choices for number of rays, correct orbits used, correct spectrum used, articulating radks where necessary, preferably customized output file names.
 - Check for steady-state versus transient, and sufficient length of transient.

 National Aeronautics and Space Administration	NASA Passive Thermal Control Engineering Guidebook	Revision: 4.0
	Date: 9/25/2023	Page 82 of 202
	Distribution Restrictions: Publicly available	Security Classification: Unclassified

- Check BUILD statement to ensure all desired submodels are included.
 - Check optical and thermophysical property aliases if applicable.
 - Check symbol overrides. Consider use of a check case with all symbols set to global values.
- Execute representative analysis cases, preferably one for each unique configuration or condition.
 - Check all warning messages for contactors and consistent unit usage (including the cc file).
 - View thermal results mapped onto the model. Look for unexpected sharp gradients or unreasonable maximum and minimum values. View the results mapped onto insulation surfaces.
 - View absorbed solar/planetary flux mapped onto the model surfaces and ensure reasonableness.
 - Ensure sufficient rays are fired for Monte Carlo ray trace (MCRT) radiation calculations and that sufficient Radk sums and cutoffs are used to not adversely affect the results. This may be of particular importance for cryogenic designs.
 - Check for convergence and identify any submodels and nodes that repeatedly prevent convergence
 - Check for bad elements and ensure coincident nodes are merged
 - Avoid very high conductances to force two nodes to the same temperature as this can cause convergence problems. If two nodes are intended to be at or near the same temperature, merge them.
 - For an enclosed portion of the thermal model, check the view to space value to verify overlapping surfaces or surface with incorrect active side. In this situation, the view to space value should be close to zero.

A template that can be useful for model reviewers is located on the Agency OneNote® notebook: Model Review Template. The peer review approach and checklist used at MSFC/EV34 is included in Organization Work Instruction EV34-OWI-003.

Following the detailed individual review, it is beneficial to have a group peer review of the model to allow multiple independent analysts to provide input from a big-picture perspective.

4.6.4 *Analysis Report Review*

All reports, informal and formal, should be reviewed by at least one other person within the thermal group. Informal presentations or reports can be reviewed by the concurrent reviewer and need not necessarily be routed through the Discipline Lead or supervisor prior to presentation to the project team.

The reviewer for formal reports, such as those for major project milestone reviews, should be defined by the Discipline Lead or supervisor. Ideally, formal reports should be reviewed by the branch prior to submittal to the project for review, but in some cases concurrent review may be necessary. Branch review must be completed prior to formal project approval of the document.

Presentations to organizations outside of the branch or project should be reviewed by the supervisor or designee. Ideally, a dry run of the presentation will also be conducted prior to the actual presentation.

4.6.5 *Recommended Report Formats*

Analysis reports may be generated in presentation, word processing, or other desktop productivity applications, depending on the maturity of the analysis and project phase. A presentation application format, such as that provided by the Powerpoint® presentation application is typically an acceptable

 National Aeronautics and Space Administration	NASA Passive Thermal Control Engineering Guidebook	Revision: 4.0
	Date: 9/25/2023	Page 83 of 202
	Distribution Restrictions: Publicly available	Security Classification: Unclassified

format for interim results or for informal presentations (within the project and its partners). Word processing documents are typically required for reporting analysis results for major project milestone reviews and at project closeout. It is acceptable to use project or branch document templates.

All reports should include (at a minimum) an overview of the model, the methodology for the analysis, lists of assumptions, representative results, comparison to requirements/limits, and recommendations (including design changes, testing, etc.). Formal reports for milestone reviews or project closeout should include sufficient detail (or provide references in which that detail could be found) such that the analysis could be readily understood by readers in the future and reproduced if needed. Details such as material properties, conductance values, mass, power, environments, analysis case definition, results of trade studies, updates made to the model since the previous formal report, comparison to test data (if applicable), and future work should be included. Final reports should also capture lessons learned.

4.7 Tool-Specific Tips

4.7.1 *Thermal Desktop™ Software Suite*

Each NASA center has been using a full-feature thermal analysis software package or suite of tools, which includes thermal, radiation, orbital and fluid analysis capability licensed from Cullimore & Ring Technologies, Inc. under the “C&R Thermal Desktop®” and “Thermal Desktop™” brand names (sometimes also referred to informally as “TD”). The Thermal Desktop™ software suite is under an Agency-wide contract.

References [1] through [3] were used to assist in the development of much of the information in this section. Specific references are included in some subsections as appropriate.

Readers may find the following NESC Academy short courses helpful for additional insight into general modeling practices:

- Common Thermal Modeling Mistakes – Part 1 (Ruth Amundsen), <https://mediaex-server.larc.nasa.gov/Academy/Play/e496742590e044cf803644e744c7c4441d?catalog=8b40998b-9b64-4987-a2b6-75dc6af48d1e>
- Common Thermal Modeling Mistakes – Part 2 (Ruth Amundsen), <https://mediaex-server.larc.nasa.gov/Academy/Play/3a60a62b347c4afd8f4afa64a137a5af1d?catalog=8b40998b-9b64-4987-a2b6-75dc6af48d1e>

The OneNote® file on the Agency-wide share has a current list of ‘tips and tricks’ in Thermal Desktop™ software, as well as sample code sections for specific functions. Some examples of information available there: logic to create a file for output, logic to define parameters differently for steady-state versus transient, logic for changing units, logic to calculate power required to maintain a given temperatures, determining what node is causing the model to stall, setting node temperature to an interpolated value, symbols and example models to calculate time-dependent orbital parameters, and to interpolate orbital parameters based on beta angle and inclination, and much more.

4.7.1.1 AutoCAD® Software Tips

Below is a list of AutoCAD® software tips and useful commands.

Tips:

 National Aeronautics and Space Administration	NASA Passive Thermal Control Engineering Guidebook	Revision: 4.0
	Date: 9/25/2023	Page 84 of 202
	Distribution Restrictions: Publicly available	Security Classification: Unclassified

- Customize keyboard commands to improve efficiency (see this section in the OneNote® notebook for instructions)
- Add hyperlinks to objects for quick references (CTRL + K)
- Use external references (XREF) instead of INSERT to import models and CAD geometry
- Hold down MIDDLE MOUSE to pan, and SHIFT + MIDDLE MOUSE to 3D rotate view
- Use drag-and-drop to open files:
 - o Drop in AutoCAD® software window to insert file
 - o Ctrl + drop in AutoCAD® software window to open file
 - o Drop with right-click in AutoCAD® software window to XREF file
- In addition to the ENTER key, SPACEBAR may be used to execute a command
- One-Key Shortcuts
- Use TAB key to cycle between commands in command line

Useful Commands:

- Use Point Filters to specify a point in 3D
- Use BURST instead of EXPLODE to preserve block attributes
- Use DIST to measure distance and angle between two or more points
- Use BREAK to create a gap or trim a line
- Use FILLET instead of EXTEND/TRIM to quickly create a corner between two co-planar lines; set radius to 0
- Use LAYWALK to view objects on each layer
- Use PURGE to rid models of unused items (layers, blocks, etc.)
- Use OOPS to undo last erase command
- Use WIPEOUT to mask underlying objects; useful for taking screenshots, etc.
- Use QSELECT to select objects by various criteria
- Use OVERKILL to delete duplicate or overlapping objects
- Use COPYBASE to specify a basepoint when copying objects; useful for pasting to a precise location (use CTRL + SHIFT + V to paste as block)
- Change PICKADD variable to set object selection preference
- Change PICKBOX variable to adjust pickbox size

4.7.1.2 Symbols

Section 4.3.2 has general guidance on the use of symbols. The information in this sub-section is intended to supplement that general information with guidance that is specific for Thermal Desktop™.

The initial values of symbols should be something reasonable, even if those symbols will later be overwritten by model logic, so that on the initial build, the model will have reasonable parameters. It is possible for the initial value to be used before logic defines a better value, which can affect model operation.

It is useful to have power for any powered component be defined as the power multiplied by an on/off switch: e.g., for the box AMP, the power in the heatload form would be defined as $Q_AMP * sw_AMP$. This allows the power of the box to be changed independently of turning it on and off, and also facilitates the use of a power timeline. Units, assumptions, and calculations should be included in the symbol definition notes.

 National Aeronautics and Space Administration	NASA Passive Thermal Control Engineering Guidebook	Revision: 4.0
	Date: 9/25/2023	Page 85 of 202
	Distribution Restrictions: Publicly available	Security Classification: Unclassified

When developing models that will be integrated into a higher-level model, the model integrator should create a template that includes any parameters that are common between models (case definition, location, orbits, etc.) so that each analyst is using the same set of values for case definition. It is very useful to define orbital parameters by case, e.g., worst case hot solar flux, as symbols, since those may change during the program. Changing them in one location is much simpler than changing them throughout all the orbits that have been defined. Details are in this document maintained on an Agency share drive) and also in the OneNote® notebook accessible to NASA users on the Agency share drive — see also section 4.7.1.23.

Symbols should be maintained in separate groups with understandable names that are unique from other symbol groups. It may be useful to group symbols based on type (power, conductance, orbital parameters, etc.) or by submodel (in this case, symbol group names should start with the same prefixes as the submodels). Grouping symbols by submodel is especially valuable if submodels are being created by multiple analysts for inclusion in a higher-level model. Then, if an imported model needs the symbols to be updated, these symbols can be imported simply as a group, without risk of missing any or overwriting others. Also, this practice allows the symbols that correspond to certain submodels to be easily located. The names to be used by each model developer can be defined in advance, and the number should be kept reasonable so that there is not a huge proliferation of symbol groups in the integrated model.

Symbols are very useful for defining different scenarios, such as:

- Hot/cold/nominal environments
- Operational/survival mode
- Min/max/nominal voltage
- Payload translation and rotation
- Turning on/off portions of the model that aren't always present (such as testing chambers)

These symbols can be used in the case set manager in various combinations to define many different unique situations. It is often useful to create a single register to define an overall case (e.g., case_def), and then create a logic block that defines specific values (boundary temperatures, power dissipations, contact conductance values, etc.) that correspond to that case. They can also be used in enable blocks to accomplish tasks such as turning heaters off as needed.

References [1] – [3] provide examples of symbol usage that the reader may find useful. TFAWS papers that describe methods of symbol usage are 2013-TFAWS-IN-002 in the interdisciplinary session here, <https://tfaws.nasa.gov/TFAWS13/>, and <https://tfaws.nasa.gov/wp-content/uploads/TFAWS2015-MM-06.pdf>

4.7.1.3 Notes Block

Each modeler should keep a short list of what basic changes have occurred in the model, and what nodes/conductors/environments are the most critical. For the integrated model, the integrator should keep a list of what version of each imported model is currently used. The simplest location is within the model itself using the command Thermal>Utilities>Notes. This practice allows that information to be kept with the model. Multiple tabs can be used to assist in organization of information.

4.7.1.4 Comment Blocks

For materials, a comment block should be used to give the reference that the data is from, to afford traceability. Similarly for any data or array used, the analyst should give the reference and date for

traceability. For conductors, contactors, heat loads, heaters, etc., the analyst should add descriptive text in the comment block, so that when the full model is assembled, the analyst can peruse a list of contactors or conductors in the Model Browser and easily understand what each one represents. For any assumption made, the documentation should be in the comment (for example, if an assumption is made on contact conductance per area, the rationale for that assumption should be inserted in the comment block). This documentation practice affords not only traceability, but also eases the job of any model reviewer evaluating the model.

4.7.1.5 Submodel Names

Submodel names should allow clear identification of the portion of model they represent. The simplest way to do this is for the first three letters to represent the element they are from. For example, on CLARREO project, the naming conventions used are given in Table 6. Thermal models meant to be integrated into an overall model should not in general contain more than about 25 submodels, unless special circumstances apply. Number of fluid submodels is usually constrained by the system itself (i.e., number of fluid loops), but in general a model should not have more than 10 fluid submodels if it is planned on being integrated with another model.

Table 6. Submodel Name Definition Example

Submodel Element	Submodel name will begin with:
Reflected Solar instrument submodels	RS_
IR instrument submodels	IR_
GNSS-RO instrument submodels	GN_
Spacecraft Bus submodels	BUS_

4.7.1.6 Layer Names

Layers should be named to allow clear identification of the portion of model they represent. In particular, layers that contain only geometry (such as STEP imports) and no thermal nodes or elements should have a name beginning with “Geo”. Layers that contain Thermal Desktop™ software items (surfaces, solids, etc.) should start with “TD”. The next characters in the layer name should define where it is from (e.g., “Geo Spacecraft Bus”). Number of layers should be kept below 50. In general, if a model to be imported contains geometry layers, it is structured such that those layers can be discarded without harm to the thermal model, so that model size can be decreased. In some cases, it may be preferable for the model to be imported with only the TD entities and without the original CAD geometry.

4.7.1.7 Item Names

Individual parts should be named within the model in a comment block, if possible.

4.7.1.8 Radiation Case Names

Radiation cases should be named the same in each submodel that participates in a common radiation exchange case. This must be coordinated (preferably in advance) between the analysts building models that will be integrated together. In general, radiation cases on interior volumes should begin with “Int”, and exterior radiation cases should begin with “Ext”.

 National Aeronautics and Space Administration	NASA Passive Thermal Control Engineering Guidebook	Revision: 4.0
	Date: 9/25/2023	Page 87 of 202
	Distribution Restrictions: Publicly available	Security Classification: Unclassified

4.7.1.9 Expression Boxes

In expression boxes where a calculated number is entered, the entire expression should be written out rather than just entering a number. For example, for the value of a contact using area * conductivity / length, the entire calculation would be in the expression field, rather than just the resultant value. In the comment box, this information is repeated with the justification. This practice allows others to understand where the value came from, and edit the equation more easily if necessary.

4.7.1.10 Geometry Import

There are many ways to import native part and assembly geometry into a Thermal Desktop™ software model. The best method for each specific model should be selected on a case-by-case basis. In general, when the geometry model desired is relatively simple, the direct creation of Thermal Desktop™ solids and surfaces is efficient. When the geometry is more complex, and many features are desired to be maintained, meshing within SpaceClaim® software may be advantageous. If many design changes to a base part are expected, the most effective method may be to use TD Direct™ and SpaceClaim® software, so that remesh of redesigned parts can be accomplished quickly and automatically. Some of these methods are described in a Webinar accessible to Agency users on the NEN website, in the file ‘Thermal Desktop Tips by Ruth Amundsen.mp4’.

Below are some of the methods for creating geometry. These are current as of Thermal Desktop™ 5.8. There is a separate Thermal Desktop™ software manual for handling geometry and model import, which readers may find valuable.

- The simplest is to directly create TD solids and surfaces manually. If the geometry is simple, or still relatively undefined, this can be the best method.
- Utilize the link through TD Direct™ to SpaceClaim® software, and directly mesh a part from a CAD package such as Creo® software. This method is best for complex geometry, where the complexity is important to maintain. It also can be used to maintain a link to native geometry, so that that if a part is changing often, the model can be easily refreshed to the current CAD design. See section 4.7.1.11 for more details.
- Import STEP or IGES file of geometry and snap Thermal Desktop™ software surfaces and solids onto it, using the geometry as a guide. The most efficient method is to maintain separate layers for geometry, so that they can be turned off. This is useful when the base geometry is complex, but can be effectively represented with simple TD surfaces and solids, and is not likely to change frequently (so a dynamic link is not required).
- Import STEP or IGES file of geometry and mesh using Thermal Desktop™ software mesher. There is a separate Thermal Desktop User’s Manual covering use of the mesher. Using SpaceClaim® software will normally be more effective than this method.
- Mesh the Creo® software geometry using other software, such as the Comet™ workspace or Altair HyperMesh® software.
- Import an existing NASTRAN mesh. Details on how to do this can be found in the TD manual. The issue with this method is that both the geometry and mesh will be fixed, so if the design changes, the mesh will have to be re-imported.

 National Aeronautics and Space Administration	NASA Passive Thermal Control Engineering Guidebook	Revision: 4.0
	Date: 9/25/2023	Page 88 of 202
	Distribution Restrictions: Publicly available	Security Classification: Unclassified

- C&R Thermal Desktop® can also directly import models from several other software packages, such as TRASYS, TSS, NEVADA, I-deas™, ANSYS®, Femap™, BETAsoft, and the STEP-TAS format.

4.7.1.11 SpaceClaim and TD Direct

SpaceClaim is a geometry creation tool, and TD Direct is used to tie SpaceClaim into the TD model. SpaceClaim can be utilized to generate geometry or import and simplify (as needed) a geometry that is necessarily more complex than easily generated in Thermal Desktop. The geometry within SpaceClaim can then be imported to/synchronized with Thermal Desktop. There are good tutorial videos available on the C&R website (note you must have a login to this site to view the training videos). There are also training videos available on the Ansys SpaceClaim site. Note that none of these links are NASA or government sites.

- SpaceClaim tutorials: http://www.spaceclaim.com/en/Support/Tutorials/Essentials/SpaceClaim_Basics_Tutorials.aspx
- SpaceClaim step-by-step case tutorial: <https://crtech.com/forum/topic/spaceclaim-geometry-creation>
- TD Direct training part 1 & 2: <https://crtech.com/videos/td-direct-training-part-1>,
<https://crtech.com/videos/td-direct-training-part-2>

4.7.1.12 Surfaces

Where possible, TD native geometry should be used, with an appropriate mesh density. If the temperature at one specific point (say, a thermocouple attachment point) is desired, a “Measure” node type should be snapped on in the desired location. This will allow temperature extraction at that location, independent of whether the mesh changes. If the geometry is too complex for use of TD native geometry, the native geometry part can be imported and meshed using the TD mesher, or meshed in the Comet™ software (see section 4.7.2 for more information). In general, avoid requirements on node numbers, such as one particular node number required to be 1001, to avoid problems when items are remeshed.

When surfaces and solids are meshed, in general, use “Edge Nodes”, which will make application of contactors much easier, as well as allowing merging where desired.

If two surfaces modeled in TD are actually physically fabricated as one contiguous part, use “Merge Nodes” to combine them. Make sure information on this merge is documented in the model notes.

When MLI is used on a surface, it is normally best to use a consistent method or number (or two offsets for front and back MLI) to offset the node numbers with MLI, unless a separate submodel is used. If offsets are used, ensure that non MLI nodes do not use these number ranges for easier identification of MLI vs. non-MLI nodes.

4.7.1.13 Boxes

In general, an item with a box shape should be modeled using a solid brick rather than six separate surfaces. For an item such as an electronics box, where the mass is a known quantity and defined as a symbol, the mass can be input in one of two ways. One is to assign a material with the appropriate density so the box mass is correct, and the other is to over-ride the calculated mass with a symbol. One issue with the second method is that the box mass will not be summed with other calculated masses when the ‘Calculate Masses’ option is used; instead, it will be grouped with other items that have also been over-ridden. Also, the box

 National Aeronautics and Space Administration	NASA Passive Thermal Control Engineering Guidebook	Revision: 4.0
	Date: 9/25/2023	Page 89 of 202
	Distribution Restrictions: Publicly available	Security Classification: Unclassified

cannot be meshed more finely. If both of those are acceptable, then that is the preferred option; simply over-ride the mass calculation on the node by selecting “Over-ride” on the node form, choosing a material and selecting the Mass option. If it is desired to have the masses included with other calculated ones, then the electronics box mass symbol can be used in the density factor box, to allow the mass of the box to be easily changed as the design changes. For example, the box would be assigned a dummy material “Electronics box” with a given density ρ , and then in the density factor for that box, the real mass divided by real volume would be input, divided by the dummy material density ρ , to give the correct density factor for the box.

Use care with insulation on the outside of a box which is modeled as a single node, to ensure that the insulation on each side of the box will have a discrete number, and not be averaged together (unless that is the desired behavior).

4.7.1.14 Duplicate Nodes

It is normally better to avoid duplicate nodes in a thermal model. One advantage is that, if there are no duplicate nodes in the model, then the check box can be used in the Case Set Manager, to prompt if duplicate nodes are found in the model. Thus, if a user has inadvertently created duplicate nodes by adding a surface and neglecting to renumber, the program will prompt the user to renumber the nodes, exit the case set manager, or allow the duplicate nodes. If duplicate nodes are left in, there may be items at very different locations and temperatures that have the same node number, which can be very confusing in evaluating the results. Some users utilize duplicate nodes purposefully, to combine or average the results from a subgroup of nodes. There are almost always better ways to achieve these goals than using duplicate nodes; node correspondence, clone nodes, contacts between parts, boundary nodes and more can all be useful.

Sometimes there are nodes that fail in a given run, because they have no connection to a boundary node in a transient run, such as a node that is dependent on radiation or convection, for a case where that radiation or convection is not included for some reason. Some users utilize duplicate nodes in this case, to avoid the error. But this leads to the issue already mentioned, that then the user must allow duplicate nodes when prompted, which will then allow inadvertent duplicate nodes in the model. A better process for dealing with nodes that are failing because of lack of connection in a certain run is to change those nodes to more accurately reflect the true physical situation, such as adding contactors to represent physical contact.

Users should always use the TD function ‘Model Checks > List Duplicate Nodes’ to identify any duplicate nodes in a model.

4.7.1.15 Assemblies

Assemblies can be very useful for handling groups of entities together. On SAGE III, assemblies were used to change the orientation of the Dragon® reusable cargo spacecraft, IP, and NVP submodels. This allowed the motion of parts relative to each other for different scenarios; e.g., for SAGE III., at one point the payload was mounted in the Dragon® spacecraft trunk, for another case it was mounted to the ExPA transfer platform, and for another case it was mounted to ELC-4. Assemblies made it easy to move and rotate one section of the payload relative to others. This also allows easy incorporation of orbits, which may assume the entire payload is oriented in a certain direction; the assembly can include symbols that define the correct orientation for each case. Figure 21 shows an example of the different assemblies. When attaching objects to assemblies, ensure that the nodes are attached for finite elements (since

 National Aeronautics and Space Administration	NASA Passive Thermal Control Engineering Guidebook	Revision: 4.0
	Date: 9/25/2023	Page 90 of 202
	Distribution Restrictions: Publicly available	Security Classification: Unclassified

elements are defined geometrically by their nodes) as well as any measures that should move with the attached geometry.

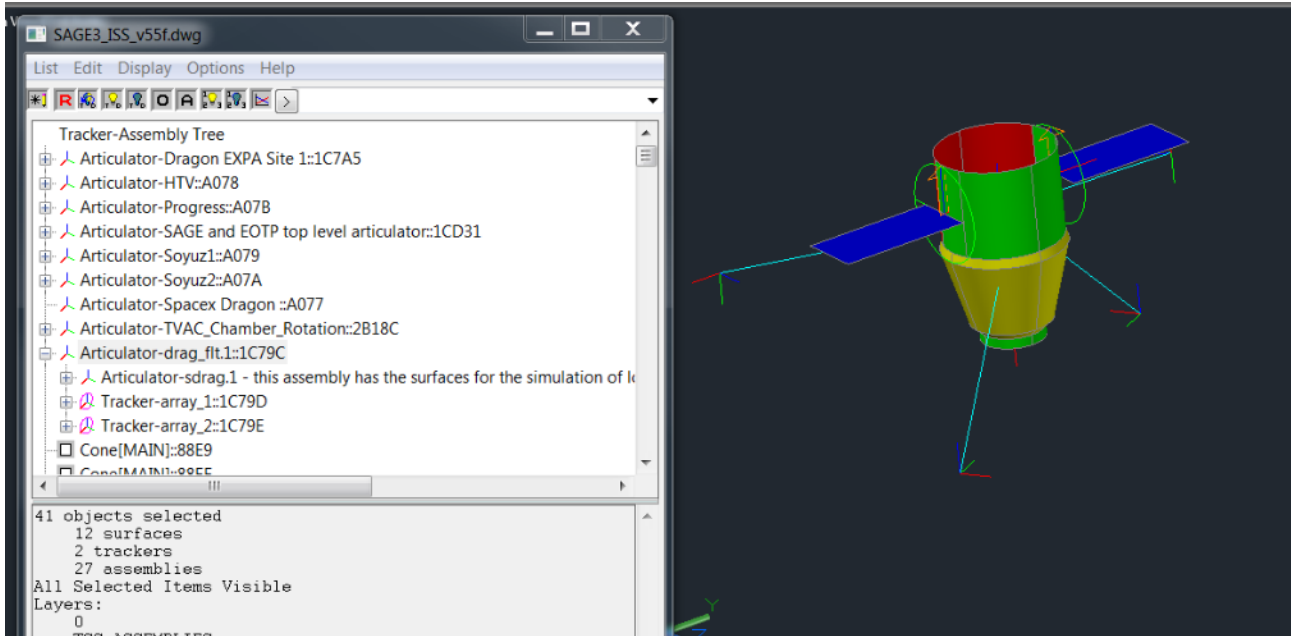

Figure 21. Sample of SAGE III assemblies.

By nesting assemblies and articulators, many different configurations can be simulated easily in a single model. This is documented in 2013-TFAWS-IN-002 -- available in the interdisciplinary papers at this link: <https://tfaws.nasa.gov/TFAWS13/>.

By nesting articulators on SAGE III, the analysis team was able to simulate:

- Motion of NVP/IP
- Motion of EOTP
- Motion of Dragon
- Translation of the payload down the trunk of the ISS
- Steps of robotic installation and transfer from Dragon to ELC-4.

In this case, two payloads that were assembled together on-orbit, the NVP and SAGE IP, were kept in separate assemblies and could be manipulated independently. A single variable was used to control the position of each one, but that single variable (Flag_SAGE_mov and Flag_NVP_mov) was referenced in the translation and rotation settings for several of the assemblies. For example, for the symbol Flag_SAGE_mov, values could be:

0 = On ELC4, 1 = In Dragon, 2 = outside Dragon on EOTP,
3 = at w-5 on EOTP, 4 = at w-2 on EOTP, 5 = EOTP near ELC-4

Then some example logic in the articulator translation and rotation blocks would look like this:

E.g.: $(\text{Flag_Sage_Mov} == 0) ? 0 : ((\text{Flag_Sage_Mov} == 1) || (\text{Flag_Sage_Mov} == 2) || (\text{Flag_Sage_Mov} == 3) || (\text{Flag_Sage_Mov} == 4) || (\text{Flag_Sage_Mov} == 5)) ? 33.2 : 0$

 National Aeronautics and Space Administration	NASA Passive Thermal Control Engineering Guidebook	Revision: 4.0
	Date: 9/25/2023	Page 91 of 202
	Distribution Restrictions: Publicly available	Security Classification: Unclassified

4.7.1.16 Domain Tag Sets

Domain tag sets are a way to “tag” groups of geometry that will be used together. For example, if there is a box base that will be in contact with a mounting plate, the base of that box can be added to a domain tag set, and the domain tag set used in the contactor. The advantage is that many different items can be added to the domain tag set, and the contactor doesn’t go away even if all items are removed from the domain tag set. Thus, the contactor can be developed with domain tag sets on both sides, so that as more is known about how the payload is configured, items on both sides of the contactor may be changed by adding and taking away from the tag sets, but the contactor remains the same. In addition, domain tag sets persist across model xref imports as well as when inserting one model into another, described in section 4.7.1.16. Thus, if one portion of a vehicle model is imported into another using an xref, a contactor for the contact between the two portions of the vehicle can be built using tag sets, and thus the contactor between the vehicle parts will be maintained even if only one of the models (and thus one side of the contact) is present. Another advantage is that domain tag sets can be defined in the base geometry in a program like SpaceClaim®/TD Direct™ software, and thus the tag set will define where the item is to be mounted, no matter how the item is meshed or how its shape changes.

4.7.1.17 Xrefs and TD Block references

Import of one TD model into another can be a laborious process (see section 4.7.1.39), with many possible pitfalls. In many situations, there are thermal models that must be combined, for example:

- Several instruments on a spacecraft
- An instrument in a TVAC chamber
- Two segments of a launch vehicle
- A spacecraft in a booster

In these cases, it is likely that each of the models will be developed and refined by separate groups of analysts. If the models (such as the instruments onto a spacecraft) are integrated using a direct model import, then there is no easy way to break the instrument models out separately to work on and refine them, and to run them alone for their own functional and TVAC testing. One way to handle this type of situation is using xrefs (external references) which is described in the TD manual (In TD 5.8, this is in section 19.8 of the TD manual). By using xrefs to combine two models, the models can be combined and run together, with common radiation groups, cases, contacts and logic. But, each of the models can also be run separately. In the case of a spacecraft with several instruments, the instrument models can be xref-ed into the spacecraft model. Thus, the entire spacecraft model can be run for spacecraft level TVAC cases and launch/flight cases. However, each of the instrument models remain separate, and can be run separately for their own functional and TVAC testing, and correlated and updated as necessary. When an updated instrument thermal model is made available, the xref is simply changed to pick up that model version instead. The same option can be used for a TVAC chamber that handles testing of many different instruments; the instrument thermal models can simply be brought into the chamber model via xrefs. For these reasons, use of xrefs can be advantageous over model import for models where one entire system or subsystem is imported into another. Another use of xrefs can be when different parts or systems are developed by different organizations, and perhaps on different schedules; xrefs allow the models to be combined without the models needing to be at the same level at the same time, and they can remain separate for work by their respective organizations. Conversely, use of xrefs does not allow for any modifications to be made to the referenced model from the higher level of assembly other than through symbols, aliases or other features that can be over-ridden. Thus, changes to the model that is pulled in

 National Aeronautics and Space Administration	NASA Passive Thermal Control Engineering Guidebook	Revision: 4.0
	Date: 9/25/2023	Page 92 of 202
	Distribution Restrictions: Publicly available	Security Classification: Unclassified

via xref must be made in that model; but those changes seamlessly transfer to the higher level model. Some additional advice for doing this is on the Agency shared thermal drive at Using xref'd drawings.

An improvement on xrefs that is now available in TD is TD Block references (in TD 5.8, this is described in section 19.8.8 of the manual). Advantages of TD Block references over xrefs are that a model can be brought in multiple times (for example, a spacecraft that has multiple identical assemblies), and the logic from the referenced model is included automatically. There is also a command called TdImportXREF, which can make it easier to import properties, materials, symbols, and case sets. This command works for both regular XREFs and TdBlockReferences; the command brings up a form similar to the import form for properties, where the logic blocks, properties, symbols and case sets can be brought over from the reference. The user selects which to bring over, and any conflicts bring up a resolution window.

4.7.1.18 Contact/Contactors

Section 4.2.4 has general guidance on contact conductance and calculating thermal resistance between two entities. This section specifically addresses how to apply contactor boundary conditions in Thermal Desktop™ software.

Except for special circumstances, contactors should be used for contact rather than the Contact tab, or conductors, or specialized code in a conductor data block. The best practice is to consolidate groups of contactors, conductors and ties where possible. In other words, if there are eight surfaces with similar ties to the same fluid lump, or eight boxes that all contact one surface, the contactor or tie should be accomplished with a single form (with a descriptive comment), rather than on separate forms. Again, this practice streamlines the model, and allows the model to be understood and modified more easily. If it is necessary to include a radiative connection but a radiation group cannot be created, then contactors can be used instead by checking the “Radiation” box on the contactor form.

In order to ensure that the contact reflects reality, it is important to ensure that the “from” surface(s) have a smaller surface area than the “to” surface(s). Otherwise, conduction will occur from the entire “from” surface(s) rather than just the portion in contact with the “to” surface(s). Contactors can be defined as edge or face contactors. When using edge contactors, a thickness multiplier must be included which represents the thickness of the surfaces in contact.

Contactors can be defined as areal (conductance per unit area) or absolute. If using areal conductance it is important to make sure that the surfaces selected represent the actual contact area. If applying one contactor to multiple parts using an absolute conductance (such as 4 bolted joints with the same conduction path), it is critical to multiply the conductance value by the number of parts. Scale factors can be used to create contact only at specific points along a surface. This can be useful in situations where the contact point only represents a small portion of the total surface (such as a bolted interface).

When creating the model, meshing of the parts must be fine enough to allow for correct contact. Caution must be used when the model utilizes center nodes instead of edge nodes. Edge nodes give accurate contact with no corrections needed, while the presence of center nodes necessitates adjustment to account for the thickness of the material, as illustrated in Figure 22. Note that the Thermal Desktop™ v6.0 software suite includes an option to include the effect of material between centroid nodes and the contacting edges, but this cannot be saved to previous versions.

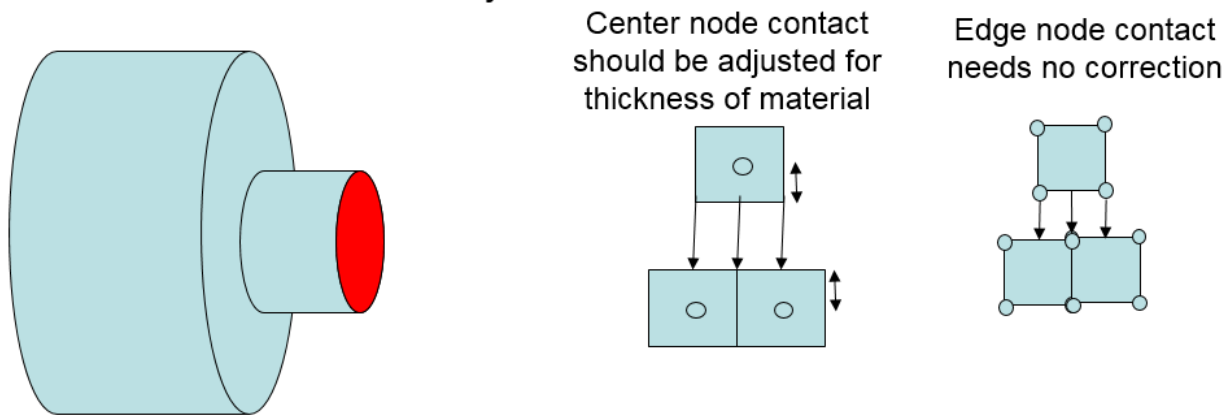

Figure 22. Center nodes vs. edge nodes.

It is critical to perform a check of contactor markers (“Thermal/Model Checks/Show Contactor Markers” or right-click on the contactor in the model browser and select “Show Contactor Markers”) to ensure that the correct parts are in contact in the way that was intended. Figure 23 provides examples of meshes of “to” surfaces that are too coarse to allow for correct contact. Figure 24 provides an example of the correct way to select “from” and “to” surfaces (on the left, with the “from” surface area less than the “to” surface area) in comparison with the incorrect approach (on the right). Figure 25 shows an example of a contact that utilized scaling to create contact only at the desired points, to represent a bolted interface. If there are significant issues with the contactors, then a message file will be created that provides warnings and this file should always be reviewed if it is created.

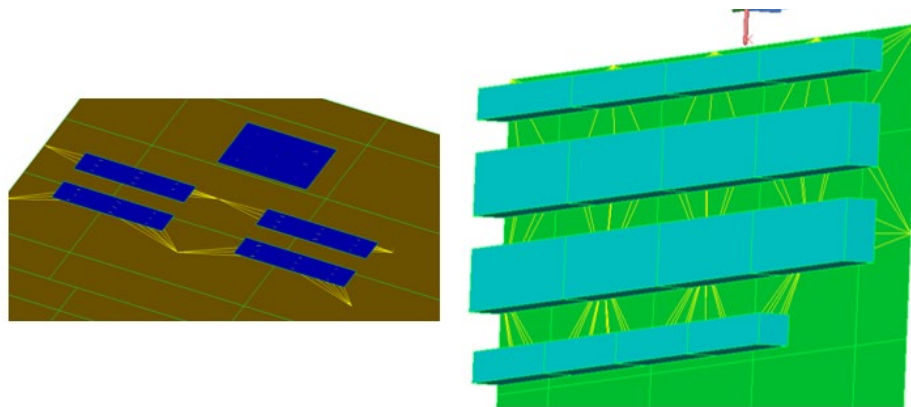

Figure 23. Insufficient mesh density for correct contact (yellow lines indicate contactors).

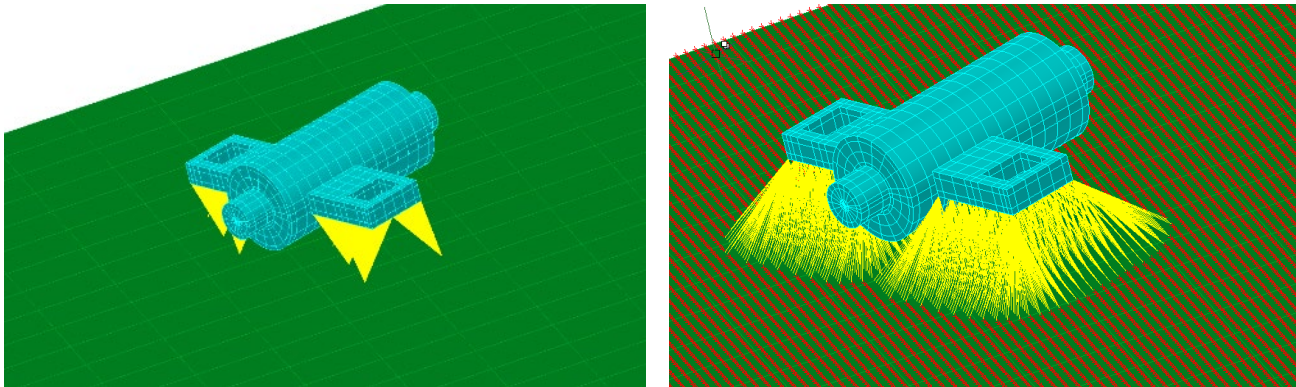

Figure 24. Correct (left) and incorrect (right) selection of “From” and “To” surfaces.

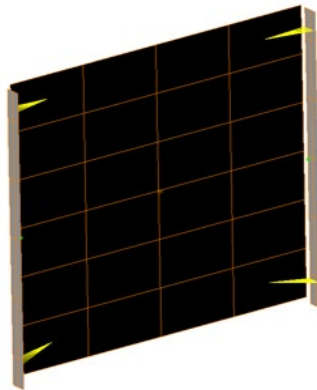



Figure 25. Use of scaling along distance.

4.7.1.19 Heaters and Heat Loads

Below are some tips for using heaters and heat loads:

- When heaters are input, use a register append string that characterizes the heater (rather than the default string). For example, the heater register append string for an operational heater on “box1” might be “_OP_BOX1_HTR”. This facilitates debugging and working with heaters.
- If an absolute heat load is applied across multiple parts, remember to multiply the heat load value by the number of parts. For example, if there are 5 parts that each dissipate 10W, the heat load form would include the symbol for the 10W heat load multiplied by 5.
- It is simpler to use a register for a heat load and define a time array than to use the time-dependent option on the heat load form.
- If a heater is disabled in the enable block then it will not be built; therefore, any logic that uses those heater variables must also be disabled. For example, if there is logic in the model that calculates duty cycle based on the registers created for each heater, if one heater is not built, its registers will not be created, so any logic that uses the registers for that heater will fail. In general,

 National Aeronautics and Space Administration	NASA Passive Thermal Control Engineering Guidebook	Revision: 4.0
	Date: 9/25/2023	Page 95 of 202
	Distribution Restrictions: Publicly available	Security Classification: Unclassified

it may be better to use a multiplier of 0 or 1 to enable or disable a heater, as this will still allow logic to represent the heater, even if zero power is applied.

- If the off temperature of a heater is set lower than the on temperature, the model will apply negative heat to try to reach the set point
- If the heater is set in steady-state to hold a temperature, it may use more power than is truly available. Since the implementation of the “Set to Mid Point” option is to hold the sensing point as a boundary, it may be applying heating (or even cooling) at the sensing location rather than the application location. Use of the Damped Proportional option is recommended for steady state heater modeling. However, it is always best to run transient cases when heaters are present. The steady state Proportional option can be used to provide information on how much power the heater needs for the given set points.
- If PID controllers are used for heater control, there are some subtleties in using them; interested users can see details in the TD manual, and NASA users can refer to the Agency OneNote® notebook at PID controllers.

4.7.1.20 Modeling TECs

The TEC option is a very handy function in TD. These are displayed in the Model Browser in the same list as contactors. To create one, first create the hot side and cold side surfaces, and then select the TEC option to create a TEC between the hot side and cold side. The item to be cooled can be attached to the cold side, or the dissipated heat can just be added to the cold side as a heat load. The power input to the TEC will be calculated by the software (invisible to the user, the program uses TECINFO, TECUNITS, TEC1 and TEC2, but the user should never have to delve into those—if needed, they are described in the SINDA/FLUINT software manual). Many registers are available to check on the operation of the TEC; these are described in the TD manual and also on the Agency OneNote® notebook at Using a TEC in TD model. A good reference is available on the Agency shared drive at Modeling and Sizing TECs. In addition, see section 4.5.4 for correlation with TECs, and section 5.9.

4.7.1.21 MLI Modeling

If a single MLI blanket covers multiple surfaces at different temperatures, then the “insulation” tab should not be used. Instead, the MLI must be modeled explicitly as a separate surface in order to obtain correct radiative heat transfer.

When modeling MLI, a visual check should always be performed to ensure that the thermal response appears to be reasonable.

4.7.1.22 Radiation Analysis

After setting up a model and before attempting to run analysis cases, the “Thermal/Model Checks/Display Active Sides” function should be used to ensure that the radiation calculations are set up as intended. Using this check allows the analyst to clearly see which surfaces (and which sides of those surfaces – note that which side is “top” may not always be intuitive) are included in each radiation group. To check multiple radiation groups, set one group at a time to the default group using “Thermal/Radiation Analysis Groups” and check the active sides, then repeat the process for the next group. Furthermore, the Model Browser can be used to display only surfaces in a specified radiation group. This can identify any stray surfaces that should not be included or missing surfaces that were excluded.

In some cases, it is necessary to manually add a boundary condition for radiation between two surfaces. If this approach is used, the surfaces involved must be designated as inactive in the radiation calculations.

4.7.1.23 On-Planet Modeling

For modeling on a planetary surface using TD, the “orbit” should be defined using the planet surface location option, where the orbit uses planetary latitude/longitude/altitude. This can be used for on-surface analysis on any planet or the moon, as well as for low trajectories or travel paths on the planet or lunar surface. One item to note is that when the radiation cases are defined, this requires an additional radiation case with radiation to a node at absolute zero to allow the correct net calculation of planetary (or lunar) heating; the TD manual gives more detail on this. The additional heat sources that are available in this option include: diffuse sky solar radiation, diffuse sky IR, diffuse sky albedo, and planet/lunar IR. For a transient run it is best to have transient data for these inputs. Some data sources for these include the North American Regional Re-analysis (NARR) and the National Solar Radiation Database (NSRD). See also section 4.4.1 for where to find this information. A sampling of these types of inputs is shown in Figure 26. Note that TD also includes ASHRAE® data for atmospheric extinction of the solar components.

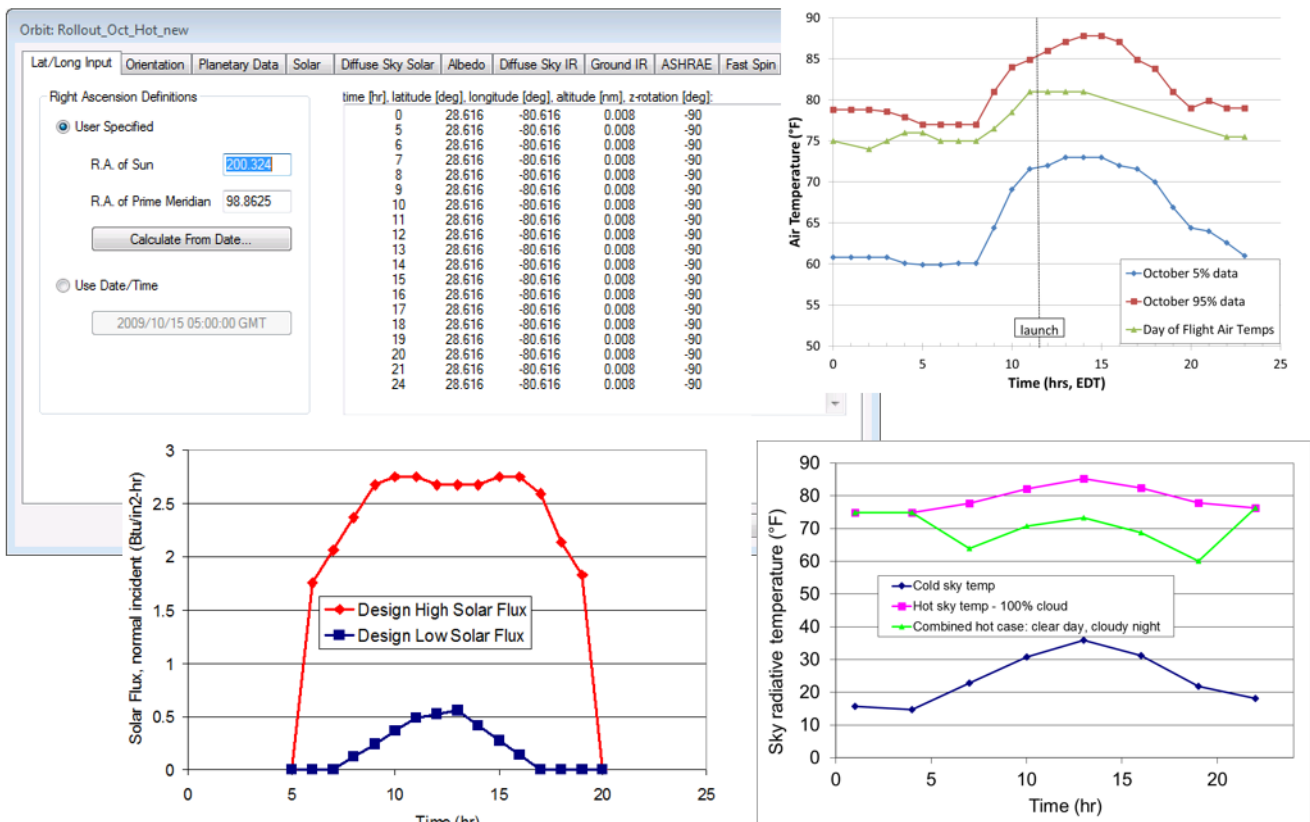



Figure 26. Samples of transient planetary/solar data.

Note that when doing the analysis in this way, the entire planet/lunar surface will be assumed to be a uniform temperature (although it may change with time, it is constant over distance). This is normally a valid assumption. However, there may be cases where the variation in temperature over the planet/lunar surface is important, for example when a part is sitting in the lunar dust in the shade of a lander, or any case where the local surface shading is important. If the shadowing effect on the surface, and the resultant

 National Aeronautics and Space Administration	NASA Passive Thermal Control Engineering Guidebook	Revision: 4.0
	Date: 9/25/2023	Page 97 of 202
	Distribution Restrictions: Publicly available	Security Classification: Unclassified

gradient of planet/lunar surface temperature is important, then the planet surface must be constructed in the model with representative material properties to simulate the surface temperature in varying shade/sun conditions. For more information, see this paper, <https://tfaws.nasa.gov/TFAWS08/Proceedings/Papers/TFAWS-08-1017.pdf>.

For on-surface modeling on the Moon, see also the Lunar Thermal Analysis Guidebook, available as a PDF and with explanatory slides on NTRS: <https://ntrs.nasa.gov/citations/20210010030> and <https://ntrs.nasa.gov/citations/20210019919>.

For analysis on any planetary body, the JPL Horizons site can be used to create an ephemeris file that can be translated into a TD vector orbit; instructions are on the Agency OneNote.

4.7.1.24 Orbits

When setting up orbits, it can be useful to use registers for common parameters such as altitude, solar flux, albedo, beta angle, etc. This gives the analyst the option to change orbit altitudes easily, to vary parameters between hot and cold cases, or to run a parametric on orbit parameters form an Excel spreadsheet. If the item modeled has parts that articulate over the course of an orbit, causing meaningful change in the radiation, then articulating radks should be run rather than steady-state (this will run the radiation conductors at each orbit step, similar to how the orbit heat rate runs are done). Since the RadCAD® software runs can utilize multiple processors, if the computer this is run on has multiple processors, adding articulating radks will not be too detrimental to run time. If there are moving parts, the analyst must ensure that the orbit time steps are appropriate to capture the movement with sufficient fidelity.

If it is necessary to interpolate the planetary environment values given in the *Spacecraft Thermal Control Handbook* for beta angle, there is existing code and symbol groups available on the Agency OneNote® notebook to accomplish this, and also in this document on the Agency share drive. This code, implemented in the TD model, will interpolate to give the correct orbit flux parameters based on the orbit inclination and beta angle.

4.7.1.25 Time-Varying Orbital Parameters

In certain cases, in particular if there is some modeled portion that has an extremely small thermal mass, and changes in temperature rapidly around an orbit, it may be necessary to vary the orbital parameters over the timeline of a single orbit. This was originally a requirement in an ISS document (SPP 57003). Code was developed at NASA LaRC for SAGE III on ISS in order to perform this required analysis. This uses arrays to represent the timeline and changing values for both Earthshine and albedo over the course of an orbit. The interp function was used to determine the time-dependent symbol values for each parameter (albedo and Earth IR) for each of the cases. For example, this function was used in the TD model to interpolate within dual arrays of times and albedo values to produce the correct albedo value at the given orbit time:

```
interp(albedo_times_hot,albedo_values_hot_extreme_B,hrTime).
```

The symbols and logic that accomplish this have been made available to all NASA Centers on the Agency-wide share drive OneNote® notebook.

On the SAGE III on ISS instrument, a situation arose in flight where a part was overheating during only certain times of year. It was determined that the part was overheating during the period of time in the year with the lowest Earth-Sun distance. The change in distance from nominal is only about 2% (since the Earth's orbit is low eccentricity), but this can lead to a 4% change in solar flux from nominal (8% swing

 National Aeronautics and Space Administration	NASA Passive Thermal Control Engineering Guidebook	Revision: 4.0
	Date: 9/25/2023	Page 98 of 202
	Distribution Restrictions: Publicly available	Security Classification: Unclassified

from high to low). An equation that can be used for calculation of that distance based on the day of the year is:

$$\frac{d}{AU} = 1 - 0.01672 * \cos(0.9856 * (day - 4))^5$$

where d is the Earth-Sun distance in AU, and day is the count of days from January 1. This can be used manually to calculate the change in solar flux, or programmed into the thermal model. This will not need to be done for most models, but can be useful if a part is very sensitive to direct solar flux level, or albedo flux.

4.7.1.26 Measures

Measures should be created for all locations where flight or test temperature sensors will be placed; their use greatly simplifies the ability to track their predictions and to compare with actual data. It is good practice to create at least one separate submodel to house all of the temperature sensors. Depending on the number of sensors, it may be useful to create a temperature sensor group for each submodel (“TC_SubmodelName”) or for each test (“TC_PayloadTVAC”).

4.7.1.27 Logic Manager

All logic should be kept in general TD Logic Manager blocks, rather than in blocks specific to each case. As required, symbols can be used to turn on and off certain blocks of logic, but placing them within the case sets themselves is unwieldy once the model is imported to an overall model.

4.7.1.28 Case Set Definition

Case sets should be used to define all possible scenarios in a model. There are several best practices to follow to allow the case set manager to be as effective as possible:

- It is best to limit symbol over-rides within the case set. In general, switching between a hot and cold case (or nominal, or other) should be a matter of changing a single symbol (flag), which will change all necessary parameters, usually within a logic block or via logic in the symbol manager. For cases with orbital heating rates, it may be also necessary to change the radiation case for the orbital heating. For models where the optical properties are altered between hot and cold case, the easiest method may be to use an alias (e.g., “Radiator”) for the optical property, and assign that alias to either Radiator_BOL or Radiator_EOL properties depending on the case. In that way, the hot and cold case property definition can be handled within the case set. Alternatively, the entire property database can be over-ridden with hot case and cold case (EOL/BOL) databases of optical properties.
- In the same vein, it is best to avoid custom operations blocks, because this makes multiple case editing difficult, and also hides the logic that another model user may need to understand. For similar reasons, it is best to avoid external file inserts, and avoid custom code in any SINDA block within the case.

 National Aeronautics and Space Administration	NASA Passive Thermal Control Engineering Guidebook	Revision: 4.0
	Date: 9/25/2023	Page 99 of 202
	Distribution Restrictions: Publicly available	Security Classification: Unclassified

- Logic in the symbol manager can be used to set many of the parameters to vary automatically based on a single flag. For example, heating rates, voltage levels, heater set points, etc. can all be set to change based on a flag that defines if this is a hot case or hot case. Then in the case set manager, that single flag sets many parameters correctly for that case. More details are in this TFAWS 2015 paper, <https://tfaws.nasa.gov/wp-content/uploads/TFAWS2015-MM-06.pdf>. Thus, the model might include a small set of registers that fully control the case definition. Parameters such as initial temperature, heater voltage, and power dissipation would be controlled by the type of case such as hot/cold, location, flight scenario, TVAC case (balance or functional), and special scenarios (plume heating, parked trackers, etc.).
- Flags can be used not just in case sets, but also in logic blocks (but if only used in a logic block, ensure the symbol is set to output to SINDA), and enable blocks to set up the desired scenarios. Flags can also be used in the definition of motion of assemblies and trackers, to change or move configurations based on the case flags (see section 4.1.15).
- As an example, the SAGE III system-level model contained ~250 cases. Each group of cases had a common run directory. This made it easy to update the run directories when the model version is changed. It also minimizes the necessity to re-run radk cases for new analysis runs. TVAC cases were grouped separately from flight cases since they often had very different parameters and were rarely run together. The naming of case run directories was defined by model version, payload location, and hot/cold case (i.e. v55_runs\ELC_hot, v55_runs\EOTP_cold). This kept the cases organized in a way that was easy for multiple users to understand.
 - Register flags were used to define the scenario
 - Hot/cold/nominal, operation/survival, voltage range, etc.
 - Flags were used in case sets, logic blocks, and enable blocks to set up the desired scenarios
 - Case_def (values 0, 1, 2, and 3) were used to represent cold, nominal and hot cases and control boundary conditions and component power dissipations
 - Flag_NVP_MOV and Flag_SAGE_MOV were used to define the position of the payload (Dragon® reusable cargo spacecraft, EOTP, ELC)
 - Flag_voltage set voltage to minimum or nominal
 - Flag_IP_TVAC and Flag_TVAC_6x6 were used to specify TVAC cases
 - Flag_survival and Flag_transfer were used to define scenarios with survival heater power only or no power during transfer from one location to another
 - Flag_plume_heat and Flag_park_port_SARG defined special scenarios
 - Register flags were used:
 - In Enable blocks to turn powers & contact on/off
 - In logic to define heater & power values based on voltage, operational scenario, MLI conductance, operational timeline, etc.
 - Multiple arrays defined for instrument science timeline
 - In Excel® applications; too complex for register-only action

 National Aeronautics and Space Administration	NASA Passive Thermal Control Engineering Guidebook	Revision: 4.0
	Date: 9/25/2023	Page 100 of 202
	Distribution Restrictions: Publicly available	Security Classification: Unclassified

- Different arrays activated by flags
 - Allows many different scenarios to be run by simply defining 2 or 3 flags in the case set
- If there is a need to run many different cases based on changes to one, two or multiple variables (such as a sensitivity study, or a beta angle sweep), the best way to accomplish this is often to use an Excel® software file with the various cases defined by symbol values, and select the “Drive Symbols by Excel” checkbox in the Symbols tab of the Case Set Manager. To maintain model traceability, it is then important to transfer the external Excel® software file with the model. If there are multiple cases of this type, they can be done using multiple tabs in the same Excel® software file.
- If logic during a case will be used to change the value of a register during the run, it is important to ensure that the symbol can be changed. Two settings are required to accomplish that. In the symbol manager, when the symbol is defined, the box “Always Output Thermal Desktop Symbol as SINDA Register” should be checked. In addition, in the form where the symbol is used, the box “Output Above Expression to SINDA” should be checked. This ensures that the register will be used, as a variable, in the file for thermal solution, rather than just a constant value.
- It is best to name case sets in the Case set manager to fully describe what they are (e.g., ‘Beta 25 Hot Case’ rather than ‘case25’).
- Grouping cases by scenario is helpful; for example, place all on-pad cases together in a group, all rollout cases together, all TVAC cases together, etc. This allows easy selection of all relevant case sets to run at once, and also allows selection of all case sets that may need to be changed at one time. This also helps clarify which cases have similar radk runs, and minimizes re-running radks.
- Run directories for cases should be carefully chosen so that re-running of the same radk cases in different directories is minimized.
- A sufficient number of case types should be defined from the beginning of modeling: not just hot/cold, but nominal, survival, day of flight, maximum gradient, etc.
- One thing that can have a large effect on the time required for a run, and its accuracy, are the settings for the radiation group runs (“Radiation Tasks” tab in the case set manager). Some general recommendations are:
 - The Job tab defines the type of job to be run. For an orbital radk run, careful consideration should be given to whether a run needs to be articulating or static radks. If there are any moving parts around the orbit (such as articulating solar arrays) that will change any radiative view of the payload if interest, then articulating radks should be run. This will take more computation time, since a radk run will be performed at each orbit point, but these runs should not need to be re-run often. If static radks are run, the position of any articulating parts will be as those parts are at the first orbit point (i.e. they will not be averaged over the run).
 - In the Control tab, the main factor in how long a radiation run will take is defined by the number of rays shot. If radiation is a critical factor in the analysis, and the geometry is relatively complex, it is a good idea to run a sensitivity analysis with various numbers of rays in radiation, to determine how many rays are needed for an accurate result. This is not as time-consuming as might be assumed, since the RadCAD® software module takes

 National Aeronautics and Space Administration	NASA Passive Thermal Control Engineering Guidebook	Revision: 4.0
	Date: 9/25/2023	Page 101 of 202
	Distribution Restrictions: Publicly available	Security Classification: Unclassified

advantage of multiple processors. Sample values for common numbers of rays would be 50K, 100K, 500K, and 1M. The number of rays can be made a symbol to facilitate this.

- The weighted error should be set to a non-zero value, to allow the program to take advantage of cutting down the number of rays for a node when the desired accuracy level has been reached. A common value here is from 2 to 5 (value given in %).
 - In the Advanced Control tab, most modern PCs will perform fastest with at least 13 for max oct-tree subdivisions, and 8 surfaces per cell. Do not set the surfaces too low. Consider a corner of a box where three surface meet, regardless of the oct cell size, there will never be fewer than three surfaces in that cell. For Nodalization Schemes, any of the three settings will produce the same numerical solutions, but if the graphics are needed to be accurate for viewing on all sides of a 1-noded box, for example, “Specific” should be selected, and if viewing of flux accurately on tops and bottoms of surface is necessary “Top/Bottom Specific” should be selected.
 - In the Radk Output tab, meaningful file names will allow simple debugging of results if necessary.
- Best practice is to group analysis cases in such a way that it is easy for any analyst on the team to find the case that he or she needs to run. Cases can be split into groups based on scenario (ground, launch, on-orbit, hot/cold) and it is a good idea to split them in such as was that it is not necessary to re-run radiation calculations for each new analysis run.
 - When determining worst-case conditions, it can be helpful to use the Thermal Desktop™ software [suite](#)’s capability for controlling symbols using Excel® software. A large array of cases can be set up and run via a single analysis case in Thermal Desktop™ software.
 - While the Monte Carlo Ray Trace is inherently parallelized to take advantage of multiple CPU cores for radiation calculations, the SINDA runs are not. If you have multiple thermal models to run that use common radiation results, it may be advantageous to run these jobs outside of TD to take advantage of multi-core machines. Use of the paths.txt file to point to directories containing the INSERT files allows only the .inp and paths.txt file to be present in a subfolder to execute the job. Due to some potential conflicts in files generated by SINDA, running each job in a separate directory is advised.

Some parts of this are also described in an NEN Webinar, in the file ‘SAGEIII_Amundsen.wmv’.

4.7.1.29 Troubleshooting Long Model Run Times

Sometimes thermal model runs will seem to stall, or will have unacceptably long run times. There are several methods for addressing this. The first is to check the .out, .msg, and .log files for the run to see if any cautions or warnings are present. Another possibility is that the model has some nodes with small CSGMIN values; the CSG calculated by TD is the capacitance divided by the sum of conductors for a node). To determine the model’s minimum CSG values, use a run (can be steady-state or very short) with save 'ALL' or at least save ‘ALL’ at end of steady state/transient. Then, when viewing results at that time step where ALL is output, view by using the CSG option in the Model Browser and the CSGMINs are ranked from the smallest to largest. To evaluate the CSGMINs for the entire model, select all submodels by selecting Submodel Node Tree at the top. Finding the nodes with minimum CSGs is important because

 National Aeronautics and Space Administration	NASA Passive Thermal Control Engineering Guidebook	Revision: 4.0
	Date: 9/25/2023	Page 102 of 202
	Distribution Restrictions: Publicly available	Security Classification: Unclassified

TD sets the time step based on the lowest $CSGMIN*1000$. If there are nodes with extremely small values, the run time can be improved by making some of them (where appropriate) arithmetic nodes.

Very useful commands for looking into why a run is slow are SETTL and PRINTTL. These are described in the TD manual. These are used in the OPERATIONS data block as shown below, with the SETTL setting up the time limiter printout settings, and PRINTTL doing the time limiter printout in the .out file after the solver is complete.

```
CALL SETTL(50)
```

```
CALL TRANSIENT
```

```
CALL PRINTTL(1)
```

(the manual has more details on what numbers to choose).

The output is a succinct analysis of what nodes are limiting the time step; search for the word 'LIMITING' in the .out file. The limiting nodes are given, and for each the conductors attached to it are also given, which allows determination of whether the issue is driven by small thermal mass, or an extremely large conductor.

4.7.1.30 Restarts

Where it is not possible to define an entire timeline to occur within a single case (e.g., the radiative elements present change between cases), then the preceding case should always be used to define the start temperatures for the subsequent case. Where fluid submodels are present, it is important to use the fluid lump temperatures for restart as well. If using registers when restarting from save file, confirm that their values at the time designated as that from which restart data should be pulled are as expected. Figure 27 shows one example of a potential issue that could be encountered. For a given temperature, a heater register could be on or off, and its state at the beginning of the run could change the results. Another example of something to watch for is that when there is periodic variation in a temperature for multiple subsystems (such as over an orbit, or with heaters cycling), each subsystem may not hit a maximum or minimum at the same time. If starting from a particular subsystem's minimum or maximum value is important, then the restart time must be selected carefully, as shown in Figure 28. If the coldest case for several components is required, it may be necessary to do separate runs with different restart times, each chosen for a specific component's coldest temperature.

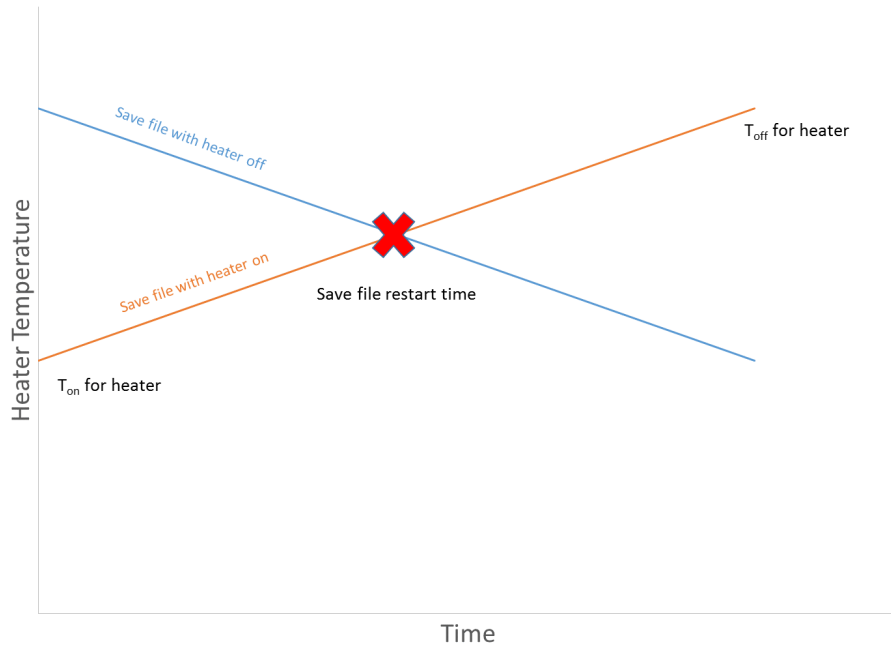

Figure 27. Example of issue with using registers in restart files.

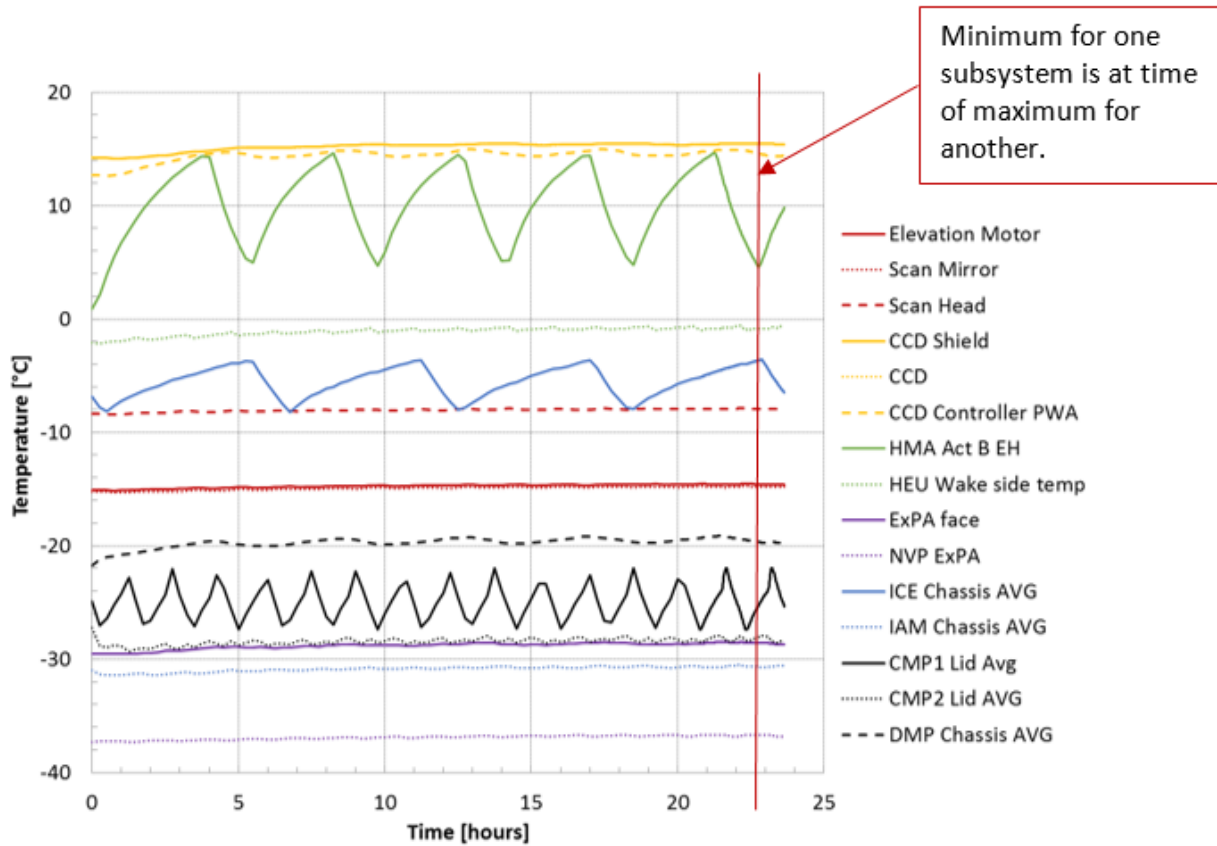



Figure 28. Example of importance of selection of restart time.

 National Aeronautics and Space Administration	NASA Passive Thermal Control Engineering Guidebook	Revision: 4.0
	Date: 9/25/2023	Page 104 of 202
	Distribution Restrictions: Publicly available	Security Classification: Unclassified

4.7.1.31 Results Processing

The Thermal Desktop™ software suite offers a large number of results processing tools and functions. Some of these tools can be found under the ThermalPost Processing menu. These include functions that can find min and max temperatures per submodel over a large number of runs, calculating sink temperatures, finding heat flows between submodels, and many more. For details, consult the TD manual.

FilePlottingTools (<http://fileplottingtools.larc.nasa.gov/>) is a freely available code developed at NASA Langley which offers a very efficient way to process Thermal Desktop™ software .sav files, and time vs. temperature text files. The intuitive interface greatly reduces the time required to develop presentation and report-quality plots from large time-dependent data sets. The “compare min max” feature allows users to compare results from various runs with the click of a single button. Some of the functional elements are:

- Computes max and min over transient for selected nodes and registers
- Can do hundreds of files with multiple nodes simultaneously
- Determines worst case file run for each node
- Compares max/min to limits for each node and run
- Highlights extremes and worst case out of all cases
- Calculates Time-To-Limit (TTL) for each node
- Standardized plot creation using any selection of nodes and files
- Plots refreshed when imported files refreshed
- Specialized routine also available to plot standard 128 cases run for Dragon® reusable cargo spacecraft in required format

Some of these methods are described in a Webinar on the NEN website, in the file ‘FilePlottingTools’.

4.7.1.32 Solver

SINDA/FLUINT software includes a goal seeking and optimization capability commonly referred to as the Solver. This is a powerful tool for design optimization, worst case scenario evaluation, and data correlation among other applications. Within Thermal Desktop™ software, the Solver couples with the Dynamic SINDA functionality. For details, see Section 5.1 of the SINDA/FLUINT User’s Manual and Section 16.2 of the Thermal Desktop User’s Manual.

4.7.1.33 Model Integration

This section describes how to integrate one thermal model into another, for example when two subsystems are brought together, or when an instrument model is integrated to the spacecraft. Note that the recommended, easier way to accomplish this is described in section 4.7.1.16 on using xrefs (external reference files) to integrate models.

4.7.1.33.1 *Coordinate System*

In all models to be imported, there should be a common coordinate system defined. This coordinate system can be defined in the template file, or in model development standards. Each model can also use a separate coordinate system of choice, but if at least one common coordinate system exists in all imported models, model transfer and debugging are greatly facilitated. For example on Ares I-X, the common coordinate system between models was the vehicle coordinate system from the official outer mold line document.

 National Aeronautics and Space Administration	NASA Passive Thermal Control Engineering Guidebook	Revision: 4.0
	Date: 9/25/2023	Page 105 of 202
	Distribution Restrictions: Publicly available	Security Classification: Unclassified

4.7.1.33.2 *Template Model File*

A template model should be used to communicate many of the parameters that should be common across models, from the imported models (e.g., an instrument level model) to the overall integrated model (e.g., a full integrated spacecraft bus observatory model).

Items that should be contained in the template drawing file include:

- Unit preferences
- Symbols
- Includes orbit or environment parameters such as solar flux
- Symbol groups
- Radiation groups
- Layers
- Environment arrays (such as air temperature)
- Thermophysical and optical materials
- Case Names, with at least one defined as the checkout test case
- Example submodel names
- Example logic blocks
- Common coordinate systems
- Orbits.

As items are better defined (such as logic blocks, material properties, orbits and case sets), this template drawing should be updated so all modelers can import the current information. It is very important to have all common materials defined in the template file, so that when a model is imported, materials are not duplicated in the overall model due to small differences in naming. The common material library can be kept in the template file and re-imported regularly by each modeler as the design progresses.

4.7.1.33.3 *Software Standardization*

Ensure that all modelers are using the same versions of all software tools and compilers. Even a change in compiler settings can cause the runs to behave differently.

4.7.1.33.4 *Induced Heating Environments*

It is best to coordinate in advance between all modelers the methods to use for modeling solar and planetary flux, as well as aeroheating. For aeroheating, coordinate on what units will be used, whether cold wall or hot wall heating will be used, and whether radiative heating is included. The user should graphically verify all heating being applied to the model.

The easiest way to add aeroheating to a TD model is using the Boundary Condition Mapper (BCM). This option allows the user to apply aeroheating from a file. The aeroheating can be defined as a transient, over a mesh of points, and also defined for several different wall temperatures. This is extremely useful as it allows the analyst to apply true hot-wall heating, and not use cold wall heating as a bounding worst case, or approximate the hot wall heating. This does a true interpolation of the heating for each node on the surface, using the node's location, current temperature, and the time point in the trajectory. The format for the file is defined in the TD manual. If the user has an aeroheating file that is in TecPlot format, there is a routine called Map2CFD, developed at LaRC, which translates from TecPlot format to the required TD input format.

 National Aeronautics and Space Administration	NASA Passive Thermal Control Engineering Guidebook	Revision: 4.0
	Date: 9/25/2023	Page 106 of 202
	Distribution Restrictions: Publicly available	Security Classification: Unclassified

In addition, an input aeroheating file can be used where the dependent variable is something other than time. For a project that dealt with aeroheating in a Martian trajectory, the heating matrix available was a function of the atmospheric density that the vehicle was at, rather than time. These files could be used directly to apply aeroheating, rather than translating them to arrays as a function of time. This capability is described more fully in a TFAWS 2010 paper on aerobraking analysis here, [https://tfaws.nasa.gov/TFAWS10/Proceedings/Aerothermal/Ruth Amundsen.pdf](https://tfaws.nasa.gov/TFAWS10/Proceedings/Aerothermal/Ruth%20Amundsen.pdf).

4.7.1.33.5 *AutoCAD® Software Groups*

Any delivered model should contain at least one AutoCAD® software group that contains every thermal entity, to allow for easier posting and unposting of the delivered model. Note that if inserting a delivered model into a higher-level model, the AutoCAD® software groups are not preserved, so Domain Tag sets should be used instead of groups.

4.7.1.33.6 *Model Quality and Delivery*

The thermal engineer should have a clear definition of the quality required for each delivered model (required review processes, etc.) prior to delivery, and a clear schedule for delivery. The delivered model should include necessary material thermophysical and optical property files as well as any external files needed to run. At least one results case (either .sav file or a transient plot and gradient image) should be supplied. This practice will allow the recipient of the model to run a sample case after receipt, to ensure correct operation, and also check the results after integration of the model. The delivered files should also include a thermal model summary document that describes at least the submodels, basic symbols, cases, model logic and results. The model summary can be based on the template included for NASA users here, or may be formatted as the delivering analyst desires, but should include this same information. Where information (such as orbital parameters) has been previously defined in the template model file, and remains unchanged, it can be eliminated from the model summary.

4.7.1.33.7 *Model Checking*

When models are submitted to be imported into an overall model, the submitted models must be checked thoroughly before importing them and potentially damaging a working integrated model. When a model is transferred, the first task is to open the drawing file and define the new location(s) of the accompanying optical and material property files. The following items were found to be useful to check before importing the model into the full model:

- View model in Model browser by Thermal properties, by Optical properties, and by Radiation groups. Make sure none are default. Make sure that everything makes sense, and in particular that the radiation groups have identical names as any that are to be matched in the integrated model.
- Post by radiation groups to make sure right surfaces/solids are in each.
- Run a mass check (Thermal -> Model Checks -> Calculate Mass) and make sure the model mass is correct.
- Output SINDA Con/Cap data to make sure there are no errors.
- Look for duplicate nodes (Thermal -> Model Checks -> List Duplicate Nodes).
- View active sides to verify their definition is correct.
- Check units for both thermal model and fluid model.
- Run the submitted model and check both an image of the results and a plot of the transient results against the results supplied by the model developer (results can differ due to differences in software

 National Aeronautics and Space Administration	NASA Passive Thermal Control Engineering Guidebook	Revision: 4.0
	Date: 9/25/2023	Page 107 of 202
	Distribution Restrictions: Publicly available	Security Classification: Unclassified

version, compiler versions, or errors in external file locations). Ensure that the option for what to do with duplicate nodes is as desired (preferably, stop run if duplicate nodes are found).

4.7.1.33.8 *Model Import*

The process of importing one Thermal Desktop™ software model into another currently involves several steps. In future versions of Thermal Desktop™ software this process should be smoother. Use of xrefs or TD Block references may have advantages over model import, in particular in cases where one subsystem or model is separable from another, tested separately, or developed by a different organization, see section 4.7.1.16. The reason to use import of one model into another is if the models do not need to be worked on by different personnel, will never need to be separated, or no changes are expected in the model that is being imported.

As an example, the following process can be followed to import a model:

- 1) Ensure the integrated model runs before import of submitted model. Save a results file to check against.
- 2) Export from the submitted model: correspondence data and property aliases (Logic Manager objects, orbits and case sets are optional). Update: currently, correspondence data is the only thing that needs to be actively exported, the rest can be imported directly from the dwg file without being exported first. However, in order to more easily select only the desired symbols and logic blocks, it may be easier to export only the desired ones from the submitted model.
- 3) To have the same radiation groups as the integrated model, edit them appropriately.
- 4) In a submitted subsystem model, display everything and all desired submodels. Be careful to display all layers, submodels, and nodes that are to be imported. Contactors that are attached to something not exported will not export, even if selected. A handy option, if a contactor is attached to something not to be exported (i.e., structure that already exists in the integrated model) is to temporarily alter the contactor to tie to one of the exported surfaces. Then, after the import the contactor can be corrected back to the original location. Even better is to use Domain tag sets in all contactors, in particular those that will function between models. Domain tag sets are maintained in a model import done via a WBLOCK. Alternatively, anything not desired upon import (such as CAD geometry or dummy surfaces) can be deleted and the model saved as a “clean” version prior to import.
- 5) Set correct coordinate system and units for transfer. (Do Format > Units > Units to set units correctly, as well as setting units in TD Preferences, and Tools>Options and set insertion scale to desired units. Can also set in Tools>Options>AM:Standards, Measurement).
- 6) Make sure that trackers are reset. Do Thermal > Articulators > Toggle Global Activation to turn trackers off before export (if there are any in the model).
- 7) Export wblock of desired items. (Type ‘wblock’, click source=objects, and select all items to be exported/imported. Be careful that the units drop-down names the correct units). Pick a logical file name (usually including ‘_block’ to denote the block export). Remember to turn the trackers back on before closing the model, and change units back if a change was made.
- 8) Open integrated model and set to correct coordinate system and units. (Do Format > Units > Units to set insert units correctly). If importing fluid submodels, set the FLUINT output units, and add any necessary fluid model constituent fluids. If necessary, delete the existing submodels that are to be replaced with this new import. An option is to rename the existing submodel (that is being replaced), from, for example, SUBMODEL to _SUBMODEL. Then

 National Aeronautics and Space Administration	NASA Passive Thermal Control Engineering Guidebook	Revision: 4.0
	Date: 9/25/2023	Page 108 of 202
	Distribution Restrictions: Publicly available	Security Classification: Unclassified

after the new SUBMODEL is imported, and connections are changed to connect to it, the older SUBMODEL can be deleted.

- 9) If replacing an existing version of the subassembly, delete any and all objects associated with it, including: surfaces, nodes, user nodes, articulators, heat loads, heaters, contactors, conductors, material orienters, solid elements, measures etc. Also remove logic objects that are no longer needed as well as any empty Domain Tag sets. Be careful with heat loads that may reference Domain Tag sets, as these cannot be deleted by selecting from the screen and must be selected from the Model Browser (or a second duplicate heat load may be created on import).
- 10) Import the symbols and property aliases exported above, and materials from the submitted materials files, using import buttons in those forms. (Logic Manager objects, orbits and case sets are optional). As mentioned earlier, to avoid duplication of common materials, all models should be started from a template which includes the same common materials. Then, only the materials unique to the submitted model must be imported.
- 11) Select Thermal > Articulators > Toggle Global Activation to turn trackers off before import (if there are any in the model). This may not be necessary, but is safest. Note that trackers should always be reset before toggling them on or off.
- 12) Create a new layer for import if needed.
- 13) Select Insert -> Block and pick the block drawing file just created. Make sure the Explode box is checked. Do not select a location and rotation – if the model is in the correct co-ordinate system, the block will come across in the same place.
- 14) After the import, to have those submodels appear in all the drop-down menus, select Thermal > SINDA Submodels- -> Scan DB.
- 15) Add any new radiation groups to the model by selecting Thermal -> Radiation Groups -> Scan DB.
- 16) Create any contactors/conductors/ties that may be needed to connect the imported model into the base model. Correct any contactors or conductors that were artificially set to contact within the imported block.
- 17) Add items to tag sets that may have been used in the original model.
- 18) Import correspondence data. Make sure to turn correspondence data on if necessary.
- 19) Select Thermal > Articulators > Toggle Global Activation to turn trackers back on if necessary.
- 20) Check total model mass.
- 21) Add any new radiation cases to all applicable cases in the case set manager (use multiple edit mode to change several cases at a time).
- 22) Change any radiation groups on surfaces that may be different in the new model.
- 23) Add any necessary registers to case sets. In general, however, registers should be set using logic in the symbol manager (or logic blocks), rather than defining them per case set – so this should not be necessary.
- 24) Delete the older original submodels that are being replaced, if they were left in the model. Make sure contactors are connected correctly after deletion.
- 25) View model in Model Browser by Thermo Props and Optical Props. If materials are duplicated by similar entries, determine if the duplicate material has the same properties and thus can be eliminated (with associated surfaces transferred to consolidate into one material entry). Check assemblies and trackers to ensure that everything that was attached originally, still is.
- 26) View model by symbols to make sure usage is consistent and no symbols have been duplicated by misspellings.

 National Aeronautics and Space Administration	NASA Passive Thermal Control Engineering Guidebook	Revision: 4.0
	Date: 9/25/2023	Page 109 of 202
	Distribution Restrictions: Publicly available	Security Classification: Unclassified

- 27) If the Measures menu was used in the imported model, set the Measures tolerances so that any thermal sensors will map as originally designed.
- 28) If Measures are mapping to tag sets or groups, make sure those are still correct.
- 29) Run the same case run in step 1) to check that results have not changed in any inappropriate manner. Test the performance of the submitted model by running the same case as the results submitted, and check that results are compatible. Several of the output subroutines can be used to evaluate the behavior of the imported submodels relative to the integrated model, such as SUBMAP to show thermal maps between each submodel.
- 30) Check the log file for the run to ensure that there are no errors; some errors will show up in the log file but not stop the run, and so the log file is the easiest option to find those.
- 31) Run cases that exercise different logic blocks if needed; for example, if the model uses different logic in hot and cold cases, or in operational versus non-op cases, run one of each. In particular, ensure that heaters, heat loads, and trackers that depend on logic, still operate correctly.

Although this process involves many steps, the procedure is actually fairly rapid to accomplish, and gives repeatable results.

4.7.1.34 Customizations

Cullimore and Ring Technologies, Inc. (C&R) is sometimes willing to create patches to perform a needed function for NASA, for free. For Mars Reconnaissance Orbiter, the project had aerobraking heat loads as a function of atmospheric density instead of time. To avoid the labor of transforming huge boundary condition matrices, C&R agreed to add an option to use density instead of time in interpolation of aeroheating. This saved the project a great deal of data processing time, and was done quickly by C&R at no charge. Other features that C&R has added to TD over the years free-of-charge:

- Plotting orbit-average Bij to space
- Features to facilitate modeling of IR lamps
- Importing symbols from Excel file to run cases
- Visualization of insulation nodes
- Ability to run TECs in mixed-units model
- Calculation of heat flows between submodels, calculation of sink temperatures
- Import of TD Measures from an Excel® software file
- Attaching TD Measure to MLI surfaces
- Ability to plot color bars without numbers, for ITAR plots
- Addition of sensing point and register output for each heater.

4.7.2 Comet Solutions™ SimApps™ Authoring Workspace

Comet Solutions™ SimApps™ Authoring Workspace software is an engineering software package that provides a framework for performing integrated, multi-disciplinary analyses. SimApps™ Authoring Workspace software can create CAD based analysis processes that can be re-used with different geometric configurations. Each process can include thermal, structural, dynamic, optical, and software tasks, and multiple processes can be created in a single model. This capability is extremely useful for creating analysis templates, which can be used between multiple projects. The SimApps™ workspace software utilizes many of the most common engineering software products used in aerospace projects, such as those marketed under the following names: CREO®, SOLIDWORKS®, Thermal Desktop™, MSC

 National Aeronautics and Space Administration	NASA Passive Thermal Control Engineering Guidebook	Revision: 4.0
	Date: 9/25/2023	Page 110 of 202
	Distribution Restrictions: Publicly available	Security Classification: Unclassified

NASTRAN™, ANSYS®, CODE V®, Zemax®, Matlab®, Excel®, and other software. LaRC has used Comet™ software extensively for Structural-Thermal-Optical-Performance (STOP) analysis, and several publications describe its use in this area (<https://doi.org/10.1117/12.2061041>, <https://doi.org/10.1117/12.2236427>).

An example STOP analyses process developed in Comet™ software is shown in Figure 29. The process defines all the tasks required for performing a complete STOP analysis, from meshing the CAD model, to post-processing the optical analysis results, and generating power point reports. Results from each analysis task are passed to each subsequent task that requires them. For example, the Thermal Desktop™ analysis is performed first, and the temperature results are then mapped to the MSC NASTRAN™ structural model to perform the deformation and stress analysis.

SimApps™ Authoring Workspace software is very useful for performing trade studies on a design early in a program, when there may be many options for design choices. Several design options can be analyzed quickly with the same analysis process, to determine which one is the best solution. Several different processes can be analyzed in the same model, such as thermal performance, STOP, modal analysis, and static loading. The ability to run several types of analysis allows a team to quickly identify any weaknesses in a design across multiple disciplines and requirements.

LaRC has developed several analysis templates, and training material which can be provided on request. More information can be found at <http://cometsolutions.com/>

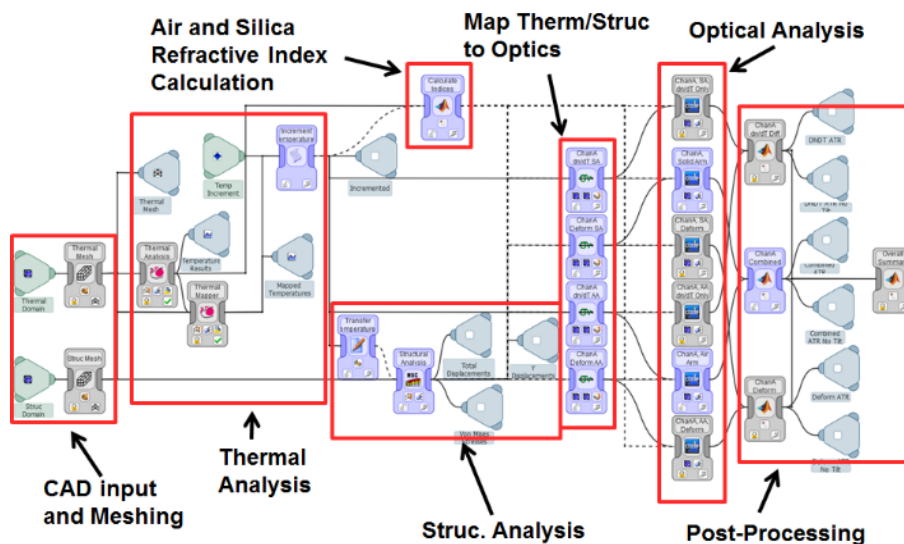



Figure 29. STOP analysis process with Comet.

4.7.3 COMSOL® Physics Simulation Software

COMSOL Multiphysics® software is a multiphysics platform for modeling engineering applications across disciplines.

 National Aeronautics and Space Administration	NASA Passive Thermal Control Engineering Guidebook	Revision: 4.0
	Date: 9/25/2023	Page 111 of 202
	Distribution Restrictions: Publicly available	Security Classification: Unclassified

The COMSOL® software core package⁶ contains everything needed to conduct most multiphysics analysis assuming a user is comfortable enough with the software to utilize the PDE/ODE functions in order to implement all of the physics needed for the analysis. However, add-ons are valuable as they greatly expand the pre-programmed physics available within a discipline, and these pre-programmed physics are often considerably quicker and easier to use than custom PDE/ODE functions. COMSOL Multiphysics® software also contains “App Builder” which is a feature that can be used to generate a stand-alone GUI interface, so that someone not familiar with the inner workings of the model is prompted to input requested parameters and desired results are returned. The differences between the core package and general notes about add-ons now follow.

The core package includes extensive geometry building tools for 1D, 2D, 2D axisymmetric, and 3D models, stock material library, several analytical tools including the ability to generate custom modeling attributes using PDE/ODE and optimization, built in tools for electromagnetics, structural mechanics, acoustics, fluid flow, heat transfer, and chemical engineering modeling, advanced meshing capabilities, and several fully customizable solvers which can be used to produce solutions to a range of study settings including steady state, time dependent, frequency dependent, and several sweep functions. In addition, advanced post processing and data visualization tools are available including reports and data export options.

In the COMSOL Multiphysics® software it is very easy to create complex geometries within the software by using the graphical interface and a variety of tools familiar to CAD software such as blocks, extrusions, many Boolean operators and virtual operators, etc. For users who need access to even more complex geometries, or who have a model built in an external CAD software tool and would like to run analysis which would iteratively update geometric parameters within the CAD software, add-ons are available for several CAD tools. These add-ons are called “live links” and can also be purchased to accomplish similarly interactive tasks with non-CAD tools such as MATLAB® and Microsoft Excel®.

After a geometry has been created or imported in the COMSOL Multiphysics® software, material properties, physics, and meshing can be applied to the geometry. The COMSOL interface applies these functionalities to the geometry, rather than the mesh, which makes it easy to apply boundary conditions or material properties (for example) to a physically meaningful entity such as a volumetric domain or boundary. The COMSOL Multiphysics® software’s core package comes with a number of common built in materials available to be applied to a geometry. Additional materials are available as an add-on; however, a user with the basic core package can create any custom material they would like. A large variety of properties are available to apply to materials; these properties can be scalar values, as well as a range of functions of single or multiple input variables (such as temperature or pressure).

The physics nodes available for the basic COMSOL Multiphysics® software core package fall under the general categories of AC/DC, Acoustics, Chemical Species Transport, Fluid Flow, Heat Transfer,

⁶ For users who are not familiar with COMSOL® software pricing and licensing structure: COMSOL prices their software by offering a basic core package with many add-ons available to greatly expand capabilities for additional cost. Access is priced for either a single user, which locks a license to an individual named user’s computer (no other users can access this license), or a server license. The server license can be accessed by various users; however, the number of users who can access the software simultaneously is limited by the number of seats purchased for the server license. The server license core package, as well as all add-ons, are double the cost of that for a single user license. To clarify semantics, COMSOL calls their core package, as well as add-ons, “licenses”; so, a user with a core package and one add-on, would technically purchase 2 licenses. Consequently, at the time of this writing NASA Langley is carrying about 70 COMSOL licenses; however, the number of actual seats is significantly fewer than 70.

 National Aeronautics and Space Administration	NASA Passive Thermal Control Engineering Guidebook	Revision: 4.0
	Date: 9/25/2023	Page 112 of 202
	Distribution Restrictions: Publicly available	Security Classification: Unclassified

Structural Mechanics, and Mathematics. Within these general categories, there are a number of physics interfaces which can be applied to a model. For example, within the core package, the “AC/DC” category contains built in physics interfaces “Electric Currents” and “Electrostatics”. Each of these interfaces contains a variety of tools necessary to apply the relevant physics, boundary conditions, specify assumptions, etc. Add-ons purchased greatly expand the number of built-in physics interfaces within a category. The AC/DC add-on contains the following physics interfaces:

- Electric Currents with Current Conservation
- Electric Currents, Shell
- Electrical Circuit with SPICE netlist import
- Electrostatics with Charge Conservation
- Magnetic and Electric Fields
- Magnetic Field Formulation
- Magnetic Field
- Magnetic Fields, No Currents
- Particle Field Interaction, Relativistic
- Rotating Machinery in 2D and 3D, Magnetic
- Electrostatics, Boundary Elements
- Magnetic Fields, No Currents, Boundary Elements

Optimization and sensitive studies can be created by various methods. Advanced meshing concepts (such as deforming mesh) are available, as well as alternate coordinate systems (such as curvilinear coordinates) which can also be employed for various modeling tricks such as applying properties to anisotropic materials in such a way that properties vary according to a coordinate system that is oriented using the geometry’s contours.

Many of the physics interfaces contain “multiphysics” built-in couplings to other interfaces. For example, there are couplings available to directly couple joule heating in an electrical component to additional physics interfaces in the area of heat transfer and or fluid flow.

For a complete list of current physics add-ons, as well as descriptions of various components, see this link:

<https://www.comsol.com/products>

After relevant physics and materials have been added to a geometry, mesh is then applied. The COMSOL Multiphysics® software has a relatively robust built-in meshing capability. Like the physics interfaces, meshing is applied directly to a geometry. Mesh dimensions are fully customizable including specifying cell size, density around fine geometric features, cell growth rate, etc. Mesh capabilities include, for example, tetrahedral mesh, swept mesh, boundary layer refinements, mapped mesh, adaptive mesh, and many more. Multiple mesh configurations can be applied to a geometry, or to difference parts of a geometry. Mesh statistics are available after a mesh has been built, which can be used to identify problematic areas or guide the user in refining or coarsening mesh as needed.

After mesh has been applied, a study and relevant solvers are applied to the model. A variety of studies are available including “Eigenfrequency,” “Stationary,” and “Time Dependent,” for example. Multiple studies can be used in the same model. After a study is selected, the user can decide which physics a given study will solve for, define sources for variables (if they are not to be generated or specified within the model), apply mesh appropriately, and run extensions such as parametric studies (parametrically vary a

 National Aeronautics and Space Administration	NASA Passive Thermal Control Engineering Guidebook	Revision: 4.0
	Date: 9/25/2023	Page 113 of 202
	Distribution Restrictions: Publicly available	Security Classification: Unclassified

specified independent variable) or auxiliary sweep (for example, iteratively ramp an input value, such as a load, in order to help the solver converge), etc. After a study is defined, a solver configuration is automatically generated; however, the user can fully customize these solvers employed (such as direct, fully coupled, or iterative solvers), as well as their parameters (such as convergence criterion or solver methods).

Post processing in the COMSOL Multiphysics® software is highly visual with plots available for “probe” functions and solution data sets (for example) in 0D, 1D, 2D, 2D axisymmetric, and 3D. Data visualization is fully customizable to include setting color coding, range, scaling, titles, labels, etc. Data can be presented in slices, surfaces, arrow volume detail, and several other options. In many cases multiple plots can be overlaid. Filters can be used to isolate relevant subsets of data. Meshing can be visualized. Structural deformation can be visualized, and exaggerated so as to be visually obvious. Derived values are also available. For example, integrals of any output variable can be applied to a geometric feature such as a volume, surface, or line. Several calculations using output data can be calculated “in house” in this manner. Energy and mass balance cross checks are built in as “global evaluations.” Finally, all physics applied, as well as the inner workings of the software, are available for inspection and in many cases alteration.

As has been made evident, the COMSOL Multiphysics® software is a highly customizable and capable software platform which could theoretically obviate the need for a large number of software options which focus on a single area of physics. For example, a single engineer could conduct a fully coupled thermo-structural analysis rather than passing data between two analysts using two different software platforms. However, everything comes with a cost and the COMSOL Multiphysics® software also has its downsides. First, the cost of the software is significant⁷ and should be weighed against other options. It should be noted that the support desk is extremely helpful and technical support engineers are exceedingly competent and helpful. Support is also available for ITAR applications. The second cost is system resources. This statement is based mostly on opinion, but there is often a general sense among engineers familiar with the COMSOL Multiphysics® software is that it tends to be relatively system resource demanding and models can take a long time to converge on solutions compared with other software options. These costs should be considered before selecting the COMSOL Multiphysics® software as an analysis tool.

4.7.4 *BPMapper*

BPMapper is a software tool that was developed at LaRC for the Ares I-X mission. It is used to map MINIVER aeroheating loads onto a Thermal Desktop™ model. The manual, source code, and executable are available on an internal Agency shared drive.

⁷ At the time of this writing, a single user core package license is approximately \$10,000 with add-ons ranging from a couple to several thousand dollars each. Yearly maintenance on the single user license is approximately \$2,000 for the core package, maintenance is also priced for add-ons proportional to their initial cost. Maintenance can be avoided, and the software will continue to function; however, the COMSOL® support desk and software upgrades are no longer available after maintenance expires. If a user wishes to renew maintenance, there is a penalty proportional to the maintenance that was not paid. Server based copies are about double the cost of a single user license.

 National Aeronautics and Space Administration	NASA Passive Thermal Control Engineering Guidebook	Revision: 4.0
	Date: 9/25/2023	Page 114 of 202
	Distribution Restrictions: Publicly available	Security Classification: Unclassified

4.7.5 *Efficient Global Optimization (EGO) Tool*

The EGO tool was originally created and implemented to predict the worst-case hot and cold beta angle and attitude combinations for the SAGE III on ISS mission. See NASA/TM-2014-218282 [7] for details of that implementation.

The EGO tool consists of a set of MATLAB® code scripts that implement an Efficient Global Optimization (EGO) method as described in Jones, et al. [Ref. 10]. Note that this tool requires several functions from the MATLAB® software’s Statistics and Machine Learning Toolbox.

The tool is generally best suited for finding the global maximum or minimum value of a function that has a complex response shape (with several local maxima/minima) over the design space. Additionally, the advantages of this approach are more significant when the model is computationally expensive to run. For a small model that runs quickly, the user may be better off using the simple brute force approach of directly evaluating a large number of points in the design space.

References and files required to run this tool can be found on an internal Agency shared drive. It is recommended that a user interested in this tool start by looking at the power point presentation and then refer to the two previously mentioned papers for additional details.

MATLAB® computer program files:

- EGO_example.m – shows an example of the process for a sample problem with a single design variable
- fit_model.m – fits a stochastic process surrogate model to the sampled data
- SimAnneal.m and ParticleSwarm.m – global optimizers that can be used to find optima of the likelihood function and the expected improvement function
- CorrMatrix.m – computes the correlation matrix
- likelihood.m – computes the likelihood for a given set of model parameters
- find_EI_maxima.m – identifies new points to evaluate based on maxima of the expected improvement function
- ExpectImprove.m – calculates the expected improvement at a set of potential new sample points
- predictY.m – uses the surrogate model to predict the objective function values at new points

General outline of process:

1. Generate an initial sample (generate DOE sample points, run user’s thermal model)
2. Fit a surrogate model to the data (fit_model)
3. Identify point of maximum Expected Improvement (find_EI_maxima)
4. Sample point of maximum Expected Improvement (run user’s thermal model)
5. Repeat steps 2-4 until convergence

5.0 Thermal Hardware Selection and Integration

This section includes guidance on the design, selection, procurement, and installation of various types of thermal hardware. Vendor and project-specific design information is not included in this document; however, readers with access to the NASA Agency-Wide Shared Drive may access notes and links related to thermal hardware vendors and selections for various projects in the Thermal Hardware section of an internal Agency-wide OneNote® notebook. A good, publicly-available class on many types of thermal

 National Aeronautics and Space Administration	NASA Passive Thermal Control Engineering Guidebook	Revision: 4.0
	Date: 9/25/2023	Page 115 of 202
	Distribution Restrictions: Publicly available	Security Classification: Unclassified

hardware can be found on the NESC Academy website at <https://nescacademy.nasa.gov/video/8c00f7bc46eb4555ae2e4414dc3862851d>.

5.1 Temperature Sensors

The information in this section is largely based on lessons learned from the SAGE III on ISS project. Additional information on temperature sensors, including thermostat vendors and flight experience on SAGE III, is available at an internal Agency-wide OneNote® notebook sensors and thermostats.

5.1.1 *Telemetry Definition*

It is important for the thermal engineer to be cognizant of the project process and status for defining temperature sensor locations and conventions for naming telemetry parameters. The thermal engineer should be involved in this process from the beginning. This will ensure that the sensors are named and placed in ways that are most effective for the thermal engineer, that the naming remains consistent, and that the sensor names in the model reflect the names used in the telemetry.

When defining temperature monitoring locations, it is important to consider telemetry availability. Some sensors may be available even when the payload is powered off, some may be available in survival modes, some may be available whenever the payload is powered on, and some may only be available in certain modes of operation (such as a certain science measurement). When deciding which sensors are the most important to have available at all times, the following are important to consider:

- Which subsystems power on first (these systems may need a sensor that is available when powered off, to allow the decision of whether the payload is within a suitable thermal range for power-on)
- Which items are expected to most closely approach limits (any component that is expected to get close to a limit should have a thermal sensor that will be available at the appropriate time)
- What might be useful to know in flight (trending, problem resolution, etc.).

5.1.2 *Selection*

There are several types of temperature sensors. Each have their own characteristics; at the beginning of a project, careful thought should be given to the type of temperature sensor used. A brief summary is given here; more detail is available for internal NASA users in the corresponding Agency OneNote® notebook section. If the sensor is protruding into a flowing fluid, it may also be required to consider the stresses in the sensor or the reaction of the sensor material to the fluid. ASME PTC 19.3 TW can be used to evaluate the static and dynamic forces on the protuberance.

Temperature sensor types:

- Thermocouples (TCs): widely used, cheap, durable, reliable, wide temperature range, but can be inaccurate especially if there are cold junction issues. A good standard for understanding thermocouple limits of error is ASTM E230. TCs with built-in adhesive are available but may prove limiting. Many on-line references are available that describe how to take TC measurements:
 - <https://www.omega.com/techref/pdf/z019-020.pdf>
 - <http://www.ti.com/lit/an/sloa204/sloa204.pdf>
 - <https://knowledge.ni.com/KnowledgeArticleDetails?id=kA00Z000000P6wvSAC>

 National Aeronautics and Space Administration	NASA Passive Thermal Control Engineering Guidebook	Revision: 4.0
	Date: 9/25/2023	Page 116 of 202
	Distribution Restrictions: Publicly available	Security Classification: Unclassified

- Resistance Temperature Detectors (RTDs): common example is Platinum Resistance Thermometer (PRT), high accuracy, high stability, but can be expensive and fragile and operate over a smaller temperature range
- Thermistors: in between TCs and RTDs as far as cost, larger drift than RTDs, not recommended over 200°C, non-linear with useful temperature range ~100°C
- One-wire temp sensors: more recent technology, each device has unique 64-bit serial address, potentially simpler wiring as they use single wire, somewhat limited temperature range (~ -55 to +125°C)
- Thermostats (see section 5.3).

5.2 Thin-Film Heaters

Thin film heaters are commonly used to control spacecraft surface temperatures. These heaters are often made with Nichrome wire imbedded in a Kapton® laminate. The heating elements can be made with single wire or dual circuits for backup. Among the custom heater manufacturers that support the aerospace industry are Tayco Engineering, Inc., Minco Products, Inc. and Translogic Inc. These vendors maintain an extensive choice of heater designs for off-the-shelf selection and custom-made heaters.

Heaters should be installed on flat surfaces without going over a dent, hole or a cable. Flat Kapton® laminate heaters may not work well over curved surfaces. Line heaters such as propulsion line heaters are best custom-made in a preferred helical shape.

The determination of maximum watt density is an important criteria for designing a heater. It is safer to maintain the maximum watt-density below 5 watt/in². For higher watt-density applications, the impact of the potential heater burnout should be considered. Higher watt-density heaters should be tested in comparable extreme environment conditions. See Table 7 and section 5.2.1.3 for additional guidance.

The attachment scheme plays an important part in designing a thin film heater. Procuring heaters with pressure sensitive adhesive is a convenient and economical way to install heaters. However, heaters with adhesive will have limited shelf life. The type of adhesive used on the heater is dictated by the environmental condition in which the heater would be used. For instance, Acrylic adhesive is usually suitable over a temperature range of -40°C to 95°C. Heaters bonded with RTV 566 are secure over a wider temperature range. The vendor should be consulted for the suitability of a particular adhesive for a given application.

Installing propulsion line heaters with pressure sensitive adhesive is challenging. It is best to procure propulsion line heaters without the adhesive. During installation, the heater is tightly wrapped around the tubing and secured in place with strips of aluminum tape. It is then taped over with one or two layers of aluminum tape over the entire length of the heater. In high watt-density applications, attention should be given to leave no void between the heater and the propulsion line that could cause a burnout.

The most economical way to passively control heaters is to utilize bi-metallic thermostats in close proximity. However, more robust control is achieved by the use of ground commandable relays, and on-board computer-controlled controllers.

It is critical that the thermal engineer ensure the heater(s) are controlled from a point with very good “communication” to the heater. The thermal analysis and design should ensure the gradients between the control point and all the heaters in a control zone are either minimized or at least well characterized and the setpoints biased to account for the gradient. This issue is particularly prevalent in propulsion line

 National Aeronautics and Space Administration	NASA Passive Thermal Control Engineering Guidebook	Revision: 4.0
	Date: 9/25/2023	Page 117 of 202
	Distribution Restrictions: Publicly available	Security Classification: Unclassified

heater systems where the thin wall low conductivity lines do not conduct laterally and have heat leak through attachment points.

NASA users may find more information on the internal Agency shared drive at the locations below:

- Agency OneNote® notebook section on heaters
- MSFC EV34 Best Practice – Considerations for Heaters in Thermal Design
- SAGE III-THM-040 Summary of Guidance on Heater Watt Density and Plans for Mitigating Risk
- SAGE III-05-308 Thin film Heater Installation Procedure
- OnePlace - SAGE III Lessons Learned (LaRC internal site)

5.2.1 Sizing

Heaters should be sized based on the limiting power case. Minimum powers (those corresponding to the low end of the possible bus voltage range) should be used in the thermal model to verify that the heater power is sufficient to maintain acceptable temperatures. Maximum powers (those corresponding to the high end of the possible voltage range) should be used to verify that heater peak power consumption and circuit current remains within any defined limits. Maximum voltages should also be used to determine the heater watt density. Heater resistances should be specified based on minimum power values and should consider heater resistance tolerance from the vendor.

5.2.1.1 Integration of Disciplines

The thermal engineer typically “sizes” the heater power/setpoint requirements as part of the thermal analysis and design, but needs to integrate with other organizations to ensure proper heater selection, procurement, installation and performance. Integration with the avionics group (i.e., power, controls, circuit design, etc.) on the actual heater circuit design is important to ensure joint thermal/electronics agreement on bus voltage range, current limits, wire gauge requirements, etc. The heater represents a resistor in their circuit; review the drawing to assure the design matches thermal assumptions (i.e., parallel versus series heaters, redundant power strings, etc.). Work with the mechanical design engineers for the heater placement, ensuring that the actual heater size is accounted for in the CAD model and confirming that there are no tolerance issues, and the drawing notes with any installation procedure “call outs.” Ensure the S&MA organization concurs with the fault tolerance plan and address any heater related hazards (i.e., runaway heater). The materials organization will likely need to concur on the adhesives relative to outgassing requirements. The thermal team should work with integration and test planning personnel to ensure the test program will include thermal balance test points for validation of the heater/control performance and duty cycle. Ensure that any specific data requirements can be accomplished by the test GSE (i.e., current shunts to provide specific power draw to a circuit of interest, etc.). The thermal engineer is typically the owner of the responsibility for the heater design and performance, but will need to integrate across the related discipline engineering groups to do this effectively.

5.2.1.2 Margin

As a general rule with heaters, the heater should be sized such that an appropriate margin on duty cycle exists in all cases. The GSFC GOLD Rules, GSFC-STD-1000, suggests that heaters should be kept below a 70% duty cycle as an orbit average. MIL-STD-1540 suggests a duty cycle of no more than 80%.

 National Aeronautics and Space Administration	NASA Passive Thermal Control Engineering Guidebook	Revision: 4.0
	Date: 9/25/2023	Page 118 of 202
	Distribution Restrictions: Publicly available	Security Classification: Unclassified

There are two possible ways to determine the heater power margin based on the duty cycle. The first way uses the predicted heater power required to maintain temperature in a given environment as the basis for calculating the power margin of the heater. For example, if 10W is required to maintain a given temperature, a 10W heater would have a 100% duty cycle. In order to get a 70% duty cycle, the heater would be sized as: $Q_h = 10W / 0.7$. This yields a total heater power of 14.3W, which translates to 42.8% heater power margin: $(14.3W - 10W) / 10W$. If the MIL-STD-1540 guideline is used, the heater size becomes $10W / 0.8 = 12.5W$, which translates to a 25% power margin: $(12.5W - 10W) / 10W$. The second way to determine the heater power margin uses the as-built power of the heater. For this same example using 70% duty cycle, the power margin would be calculated as $(14.3W - 10W) / 14.3W$, which yields a 30% heater margin. It should be noted that as long as duty cycle is used to determine the required heater size, the heater size will be consistent with the standard. Calculating the power margin once the heater is sized by duty cycle, regardless of the power margin method used, will not affect the sizing of the heater.

5.2.1.3 Watt Density

In addition to requirements driven by the project (such as voltage limits) and by the thermal design (such as power dissipation), watt density must be considered when sizing thin-film heaters. Various guidelines exist but in general best practice is to try to keep watt densities below 3.5 W/in². However, watt densities above this will not necessarily cause issues. Consideration should be given to the substrate the heater is mounted on: relatively thick, high conductivity substrates, such as aluminum, can normally tolerate higher watt densities. Members of the thermal community were surveyed on recommendations for watt density; a summary is shown in Table 7. The SAGE III project made the decision to keep watt densities below 3.5 W/in² where possible, but watt densities up to 7 W/in² were allowed where necessary because of size constraints on relatively thick (>0.080”) aluminum substrates.

Table 7. Guidance on Maximum Watt Density

Reference	Guidance*
Tayco Engineering, Inc. Flexible Kapton® Heater Information Sheet (www.taycoeng.com)	Page 3, item 1: Normal satellite usage is less than 3 W/in ² ; however, depending on application methods, power density can go up to 25 W/in ² Page 3, item 2: Heaters with watt densities of 3-7 W/in ² should be secured using epoxy around the perimeter Page 3, item 3: Heaters with watt densities of 7–25 W/in ² should have heat sink plates above and below them
Jack Ercol (APL)	Tested Kapton® laminate heaters with watt densities up to 10 W/in ² without issues (AIAA-2000-2881)
Dave Gilmore (Aerospace)	If watt density is greater than 5 W/in ² , use epoxy around the perimeter to ensure good bonding and use aluminum over-tape** to reduce hot spots

 National Aeronautics and Space Administration	NASA Passive Thermal Control Engineering Guidebook	Revision: 4.0
	Date: 9/25/2023	Page 119 of 202
	Distribution Restrictions: Publicly available	Security Classification: Unclassified

Reference	Guidance*
Bruce Drolen (Boeing)	<p>2.25 W/in² max for the following conditions: significant temperature cycling, bonded to honeycomb structure with face sheet <10 mil, bonded to metal plate of thickness less than 0.03 inches, or applied around curved objects</p> <p>4.5 W/in² max for heaters bonded to honeycomb with face sheet >10 mil or to metal plates thicker than 0.03 inches</p> <p>9 W/in² max for heaters bonded to heat pipes with no significant temperature cycling</p>
JPL	<p>From JPL Design Principles: Power density limit for film heaters – Kapton film heaters, when bonded to a metallic or composite substrate over 100% of the heater's active area, shall be limited to a maximum power density of 3.0 watts per square centimeter [19.4 W/in²]. Kapton® film heaters shall be limited to a maximum power density of 0.5 watts per square centimeter [3.2 W/in²] when bonded over voids or other discontinuities of the heat-dissipating substrate.</p>

*Paraphrased for simplicity

**See section 5.2.3.1 for a detailed discussion of aluminum over-taping

5.2.1.4 Temperature Limits

Vendor-specified maximum temperature limits for thin-film heaters vary. The limiting factor for maximum allowable temperature for Kapton® thin film heaters is the pressure sensitive adhesive (PSA). Typically, it is prudent to use an upper limit of 120°C for Kapton® thin-film heaters with acrylic PSA; however, the 3M Company (adhesive manufacturer) has stated that true limit is much higher, particularly for short periods of time (<https://multimedia.3m.com/mws/media/1705914O/3m-high-temperature-tapes-product-selection-guide.pdf>).

5.2.1.5 Physical Size

It is critical to perform detailed checks to ensure that heaters will fit in the intended area by ensuring that the mechanical team is involved early and that they see the data sheet rather than just the overall size of the heater. Some examples of issues that have led to interference: (1) a tab on the heaters that the mechanical designers were not aware of, (2) tolerances were not fully accounted for, and (3) mechanical and electrical designers were not aware that some of the heaters were wire-wound type and were therefore thicker than the typical Kapton® laminate heater.

Use simple shapes (circles, rectangles) whenever possible to simplify installation and minimize the risk of creating bubbles which could lead to heater burn-through. If space is limited, consider consolidating several heater circuits (such as primary and backup, or survival and operational) in a single “dual element” Kapton® laminate heater or ordering custom-shaped heaters.

 National Aeronautics and Space Administration	NASA Passive Thermal Control Engineering Guidebook	Revision: 4.0
	Date: 9/25/2023	Page 120 of 202
	Distribution Restrictions: Publicly available	Security Classification: Unclassified

5.2.2 Procurement

When selecting a heater vendor, consider flight heritage and how much customization is required in addition to cost and lead time.

Vendor qualification testing is normally not required for heaters unless significant customization (beyond the standard options) is done.

5.2.3 Installation

Below are steps to consider when generating procedures for installation of Kapton® laminate heaters. These instructions assume that heaters include a built-in adhesive backing; however, 3M® double-sided adhesive strips can also be used to bond down Kapton® laminate heaters.

- Preparation
 - Clean delivered heaters with wipers lightly moistened with IPA.
 - If desired, lightly abrade substrate where heater is to be applied with Scotch-Brite® scrubber, taking precautions to clean away particulates generated.
 - Clean surface to which heaters will be mounted using IPA moistened wipers or dry air, as appropriate.
 - Use a clean-room compatible heat gun or convection oven to remove moisture and residual solvent.
- Installation
 - Position an alignment bar (or other alignment method such as tape) precisely on the substrate surface, along one side of the long length of the heater placement position. The alignment method will assist with proper alignment of the heater on the substrate. Secure alignment bar using Kapton® tape.
 - Place the heater on a clean table top surface with the protective backing paper side up.
 - Determine the proper direction for the heater lead wires and position appropriately.
 - Peel back approximately 3/8 inch of the long side of the heater protective backing paper, on the side which will be along the alignment bar. Fold back at 180°.
 - Grasp the heater at both ends and position the 3/8 inch of exposed adhesive edge at an angle of approximately 70° from the substrate. No finger pressure should be applied until the heater is properly aligned. Any alignment mistakes at this time should be corrected by a quick snap to release the heater from the substrate.
 - Lower the heater from the angle of 70° to roughly 30°, then press gently down on the heater edge adjacent to the alignment bar, working from left to right until the adhesive is completely in contact with the substrate. A clean-room wipe under the finger can be helpful in applying smooth pressure.
 - Slowly remove the protective backing paper, by pulling away from the alignment bar, using tweezers or fingers in the center of the long edge. Use the other hand to gently apply pressure to the outer Kapton® laminate heater surface while the backing paper is being

 National Aeronautics and Space Administration	NASA Passive Thermal Control Engineering Guidebook	Revision: 4.0
	Date: 9/25/2023	Page 121 of 202
	Distribution Restrictions: Publicly available	Security Classification: Unclassified

removed. Work the finger back and forth over the heater for good adhesive contact with the substrate. Continue to pull the backing paper until heater is fully bonded, being sure not to entrap air bubbles between the heater and substrate. Keep the heater at an approximate 30° angle while removing the backing paper.

- Press the heater surface several times with firm, uniform finger pressure for good adhesive contact. Finger pressure is sufficient at ambient temperature to result in good adhesion. Improved adhesion is obtained by using a 4.5 lb rubber roller. Always start at the center of the long length of the heater and roll slowly to each outer edge. Repeat several times until all surfaces are rolled.
 - If desired, apply weight to heaters at approximately 0.5 lbs/in² and leave the weights in place for a minimum of 8 hours.
 - Using epoxy, stake the edges of the heater using small beads. Staking should be at each corner of the heater, and in dots at approximately 0.5-1” spacing around the periphery of the heater. The intent is to avoid peel-up from the edges, but allow a vent path for vapors and moisture that may be trapped under the heater.
 - Wipe all surfaces with clean wipes lightly dampened with alcohol after completion of bonding.
- Inspection
 - Visually inspect the heater for evidence of trapped air.
 - Check heater adhesive bond for bubbles using IR camera. If this step is performed, it should be done within an hour after the heater application, so that if a decision is made to remove the heater, the transfer adhesive will not be fully hardened. When using a power supply to check the heater performance, limit current to a value based on the resistance of the heater to be tested.
 - Ensure that lead wires for heater(s) are clearly labeled as to which heater they are for.
 - Photograph the heater(s) on the surface from several angles.
 - Secure hardware as necessary. Ensure that no stress is put on heater or lead wires that would separate heater from surface, until thin-film adhesive cure is complete (24 hour minimum).
 - Measure the hardness of the cured epoxy witness sample with the durometer as required per NASA-STD-8739.1 and record the result as required.

5.2.3.1 Aluminum Over-taping

Varied recommendations exist with respect to the practice of over-taping Kapton® heaters with aluminum tape. In some organizations, aluminum over-taping is performed for all heaters as standard practice, while others recommend it for heaters over a certain watt density (ranging from 1-5 W/in²). The standard process for flight projects at NASA LaRC is to not over-tape when heaters are used on metallic substrates with simple geometry. NASA GSFC uses aluminum over-taping on flight heaters, regardless of substrate, to spread out hot spots as would be created if there were a bubble in the adhesive under the heater. To

 National Aeronautics and Space Administration	NASA Passive Thermal Control Engineering Guidebook	Revision: 4.0
	Date: 9/25/2023	Page 122 of 202
	Distribution Restrictions: Publicly available	Security Classification: Unclassified

mitigate the danger of trapped air and moisture, they utilize a thin (~1/16”) gap between tape pieces, to allow escape of any moisture during heating at vacuum. GSFC does not use over-tape on heaters that are epoxied down. This section provides a discussion of the potential benefits and risks associated with the use of aluminum over-tape.

The primary reason for using aluminum over-tape is its potential benefit as a heat spreader, in the event that a bubble exists in the heater which would lead to a local hot spot. Additionally, it may help to prevent the edges of the heater from curling if applied such that it extends beyond the heater by approximately 0.25”. While it typically takes years for edges to begin curling due to degradation of the adhesive, adding aluminum tape can delay the onset of curling of the heater’s edges since the aluminum will begin to curl first. One other consideration for aluminum over-taping would be in scenarios where the heater configuration could have radiative heat loss (i.e., not covered in MLI) and the hemispherical emittance needs to be lowered from >0.5 to <0.05 in order to reduce this heat loss.

During the development of the SAGE III on ISS payload, thermal engineers at NASA LaRC learned that Tayco Engineering, Inc. (the project’s heater vendor) does not recommend the use of aluminum over-tape due to concerns that it prevents gas/moisture from escaping the Kapton® heater surface when placed in a vacuum environment, which can lead to the to formation of bubbles (and thus local hot spots) in the heater. The SAGE III team contacted Tayco Engineering, Inc. to find out more about this recommendation and attempt to understand why it is different from some practices within the thermal community. The original recommendation to use aluminum tape as a heat spreader did indeed come from Tayco Engineering, Inc.; however, it was intended specifically for the situation in which a heater is mounted to a thin non-metallic structure. The recommendation was to apply aluminum tape to the non-metallic structure underneath the heater, thereby creating a heat flow path. This recommendation was mis-interpreted at some point to mean that aluminum tape should be applied over Kapton® heaters, regardless of the type of mounting surface. Over time, this became a practice in some of the thermal community. When the heater is applied to a structural aluminum substrate, as all of the SAGE III heaters were, the very thin aluminum layer present in the aluminum tape adds a negligible heat transfer path compared to the aluminum substrate itself. Based on this information, SAGE III decided not to use aluminum over-tape. All of the SAGE III heaters were mounted to metallic surfaces that were at least 50 times thicker than the aluminum tape and therefore provided sufficient heat sinking capability. The team agreed that it was prudent to follow manufacturer recommendations unless there was a compelling technical reason not to do so.

5.3 Thermostats

Thermostats are the most common heater controlling device. A thermostat consists of a bi-metallic switch packaged within a hermetically sealed housing that opens and closes at a predetermined temperatures. The temperatures at which the circuit opens or closes are set by the internal construction of the device. The actuation point temperature is bounded within a range, known as the deadband, which can be as small as 1°C, or as high as 10°C. Normally, the narrower the band is, the higher the cost. Most thermostats have wider bands such as 4°C to 5°C that offer reasonable compromise between cost and performance. Each thermostat is individually tested over the operational range for predictable performance.

It is recommended that high current or small deadband (i.e., <5°C) be avoided to avoid “dithering”. Internal self-heating can cause the thermostat to open even as the hardware temperature being controlled is dropping below the set-point.

For increased reliability, a thermostatic controlled heater circuit contains two thermostats arranged in series with the heater. In this arrangement the heater cannot remain permanently on for having the

 National Aeronautics and Space Administration	NASA Passive Thermal Control Engineering Guidebook	Revision: 4.0
	Date: 9/25/2023	Page 123 of 202
	Distribution Restrictions: Publicly available	Security Classification: Unclassified

thermostat stuck in the on position. However, the circuit could fail if one of the two thermostats is stuck in the open position, so it is considered one fault tolerant to “fail closed”, but zero fault tolerant to “fail open.” Parallel thermostats can provide fault tolerance to “fail open.” Consult with the local S&MA organization relative to failure modes and fault tolerance for your project to determine the best thermostat redundancy scheme.

Another type of thermostat are “solid state” thermostats, which provide simple proportional control based on a temperature sensor (e.g., RTD, PRT, etc.), which can provide tighter temperature control and are “distributed” to the heater control area and reduce wire/cable requirements compared to central computer-controlled heaters. These devices also have programmable setpoints which allows flexibility as the design matures. Many satellite aerospace companies have proprietary in-house solid state thermostat designs. MSFC developed an in-house programmable thermostat for the Multi-Purpose Logistics Module (NASA/TM-2007-214957).

NASA users may find more information on the internal Agency shared drive at the links below:

- SAGE lessons learned
- MSFC EV34 Best Practices – Considerations for Heaters in Thermal Design
- Agency OneNote® notebook section on thermostats

5.3.1 Selection

The following should be considered in selection of thermostats. The thermostat inventory list from the SAGE III project is provided to Agency users on an Agency shared drive as an example of these considerations.

- Thermostats are normally used for survival heaters, since they can provide a purely mechanical switch for activating heaters, based on the temperature of the hardware, with no electronics or software needed to be operational.
- In selecting thermostats, one should define set points such that there is ample margin between the set point and the hardware limit, provided the selected heaters can maintain the hardware at the set point (taking into account any requirements related to heater duty cycle).
- If there is an auxiliary set of heaters, using auxiliary thermostats, define the auxiliary set points at least 3-5°C cooler than the main set points. This will allow the auxiliary heaters to function as a true backup, and will activate only if the primary have failed.
- It is optimal to select thermostats with a minimum deadband of approximately 5°C; however, be aware that larger deadbands provide higher reliability.
- Use of series redundancy thermostats prevents a single, failed closed circuit from continuously energizing a heater. In some instances where very high reliability is needed, quad redundancy may be employed (2 series thermostats in parallel with 2 additional series thermostats).
- When determining whether to use mechanical thermostats or software-controlled thermostats, consider the reliability/simplicity of the mechanical type versus the benefits of being able to adjust set point with the software-controlled type (this is especially useful in test).
- NASA users may find more information related to selecting thermostats (including tolerances, voltage ratings, etc.) on the internal Agency shared drive in the Agency OneNote® notebook section on thermostats.

 National Aeronautics and Space Administration	NASA Passive Thermal Control Engineering Guidebook	Revision: 4.0
	Date: 9/25/2023	Page 124 of 202
	Distribution Restrictions: Publicly available	Security Classification: Unclassified

5.3.2 Procurement

- Select stock units when possible, to save time and reduce complexity.
- Start a vendor search early in order to ensure that any vendors that can meet requirements are identified
- While it is not required to conduct acceptance testing on all units to confirm data provided by the vendor, it is a good idea to test the units that are selected for flight, prior to installation on flight hardware.
- Consolidate acceptance test data for thermostats in a single location so that it is easy to reference and to select alternate units when necessary.

5.3.3 Installation

- Thermostats are normally fastened to the hardware using screws, but good practice is to also use a thermally-conductive epoxy on the bondline to assure good thermal contact.
- Thermostats should be positioned reasonably close to the heaters they will be controlling so that the hardware cannot fall too far below the setpoint temperature of the thermostat. However, the thermostat should not be right on top of the heater, or the thermostat may open before the hardware has fully responded to the heater. A good common practice is to position the thermostat 0.5” – 2” away from the heater edge.

5.4 Thermal Interface Materials

MSFC conducted some performance testing of 20 thermal interface filler materials in a bolted aluminum interface in vacuum and documented in NASA TM-2003-212500. The memorandum does not provide estimated resistance since the test apparatus did not adhere to all ASTM® standards, but it provides good relative performance indicators. One finding was that the performance in the bolted joint did not correlate well with the manufacturer’s published data. It is recommended that characterization/development tests be performed for mission-specific critical interface locations and not rely solely on vendor data.

5.4.1 Printed Circuit Board Assemblies and Components

The following considerations should be made when selecting interface materials for thermally-sensitive printed circuit board assemblies and/or components:

- **Temperature Range** – The temperature range specified by the manufacturer should meet or exceed the temperatures expected at the interface.
- **Thermal Conductivity and Gap Thickness** – While thermal conductivity is an important consideration, the majority of TIMs are relatively poor conductors, so it’s important to keep TIMs as thin as possible. As gap thickness increases, higher thermal conductivity materials become more desirable.
- **Electrical Conductivity** – Some TIMs are either electrically conductive or insulative, so choose the material that best fits the application. Generally speaking, electrical conductivity increases with thermal conductivity.

- **Outgassing** – For contamination-sensitive payloads, some materials may be prohibited such as silicones. A good source to check outgassing measurements of specific materials: <https://outgassing.nasa.gov/>
- **Diode Location** – The location of the diode within the part package should be considered when choosing the surface to apply an interface material.
- **Contact Pressure** – Some solid TIMs are sensitive to contact pressure. Indium foil, for example, is not suited for pressures greater than 400 psi, and many thermal pads specify a maximum compression ratio.
- **Product Availability** – Most TIMs are readily available; however, some have lead times of four weeks or greater.

5.4.1.1 Experience from SAGE III

A variety of Thermal Interface Materials (TIMs) were used within the SAGE III Interface Adapter Module (IAM) to prevent Printed Circuit Board (PCB) assemblies and components from overheating.

In general, board-level components should be selected during the design phase such that overheating will not become an issue. However, in cases where this is not easily avoided, or simply cannot be avoided due to part availability issues, etc., thermal interface materials may be used to aid in thermal mitigation of the part. Table 8 details the internal IAM electronic components that utilized interface materials, as well as the type of material used.

Table 8. Interface Materials Used in the SAGE III IAM

Board	Component Description	Designator	Interface Material
SSMC	Monolithic Op Amp, 5962R8964401VPA	U2,U3	Loctite® Stycast® 2850 FT/Catalyst 9
	64Gbit FLASH, 3DFN64G08VS8305 MS	U6,U7,U8	Loctite® Stycast® 2850 FT/Catalyst 9
120V Contingency	Diodes, OM5007ST	D1, D15, D2, D16	Loctite® Stycast® 2850 FT/Catalyst 9
	Filters, AME270461 X/CH	FL1, FL2	Indium, 0.005 in thick
	Converters, AFL12015DY	PS5, PS6	Indium, 0.005 in thick
120V Operational	Diodes, OM5007ST	D1, D2	Loctite® Stycast® 2850 FT/Catalyst 9
	Fuse, P600L-135-5.0	F2	Loctite® Stycast® 2850 FT/Catalyst 9
	Solid State Relay, 53258	RL1, RL2	Loctite® Stycast® 2850 FT/Catalyst 9

 National Aeronautics and Space Administration	NASA Passive Thermal Control Engineering Guidebook	Revision: 4.0
	Date: 9/25/2023	Page 126 of 202
	Distribution Restrictions: Publicly available	Security Classification: Unclassified

Board	Component Description	Designator	Interface Material
FPGA Controller	POL Converter, DC/DC, MFP0507S	U7	Arathane® 5753/BN PT620
28V Operational	Fuse, FM12	F88, F96	Loctite® Stycast® 2850 FT/Catalyst 9
	Relay, MP53250	RL1, RL2, RL11, RL28	Loctite® Stycast® 2850 FT/Catalyst 9
	Converter, M3G280515T	U3	Indium, 0.005 in thick
	Converter, M3G2805S	U2	Indium, 0.005 in thick
	Converter, M3G2805S	U1	Indium, 0.005 in thick
	Converter, M3G2805S	U1	Indium, 0.005 in thick

In most cases, Loctite® Stycast® 2850 FT/Catalyst 9 epoxy, a thermally conductive epoxy, was applied underneath the part to increase heat transfer to the board. This material was selected based on several factors, but primarily because of extensive application experience with LaRC technicians, its higher thermal conductivity (relative to other epoxies), and low outgassing properties. In other cases, Stycast® epoxy was used at interfaces with copper thermal straps which extended from the topside of surface-mounted parts to a major heat path or sink.

Another material used was a mixture of Arathane® 5753 casting compound, Boron Nitride (BN) PT620, and MIL-PRF-9954D No. 8 glass beads. After mixing the Arathane® 5753 casting compound with BN PT620 at a 3:2 ratio, the mixture was applied to the mating-surface of the part, then glass beads were sprinkled at each corner prior to installation on the board. The glass beads served to limit the thickness and prevent crushing of the BN PT620 particles.

Indium foil, which has an exceptionally high thermal conductivity and is malleable enough to fill in small cavities between mated surfaces, was selected for components with high heat dissipation and for those that were installed with mechanical fasteners (as opposed to soldered attachments for which indium foil is not suitable). It is important to note that indium foil is only acceptable where contact pressures do not exceed 400 psi. Greater pressures may result in loss of preload due to cold flow caused by thermal cycling and/or vibration testing.

Interface materials were also used inside the IAM to decrease thermal resistance between printed circuit boards and the structure they were mounted to. In most cases, the contact pressure in these areas was greater than 400 psi, and therefore, copper Heat-Spring® foil was used. Heat-Spring® is a thin metal foil pressed into a wave-form, spring-like shape that increases heat transfer between two surfaces when compressed. This is especially true for surfaces that are milled without a tight surface-roughness specification. Heat-Spring® was used in the PDU board stack (which followed a traditional PCB stacking configuration utilizing standoffs and spacers) along the edges of each board, the primary heat path to the chassis. In addition to component-to-board interfaces, indium foil was used at structural interfaces between the PDU top/bottom assemblies and chassis given that contact pressures were less than 400 psi.

 National Aeronautics and Space Administration	NASA Passive Thermal Control Engineering Guidebook	Revision: 4.0
	Date: 9/25/2023	Page 127 of 202
	Distribution Restrictions: Publicly available	Security Classification: Unclassified

Another example of using a thermal interface material within a circuit board assembly was with the Exploration Upper Stage (EUS) Flight Imaging Launch Monitoring Real-time System (EFILMRS) project at MSFC. EFILMRS designed and qualified cameras that will fly on SLS EUS to monitor flight events, such as stage separation. The camera's design consisted of selecting an off-the-shelf camera (e.g., Imperx™ Cheetah IMX174 camera), then repackaging in a ruggedized housing. Because the camera vendor did not design for vacuum compatibility, an encapsulate material (Cytec® Conathane® EN-11 material) was used at MSFC to remove the heat from the chips and boards. The encapsulation was also used within an off-the-shelf housing as shown in Figure 30. Figure 31 shows encapsulating the EFLIMRS camera that includes a MSFC ruggedized housing.

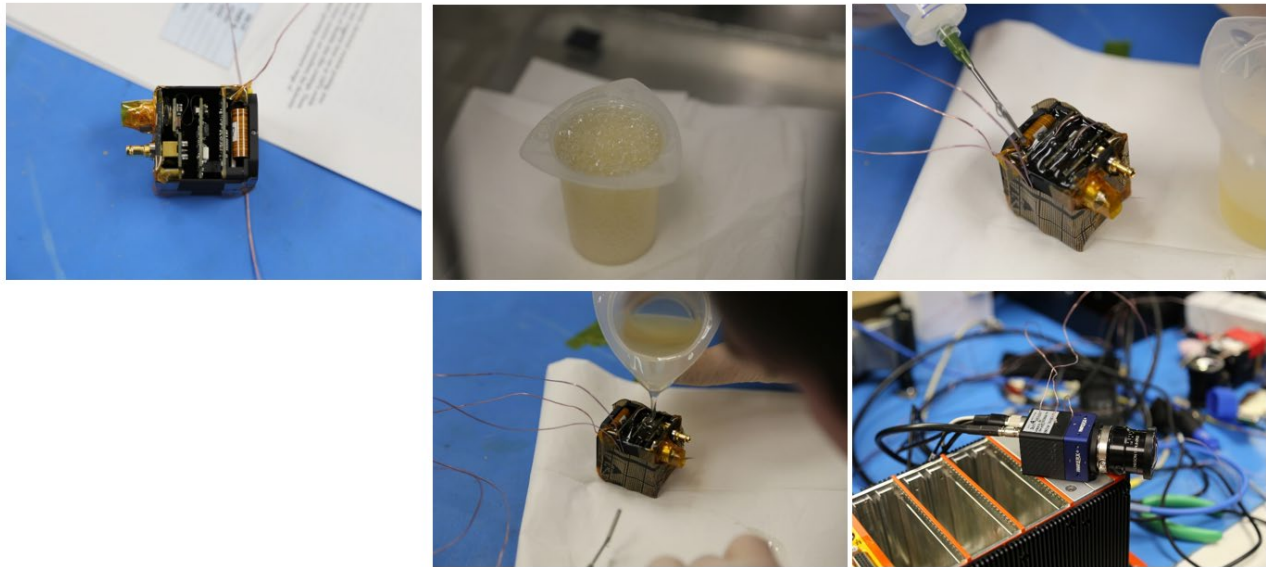



Figure 30. Encapsulation of COTS Camera from Imperx, Inc. (Cheetah SDI-2010 camera)

 National Aeronautics and Space Administration	NASA Passive Thermal Control Engineering Guidebook	Revision: 4.0
	Date: 9/25/2023	Page 128 of 202
	Distribution Restrictions: Publicly available	Security Classification: Unclassified

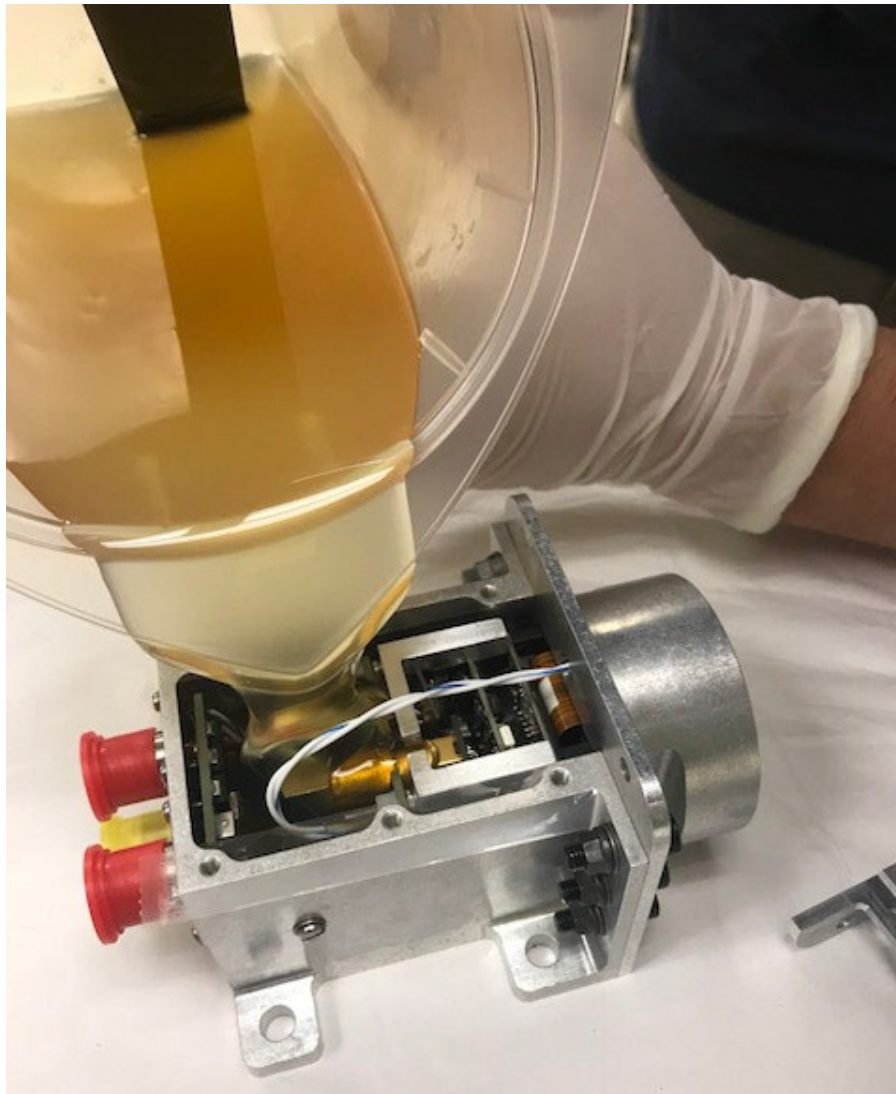



Figure 31. Encapsulation of EFILMRS Camera

5.4.2 *Installation of Electronics Boxes*

5.4.2.1 Experience from SAGE III

Early thermal analysis showed that heat rejection via radiation alone would not be sufficient for the Interface Adapter Module (IAM). Because the IAM only had fasteners on two sides (approximately 20” span between the sides with fasteners), instead of around the perimeter, there would not have been good thermal contact between the IAM and the EXPRESS Pallet Adapter (ExPA) without the addition of a thermal interface material. Three design iterations were required before an acceptable thermal interface material was found for the IAM-ExPA interface.

Indium foil was initially selected as the thermal interface material because of its high thermal conductivity and space flight heritage. It was later determined that this was not acceptable for two reasons. First, indium is subject to cold flow which could result in a loss of preload over time due to thermal cycling and vibration testing. Second, there was a potential to trap gas by covering the blind holes in the ExPA.

 National Aeronautics and Space Administration	NASA Passive Thermal Control Engineering Guidebook	Revision: 4.0
	Date: 9/25/2023	Page 129 of 202
	Distribution Restrictions: Publicly available	Security Classification: Unclassified

The next interface material that was chosen was a Gap Pad® 2200SF thermal pad. This material is a silicone-free thermal pad that is available in a wide range of thicknesses and has good conductance when compressed. There was no known spaceflight heritage for this material and there was some concern about issues with this material in a high-vacuum environment. A test was performed in a small TVAC chamber to evaluate the material’s suitability. During this test, uncompressed and compressed samples (various levels of compression) were subjected to 100°C and vacuum for approximately 72 hours. Upon completion of the test, it was found that a yellow condensate had formed on the oven surfaces during the test and the uncompressed specimens had become hard and brittle. The thermophysical properties of the specimens were then tested and compared to un-tested material. As a result of these findings, it was determined that this material would not be suitable for use for the IAM-ExPA interface.

The material that was finally selected for the IAM-ExPA interface was NuSil® CV-2946 silicone, a thermally conductive, platinum impregnated silicone. This material has extensive spaceflight heritage and good thermal conductance. Additionally, it is easily removable from flight hardware (with or without a release agent, in absence of primer). Subsystem-level TVAC testing provided verification that the material would perform as desired.

SAGE III team members travelled to GSFC for hands-on training in the application of NuSil® silicones. Several practice applications were performed at LaRC using mock-ups of flight hardware. A procedure for applying NuSil® silicones to the IAM-ExPA interface was developed based on these training experiences (SAGE III-10-140).

MSFC ES22 conversations with GSFC included guidance that if a gap filler requires pressure (e.g., an avionics box with bolts around the perimeter, using CHO-THERM® 1671 thermal insulator pads as a filler), then it is recommended to assume that the contact area is picture frame around the edge of the box that covers 20% of the contact area. This is because the contact pressure of the bolts at the edge will not extend across the entire box area. However if an adhesive is used (e.g., RTV or epoxy), and it covers the entire area, then the entire area can be assumed to be contacted in the thermal model.

5.5 Thermal Straps

5.5.1 *Selection/Design*

Thermal straps are flexible joints used to provide a conductive link between two surfaces. This is particularly useful when a high conductivity thermal path is necessary, but a stiff structural connection is undesirable or not possible. Such a situation may arise from space constraints, the need for vibration isolation, relative motion between the two surfaces, or accommodation of thermal expansion and contraction. An example use case is to connect detectors to coolers to minimize impact of the cooler on the detector package (e.g., multiple load paths, vibration isolation).

Thermal straps are typically constructed out of flexible laminate thin foils or braids of high conductivity material such as copper, high purity Aluminum or Annealed Pyrolytic Graphite (APG). A thermal strap typically consists of a flexible foil or braided cable with terminal blocks at each end. Straps made with braided cables are more flexible than foil straps, but foil straps usually offer higher thermal conductance. Materials used for thermal straps include copper, aluminum, graphite fiber, pyrolytic graphite, and graphene. Choice of material depends on requirements on flexibility, durability, thermal conductivity, mass, temperature range, and cost. Metallic braided straps are the most flexible, followed by graphite fiber straps, metallic foil straps, and carbon-based foil straps. In terms of thermal conductivity, carbon-based

 National Aeronautics and Space Administration	NASA Passive Thermal Control Engineering Guidebook	Revision: 4.0
	Date: 9/25/2023	Page 130 of 202
	Distribution Restrictions: Publicly available	Security Classification: Unclassified

straps offer much higher conductivities than copper or aluminum, however they are much more expensive and can be less durable. Thermal performance also depends strongly on the operating temperature range.

Manufacturers offer standard sizes of thermal straps, however many offer custom design solutions. Strap length, number of braided cables, foil width, terminal block configuration, and overall shape can be customized. Terminal blocks can be customized with bolt/screw hole patterns, or could be shaped to interface with hardware, e.g., cryocoolers or heat pipes. If the terminal block will be bolted or screwed down, it is recommended to use a thermal interface material to minimize the thermal contact resistance. In some situations, it may be advantageous to weld, braze, or solder the terminal block directly to the surfaces. Some vendors offer gold or nickel plated terminal blocks for increased corrosion resistance and emissivity. Gold coatings may also decrease thermal contact resistance. Straps can also be purchased with an aluminized Mylar overwrap to reduce radiation heat transfer. For graphite fiber straps, this overwrap also serves to enclose the fibers which can fray and fracture, causing unwanted foreign object debris. However, the overwrap can also prevent air from escaping if operation in a vacuum environment is expected.

There are two parts to a thermal strap: 1) terminal blocks and 2) flexible strap material. The critical dimensional parameters of each thermal strap are the cross-sectional area (A) and the total length of the flexible material between the terminal blocks (L). These two dimensional parameters are the values in the A/L ratio. The higher the ratio, the higher the thermal conductance of the thermal straps.

The following are several materials that are commonly used:

1) Aluminum foil:

This is the most common type of thermal straps that are used at JPL. Aluminum foil thermal straps are the preferred type of thermal straps because of the high conductivity and low density material properties of aluminum.

2) Copper foil:

For applications that require higher conductance values, copper foil thermal straps have also been used. Copper foil thermal straps have higher conductance values but also higher density. Due to their higher density, copper foil straps are sometimes not the preferred solution.

3) Copper braid:

Similar to copper foils, copper braids are used for applications that require higher conductance. To select the copper foil or the copper braid for use would be determined by the thermal engineer. Typically, copper braids have been used for applications that do not require flexibility constraints.

4) Graphite foils:

Higher power dissipation applications have been increasing significantly and pushing the traditional aluminum thermal strap designs to be too large and massive. The graphite foil have higher conductivity (roughly 7x) and less mass (roughly 1/2x) than aluminum foils. As power density of components increase, graphite foil thermal straps are becoming an option.

 National Aeronautics and Space Administration	NASA Passive Thermal Control Engineering Guidebook	Revision: 4.0
	Date: 9/25/2023	Page 131 of 202
	Distribution Restrictions: Publicly available	Security Classification: Unclassified

5.5.2 Lessons Learned

The NASA Lesson Learned Information System (LLIS) contains lessons that have been learned through hardware design and fabrication. In designing and fabricating thermal straps, NASA users with access can utilize the references shown in Table 9.

Table 9. Lessons Learned on Thermal Straps

Lesson Learned Category	Description	Locations inside NASA firewall
Thermal Strap Joint Relaxation and Material Creep	Thermal straps often use soft materials such as aluminum 1100 and indium. When these materials are tightened in a thermal strap joint, they can creep, leading to a loss of pre-load and loss of effective thermal contact. Care must be taken not only in design of the joint and selection of materials, but also in selection of torque values and re-torque schedules.	LLIS OnePlace (LaRC internal site)

5.6 Thermal Tapes

In addition to the information provided in this section, NASA users may find more information at the locations below:

- OnePlace - SAGE III lessons learned (LaRC internal site)
- Agency OneNote® notebook section on tapes
- Sample installation procedures on an Agency shared drive

5.6.1 Selection

Degradation of the optical properties over the life of the mission should be considered in selection of a tape. In general, virgin properties (BOL) are used for the cold cases and degraded (EOL) properties are used for hot cases. There is data on the degradation of material properties in space in NASA TP-2013-217498 and in the Agency OneNote® notebook section on tapes.

Below are some considerations for selecting silver Teflon® tape:

- Consider the tradeoff between fragility and performance when determining whether to use dimpled or non-dimpled tape. It may be a good idea to order a small quantity of both tapes to determine differences in how easily damaged they are during handling.
- Consider carefully whether or not to order silver Teflon® tape with a protective overlay. It does not fully protect the surface of the tape and if team members do not understand this then team members may be less cautious and may actually be more likely to damage the tape.

 National Aeronautics and Space Administration	NASA Passive Thermal Control Engineering Guidebook	Revision: 4.0
	Date: 9/25/2023	Page 132 of 202
	Distribution Restrictions: Publicly available	Security Classification: Unclassified

5.6.2 Procurement

Due to the shelf life limitations, it is best to order the tape as close to the time of application as possible without creating unnecessary schedule risk (tape order should not be in the critical path).

5.6.3 Installation

Creating templates for tape and making tape kits ahead of time works very well and may be a good investment of time for applications involving complex geometry. It allows the team (thermal engineer, mechanical engineer, technician(s), quality assurance, contamination control) to work through the details and to communicate them clearly in advance of installation. This approach also streamlines the installation process since tape does not need to be measured and cut during installation.

Rather than cutting around fasteners, it is best to keep shapes as simple as possible (i.e. rectangular strips) and to only complicate shapes where it is absolutely necessary.

If a protective overlay is used, then it should be removed as late in the I&T flow as possible.

Only experienced technicians should apply tape to flight hardware. When a technician is learning to install tapes, he or she should first observe someone with experience and then practice on non-flight hardware before performing flight installations.

5.7 Thermal Control Surface Treatments

Paints and other thermal surface finishes have more use than just to protect the base parts from corrosion. Paints and finishes can be used to reflect or absorb heat. Spacecraft require thermal control so almost all visible interior and exterior surfaces are thermal control surfaces. Certain spacecraft surfaces are finished with white or black paints.

White paints are used to radiate or reflect heat while black paints are generally used to absorb heat. Radiator surfaces are often painted with white paints, such as S-13 GLO S-13 GLO (absorptance= 0.2 to 0.5 and emittance=0.88), or Z93 (absorptance= 0.15 to 0.5 and emittance=0.9). Radiator surfaces are often painted with white paints, such as S-13 GLO (absorptance= 0.2 to 0.5 and emittance=0.88), or Z93 (absorptance= 0.15 to 0.5 and emittance=0.9). Painting a radiator surface is not the best choice because white paints tend to degrade over time due to UV exposure and analyses need to include beginning of life (BOL) and end of life (EOL) property cases. The second surface aluminized Teflon® coated or Optical Solar Reflector (OSR) coated surface offers better choice in controlling solar absorption.

Black paints are most suitable when sunlight is not present. Chemglaze® Z-306 paint (absorptance= 0.95 and emittance=0.87) is a commonly used black paint to finish internal panels, digital boxes or the back side of a solar array. Chemglaze® coating tends to outgas in the beginning phase of application, though at an acceptable rate for many spacecraft applications.

Paints must be properly applied to obtain the proper thermal performance and specialized paints are expensive. Less expensive paints can be used for experimental or low budget projects but all requirements must be understood. The exterior of the Ares I-X Upper Stage Simulator (USS) used a thermal roof paint for commercial buildings that resulted in significant cost savings over Z93. Potential alternatives were

 National Aeronautics and Space Administration	NASA Passive Thermal Control Engineering Guidebook	Revision: 4.0
	Date: 9/25/2023	Page 133 of 202
	Distribution Restrictions: Publicly available	Security Classification: Unclassified

tested before use at the KSC Beachside Atmospheric Test Facility. Data on several low-cost white paints tested are available to Agency users on an internal share drive.

For the exterior of launch vehicles like the Ares I-X, triboelectrification needs to be considered. Triboelectrification is a static-generating condition created by flying through moisture-laden clouds that can interfere with radio signals to and from the vehicle. Ares I-X was not informed of the requirement until on the launch pad so its exterior paint had not been tested for triboelectrification. Without verifying that the paint met triboelectrification requirements, launch required nearly cloud-free skies.

Extensive information is available on paints in the literature. The user should research various options before resorting to any particular type of finish.

5.8 Multi-Layer Insulation (MLI)

In addition to the information provided in this section, NASA users may find more information at the locations below:

- OnePlace - SAGE lessons learned (LaRC internal site)
GSFC 549-WI-8072.0.2 Design and Fabrication of Thermal Blankets
- GSFC 549-WI-8072.0.7 Thermal Blanket Grounding
- 1F67001-1 ISS Thermal Blanket Design Specification
- 1F02707-1 ISS MLI Requirements

5.8.1 *Materials*

If using beta cloth as the outer layer, consider using aluminized beta cloth on the inside of the outer layer of MLI as a light-blocking layer to ensure that the inner MLI layers will not get too hot, and also to protect underlying Kapton® laminate from erosion due to atomic oxygen, keeping in mind potential grounding requirements. Ensure that grounding of that aluminized layer is included in the design.

Particulate shedding is a concern for certain applications of aluminized material. Obtain agreement on materials as early in the process as possible, including the contamination control engineer.

Materials are often baked out prior to fabricating blankets to minimize contamination, but a full bakeout is typically required after fabrication.

Blankets with a Germanium Kapton® laminate outer layer can be easily damaged via handling or exposure to moisture. Other cautions for this material:

- Will oxidize in a humid environment
- Must be placed in a nitrogen-purged bag after opening sealed shipping container
- Bags must include a metallized moisture barrier (Contact Dave.Rowe@Multek.com for more information; they have a root cause report on this issue: http://esmat.esa.int/materials_news/isme09/pdf/3-Ground/Poster%20Groung%20Testing%20-%20Cesar-Auguste.pdf)
- Can have issues with particle generation

 National Aeronautics and Space Administration	NASA Passive Thermal Control Engineering Guidebook	Revision: 4.0
	Date: 9/25/2023	Page 134 of 202
	Distribution Restrictions: Publicly available	Security Classification: Unclassified

- Stated shelf life is only one year when stored in original unopened container:
<https://www.sheldahl.com/sites/default/files/2017-09/Germanium.pdf>

Additional material Guidelines for MLI can be found in NASA TP-1999-209263.

5.8.2 MLI Design

Detailed thermal analysis is the best way to determine the number of layers and the outer finish requirement for a MLI blanket. For most panel coverage, a 10-layer blanket is sufficient. A higher number of layers may be required for applications in cooler environments. Conversely, a lesser number of layers are needed for covering tubular surfaces. As an example of a higher number of layers, the optical bench on Chandra X-Ray Observatory is 25 layers due to a very tight dimensional stability requirement, the need for removing thermal gradients, and the need to meet heater power limits.

Blankets should be over-sized slightly so that the fit can remain loose. All blankets should be fit-checked using a template prior to fabricating.

Blankets are typically grounded to the structure to dissipate static charges, with the number of grounding wires typically being based on the surface area of the blanket. For many spacecraft applications, each MLI blanket needs to contain two conductive straps for grounding. The length of the grounding wire and size of the grounding lugs must be carefully determined based upon the expected availability of grounding locations in the flight configuration; this requires coordination with electrical, mechanical, and systems engineering teams.

Each blanket must contain adequate vent passages after it is installed. The required vent area is calculated individually for each blanket. Ensure that all blankets are vented such that venting will occur away from contamination-sensitive surfaces.

When considering how blankets will attach to hardware, there are multiple options including transfer adhesive, hook-and-loop material, lacing cord or ty-wraps tied through a mechanical feature on the hardware, and buttons. If transfer adhesive is to be used, it is important to ensure that there is sufficient surface area for contact between the blanket and hardware (otherwise, the blanket may not adhere as intended). Other considerations when determining attachment method include contamination (can be a concern with hook-and-loop), complexity (must be considered if attachment hardware such as buttons must be placed with precision), and redundancy (having at least two types of attachment can help reduce the risk of a blanket detaching from the hardware).

Consider blankets for wrapping cables if necessary, and also blankets to act as finger guards against finger entrapment if necessary. One objective for wrapping cables is to provide the cables a layer of protection from potential damage or degradation resulting from Micrometeoroid and Orbital Debris (MMOD) and exposure to Atomic Oxygen (AO). The blanket also serves to block cable components from direct

 National Aeronautics and Space Administration	NASA Passive Thermal Control Engineering Guidebook	Revision: 4.0
	Date: 9/25/2023	Page 135 of 202
	Distribution Restrictions: Publicly available	Security Classification: Unclassified

exposure to solar radiation, generally reducing the surface temperature where applied. If wrapping cables, plan how to incorporate connector boots.

Test blankets should be designed to be as similar to the corresponding flight blankets as possible based on the known information, with the understanding that final model correlation will be done at the payload level with flight blankets in place.

Below are some best practices related to documentation of MLI design:

- Thoroughly document and configuration manage the MLI design process. Details can be easily lost if not properly documented. Furthermore, if it becomes necessary to change the vendor during the process, then it is critical to have design details documented clearly.
- Blanket drawings should include overall dimensions, design notes, and a full bill of materials (BOM). Specific dimensions may be better handled via physical templates, so as not to over-constrain the designed and to reduce the number of required drawing revisions.
- Determine a labeling scheme for the blankets early in the design process, and be clear and consistent with respect to what information should go on blanket labels.

5.8.3 Procurement

Some known MLI blanket vendors are listed on the Agency OneNote® notebook, for NASA users. Below are some general tips for procuring MLI blankets:

- If blanket design and fabrication will occur on a contract, allow a minimum of 2 months for proposal, 2 months for RFQ release, and at least 2 months for the contract to be issued.
- Be aware that materials for MLI can be long-lead items, with some taking 6 months or more to arrive.
- Ensure that requirements are clearly defined for materials, number of layers, bakeout, grounding, venting, size, coverage, and any specialized needs.
- Be sure to include templating, drawing/procedure development, material/tool procurement, fit checks, repairs, and installation in the MLI contractor's statement of work in addition to fabrication of the blankets. This forces the team to think through what is really needed and will help to avoid cost and schedule over-runs later.
- If possible, request that the vendor conduct or assist with fit checks and flight installation. Vendor expertise during troubleshooting can be very valuable.
- Weigh the benefits of fabricating flight spare blankets (schedule savings if issues arise late in the I&T flow) versus the cost (materials, upfront fabrication time for items that may never be needed). Consider the level of time and difficulty of fixing flight blankets if spares are not available.

5.8.4 Fit Checks

Performing fit checks is an important part of the MLI design and fabrication process. If possible, schedule should allow for an initial and final fit check on flight hardware, along with time to modify drawings and blankets after each fit check (required time should be much less following final fit check).

 National Aeronautics and Space Administration	NASA Passive Thermal Control Engineering Guidebook	Revision: 4.0
	Date: 9/25/2023	Page 136 of 202
	Distribution Restrictions: Publicly available	Security Classification: Unclassified

Fit checks should be performed on mock-ups or EDUs whenever possible, as this can greatly reduce the number of blanket modifications that are needed at the time of final fit check on flight hardware. Having a full-scale mockup to use for fit checks is ideal, but not always possible. It is critical to make sure that differences between the mock-up and flight hardware are understood. This includes differences in cable sizes and routing.

Separate procedures may be needed for fit-checking templates, performing the initial flight blanket fit check, and final flight blanket fit check. Procedures should include the following:

- Ensure blankets are grounded before contacting flight hardware
- Confirm locations of slits, VELCRO® fasteners, snakebites, filters
- Confirm fit and function are as desired
- Confirm full range of travel for any moving parts
- A place to capture any necessary changes in writing and on the templates themselves (if applicable)

Fit checks should generally be conducted with the blanket designer, thermal engineer, mechanical engineer, and QA representative (varies depending on project requirements). Ensuring that an experienced blanket designer / technician performs the fit check can significantly reduce the amount of changes that are necessary during flight installation.

5.8.5 *Inspection and Repair*

MLI blankets should be acceptable from the thermal, contamination, and electrostatic discharge (ESD) perspectives any time that they are installed on the flight hardware. To accomplish that, there should be a threshold of acceptable damage defined such that any time the blankets are handled, they will be compared to that standard to ensure that their performance will be successful. Processes should be in place to repair or replace blankets if necessary.

Inspections should occur upon receipt of blankets and prior to all installation activities (fit check, test installation, and final installation).

The thermal, contamination and test leads should all have the authority to determine that an MLI blanket has a level of damage that necessitates convening of a Materials Review Board (MRB) to determine path forward. The leads should evaluate qualitatively for “use-as-is”, “repair” or “replace before flight” dispositions.

Conditions that can trigger “repair” or “replace” dispositions can include:

- External vent holes are taped over or sealed closed
- A rip, tear or hole exists in the blanket that is more than 1.5” long, or covers more than 5% of the blanket area
- Visible discoloration or tactile (sticky) contamination of the blanket is evident over more than 5% of the surface area.
- Numerous particulates are visibly present on the blanket

 National Aeronautics and Space Administration	NASA Passive Thermal Control Engineering Guidebook	Revision: 4.0
	Date: 9/25/2023	Page 137 of 202
	Distribution Restrictions: Publicly available	Security Classification: Unclassified

- There was known contamination of the blanket that is no longer visible (for example, a fluid spilled on the blanket and seeped into the inner layers)
- An installed blanket has obvious and extreme looseness in any area, or there are places where the blanket is pulled so tight over a corner that the layers are obviously compressed to the point of thermal short and potential tear-through
- An articulating component does not have full range of motion due to restriction of a blanket
- Stitching is frayed to the point that it appears that tearing is imminent
- Velcro is worn to the point of not adhering, or of throwing off excessive contaminants
- Discoloration of outer layer (could be indicative of outgassing or loss of coating)
- Grounding wires / lugs are not consistent with payload or vehicle-level grounding requirements

An additional aspect of MLI blanket inspection will often include resistance measurements to ensure that the blankets are properly grounded. Specific requirements will vary from project to project, but one point of reference is GSFC 549-WI-8071.0.7 Thermal Blanket Grounding.

5.8.6 Installation

For installation of test blankets, see also section 6.1.7.6. The following considerations are important in planning and performing installation:

- It is best to avoid contact between the MLI outer surface and hardware surfaces if possible, but it in general will not materially affect performance if there are intermittent points of contact (the exception may be cryogenic blankets). Standoffs of G10 or G11 are a good idea if maximum effectiveness is desired.
- When folding and cutting, creases and sharp corners should be avoided where possible (allow enough material so that it can “poof” out, for lack of a better term). That said, it is often impossible to avoid bending the material over the hardware in such a way that there are no creases or sharp corners.
- One note is that the MLI is not going to be very effective around its edges since the material is normally taped together at the edges, so fastening the blanket to the hardware along the edges, will not have a large impact on blanket effectiveness. The idea is to have enough material that it can billow out wherever it is not taped.
- When taping, the goal is to minimize any view from the hardware to the surroundings, so the intent is to not leave gaps.
- Create a single receipt inspection procedure to use for each blanket, with write-ins that allow customization as needed (blanket names, drawing numbers, and any special instructions). Receipt inspection should include the following:
 - Personnel: thermal engineer, contamination control engineer, and Quality Assurance (QA) representative
 - Check for conformance to drawings
 - Check overall appearance (damage and cleanliness)
 - Verify that labels are legible and correct
 - Photograph all blankets
 - Note non-conformances or necessary minor modifications

 National Aeronautics and Space Administration	NASA Passive Thermal Control Engineering Guidebook	Revision: 4.0
	Date: 9/25/2023	Page 138 of 202
	Distribution Restrictions: Publicly available	Security Classification: Unclassified

- Photographs during fit checks, receipt inspections, and installation can be valuable for dispositioning anomalies and keeping track of the process.
- Schedule should allow for blanket closeout following payload level TVAC testing (remove test thermocouples, apply transfer adhesive, make final minor adjustments).
- Installation should include the blanket designer, thermal engineer, mechanical engineer, and QA representative.
- Running cables over the MLI blankets worked well for the SAGE III project because the underlying blankets did not need to be extremely effective. This approach would not be ideal if the blankets need to be very effective, since the blankets are compressed wherever cables are present. Make sure to consider both blanket needed effectiveness, and integration flow, when deciding whether to route cables above or below MLI.

5.9 Thermo-electric Coolers

Eric Grob from GSFC gave a comprehensive course on TECs at TFAWS 2011, available on an Agency share drive and also under ‘Thermo-Electric Cooler Design Course’ on the TFAWS site, <https://tfaws.nasa.gov/TFAWS11/TFAWS%202011%20Proceedings.pdf>.

5.9.1 *Procurement*

In addition to following the process above, it is always a good idea to talk to the vendor to understand all the details that need to be on the purchase order, such as required testing.

5.9.2 *Installation*

TECs are very dependent on effective heat transfer, so the method of mounting them should include careful design to ensure maximum heat transfer. TECs are sometimes purchased with tinned faces, such that the cooled device can be directly soldered on the cold side, and the hot side can be attached with solder. Thin layers of highly conductive adhesive can also be used. In some case mechanical clamping can be used, but great care must be taken to ensure sufficient thermal transfer. The surface to which the TEC will be mounted should be extremely flat, to ensure full thermal contact. Eric Grob’s referenced presentation has additional details. It is a good idea to have thermal sensors on the hot and cold sides to monitor operation. Wires and other connections from the cold side to any warm surface should be limited, to minimize parasitic heat leak, and the design should also work to minimize radiative transfer. The TEC may need to be mounted on a heat sink, for effective capture of the heat dissipation from the TEC and to avoid the hot side warming excessively. For larger assemblies that are cooled by a TEC (or array of TECs), the thermal isolation of the mechanical supporting structure between the cooled assembly and the warmer structure may require careful design to not result in too much stress on the TEC during launch. Assemblies that are supported exclusively by the TEC do not have these parasitic heat leak concerns.

5.9.3 *Operation*

Operation of the TEC will depend on the type; they can be controlled via voltage, current or power. The thermal model of the TEC should reflect the control type used.

5.10 Heat Sinks

Heat sinks are used to stabilize the temperature of a component. They may be used for a simple addition to thermal mass, for example a heat sink on a high-power chip, which absorbs some of the heat from the

 National Aeronautics and Space Administration	NASA Passive Thermal Control Engineering Guidebook	Revision: 4.0
	Date: 9/25/2023	Page 139 of 202
	Distribution Restrictions: Publicly available	Security Classification: Unclassified

chip and decreases the temperature rise. Or, heat sinks may have fins incorporated, to maximize convective transfer to air and help transfer heat away from the component. If fins are used, it is helpful to have some form of forced air flow to help take advantage of the extended fin area. In a radiative-only environment, heat sinks might incorporate some way to maximize radiative transfer away from the component. Heat sinks are normally metallic, to maximize thermal mass and conductivity.

5.11 Fans

For a vehicle or payload that is operating in air, moving air flow is often used to enhance the heat transfer and thus the removal of heat from a component. Sometimes an Environmental Control System (ECS) or air-conditioning will be used. If that is not feasible, another way to effectively provide moving air flow is with small fans. On the Ares I-X vehicle, fans were used, directed at the avionics components to provide cooling for the duration of the pre-launch countdown when ECS was not available. Fans can be extremely effective, but measures may need to be taken to ensure that the fans do not put excessive electronic “noise” onto the power lines while operating. Fans can be used in conjunction with heat sinks, to enhance the removal of heat from a component in an ambient pressure environment.

5.12 Thermal Switches/Shape Memory Alloys

There are number of different types of thermal switches which are available to thermal engineers. Most flight qualified thermal switches use the phase change of paraffin wax from solid to liquid and its accompanying expansion/contraction to actuate a mechanism and create/break thermal contact. For example, this type of thermal switch was flown on the Mars Exploration Rovers (MER) to control the battery temperature. Shape memory alloys also can be used instead of paraffin-based switches, but do not have the same flight heritage that paraffin switches have. In a sense, louvers are a type of thermal switch which are actuated by a bimetallic spring. Louvers are especially useful for missions beyond the asteroid belt since such missions often require thermal control for a Venus fly by as well as for deep space operations far from the sun (> 4 AU). Variable conductance heat pipes and Loop Heat Pipes also are thermal switches in a sense because their conductance can vary as a function of temperature. Loop heat pipes are used on the ESA ExoMars rover for thermal control and reject heat from the rover body in the hot case, but hold onto heat in the cold case. Thermal switches which operated based on gas vapor pressure were developed and flown on the Viking landers in the 1970’s. Finally, a mechanically pumped fluid loop also can serve as a type of thermal switch, since fluid can be routed through the use of temperature actuated control valves as is done on the Mars Science Laboratory (MSL) and Mars 2020 rovers. For some perspective on the topic, Table 10 gives a summary of some of the turn down devices available to thermal engineers.

Table 10. Summary of Turn Down Devices

Device	Mass (Kg)	Approx. Cost (\$)	G _{min} (W/K)	G _{max} (W/K)	Notes
MER Paraffin Heat Switch	0.2 Kg	\$ 0.15M	0.02 W/K	1 W/K	Used on MER; Info taken from SNC Catalog and 2002 ICES papers.

Device	Mass (Kg)	Approx. Cost (\$)	G _{min} (W/K)	G _{max} (W/K)	Notes
Louver (Full Set)	0.8 Kg	\$ 0.15M	~ 0.09 W/K @ 0 C	~ 0.68 W/K @ 35 C	Values shown are for a full set. Lots of Orbital Flight Heritage.
VCHP (Variable Conductance Heat Pipe)	~ 1 Kg	\$ 0.15M	~ 0.1 W/K	~ 10 W/K	Used on OCO2. Must consider ground testing configuration, test in reflux. Controlled using cold side reservoir.
LHP (Loop Heat Pipe)	~ 1 Kg	\$ 0.75M	0.05 W/K	16 W/K	Complex Start Up Transients. Must use heaters for start up. Difficult to integrate since entire system is hermetically sealed.
PFL (Pumped Fluid Loop)	>15 Kg	> \$ 10M	0.75 W/K	15 W/K	Requires continuous power for operation.

A number of vendors are capable of producing heat switches and heat pipes. Users inside the NASA firewall can consult the OneNote pages on heat pipes and thermal switches for more information.

When evaluating thermal switches for use in an application, users should be careful not to give too much weight to manufacturer specifications. The reason is that such specifications, like turn down ratio alone, do not represent the type of performance that can be achieved in a realistic design. Here are a few examples:

 National Aeronautics and Space Administration	NASA Passive Thermal Control Engineering Guidebook	Revision: 4.0
	Date: 9/25/2023	Page 141 of 202
	Distribution Restrictions: Publicly available	Security Classification: Unclassified

- Louvers have a turn down ration of approximately 5 when their effective emissivity is considered ($0.75/0.15 = 5$). However, this ratio does not take into account the temperature dependent nature of radiative heat transfer. For large temperature swings, the turn down ration may in fact be much higher.
- Flat plate heat switches can achieve very high turn down ratios of 78:1: they conduct $607 \text{ W/m}^2\text{-K}$ closed and $7.8 \text{ W/m}^2\text{-K}$ when open. However, when paired with a radiator, the heat switch is very ineffective because the open conductance is the same order of magnitude as a radiator ($\sim 5 \text{ W/m}^2\text{-K}$).

When choosing a heat switch, the entire system must be considered. This includes not only the turn down ratio, but also any minimum or maximum conductance requirements, as well as how parasitic heat leaks will degrade the performance of the heat switch.

5.13 Cryocoolers

Information on NASA cryocooler programs as well as basic information on operation of cryocoolers can be found on the JPL Technical Report Server (<https://trs.jpl.nasa.gov/handle/2014/40122>) and in a NIST summary of cryocoolers (<https://trc.nist.gov/cryogenics/cryocoolers.html>). A useful course on cryocoolers can be found here: <https://nptel.ac.in/courses/112/101/112101004>. Also, the *Spacecraft Thermal Control Handbook*, Volume II: Cryogenics has a wealth of useful information. Here are some high-level take-aways for determining if a given cryocooler has sufficient lift capabilities for your application (based on discussion with member of GSFC Cryogenics and Fluids Branch):

- Apply 100% margin. If cryocooler is capable of lifting 1 W, all thermal loads into the cold tip must not exceed 0.5 W
- Conductive parasitic loads must be considered
- Hand calculations are typically sufficient for first-cut analysis, but must be followed by detailed analysis before making a final selection
Use temperature-dependent properties
- It is very common for thermal analysis to dictate changes to mechanical design (materials, geometry, etc.)

5.14 Sunshade Design

The purpose of sunshades is to shield the sun's rays from reaching certain sensitive optical or thermal surfaces. Sunshades (sunshields) reduce the incident radiation on a thermally-sensitive payload by intercepting these rays and reflecting and reradiating them. Typically, shades are implemented when standard surface treatment strategies do not provide sufficient thermal protection, justifying the additional complexity.

There are several ways a sunshade can be fabricated. For instance, an open cavity can be blocked off by two or more layers of three-ply shields made of MLI blanket material. The outer layer of the shield can be 5 mil thick second surface aluminized Teflon. Honeycomb panel with the sun-side finished with vapor-deposited gold tape could serve as a sunshade. The construction and design of a shield is governed by how extreme the thermal radiation environment will be and the payload or subsystem design temperature. The Parker Solar Probe (<http://parkersolarprobe.jhuapl.edu/The-Mission/>) must handle $700,000 \text{ W/m}^2$ but has no special requirements on its spacecraft bus, utilizes a carbon-carbon shield with a high-emissivity ceramic coating, while contending with an aggressive charging environment and strict mass loss

 National Aeronautics and Space Administration	NASA Passive Thermal Control Engineering Guidebook	Revision: 4.0
	Date: 9/25/2023	Page 142 of 202
	Distribution Restrictions: Publicly available	Security Classification: Unclassified

requirements. On the opposing extreme, the James Webb Space Telescope (<https://www.jwst.nasa.gov/>) must maintain the telescope element at 40K, and does this with an extensive deployable, five-layer MLI shield. Even larger multi-element shields are planned for the Origins Space Telescope (<https://asd.gsfc.nasa.gov/firs/>).

For less extreme missions, a shield configuration need not be this complicated. For instance, an open cavity on the spacecraft may be shielded by one or more layers of three-ply MLI blankets. The outer layer of the shield can be 5 mil thick second-surface aluminized Teflon® coating. Other possible constructions include honeycomb panel with the solar facing side finished with vapor-deposited gold tape, or open-cell urethane foam sheet finished with 1 mil thick aluminized Kapton® film. Specific applications will demand unique materials and support combinations. Modeling methods appropriate for MLI and reflective surface coating are described elsewhere in this handbook.

Regardless of construction, sunshades obviously require special attention to spacecraft geometry and attitude during analysis and operation. Care must be taken to ensure that the protected payload remains within the “shadow envelope” in relation to the primary radiation sources. Accurate pointing is necessary to ensure that this envelope is not compromised, which may quickly overheat hardware that is otherwise design for much lower incident radiation.

5.15 Geometry Design for Thermal Resistance

As described in Section 5.2.4.3, thermal resistance networks are a simple and effective way to model the heat flow between two or more objects that are in direct contact with each other. Drawing a thermal circuit (Figure 30) and calculating thermal resistance values across each component can be very useful to develop a thermal model. These calculations can also be used to verify results obtained from the model upon completion. Thermal Desktop™ (TD) software has features (i.e., conductors and contactors) that allow the user to input these calculated values into the model.

Thermal resistance networks can be drawn for various geometries, including cylinders. For resistance networks of cylindrical systems, heat transfer can be modeled as steady-state, one-dimensional with temperature as a function of radius since temperature gradients only occur in the radial direction. Since there is no heat generation and thermal conductivity, k is constant, Fourier’s law can be written as

$$Q_{cyl} = -kA \frac{dT}{dr} = -k(2\pi rL) \frac{dT}{dr}$$

where A is the area normal to the direction of heat transfer. After integrating and simplifying the above equation, the resistance of the cylinder, R_{cyl} can be calculated as follows

$$R_{cyl} = \frac{\ln(r_2/r_1)}{2\pi Lk}$$



The thermal resistance, R_{cyl} is shown in the thermal resistance circuit in Figure 30.

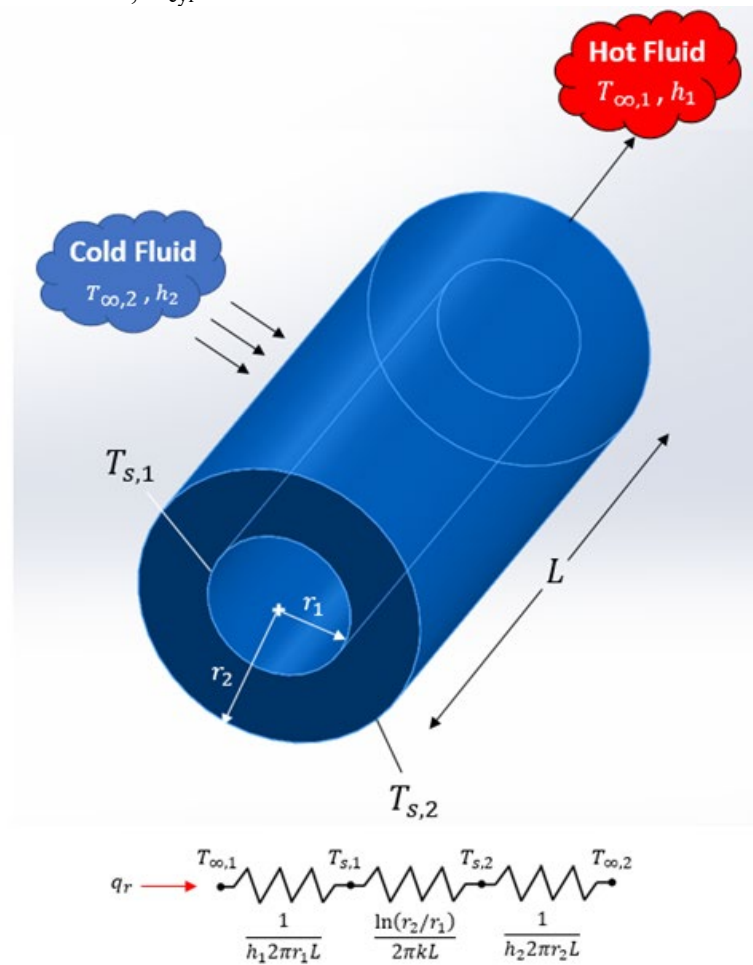
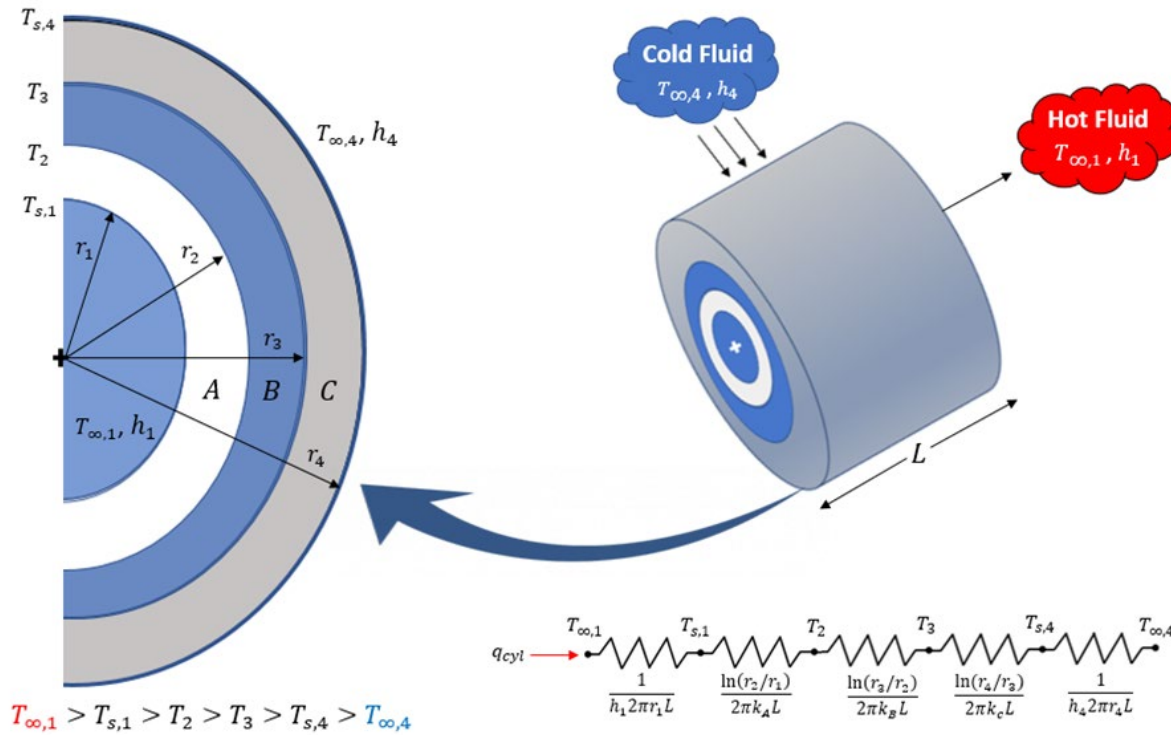

Figure 28. Thermal resistance circuit for a hollow cylinder



Figure

29. Temperature distribution for a composite cylindrical wall

Consider the case of a multilayered composite cylindrical system as shown in Figure 29. Neglecting interfacial contact resistances between each layer, the following expression can be used to determine the heat transfer rate through the composite system

$$Q_{cyl} = \frac{T_{\infty,1} - T_{\infty,4}}{\frac{1}{2\pi r_1 L h_1} + \frac{\ln(r_2/r_1)}{2\pi k_A L} + \frac{\ln(r_3/r_2)}{2\pi k_B L} + \frac{\ln(r_4/r_3)}{2\pi k_C L} + \frac{1}{2\pi r_4 L h_4}}$$

As shown in Figure 29, adding multiple layers around the initial cylinder results in lengthening the thermal path. This thermal path includes convective heat transfer with the hot and cold fluid and conduction between the surfaces that are in direct contact with each other. The overall heat transfer coefficient, U can also be obtained in this analysis as follows,

$$Q_{cyl} = \frac{T_{\infty,1} - T_{\infty,4}}{R_{tot}} = UA(T_{\infty,1} - T_{\infty,4})$$

[Ref] Bergman, T.L., Lavine, A.S., Incropera, F.P., Dewitt, D.P., "Fundamentals of Heat and Mass Transfer", 6th edition, 2006.

 National Aeronautics and Space Administration	NASA Passive Thermal Control Engineering Guidebook	Revision: 4.0
	Date: 9/25/2023	Page 145 of 202
	Distribution Restrictions: Publicly available	Security Classification: Unclassified

5.16 High Temperature Devices

5.16.1 *Furnace and Cartridge Design*

Users inside the NASA firewall can find on OneNote a summary from the course “Microgravity Furnace Design. An Introductory Course” by Morgan Research Corporation, presented to MSFC.

Recent papers on MSFC’s Sample Cartridge Design (SCA) work can be found in these papers: <https://ntrs.nasa.gov/citations/20170009018>, <https://ntrs.nasa.gov/citations/20150016503>.

Some lessons learned include:

- Vacuum bake out everything above their expected operating temperature.
- Even though the plan is to be in an inert atmosphere, at high temperatures oxides (or other chemicals) may be released that will then react with materials. This occurrence caused a thermocouple sheath change from a Type N wire with a tantalum sheath to a more expensive Type S wire with platinum sheath.
- Purity of materials becomes important. For example, when quartz ampoules were breaking around 1200°C, this caused a change to a much higher purity quartz. Though even the higher purity quartz was expected to break not too much higher in temperature.
- Development testing is important to ensure mission success. It is hard to know what will happen at high temperatures until testing it. Even then, you may not ever know what actually happens (unless you want to spend lots of money to do a research project), so you learn to work around it.
- Common “engineering” materials include: alumina, quartz, quartz wool, refractory metals.
- It is likely that the TC’s will not be in direct contact with the science material, so it is important to have an understanding of the lag between the two. Thermal modeling can help inform this discrepancy.
- When using a furnace, it is recommended to have a “thermal calibration cartridge” that is inserted after any long processing to measure temperature drift in the furnace control thermocouples. Having a single cartridge that can be used over-and-over again, as opposed to building a new calibration cartridge each time, will alleviate measurement errors and allow the drift to be characterize over time.

5.17 Measurement and Lab Devices

There are many different types of equipment that may be used for measurement and testing in the thermal discipline. Devices for temperature measurement range from simple TCs and readers, to larger data acquisition systems. There are battery-powered temperature and humidity data loggers that can take data unattended and without input power for weeks before downloading.

For heat flux measurement, there are many different types of calorimeters.

For material property measurement, there are systems for measuring thermal conductivity and thermal contact resistance. For optical property measurement, there are systems for measuring emittance in the IR as well as absorptivity in the solar waveband. Descriptions of older systems as well as comments on use of newer systems for reflectance measurements are on the Agency-wide OneNote®.

 National Aeronautics and Space Administration	NASA Passive Thermal Control Engineering Guidebook	Revision: 4.0
	Date: 9/25/2023	Page 146 of 202
	Distribution Restrictions: Publicly available	Security Classification: Unclassified

6.0 Thermal Testing (Thermal Control System Verification and Validation)

6.1 Thermal Vacuum Testing

6.1.1 *Standards*

Thermal standards vary and are very dependent on project requirements. Appendix D: Useful Links, Section 13.0, gives some valuable links to standards.

The standard used will normally define the number of cycles to be performed, dwell times, ramp rate, test tolerance, margin, stability criteria, and some discuss profile order. Example TVAC test procedures are available to NASA users on the Agency share.

Standards sometimes require tailoring – common examples include high-risk projects (Class D/E) and those that are generally lower cost such as small-sats. Common examples of tailoring include reducing the number of cycles, reducing the duration of cycles, and reducing the amount of margin required. When determining applicability of standards to a particular project it is important to consider the type of project for which the standard was written (e.g., requirements for a planetary probe are likely to be different from those for an Earth-orbiting instrument).

6.1.2 *Planning*

In planning a TVAC test, some the key items to consider include the following:

- When establishing a TVAC test schedule, make sure to include all activities related to the test, such as procedure development, peer reviews, test setup, and post-test hardware removal in addition to the test itself. Use thermal modeling to inform the definition of the test duration.
- Begin to develop testing schedules early (high-level prior to System Requirements Review, detailed prior to Critical Design Review), ensure that subsystem and discipline leads have the opportunity to provide input, and provide the opportunity for stakeholders to review and provide feedback.
- Use probabilistic risk assessments to establish schedule reserve, and review often (at least after each major test)
- If remote operation of an instrument is necessary, begin plans as soon as this need is identified.
- Verify the capabilities and limitations of the proposed test facility. Perform unloaded tests as necessary to determine characteristics of the chamber (i.e., gradients in platens, maximum ramp rates, etc.).
- Include peer review(s) when laying out testing plans, timing them late enough in the process that plans are well-developed but not so late in the process that there is no time to adjust plans (recommend at least 2 months prior to testing).
- Consider suggesting to project management that the TRR for a major (payload-level) TVAC test be split into two parts to allow for changes to be made as identified in the first review while also allowing the team to continue working up until the start of the test. The first review should cover as many items as possible, including anything that is ready to be discussed a couple of weeks before the test. The second review should serve as a final status update prior to pumping down the chamber, and should include information that could not be covered previously such as pre-

TVAC functional test results. In addition, safety concerns should be addressed at the second review so that they will be fresh in everyone’s mind going into the test.

- Carefully consider what roles are needed when planning a TVAC test, both on-shift and lead roles. This should be tailored to the needs of each test, but the roles defined for SAGE III IP TVAC worked well for that project. As a reference, those are provided here in Table 11 and Table 12.

Table 11. Example Leadership Roles and Responsibilities

Role	Responsibilities
Lead Test Director (LTD)	Project engineer; a deputy should also be appointed
	Leads Test Readiness Review (TRR)
	Is not required to be present at the test 24/7, but works Test Director (TD) shifts as needed; otherwise, on-call
	Coordinates overall staffing plans, including contingency plans in the event of emergencies; also coordinates staffing for on-shift TDs
	Oversees closure of Non-Conformance Reports (NCRs)
	Delivers as-run copy of the main test procedure to the Configuration Management Team for upload to shared archive location
	Coordinates preparation of the quick-look test report
	Ensures that the test artifacts are completed and stored at the appropriate shared archive location
Lead Facility Operator (LFO)	Systems Integration and Test Branch (SITB) engineer; a deputy should also be appointed
	Is not present at the test at all times, but works Facility Operator (FO) shifts as needed; otherwise, on call
	Participates in walk-through of the combined test procedure (main and functional) and the TRR
	Coordinates training for FOs as needed
	Provides FO schedule to TD for incorporation in overall staffing plan
	Coordinates FO activities and provides guidance as needed during the test
	Provides concurrence to TD for any decisions regarding changes during the test that impact scope or objectives or goals of the test
	Delivers facility data to the Configuration Management Team for upload to CSS
Provides input to test report from a facility perspective	
Lead Test Conductor (LTC)	SAGE III operations engineer
	Is not present at the test at all times, but works Test Conductor (TC) shifts as needed; otherwise, on call



Role	Responsibilities
	<p>Prepares the functional procedure</p> <p>Participates in walk-through of the combined test procedure (main and functional) and the TRR</p> <p>Coordinates training for Test Conductors and Test Operators (TOs) as needed</p> <p>Provides TC & TO schedule to TD for incorporation in overall staffing plan</p> <p>Coordinates TC & TO activities and provides guidance as needed during the test</p> <p>Provides concurrence to TD for any decisions regarding changes during the test that impact scope or objectives or goals of the test</p> <p>Delivers as-run copy of the functional procedure to the Configuration Management Team for upload to shared archive location</p> <p>Delivers InControl data artifacts to the SAGE III Configuration Management Team for upload to CSS</p> <p>Coordinates preparation of ops test report</p>
Lead Thermal Engineer (LTE)	<p>SAGE thermal engineer</p> <p>Is not present at the test at all times, but works Thermal Engineer (TE) shifts as needed; otherwise, on call</p> <p>Prepares the test plan that specified test conditions, goals, and constraints</p> <p>Prepares and updates the main test procedure as necessary with input from the LFO, LTC, Subsystem Leads (SLs), and Contamination Control Engineer (CCE)</p> <p>Conducts a walk-through of the combined test procedure (main and functional) with at least one representative from each role listed in this table</p> <p>Coordinates creation of common test log</p> <p>Participates in the TRR</p> <p>Coordinates training for TEs as needed</p> <p>Provides TE schedule to TD for incorporation in overall staffing plan</p> <p>Coordinates TE activities and provides guidance as needed during the test</p> <p>Provides concurrence to TD for any decisions regarding changes during the test that impact scope or objectives or goals of the test</p> <p>Coordinates preparation of final test report and provides input from a thermal perspective</p>
Contamination Control Engineer (CCE) & CMP Scientist	<p>SAGE III contamination control engineer</p> <p>On call for the duration of the test</p> <p>Ensures compliance of project CCP during the execution of the test</p> <p>Ensures all cleanliness requirements are followed</p>

 National Aeronautics and Space Administration	NASA Passive Thermal Control Engineering Guidebook	Revision: 4.0
	Date: 9/25/2023	Page 149 of 202
	Distribution Restrictions: Publicly available	Security Classification: Unclassified

Role	Responsibilities
	<p>Gives guidance and direction to operating the environmental monitoring sensors</p> <p>Oversees steps in procedure that relate to collecting contamination data for verification purposes</p> <p>Provides concurrence to TD for any decisions regarding changes during the test that impact scope or objectives or goals of the test</p> <p>Provides assessment of scavenger plate and cold finger deposits</p> <p>Inputs comments into the “Contamination” tab of the common test log</p> <p>Reduces data acquired by the CMPs</p> <p>Provides input to test report from a contamination perspective</p>
Subsystem Leads (SLs) <i>IA/Science</i> <i>Avionics</i> <i>Electrical</i> <i>[Instrument subsystem leads as appropriate]</i>	<p>SAGE III engineers</p> <p>On call for the duration of the test</p> <p>Participates in walk-through of the combined test procedure (main and functional) and the TRR</p> <p>Provides concurrence to TD for any decisions regarding changes during the test that impact scope or objectives or goals of the test</p> <p>Provides input to test report from subsystem perspective as needed</p>
Ground Systems Lead (GSL)	<p>Provides InControl™ satellite command and control software training to other test personnel as needed prior to the test</p> <p>Is not present at the test at all times, but is on-call to assist with InControl™ software issues as needed</p>
Mission Assurance Manager (MAM)	Coordinates and leads activities of Quality Assurance Specialists (QAS)

Table 12. Example Test Personnel Roles and Responsibilities

Role	Responsibilities
Test Director (TD)	Leads the conduct of the test, ensuring that the main test procedure is followed
	Ensures that all on-shift personnel are kept in the loop with the progress of the test and any issues that require discussions
	Leads daily status meeting
	Leads OK-to-proceed meetings prior to leaving each test condition
	Sends a daily status report to the team via email following the daily status meeting
	Maintains an overall test log in the “TD” tab of the common log



Role	Responsibilities
	<p>Incorporates redlines and bluelines in the main test procedure, coordinated with FO, TC, TE, and QAS to capture potential impacts to main test procedure</p> <p>Is responsible for coordinating the necessary approvals for any decisions regarding changes during the test that impact the scope, objective, or goals of the test. At a minimum, approvals are required from all leads identified in this table; however, major changes also need to be approved by Chief Engineer (CE) and/or Project Manager (PM). TD is also responsible for communicating such decisions to the testing team.</p> <p>Ensures that the appropriate process is followed for NCRs</p>
Facility Operator (FO)	<p>SITB test engineer or technician. Both a facility engineer and a technician will be present for the first 3 days of the test and anytime the chamber is being brought to ambient conditions; otherwise, only one FO will be on-shift at a particular time. A facility engineer will be on-call anytime a less-experienced FO is on shift.</p> <p>Performs steps for installing test hardware, taking measurements, and operating the test facility</p> <p>Operates thermal vacuum chamber according to approved process and procedures</p> <p>Makes adjustments to thermal chamber as requested by the TE</p> <p>Inputs comments into the “Facility” tab of the common test log</p> <p>Attends daily status meetings if possible</p>
Test Conductor (TC)	<p>SAGE III operations engineer</p> <p>Oversees execution of functional tests and procedures</p> <p>Incorporates redlines and bluelines in the functional procedure, coordinated with the TD to capture potential impacts to main test procedure</p> <p>Attends daily status meetings</p> <p>Inputs comments into the “IP Ops” tab of the common test log</p>
Test Operator (TO)	<p>SAGE III engineer or technician</p> <p>Operates all SAGE III hardware and associated GSE</p> <p>Executes all SAGE III functional tests and procedures</p> <p>Inputs comments into the “IP Ops” tab of the common test log</p>
Thermal Engineer (TE)	<p>SAGE III and/or Structural and Thermal Systems Branch (STSB) thermal engineer</p> <p>Monitors temperatures during the test and provides FO direction for making chamber adjustments</p> <p>Determines when environmental conditions are met and provides approval to proceed to TD</p> <p>Attends daily status meetings</p> <p>Inputs comments into the “Thermal” tab of the common test log</p>

Role	Responsibilities
Quality Assurance Specialist (QAS)	Performs the duties outlined in the Software Assurance Plan
	Assumes responsibilities for all the quality control issues that arise during the test
	Is responsible for being aware of tests that are not meeting requirements and enforcing the process of halting testing and generating the necessary NCR
	Assures that all the required safe practices are implemented during the test procedure and that operations are performed in the proper order
	Attends daily status meetings
	Inputs comments into the “QA” tab of the common test log

- Training for thermal engineers working a TVAC test should include a briefing from the project thermal engineer as well as a facility tour from a facility engineer. A sample training presentation is available to NASA users on the Agency shared drive.
- Begin discussions related to GSE development very early in the test planning process, allowing sufficient time for concept development, detailed design, peer reviews, fabrication/assembly, and testing.
- Initiate staffing plans early (approximately 2 months in advance), working toward a final version approximately 2 weeks prior to the start of a major test.
- Use a collaborative tool to maintain a master personnel schedule. Ensure that all team members understand how to access the schedule and that they are aware that it is their responsibility to check for updates. If possible, use a tool that has the ability to notify users when updates are made (such as SharePoint® software).
- Make sure to have backup personnel in place when creating a schedule for a test that operates on a 24/7 basis.
- Schedule shifts with a short (30-minute) overlap to provide time for a smooth transition.
- It is important to have a pre-defined method of response if someone is late or misses their shift (person on shift stays late, next person called in early, etc.).
- Have cell phone contact information for all test personnel in online spreadsheet and printed in the test area.
- Consider pros and cons of staggering start times for shifts for different groups (facility, thermal, instrument operator, etc.).
- Planning for test setup should be done separately from the TVAC test itself in order to avoid confusion.
- Include at least one person from each discipline on each test setup shift, even if the plan does not include tasks specific to that discipline. This ensures that work can continue if tasks fall behind or move more quickly than expected.
- Ensure that personnel have a method to execute their normal work from the test facility, if their expertise is not needed during that shift

 National Aeronautics and Space Administration	NASA Passive Thermal Control Engineering Guidebook	Revision: 4.0
	Date: 9/25/2023	Page 152 of 202
	Distribution Restrictions: Publicly available	Security Classification: Unclassified

- Ensure that the schedule includes a lead for each shift who is familiar with the GSE and test setup; train additional personnel as needed.

6.1.3 *Environment Definition*

In defining the TVAC environments, the important thing is to ensure that the environments defined include all effects that will be experienced during flight, as far as is practicable, and that the required margins beyond what is expected during flight can be achieved, but the thermal range is not so extreme as to go beyond the payload limits.

A discussion of methods for achieving TVAC environments was assembled for the Constellation program, and is available on the Agency share for those within the NASA firewall: Defining Thermal Environments in TVAC Testing (Eugene K. Ungar, 3/3/09).

The thermal environments that will be encountered in flight, and which should be represented in the model, may include direct solar flux, reflected solar flux including planetary albedo, IR radiation from a planet or satellite, and IR from other nearby surfaces. The thermal model should include all of these, and predict a range of temperatures for each component in the payload. Normally, margins will be added to those to account for model uncertainty, to define the thermal range to be used in test. The project may have independent requirements for margins, or they may rely on a source such as GEVS, GSFC-STD-7000 (<https://standards.nasa.gov/standard/gsf/gsf-std-7000>) and the GOLD Rules, GSFC-STD-1000 (<https://standards.nasa.gov/standard/gsf/gsf-std-1000>).

In many cases, a TVAC test will not be able to get each and every component to exactly the predicted range plus the required thermal margin. In getting parts of the payload to the required ranges, some components may go outside the desired range. As long as the components do not approach their limit ranges, this is not normally a problem. A TVAC test is a careful balance of designing the setup and environments so as many parts of the payload as possible can be taken to their desired ranges, while not over-driving any components. For certain components, it may not be possible to achieve the designed prediction+margin range, and in that case there may be a project decision to waive the requirement, or to test that component more fully at the component level.

Every test will have slightly different methods of achieving the desired environments, but normally in a TVAC chamber there will be a cold shroud and cold scavenger plate, and then heating will be applied via cal rods, heater plates, quartz lamps (see issues on the waveband of lamps in sections 4.5.6 and 6.1.8), or (more rarely) a solar simulator. A very comprehensive evaluation of all methods for providing environments is given in GEVS (GSFC-STD-7000). Normally it is not critical to have the waveband of the energy used for heating the payload (i.e., IR or solar) match flight, as long as the wavebands are known such that the test can be effectively modeled, and the test data used to correlate the model.

6.1.4 *Test Profile*

A full definition of the test profile will include the following:

- Number of cycles
- Duration of cycles and dwells
- Maximum and/or minimum rate of temperature change
- Thermal ranges (for full system or by subsystem, operational and survival, hot and cold)
- Thermal balance(s): number of conditions, powered vs. unpowered, cool-downs

 National Aeronautics and Space Administration	NASA Passive Thermal Control Engineering Guidebook	Revision: 4.0
	Date: 9/25/2023	Page 153 of 202
	Distribution Restrictions: Publicly available	Security Classification: Unclassified

- Definition of stability for both dwells and balances
- Cold/hot restarts
- Consideration of corona region cautions if applicable

If schedule allows, perform payload thermal balance testing prior to thermal cycle testing so that the correlated model can be used to set test conditions. Include thermal balances in subsystem-level TVAC testing whenever possible. Correlating portions of the model early provides confidence in flight predictions and allows system-level TVAC test conditions to be set as appropriately as possible. In lieu of a full thermal balance, a thermal transient can also be used effectively for correlation if the start conditions and driving function are well known. A good way to achieve this is to have the payload in a steady-state condition, and then make a known change to the environment, which can be either applying power, or making a defined and controlled change in the heating environment.

Ensure that TVAC testing includes, at a minimum, the following conditions to support model correlation: one unpowered balance, hot powered balance, cold powered balance, and one cool-down transient (environment is constant while the system is powered down and allowed to cool). It is preferable to include unpowered balances at hot and cold points and a heater-only balance. At least one of the powered balances should start from the end of an unpowered balance, so that the system is at steady-state prior to powering on. This way, the environment is constant and the only reason for temperature change is the system powering on.

To get the best thermal balances for correlation, a highly effective sequence is to first run an unpowered balance, then without changing the chamber conditions, transition to heater-only balance and then a powered balance. At the completion of any operational testing at the end of the powered balance, it is valuable to hold the payload steady in a powered condition, and then again without changing the chamber conditions, power off the payload. This gives a cooldown curve that is independent of the powers applied in the operational mode (which can be inaccurate or uncertain). The unpowered cooldown behavior will be dependent only on thermal masses and connections.

While project requirements will largely influence how the TVAC test profile is defined, the following items are important to consider when developing a TVAC test profile:

- Functional tests with door open, at ambient temp / vacuum, and at each plateau, covering full voltage range
- The main goal in functional testing is to make sure the previous step did not cause damage to the payload. If a functional test is done with the door open, and then the door is closed, the chamber is pumped down, and the payload taken to the hot plateau before the next functional test, there will be no way of differentiating any potential damage to the payload between the transition to vacuum and the transition to hot plateau.
- If acceptable, chamber backfill with GN₂ can be considered to increase transition rates. Be mindful of the impact that temperature gradients within the chamber can have on hardware when backfilling occurs (thermal shock).
- Heater checkouts during first ramp to cold (to verify current and turn on/off as expected)
- Best practice is to go to a hot plateau first, to avoid any condensation of contaminants on a cold payload.
- Hot and cold survival dwells

 National Aeronautics and Space Administration	NASA Passive Thermal Control Engineering Guidebook	Revision: 4.0
	Date: 9/25/2023	Page 154 of 202
	Distribution Restrictions: Publicly available	Security Classification: Unclassified

- Including a survival dwell without heaters allows thermal margin to be achieved, while including a survival dwell with heaters allows for verification of their performance; include both whenever possible.
- Hot and cold operational dwells.
- Thermal balance to include hot and cold conditions, unpowered and powered states (environment held constant when powered on to minimize variables), and unpowered cool-down period to capture the transient behavior.
- It is important to perform powered and unpowered balances. Data from unpowered balance provides the ability to correlate to passive aspects of the model such as contact conductance and surface properties without the complications that can accompany operational power dissipation. After unpowered correlation is achieved, correlation to powered data can be done more effectively.
- It is important to include at least two thermal balance conditions. If only one condition is performed, then it would be easy to change variables to suit that one case, without realizing that these changes would mean that the model does not agree in another case.
- Including an unpowered cool-down period is critical for model correlation because it allows for correlation of the transient behavior without the complications associated with operational or heater power dissipation, or changes in the environment.
- Consider performing thermal balance on the second cycle, rather than at the beginning or end. This allows for the first cycle to be used to work through unknowns and confirm how much the system would warm up from an unpowered state in a stable environment. Doing the balances in the second cycle was early enough that corrections to targets could be made for the final two cycles if the system behaves significantly differently than expected.
 - Hot and cold re-starts (these can be critical for identifying issues)
 - TQCM measurements

At the payload level, the following approaches can work well for defining temperature targets and thermal stability:

- Thermal stability is achieved when the specified sensors (one per subsystem) have reached their target ranges and all sensors being monitored in the TE log are changing $< 2^{\circ}\text{C}/\text{hour}$. The TE log can be set up to calculate the rate of change of manually entered temperature data so that the TE on shift can easily determine when steady-state was reached.
- For thermal balance conditions, balance is declared when all monitored sensors are changing $< 0.1^{\circ}\text{C}/\text{hour}$ over a period of 6 hours (does not apply if heaters are cycling). An effective way to determine when balance is reached is to observe live plots until the rate of change is approximately $0.1\text{C}/\text{hr}$ for the slowest-changing sensor, then wait 6 hours and plot data from all flight sensors to ensure that the criteria are met.
- Temperature targets are achieved within a tolerance of $\pm 2^{\circ}\text{C}$.
- In general, temperature targets can be set based on thermal model predictions plus margin as defined based on discussion with project personnel.
- For cold operational conditions, margin can be achieved via analytical definition of a margined environment rather than by target temperatures. Per GEVS, cold operational margin may be shown

either with temperature margin or by showing that operational heaters maintain control in a margined environment. The margined cold environment can be determined by (1) running the flight cold case and determining payload temperatures, (2) running the TVAC model to determine the environments necessary to produce those payload temperatures (no margin), and (3) running the TVAC model to find heater plate settings that result in 30% higher heat loss from the payload to the environment. Note that this approach should mainly be applied to dedicated heat rejection surfaces such as radiators and not necessarily to MLI for which the heat flow is already minimized.

Some example test profiles are shown in Figure 32 and Figure 33. Note that voltages for both a main bus and operational or contingency bus are run independently at maximum, minimum and nominal values, functional testing and hot/cold starts are shown, and heater checkouts are indicated during the first ramp to cold survival. NASA users may find additional references related to defining thermal stability on the Agency share drive.

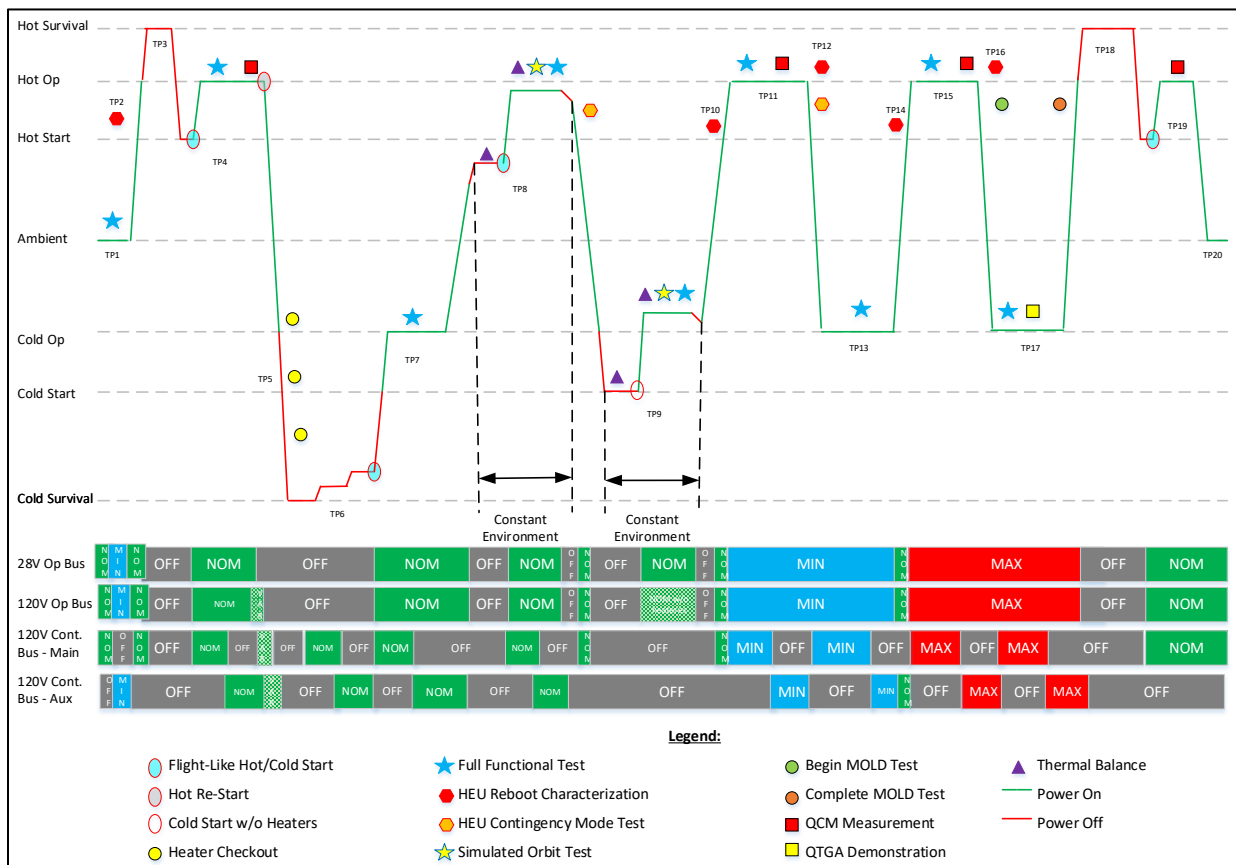

Figure 32. Sample TVAC test profile for SAGE III Instrument Payload.

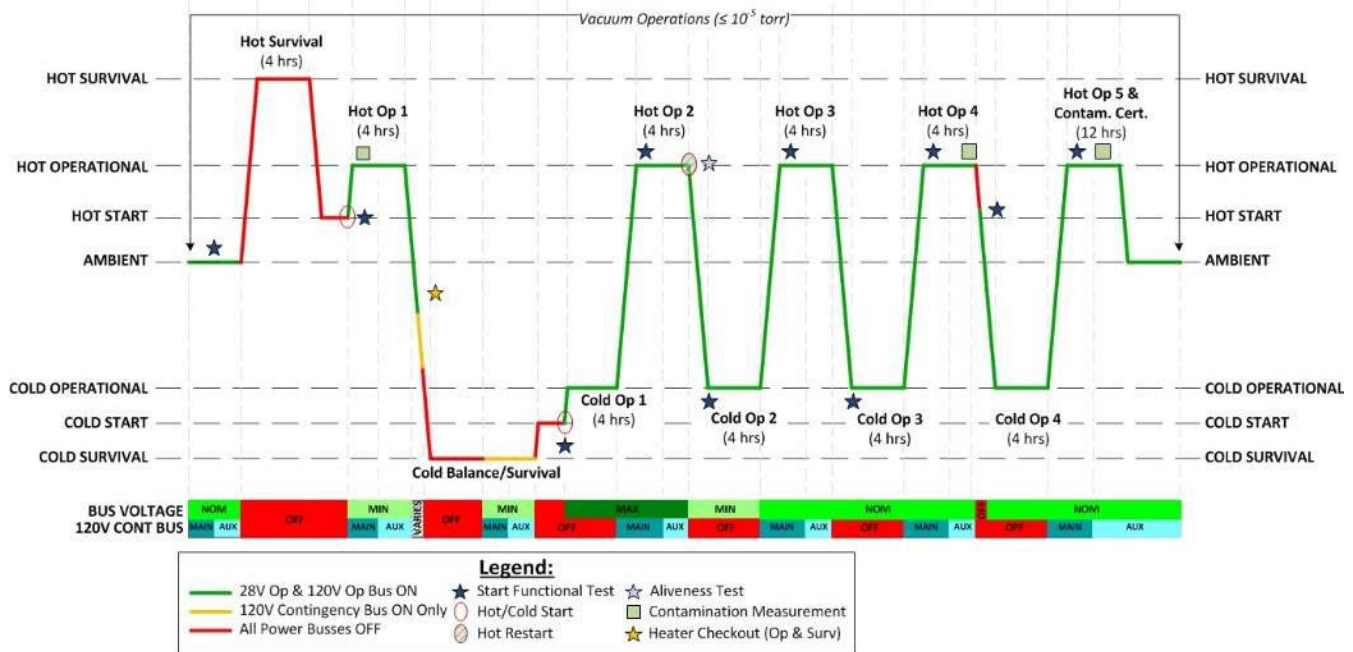

Figure 33. Sample TVAC test profile for electronics box.

6.1.5 De-Scope Options

Many times a project will run into schedule or budget issues, and the thermal engineer will be asked what could be cut from the test plan. It is always a good idea to think about this early, so that if it comes to pass, there is already a plan in place. A key consideration is to consider the minimum required goals for the test, versus items that are desired but not required. Ambient pressure testing can sometimes be suggested as a way to cut cost or schedule versus TVAC testing, but there are many disadvantages to ambient pressure testing, the most critical being the difficulty of achieving the same gradients on a powered payload as would be achieved in vacuum, and the inability to be confident that the payload will function at the required temperature range in a vacuum.

Reduction in the number of cycles is often a target for cost and schedule savings. Removal of cycles and the associated functional tests should be carefully considered due to the risk of under testing. The associated risks should be well understood and acceptable to the project before committing to shorten testing.

6.1.6 Procedure Development

Best practice is always to start procedure development from a pre-approved template whenever possible. On the first test procedure for a given project, another project's procedure can be used as a starting point. An organization should always strive to have procedures for past projects archived in an easily available location. Some representative procedures which can be used as guidelines are available here on the shared drive for those within the NASA firewall. Some items to consider in procedure development:

- Develop a test plan well in advance of the start of procedure development.
- Conduct multiple table-top and email reviews, including project and facility personnel, during the development of test procedures.

 National Aeronautics and Space Administration	NASA Passive Thermal Control Engineering Guidebook	Revision: 4.0
	Date: 9/25/2023	Page 157 of 202
	Distribution Restrictions: Publicly available	Security Classification: Unclassified

- When possible, leverage previous testing by adopting format and content from previous successful procedures.
- Create separate procedures for hardware setup and removal. These procedures should clearly call out which personnel are required for each section.
- Use an open-ended format for scenarios with uncertain sequencing (e.g., heater checkouts). Consider having a general procedure with a table to record the necessary data, rather than a detailed step-by-step procedure.
- Make sure the wording for how to determine when thermal balance is achieved is very clear. Review it with the thermal engineering team and well as the Test Director to ensure that everyone shares the same understanding of its meaning.
- Assign a Test Director to serve as the person responsible for the execution of the procedure during the test. It is critical that this person be from the project rather than the facility, and the he or she is knowledgeable enough about the overall system that decisions can be made in a timely manner.
- Ensure that the test setup procedures clearly indicate which personnel are required to execute each section of the procedure.

6.1.7 *Test Setup*

6.1.7.1 General

- Clearly mark areas which are designated only for personnel actively working on the setup tasks. Backup personnel should remain outside of this area.
- Test configuration should be defined by an approved drawing. This ensures that there is traceability in case there is ever a later question about the test configuration, after the test setup has been dismantled.

6.1.7.2 Flight-Like Interfaces

- Make sure to communicate to the team early on that the test configuration, including conductive and radiative interfaces) should be as flight-like as possible. Flight surface finishes, fasteners, standoffs, and torque values should be used if at all possible.
- Review drawings (and, later, photographs) of the test configuration to make sure the thermal model of the test setup is an accurate representation of the actual test configuration.
- Consider the potential heat leaks from ground support harnesses to or from the test article. If the heat leak is significant, guard heaters can be installed to reduce heat leaks to or from the test article via this path. Adding the guard heater provides a well-known boundary condition for thermal model correlation.

6.1.7.3 Temperature Sensor Locations

- Always have backups in place for control TCs in the event that the planned control TC fails.
- When there is an assumption in the thermal model (such as the contact between a heater frame and plates), make sure there is at least one TC installed so as to validate the assumption.

 National Aeronautics and Space Administration	NASA Passive Thermal Control Engineering Guidebook	Revision: 4.0
	Date: 9/25/2023	Page 158 of 202
	Distribution Restrictions: Publicly available	Security Classification: Unclassified

- Make sure each heater has a temperature sensor nearby (a flight sensor is preferable, but at least a test TC) so that it is simple to confirm when the heaters turn on and off.
- Make sure to instrument the shroud well enough that any gradients are captured—shroud gradients can often be larger than anticipated.
- Whenever possible, include test temperature sensors within electronics boxes (to be used during testing but not flight) to aid in model correlation. It is also highly beneficial to have current monitors to determine the power dissipated by the box. This is only possible if the thermal team is involved in the early stages of electronics design.

6.1.7.4 Thermocouple Installation

There has recently been some valuable work in evaluating attachment methods for thermocouples:

- TFAWS 2017 paper by Sarah Wright & Gene Ungar, JSC (<https://tfaws.nasa.gov/files/TFAWS2017-AT-20-Presentation.pdf>)
- Lessons learned from the SAGE III project on TC attachment (this is available only inside NASA firewall)

Some general notes for achieving reliable, high quality contact for test TCs, based on SAGE III experience, are as follows:

- *Placement*
 - It is important to install TCs at all locations required to validate assumptions in thermal models. When there is an assumption in the thermal model (such as the contact between heater frame and plates), make sure there is at least one TC installed so as to validate the assumption. If there are multiple instances of a similar contact conduction in the test equipment assembly, it is good practice to install TCs on both sides of at least one of those interfaces to validate the assumption of contact conductance in the model.
 - It is important to make sure that each heater has a temperature sensor nearby so that it is possible to confirm when the heaters turn on and off. This will simplify any heater checkout process.
 - Always have backups in place for control TCs in the event that the planned control TC fails.
- *Type of Tape*
 - Test TCs should be attached with high-conductivity tape to minimize the error if the TC bead lifts off the surface.
 - Since aluminum tape has a low surface emissivity, Kapton® tape may be applied over top in cases where aluminum tape consumes a large proportion of a high emissivity surface, without a noticeable effect on the measured temperature. Aluminum tape with Kapton® overtape effectively held the TCs in place during SAGE III testing.
 - Kapton® tape may be preferable to aluminum for securing TCs to hardware in the following scenarios:
 - Low mass surfaces, where aluminum tape may represent a large percentage of the mass

 National Aeronautics and Space Administration	NASA Passive Thermal Control Engineering Guidebook	Revision: 4.0
	Date: 9/25/2023	Page 159 of 202
	Distribution Restrictions: Publicly available	Security Classification: Unclassified

- MLI blankets, since Kapton® tape is less rigid and will conform to the blanket shape more easily
 - Tape-wrapped harnessing, as existing Kapton® tape could be damaged by sharper aluminum tape edges. Also, as with MLI blankets, Kapton® tape will conform more easily to harnessing.
 - In situations where high gradients are expected, consider minimizing the amount of aluminum tape used to avoid measuring an averaged temperature rather than a point temperature; this must be balanced with the fact that larger pieces of tape will be more effective at securing the TC to the hardware.
 - Kapton® epoxy sandwiches (or large globs of epoxy) around TC beads should be avoided due to the risk of isolating the TC bead from the hardware on which temperature is being measured. Testing of several installation types was done, for SAGE III and Kapton® epoxy sandwiches around beads led to errors in TC measurements. Aluminum tape over a bare TC bead was found to be the most effective and repeatable installation method. If a Kapton® epoxy sandwich is required because of electrical conductivity concerns, be aware that it will cause a thermal delta.
- *Installation tips*
 - Use a plastic flat edge as needed to press the tape to the surface and around the bead, working out any air bubbles.
 - Label the TCs at the bead and connector ends by writing the TC number on aluminum tape. If the area will need to be wiped with IPA after TC installation, or if there are concerns about the label wearing off over time, then it may be advisable to place Kapton® tape over the labeled aluminum tape. When labelling with a permanent marker cannot easily be seen (Black/blue marker on Kapton® tape), a small piece of Teflon® film labelled with the TC number and taped near the TC will improve the contrast for photographs.
 - Include a step to photograph TCs as they are installed, making sure the location is easily discernable by either labeling or based on landmarks/geometry. Ensure that the photograph can clearly identify where the TC is located. A very close picture of a TC on a large panel may not be sufficient to identify its location. TC touch tests should be completed as late in the setup flow as possible, to minimize the chance that other setup work will interfere with the installation of the TC.
 -
- *Wiring*
 - Check TC extension wires before installing to make sure the leads are hooked up correctly and that there is no damage to the wires.
 - Using Kapton tape for strain relief prevented TCs from becoming dislodged during testing.
 - Care should be taken when routing cables alongside each other and cable shielding should be considered where necessary. Always check wire routing and evaluate signal noise before closing the door and pumping down: the SAGE III project had issue with noise in TC measurements due to routing next to other cables

 National Aeronautics and Space Administration	NASA Passive Thermal Control Engineering Guidebook	Revision: 4.0
	Date: 9/25/2023	Page 160 of 202
	Distribution Restrictions: Publicly available	Security Classification: Unclassified

- Wires should be routed such that their path is isothermal, to the extent possible, to avoid gradients leading to an inaccurate measurement.
- *Touch tests*
 - Touch tests should be done through the facility DAS (in lieu of a portable TC reader) whenever possible. If TCs are installed away from the DAS, then a TC reader should be used for an initial touch test and a second touch test should be performed through the facility DAS prior to the start of the test.
 - TC touch tests should be completed as late in the setup flow as possible, to minimize the chance that other setup work will interfere with the installation of the TC.
 - Ensure that all TCs are reading about the same value under ambient, unpowered conditions. Any offsets prior to warmup or cooldown with testing should be identified.
 - TC touch tests through the DAS should include a check for noise in the signal.

6.1.7.5 Test Heaters

If heater plates are used in the test, in order to make the analysis as simple as possible, the heater plates should be designed to have a minimum gradient across their span. One way to accomplish this is to spread the heaters across the plates as evenly as possible, for example to use 1”-wide thin-film Kapton® laminate heaters and space them evenly across the plates. If backup heater sets are installed, they should be interleaved with the primary heaters, so a similar gradient will be experienced if use of the backup heaters is necessary. In order to understand the gradient that exists across the heater plates during testing, either a characterization test should be performed to characterize the heater plates fully, or at least one representative plate should be instrumented during the test so as to capture the full gradient. The analyst should not depend on a single sensor on the plate to represent the temperature of the entire plate: a 10°C gradient across plates is commonly experienced, and can be sufficient to throw off thermal model correlation. When modeling heater plates, to facilitate correlation, they should be meshed with sufficient density to show the true gradient that is experienced during the test.

The engineer designing the test setup should make sure that control sensors are far enough from the heaters so that control will be stable and well-controlled. If possible, if assumptions are made about the thermal resistance in mounting the heater plates in the chamber, at least one such connection should be instrumented so as to validate those assumptions. In the thermal model, the heaters should be modeled explicitly, and their optical properties, normally different than the underlying plate, captured. Any temperature sensors and control sensors should also be captured explicitly within the thermal model.

6.1.7.6 Test MLI Installation

For installation of MLI for tests, see the general advice for MLI installation in section 5.8.6, but also consider the following:

- It is possible that extra MLI blankets will be needed for test that would not be present in flight, such as to shield from some warm GSE component, provide shielding from the shroud or a cryogenic scavenger plate, etc.
- If test-only blankets are fabricated, the project may consider saving cost by making them different than flight blankets in aspects such as the outer layer of beta cloth. To facilitate correlation of the

 National Aeronautics and Space Administration	NASA Passive Thermal Control Engineering Guidebook	Revision: 4.0
	Date: 9/25/2023	Page 161 of 202
	Distribution Restrictions: Publicly available	Security Classification: Unclassified

thermal model to test, it is best if the outer optical properties of the blankets are similar to the flight blankets.

- Consider which blankets need to be in place for each environmental test. At a minimum, all flight blankets must be present for final payload level TVAC testing.
- Minimize the use of tape used on blankets during testing and always tab any tape that is used so that it is easy to remove without damaging the blanket; transfer adhesive is not preferred for test installations since it is difficult to remove and steps taken during the removal process could result in damage to blankets.
- Consider placing a test temperature sensor on the outside of selected MLI blankets, to get a rough measure of the radiative environment from the temperature of external MLI surfaces, as that is a measure that will most probably not be available during flight, and can be helpful in model correlation.

6.1.8 *Quartz Lamp Spectrum*

Quartz lamps (as well as other types) supply radiant heat largely in the solar spectrum, but the exact spectral distribution depends upon the lamp setting which creates significant complications for model correlation. Correlating results with a thermal model may be easier and more successful by using heater plates rather than developing a thermal model to account for the necessary details of the lamp spectrum. An agency-level lesson learned related to this topic can be found on LLIS (submission 18804), for those with access to the NASA LLearned Information System.

If it is desired to correlate thermal models to TVAC test data, it is best to avoid the use of quartz lamps, or any lamps that have any significant solar spectrum. In addition to simulating the correct spectral content, there are inevitable variations in the intensity of the incident heating on the test article due to imperfections in the lamp reflector surfaces, variation in individual lamp power as a function of the test setup and the overlapping intensity from lamp spacing given that it is not a far field (non-collimated) source. Although the lamps can theoretically be modeled, this can prove very difficult in practical applications.

If a NASA project desires to test in the LaRC 8' x 15' TVAC chamber, the heater plates designed by SAGE III are available for use. Additionally, the upgraded lamp system in that 8' x 15' TVAC chamber now has calibrated voltage and current meters which can be used in conjunction with manufacturer's data to predict the IR/visible spectrum power contributions (verification by test is required). Similarly, NASA MSFC has two smaller heater shroud assemblies (10" x 10" x 17" and 27.5" x 12" x 10") utilized for the Lightning Imager System and Gamma-Ray Burst Monitor projects with multiple controllable zones that can be placed in a chamber to provide radiation sink temperatures.

If quartz lamps cannot be avoided, see Section 4.5.6 for a discussion of an approach for correlating to test with quartz lamps present.

6.1.9 *Thermal Limits and Margins for Testing*

The approaches for setting thermal limits and margins for testing will vary from project to project. This section will suggest guidelines, but project-specific guidance will obviously take precedence. Thermal limits and margin policy should be formally documented prior to testing, ideally prior to test planning, to facilitate test profile development. The limits and margins document should be officially approved prior

 National Aeronautics and Space Administration	NASA Passive Thermal Control Engineering Guidebook	Revision: 4.0
	Date: 9/25/2023	Page 162 of 202
	Distribution Restrictions: Publicly available	Security Classification: Unclassified

to testing and be easily accessible. Ensure that documented limits match what is programmed into the test software and logs.

For a general discussion of thermal limits and margins, see also section 4.1.19.

Components that are controlled by heaters may have different margins on both the cold and hot sides, depending on the scenario. On the cold side, the full margin may not be necessary, but may be reduced based on the fact that the heater uncertainty margin may be less than the thermal modeling uncertainty. However, to have a reduced temperature margin, per the GEVS document, a duty cycle of 70% or less is recommended for heaters. On the hot side, if the heater is what is driving the component to the predicted hot temperature, it may not be necessary to provide a full margin on the hot side for testing, since again the thermal model uncertainty does not apply.

When performing qualification testing, some margin should be maintained between the test temperature and the hardware limits, to take into account testing tolerance and a safety margin.

As an example margin policy (SAGE thermal limits document available here for those inside the NASA firewall), the SAGE III policy included the following:

- Red limits were determined based on manufacturer datasheets, with the red limit for the chassis being set to that of the most limiting component. For the hot operational red limits for components whose manufacturer-supplied limits applied to the junction temperature, limits were set based on the predicted case temperature given that case temperatures were measured and not junction.
- Actions when a red limit is reached: The IP and facility will be put into or held in a safe, stable mode. An NCR will be written and an MRB will be convened. The MRB will determine the appropriate corrective action to be taken. If a thermal limit is reached, corrective action will be taken to warm/cool the hardware as part of putting the IP into a safe, stable mode. Actions to warm/cool the hardware include changing facility settings, powering the IP off, and/or turning the test article heaters on. A list of items that may result in red alerts but do not constitute NCRs will be posted at the Test Director and Test Conductor consoles.
- Yellow limits were generally set 5°C away from the red limits; however, some limits were set with a smaller gap to allow test targets to be set with enough margin.
- Actions when a yellow limit is reached: A note will be made in the shared log. Depending on what has tripped the limit, the Test Director, Test Conductor, and/or Thermal Engineer will monitor the system(s) to assess whether or not action needs to be taken in order to avoid reaching the red limit. If necessary, a Cognizant Engineer not on-shift may be called for consultation at the discretion of the Test Director. While writing an NCR is not required when a yellow limit is triggered, team members are not precluded from writing one as necessary for repeated, extended, and/or unexpected yellow alerts.

In general, red limits should mean that the hardware is at risk and action must be taken to warm or cool it if possible. Yellow limits should provide sufficient warning that a red limit is approaching, such that action can be taken to prevent the temperature from reaching the red limit; in general, a 10°C gap works well but this can vary based on how quickly the component's temperature can change.

Thermal limits can often change throughout the life of a project, especially as component and sub-assembly testing is completed. In general, the component testing should go to the widest thermal ranges,

 National Aeronautics and Space Administration	NASA Passive Thermal Control Engineering Guidebook	Revision: 4.0
	Date: 9/25/2023	Page 163 of 202
	Distribution Restrictions: Publicly available	Security Classification: Unclassified

and then those test-to values can become the not-to-exceed for the next level of testing. The payload should undergo full TVAC testing to the desired limits at its own instrument-level TVAC. However, if the payload is going on a larger vehicle such as an integrated spacecraft, it may not be possible to drive each component to its full range during the spacecraft level testing.

Initially, hot operational chassis limits for electronics boxes can be set using the thermal model to determine the chassis temperature at which the first internal component would reach a datasheet limit. Later, it may be advisable to make limits more conservative based on as-tested temperatures.

6.1.10 *Communication*

Some factors to consider in setting up communication methods to facilitate TVAC testing:

- Daily status meetings are very valuable during TVAC testing, both to provide a way for the testing team to discuss issues and to obtain consensus when decisions needed to be made. In addition, the meetings and subsequent notes serve as a way to disseminate important information about the test status to the team. Document notes in such a way that the value outweighs the burden on the leader of the meeting for preparing them.
- Creating a common test log spreadsheet that can be edited concurrently and accessed remotely is an extremely valuable tool. This should be tailored to the needs of each test, but some features to consider including are as follows:
 - Tabs for each position (facility, thermal, instrument ops, QAS, etc.), lessons learned.
 - Record information such as date, time, name, and test point along with notes
 - Staffing plan
 - Test profile and time projections
 - NCR log
 - Daily status summary
 - Test procedure log
 - Operator guidelines
 - Test configuration / change log (facility settings, heater set points, etc.)
 - Up-to-date remaining time projections for the test, updated by the TE
 - Current settings of any user-changeable items (TEC setting, heater settings, instrument operational model, etc.)
- In addition to having a common log for all test participants to record information, it is useful to create a document (or set of documents) that is specific to the needs of the thermal engineers. The log should contain (at a minimum) targets and predicted facility settings for each test condition as well as a place to track critical temperatures, monitor stability, and calculate rate of change. Reference documents should include information about temperature sensors (locations and limits), instructions from the lead thermal engineer on how to achieve targets and items to watch for during specific test conditions, as well as how to do things like retrieve data and make changes to displays. If possible, include graphical representations of temperature sensor locations alongside the real-time temperature data. At a minimum, graphical representations should be included in the

 National Aeronautics and Space Administration	NASA Passive Thermal Control Engineering Guidebook	Revision: 4.0
	Date: 9/25/2023	Page 164 of 202
	Distribution Restrictions: Publicly available	Security Classification: Unclassified

reference documents. The list of information that should be considered for the thermal-engineer-only log includes:

- Graphical and list-format description of flight and test sensors and locations
- Red and yellow limits for each sensor
- Targets and predicted facility settings for each test condition
- For each test condition, a place to enter and track critical temperatures, monitor stability, and calculate rate of change
- Instructions from lead TE on how to achieve targets and items to watch for during specific test conditions
- Instructions for retrieval of test data and running local displays
- Log of test history: what heater settings were needed to achieve targets, items that did not achieve target, any anomalous or not-understood behavior of the payload, etc.
- Ensure that there is an easy way for the entire thermal team to access the thermal log and other reference documents. Due to restrictions on common logins, it is desirable to use a Google Docs™ application or SharePoint® application rather than attempting to keep all of the information on a shared laptop. One alternative could be to use a lab computer (without the standard logon security restrictions), if one can be made available.
- Set up a template for comparing predictions to test data ahead of time. Choose thermal model nodes to be plotted (Measures preferred) and make sure they are in the same order as the respective flight sensor data will be output to facilitate quick and easy comparison.

Users inside the NASA firewall can find a sample test log and TE log are given on an Agency shared drive.

6.1.11 Test Reports

Best practice is to have a quick-look report out within a week of the test ending. This can be a very simple one-pager, and just gives personnel who were not directly involved with the test and overview of the status. Then, within one month of the end of the test, the complete thermal report should be issued. If this is too difficult, a draft report can be issued at the one-month mark, and revisions made later. It is important to get a report out early, since the post-test reporting can sometimes be neglected in the press of other project responsibilities. A thermal correlation report should follow as soon as practical; depending on the difficulty of correlation and the complexity of the test, this may be anywhere from 1 to 3 months after the completion of testing.

As an example of what should be included in a test report, sample reports from the SAGE III project (quick look, final, and correlation) are available for NASA users on an Agency shared drive.

The contents of a test report will obviously vary depending on the test, but the following should be considered for inclusion:

- Test purpose
- Personnel
- Description of article under test
- Test setup (GSE, EGSE, chamber, DAS, sensors and placement)

 National Aeronautics and Space Administration	NASA Passive Thermal Control Engineering Guidebook	Revision: 4.0
	Date: 9/25/2023	Page 165 of 202
	Distribution Restrictions: Publicly available	Security Classification: Unclassified

- Test profile
- Test results (temperatures, power, voltages, vacuum level)
- Data plots
- Test assessment
- Thermal margins assessment
- Contamination assessment
- Nonconformance reports (NCRs)
- Configuration change requests (CCRs)
- Requirements verification
- Operating hours log
- Lessons learned

6.2 Ambient Pressure Thermal Testing

Ambient testing includes a component level thermal cycling test in normal atmospheric pressure air or nitrogen, which demonstrates the ability for the hardware to operate under thermally stressing environments. In thermal cycle tests the components are tested to their extreme temperature range to bring out any workmanship defects. The temperature ramp rate is normally also the maximum during these tests.

The number of cycles and the temperature ramp rate required at this level of testing vary from program to program. With the unit powered on, a minimum of 8 thermal cycles at temperature ramp rate of 10°C/min, or maximum chamber rate, are required for thermal cycle tests. For some applications 3°C/min to 5°C/min transition rate might be acceptable. Some programs require a total of 26 thermal vacuum or thermal cycle tests in the entire life cycle of a hardware development, from which 4 thermal cycles are set aside for the vehicle level thermal vacuum testing, and the remainder of 22 cycles are done at component or sub-assembly level testing. The maximum operating temperature is set equal to the maximum predicted temperature plus an 11°C uncertainty margin. The negative uncertainty margin can be replaced by having a 25% heater control authority under the limiting condition (maximum heater duty cycle of 75%). Additional test margins can be applied to represent non-operational environments. Typically, a 5°C margin is applied for protoflight or qualification condition over the acceptance limits. A minimum of 1 hr dwell time should be obeyed for the plateau condition. However, the dwell times during the first and the last cycle should be long enough to perform functional tests. The soak duration is extended if stabilization is required during operation. Some programs require the last few cycles to be defect free.

6.3 Burn-in Thermal Testing

Burn-in testing is performed, typically, on electrical, electronic, and electromechanical components or units. This test can also be performed on valves, thrusters, and moving mechanical assemblies (MMA). The goal is to screen for latent defects due to material or workmanship issues by increasing the time under test (and usually in a worst-case environment) thereby eliminating weak items before they are put into service.

Components and units are designed with a desired service life and reliability. However, it has been shown that in a population of manufactured items that some subset will fail early. The likelihood of failure is highest during the initial and final phases of service life. The “bathtub” curve (Figure 34), described in many reliability and statistical control process references, shows the failure rates over time.

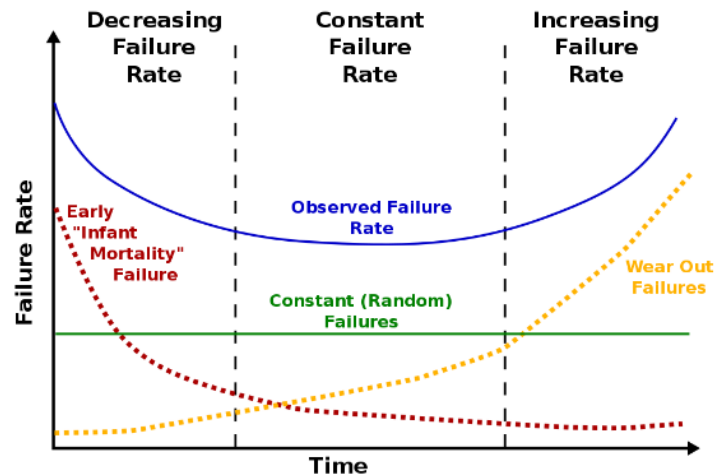

Figure 34. Bathtub curve (Wikipedia, 13 March 2018).⁸

Burn-in testing allows those items that fail during the “infant mortality” phase to be screened out from the population thereby yielding a higher reliability among the population put into service.

6.3.1 Component Level Testing

Components are typically procured from a manufacturer. At this level, burn-in testing is usually performed by the manufacturer and items are delivered with a known reliability (having already screened out those components that failed in their infancy).

6.3.2 Unit Level Testing

Most burn-in testing takes place at the unit level along with thermal vacuum and/or thermal cycling. While functional tests are not usually performed during Burn-in testing, the unit is operational. At the unit level, it is considered a thermal environmental test.

From the *Spacecraft Thermal Control Handbook* (Gilmore, 2002) [Ref 4]:

Burn-in tests are typically part of unit thermal cycle tests in which additional test time is accrued to meet a set requirement. The unit is either cycled or held at an elevated hot temperature during the burn-in test, and the unit is operational, although functional tests are not performed.

Note that burn-in testing at ambient temperatures has been shown to result in negligible additional stresses. Thus, the burn-in test environment should be at least equal to the acceptance environment. The test can be performed at ambient pressures. Commercial-off-the-shelf (COTS) units may be delivered having already received a burn-in test. However, commercial testing has been shown to be generally less strenuous due to less time under test and being tested at less stressful ambient temperatures (Gilmore, 2002).

Burn-in testing per *MIL-STD-1540E* (also labelled SMC Standard SMC-S-016 [Ref 13]; see section 6.3.8.3 part d.) outlines these requirements:

⁸ Credit Source: U.S. Army/Wyatts, https://commons.wikimedia.org/wiki/File:Bathtub_curve.jpg

 National Aeronautics and Space Administration	NASA Passive Thermal Control Engineering Guidebook	Revision: 4.0
	Date: 9/25/2023	Page 167 of 202
	Distribution Restrictions: Publicly available	Security Classification: Unclassified

For acceptance and protoqualification testing, units shall be “burned in” beyond the durations prescribed for thermal cycle and thermal vacuum testing. During burn-in, the test unit shall be powered and appropriately monitored. The duration of burn-in is such that additional operation shall be accumulated so that the combined duration of unit thermal cycling, unit thermal vacuum and the additional burn-in testing shall be at least 200 hours. The last 100 hours of operation shall be failure free. For internally redundant units, the operating hours shall consist of at least 100 hours of primary operation and at least 100 hours of redundant operation. Specification performance tests shall be performed prior to and following the burn-in test. The test is performed with the unit temperature either cycled between the acceptance temperature range or elevated at the acceptance hot temperature.

Burn-in testing is governed by three test parameters: temperature; total operating time; and failure-free hours. From *MIL-STD-1540*, these parameters are summarized in the *Spacecraft Thermal Control Handbook* in Table 13 below:

Table 13. Unit Burn-In Test Parameter Comparison (Gilmore, 2002)
Courtesy of The Aerospace Corporation

Thermal Cycle Test Parameter	Thermal Cycle Test Parameter (MIL-STD-1540C)
Temperature	Maximum expected, or at least +61°C
Total operating time	200 hrs minimum, including thermal cycling and vacuum time
Failure-free hours	Last 100 hrs (50 hrs primary and 50 hrs redundant side)

ISO 15864:2004(E), *Space systems — General test methods for space craft, subsystems and units* (applied to non-crewed vehicles) requires burn-in (wear in) testing for acceptance and protoqualification units (subsystems) for electrical and electronic items, valves, and thrusters and suggests optional testing for MMA. For the non-electrical devices, this testing is satisfied by increasing the cycles (e.g., valve – open/shut) as opposed to accumulating addition time.

Per MIL-STD-1540B [Ref 11], for valves, thrusters, and MMAs, the cycles of operation can be performed at ambient conditions.

Ultimately, burn-in testing should be according to the requirements of the test unit (however, most verification plans make at least some reference to the MIL-STD-1540 series [Ref 12] and other related series of standards). Burn-in testing per MIL-STD-1540_E is as follows:

For acceptance and protoqualification testing, units shall be “burned in” beyond the durations prescribed for thermal cycle and thermal vacuum testing. During burn-in, the test unit shall be powered and appropriately monitored. The duration of burn-in is such that additional operation shall be accumulated so that the combined duration of unit thermal cycling, unit thermal vacuum and the additional burn-in testing shall be at least 200 hours. The last 100 hours of operation shall be failure free. For internally redundant units, the operating hours shall consist of at least 100 hours of primary operation and at least 100 hours of redundant operation. Specification performance tests shall be performed prior to and following the burn-in test. The test is performed with the unit temperature either cycled over the acceptance temperature range or elevated at the acceptance hot temperature.

 National Aeronautics and Space Administration	NASA Passive Thermal Control Engineering Guidebook	Revision: 4.0
	Date: 9/25/2023	Page 168 of 202
	Distribution Restrictions: Publicly available	Security Classification: Unclassified

6.3.3 Other Considerations

Typically, if a unit undergoes minimal rework, qualification and acceptance testing must be performed again. However, burn-in testing should not be repeated.

If major rework and/or redesign is required then qualification, acceptance, and burn-in must be repeated. (See MIL-STD-1540B; section 7.3.9 for further discussion.)

If a unit is to be retested for any reason, the accumulated life should be considered and the effect on ultimate service life should be evaluated.

6.3.4 Further Reading

ISO 15864:2004(E), *Space systems – General test methods for space craft, subsystems and units [Ref 14]*, provides a baseline for environmental testing, including burn-in, for non-crewed spacecraft. This “light-weight” document has been increasingly referred to in the literature for cubesats and smallsats.

MIL-STD-883, *Test Method Standard - Microcircuits*, is a detailed guide for burn-in testing requirements for microcircuits. In June 2015 it was reported at the Electronics Technology Workshop (ETW) held by the NASA Electronic Parts and Packaging Program (NEPP) that version J of that document had been audited and was found to be out-of-date and its interpretation could be unclear. A task force was formed to guide corrective actions. In April 2016 an update, MIL-STD-833K, was issued.

7.0 Flight Operations

Flight operations will obviously be very different from one project to the next. For Ares I-X, which was a launch vehicle with a 3-minute flight time, flight operations consisted of work in the control room on the morning of launch. For Mars Reconnaissance Orbiter, flight operations consisted of several months of aerobraking passes, evaluating temperatures at each pass, comparing them to thermal model predictions, and recommending thermal and trajectory limits for upcoming passes. For a science instrument mounted on a spacecraft or the International Space Station, flight operations may consist of several months of commission, and several years of science operations.

However, there are similarities in that in all these cases, preparations much be made for flight operations which include thermal limits, red/yellow or go/no-go limits, procedures for anomaly resolution, disaster recovery, potential power outage, etc. The thermal engineer should ensure that all operational procedures have been reviewed for thermal aspects, all necessary temperatures are being monitored and compared to limits, and if necessary, a quick-look thermal model is available to answer flight questions in near real-time.

7.1 Thermal Limits for Flight

The approaches for setting thermal limits for flight will vary from project to project. This section will suggest guidelines, but project-specific guidance will obviously take precedence. Flight thermal limits should be formally documented well prior to flight, ideally prior to testing, so that coverage of all potential flight thermal ranges during testing is assured. The flight limits should be officially approved prior to the Flight Readiness Review (FRR) and should be easily accessible. The thermal engineer should ensure that documented limits match what is programmed into the flight software.

In general, red limits should mean that the hardware is at risk and action must be taken to warm or cool it if possible. Yellow limits should provide sufficient warning that a red limit is approaching, such that action can be taken to prevent the temperature from reaching the red limit. In most cases, yellow limits

 National Aeronautics and Space Administration	NASA Passive Thermal Control Engineering Guidebook	Revision: 4.0
	Date: 9/25/2023	Page 169 of 202
	Distribution Restrictions: Publicly available	Security Classification: Unclassified

will be set such that they are some set amount (5 or 10°C) away from the red limits. There will always be exceptions to this based on the specific hardware and whether it is heater controlled.

As an example (SAGE thermal limits document available to NASA users on an Agency shared drive), the flight thermal limits policy for the SAGE III project included the following:

- Red limits were generally set to most extreme as-tested temperatures; some exceptions were made where flight heritage documentation was available.
- In most cases, yellow limits were set to 10°C away from red limits.
- In cases where the vendor-specified component limit was beyond the temperature to which the system was tested in TVAC, one approach for flight limits is to set them equal to 5°C beyond the temperature to which the component was tested. Setting the red limit equal to the as-tested temperature may be overly conservative (the system successfully operated for long durations at the test temperature); however, setting the limit equal to the datasheet value may be unnecessarily risky. Setting the limits at 5°C beyond the as-tested value was a good compromise.
- Actions to take in flight for yellow and red limit violations were defined in the On-Orbit Contingency Procedures document. For thermal limits, the action to take for yellow limits was for the ops team to watch for the trend and notify the thermal engineering team if it continued to trend toward red. In general, the approach for hot operational red limits was to power off the subsystem or place the payload in safe mode, depending on which limit was reached. After that, a Material Review Board (MRB) was convened to determine what to do next. The approach for cold operational red limits was to convene an immediate MRB in some cases, it was not always desirable to power off because survival limits may be only slightly colder than operational limits and powering off would result in violation of the cold survival limit which could result in hardware damage. In a scenario where a temperature was just below the cold red operational limit, the MRB could decide to remain powered on. It is also important to note that several of the thermal limits had Fault Detection Isolation and Recovery (FDIR) in place which takes appropriate action automatically if a limit is reached.

7.2 Data Monitoring

[Information will be added here in a later revision, based on SAGE experience: Warren Davis]

8.0 Expectations for Project Milestone Reviews

The guidance in this section is intended to provide a thermal engineer with a high-level understanding of what is typically expected at major project milestone reviews. This section addresses model fidelity, level of detail in analysis, and plans for integration and testing. Note that the guidance provided here does not supersede any project-specific guidance or any requirements defined in agency, center, or organizational documents. As an example, to give a general idea of model level of fidelity, an example model is shown below at preliminary and critical design reviews in Figure 35 and Figure 36. Sample thermal presentations for many of the project review types are available to NASA users on an Agency shared drive. In addition to thermal analysis requirements, thermal engineers are expected to be involved with thermal hardware selection. Having knowledge of prospective hardware vendors and hardware lead times will aid in project planning. Thermal engineers must also understand the need for redundancy and have an understanding of failure analysis to facilitate a successful design.

 National Aeronautics and Space Administration	NASA Passive Thermal Control Engineering Guidebook	Revision: 4.0
	Date: 9/25/2023	Page 170 of 202
	Distribution Restrictions: Publicly available	Security Classification: Unclassified

Expected margins at each review level are given in the GOLD Rules, GSFC-STD-1000.

8.1 System Requirements Review (SRR)

- Thermal requirements list
- Outline of thermal cases / trade studies
- Early first-cut thermal analysis (can be hand-calculations or lumped- sum modeling)
- Early trades for high-level decisions (e.g., active versus passive cooling)
- High-level temperature limits and comparison to analysis results
- List of future work / potential areas of concern

8.2 Preliminary Design Review (PDR)

- Changes since SRR
- Define analysis tools and intent of modeling
- Early version of high-fidelity model, including description of subsystems, major components present, case setup, boundary conditions such as radiation/convection/conduction definition, planetary sources, power dissipation worst cases
- Margin policy for temperatures and heaters
- Component level limits and limit types (operational versus performance-based limits, survival limits)
- Subsystem-level limits and comparison to analysis results
- Predicted thermal power needs (heaters, coolers)
- Show compliance with thermal requirements (i.e., flow down of requirements from higher levels as well as derived requirements)
- List of future work / potential areas of concern: define tall poles or show stoppers in the design in terms of thermal
- List of long lead items for which procurement must begin before the Critical Design Review (CDR).

 National Aeronautics and Space Administration	NASA Passive Thermal Control Engineering Guidebook	Revision: 4.0
	Date: 9/25/2023	Page 171 of 202
	Distribution Restrictions: Publicly available	Security Classification: Unclassified

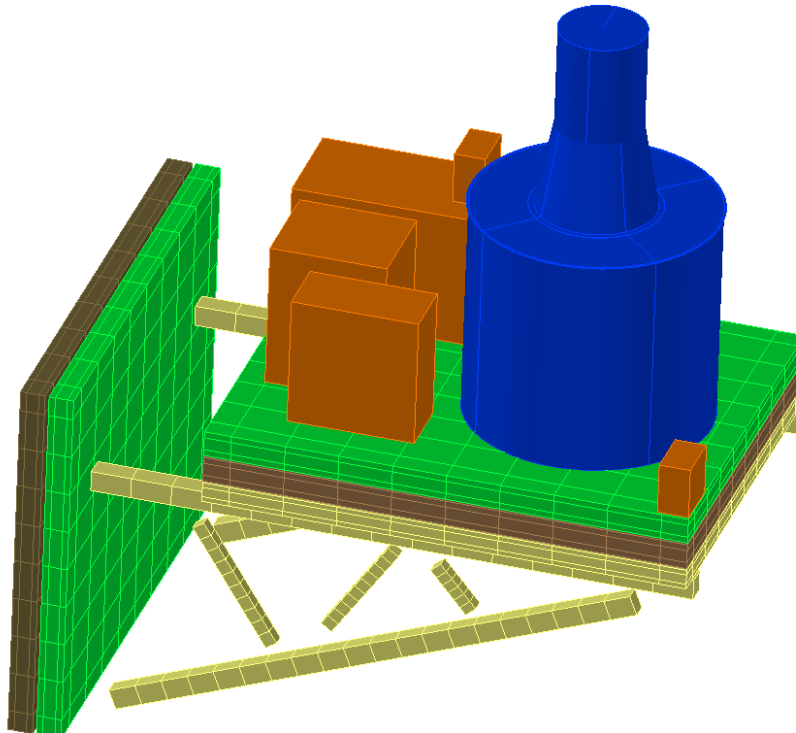



Figure 35. Sample PDR-level model (SAGE III on ISS, 1700 nodes in payload model, 4000 nodes in ISS model).

8.3 Critical Design Review (CDR)

- Changes since PDR
- High-fidelity model with predictions for all bounding flight scenarios (show details of modeling including updates to everything from PDR plus details such as conductance values, material properties, etc.)
- Refined power dissipations including timelines where appropriate, measured powers where possible
- Component-level limits and comparison to analysis results
- Predicted thermal power needs (heaters, coolers)
- Show compliance with thermal requirements and margin policy
- Thermal test plans (component, payload)
- Description of thermal hardware
- Status of any thermal procurements already underway
- List of future work / potential areas of concern

 National Aeronautics and Space Administration	NASA Passive Thermal Control Engineering Guidebook	Revision: 4.0
	Date: 9/25/2023	Page 172 of 202
	Distribution Restrictions: Publicly available	Security Classification: Unclassified

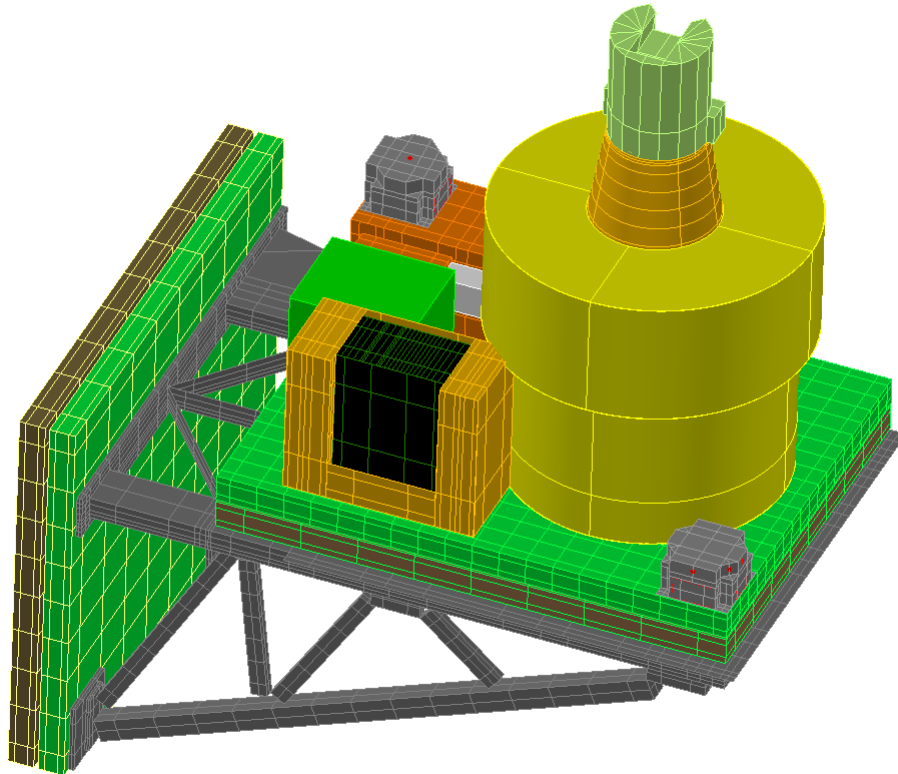

Figure 36. Sample CDR-level model (SAGE III on ISS, 10,000 nodes in payload model, 4000 nodes in ISS model).

8.4 Pre-Environmental Review

- Changes since CDR
- Test plan (profile, setup, facility, procedures, staffing, GSE)
- Test limits
- Pre-test predictions

8.5 System Acceptance Review / Pre-Ship Review

- Results of environmental testing
- Model correlation (may be a status rather than report of completed correlation)
- Updated flight predictions and comparison to limits
- Changes to limits for flight operations

8.6 System Integration Review

- All thermal non-conformances closed; thermal predictions complete showing thermal is ready for integration

8.7 Mission Operations Review

- All mission operations procedures involving thermal are complete

 National Aeronautics and Space Administration	NASA Passive Thermal Control Engineering Guidebook	Revision: 4.0
	Date: 9/25/2023	Page 173 of 202
	Distribution Restrictions: Publicly available	Security Classification: Unclassified

- All mission predictions are complete; no violations expected, or expected violations have explanations and waivers
- Thermal staff is prepared for operations

8.8 Flight Readiness Review/ Launch Readiness Review

- All thermal non-conformances closed; thermal predictions complete showing thermal is ready for flight
- Thermal staff is prepared for flight operations

9.0 Knowledge Sharing

Sharing knowledge gained is more than just an important part of every engineer's work, it is her/his responsibility.

When a thermal engineer learns something that may impact others' work, they should ensure everyone with an interest in the area is made aware of this new knowledge, to save others the wasted time of 're-inventing the wheel'. Sharing information in this way has two benefits, not only that the time of others is saved when they use the new information, but also that a culture of knowledge sharing is developed which means others will be more willing to share their information as well. If the item is something only of importance to the local group, the engineer may email the local thermal group with a cc to branch management to ensure that all analysts are sharing information and saving each other time, and/or place it on a local shared location. If the information gained is of importance or interest to the entire NASA thermal community, there are several methods for transferring the information:

- Information can be added to this Guidebook.
- Information can be broadcast to the entire NASA thermal community via the lead of the NESC Passive Thermal Technical Discipline Team (PT TDT)
- A NASA engineer looking for the answer to a specific question can utilize crowdsourcing by sending their question out to that same community.
- Information to be shared that consists of a file (subroutine, spreadsheet, etc) can be placed on the Agency shared drive as well as any local shared drive when available. No file will be shared outside the NASA community without the permission of the author. Files, comments, instructions and 'tips and tricks' for both software and hardware can also be placed on the OneNote notebook on the Agency share drive. Examples of items to share via the shared drive and OneNote are:
 - How-to's & tips on software and hardware
 - Code fragments & subroutines of general use
 - Materials information (and updates to the NESC material property database can be sent to the curator of the NESC Passive Thermal Technical Discipline Team site for inclusion)
 - Thermal hardware specifications and vendors
 - Model reviews: a OneNote digital notebook is a very effective way to capture thermal model review, with a thermal model writeup, model reviewer's comments, modeler's responses, and final closeout all in one place

 National Aeronautics and Space Administration	NASA Passive Thermal Control Engineering Guidebook	Revision: 4.0
	Date: 9/25/2023	Page 174 of 202
	Distribution Restrictions: Publicly available	Security Classification: Unclassified

- Reference document locations
- Software installation instructions
- General advice (e.g., on computer refreshes)
- Sample presentations
- On an organization’s local shared drive, information of only local interest can be shared, such as:
 - Shared network PCs and server names
 - Local thermal meeting agendas and topic items
 - Local training classes
 - Local reference file locations
 - Local facility information and recommendations
 - Project-specific information, including thermal model reviews for a project local to the Center
- Items of permanent general thermal interest can be posted on the NESC TDT NEN page, by emailing them to John Sharp
- Information can be shared in real-time by participation in Agency-wide Webinars led by the NESC PT TDT. The current coordinator is Eric Sunada; past Webinars are archived on the NESC TDT NEN page.
- If information is to be shared with a group of people, it can be useful to make an email list for that group.
- Specific documents can be shared either via SharePoint® software (in the same manner as this Guidebook) or via Office 365® application services.

These practices of sharing information ensure that one thermal analyst is not wasting time re-learning a lesson that someone else has already learned. Sharing lessons learned makes the entire NASA thermal community more efficient in doing their work, and thus contributes to the success of the overall NASA mission. Each engineer/analyst should consider that the time they spend to inform others of the problem or solution is time that is saved for others. A goal for the future is to improve effectiveness of sharing lessons learned among all NASA Centers as well as with other government organizations.

If a thermal engineer finds themselves in need of information or support that is not locally available, today’s IT tools allow for extremely rapid and effective sharing of information. Listings of experts in various software tools and disciplines, as well as thermal organization leads, are available at the NESC PT TDT pages for tools and contacts. Often, an expert at another NASA Center can provide five minutes of screen-sharing of active model work, which may quickly resolve issues for the analyst with a specific question. The annual TFAWS conference (<https://tfaws.nasa.gov/>) provides another great venue for making contacts with thermal engineers across the Agency as a support group.

Information garnered on tools should be sent to the tool vendor when appropriate. Red flags that might trigger this are tool bugs, new material information, operational information on a component or material, etc. Another method for sharing lessons learned is on a user forum for a particular tool.

 National Aeronautics and Space Administration	NASA Passive Thermal Control Engineering Guidebook	Revision: 4.0
	Date: 9/25/2023	Page 175 of 202
	Distribution Restrictions: Publicly available	Security Classification: Unclassified

At least at the end of a major project (and more often if appropriate), the analyst should prepare a presentation for their thermal group on lessons learned, which should be archived on their local shared location. The lessons learned should be evaluated and any appropriate information captured in the Agency database for lessons learned.

This ensures that those in the thermal field are all learning from each other, and that some project lesson learned is not missed simply because a member of the group did not have any contact with that particular project. This ensures the longevity of the lessons learned, especially in the case where there is turnover of the personnel in the group.

The thermal group at each NASA Center should meet regularly to discuss current work, on-going concerns, lessons learned, prospects for new work, etc. This facilitates open dialog among the members of the group, hopefully leading to better decisions, more proactive attitudes toward improvement, efficient work process improvement, and a smooth and pleasant work environment.

10.0 Appendix A: Acronyms

A list of acronyms used in this document is provided in Table 14.

Table 14. Acronym List

Abbreviation/ Acronym	Definition
AM	Air Mass
AO	Atomic Oxygen
BOL	Beginning of Life
BTU	British Thermal Unit
CAD	Computer Aided Design
CCR	Configuration change request
CDR	Critical Design Review
CFD	Computational Fluid Dynamics
CLT	Capability Leadership Team
CTE	Coefficient of Thermal Expansion
DoE	Design of Experiments
DSNE	Design Specification for Natural Environments
EDU	Engineering Development Unit
EFILMRS	EUS Flight Imaging Launch Monitoring Real-time System
ELC-4	ExPRESS Logistics Carrier 4
EOL	End of Life

 National Aeronautics and Space Administration	NASA Passive Thermal Control Engineering Guidebook	Revision: 4.0
	Date: 9/25/2023	Page 176 of 202
	Distribution Restrictions: Publicly available	Security Classification: Unclassified

Abbreviation/ Acronym	Definition
EOTP	Enhanced Orbital Replacement Unit Temporary Platform
ESGE	Electrical Ground Support Equipment
EUS	Exploration Upper Stage
ExPA	ExPRESS Payload Adapter
ExPRESS	Expedite the Processing of Experiments to Space Station
FD	Finite Difference
FE	Finite Element
FO	Facility Operator
FRR	Flight Readiness Review
GEVS	General Environmental Verification Standard
GSE	Ground Support Equipment
GSFC	Goddard Space Flight Center
GSL	Ground Systems Lead
GUI	Graphical User Interface
I&T	Integration & Test
IAM	Interface Adapter Module
IP	Instrument Payload
IR	Infrared
ISS	International Space Station
ITAR	International Traffic In Arms
JSC	Johnson Space Center
LaRC	Langley Research Center
LHP	Loop Heat Pipe
LLIS	Lesson Learned Information System
MAM	Mission Assurance Manager
MCRT	Monte Carlo ray trace
MEDLI	Mars Science Laboratory Entry Descent and Landing Instrument

 National Aeronautics and Space Administration	NASA Passive Thermal Control Engineering Guidebook	Revision: 4.0
	Date: 9/25/2023	Page 177 of 202
	Distribution Restrictions: Publicly available	Security Classification: Unclassified

Abbreviation/ Acronym	Definition
MIT	Massachusetts Institute of Technology
MLI	Multi-layer Insulation
MMA	Moving Mechanical Assemblies
MMOD	Micrometeoroid and Orbital Debris
MOR	Mission Operations Review
MRO	Mars Reconnaissance Orbiter
MSL	Mars Science Laboratory
NARR	North American Regional Re-analysis
NASA	National Aeronautics and Space Administration
NCR	Nonconformance report
NEDD	Natural Environments Definition for Design
NEN	NASA Engineering Network
NESC	NASA Engineering and Safety Center
NSRD	National Solar Radiation Database
NTRS	NASA Technical Report Server
NVP	Nadir Viewing Platform
PCB	Printed Circuit Board
PDR	Preliminary Design Review
PER	Pre-Environmental Review
PFL	Pumped Fluid Loop
PRT	Platinum Resistance Thermometer
PSA	Pressure Sensitive Adhesive
PT	Passive Thermal
PWA	Printed Wiring Assembly
QA	Quality Assurance
QAS	Quality Assurance Specialist
Radk	Radiation Conductor

 National Aeronautics and Space Administration	NASA Passive Thermal Control Engineering Guidebook	Revision: 4.0
	Date: 9/25/2023	Page 178 of 202
	Distribution Restrictions: Publicly available	Security Classification: Unclassified

Abbreviation/ Acronym	Definition
RMS	Root-mean-square
RTD	Resistance Temperature Detector
S&MA	Safety & Mission Assurance
SAGE	Stratospheric Aerosol and Gas Experiment
SAR	System Acceptance Review
SCA	Sample Cartridge Design
SI	International System (units)
SL	Subsystem Lead
SLS	Space Launch System
SRR	System Requirements Review
STCH	Spacecraft Thermal Control Handbook
STOP	Structural Thermal Optical Performance
STRIVES	Agency Scientific, Technical & Research Information discoVery System
TC	Thermocouple
TC	Test Conductor
TD	Thermal Desktop
TD	Test Director
TDT	Technical Discipline Team
TE	Thermal Engineer
TEC	Thermoelectric Cooler
TIM	Thermal Interface Material
TFAWS	Thermal and Fluids Analysis WorkShop
TO	Test Operator
TPS	Thermal Protection Systems
TRR	Test Readiness Review
TVAC	Thermal Vacuum
VCHP	Variable Conductance Heat Pipe

11.0 Appendix B: Contributors

Table 15 provides a partial list of individual contributors to this document. Many thanks go to these authors and many others who assisted in this effort for their collaborative work in producing this document.

Table 15. Contributors

Name	Center	Organization
Ruth Amundsen	LaRC	D206/Structural and Thermal Systems
Walt Bruce	LaRC	D206/Structural and Thermal Systems
Warren Davis	LaRC	D206/Structural and Thermal Systems
Josh Fody	LaRC	D206/Structural and Thermal Systems
Kaitlin Liles	LaRC	D206/Structural and Thermal Systems
Steve Rickman	JSC	NESC
Alex Scammell	LaRC	D206/Structural and Thermal Systems
Tory Scola	LaRC	D206/Structural and Thermal Systems
Kamrul Choudhury	ARC	RE/Mechanical Systems & Analysis
Ronald Lewis	JSC	ES3/Thermal Design Branch
Jose Rivera	JPL	353F/Instrument and Payload Thermal Engineering
Howard Tseng	JPL	353F/Instrument and Payload Thermal Engineering
Matthew Redmond	JPL	353F/Instrument and Payload Thermal Engineering
Richard Wear	SSC	EA32/Mechanical Design and Analysis
John Sharp	MSFC	EV34/Thermal Analysis & Control Branch
Greg Schunk	MSFC	EV34/Thermal Analysis & Control Branch
Eric Grob	GSFC	Code 545/Thermal Engineering Branch
Daniel Nguyen	GSFC	Code 545/Thermal Engineering Branch
Hume Peabody	GSFC	Code 545/Thermal Engineering Branch
Gary O'Neil	KSC	VA-H3/Launch Services – Environments & Launch Approval
Jared Congiardo	KSC	NE-XY/Exploration Division – Engineering Analysis
Brian Motil	GRC	Thermal Systems and Transport Processes Branch



Name	Center	Organization
John Siamidis	GRC	Thermal Systems and Transport Processes Branch
Erik Stalcup	GRC	Thermal Systems and Transport Processes Branch
George Harpster	GRC	Thermal Systems and Transport Processes Branch
Jared Berg	GRC	Thermal Systems and Transport Processes Branch
Ryan Edwards	GRC	Thermal Systems and Transport Processes Branch
William Fabanich	GRC	Thermal Systems and Transport Processes Branch
Richard Wear	SCC	Mechanical Design and Analysis Branch
Tom Squire	ARC	Projects Management Division

 National Aeronautics and Space Administration	NASA Passive Thermal Control Engineering Guidebook	Revision: 4.0
	Date: 9/25/2023	Page 181 of 202
	Distribution Restrictions: Publicly available	Security Classification: Unclassified

12.0 Appendix C: References

1. Liles, K.A., et al, “Development and Implementation of Efficiency-Improving Analysis Methods for the SAGE III on ISS Thermal Model,” *Thermal and Fluids Analysis Workshop*, Daytona Beach, FL, 2013. (<https://tfaws.nasa.gov/TFAWS13/>, 2013-TFAWS-IN-002 -- in interdisciplinary section)
2. Liles, K.A., Amundsen, R.M., Davis, W.T., McLeod, S., “Thermal Modeling Method Improvements for SAGE III on ISS,” *Thermal and Fluids Analysis Workshop*, Silver Spring, MD, 2015.
3. Liles, K.A., Amundsen, R.M., Davis, W.T., Carrillo, L.Y., “Thermal Design and Analysis of an ISS Science Payload – SAGE III on ISS,” *International Conference on Environmental Systems*, Charleston, SC, 2017.
4. Gilmore, D. G. (Editor), *Spacecraft Thermal Control Handbook*, El Segundo, The Aerospace Press, 2002.
5. Bate, R. R., Mueller, D. D., and White, J. E., *Fundamentals of Astrodynamics*, New York, Dover Publications, Inc., 1971.
6. Battin, R. H., *An Introduction to the Mathematics and Methods of Astrodynamics*, New York, American Institute of Aeronautics and Astronautics, 1987.
7. Moeller, T.M., Wilhite, A.W., Liles, K.A., “Selection of Thermal Worst-Case Orbits via Modified Efficient Global Optimization,” NASA/TM-2014-218182, 2014.
8. Amundsen, R.M., Davis, W.T., Liles, K.A., “Correlation of the SAGE III on ISS Thermal Models in Thermal Desktop,” *International Conference on Environmental Systems*, ICES-2017-171, Charleston, SC, 2017.
9. Davis, W.T., Liles, K.A., and Martin, K., “SAGE III Lessons Learned on Thermal Interface Design,” *Thermal and Fluids Analysis Workshop*, Silver Spring, MD, 2015.
10. Jones, D.R., Schonlau, M., Welch, W.J., “Efficient Global Optimization of Expensive Black-Box Functions,” *Journal of Global Optimization* 3: 455-492, 1998.
11. MIL-STD-1540B, *Test Requirements For Space Vehicles*, revision B (DOD, 1974)
12. MIL-STD-1540D, *Product Verification Requirements For Launch, Upper Stage, And Space Vehicles*, revision D (DOD, 1999)
13. SMC Standard SMC-S-016, *Test Requirements for Launch, Upper-Stage and Space Vehicles*, (USAF Space Command, 2008)⁹
14. ISO 15864:2004(E) *Space systems – General test methods for space craft, subsystems and units*, first edition (the International Organization for Standardization, 2004)

⁹ Information in this document is also contained in The Aerospace Corporation report #TR-2004(8583)-1, Rev A (also published as SMC-TR-06-11). It is also commonly referred to MIL-STD-1540E).

 National Aeronautics and Space Administration	NASA Passive Thermal Control Engineering Guidebook	Revision: 4.0
	Date: 9/25/2023	Page 182 of 202
	Distribution Restrictions: Publicly available	Security Classification: Unclassified

13.0 Appendix D: Useful Links

Table 16 gives links of interest for thermal engineers.

Table 16. Useful Links

Reference	Description
NASA Lessons Learned Database https://llis.nasa.gov	Formal lessons learned database for the Agency
<u>Lessons Learned (IKM -- Institutional Knowledge Management)</u> One Place (LaRC internal only) Console View (drop down at top right)	LaRC system for knowledge capture and Non Conformance Reports (NCRs)
NASA Engineering Network (NEN) Passive Thermal Control Active Thermal	Consolidated repository for resources for the thermal community, including best practices, events, contacts, forums, links, standards, useful documents, etc.
NESC Academy General: https://nescacademy.nasa.gov/ Many Passive Thermal lessons	Online training on various topics, for example radiation analysis, orbital analysis, arc-jet testing, numerical methods, thermal blankets, thermal testing, and more.
NESC Passive Thermal listing of Tools and Facilities	Listing of thermal software tools and facilities in use at Centers, as well as a listing of experts.
GSFC Thermal Wiki Note that this site is no longer open to all NASA users by default – you must request NAMS access to be able to view it (search for GSFC ETD Confluence Access). Exact instructions are located on the Agency thermal share	Contains many good references including heater sizing, radiator sizing, limits definition, heat pipe design, coatings, blanket design, systems engineering, thermal analysis, thermal testing.
Agency Shared Drive E.g., <ul style="list-style-type: none"> • Ablation references • Materials information 	Agency-wide repository for sharing thermal information; includes an Agency-wide OneNote digital notebook. Access is controlled within NASA firewall to thermal engineers. Email list of users is NASA-DL-thermal-share-drive.

 National Aeronautics and Space Administration	NASA Passive Thermal Control Engineering Guidebook	Revision: 4.0
	Date: 9/25/2023	Page 183 of 202
	Distribution Restrictions: Publicly available	Security Classification: Unclassified

Reference	Description
TFAWS Current year TFAWS at https://tfaws.nasa.gov/ TFAWS archives at https://tfaws.nasa.gov/about/archives/	NASA-sponsored annual thermal and fluids conference
NASA Technical Standards Agency: https://standards.nasa.gov Thermal-Related are on the Agency Passive Thermal NEN site	NASA standards (e.g., <i>NASA-STD-5021 Thermal Protection System Standard for Crewed Spacecraft</i>)
NTRS https://ntrs.nasa.gov/	NASA Technical Report Server
Aerospace Corp. Intro to Satellite Thermal Control Course	Satellite Thermal Control Course
AIAA-2011-3757 Defining Ablative Thermal Protection System Margins for Planetary Entry Vehicles	Defining TPS margins
NASA TM 4527 Natural Orbital Environment Guidelines for Use in Aerospace Vehicle Development (1994) NASA TM-2001-211221 Guidelines for the Selection of Near-Earth Thermal Environment Parameters for Spacecraft Design (2001 update)	Environments for Near-Earth Orbit
TP-2005-212792	GSFC Coatings Handbook
Modeling electronics reference on Agency shared drive (Electronics thermal analysis needs.doc)	Advice for what is needed in modeling electronics

Links specific for testing information are given in Table 17.

Table 17. Testing Links

Reference	Link
NESC Academy Class on Thermal Testing	Part 1 of 5-part series, https://mediaex-server.larc.nasa.gov/Academy/Play/8c1cd7c960df41afa9a3e5936032759a1d?catalog=8b40998b-9b64-4987-a2b6-75dc6af48d1e
Thermal Vacuum Testing at JPL	http://mediaex-server.larc.nasa.gov/Academy/Viewer/?peid=e75261ee9d3f488eaa20f7a742e610341d
Rationale for Selected MIL-STD-1540E Thermal Test Requirement	http://mediaex-server.larc.nasa.gov/Academy/Viewer/?peid=3d29c289da404ed394a839bae8b6f3201d

 National Aeronautics and Space Administration	NASA Passive Thermal Control Engineering Guidebook	Revision: 4.0
	Date: 9/25/2023	Page 184 of 202
	Distribution Restrictions: Publicly available	Security Classification: Unclassified

Reference	Link
GSFC testing documents, often used for Earth-orbiting payload test definition	GEVS (GSFC-STD-7000) GOLD Rules, GSFC-STD-1000
SMC-TR-06-11 Test Requirements for Launch, Upper-Stage, and Space Vehicles	SMC-TR-06-11 (also called Aerospace report TR-2004-8583-1 REV. A)
SSP-41172 ISSP Qualification and Acceptance Environmental Test Requirements	SSP-41172
NASA Payload Test Requirements	https://standards.nasa.gov/standard/nasa/nasa-std-7002
TFAWS11 thermal properties testing	https://tfaws.nasa.gov/TFAWS11/Proceedings/Thermal%20Properties%20Testing%20Course.pdf
TFAWS 03 Thermal Testing short courses	https://tfaws.nasa.gov/TFAWS03/tfaws03_events.html
TFAWS 2010 Testing papers	https://tfaws.nasa.gov/TFAWS10/Proceedings/TFAWS_2010_Proceedings.pdf
TFAWS 2012 Testing Short Course	https://tfaws.nasa.gov/TFAWS12/Proceedings/TFAWS%202012%20Proceedings.pdf (see Thermal Test Requirements, Design and Examples Course)

14.0 Appendix E: Materials Databases

Note: Any of these databases, including descriptions and references as well as material properties, are provided 'as is' without any warranty of any kind, either expressed, implied, or statutory, including, but not limited to, any implied warranties of merchantability, or fitness for a particular purpose, or any warranty that the database will be error free. In no event shall the United States government, or its contractors or subcontractors, be liable for any damages, including, but not limited to, direct, indirect, special or consequential damages, arising out of, resulting from, or in any way connected with these databases, whether or not based upon warranty, contract, tort, or otherwise, whether or not injury was sustained by persons or property or otherwise, and whether or not loss was sustained from, or arose out of the results of, or use of, the database. The United States government disclaims all warranties and liabilities regarding third party data. The source of any referenced third party data should be consulted to verify such data prior to use.

Materials Reference	Description
NESC TDT NEN – TD Materials Databases	Database of TD properties maintained, and distributed through NESC TDT NEN page

 National Aeronautics and Space Administration	NASA Passive Thermal Control Engineering Guidebook	Revision: 4.0
	Date: 9/25/2023	Page 185 of 202
	Distribution Restrictions: Publicly available	Security Classification: Unclassified

Materials Reference	Description
TPSX Material Properties Database https://tpsx.arc.nasa.gov/	Ames-maintained data on TPS materials
Cullimore & Ring Technologies https://www.crtech.com/fluid-properties	Many good fluid tables
CINDAS data (was Touloukian) https://cindasdata.com/	On-line database replacing the huge blue reference Purdue Touloukian volumes. Also includes Aerospace Structural Metals Database. Requires subscription.
Knovel https://app.knovel.com	Web-based materials reference search engine
Engineering Toolbox https://www.engineeringtoolbox.com/material-properties-t_24.html	Thermophysical properties and emissivities for many different kinds of materials
Matweb http://www.matweb.com/	Material properties database
Sheldahl Red Book https://www.sheldahl.com/sites/default/files/2020-02/RedBook.pdf	Datasheets for Sheldahl thermal control materials
MAPTIS (Materials And Processes Technical Information System) https://maptis.nasa.gov/	NASA site for materials and processes, NASA login
NASA TP-2005-212792 Spacecraft Thermal Control Coatings References	Summary of α and ϵ on many materials, from GSFC
GE Genium data book Hard copy exists at Langley	Solid, fluid and gas properties as well as good summary of contact conductances

 National Aeronautics and Space Administration	NASA Passive Thermal Control Engineering Guidebook	Revision: 4.0
	Date: 9/25/2023	Page 186 of 202
	Distribution Restrictions: Publicly available	Security Classification: Unclassified

Materials Reference	Description
MISSE data on materials degradation: https://ntrs.nasa.gov/archive/nasa/casi.ntrs.nasa.gov/20150016412.pdf (white paints, beta cloth, fiberglass) MISSE data on degradation of optical properties for silver Teflon Table 22 of the MISSE data in NASA TP-2013-217498 at https://ntrs.nasa.gov/citations/20140003183 shows changes in silver Teflon properties during flight.	MISSE data must be evaluated carefully to ensure the material of interest has similar orbit exposure as available MISSE data
NASA TP-1999-209263 Multilayer Insulation Material Guidelines, at https://ntrs.nasa.gov/citations/19990047691	Guideline document for material selection and MLI design
<i>NIST "Thermophysical Properties of Fluid Systems"</i> https://webbook.nist.gov/chemistry/fluid/	National Institute of Standards and Technology online Fluid/Gas property database

15.0 Appendix F: Center Capabilities

As part of an NESC effort, for those inside the NASA firewall, a listing of thermal software tools in use at each center, as well as a listing of experts in each tool, is available on the NESC NEN Passive Thermal site.

16.0 Appendix G: Tools Developed In-House

Table 18 provides a partial listing of tools developed in-house at several NASA Centers.

 National Aeronautics and Space Administration	NASA Passive Thermal Control Engineering Guidebook	Revision: 4.0
	Date: 9/25/2023	Page 187 of 202
	Distribution Restrictions: Publicly available	Security Classification: Unclassified

Table 18. Tools Developed In-House

Tool	Center	Type	POC
FilePlottingTools: fileplottingtools.larc.nasa.gov	LaRC	Excel – for TD results processing	Tory Scola
BPMapper	LaRC	Routine for mapping from MINIVER to TD input format	Tory Scola
Mars Orbital Debris Analysis Code (MOrDAC)	LaRC	Evaluation of thermal response of small particles entering the Martian atmosphere	Kaitlin Liles
Efficient Global Optimization Tool	LaRC	Matlab – Finds global maximum or minimum value of a function that has a complex response shape	Developed by Tim Moeller NASA POC: Kaitlin Liles mailto:
TD Scripts and Subroutines	LaRC		As in Agency OneNote
CHarring Ablator Response(CHAR) Code and Tutorial	JSC	Direct and Inverse Thermal Response and Ablation Simulation Software	Adam Amar
SURFICE (SURface ICE)	MSFC	Routine for predicting rate of ice growth from atmosphere onto cryogenic/cold surfaces (launch vehicles)	John Sharp
TopHAT (Topographical Heatrate Application Tool)	MSFC	Excel – mapping of aerothermal heat rates	Brian Hamill



Tool	Center	Type	POC
Generalized Fluid System Simulation Program (GFSSP), https://www.nasa.gov/gfssp	MSFC	General-purpose computer program for analyzing steady state and time-dependent flowrate, pressure, temperature and concentrations in a complex flow network	Alok Majumdar
GMM/TMM Converter	GSFC	Conversion utility between TSS, ESARAD, and Thermica GMM formats and SINDA, ESATAN TMM formats	Hume Peabody Kan Yang
Heat Analysis Manager (HAM)	GSFC	Software for generating heat maps and extracting data from TD result files	Daniel Bae

17.0 Appendix H: Model Archives

Table 19 provides a list of completed and archived models that may be used for reference at the discretion of the specified point of contact. It is the responsibility of the thermal modeler to determine if their model is suitable for dissemination. Models can be posted on the Agency thermal share drive here, to allow others to benefit from them, but modelers are encouraged to get written permission from their project, or follow the Agency procedure for release, before posting a model.

Table 19. List of Archived Models

Project	Model Archive Date	Software & Version	Model Features	Level of Correlation	Level of Sensitivity	Point of Contact (Center/Name)
SAGE III on ISS	June 2017	Thermal Desktop 5.7	<ul style="list-style-type: none"> • Articulators • MLI • TECs • Heaters • Board-level electronics • Low-Earth orbit with time-varying parameters • Simplified ISS and Dragon • ISS model can be run in °C or °FTVAC configurations • Configurations for Dragon solo, robotic transfer on ISS, flight ops 	<p>Fully correlated to system-level TVAC (overall RMS error < 3°C)</p> <p>Partially correlated to flight</p> <ul style="list-style-type: none"> • Overall RMS error <5°C • Good matching for worst-case hot beta angle • Significant under-predictions at high negative beta angles 	EAR	LaRC / Kaitlin Liles
MEDLI on MSL	Nov. 2011	Patran Thermal 2007	<ul style="list-style-type: none"> • Board-level electronics 	Partially correlated to TVAC (within 10°C)	Open	LaRC / Kaitlin Liles



Project	Model Archive Date	Software & Version	Model Features	Level of Correlation	Level of Sensitivity	Point of Contact (Center/Name)
Ares I-X	2010	Thermal Desktop 5.7	<ul style="list-style-type: none"> • On-planet analysis • First comparison of internal TD planet method to manual planet build • 350' 2-million-lb vehicle • On pad and ascent cases • Integration of models from 5 organizations • Box level analysis • FloCAD model for air purge • First use at LaRC of Boundary condition mapper (BCM) for aeroheating 	<p>Documented in TFAWS 2010 paper, https://tfaws.nasa.gov/TFAWS10/Proceedings/Passive%20Thermal/Ruth%20Amundsen.pdf</p>	EAR	LaRC / Ruth Amundsen
MRO	2001	MSC Patran / Thermal Desktop	<ul style="list-style-type: none"> • Trajectory pass for orbital analysis in Thermal Desktop • Thermal model and aeroheating in MSC Patran 	<p>Correlated to average 5°C over hundreds of aeroheating passes. Documented in 07ICES-17, https://ntrs.nasa.gov/citations/20070030304AIAA 2007-1214, and TFAWS05 paper, https://tfaws.nasa.gov/TFAWS05/Website/files/ThermalPaperSession/TFAWS05_RAmundsen_TH.pdf</p>	Open	LaRC / Ruth Amundsen



Project	Model Archive Date	Software & Version	Model Features	Level of Correlation	Level of Sensitivity	Point of Contact (Center/Name)
Mars Odyssey	2001	MSC Patran / Thermal Desktop	<ul style="list-style-type: none"> Trajectory pass for orbital analysis in Thermal Desktop Thermal model and aeroheating in MSC Patran 	Documented in AIAA 2003-3764, https://ntrs.nasa.gov/citations/20030065626	Open	LaRC / Ruth Amundsen
Mars Global Surveyor (MGS)	2004	MSC Patran / Thermal Desktop	<ul style="list-style-type: none"> Post-flight model build and correlation to trajectory and aero-heating passes Trajectory pass for orbital analysis in Thermal Desktop Thermal model and aeroheating in MSC Patran 	Correlated to within 5%. Documented in AIAA 2003-3765 (https://ntrs.nasa.gov/citations/20030066233) and Journal of Spacecraft and Rockets 2005 paper.	Open	LaRC / Ruth Amundsen
Automated Aerobraking (AAB)	2010	Thermal Desktop 5.3	<ul style="list-style-type: none"> Single TD model for orbital and aeroheating trajectory pass (using BCM) Mars and Venus trajectories Example model to prove out concept of spacecraft performing automated aerobraking 	None – proposed mission only. Rough correlation to MRO trajectory. Documented in TFAWS 2010 paper (https://tfaws.nasa.gov/TFAWS10/Proceedings/Aerothermal/Ruth%20Amundsen.pdf)	Open	LaRC / Ruth Amundsen



Project	Model Archive Date	Software & Version	Model Features	Level of Correlation	Level of Sensitivity	Point of Contact (Center/Name)
AA-2	2018	Thermal Desktop 5.8	<ul style="list-style-type: none"> Model of Crew Module and Separation Ring Imported as xref into full vehicle model of AA-2 with Launch Abort System (LAS) Air purge modeled via conductors 	None as of 2018. Flight in 2019.	Open	LaRC / Ruth Amundsen
Hyper-X (X-43A)	2006	MSC Patran	<ul style="list-style-type: none"> Only high-heating areas modeled (wing, tail, nose) Full 3D, aeroheating on skins and sharp leading edges 	Rough correlation to flight. Papers JANNAF 1997, 2001, 2003, TFAWS 2004 (https://tfaws.nasa.gov/TFAWS04/Website/program/paper/TFAWS04_RAmundsen_Aero_CFD.pdf)	ITAR	LaRC / Ruth Amundsen
Delta II Stage 2		Thermal Desktop	Entire 2nd Stage to predict avionics transient thermal response, prelaunch and flight. Used for integration with payload for mission specific integrated stage/payload thermal response.	Continuous validation for as-flown telemetry.	SBU ITAR ULA Proprietary	KSC / Cindy Fortenberry
Delta IV Cryogenic Second Stage		Thermal Desktop	Entire 2nd Stage to predict avionics and propellant transient thermal response, prelaunch and flight. Used for integration with payload for mission specific integrated stage/payload thermal response.	Continuous validation for as-flown telemetry.	SBU ITAR ULA Proprietary	KSC / Cindy Fortenberry



Project	Model Archive Date	Software & Version	Model Features	Level of Correlation	Level of Sensitivity	Point of Contact (Center/Name)
Centaur III Forward End		Thermal Desktop	Forward end of Centaur III inclusive of entire avionics suite (Common Avionics Block 3B+). Used for integration with payload for mission specific integrated stage/payload thermal response.	Continuous validation for as-flown telemetry.	SBU ITAR ULA Proprietary	KSC / Cindy Fortenberry
Falcon 9 Stage 2		Thermal Desktop	Entire 2nd Stage to predict avionics, TVC, and selected propulsion component transient thermal response, prelaunch and flight. Used for integration with payload for mission specific integrated stage/payload thermal response.	Continuous validation for as-flown telemetry.	SBU ITAR SpaceX Proprietary	KSC / Cindy Fortenberry



Project	Model Archive Date	Software & Version	Model Features	Level of Correlation	Level of Sensitivity	Point of Contact (Center/Name)
Falcon 9 Composite Overwrap Pressure Vessel		Thermal Desktop	Detailed model of aluminum liner and composite overwrap. Simulates internal helium fill/pressurization and associated heat of compression. Also simulates external fluid immersion as necessary, including boiling phases associated with level of superheat. Provides detailed transient thermal response to pressurization, depressurization, and immersion, including axial (boss to boss) and radial (internal gas to external composite surface) temperature gradients.	Validated against testing using ambient and cryogenic helium pressurization combined with cryogenic immersion. Correlated against instrumentation mounted internal (gas and liner) and external to the COPV.	SBU ITAR SpaceX Proprietary	KSC / Cindy Fortenberry



Project	Model Archive Date	Software & Version	Model Features	Level of Correlation	Level of Sensitivity	Point of Contact (Center/Name)
Falcon 9 Composite Overwrap Pressure Vessel		Simcenter Star CCM+	Detailed model of aluminum liner and composite overwrap. Simulates internal helium fill/pressurization and associated heat of compression. Also simulates external fluid immersion as necessary. Provides detailed transient thermal response to pressurization, depressurization, and immersion, including axial (boss to boss) and radial (internal gas to external composite surface) temperature gradients.	Validated against testing using ambient and cryogenic helium pressurization combined with cryogenic immersion. Correlated against instrumentation mounted internal and external to the COPV.	SBU ITAR SpaceX Proprietary	KSC / Cindy Fortenberry
Atlas V Booster Avionics Pod		Thermal Desktop	Avionics and ECS	Continuous validation for as-flown telemetry.	SBU ITAR ULA Proprietary	KSC / Cindy Fortenberry
Falcon 9 Payload Fairing		MINIVER Thermal Desktop	Payload fairing structure and associated TPS, internal acoustic protection, and jettison hardware.	Validation against available flight data.	SBU ITAR SpaceX Proprietary	KSC / Cindy Fortenberry
Pegasus XL Stage 3		Thermal Desktop	3rd Stage to predict avionics transient thermal response, prelaunch and flight. Used for integration with payload for mission specific integrated stage/payload thermal response.	Continuous validation for as-flown telemetry.	SBU ITAR Northrop Grumman Proprietary	KSC / Cindy Fortenberry



Project	Model Archive Date	Software & Version	Model Features	Level of Correlation	Level of Sensitivity	Point of Contact (Center/Name)
Star 48BV Kick Stage		Thermal Desktop	Predict avionics, ordnance, and separation system transient thermal response, prelaunch and flight. Used for integration with payload for mission specific integrated stage/payload thermal response.	Validation planned against flight data from Parker Solar Probe	SBU ITAR Northrop Grumman Proprietary	KSC / Cindy Fortenberry
Mars Science Laboratory / Mars 2020 Payload Fairing Environmental Control System Failure		Thermal Desktop	A thermal/fluid model that uses a flow network connected to payload fairing and payload thermal modeling to mimic the mass flow of temperature controlled gas from an operating payload fairing ECS, through the transition to a non-operational ECS, to a still gas volume that stratifies in reaction to heat rejection from the payload.	Model not validated. Inputs to mimic the gas behavior based upon CFD analysis results.	SBU ITAR ULA Proprietary	KSC / Cindy Fortenberry
CRYOTE I		Thermal Desktop	Cryogenic tank fill/drain simulation to evaluate heat load to cryogen through various insulation schemes and the concept of vapor cooled shielding.	Modeling validated against vacuum test data using liquid nitrogen as the tank cryogen.	ULA Proprietary	KSC / Cindy Fortenberry



Project	Model Archive Date	Software & Version	Model Features	Level of Correlation	Level of Sensitivity	Point of Contact (Center/Name)
CRYOTE III		Thermal Desktop	Cryogenic tank fill/drain simulation to evaluate heat load to cryogen through various insulation schemes and the concept of vapor cooled shielding.	Modeling validated against ambient pressure test data using liquid nitrogen and liquid hydrogen as the tank cryogen.	ULA Proprietary	KSC / Cindy Fortenberry
MEDLI2 on Mars 2020	2018	Thermal Desktop	<ul style="list-style-type: none"> Electronics box and pressure transducers are modeled within Mars 2020 aeroshell representation (includes parts of descent stage and rover). Electronics box includes board level analysis. SpaceClaim used to import and mesh electronics box chassis, pressure tubing, and rover helicopter debris shield. 	<ul style="list-style-type: none"> EDU version of electronics box (SSE) correlated to TVAC test results within 5°C. Unpowered SSE correlated to MEDLI System Thermal Test (STT) data to within 3.5°C. 	Open	LaRC / Alex Scammell
GHAPS (high altitude balloon project)	2017	Thermal Desktop	<ul style="list-style-type: none"> High altitude balloon project Simulates ground, ascent, and float environments Time varying registers to simulate pressure and temperature decrease during ascent. 	<ul style="list-style-type: none"> No correlation. 	Open	MSFC / Shawn Breeding

 National Aeronautics and Space Administration	NASA Passive Thermal Control Engineering Guidebook	Revision: 4.0
	Date: 9/25/2023	Page 198 of 202
	Distribution Restrictions: Publicly available	Security Classification: Unclassified

18.0 Appendix I: Center-Specific Guidance

18.1 LaRC-Specific Guidance

In some cases, information in this Guidebook has been, or is in the process of being, elevated to a more formal type of documentation such as the LaRC Engineering Best Practices (LF 209) worksheet, a Langley Management System (LMS) procedure, and/or a NASA Lessons Learned Information System (LLIS) submission.

The process for reviewing formal STSB (Engineering Directorate, Structural and Thermal System Branch, D206) reports is defined in LMS-OP-2221.

Reports or presentations generated at LaRC that are to be sent to audiences outside of NASA must be approved through the Agency Scientific, Technical & Research Information discoVery System (STRIVES).

Processes to follow for spaceflight hardware development and reviews are in these documents:

- Aerospace Systems Implementation, Testing And Integration Within Engineering Directorate
- Space Flight Independent Life Cycle Review Procedural Requirements (LPR 7120-7)

STSB maintains a shared drive for archival and dissemination of thermal-specific guidance, only accessible to STSB members. In general, any thermal information posted to this location is also copied to the Agency wide shared drive, unless the information is sensitive or LaRC-specific in some way. The thermal group maintains some of the shared information in a OneNote Thermal Knowledgebase notebook. Again, anything added to that OneNote notebook file is also added to the Agency-wide OneNote notebook file.

18.2 KSC/Launch Services Program Guidance

The Launch Services Program, while located at KSC, operates mostly independently of KSC in its work in the thermal analysis discipline. Thus, the guidance provided here should not be construed as that of the KSC engineering directorate.

The thermal analysis discipline within LSP interfaces with the commercial launch service providers and the NASA payload providers to ensure:

- thermal interface requirements between launch vehicle and payload are met
- ensure payload thermal response through separation from the launch vehicle are within allowable specifications
- proper thermal modeling of the payload within the commercial provider's thermal analyses

The discipline also monitors the launch vehicle design, analysis, qualification, and flight throughout its lifetime to inform the Program of a vehicle's risk status for a wide array of NASA payloads. In this role, the LSP thermal analysis team:

- interfaces with commercial launch provider thermal teams to understand their institutional practices for thermal design, analysis, and test
- performs thermal assessment of launch vehicle hardware qualification testing to ensure testing levels and durations are appropriate for the usage of the hardware. It should be noted that the recommendations from SMC-S016 (or its predecessor, MIL-STD-1540) is used as the baseline for

thermal margins for analysis uncertainty, acceptance testing, and qualification (figure below). Deviations from this standard are not unusual, but must be supported with rationale from analysis, specifics of item operation, and/or extensive flight history.

- Performs strategic IVV analyses of launch vehicle systems
- Provides day of launch on-console support to the NASA Chief Engineer for go/no-go assessments of the launch vehicle readiness for launch

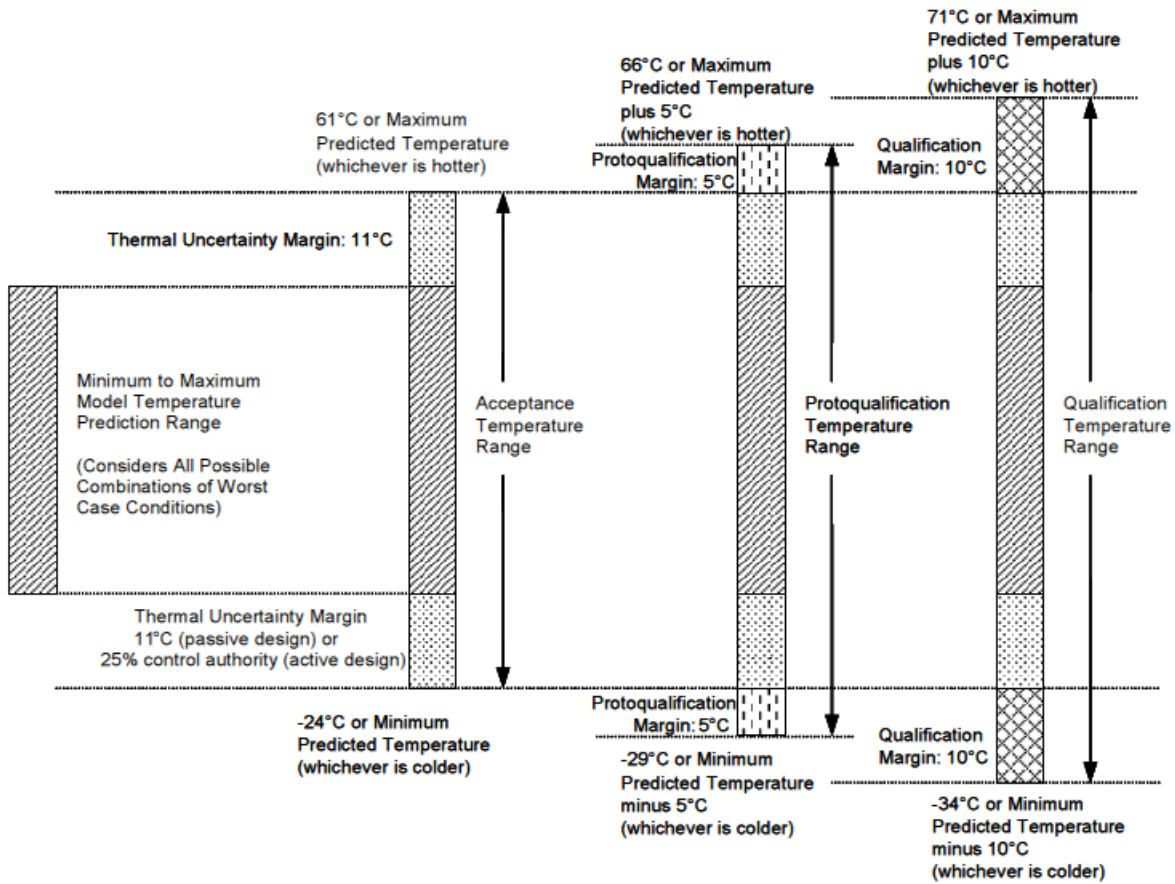

Note: figure is from SMC-S-016, Test Requirements for Launch, Upper-Stage and Space Vehicles, which is public-release, unlimited distribution.

Given the LSP Thermal role, the strategy of any given analysis can range from stacked worst case assumptions to bound a wide range of conditions to specific mission operations to determine an actual flight predicted response.

The increasingly competitive commercial launch industry has shifted the burden of thorough thermal analysis of the launch vehicle and mission specific scenarios to the NASA team, which, in turn, has increased the importance of guidelines such as this document and rigorous planning, execution, and review of the LSP internal analysis products.

Many of the analyses associated with launch vehicles are transient simulations, starting with either vehicle power-on of avionics or cryogenic loading of propellants while on the pad. This is because the launch vehicle rarely reaches a steady state condition once launch preparations commence. The sequences of vehicle events are critical to simulations, including items such as avionics power-on, ECS set points and

 National Aeronautics and Space Administration	NASA Passive Thermal Control Engineering Guidebook	Revision: 4.0
	Date: 9/25/2023	Page 200 of 202
	Distribution Restrictions: Publicly available	Security Classification: Unclassified

flow rates, propellant loading temperature and flow rate, pressurization of pressure vessels. It is not often that the specific launch site surroundings and climate diurnals are simulated, as vehicle designs are derived to be tolerant of any launch date and typically more than one launch site. Plus, there is economy in avoiding repetitive analyses of the same vehicle for each launch if all appropriate margins are maintained in a bounding scenario. The prelaunch simulations are typically run from a negative start time to mimic the minus count of a launch countdown, and typically end at T-0.

The ascent simulations are initialized with the T-0 temperatures from the prelaunch analysis. After launch, the launch vehicle analyses are configured to use multiple BUILDS to capture changing geometry (stage separations, payload fairing jettison). The ascent trajectory can be a bounding artificial profile devised to envelope as many types of missions as practical in the design and qualification phase, or more mission specific. Even in a mission specific analysis, there can be many trajectories to simulate in order to capture the worst cases across a launch period. For example, an interplanetary mission may have hundreds of possible flight paths over a calendar launch period and daily launch window. The LSP Thermal team has devised a method to down select large trajectory sets using a simplified multi-faceted geometric entity and using post processing of the heating data to make informed decisions on which launch days and times create worst case conditions.

The modeling of launch vehicle components and systems used by the LSP Thermal team is either constructed from provided mechanical drawings or obtained from the launch service provider. In either case, the modeling undergoes significant review before being used for any design qualification or flight performance decision making. The review process includes a full team peer review with inclusion of other engineering disciplines as warranted. Flight data is used for model validation when available. For thermal modeling used routinely for mission specific analyses, post flight reconstruction of the mission to generate as-flown thermal results is completed for comparison to vehicle telemetry. This helps the LSP Thermal team identify modeling issues, subtle flight observations that may not have resulted in any anomalous behavior, and/or any operational changes implemented by the launch service provider.

The LSP serves the science payload provider to ensure delivery to orbit within the payload thermal requirements. A significant segment of this service is the thermal simulation of the payload while mechanically attached to the launch vehicle, from payload fairing encapsulation to separation from the vehicle upper stage in orbit. The LSP team can facilitate early assessment of payload thermal environments via independent (e.g., without launch service contractor involvement) using its library of upper stage thermal models and flight experience across the commercial launch vehicle fleet. Additionally, the LSP team can perform “what if” scenarios that fall outside of the contractual commercial launch obligations. These efforts hinge upon the provision of a launch configured thermal representation of the payload. The LSP team looks for the following features in any payload thermal model:

- All deployable features in a stowed position for launch (particularly important when solar arrays cover heat rejection surfaces when stowed)
- Beginning of life thermo-optical properties
- Battery charging/discharging dissipation profiles
- Heat pipes (or similar) and their analytical configuration for their orientation in a 1g environment
- Power activation profiles during pre-launch operations
- Heater system enabling for pre-launch operations
- Reaction control system propellant line status (full or empty)
- Convection features as necessary

 National Aeronautics and Space Administration	NASA Passive Thermal Control Engineering Guidebook	Revision: 4.0
	Date: 9/25/2023	Page 201 of 202
	Distribution Restrictions: Publicly available	Security Classification: Unclassified

- Appropriate temperature requirements for the launch phase

The LSP Thermal team will review the provided payload thermal modeling as a gate to providing the modeling to the launch service contractor to ensure success in their contractual analysis requirements. The modeling format used across the current commercial launch vehicle fleet is Thermal Desktop™. The LSP Thermal team can assist in performing any format conversions necessary to result in a payload Thermal Desktop™ model. In addition, the LSP Thermal team will integrate the payload thermal model into its own launch vehicle upper stage thermal modeling as an independent path to successful thermal integration.

Through the integrated thermal modeling activities, interface requirements between the launch vehicle and the payload are verified and in some cases modified based upon the analytical results. Thus, the early interaction between the payload thermal team and the LSP thermal team is encouraged to minimize changes late in the launch integration cycle.

Another significant effort performed by the thermal discipline in LSP is the approval of launch vehicle component qualification and acceptance testing. In this role, the thermal engineer is expected to understand a component's thermal environment and thermal response within that environment; the component's manner and timing of function; the industry standard for testing of the component type; the thermal time constant of the component to determine proper thermal test timing. The review seeks adherence to industry guidelines (MIL-STD-1540, SMC-S-016, as examples) with respect to thermal levels that maintain recommended margin to worst case analytical predictions. Aside from these industry guidelines, the overriding engineering judgement often falls back on the Test Like You Fly (TLYF) foundation. In fact, the LSP tracks all exceptions to the TLYF philosophy in its engineering review process. Examples of TLYF parameters: component function at proper temperature, order of thermal testing relative to vibration and shock exposure, vacuum or ambient pressure during thermal testing.

The LSP thermal engineering review of a component qualification is built upon the foundation of an analytical determination of the design environment, followed by application of the guideline thermal margins to acceptance and qualification test levels, followed by review of the test procedures to ensure that they properly achieve the test levels, followed by review of the data from the execution of the acceptance and qualification tests. The review often necessitates collaboration with other discipline engineers and is always reviewed by the cognizant engineer, the Vehicle Systems Engineer, and the Chief Engineer before being approved for flight with a NASA payload, per the LSP engineering review process.

18.3 KSC Engineering Guidance

Thermal analysis within the broader Kennedy Space Center engineering community is frequently coupled with fluid analysis. KSC has implemented the following analysis standards applicable to thermal and fluid analysis:

- KSC-STD-Z-0015 Standard for Engineering Analysis
- KSC-STD-Z-0017 Standard for Thermal/Fluid Engineering Analysis

Both are available through the NASA Technical Standards website.

 National Aeronautics and Space Administration	NASA Passive Thermal Control Engineering Guidebook	Revision: 4.0
	Date: 9/25/2023	Page 202 of 202
	Distribution Restrictions: Publicly available	Security Classification: Unclassified

Unless otherwise directed, analysis models and other analysis products are to be stored in the Kennedy Design and Data Management System (KDDMS). Formal release of analysis products follows KDP-P-2718.