

NASA/TP–20230014975



International VLBI Service for Geodesy and Astrometry 2021+2022 Biennial Report

Kyla L. Armstrong, Dirk Behrend, and Karen D. Baver

November 2023

NASA STI Program ... in Profile

Since its founding, NASA has been dedicated to the advancement of aeronautics and space science. The NASA scientific and technical information (STI) program plays a key part in helping NASA maintain this important role.

The NASA STI program operates under the auspices of the Agency Chief Information Officer. It collects, organizes, provides for archiving, and disseminates NASA's STI. The NASA STI program provides access to the NTRS Registered and its public interface, the NASA Technical Reports Server, thus providing one of the largest collections of aeronautical and space science STI in the world. Results are published in both non-NASA channels and by NASA in the NASA STI Report Series, which includes the following report types:

- **TECHNICAL PUBLICATION.** Reports of completed research or a major significant phase of research that present the results of NASA Programs and include extensive data or theoretical analysis. Includes compilations of significant scientific and technical data and information deemed to be of continuing reference value. NASA counterpart of peer-reviewed formal professional papers but has less stringent limitations on manuscript length and extent of graphic presentations.
- **TECHNICAL MEMORANDUM.** Scientific and technical findings that are preliminary or of specialized interest, e.g., quick release reports, working papers, and bibliographies that contain minimal annotation. Does not contain extensive analysis.
- **CONTRACTOR REPORT.** Scientific and technical findings by NASA-sponsored contractors and grantees.
- **CONFERENCE PUBLICATION.** Collected papers from scientific and technical conferences, symposia, seminars, or other meetings sponsored or co-sponsored by NASA.
- **SPECIAL PUBLICATION.** Scientific, technical, or historical information from NASA programs, projects, and missions, often concerned with subjects having substantial public interest.
- **TECHNICAL TRANSLATION.** English-language translations of foreign scientific and technical material pertinent to NASA's mission.

Specialized services also include organizing and publishing research results, distributing specialized research announcements and feeds, providing information desk and personal search support, and enabling data exchange services.

For more information about the NASA STI program, see the following:

- Access the NASA STI program home page at <http://www.sti.nasa.gov>
- E-mail your question to help@sti.nasa.gov
- Phone the NASA STI Information Desk at 757-864-9658
- Write to:
NASA STI Information Desk
Mail Stop 148
NASA Langley Research Center
Hampton, VA 23681-2199

NASA/TP–20230014975



International VLBI Service for Geodesy and Astrometry 2021+2022 Biennial Report

Kyla L. Armstrong (ed.)
NVI, Inc., Greenbelt, MD

Dirk Behrend (ed.)
NVI, Inc., Greenbelt, MD

Karen D. Baver (ed.)
NVI, Inc., Greenbelt, MD

National Aeronautics and
Space Administration

Goddard Space Flight Center
Greenbelt, MD 20771

November 2023

Government Rights Notice

This work was authored by employees of NVI, Inc., under Contract No. 80GSFC22CA066 with the National Aeronautics and Space Administration and partly by employees of the Jet Propulsion Laboratory, California Institute of Technology under Contract No. 80NM0018D0004 with the National Aeronautics and Space Administration. The United States Government retains and the publisher, by accepting the article for publication, acknowledges that the United States Government retains a non-exclusive, paid-up, irrevocable, worldwide license to reproduce, prepare derivative works, distribute copies to the public, and perform publicly and display publicly, or allow others to do so, for United States Government purposes. All other rights are reserved by the copyright owner.

Trade names and trademarks are used in this report for identification only. Their usage does not constitute an official endorsement, either expressed or implied, by the National Aeronautics and Space Administration.

Level of Review: This material has been technically reviewed by technical management.

Available from

NASA STI Program
Mail Stop 148
NASA's Langley Research Center
Hampton, VA 23681-2199

National Technical Information Service
5285 Port Royal Road
Springfield, VA 22161
703-605-6000

Available in electronic form at <https://www.sti.nasa.gov> and <https://ntrs.nasa.gov>

Foreword

Since its creation in 1999, the International VLBI Service for Geodesy and Astrometry (IVS) has documented its progress and current status in the form of annual or biennial reports. The first sixteen years were recorded in the form of annual reports. Starting in 2015/2016 the cadence was changed to two years; hence, this Biennial Report marks eight years of using the two-yearly reporting scheme.

The general structure of the reporting has remained stable over the years: the individual components of the IVS contributed short reports describing their numerous activities, progress, and future plans. Without the continued input from the VLBI groups of the international geodetic and astrometric community, this publication could not be compiled and the IVS itself would not be able to flourish. So, once again many thanks to all IVS components who contributed to this Biennial Report.

Like all other IVS publications, the Biennial Report is published in electronic form only. The last IVS publication, for which also a printed version was created, was the Biennial Report for 2015+2016. All IVS publications (i.e., Annual/Biennial Reports, General Meeting Proceedings, and IVS Newsletter) are available online. The contents of this report appear on the IVS website at

<https://ivscc.gsfc.nasa.gov/publications/br2021+2022>

The contents of the report are organized as follows:

- The first seven sections hold the reports from the Coordinators (including the Chair) and the

reports from the IVS Permanent Components: Network Stations, Operation Centers, Correlators, Data Centers, Analysis Centers, and Technology Development Centers.

- The final section provides reference information about IVS. Following the current (May 24, 2019) version of the IVS Terms of Reference, a reference table is provided with links to the IVS Member and Affiliated organizations, the IVS Associate Members, and the IVS Permanent Components.

In its online location, the Biennial Report is part of the IVS website, which contains information concerning the IVS organization. For that, we consider it unnecessary to reproduce this information in the report itself. Hence, we would like to ask our readers to make use of the online tools to look up the most recent lists of IVS components, its member organizations as well as affiliated organizations, and Directing Board Members. The information can be found through the “About IVS” button, which is accessible from most IVS website pages. Useful links are also compiled in the closing section of this report.

During the report period, the IVS consisted of

- 34 Network Stations, acquiring high performance VLBI data,
- three Operation Centers, coordinating the activities of a network of Network Stations,
- seven Correlators, processing the acquired data, providing feedback to the stations and providing processed data to analysts,
- four Data Centers, distributing products to users and providing storage and archiving functions,
- 32 Analysis Centers, analyzing the data and producing the results and products,

- six Technology Development Centers, developing new VLBI technology,
 - an Office for Outreach and Communications, promoting knowledge about the VLBI technique, and
 - a Coordinating Center, coordinating daily and long-term activities.
- There were altogether
- 88 Permanent Components, representing 43 institutions in 22 countries, and
 - about 350 Associate Members.

Table of Contents

Foreword	v	“Quasar” VLBI Network Stations 2021–2022 Report	85
IVS Coordination	1	RAEGE Santa Maria Station 2021–2022 Report ..	88
IVS Chair’s Report	3	Shanghai Station Report for 2021–2022	94
Coordinating Center Report	5	Urumqi Station Status Report for 2021–2022	97
Analysis Coordinator Report	8	New Zealand VLBI Station Warkworth	100
Network Coordinator Report	11	Westford Antenna 2021+2022 Report	103
Technology Coordinator Report	17	Geodetic Observatory Wettzell: 20-m Radio Telescope and Twin Radio Telescopes	106
Office of Outreach and Communications Report ..	19	Yebe Observatory Report	111
Network Stations	21	Operation Centers	117
Argentinean–German Geodetic Observatory	23	CORE Operation Center 2021–2022 Report	119
Effelsberg Radio Observatory 2021–2022 Report ..	27	DACH Operation Center 2021–2022 Report	123
Fortaleza Station Report for 2021 and 2022	31	NEOS Operation Center	127
Goddard Geophysical and Astronomical Observatory	35	Correlators	129
Hartebeesthoek Radio Astronomy Observatory (HartRAO)	37	Bonn Correlator Report 2021–2022	131
AuScope VLBI Array and Hobart 26-m Antenna ..	42	MIT Haystack Observatory Correlator Report 2021–2022	134
Ishioka Geodetic Observing Station 2021–2022 Report	47	IAA Correlator Center Report 2021–2022	139
Status Report of Koganei 11-m VLBI Station for 2021–2022	52	Shanghai VLBI Correlator 2021–2022 Report ...	141
Kokee Park Geophysical Observatory	57	Tsukuba VLBI Correlator	145
Matera CGS VLBI Station 2021–2022 Report	60	Vienna Correlator Report 2021–2022	149
Medicina Station Status Report	63	Washington Correlator	154
McDonald Geodetic Observatory	65	Wettzell VLBI Correlator	156
VERA 2021 and 2022 Geodetic Activities	68	Data Centers	159
Noto Station Status Report	71	BKG Data Center	161
Ny-Ålesund Geodetic Observatory	73	CDDIS Data Center Report for 2021–2022	165
German Antarctic Receiving Station (GARS) O’Higgins	77	Italy INAF Data Center Report	169
Onsala Space Observatory – IVS Network Station Activities during 2021–2022	80	Paris Observatory (OPAR) Data Center	170
IVS 2021+2022 Biennial Report		Analysis Centers	173
		Analysis Center of Saint Petersburg University ..	175
		Geoscience Australia Analysis Center Report ...	177

Report for 2021–2022 from the Bordeaux IVS Analysis Center	179	Pulkovo Observatory (PUL) Analysis Center Report 2021–2022	251
BKG VLBI Analysis Center	185	Tsukuba VLBI Analysis Center	254
BKG/DGFI-TUM Combination Center	189	Universidad de Alicante VLBI Analysis Center (UAVAC) Report	257
Matera CGS VLBI Analysis Center	194	U.S. Naval Observatory VLBI Analysis Center ..	260
DGFI-TUM Analysis Center	196	USNO Analysis Center for Source Structure Report	263
ETHZ VLBI Analysis Center Report	200	Vienna Analysis Center Report 2021–2022	268
GFZ Analysis Center 2021–2022 Report	205	Technology Development Centers	273
GSFC VLBI Analysis Center Report	211	GSFC Technology Development Center	275
IAA VLBI Analysis Center Report	216	IAA Technology Development Center Report for 2021–2022	279
IGN Argentino Associate Analysis Center Report	218	Onsala Space Observatory – IVS Technology Development Center Activities during 2021–2022	283
National Geographic Institute of Spain Analysis Center Report	221	IGN Yebes Observatory Technology Develop- ment Center 2021–2022 Report	288
Italy INAF Analysis Center	224	IVS Information	295
KTU-GEOD Analysis Center Report	226	IVS Terms of Reference	297
Norwegian Mapping Authority Analysis Center Report	231	Links to Additional IVS Information	305
Service and Research at Paris Observatory (OPAR) Analysis Center	236		
Onsala Space Observatory – IVS Analysis Center Activities during 2021–2022	241		
PMD IVS Analysis Center Report	246		

IVS COORDINATION



IVS Chair's Report

Rüdiger Haas

The years 2021 and 2022 were rather special for the IVS. During 2021, the Covid-19 pandemic slowly faded out, and life returned more or less to normal in most countries. People began going back to their work places instead of working from home, and even international travel became slowly possible again. But the lessons that the IVS components learned during the pandemic, e.g. on how to operate VLBI stations and correlators remotely, are very valuable. The routines adopted, e.g. automated and unattended operations of VLBI stations, will also be of importance and will to some extent continue to be part of the everyday IVS operations in non-pandemic times.

Even though the pandemic slowly faded out during 2021 and 2022, most IVS meetings still were held virtually or in hybrid form. In March 2021, the 24th EVGA working meeting was held completely virtually. The same was true for the 11th IVS Technical Operations Workshop, held in May 2021. In October, the 2nd EU-VGOS workshop was held in hybrid form, with participants both on site in Vienna, Austria, and online. Also the initial plans were that the 2022 12th IVS GM could be held as a hybrid event with on-site participation in Helsinki, Finland, and online participation. But this became impossible, and it had to be changed completely to a virtual meeting in Cyberspace. The IVS VLBI Training school organized in connection with the 12th IVS GM was also held as an online event.

The Russian war of aggression against Ukraine began in February 2022 and caused a significant disruption

and change in the IVS operations. Because some countries do not allow research collaboration with Russia anymore, some VLBI stations no longer co-observe with Russian VLBI stations. These co-observing rules led to corresponding changes in the IVS Master Schedule that will continue until further notice.

The IVS Combination Center submitted the final IVS combined solution for the ITRF2020 combination. In total, 11 IVS Analysis Centers submitted individual solutions to the IVS Combination Center. Seven different VLBI software packages were used for these 11 contributions, see Figure 1.

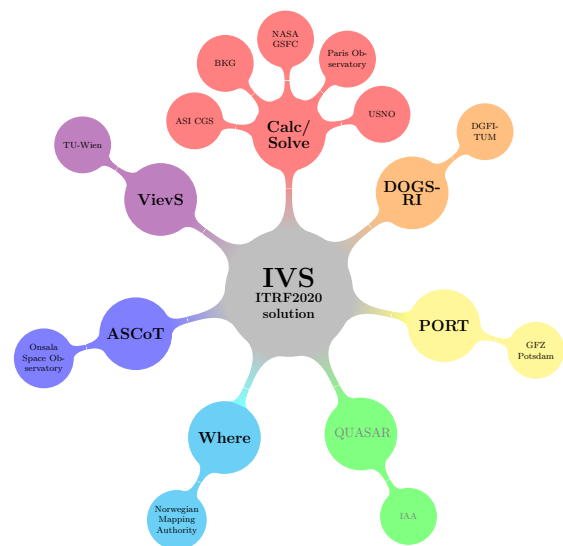

Fig. 1 Submissions to the IVS combined solution for the ITRF2020 combination, with analysis software used and names of the IVS Analysis Centers.

Chalmers University of Technology, Department of Space, Earth and Environment, Onsala Space Observatory

IVS Chair

IVS 2021+2022 Biennial Report

The evaluation of the new ITRF2020 showed that the SLR and VLBI scales are within 0.5 ppb for the period 1993.0–2013.75. But it was detected that the VLBI scale drifts away after 2013.75, a phenomenon that has not been completely understood and explained yet. A task force on the IVS scale drift, led by the IVS Analysis Coordinator John Gipson, was established to investigate the phenomenon.

VGOS evolved further during 2021–2022. In 2021 the VGOS operational series (VO) was observed every second week. Up to nine VGOS stations were involved: GGAO12M (Gs), ISHIOKA (Is), KOKEE12M (K2), MACGO12M (Mg), ONSA13NE (Oe), ONSA13SW (Ow), WESTFORD (Wf), RAE-GYEB (Yj), and WETTZ13S (Ws). In late 2021 the IVS accepted a proposal by BKG to establish an IVS correlator at the Geodetic Observatory Wettzell. With a new correlator, the expectations were to ramp up the VGOS observations. Starting in January 2022, the cadence of the VO series was thus changed to weekly observations. This worked fine in the beginning, but over time a backlog of VO sessions still accumulated at the correlators. The turnaround time for VO sessions became so long that stations did not get feedback anymore in a reasonable time. Thus, in November 2022 the OPC decided to change back to observing every second week in order to reduce the backlog. It is envisaged that this will be achieved soon and that the VO cadence can be changed again to weekly observations in the second half of 2023. Additionally, new stations joined the VO sessions in 2022. Both HOBART12m (Hb) in Australia and NYALE13N (Nn) on Svalbard joined VO sessions for the first time, and with success.

Several VGOS Research & Development (VR) sessions were observed in 2021 and 2022. These sessions are meant to test different technical and observational aspects in order to develop VGOS further.

Several VGOS Intensive series were also started in 2022, such as the VGOS-INT-S, VGOS-INT-G, and VGOS-INT-Y, additional to the already existing VGOS-INT-A/B/C. Also in 2022, a S/X legacy IVS-INT-00 was started, observing over midnight UT.

In general, the experience is that VGOS sessions are outperforming legacy S/X VLBI sessions concerning station position repeatability and baseline repeatability, as well as UT1-UTC precision and accuracy. But, primarily due to the limited geographic distribution of the station network, VGOS sessions perform

below legacy S/X VLBI sessions for polar motion and nutation.

A topic of increasing importance and concern is the frequency selection for VGOS. During the last two years, the IVS has experienced more and more disturbances at VLBI stations that are caused by an increased utilization of the radio spectrum by active services, both ground-based and space-based. This development is extremely worrying for the future use and operation of VGOS. The IVS was therefore active in giving input to the resolution “in support of the protection of geodetic radio astronomy against radio frequency interference” in 2021, presented to the IAU General Assembly 2022; in writing a support letter in 2021 for a “New IAU Center for the Protection of the Dark and Quiet Sky from Satellite Constellation Interference”, and in writing a support letter in 2022 for a proposed focus meeting on “The future of radio astronomy in an increasingly crowded spectrum” at the IAU General Assembly 2024.

One of our IVS network stations, Santa Maria, even had to face the establishment of a strong radar in close vicinity to the station in 2022. This radar saturates the Santa Maria VGOS receiver and makes it impossible for the station to observe the whole VGOS frequencies currently used in the VO series. It is unfortunately unclear how this problem can be solved at this time.

In the summer of 2022 the Auckland University of Technology decided to disinvest in the Warkworth Radio Astronomical Observatory, one of the important IVS stations in the southern hemisphere. Due to this development and the uncertainty involved, the IVS Network Coordinator, Stuart Weston from Warkworth Observatory, decided to resign from his duties for the IVS. I would like to thank Stuart very much for his service in this function during the past 2.5 years. The IVS sent a letter of protest to Auckland University of Technology and asked for the development of solutions to keep the observatory operational. Luckily it seems now that a solution could be found to keep the observatory alive and operational through moving the responsibility to a New Zealand ministry.

None of the IVS DB meetings during 2021 and 2022 could be held in person. All were online meetings. So I am looking forward to in-person meetings again in 2023. The next IVS DB meeting will be in connection to the EVGA 2023 working meeting, in combination with an IVS Retreat.

Coordinating Center Report

Dirk Behrend, Kyla Armstrong

Abstract This report summarizes the activities of the IVS Coordinating Center during the 2021 and 2022 calendar years and provides an outlook on activities planned for the next two years.

1 Coordinating Center Operation

The IVS Coordinating Center is based at the Goddard Space Flight Center and is operated by NEOS (National Earth Orientation Service), a joint effort for VLBI by the U.S. Naval Observatory and the NASA Goddard Space Flight Center.

The mission of the Coordinating Center is to provide communications and information for the IVS community and the greater scientific community and to coordinate the day-to-day and long-term activities of the IVS.

The Web server for the Coordinating Center is provided by Goddard. The address is

<https://ivscc.gsfc.nasa.gov>.

2 Activities during 2021 and 2022

During the period from January 2021 through December 2022, the Coordinating Center supported the following IVS activities:

NVI, Inc./NASA Goddard Space Flight Center

Coordinating Center

IVS 2021+2022 Biennial Report

- **Directing Board support:** Due to the COVID-19 pandemic, the Board did not hold any in-person meetings in 2021 and 2022. In its place shorter ersatz meetings from two to four hours long were organized via Zoom. Virtual Board meetings took place in March, July, and September of 2021 as well as January, April, and September of 2022. Directing Board meetings are expected to return to an in-person environment in 2023. Notes from each meeting were published on the IVS website.
- **Observing Program Committee (OPC):** Coordinated meetings of the OPC to monitor the observing program, review problems and issues, and discuss changes.
- **Master Schedules for 2021 and 2022:** Generated and maintained the Master Observing Schedules for 2021 and 2022. Coordinated VLBI resources for observing time, correlator usage, and disk modules. Coordinated the usage of Mark 5 and Mark 6 systems at IVS stations and efficient deployment of disk modules.
- **2022 and 2023 Master Schedules:** Generated the proposed Master Schedules for 2022 and 2023 and received approval from the Observing Program Committee.
- **VGOS:** Supported the activities for establishing the VLBI Global Observing System (VGOS) through participation in the VGOS Technical Committee (VTC) and organizing meetings of the VGOS Operations and Resources group and the VGOS Correlators.
- **Communications support:** Maintained the Web pages and e-mail lists. The IVS mailing lists are part of the NASA-wide Agency Mailing List Service (AMLS). In May 2021, AMLS was migrated to a new host organization as well as

upgraded to the newest list manager. For the migration, all membership information and list options were rolled over from the old to the new lists. The mailing list names did not change. All subscription requests are handled via e-mail either directly to the list or to the list managers. The Coordinating Center curates and updates the status of each list so that it reflects the most recent version of the subscription list. The general public (i.e., non-NASA users) can no longer access the Web interface, including the list archives. The Coordinating Center also maintained the 24-hour and Intensive session Web pages including the data acquisition, correlation, analysis, and performance summaries.

- **Publications:** Published the 2019+2020 Biennial Report in October 2021. Published six editions of the IVS Newsletter in the months of April, August, and December of 2021 and 2022. Published the 2022 General Meeting Proceedings in late 2022. All publications are available in electronic form only and can be found at <https://ivscc.gsfc.nasa.gov/publications/>.



Fig. 1 Logo of the 11th IVS Technical Operations Workshop.

- **Meetings:** Coordinated, with Local Committees, the 11th IVS Technical Operations Workshop, held virtually in May 2021, and the 12th IVS General Meeting, held virtually in March 2022. The GM was originally slated to be held in Helsinki, Finland, from March 27–April 1, 2022, but it had to be moved to cyberspace because of the pandemic. Chaired the Program Committees of both meetings.



Fig. 2 Logo of the 12th General Meeting Proceedings, held in cyberspace in March 2022.

3 Staff

The staff of the Coordinating Center is drawn from individuals who work at Goddard. The staff and their responsibilities during 2021–2022 are listed in Table 1.

Table 1 IVS Coordinating Center staff.

Name	Title	Responsibilities
Dirk Behrend	Director	Web site and e-mail system maintenance, Directing Board support, meetings, publications, session Web page monitoring
Cynthia Thomas	Operation Manager	Master Schedules (current year), resource management and monitoring, meeting and travel support, special sessions
Mario Bérubé	Offsite Consultant	Session processing scripts, Data Center support
Karen Baver	General Programmer and Editor	Publication processing programs, LaTeX support and editing, Data Center support
Kyla Armstrong	Data Technician and Editor	Publications support and Web site support

4 Plans for 2023 and 2024

The Coordinating Center plans for 2023 and 2024 include the following:

- Maintain the IVS website and mailing lists. Modernize the IVS website.
- Publish the 2021+2022 Biennial Report (this volume).
- Coordinate the 12th IVS Technical Operations Workshop together with MIT Haystack Observa-

- tory, to be held in-person for the first time since 2019, in May 2023.
- Coordinate, with the local committee, the 13th IVS General Meeting and 25th IVS Anniversary event, both to be held in Tsukuba, Japan in March 2024.
 - Maintain the new ingest software at the Data Centers and work on a clean-up of the data holdings. Ensure that the mirroring among the Data Centers works properly.
 - Publish the Proceedings volume of the 13th IVS General Meeting.
 - Support Directing Board meetings in 2023 and 2024.
 - Coordinate the 2023 and 2024 Master Observing Schedules and IVS resources.
 - Publish Newsletter issues in April, August, and December of 2023 and 2024.
 - Support the VGOS activities within the VTC, the VGOS Operations and Resources group, and the VGOS Correlators.

Analysis Coordinator Report

John Gipson

Abstract I discuss some notable work over the prior two years.

1 IVS Contribution to ITRF2020

In the beginning of 2021 the IVS submitted its contribution for ITRF2020. Eleven Analysis Centers (ACs) using six different software packages contributed to this effort. Each AC submitted SINEX files containing the unconstrained normal equations for station position and source coordinates. These files were vetted by the IVS Combination Center. For each session the IVS Combination Center combined the files from the different ACs. For more details see Hellmers et al.

Table 1 Institute and the software used.

Institute	Software
ASI CGS	Calc/Solve
BKG	Calc/Solve
DGFI-TUM	DOGS-RI
GFZ-Potsdam	PORT
IAA	Quasar
GSFC	Calc/Solve
NMA	Where
Paris Observatory	Calc/Solve
Onsala	ASCOT
TU Wien	VieVS
USNO	Calc/Solve

NVI, Inc./NASA Goddard Space Flight Center

IVS Analysis Coordinator

IVS 2021+2022 Biennial Report

Compared to ITRF2014, there were four significant model changes:

1. A new high-frequency EOP model,
2. A new mean pole tide model,
3. Incorporation of Galactic aberration,
4. Use of models for gravitational deformation of antennas.

The first two models are used by all of the geodetic techniques. The last two are specific to VLBI. It is interesting to note that these affect the extreme ends of the signal path. Galactic aberration models reduce errors in estimates of source position, while gravitational deformation models reduce errors in estimates of station position.

ITRF2020 was also notable in that it was the first ITRF which used data from VGOS antennas.

1.1 Investigation of Preliminary ITRF2020

In the spring of 2022 Zuheir Altamimi produced a preliminary version called ITRF2020P. Several IVS Analysis Centers participated in investigating different aspects of this. Table 2 below summarizes the contributions.

The general conclusion was that ITRF2020P was much better than ITRF2014, especially for stations that had little data for ITRF2014. In particular, the Post-Seismic Deformation (PSD) models fit the data better, and the velocities were better.

Zuheir Altamimi noticed that there appears to be a drift in the VLBI scale with respect to ITRF2020 after around 2014. Many IVS Analysis Centers confirmed this scale drift. However, some ACs reported that if an

Table 2 Contributions to ITRF2020P.

Person	Institute	Contribution
John Gipson/ IVS Analysis Coordinator	NVI, Inc./NASA	Summary
Minghui Xu	Aalto University Metsähovi Radio Observatory	Ties
Sadegh Modiri Hendrik Hellmers Sabine Bachmann Daniela Thaller	BKG IVS Combination Center	Scale Scale Scale Scale
Matthias Glomsda Kyriakos Balidakis Henryk Dobsław	DGFI-TUM GFZ German Research Centre for Geosciences	EOP Scale
Tobias Nilsson	Lantmäteriet	Comparison of ITRF2014 with ITRF2020/ Scale
Hana Krásná	TU Wien	Scale

a priori reference frame was derived from VLBI, the scale drift was absent. This area is still under investigation.

2 New Gravitational Deformation Models

Since the IVS contribution to ITRF2020, several more antennas have been surveyed to determine gravitational deformation models. A model for Ny-Ålesund became available in late 2020, too late for inclusion in ITRF2020. Because Ny-Ålesund and Kokee Park are structurally identical, the gravitational deformation model applies to both. Other antennas which were surveyed and whose models are now available are 1) the Onsala twins, 2) Wettzell 20-m, and 3) the Wettzell twins. The IVS thanks the institutions which host these antennas for making the effort to perform the surveys and reduce a source of systematic error.

3 Operational Transition to ITRF2020

The IVS will transition to using ITRF2020 for the a priori in the first quarter of 2023.

- For this purpose, the IVS Analysis Centers will use the Post-Seismic Deformation models from ITRF2020.
- Because of the issues with VLBI scale with respect to ITRF2020, and also because there is much more data available for VGOS stations, the a priori reference frame will be derived from VLBI data only.
- The IVS will also use the expanded list of stations with a gravitational deformation model.

All of the IVS Analysis Centers are supposed to submit solutions to the IVS Combination Center by February 28, 2023. The Combination Center will vet the solutions and provide feedback to the ACs. By the end of March, the IVS Combination Center will produce a new combined solution. Henceforth all of the ACs are expected to use the new models.

4 New S/X Intensives

In the last two years two Intensive series have been scheduled on an R&D basis. The ‘midnight Intensives’ involve the Kokee–Wettzell baseline, currently run two days per week, and are centered around 00:00 UT. An advantage of these Intensives is that you do not need to do any interpolation to compare results with EOP from other techniques or with EOP time series such as C04.

The Southern Intensives run on Monday at 06:30 UT and use the Hobart–HartRAO baseline. These are unique in that they use only Southern Hemisphere stations. See Böhm et al.

5 VGOS Intensives

The last four years have seen an increase in the cadence of both 24-hour and Intensive VGOS sessions. The Intensive VGOS sessions are particularly interesting because in principle the turnaround time for observing, correlation, and analysis can be less than 24 hours. Below is a list of the current VGOS Intensives.

The VGOS-INT-A series uses the VGOS antennas at Kokee and Wettzell and is scheduled on the same days and at the same time as the S/X Intensives. This allows a direct comparison of the estimated UT1. Comparison with the R1 sessions and the R4 sessions, as well as with external series, indicates that the

Table 3 Intensive sessions, their baselines, and their scheduled times.

Intensive	Baseline	Time
VGOS-INT-A	K2-Ws	Mon-Fri @ 18:30-19:30
VGOS-INT-B	Is-Oe-Ow	Sat-Sun @ 07:00-08:00
VGOS-INT-C	Is-Oe-Ow	Sat-Sun @ 08:45-09:45
VGOS-INT-S	Mg-Ws	Tue @ 19:45-20:45
VGOS-INT-Y	Gs-Sa-Yj	Tue @ 14:00-15:00

VGOS Intensives perform better than the S/X Intensives. These results have not been published.

The VGOS-INT-B and VGOS-INT-C Intensives use the Ishioka–Onsala baseline. These two series differ in the selection of the sources. See Haas et al. for a description of the VGOS-INT-B and VGOS-INT-C Intensives. The scatter of the difference in the UT1 estimates from that of C04 is comparable to the S/X Intensives. For further information see Haas et al.

The VGOS-INT-S and VGOS-INT-Y series were designed to study the effects of using shorter baselines. The thought here is that because the baseline is shorter, the area of mutual visibility will be larger than for the longer baselines. This might allow the selection of better sources. Results from these sessions are being written up for publication.

6 IVS Analysis Workshops

During 2021–2022, there were four Analysis Workshops. Workshops were held each year in the spring/early summer and in the fall. The spring/early summer workshops were held in conjunction with the 2021 EVGA Working Meeting and the 2022 IVS General Meeting. All of the workshops were held virtually using Zoom. With the return to normalcy, the next IVS Workshop is scheduled to be held in person as a splinter meeting at the 2023 EVGA Working Meeting.

Several concrete recommendations came out of these workshops. Here this list mentions a few.

1. Claudia Flohrer of BKG proposed a new format for EOP files which was discussed and accepted. This new format provides additional information about the EOP solution—e.g., what constraints were implemented. The IVS Combination Center and the

USNO Earth Orientation Center are currently accepting files in both formats.

2. Chris Dieck of USNO headed an ad hoc working group that specified a new format for the master schedules and a new convention for the session names. The previous format for the master schedule was designed over 30 years ago when there were not as many sessions. With the possibility of having many Intensive sessions per day, a new format was required.
3. It was proposed and agreed upon to have Principal Investigators (PIs) for each IVS session type. This has always been the case informally, but this agreement formalizes this relation. The PIs have ultimate responsibility for each session type. This includes things such as the observing strategy and choice of sources. The PIs are also responsible for communication with the correlators about how to correlate the data.

References

1. S. Böhm, J. Böhm, J. Gruber, L. Kern, J. McCallum, L. McCallum, T. McCarthy, J. Quick, M. Schartner. “Probing a southern hemisphere VLBI Intensive baseline configuration for UT1 determination”, In *Earth, Planets and Space*, 74, 118 (2022). DOI:10.1186/s40623-022-01671-w.
2. R. Haas, E. Varenus, P.-K. Diamantidis, S. Matsumotu, M. Schartner, T. Nilsson. “VGOS Intensives Ishioka-Onsala”, In: *Proceedings of the EGU General Assembly 2021* (2021), DOI:10.5194/egusphere-egu21-12916.
3. H. Hellmers, S. Modiri, S. Bachmann, D. Thaller, M. Bloßfeld, M. Seitz, J. Gipson. “Combined IVS Contribution to the ITRF2020”, In: *International Association of Geodesy Symposia*. Springer, Berlin, Heidelberg (2022). https://doi.org/10.1007/1345_2022_170.

Network Coordinator Report

Mario Bérubé¹, Stuart Weston², Alexander Neidhardt³

Abstract This report includes an assessment of the IVS network performance in terms of lost observing time for calendar years 2021 and 2022. The observing losses were 19.0% in 2021 and 16.7% for 2022. The 2021 statistics are similar to the prior 2019–2020 period, but 2022 shows significant improvement. Various tables are presented to break down the relative performance of the network and the incidence of problems with various sub-systems. At the end of 2022, Stuart Weston discontinued to be the IVS Network Coordinator and he was succeeded in this role by Alexander Neidhardt.

1 Introduction

As described in more detail in the network station report for Warkworth Observatory, Auckland University of Technology divested itself of the station effective mid-December 2022. While a new funding mechanism was being negotiated, the then IVS Network Coordinator Stuart Weston decided to step down from his position by the end of 2022—also given the uncertain future outlook. The IVS Directing Board elected Alexander Neidhardt to become Stuart’s successor, starting his tenure in January 2023.

1. NVI, Inc./NASA Goddard Space Flight Center

2. Institute for Radio Astronomy and Space Research, Auckland University of Technology

3. Forschungseinrichtung Satellitengeodäsie (FESG), Technische Universität München

IVS Network Coordinator

IVS 2021+2022 Biennial Report

In this report, we provide an assessment of the network performance of the IVS stations broken down by calendar year. We follow the same methodology that was used in previous reports. One major difference, however, is the inclusion of the VGOS stations, as a fledgling but growing VGOS network contributed to the IVS products over the entire reporting period.

2 Observing Network

The network consists of 45 IVS Network Stations as official member components of the IVS as well as several cooperating sites that contribute to the IVS observing program, in particular the ten VLBA stations and four NASA DSN stations. The VGOS network has been included in the global statistics, since it now contributes to the creation of IVS products. As a consequence, there are no individual statistics for the VGOS and legacy S/X networks. In 2021, Fortaleza was initially included in 100 sessions but could not observe; it was removed from any statistics.

3 Network Performance

The network performance is expressed in terms of lost observing time, or data loss. This is straightforward in cases where the loss occurred because operations were interrupted or missed. But, in other cases, it is more complicated to calculate. To handle this, a non-observing time loss is typically converted into an equivalent lost observing time by expressing it as an approximate equivalent number of recorded bits lost.

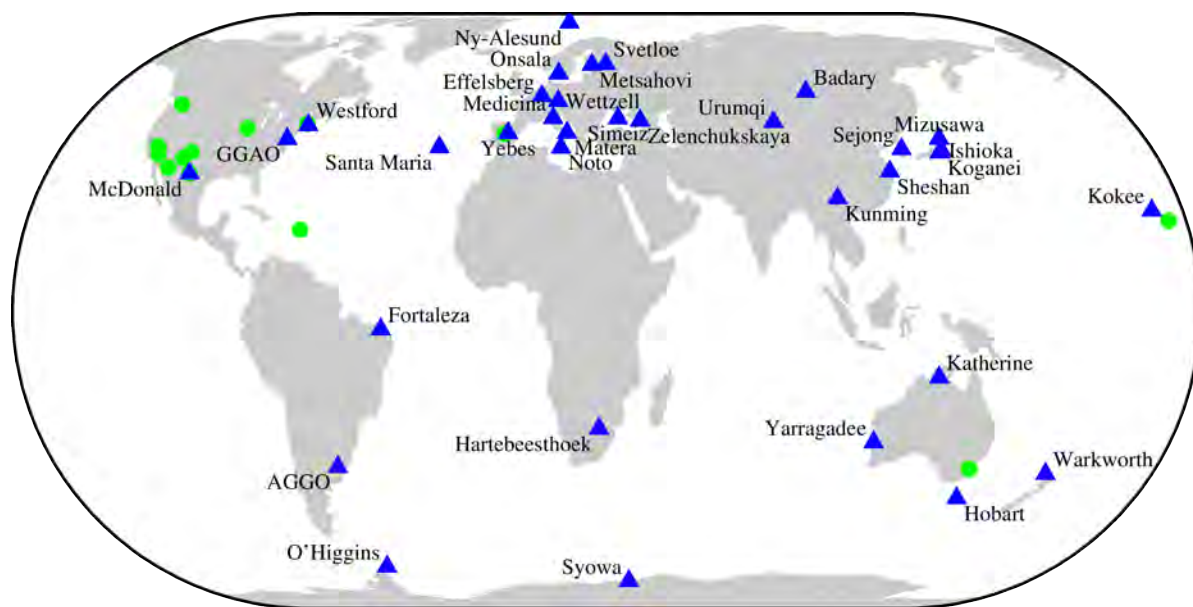

Fig. 1: Distribution plot of the VLBI stations that contributed to the 2021–2022 IVS Master Schedules. The IVS Network Stations are shown as blue triangles (▲), while the Cooperating Stations are indicated by green dots (●).

As an example, a warm receiver will greatly reduce the sensitivity of a telescope. The resulting performance will be in some sense equivalent to the station having a cold receiver but observing for (typically) only one third of the nominal time and therefore recording the equivalent of only one-third of the expected bits. In a similar fashion, poor pointing can be converted into an equivalent lost sensitivity and then equivalent fraction of lost bits. Poor recordings are simply expressed as the fraction of total recorded bits lost.

Using correlator reports, an attempt was made to determine how much observing time was lost at each station and why. This was not always straightforward to do. Sometimes the correlator notes do not indicate that a station had a particular problem, while the quality code summary indicates a significant loss. Reconstructing which station or stations had problems—and why—in these circumstances does not always yield accurate results. Another problem was that it is hard to determine how much RFI affected the data, unless one or more channels were removed and that eliminated the problem. It can also be difficult to distinguish between BBC and RFI problems. For individual station days, the results should probably not be assumed to be accurate at better than the 5% level.

The results here should not be viewed as an absolute evaluation of the quality of each station's per-

formance. As mentioned above, the results themselves are only approximate. In addition, some problems such as weather and power failures are beyond the control of the station. Instead the results should be viewed in aggregate as an overall evaluation of what percentage of the observing time the network is collecting data successfully. Development of the overall result is organized around individual station performance, but the results for individual stations do not necessarily reflect the quality of operations at that station.

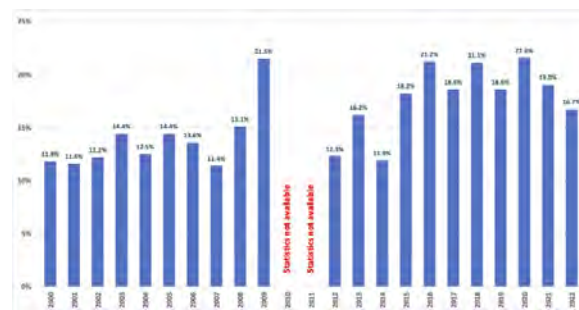

Fig. 2: The historical data loss since 2000.

The overall network performance for 2021–2022 has improved when compared to the 2019–2020 period, as can be seen in Figure 2. The results of this

report are based on correlator and analysis reports for 456 correlated 24-hour sessions. The examined data set includes 4,028,539 observations. Approximately 74% of these observations were successfully correlated, and over 64% were used in the final IVS Analysis Reports for 2021 and 2022. Sessions correlated at the VLBA were also included when data analysis reports provided relevant information about reasons for data loss.

Table 1 summarizes the data set that was used for the 2021–2022 network performance report. The data in parentheses represent the station days processed by the correlators. The table also includes the percentages of successfully correlated and used observations that are comparable to the previous period. The average number of stations per session is 9.7 in 2021 and 9.5 in 2022, compared to 9.6 in 2020.

Table 1: Data sets used for the 2021–2022 network performance report.

Year	Sessions	Station days	Observations	Correlated	Used
2021	219	2,135 (1,968)	1,867,875	75%	61%
2022	237	2,247 (2,114)	2,160,664	74%	66%

More than 405 station days (19.0%) were lost in 2021, and 375 (16.7%) days were lost in 2022. The observing time loss for 2021–2022 has been affected by stations that did not observe and were not removed from the master schedule. This loss accounted for 167 station days, or 7.8%, in 2021 and 133 station days, or 5.9%, in 2022.

Figures 3 and 4 are showing detailed data loss by sub-system for 2021 and 2022. As shown in Figure 2, the 2021 network lost over 19.0% of its data, a slight improvement over 2020. With a network loss of 16.7%, 2022 was also showing improvement over the previous year.

To analyze this global performance, the network has been analyzed by groups: Figure 5 shows 2021, and Figure 6 shows 2022. Tables 2 and 3 provide information on the three groups: **Big Large N** (stations that were used in 55 or more sessions), **Large N** (stations that were used in 24 or more sessions), and **Small N** (stations that were used in 23 or fewer sessions). The distinction between these groups was made on the assumption that results will be more meaningful for the stations with more sessions. The **Big Large N** group

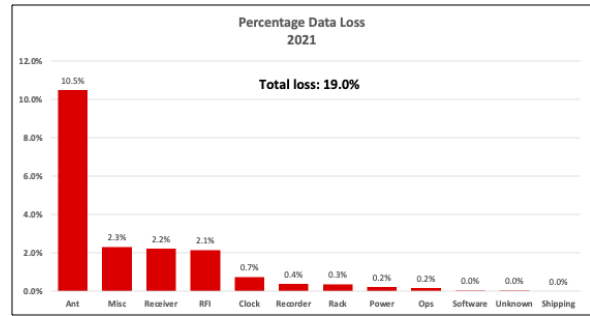

Fig. 3: Percentage of data loss for each sub-system in 2021.

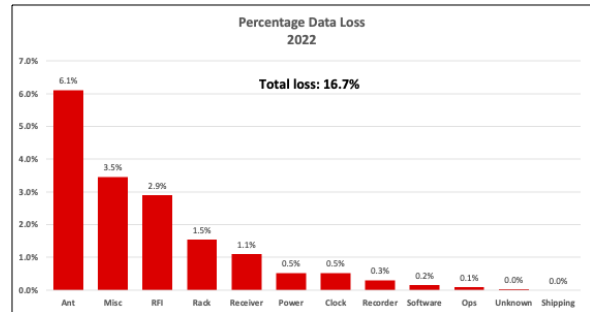

Fig. 4: Percentage of data loss for each sub-system in 2022.

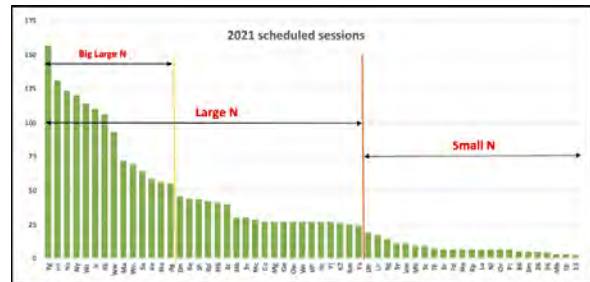

Fig. 5: The number of 24-hour sessions correlated in 2021.

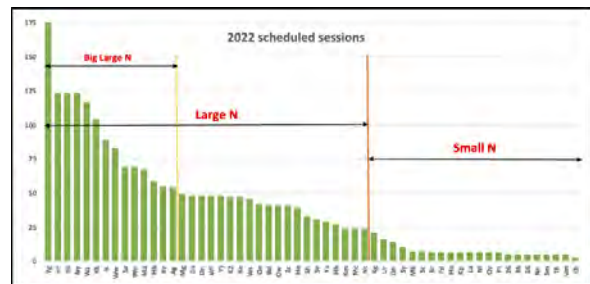

Fig. 6: The number of 24-hour sessions correlated in 2022.

is a subset of **Large N** and is used to show the performance of the busiest IVS stations. The **Big Large N**

Table 2: Group analysis for 2021.

Category	Number stations	Station-days	Average	Median	>92%	<70%
Big Large N (>55)	14	1328	22.6%	20.5%	6	9
Large N (≥ 24)	34	1963	19.4%	10.5%	11	26
Small N (<24)	23	172	18.6%	16.8%	10	18
Full network	57	2135	19.0%	11.0%	21	44

Table 3: Group analysis for 2022.

Category	Number stations	Station-days	Average	Median	>92%	<70%
Big Large N (>55)	14	1310	12.2%	8.2%	7	13
Large N (≥ 24)	34	2087	11.9%	9.6%	13	31
Small N (<24)	22	160	19.5%	8.1%	11	17
Full network	56	2247	16.7%	9.6%	24	48

Table 4: Percentages of data loss by sub-system. Percentages for 2010 and 2011 were not calculated.

Sub-System	2022	2021	2020	2019	2018	2017	2016	2015	2014	2013	2012	2009	2008	2007	2006	2005	2004	2003
Antenna	6.1	10.5	6.4	2.5	5.2	3.6	9.2	3.6	1.8	6.4	2.2	6.3	2.9	3.9	2.6	3.5	4.1	2.6
Miscellaneous	3.5	2.3	7.1	5.1	8.6	6.5	3.3	4.7	4.2	1.5	0.8	3.3	1.9	0.9	2.4	1.2	1.0	0.9
RFI	2.9	2.1	1.5	1.5	1.8	2.3	2.3	1.6	1.6	1.0	1.5	1.3	2.2	1.2	1.6	0.9	0.6	1.3
Rack	1.5	0.3	0.9	1.1	0.9	0.9	0.6	2.3	1.4	3.2	2.7	1.4	1.3	1.3	2.2	0.7	0.9	0.7
Receiver	1.1	2.2	3.5	4.7	2.8	1.5	0.6	1.8	1.7	1.2	1.4	4.0	2.1	1.7	2.8	3.5	2.3	3.6
Power	0.5	0.2	0.2	0.3	0.2	0.9	0.4	0.2	0.0	0.3								
Clock	0.5	0.7	0.1	1.2	0.0	0.5	2.3	0.2	0.0	0.6	0.2	0.4	0.1	0.0	0.7	2.1	0.1	0.5
Recorder	0.3	0.4	0.6	0.5	0.5	0.5	0.5	1.2	0.5	0.5	0.7	0.6	0.6	0.5	0.4	1.3	1.4	1.6
Software	0.2	0.0	0.1	0.1	0.0	0.1	0.1	0.1	0.0	0.2	0.0	0.0	0.0	0.0	0.0	0.1	0.0	0.0
Operations	0.1	0.2	1.0	0.6	0.6	0.6	0.5	1.1	0.5	0.4	0.2	0.3	0.3	0.0	0.3	0.7	0.8	0.5
Unknown	0.0	0.0	0.2	0.7	0.5	0.9	1.0	1.1	0.2	0.9	1.7	3.1	2.7	1.7	0.5	0.5	1.3	1.8
Shipping	0.0	0.0	0.1	0.3	0.3	0.4	0.3	0.2	0.0	0.1	0.4	0.9	0.8	0.1	0.0	0.0	0.2	0.9

groups in Tables 2 and 3 are showing higher than expected averages, even though many stations have delivered more than 70% and 92% of their data. This is mainly due to few stations being down for many days.

Table 4 is providing a detailed breakdown of data loss by sub-system or categories since 2003. These categories rather broad and require some explanation, which is given below.

Antenna This category includes all antenna problems, including mis-pointing, antenna control computer failures, non-operation due to wind through 2013, and mechanical breakdowns of the antenna. It also includes scheduled antenna maintenance. Wind stows have been moved to Miscellaneous starting in 2014.

Clock This category includes situations in which correlation was impossible because the clock offset either was not provided or was wrong, leading to “no fringes.” Maser problems and coherence problems that could be attributed to the Maser are

also included in this category. Phase instabilities reported for Kokee are included in this category. DBBC clock errors are included in this category.

Miscellaneous This category includes problems that do not fit into other categories, mostly problems beyond the control of the stations, such as power (only prior to 2012), (non-wind) weather through 2013, wind stows (moved here from the Antenna category starting in 2014), cables, scheduling conflicts at the stations, and errors in the observing schedules provided by the Operation Centers. For 2006 and 2007, this category also includes errors due to tape operations at the stations that were forced to use tape because either they did not have a disk recording system or they did not have enough media. All tape operations have since ceased. This category is dominated by weather and scheduling conflict issues.

Operations This category includes all operational errors, such as DRUDG-ing the wrong schedule, starting late because of shift problems, operator (as

opposed to equipment) problems changing recording media, and other problems.

Power This category includes data lost due to power failures at the sites. Prior to 2012, losses due to power failures were included in the Miscellaneous category.

Rack This category includes all failures that could be attributed to the rack (DAS), including the formatter and BBCs. There is some difficulty in distinguishing BBC and RFI problems in the correlator reports, so some losses are probably mis-assigned between the Rack category and the RFI category.

Receiver This category includes all problems related to the receiver, including outright failure, loss of sensitivity because the cryogenics failed, design problems that impact the sensitivity, LO failure, and loss of coherence that was due to LO problems. In addition, for lack of a more clearly accurate choice, loss of sensitivity due to upper X-band Tsys and roll-off problems are assigned to this category.

Recorder This category includes problems associated with data recording systems. Starting with 2006, no problems associated with tape operations are included in this category.

RFI This category includes all losses directly attributable to interference, including all cases of amplitude variations in individual channels, particularly at S-band. There is some difficulty in distinguishing BBC and RFI problems in the correlator reports, so some losses are probably mis-assigned between the Rack category and the RFI category.

Shipping This category includes all observing time lost because the media were lost in shipping or held up in customs or because problems with electronic transfer prevented the data from being correlated with the rest of the session's data.

Software This category includes all instances of software problems causing observing time to be lost. This includes crashes of the Field System, crashes of the local station software, and errors in files generated by DRUDG.

Unknown This category is a special category for cases where the correlator did not state the cause of the loss and it was not possible to determine the cause with a reasonable amount of effort.

An assessment of each station's performance is not provided in this report. While individual station information was presented in some of the previous

years, this practice seemed to be counter-productive. Although many caveats were provided to discourage people from assigning too much significance to the results, there was feedback that suggested that the results were being over-interpreted. Additionally, some stations reported that their funding could be placed in jeopardy if their performance appeared bad, even if it was for reasons beyond their control. Last and not least, there seemed to be some interest in attempting to "game" the analysis methods to apparently improve individual station results. Consequently, only summary results have been presented here.

Some detailed comments on the most significant issues for the 2021–2022 data loss are given below.

- Once again, the two largest sources of data loss for 2021–2022 are Antenna and Miscellaneous. The Antenna sub-system loss is mainly due to repairs/maintenance at antennas that took more time than expected. The high values of Miscellaneous are highly affected by stations having other commitments and bad weather. Many hours were lost by antennas being stowed due to high winds or thunderstorms.
- The Receiver sub-system data loss is mainly due to a few stations observing a total of 52 station days with warm receivers.
- Operator performance is very good with less than 0.2% of data loss.
- RFI due to commercial systems continues to be an important factor of data loss for S/X stations. The impact on data loss for VGOS stations is minimal due to higher number of channels.

4 Summary and Outlook

Estimating station data losses could be subjective and some times approximative, but this is a useful tool for evaluating the health of the IVS network over the years. A station yielding over 80% of data is considered very good, and the statistics of the Large N group show that many stations have been doing well in 2021–2022.

Alexander Neidhardt will start his activities as IVS Network Coordinator in 2023. His planned work will include the following items:

- update the static network information;

-
- provide more dynamic feedback to the IVS Directing Board and the IVS Network Stations (using web services);
 - contribute to ad hoc working groups on frequencies including fixed observation frequencies for VGOS;
 - discuss better feedback structures in the project group on “IVS Success Analysis and Station Feedback.”

Technology Coordinator Report

Gino Tuccari

Abstract The main activities of the IVS Technology Coordinator in the period 2021–2022 are summarized. The main parts were related to the organization and support of VTC teleconferences, technical support of IVS stations, maintaining the VGOS Equipment Tables for improving technical compatibility, and communication with the EVN. This period was greatly affected by the Covid-19 pandemic restriction, and this had an effect on the missing in-person visits, which otherwise could have been done.

1 VTC Activities

In 2021–2022, organizing teleconferences and supporting the VGOS Technical Committee (VTC) activities were a large part of the Technology Coordinator activities. Due to the pandemic, virtual conferences were the only way many colleagues working from home could participate.

Monthly Zoom teleconferences have seen a large number of participants interested in giving a contribution based on their particular field of expertise.

The two most prominent topics presented in the agenda were related to the two working sub-groups already defined for:

a) the study of shorter integration periods (proposer and sub-group leader B. Petrachenko), with a number of RD observation sessions; additionally (proposed by H. Hase and actively supported by B. Petrachenko),

starting from the need to get protected from RFI, frequency slots in the full VGOS band have been evaluated for possible new observing frequency schemes.

b) the effects of source structure and a possible process for correction (sub-group leader P. Charlot).

At the last VTC meeting in 2022 a complete report of the activities by the two sub-group coordinators was given. These activities will continue in 2023, but those are expected to have an impact on the observations and the data process.

A third sub-group which will take care of the RFI mitigation efforts from several IVS groups was established (under the leadership of L. Hilliard). Its activity is expected to provide shared solutions to face the increasing problem of observing in RFI environments, particularly in the lowest part of the VGOS spectrum.

Finally, antenna calibration efforts were spent (under the support of E. Varenius) in order to assure that any VGOS station would attend to the knowledge and tools for maintaining antenna calibration data.

2 VGOS Equipment Tables and Technology Coordinator Web Pages

The VGOS tables are maintained with detailed information about relevant equipment of existing VGOS stations and those under construction. This is felt to be useful for promoting compatibility within the IVS network and as a guide for new and upcoming stations.

This data was placed in dedicated Technology Coordinator web pages (<https://www.ivs-technology-coordinator.info>) where additional information related to the VTC activities are even reported.

INAF-Istituto di Radioastronomia and Max-Planck-Institut für Radioastronomie

IVS Technology Coordinator

IVS 2021+2022 Biennial Report

Registered users can download the recorded VTC teleconferences at: <https://www.ivs-technology-coordinator.info/recordings/>.

3 Firmware Development for the Network

The DBBC3 is largely diffused in the IVS network, as in EVN. Several stations are demanding the possibility of performing the polarization conversion from linear to circular within the backend system. The VGOS broadband feeds are linearly polarized, and the conversion has to be performed using a quadrature hybrid inside the dewar or at a later stage during the data process. An alternative solution can be offered by providing the conversion inside the backend, and this is possible in the DBBC3 with a dedicated firmware. A project was then defined to be carried out by the DBBC team in order to provide this possibility to stations requiring this solution.

4 Liaison with the EVN

Periodic meetings were performed on a regular basis with EVN Technical and Operations Group (TOG) Chairman Uwe Bach in order to maintain an exchange of information about any technical element worth being shared between the two networks.

Office of Outreach and Communications Report

Nancy Wolfe Kotary

Abstract This document constitutes the biennial 2021–2022 report for the IVS Office of Outreach and Communications.

1 General Information

The IVS Office of Outreach and Communications (IVS OOC) is staffed by myself alone, as its director, with administrative and information technology support from MIT Haystack Observatory and in consultation with the IVS Coordinating Center (IVS CC). Responsibilities include maintaining an outreach website, <http://vlbi.org>, which is funded by MIT Haystack Observatory, plus the nascent IVS social media presence, as well as general outreach and communications activities.

2 Activities During the Past Two Years

Activities for the period of this report include maintenance and periodic updates to the <http://vlbi.org> site; postings to the IVS Twitter account (<https://twitter.com/ivs.ooc>); attendance at and participation in IVS Directing Board (IVS DB) meetings; working with the IVS CC on IVS elections; a complete redesign of the venerable IVS Newsletter; and minor contributions to the IVS Newsletter content.

1. MIT Haystack Observatory

IVS Office of Outreach and Communications IVS-OOC

IVS 2021+2022 Biennial Report

3 Current Status

The described activities of the IVS OOC are being continued and are planned to be extended.

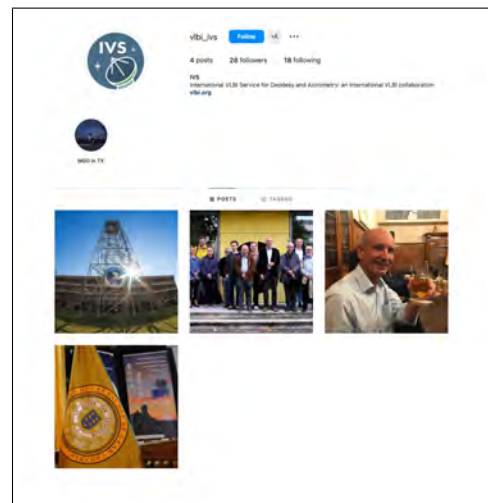

Fig. 1 The small, yet beautiful, IVS Instagram site.

4 Future Plans

IVS OOC activities will be updated and expanded over the next year. The IVS OOC website, <http://vlbi.org>, will be updated and a few links will be repaired during normal maintenance, and additional content will be added as time permits. The material will include new VLBI outreach and educational material, as well as IVS information, both text and graphics. The Twitter

feed will be more frequently updated and will be used to promote IVS materials, from the IVS OOC and elsewhere. Information from IVS stations will be solicited. With the return of in-person events, such as the IVS

Technical Operations Workshop (TOW), the IVS Instagram site (https://www.instagram.com/vlbi_ivs/) will be able to be revived, and the site will benefit from new photographs of IVS activities.

NETWORK STATIONS



Argentinean-German Geodetic Observatory

AGGO-VLBI Network Station Report

Hayo Hase¹, Federico Salguero², Martin García², José Vera², Augusto Cassino², Alfredo Pasquaré², Christian Kristukat¹

Abstract The Argentinean-German Geodetic Observatory (AGGO) contributed to observation programs of the IVS and of Wettzell. This report summarizes the activities of AGGO as an IVS Network Station in relation to the provision of VLBI data during 2021–2022.

1 General Information

The Argentinean-German Geodetic Observatory (AGGO) is a joint effort of the Argentinean National Scientific and Technical Research Council (CONICET) and the German Federal Agency of Cartography and Geodesy (BKG) to support the Global Geodetic Observing System (GGOS) by contributing a geodetic fundamental station located in South America [1].

The selected site is a plot of land, owned by the science department of the provincial government of the Province of Buenos Aires, about 25 km from the center of its capital town of La Plata (and about 50 km from the city of Buenos Aires). It is adjacent to the natural park Pereyra Iraola and next to the Argentinean Institute of Radio Astronomy (IAR) [2].

The project is based on the bilateral scientific-technical cooperation between Argentina and Germany. The agreement of cooperation between both partners was renewed in October 2022. It provides now a base for an at least 10-year period of further

1. Bundesamt für Kartographie und Geodäsie (BKG)

2. Consejo Nacional de Investigaciones Científicas y Técnicas (CONICET)

AGGO Network Station

IVS 2021+2022 Biennial Report



Fig. 1 The Argentinean-German Geodetic Observatory is a fundamental station for geodesy and, as such, a reference in the time, space, and gravity domain (Photo: 2022-12-26).

cooperation and commitment to operate AGGO jointly. Germany via BKG provides, maintains, and renews the measuring devices. CONICET provides the infrastructure. The operation is carried out jointly by staff from BKG and CONICET, complemented by operators from the Ministry of Defense of Argentina.

2 Component Description

Figure 2 shows a recent picture of the VLBI antenna at AGGO with characteristics and coordinates given in Table 1.

3 Staff

In 2022 two new colleagues could be hired for the VLBI activities at AGGO. The current VLBI staff situation is given in Table 2 (with new members marked



Fig. 2 The 6-m primary focus offset radio telescope for VLBI observations of AGGO (2021-10-16).

Table 1 Useful data about the VLBI reference point at AGGO and VLBI equipment.

Parameter	Value
DOMES No.	41596S002
CDP No.	7641 (axis intersection)
Four char code	AGGV
IVS two-letter code	Ag
approx. longitude	W 58.51398°
approx. latitude	S 34.8739°
approx. height	35.8 m
data acquisition	VLBA5
data recorder	Mark 5B+
max. e-transfer bandwidth	400 Mbps
FS version	9.13.2 (2020)
webcam:	https://www.aggo-conicet.gov.ar/liveview.php

by *). As the VLBI system is not a black box with un-failing components, training of the operators has been an ongoing process. The transition to new devices or changes in the operation processes has required a permanent training. During the last two years the technical documentation for the operations, the procedures, and the manuals have been improved and extended so that new operators can be trained more efficiently.

4 Current Status

4.1 Maintenance and Modernization

During the year 2021 some COVID-19 related restrictions still applied, and the main focus was put on keeping the observation schedules executed and monitoring the system performance. At the beginning of 2022 several modernization actions were carried out at the receiver. Replacement of aged, semirigid cables as well as the exchange of a failing local oscillator had become necessary. Some defective peltier elements at the receiver box had to be replaced. Due to the hot climate during Argentinean summer days, frequent interventions on the cryosystem were necessary in order to re-establish and maintain cryogenic temperatures. Still, it was not always possible, and some observations were lost due to high outside temperatures.

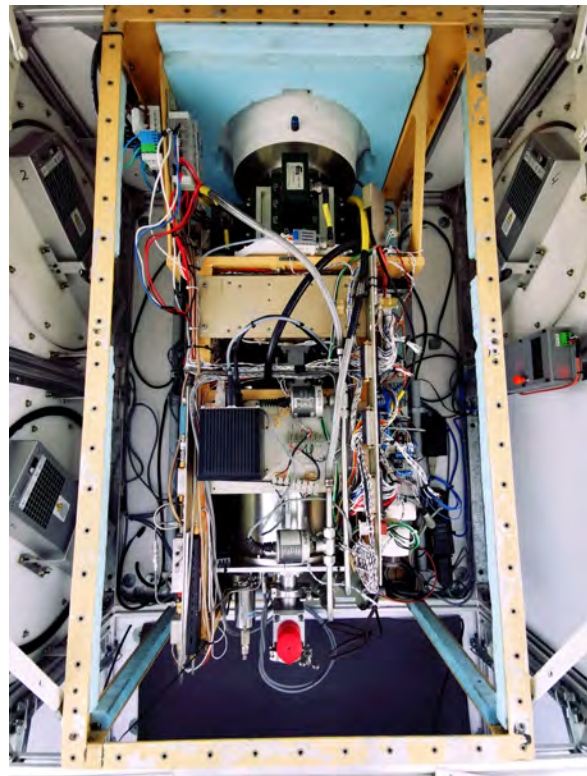

Fig. 3 The cryogenic dual band S/X receiver of the 6-m radio telescope at AGGO (2022-04-14).

Table 2 AGGO staff 2021–2022 linked with VLBI (new *members). (Name top-down corresponds to photo left-right.)

Name	Background	Tasks	Email
Federico Salguero	electronic engineer	VLBI hardware	fsalguero@aggo-conicet.gob.ar
*Martin García	electronic engineer	VLBI hard- and software	mgarcia@aggo-conicet.gob.ar
José Vera	electronic engineer	VLBI software and system administrator	jvera@aggo-conicet.gob.ar
Alfredo Pasquaré	electronic engineer	time and frequency lab, GNSS	apasquare@aggo-conicet.gob.ar
Augusto Cassino	electrical engineer	head of infrastructure and construction	acassino@aggo-conicet.gob.ar
Hayo Hase	geodesist	head of operations	hayo.hase@bkg.bund.de
*Christian Kristukat	physicist	VLBI support	christian.kristukat@bkg.bund.de
Six operators	soldiers	VLBI operation	



In November 2022 the first observations using the DBBC2 and the FlexBuff recorder could successfully be performed in parallel to the analog VLBA4 system with Mk5 recorder. This was made possible by a joint effort thanks to the preparation of this upgrade by AGGO staff (Field System upgrade from 9.13 to 10.1, hardware installation, and development of an IF splitter) and the visit of Christian Plötz from BKG Wettzell, who introduced the AGGO staff to the new devices.

Although the quality of the line power supply to AGGO has improved to some extent, AGGO is still affected by unannounced power outages. The horizon mask for the radio telescope decreased slightly due to growing trees. The radio frequency interference situation at S-band is affecting most often the upper two S-band channels.

As a fundamental station for geodesy, AGGO hosts also an SLR station, the overhaul of which suffered further delays due to the COVID-19 crisis. The local survey of the important reference points at AGGO is executed on a periodical basis. Other instruments are kept working:

- time and frequency lab with two H-masers, three Cs normals (one Cs failed and will be replaced in 2023), one GNSS receiver, and one NTP server
- VLBI radio telescope
- GNSS receiver (IGS)
- absolute gravity meter and superconducting gravity meter (IGFS)
- hydrological sensors
- meteorological sensors.

Internet provision is available through a 1 Gbps optical fiber.

The construction of a new office building for the staff of AGGO has been initiated and is more than four years delayed. Once it is finished, the space of the operation building will be released to move the VLBI equipment from the containers to the operation building.

4.2 Sessions

Table 3 gives an overview about the data yield from AGGO and its performance. The loss of sessions is related mainly to technical failures during the summer months. But these failures trigger improvement projects, which will be rolled out during the coming years (see Section 5).

4.3 Outreach

Several groups of students and scientists of local universities and research institutions have been received in order to spread the knowledge about the existence of the AGGO as a fundamental station for geodesy and to demonstrate modern geodetic methods to a broader audience. In October 2022 a workshop on VLBI was held at the University of La Plata, and AGGO staff participated as speakers.

Table 3 AGGO VLBI session performance 2021–2022. The column “Correlated” contains also observed sessions which are still in backlog at the correlators. “Lost” sessions are those which had to be canceled or had been eliminated from the correlation process due to poor quantity or quality of observations. The W-series is a domestic 2-hour session of BKG on the baseline Wettzell–AGGO.

Year	Session	Duration (hours)	Scheduled	Correlated	Lost	Performance
2021	R1	24	39	27	12	0.69
	R4	24	3	2	1	0.67
	T2	24	3	1	2	0.33
	CRD	24	6	3	3	0.50
	OHG	24	4	2	2	0.50
Total (24 hour)			55	35	20	0.64
	WE	2	18	14	4	0.78
2022	R 1	24	43	29	14	0.67
	R4	24	0	0	0	0.00
	T2	24	3	1	2	0.33
	CRD	24	6	5	1	0.83
	OHG	24	5	2	3	0.40
Total (24 hour)			57	37	20	0.65
	WF	2	6	5	1	0.83

5 Future Plans

A number of important issues will take place during the coming years.

- Replacement of hybrid cables of the azimuth and elevation cable wrap. After > 27 years of operation the cables will be proactively replaced by unused hybrid cables.
- The servo cabinet of the antenna control unit will be moved from the container into the operation building of AGGO. This action requires disconnecting and reconnecting all critical signal and power lines.
- The VLBI operation will be moved to the operation room of the operation building.
- With the disappearance of CTI components for the cryogenic part at the front end, a new dewar with a different cryocooler and compressor needs to be designed, produced, and installed. This is the opportunity to employ a larger cryocooler and hence to achieve better system performance and better resistance against hot summer days.
- The technical specifications of a VGOS radio telescope for AGGO will be prepared.

Related to these VLBI-specific tasks, it should be mentioned that AGGO also received a Water Vapor Radiometer as a complementary device to VLBI and GNSS measurements. Its installation is scheduled for 2023.

Acknowledgements

The authors acknowledge the support received from the Argentinean Ministry of Defense with the provision of operators and are especially grateful to its coordinator Dr. Anibal Aguirre.

References

1. H. Hase, C. Brunini, A. Cassino, F. Salguero, J. Vera, A. Pasquaré, “Moving from TIGO to AGGO.” In: International VLBI Service for Geodesy and Astrometry 2015+2016 Biennial Report, edited by K. D. Baver, D. Behrend, and K. L. Armstrong, NASA/TP-2017-219021, pp. 43–47, 2017.
2. H. Hase, F. Salguero, J. Vera, A. Cassino, A. Pasquaré, C. Brunini, “AGGO Coming Back To Operation.” In: International VLBI Service for Geodesy and Astrometry 2017+2018 Biennial Report, edited by K. L. Armstrong, K. D. Baver, and D. Behrend, NASA/TP-2020-219041, pp. 41–44, 2020.

Effelsberg Radio Observatory 2021–2022 Report

Uwe Bach, Alex Kraus

Abstract The 100-m radio telescope of the Max-Planck-Institut für Radioastronomie (MPIfR) is one of the largest fully steerable single-dish radio telescopes in the world and is a unique high-frequency radio telescope in Europe. The telescope can be used to observe radio emissions from celestial objects in a wavelength range from 90 cm (300 MHz) down to 3.5 mm (90 GHz).

1 General Information

The Effelsberg radio telescope was inaugurated in 1971 and was (for almost 30 years) the largest fully steerable single-dish radio telescope in the world. It is situated in a protected valley near Bad Münstereifel (about 40 km southwest of Bonn) and operated by the Max-Planck-Institut für Radioastronomie (MPIfR) on behalf of the Max-Planck-Society (MPG). To this day, it is the largest radio telescope in Europe and is mostly used for astronomical observations.

This extremely versatile and flexible instrument can be used to observe radio emissions from celestial objects in a wavelength range from about 1 m (corresponding to a frequency of 300 MHz) down to 3.5 mm (90 GHz). The combination of the high surface accuracy of the reflector (the mean deviation from the ideal parabolic form is ~ 0.5 mm rms) and the construction principle of ‘homologous distortion’ (i.e., the reflector in any tilted position has a parabolic shape with a

well-defined, but shifted, focal point) enables very sensitive observations to be made at high frequencies (i.e., $\nu > 10$ GHz).

The wide variety of observations with the 100-m radio telescope is made possible by the good angular resolution, the high sensitivity, and a large number of receivers which are located either in the primary or in the secondary focus. Together with a number of distinct backends dedicated to different observing modes, this provides excellent observing conditions for spectroscopic observations (atomic and molecular transitions in a wide frequency range), high time-resolution (pulsar observations), mapping of extended areas of the sky, and participation in a number of interferometric networks (IVS, mm-VLBI, EVN, and Global VLBI etc.).

Table 1 Telescope properties.

Name	Effelsberg
Coordinates	6:53:01.0 E,+50:31:29.4 N
Mount	azimuthal
Telescope type	Gregorian (receivers in primary and secondary focus)
Diameter of main reflector	100 m
Focal length of prime focus	30 m
Focal length of secondary focus	387.7 m
Surface accuracy	0.55 mm rms
Slew rates	Azi: 25 deg/min, Elv: 16 deg/min
Receivers for geodetic observations	3.6 cm/13 cm secondary-focus (coaxial)
T_{sys} (3.6 cm/13 cm)	25 K, 200 K
Sensitivity (3.6 cm/13 cm)	1.4 K/Jy, 0.5 K/Jy
HPBW (3.6 cm/13 cm)	81 arcsec, 350 arcsec
Tracking accuracy	~ 2 arcsec

Max-Planck-Institut für Radioastronomie, Bonn, Germany

Effelsberg Network Station

IVS 2021+2022 Biennial Report



Fig. 1 Aerial view of the Effelsberg radio observatory on the morning of July 15, 2021. The image shows in the foreground the completely flooded “low-band” part of the Effelsberg station of the European LOFAR telescope network. In the background is the 100-m radio telescope and to the left the observatory building with the control room (photo N. Tacke, MPIfR).

2 Staff

The staff at Effelsberg consists of about 40 people, including telescope operators, technical personnel for receivers, electronics, and mechanics, scientists, and administrative personnel. Involved in IVS activities are, besides the telescope operators, **Dr. Alexander Kraus** as station manager and scheduler for the 100-m Effelsberg telescope and **Dr. Uwe Bach** as support scientist and VLBI friend. Two of the telescope operators, **Marcus Keseberg** and **Peter Vogt**, are also involved in the preparation of schedules and disk management and shipping.

3 Activities during the Past Years

Effelsberg has participated regularly in the EUROPE IVS sessions since 1991. In 2021 and 2022, the experiments T2P144, T2148, T2P151, and T2P157 were ob-

served. All observations were successful. Only T2P157 was partly affected by snow fall, and a few scans were lost. About 30% of the observing time of the Effelsberg antenna is used for VLBI observations. Most of them are astronomical observations for the European VLBI Network (EVN), High Sensitivity Array (HSA), Global MM VLBI Array (GMVA), or other global networks, but also geodetic VLBI observations within the IVS are performed.

Despite the restrictions caused by the worldwide pandemic that also caused shutdowns in Germany in 2021, the operation of the observatory was not interrupted. A reduced staff ensured the operation, and observations were conducted remotely. Since 2022, there have been no general shutdowns, and the restrictions have only applied to individual measures, such as quarantine in the event of infection.

In summer 2021 an extreme weather situation with heavy rainfalls on July 13 and 14, 2021 caused serious flooding in the Ahr valley and neighboring regions of the Eifel, with partly devastating destruction. To a

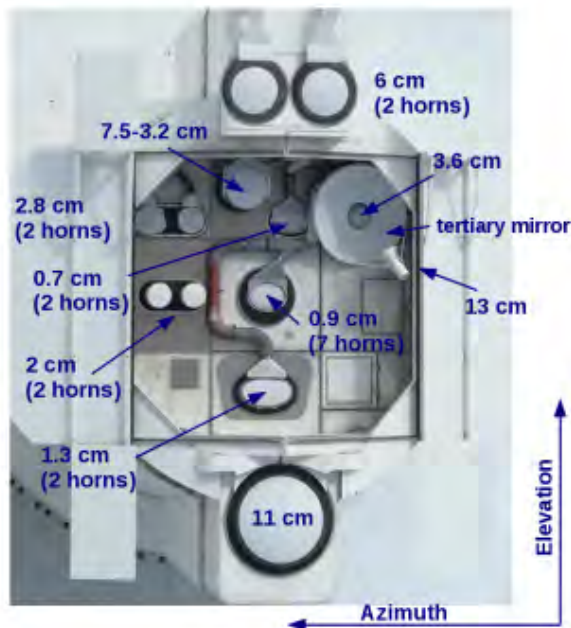

Fig. 2 Picture of the secondary focus cabin with several astronomical receivers. Secondary focus receivers are permanently mounted on their positions and can be used “quasi-parallel”, i.e., one can easily change by software from one receiver to another in a timescale of about 40 seconds. The geodetic SX system with the 3.6-cm horn and the tertiary mirror for the 13-cm horn is visible on the top right side of the cabin.

relatively small extent—compared to the neighboring valleys—the observatory was also affected. Due to its location in a valley, with the Effelsberger Bach and the Rötzelbach (normally tiny creeks), there was also massive flooding here. Part of the ground was overflowed, including the access road and the storage building south of the telescope. A container with technical equipment was washed away, and some low-band antennas of the LOFAR field were destroyed (see also the photo in Figure 1). Fortunately, no one was harmed during this event. But the institute was without electricity, water, and telephone for a few days. Thanks to the energetic efforts of many colleagues from Effelsberg and Bonn, the situation was soon eased. Astronomical observations with the 100-m telescope was restarted after just five days.

4 Current Status

Effelsberg uses the DBBC2, Fila10G, and a Mark6 recorder for all EVN, global, and geodetic VLBI observations. The Mark6 recorders provide 390 TB of storage capacity, and most of the recorded data are e-transferred to the correlators in Bonn and JIVE. One slot is currently kept for modules that can be shipped.

In addition to the DBBC2 there are two NRAO RDBEs connected to one of the Mark6 recorders that are used for observations with the VLBA and HSA. Mark6 modules to Socorro are still being shipped. Both VLBI backends and their recorders are controlled by the Field System (current release FS-10.1.0). The observatory is connected via a 10 GE optical fiber to the e-VLBI network and can do real time e-VLBI observations (performed about monthly within the EVN) and e-transfers.

5 Future Plans

The DBBC3 is currently being commissioned for regular use for all Effelsberg VLBI observations. In principle it is fully compatible with both existing systems, the DBBC2 and the RDBEs, and can therefore replace both. But before this is finalized, tests within the EVN, GMVA, and together with the VLBA have to be performed to ensure that the correlation and calibration of data is as good as before. The operators have to also be trained to work with the new backend.

In parallel the direct digitalization of the RF signals from the receivers in Effelsberg is progressing. The same digitizers that are used for Meerkat digitize up to 3 GHz at the receiver, and the full band at 10 to 12 bits is streamed over 100 Gbps Ethernet using the SPEAD protocol to the software backend. A software backend on a GPU cluster is being developed that currently supports single dish continuum and spectroscopy observations in full Stokes and pulsar observations. A first implementation of a tunable digital down conversion algorithm that writes out channelized VLBI VDIF data at data rates of up to 2 Gbps is being developed as well. After the verification with local zero-baseline tests, tests with real VLBI observations are planned. There are currently three receivers that provide the digitized signals—the 21 cm (1.29 to 1.51 GHz), a prime focus wide band receiver at 1.3 to

6 GHz, and a secondary focus receiver from 4 to 9.3 GHz (7.5 cm to 3.2 cm, see Figure 2)—that cover some of our typical VLBI frequency bands. Once the system is established, it is planned to digitize more and more of the Effelsberg receivers over the next years.

A larger project to upgrade the main axis control systems and encoders in azimuth and elevation has started. The contract with a company that specializes in

radio telescopes has been signed, and the detailed design study has started. The actual change of the hardware requires an observational stop of several weeks and is currently foreseen for summer 2024. We will try to minimize the downtimes during the regular EVN sessions and the planned e-VLBI dates.

Fortaleza Station Report for 2021 and 2022

Adeildo Sombra da Silva ¹, Jean-Pierre Raulin ¹, Darryl D. Lakins ², Jeffrey L. Dorman ²

Abstract This is a brief report about the activities carried out at the Fortaleza Geodetic Observatory (FGO), Rádio Observatório Espacial do Nordeste (ROEN), located in Eusébio, CE, Brazil, during the period from January 2021 until December 2022.

1 General Information

The Rádio Observatório Espacial do Nordeste, ROEN, also known as Fortaleza Geodetic Observatory, FGO, located at INPE facilities in Eusébio, nearly 30 km east of Fortaleza, Ceará State, Brazil, began operations in 1993. Geodetic VLBI and GPS observations are carried out regularly, as contributions to international programs and networks. ROEN/FGO is part of the Brazilian space geodesy program, which was initially conducted by CRAAE (a consortium of the Brazilian institutions Mackenzie, INPE, USP, and UNICAMP) in the early 1990s. The program began with antenna and instrumental facilities installation sponsored by the U.S. agency NOAA and the Brazilian Ministry of Science and Technology's FINEP agency.

ROEN/FGO is currently coordinated by CRAAM, The Center of Radio Astronomy and Astrophysics, Engineering School, Mackenzie Presbyterian University, São Paulo, in agreement with the Brazilian National Space Research Institute, INPE. The activities are carried out under an Agreement of Cooperation

signed between NASA—representing research interests of NOAA and USNO—and the Brazilian Space Agency, AEB, which has been extended until August 2023. Discussions are currently underway for a ten-year extension including new possible partners. Under the auspices of the NASA-AEB Agreement, a contract was signed between NASA and CRAAM, Mackenzie Presbyterian Institute and University to partially support the activities at ROEN/FGO. In 2019 the contract was renewed for five more years.

The counterpart of the operational costs, staff, and support of infrastructure are provided by INPE and by Mackenzie.



Fig. 1 14.2-m radio telescope.

1. Universidade Presbiteriana Mackenzie, CRAAM and INPE, Rádio Observatório Espacial do Nordeste

2. National Aeronautics and Space Administration, NASA

2 Main Instruments

The largest instrument at ROEN is the 14.2-m radio telescope on an alt-azimuth positioner. It is operated at S- and X-bands, using cryogenic radiometers. The system is controlled by the Field System, Version 9.11.19. Observations are recorded with a Mark 5A system and transmitted through a high speed network either to the correlators in U.S. (WACO and Haystack) or to Bonn in Germany or to Shao in China at rates about 300 Mbps.

For this, a 1 Gbps link has been available since 2007. It integrates and is sponsored by the Brazilian Research Network — RNP.

One Sigma-Tau hydrogen maser clock standard is operated at ROEN. GPS monitoring is performed within a cooperative program with NOAA (USA). A Septentrio PolarRx5 receiver was installed at the station and operates continuously. The collected data are provided to the NOAA/IGS center and to the Brazilian IBGE center. ROEN has all basic infrastructures for mechanical, electrical, and electronic maintenance of the instrumental facilities.

3 Staff

Dr. Jean-Pierre Raulin is the current coordinator of the geodesy program. The coordination receives support from the São Paulo office at CRAAM/Instituto and Universidade Presbiteriana Mackenzie, with administrative support from Valdomiro M. S. Pereira and Lucíola Russi.

The Fortaleza Station facilities and geodetic VLBI and GPS operations are managed on site by Eng. Adeildo Sombra da Silva (CRAAM / Mackenzie) and the technicians Francisco Renato de Abreu (CRAAM / Mackenzie), Emerson Costa (CRAAM / Mackenzie), and Kelvin de Oliveria (CRAAM / Mackenzie).

4 Current Status and Activities

4.1 Azimuth Bearing Replacement

In November of 2020, the FGO 14.2-meter antenna bearing failed after ten years of operations. Intertronic-



Fig. 2 The 14.2-m antenna set down off the pedestal for bearing replacement activity.

Calian (ISI) completed a failure analysis to identify the root cause of the bearing failure. Based on the results of the failure analysis, ISI developed specifications for an improved bearing that provides extended life. There were delays in getting access to a vendor to manufacture the bearing, with the main contributor to the delay being the pandemic and associated supply chain issues. Once the manufacturing of the bearing started, the antenna's gearboxes, electrical motors, torque limiters, and other auxiliary equipment were replaced or refurbished by the FGO staff. Upon receipt of the new bearing, the old bearing was replaced with the new bearing by Revtech in February 2023. Both NASA and ISI-Calian were onsite to support the replacement activities.

All the auxiliary equipment was installed and tested. The signal chain was installed. The FGO staff tested the antenna's slewing and pointing. The pointing and slewing models were updated. The FGO 14.2 m was placed back into operations in May 2023.

4.2 New VGOS Antenna Construction

The new VGOS 12-m system build began in early 2021. ISI has the manufacturing of the 12-m antenna, and the factory acceptance test will be in September 2023. MIT has started the build of the signal chain. The FGO signal chain build will include the new generation ROACH-2 digital backends. The digital backend systems digitize and timestamp the incoming radio signals before they are sent on to other components for recording and analysis. Peraton is providing the meteorological sensors, networking equipment, the monitoring/archival element, and a time/frequency element that includes a new Hydrogen Maser Clock. NVI is providing the Field System that will include the capability of automatically handling schedules and an improved communications capability between VLBI stations and communication & coordination centers. KBR developed designs for all the modifications to the FGO infrastructure needed to support the new 12-m VGOS system. The modifications include a new generator and an uninterruptible power supply (UPS) set that will service both the 12-m and 14.2-m antennas. KBR also provided designs for an antenna foundation, an access road for the new 12-m antenna, and modifications to the operations building to support the new maser clock and other technical equipment.

Mackenzie University is implementing the modifications to the FGO infrastructure. Earthscope is providing three new GNSS antennas/receivers. The SGNOG, Space Geodesy Project's network operations center, will provide enhanced display capabilities to increase the overall situation awareness for the FGO station. This will include station operational status, network management, and alert displays that will enable the local operations team, support elements, and NASA managers to effectively respond to changes to the FGO operational environment.

The FGO station will be ready for commissioning/operations as early as January 2025.

4.3 VLBI Observations

In the years of 2021 and 2022, Fortaleza did not participate in any geodetic VLBI sessions.



Fig. 3 Site plan for 12-m VGOS construction.

4.4 Operational and Maintenance Activities

The summary of activities performed in the period is listed below:

1. Evaluation of the azimuth bearing failure: NASA/Intertronics Inc. performed a failure analysis.
2. Producing new requirements for extending the bearing lifespan.
3. Procurement and hiring of companies to design and manufacture the bearing.
4. Procurement and hiring of companies to perform the bearing replacement work.
5. Refurbishment of gearboxes, electrical motors, torque limiters, and brakes of antenna drives.
6. Supporting the Revtech company activities during the bearing replacement work along with NASA and Intertronics Inc. staff.
7. Procurement and hiring of contractors to perform geotechnical and topographical surveys for the design of the new VGOS telescope.
8. Providing support to the KBR team at the site on the new VGOS system design.
9. Operation and maintenance of geodetic GPS (NOAA within the scope of the NASA contract).

4.5 GPS Operations

The IGS network GPS receiver operated regularly at all times during 2021 and 2022. Data were collected and uploaded to an IGS/NOAA.

5 Future Plans

FGO expects to return to the IVS geodetic VLBI schedule in May 2023.

All efforts are being made to implement the designed site constructions and modifications on time to make the facilities ready for the installation within 2023, then have the VGOS system fully operational up to early 2025, according to the schedule.

Goddard Geophysical and Astronomical Observatory

Chris Szwec, Katie Pazamickas

Abstract This report summarizes the technical parameters of the Very Long Baseline Interferometry (VLBI) systems at the Goddard Geophysical and Astronomical Observatory (GGAO) and provides an overview of the activities that occurred in 2021–2022, provides the outlook for 2023, and lists the outstanding tasks to improve the performance.

1 Location

The Goddard Geophysical and Astronomical Observatory (GGAO) consists of a 12-meter radio telescope for VGOS development, a 1-meter reference antenna for microwave holography development, an SLR site that includes MOBLAS-7, the next generation Space Geodesy Satellite Laser Ranging (SGSLR) system, a 48” telescope for developmental two-color Satellite Laser Ranging, a GPS timing and development lab, a DORIS system, meteorological sensors, and a hydrogen maser. The 5-meter radio telescope for VLBI is no longer in service. In addition, the site is a fiducial IGS site with several IGS/IGSX receivers. GGAO is located on the east coast of the United States in Maryland. It is approximately 15 miles NNE of Washington, D.C. in Greenbelt, Maryland.

- Longitude 76.4935
- Latitude 39.0118
- MV3
- Code 61A

Peraton

GGAO Network Station

IVS 2021+2022 Biennial Report

- Goddard Space Flight Center (GSFC)
- Greenbelt, Maryland 20771
- <https://cdis.nasa.gov/ggao/>

2 Technical Parameters

In October of 2010, construction of the 12-meter VGOS developmental antenna was completed. This antenna features all-electric drives and a Cassegrain feed system. The antenna has a VGOS broadband receiver and associated subsystems.

The technical parameters of the 12-m radio telescope are summarized in the following table.

Table 1 The technical parameters for GGAO.

Parameters	12-m Antenna
Owner and operating agency	NASA
Year of construction	2010
Diameter of main reflector	12 m
Azimuth range	+/-270 deg
Azimuth velocity	5 deg/sec
Azimuth acceleration	1.3 deg/sec/sec
Elevation range	5-88 deg
Elevation velocity	1.25 deg/sec
Elevation acceleration	1.3 deg/sec/sec
Focus	Cassegrain
Receive Frequency	2-14 GHz
Bandwidth	512 MHz, four bands
VLBI terminal type	VGOS
Recording media	Mark 6

3 Staff of the VLBI Facility at GGAO

GGAO is a NASA research and development and data collection facility. The VLBI facility at GGAO is operated under the Space Exploration Network Services and Evolution (SENSE) contract by Peraton. The Peraton staff includes Katie Pazamickas (Station Manager), Jay Redmond (Station Engineer), and Sean Gilliams (Station Engineer) conducting VLBI operations and maintenance at GGAO with the support of the sustaining engineering Peraton team.

- Completed a replacement of the jackscrew, elevation gearbox, and brake assembly with the team at ISI
- Supported MIT in a GGAO receiver upgrade. Receiver components were upgraded and tested at MIT and re-installed at GGAO
- Supported NVI in Field System upgrades as a test station
- Supported the development of Single Dish Tests with NASA and continued to operate SDEs upon request.

E-Transferring entire VGOS-O and VGOS Intensive sessions to various correlators has become routine.

4 Mission Support

Having ceased VLBI operations in May 2007, the MV3 5-m antenna is retired due to issues with the obsolete controller. The 12-m VGOS antenna has participated in many VLBI Global Observing System (VGOS) 24-hour experiments, including CONT17, VGOS Trial, and VGOS Intensive observations. The antenna currently observes VGOS-O observations on a regular weekly basis as well as other observations as required.

5 Recent Activities

Much of the 2021 and 2022 activities at GGAO have been focused on VGOS observing using the 12-m antenna. Other activities worth noting include:

- Conducted IVS observations using the Mark 6 recorders to demonstrate the VGOS capabilities on a regular schedule (provided by the IVS)
- Participated in 52 VGOS-O sessions in 2021 and 2022
- Participated in 16 VGOS Intensive sessions in 2022
- Participated in five R&D sessions in 2021–2022
- Participated in three VGOS-T sessions in 2021–2022
- Participated in six VGOS Intensive-test sessions in 2022
- Obtained regular cable delay measurements to use along with the observation data
- Fully upgraded the VLBI facility's network infrastructure

6 Outlook

GGAO will continue to support VGOS, e-VLBI, and other developmental observations and activities during the upcoming year. Tentative plans for 2023 include:

- Conducting IVS observations using the Mark 6 recorders to demonstrate the VGOS capabilities on a regular schedule as dictated by the IVS
- Continuing to investigate how and why the cables are degrading in the azimuth wrap and continuing to mitigate water intrusion
- Continuing taking cable delay measurements for observation data correlation
- Sub-reflector replacement due to damage caused by the weather
- Technology upgrades for the GGAO digital backend
- Continuing to operate as a test station for VGOS development, specifically for the FGO 12-m antenna build.

Hartebeesthoek Radio Astronomy Observatory (HartRAO)

Marisa Nickola, Aletha de Witt, Jonathan Quick, Roelf Botha, Philip Mey

Abstract HartRAO is the only fiducial geodetic site on the African continent, and it participates in global networks for VLBI, GNSS, SLR, and DORIS. This report provides an overview of geodetic VLBI activities at HartRAO during 2021 and 2022, including progress with the VGOS antenna and an update on the 26-m antenna's failing west declination shaft bearing.

1 Geodetic VLBI at HartRAO

The Hartebeesthoek Radio Astronomy Observatory (HartRAO) forms part of the larger South African Radio Astronomy Observatory (SARAO). The Hartebeesthoek site is located 65 km northwest of Johannesburg, just inside the provincial boundary of Gauteng, South Africa. HartRAO is located 32 km away from the nearest town, Krugersdorp. The telescopes are situated in an isolated valley which affords some protection from terrestrial radio frequency interference. HartRAO currently operates 13.2-m, 15-m, and 26-m radio telescopes. The 13.2-m VGOS radio telescope is still not fully operational, but a broadband VGOS receiver is under construction at Yebes, and a matching DBBC3 backend and Mark 6 recorder are now available. It should hopefully achieve operational status in the first half of 2024. The 26 m is an equatorially mounted Cassegrain radio telescope built by Blaw Knox in 1961. The telescope was part of the NASA deep space tracking network until 1974 when the

SARAO

HartRAO Network Station

IVS 2021+2022 Biennial Report

facility was converted to an astronomical observatory. The 15 m is an az-el radio telescope built as a Square Kilometer Array (SKA) prototype during 2007 and converted to an operational geodetic VLBI antenna during 2012. The telescopes are co-located with an ILRS SLR station (MOBLAS-6), a Russian satellite laser and radio ranging system «Sazhen-TM+OWS», two IGS GNSS stations (HRAO and HRAG00ZAF), a seismic vault, and an IDS DORIS station (HBMB) at the adjoining South African National Space Agency Earth Observation (SANSA EO) site. SARAO is also a full member of the European VLBI Network (EVN).



Fig. 1 The HartRAO 26-m and 15-m antennas currently participating in IVS sessions.

2 Technical Parameters of the 15-m, 26-m, and VGOS Telescopes at HartRAO

Table 1 contains the technical parameters of the HartRAO 15-m, 26-m, and VGOS antennas, while Table 2 and Table 3 contain technical parameters of

the HartRAO 15-m and 26-m receivers, respectively. The current data acquisition systems consist of a DBBC terminal and a 432 TB Flexbuf recorder for the 15-m antenna and a Mark 5B+ recorder for the 26-m antenna. Spare Mark 5B, Mark 5B+, and Mark 5C recorders are used for e-transfer of data and conditioning and testing of disk packs. Both DBBC2s have recently had an internal power-wiring upgrade installed. A 258 TB Flexbuf recording system is also available on the 26-m antenna for astronomical VLBI use.

Currently, the hydrogen maser iMaser 72 is being used for VLBI on both the 15-m and 26-m antennas. The EFOS-28 hydrogen maser, previously employed for VLBI on the 15-m antenna, developed an internal heater fault and was taken out of service. It is not reliable but still usable. A heater controller replacement on EFOS-28 is also pending, which should correct the problem once installed. The older EFOS-6 hydrogen maser is completely down at the moment, and attempts to restart it have failed thus far.

Table 1 Antenna parameters.

Parameter	Hart15	Hart26	HartVGOS
Owner and operating agency	NRF	NRF	NRF
Year of construction	2007	1961	2017
Mount type	Offset az-el	Offset equatorial	Az-El
Receiving feed	Prime focus	Cassegrain	Ring-focus
Diameter of main reflector d	15 m	25.914 m	13.2 m
Focal length f	7.5 m	10.886 m	3.7 m
Focal ratio f/d	0.5	0.42	0.4
Surface error of reflector (RMS)	1.6 mm	0.5 mm	0.1894 mm
Short wavelength limit	3 cm	1.3 cm	3 mm
Pointing resolution	0.001°	0.001°	0.0001°
Pointing repeatability	0.004°	0.004°	(unknown)
Slew rate on each axis	Az: 2° s ⁻¹ El: 1° s ⁻¹	HA: 0.5° s ⁻¹ Dec: 0.5° s ⁻¹	Az: 12° s ⁻¹ El: 6° s ⁻¹

3 Current Status

During 2021 and 2022, the 15-m antenna participated in 131 and 169 geodetic/astrometric IVS sessions respectively (see Figure 2). The 26-m antenna partic-

Table 2 Parameters of the 15-m co-axial receiver.

Parameter	X-band	S-band
Feeds	stepped horn	wide-angle corrugated horn
Amplifier type	cryo HEMT	cryo HEMT
T_{sys} (K)	40	42
S_{SEFD} (Jy)	1400	1050
PSS (Jy/K)	35	25
3 dB beamwidth (°)	0.16	0.57

Table 3 Parameters of the 26-m receiver (degraded performance due to dichroic reflector being used for simultaneous S-X VLBI).

Parameter	X-band	S-band
Feeds	dual CP conical	dual CP conical
Amplifier type	cryo HEMT	cryo HEMT
T_{sys} (K)	52	40
S_{SEFD} (Jy)	849	1190
PSS (Jy/K)	16.3	29.8
3 dB beamwidth (°)	0.096	0.418

ipated in 29 and 30 sessions during 2021 and 2022 respectively (see Figure 3). Only during the T2P sessions did the antennas have an opportunity to observe together in 2021 and 2022. The 15-m antenna continued its participation in the hour-long Southern Intensive (SI) test sessions, observing together with the Hobart and Yarragadee 12-m antennas in 35 sessions in 2021. The SI sessions were officially added to the 2022 Master Intensive Schedule with observations scheduled for Mondays at 06:30 UT to overlap with the INT-3 sessions. From June 2022 onwards, the three-station network was reduced to the single HartRAO15–Hobart12 baseline. During 2021 and the first part of 2022, the 15-m antenna also joined in the AUSTRAL mixed-mode (AUM) observing sessions which aimed to provide the Hobart and Katherine 12-m antennas with uninterrupted position time series before they transitioned to full VGOS wideband operations. The HartRAO 26-m also contributes to astrometric celestial reference frame (CRF) observations conducted at K-band (24 GHz). Regular single-baseline observations between the HartRAO and Hobart 26-m antennas provide valuable data for the southern K-band CRF. Unfortunately, from March 2021 onwards, a bearing failure on the Hobart 26-m antenna prevented any further single-baseline VLBI sessions between the HartRAO and Hobart 26-m antennas from being observed. These astrometry experiments, towards the improvement of the K-band CRF in the South, will resume in 2023.

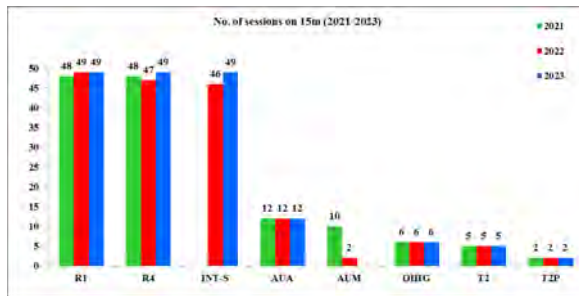

Fig. 2 HartRAO 15-m IVS sessions observed during 2021 and 2022, as well as planned for 2023.

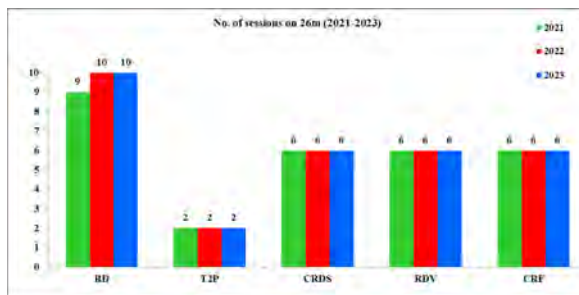

Fig. 3 HartRAO 26-m IVS sessions observed during 2021 and 2022, as well as planned for 2023.

All sessions in 2021 and 2022 continued to be run under remote control whilst the COVID-19 situation slowly returned to normal. VLBI data for all sessions were e-transferred to the correlators as before.

Despite the continued use of remote attendance, the 15-m antenna's reliability was markedly improved during 2021–2022. This was in part due to a long overdue servicing of the dewar o-rings. In 2021, the S/X receiver on the 15 m was brought down to fix the vacuum leaks. It was possible to fix these leaks without removing the heat shield or any components, and therefore it was unnecessary to do a full calibration of the receiver before reinstalling. The main reason for the 15-m antenna's improvement, however, was the introduction of a far more reliable Flexbuf recording system. The most data loss was due to factors beyond our control, such as bad weather and/or external power supply issues. Currently, our biggest challenge to observing is the electricity supply. Although we have backup generators in place, there are occasions where the antennas are interrupted, thus losing some observation time.

Unfortunately, the same cannot be said about the 26-m antenna's reliability over the same period.

Various drive, power supply, and interlock failures plus control system hardware issues resulted in not unplanned downtime. We also ran into at least two disk pack failures. Fortunately, this antenna is less sensitive to external power supply events and usually recovers automatically.

One of the 26-m antenna's BEI encoders failed on November 16, 2022. It was replaced by a similarly aged encoder, dating from 1995, which also did not operate reliably. On November 23, 2022, the BEI was replaced with a 26-bit Heidenhain ROC226 encoder. This is an interim solution, as the west declination shaft bearing is still in need of replacement, thereby delaying the installation of new higher resolution Heidenhain absolute encoders. The performance of the new encoder in relation to the old encoder still needs to be ascertained; however, the 26 m is back to normal operation.

The feedcone cover on the 26-m antenna was replaced on October 10, 2022. The previous cover was already 20+ years old, and its seam ran through the middle and across some of the receivers. Although watertight, the seam allowed water to pocket and possibly affect the receiver temperature at K-band. The replacement cover is wide enough to cover the feedcone without any seams (see Figure 4).

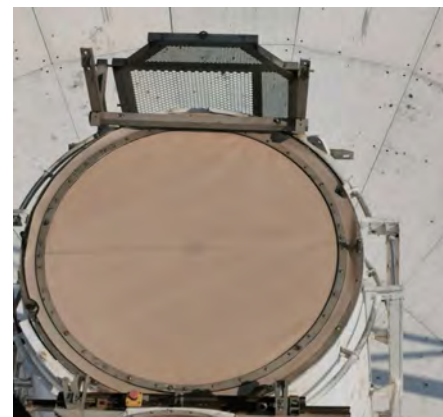

Fig. 4 A brand new cover for the 26-m antenna's feedcone.

4 Personnel

Table 4 lists the HartRAO station staff involved in geodetic VLBI.

Jonathan Quick (VLBI friend) handles all local telescope scheduling issues and provides technical support for the Field System as well as support for hardware problems. During the COVID-19 lockdown, from March 19, 2020 onwards, Jon has been running all geodetic VLBI sessions remotely.

Operations astronomer Aletha de Witt provides support for astrometric VLBI. Alet is the principal investigator for CRF and CRDS IVS astrometric VLBI sessions, as well as for the K-band CRF project. In 2021, Alet was elected as vice president of the IAU Astrometry Commission A1. She is also the chair of the IVS CRF Committee. Alet continued to serve as an at large member on the IVS Directing Board during 2021–2022.

Table 4 Staff supporting geodetic VLBI at HartRAO.

Name	Function	Program
A. de Witt	Operations/ Scheduling	Fundamental Astronomy
J. Quick	Hardware/ Software	Astronomy
S. Blose	Operator	Engineering
P. Mey	Operator	Engineering
R. Myataza	Operator	Engineering
M. Nickola	Logistics/ Operations	Fundamental Astronomy
P. Stronkhorst	Operator	Engineering

5 New Developments

A fully VGOS-capable DBBC3 terminal from Hat-Lab was delivered in early 2021 but was only commissioned in mid-2022 once staff returned to work on site more regularly. Although Yebes Observatory was also appointed to build a complete wide-band VGOS receiver system to match in early 2020, long pandemic-related delays in sourcing the necessary components has pushed out the delivery of the latter, now expected in late 2023.

During 2019 and 2020, plans were put in place and preparation started to improve the performance and enhance the reliability of the 15-m and 26-m antenna systems. There was only limited progress on this refurbishment, mainly due to limited staff availability on site.

Although bids for possible replacement of the 26-m declination shaft bearings, which would probably involve some significant period of downtime, were solicited in 2020, we have as yet been unable to secure funding for this, as it does not have the support of SARA management. We are hopeful of convincing our funding agencies of the critical importance of the 26 m’s continued participation in IVS activities, given that it is one of only a very few antennas in the south and one of only two in Africa forming part of the IVS network (the other being the 15 m). Continuous monitoring of the axial shift on the 26 m is being performed pending a decision. Work will also continue to upgrade the hour angle encoder on the 26-m antenna with a higher accuracy Heidenhain encoder.

To address the increased load-shedding in South Africa, a generator control unit is being tested to start and run the generator before any planned electricity outages. The UPS for the control room and main building will also be upgraded to a solar power system with additional battery capacity.

In August 2021, the VLBA stations Mauna Kea and St. Croix were added to the CRDS network, followed by the addition of the Kunming 40-m antenna in October 2021. Single-baseline astrometric VLBI observations between the HartRAO 26-m and Yebes 40-m antennas were introduced in May 2022, towards increasing the number of north-south baseline observations needed to further improve and maintain the K-band CRF. During 2021 and 2022, emphasis was placed on observing ICRF-3 defining sources in IVS CRDS and CRF sessions. VLBA CRF SX observations taken between April and June 2021 were combined with near-simultaneous CRF observations at K- and Q-band and used to compare images and astrometry for the SX-, K-, and Q-bands in order to study the astrophysical differences and determine the optimal frequency band for CRF observations.

Support for the tracking of arbitrary ephemeris tables by way of cubic spline interpolation was added to the local Field System antenna interface to facilitate the use of the 26-m antenna for spacecraft tracking — a return to its original role some 50 years later! The 26 m was tested for use in a few space missions in collaboration with the South African National Space Agency (SANSA). Due to the 26 m’s sensitivity, it is possible for SANSA to transmit a signal to the satellites using their smaller 12-m antennas and receive the response via a fiber optic link connected to our 26-m antenna.

The power and communication system for a new permanent meteorological system was installed next to the Stevenson screen. Once the comparative study with the current (old) sensors has been completed, the height will be adjusted to measure the barometric pressure at the reference height of the 15-m antenna. We have procured two Paroscientific Model 6000-16B barometers, which are to be mounted at the reference heights of the 26-m and VGOS antennas. To calibrate these multiple barometers (and our off-site GNSS MET4 barometers), we also procured a Paroscientific Model 765-16B Field Barometric Standard.

Progress with the automated site tie continued to be slow due to software issues. We've made some headway with standardizing the reference pier construction as well as the surveying accessories (reference plate, levelling plate, and z-coaxial prism holders—see Figure 5) and can now proceed with initial measurements towards automation.

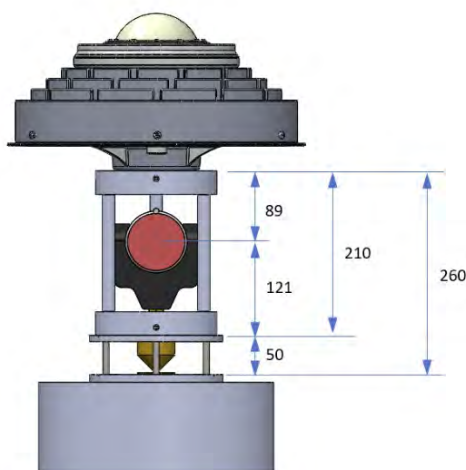

Fig. 5 Automated site tie—typical assembly of a levelling plate and z-coaxial prism holder (Leica GPH1P) with a GNSS antenna (Leica AR25).

6 Future Plans

Of the 202 geodetic VLBI sessions scheduled for 2023, 170 sessions (including 49 Southern Intensive sessions) are allocated to the 15-m antenna, 28 ses-

sions are allocated to the 26-m antenna, and two T2P sessions will be run on both antennas.

Work is still under way to equip the VGOS antenna with an in-house cryogenic receiver that will be used to test and resolve possible interface/control issues before arrival of the broadband VGOS receiver. Preliminary participation in VGOS observations is only expected to begin in early 2024.

Depending on the state of the 26-m antenna declination bearing and the continued monitoring thereof, the utilization of this antenna may have to be decreased to ensure a longer lifespan. A gravitational deformation survey of the 26-m equatorially mounted antenna, initiated by John Gipson and led by Axel Nothnagel in collaboration with Christoph Holst and Agnes Weinhuber from the Technical University of Munich, is planned for 2023.

Plans to further expand the CRDS network, as well as for a SARA0 geodetic correlator facility, are under way. A data paper with details and results of the CRDS observations is to be submitted for publication in 2023. Time was also granted for K-band CRF observations between the Korean VLBI Network (KVN) and the HartRAO and Hobart 26-m antennas for the first semester of 2023. And finally, the IAU Astrometry Commission A1 is planning an Astrometry Focus Meeting at the next IAU General Assembly to be held in Cape Town in 2024.

Acknowledgments

HartRAO forms part of SARA0, which is a national facility operating under the auspices of the National Research Foundation (NRF), South Africa. The Space Geodesy Programme is an integrated program, combining VLBI, SLR, and GNSS, and it is active in several collaborative projects with DLR, ESA, GFZ (Potsdam), GSFC, ILRS, JPL, and «Roscosmos», as well as numerous local institutes. General information as well as news and progress on geodesy and related activities can be found at <http://geodesy.hartrao.ac.za/>.

AuScope VLBI Array and Hobart 26-m Antenna

Lucia McCallum, Jamie McCallum, Tieghe McCarthy, Lim Chin Chuan, Warren Hankey, Ahmad Jaradat, David Schunck, Brett Reid, Boye Zhou

Abstract This is a report on the activities carried out at the University of Tasmania in support of the three AuScope VLBI observatories and the Hobart 26-m antenna in 2021 and 2022. Our current and completed research programs are outlined, as are our planned developments of the array.

1 General Information

The Australian AuScope VLBI array consists of 12-m VLBI telescopes located in Hobart, Tasmania (Hb); Katherine, Northern Territory (Ke); and Yarragadee, Western Australia (Yg). Those three telescopes are in the transition to VGOS sites, with the existing legacy S/X telescopes being equipped with new VGOS receivers and backends. This contribution also covers the Hobart 26-m telescope (Ho). While the telescopes are owned and operated by the University of Tasmania, the Australian IVS observations are contracted through Geoscience Australia. This is done within the *AuScope VLBI Project*, funded through *Positioning Australia*, an initiative of the Australian Government. Funding is secured on five-year cycles, with a renewal of the contract scheduled for the end of 2023.

University of Tasmania, Australia

UTAS, AuScope, Hb, Ho, Ke, Yg, Network Stations

IVS 2021+2022 Biennial Report

2 Component Description

The AuScope VLBI array was initially designed as three identical telescopes with the technical specifications for legacy operations detailed in [2]. Today, Hb and Ke were upgraded to VGOS sites, while Yg remains in legacy S/X configuration with the upgrade planned for 2023. Ho experienced a major structural damage in August 2021, but has recently rejoined some IVS legacy observations.

2.1 Yarragadee 12-m

Yarragadee has continued observing as part of the S/X network throughout 2021–2022, although its upgrade to a VGOS station is planned for early 2023. The system is essentially unchanged, except that the phase calibration unit was decommissioned in early 2021 after an investigation into apparent clock breaks affecting the data. This appears to have been linked to a lack of temperature stabilization in the phase calibration unit, leading to step changes in its performance around sunrise and sunset. With COVID travel restrictions in place, the decision was made to shut it down rather than attempt a repair remotely. The observing system at Yarragadee consists of the legacy S/X receiver with a DBBC2 as sampler, recording to a Mark5B+ unit. Data transfer is via post, with modules or USB-HDDs with a copy of the data being sent to Hobart for further e-transfer. The Internet connection is sufficient for basic remote operations and suitable for high-latency transfers of small test data. Peak rates are approximately 10 Mbps.

2.2 VGOS Stations Hobart12 and Katherine

Late in 2021, the first upgraded 8-input DBBC3 was received at Hobart and put into use to enable the full VGOS mode. Prior to this, we lacked the ability to observe both the A- and B-bands simultaneously. Previous test observations had used a subset of bands to demonstrate fringes, but no useful observations could be made in this configuration. The first full-band VGOS observation occurred in late 2021 which revealed some issues in the phase calibration system causing spurious harmonics.

A major overhaul of the calibration (noise diode and phase cal) systems was undertaken in early 2022 which has greatly improved the performance. In the previous implementation, there were extreme differences in the amplitude with respect to frequency, with low frequencies dominating. The noise diode circuit now includes some gain equalization and the 10-MHz input to the phase cal unit was filtered, improving the pulse sharpness. There is still a variation in strength with frequency, but at a manageable level. Over the course of 2022, tag-along experiments were performed and Hobart12 joined the IVS VO observing program at the end of 2022.

Katherine's upgraded DBBC3 was delivered in September 2022, enabling participation in full VGOS observations. The first tag-along experiment was scheduled for the end of 2022 and we are currently waiting on results, although local baseline fringe tests appear very promising.

The observing system at both Hobart12 and Katherine consists of a dual-linear polarization wideband receiver (2.2–14 GHz), connected to an 8-input DBBC3 and recording to a 36-disk Flexbuff system. Frequencies below 3 GHz are sent over coaxial cable using pre-existing S-band local oscillator for downconversion, while the 3–14 GHz RF is transmitted using RF-over-fiber links to the control room. The output is bandpass filtered to provide three 4 GHz input bands to the DBBC3 sampler (3–7 GHz, 6–10 GHz, and 9.5–13.5 GHz). The 3–7 GHz band goes through an additional splitter, with the additional input enabling the IVS VGOS mode. There are two Flexbuffs in use at Hobart and one at Katherine, each with approximately 288 TB storage capacity. A new, higher capacity Flexbuff is planned for each site in preparation for

the increasing needs of VGOS experiments. In Hobart, data is e-transferred from the site, using a 10-Gbps link to the University and then over a shared multi-Gbps link to the Australian Research Network (AARNet) on the mainland and wider Internet. While variable, typical performances are on the order of hundreds to thousands Mbps, both inwards and outwards.

2.2.1 Mixed-mode Configuration

As mentioned above, the S-band from the receivers is made available in the control room through the previous S/X system's downconverter. These IF signals (at 300–400 MHz) are connected to the DBBC3 inputs through a remotely controllable RF switch. This allows us to swap between either the 3–7 GHz band or the downconverted S-band as the input to the first two modules of the DBBC3. This system was first implemented at Katherine following the failure of the DBBC2 but was adopted for Hobart12 soon afterwards. This system is considerably easier to monitor and control than the previous implementation, where the S-band was recorded using a separate DBBC2. The DBBC3 in use now supports the DDC.U firmware and the flexible bandwidth selection this supports. As such, we are now able to observe in the typical R1/R4 modes with only the lack of the LSB channels, and a doubling of the recorded data volume due to the dual-polarization.

2.3 Hobart26

The Hobart 26-m telescope was largely out of service during 2021–2022, following a failure of the X-axis bearing in July 2021. Carrying out the repairs proved to be a considerable challenge but were successfully completed in November 2022. Unfortunately, several other components of the receiver and backend systems suffered during the prolonged outage and we have seen some issues with sensitivity and stability affecting data from late 2022. We hope to be able to restore the Hobart26 to its previous performance early in 2023 and for it to continue its contributions to the IVS observing program. The recording system consists of the original RCP-only S/X receiver, sampled through a DBBC2 and recorded by a Mark5B+ recorder. Data

Table 1 Staff and their responsibilities.

Name	Role	Topics
Jamie McCallum	AuScope array manager	Operations & Development
Warren Hankey	Technical support	Technical support and data transfers
Brett Reid	Observatory manager	Maintenance, repairs, and implementation of new systems
Eric Baynes	Technical support	Electronics specialist, part-time
Peter McCulloch	Technical support	VGOS RF-design, part-time
Lucia McCallum	AuScope scientist	research, AOV secretary, part-time
Guifré Molera Calvés	Post-doc	systems development, until 01/2022
Tiege McCarthy	Post-doc	project work, correlation
Boye Zhou	Post-doc	research, since 07/2022
Lim Chin Chuan	PhD student	research, dynamic observing
Ahmad Jaradat	PhD student	research, VGOS
David Schunck	PhD student	research, satellite VLBI
AuScope observers		about 12 regular observers

is e-transferred from the site, using a 10-Gbps link to the University and then over a shared multi-Gbps link to the Australian Research Network (AARNet) on the mainland and wider Internet. While variable, typical performances are on the order of hundreds to thousands Mbps, both inwards and outwards.

3 Staff

Routine operations, maintenance, and development are undertaken by a few staff members, while experiment monitoring is usually carried out by PhD students. All staff are affiliated with the University of Tasmania in Hobart, where we have also established a small research group. Table 1 summarizes the current staff and their responsibilities.

4 Current Status and Activities

During 2021 the AuScope array participated in 168 IVS-scheduled 24-hour sessions, with the number increasing to 190 in 2022. Yarragadee was supporting the bulk of these experiments with regular participation in all R1 and R4 sessions except during the Christmas–New-Year shutdown period.

4.1 VGOS Upgrade

The Hobart wide-band receiver was permanently installed in 2017, with Katherine following in late 2019. A fully VGOS-compatible system was finally established in early 2020 after the first 4-input DBBC3 system arrived at Hobart and put into service. After the phase calibration system was redesigned in early 2022, commissioning observations were carried out for Hobart12 and commenced for Katherine in late 2022. Yarragadee’s upgrade is still pending, but is planned for the second quarter of 2023, following the arrival of the final upgraded DBBC3.

4.2 VGOS Observations

We are also carrying out our own Hobart12–Katherine fringe tests and experiments to both test the systems and investigate the potential of alternative frequency sequences. As the phase calibration system was unfit for use at Katherine until late in 2022, these observations have used a manual phase calibration approach where the single-band delay per sampler is calibrated prior to the wideband fit. Additionally, a priori dTEC information is needed which we have taken from global TEC maps. The results appear stable and accurate, looking at baseline length repeatabilities. Over the course of 2022, these sessions were enhanced with the participation of the Ishioka telescope and now use the phase calibration system.

4.3 Mixed-mode Observing

Mixed-mode sessions were a high priority during the past two years. The major aim was to bring Hb and Ke back into the IVS (legacy S/X) network, with regular routine operation. In Australia, we understand mixed-mode as such, that Hb and Ke essentially mimic the S/X mode, with the only difference that they are recording dual-linear polarization signals instead of the right-hand circular polarization used in legacy S/X IVS observing. Further details are given in [3], following an extensive mixed-mode series as part of the AUSTRAL observing program.

4.4 AUSTRAL Sessions

AUSTRAL sessions [4] are an important part of the AuScope project. On the one hand, organizing these sessions ensures to maintain knowledge and capabilities of all stages of VLBI (*from scheduling through analysis*), and on the other hand we believe that by increasing our observing cadence we have a better chance to make improvements in automation, data volume, storage and processing etc., that are needed for VGOS. While the Australian mixed-mode sessions (AUM) represented the majority of the AUSTRAL sessions over the past two years, AUA sessions are also ongoing at a monthly cadence. The AUSTRAL program is kindly supported by the stations in HartRAO and Warkworth, as well as DACH for some of the scheduling. All AUSTRAL sessions are part of the IVS program with the data made available through standard channels.

4.5 Southern Intensives

Since 2021, the Southern Intensive sessions [1] have been operationally observed on the Hart15M–Hobart12 baseline. These *Intensive*-style sessions are of one-hour duration, and processed and submitted with low latency. A good data connection between Hobart and HartRAO as well as achievements in automation typically allow for the data to be fully transferred from HartRAO in an hour or so. Correlation and post-processing was typically performed during

office hours the next day, for a turnaround time of less than 24 hours.

4.6 Dynamic Observing

The *Dynamic Observing* project covers work on automating the AuScope operation and observing procedures to increase the session throughput and improve the observing efficiency. The automation is realized through the fully developed tool *Dynob*. The performance of the AuScope telescopes in most AUM sessions was monitored, together with the flux density for all observed sources. New AUM sessions are expected to be scheduled with the monitored antenna sensitivity and source flux densities for improved a priori signal-to-noise ratio prediction. Continuous observation is still needed to yield more data and identify room for improvement. The *Dynob* tool has now been tested with our weekly southern Intensive sessions to improve the turn-around time. The processing of these sessions until Level-1 vgosDB is now achievable with one click after all data have arrived from Hartebeesthoek. The processing latency is about one hour. *Dynob* fully supports legacy S/X, mixed-mode, and VGOS observations at flexible frequency ranges.

4.7 Correlation

As of early 2022, UTAS has secured additional funding, through Geoscience Australia (GA) as part of the Positioning Australia project, to establish an Australian VLBI Correlation Center. This Correlation Center will initially aim to service the VLBI correlation needs of Australia and the Asia-Pacific region; however, the ultimate goal is to become recognized by the IVS as an official international Correlation Center. The backbone of this center is Gadi, a high performance computing (HPC) system hosted by the National Computational Infrastructure (NCI) in Canberra, Australia.

Initial testing show that this HPC can readily handle geodetic VLBI correlation workloads, with exceptional compute and data I/O performance. The primary challenge of this project is data logistics and transport, particularly for VGOS data volumes, due to the facility not being directly run by UTAS (unlike our current cor-

relation infrastructure). The fact that it is not a UTAS run facility has created two issues: the first is that shipping data directly to the HPC is not feasible (due to lack of staff and/or data ingest infrastructure), and the second is that nominally transferring data to Gadi is restricted to approved NCI accounts that are members of the project. To accommodate for e-transfer to the center, we have created a dedicated e-transfer virtual machine using the NCI Nirin cloud infrastructure. The virtual machine allows us to configure our own security rules, allowing for incoming UDP and TCP from IP addresses that we approve, and lets us mount the same storage allocation that is accessible to Gadi. This allows data to be e-transferred to the center by external partners that can be directly managed by UTAS geodesy staff. As not all stations are currently capable of e-transfer to Correlation Centers, including our remote stations in Katherine and Yarragadee, we are working on a data relay station based out of Geoscience Australia's headquarters in Canberra. This relay station will allow data disk packs to be shipped in, where they will be subsequently e-transferred over onto our Gadi storage allocation. Ideally, this solution will become less necessary moving into the future as e-transfer capability is expanded; however, currently it is necessary to begin production correlation at this center in the near future. Once this relay station is implemented, larger scale testing and validation of the whole correlation pipeline can be undertaken.

4.8 VLBI Satellite Tracking

Funded by the Australian Research Council (ARC), at UTAS we investigate VLBI observations to satellites, aiming for improved space ties. Current work covers the technical realization of such observations (*pipeline from scheduling to analysis*) as well as simulation studies.

5 Future Plans

The next priority for the AuScope project is the VGOS upgrade of Yg, planned for the first part of 2023. In terms of observations, our in-house AUV VGOS pro-

gram will be extended and we have also started AUJ sessions with participation of the Ishioka telescope.

5.1 High-speed Data Connections

The transition to the VGOS backend has emphasized the current limitations of our data transport via shipping, and highlighted the need for better e-transfer capabilities. Funding has been sought to install 10-Gbps fiber optic connections to both the Katherine and Yarragadee sites and prospects are good that this will go ahead in 2023, with both links operational by the end of 2024. Having access to high speed data transfer should greatly reduce the latencies involved in data transport and improve their reliability.

Acknowledgements

The AuScope VLBI operations are contracted through Geoscience Australia. Parts of this work are supported by the Australian Research Council ARC, through a DECRA award (DE180100245). We thank the University of Tasmania for co-funding of PhD scholarships.

References

1. S. Böhm et al., "Probing a southern hemisphere VLBI Intensive baseline configuration for UT1 determination", *Earth, Planets and Space*, 74:118, <https://doi.org/10.1186/s40623-022-01671-w>, 2022.
2. J. Lovell et al., "The AuScope geodetic VLBI array", *Journal of Geodesy*, 87, doi:10.1007/s00190-013-0626-3, 527–538, 2013.
3. L. McCallum et al., "The Australian mixed-mode observing program", *Journal of Geodesy*, 96:67, <https://doi.org/10.1007/s00190-022-01657-2>, 2022.
4. L. Plank et al., "The AUSTRAL VLBI observing program", *Journal of Geodesy*, doi:10.1007/s00190-016-0949-y, 2016.

Ishioka Geodetic Observing Station 2021–2022 Report

Masafumi Ishigaki¹, Hiroyuki Yoshifuji¹, Yu Takagi¹, Tomokazu Nakakuki¹, Masaki Honda¹, Katsuhiro Mori¹, Yudai Sato¹, Saho Matsumoto¹, Haruka Ueshiba¹, Kyonosuke Hayashi¹, Toru Yutsudo¹, Kentaro Nozawa²

Abstract This report summarizes the recent activities of the Ishioka Geodetic Observing Station, which is operated by the Geospatial Information Authority of Japan. In the latest two years, it has contributed to both S/X and VGOS observations coordinated by IVS. In 2021 and 2022, it also participated in several experimental observations, such as a mixed-mode test session, to investigate the possibility for S/X observations with the broadband feed.

1 General Information

The Ishioka Geodetic Observing Station (Figure 1, hereafter Ishioka station) is located at approximately 70 km to the northeast of Tokyo and 17 km to the northeast of the headquarters of the Geospatial Information Authority of Japan (GSI) in Tsukuba (Figure 2).

The Ishioka 13.2-m radio telescope started observation in 2015 as a successor of the Tsukuba 32-m telescope which used to be in Tsukuba. Ishioka station is operated by GSI and has the 13.2-m radio telescope which fills VGOS requirements. It has participated in S/X sessions coordinated by the IVS and is also involved in VGOS sessions as one of the VGOS stations.

1. Geospatial Information Authority of Japan

2. Advanced Engineering Service Co., Ltd.

Ishioka Network Station

IVS 2021+2022 Biennial Report



Fig. 1 The Ishioka 13.2-m radio telescope in the Ishioka Geodetic Observing Station.

2 Component Description

The specifications of the Ishioka 13.2-m radio telescope are summarized in Table 1. Ishioka station has two types of feeds: tri-band feed and QRFH feed. We use these two feeds depending on the types of observation; tri-band feed for legacy S/X observation and QRFH feed for broadband observation. We switch the feeds and adjust the equipment according to the type of



Fig. 2 Location of Ishioka station.

observation. It usually takes approximately one week for the adjustment.

A signal detected with the feeds is recorded in the following way for both of the S/X and VGOS observation. First, the signal is amplified and converted to an optical signal to be delivered to the observation room next to the telescope through the optical fiber. Then, the electrical signal is reproduced by E/O converters and down-converted to intermediate frequency. Finally it is digitalized and recorded on storage devices. The telescope and other equipment are controlled by Field System ver. 9.10.5 (FS9).

3 Staff

Ishioka station is operated by seven staff members belonging to the GSI VLBI group and is a contracted operation staff as of December 2022. In April 2021 and 2022, there was a personnel change in our group. The member list is shown in Table 2.

Table 1 Specifications of the Ishioka 13.2-m radio telescope.

Parameter	Ishioka 13.2-m radio telescope
Owner and operating agency	GSI
Latitude	N 36° 12' 33"
Longitude	E 140° 13' 8"
Altitude	112.8 m
Year of construction	2014
Radio telescope mount type	Az-El
Antenna optics	Ring focus
Diameter of main reflector	13.2 m
Azimuth range	180° ± 250°
Elevation range	0–100°
Azimuth drive velocity	12°/sec
Elevation drive velocity	6°/sec
Tsys at zenith (X/S)	50 K / 300 K
Tsys at zenith (Broadband)	H-pol: ^{*1} 141 K (3 GHz band) 191 K (5 GHz band) 252 K (6 GHz band) 397 K (10 GHz band) V-pol: ^{*2} 141 K (3 GHz band) 181 K (5 GHz band) 264 K (6 GHz band) 377 K (10 GHz band)
SEFD (X/S)	1950 Jy / 1750 Jy
SEFD (Broadband)	H-pol: ^{*1} 1580 Jy (3 GHz band) 1978 Jy (5 GHz band) 2154 Jy (6 GHz band) 3695 Jy (10 GHz band) V-pol: ^{*2} 1567 Jy (3 GHz band) 2083 Jy (5 GHz band) 2122 Jy (6 GHz band) 3079 Jy (10 GHz band)
RF range (X)	8192–9104 MHz
RF range (S with BPF)	2170–2425 MHz
RF range (Broadband with BPF)	2–14 GHz
Recording terminal	ADS3000+ sampler & K5/VSI data recording terminals
Data capacity	89 TB
Hydrogen maser	VCH-1003M (VREMYA-CH)

¹The average value in observing frequency band for VGOS observation (3 GHz band: 3000.4–3480.4 MHz, 5 GHz band: 5240.4–5720.4 MHz, 6 GHz band: 6360.4–6840.4 MHz, 10 GHz band: 10200.4–10680.4 MHz).

²Tsys and SEFD of V-polarization had not been measured since January 2020 because of receiver damage. After replacing the LNA in March 2022, it became possible to measure them again. See also Section 4.2.2.

Table 2 Member list of the GSI VLBI group in 2021 and 2022.

Name	Main Function
2021	
Yudai Sato	Supervisor
Toru Yutsudo	Management
Katsuhiko Mori	Observation facility management & Local-tie survey
Yu Takagi	Research
Kyonosuke Hayashi	Research
Haruka Ueshiba	Operation & Local-tie survey
Tomokazu Nakakuki	Operation & Research
Saho Matsumoto	Operation & Research
Kentaro Nozawa	Operation (AES)
2022	
Yudai Sato	Supervisor
Masaki Honda	Management
Katsuhiko Mori	Observation facility management & Local-tie survey
Yu Takagi	Research
Tomokazu Nakakuki	Research
Masafumi Ishigaki	Operation & Research
Hiroyuki Yoshifuji	Operation & Research
Kentaro Nozawa	Operation (AES)

4 Current Status

4.1 Observation

Ishioka is basically automated and operated remotely from the GSI headquarters in Tsukuba. The unmanned operation takes place each weeknight and every weekend, and error e-mails are sent to operators in case of emergency. After the spread of COVID-19, the operators occasionally work from home and monitor the status of Ishioka remotely.

4.1.1 S/X Observation

Ishioka station participated in S/X sessions from May 2021 to March 2022 and also from October to December in 2022 (Table 3). It was mainly involved in one-hour sessions for determining dUT1 and 24-hour sessions for obtaining EOPs. AOV sessions were conducted once a month in mixed-mode, which are designed for enhancing positioning accuracy in the Asia-Oceania region. GSI contributed to all the sessions as

an observing station and also about one-third of the sessions as a scheduler in cooperation with SHAO and UTAS.

In September 2022, Ishioka also participated in a mixed-mode test session. In this session, some of the VGOS stations including Ishioka joined the S/X session to investigate the feasibility of cross-correlation between circular and H-V polarizations. If the mixed-mode observation becomes feasible, it is quite beneficial for Ishioka because we do not have to switch the feed between S/X observation and VGOS observation periods. A fringe was not detected in the test session, so it is necessary to investigate the cause for further progress.

4.1.2 Broadband Observation

Ishioka station was involved in the broadband observation with the QRFH feed from January to April in 2021 and from April to September in 2022. It participated in VGOS-O sessions weekly and also observed one-hour Intensive sessions, INT-B and INT-C, with Onsala (ONSA13NE and ONSA13SW) every Saturday and Sunday.

Table 3 Number of regular sessions in 2021 and 2022 Ishioka participated in.

	Sessions	2021	2022
S/X	IVS-R1	14	21
	IVS-R4	16	20
	IVS-T2	3	2
	APSG	1	–
	AOV	5	11
	AUA	–	1
	IVS-CRF	2	1
	IVS-INT1	15	9
	IVS-INT2	28	40
	IVS-INT3	15	18
	IVS-R&D	2	4
	Total	101	127
	VGOS	VGOS-O	11
VGOS-B		5	42
VGOS-C		4	38
VGOS-W		–	4
VGOS-R		–	3
Total		20	111
Total		121	238

4.2 Troubles

We briefly report on the troubles which had a large impact on the operation of Ishioka station. See [1] for more details of the troubles.

4.2.1 Trouble in Motor Encoder

From May through November 2021, Ishioka didn't participate in many of the sessions due to antenna troubles. The antenna suddenly stopped during observation because of an error of the servo amplifier for the elevation drive motor. It was caused by contact failure of the motor encoder. During investigation of the encoder, we had participated in observation as much as possible with slow slew speed (EL 3 deg/sec). It stopped frequently in spite of the slow speed, so it was necessary to monitor the telescope during the observation. We restarted the observation with normal slew speed (EL 6 deg/sec) in November 2021, so it took more than five months to return to normal operations.

4.2.2 Internal Noise due to LNA

Noise in the V-polarization had caused a serious problem in Ishioka station since January 2020. Detailed investigation revealed that the LNA on the VGOS receiver was broken and generated the noise. After replacing the LNA, we successfully detected a clear fringe in a test session between Onsala and Ishioka in March 2022.

4.3 Local-tie Survey

At Ishioka station, GNSS Continuously Operating Reference Stations (GNSS CORSs) are also operated, and one of them is registered as an IGS station. We regularly conduct local-tie surveys to determine the local-tie vector between the VLBI antenna and the GNSS antenna (Figure 3), which contribute to the ITRF construction. The first local-tie survey in Ishioka station was conducted in 2016, and it has been done once a year since 2018. In 2021 and 2022, we adopted the *Inside method* in the local-tie survey. In the *Inside method*, we set a total station inside the azimuth cabin

and measure the distance between the total station and mirrors attached on the wall of the cabin. See [2] for more details of the method.

We submitted the result of the local-tie surveys to IERS. Ishioka was registered as one of the IERS stations for the first time in 2021.

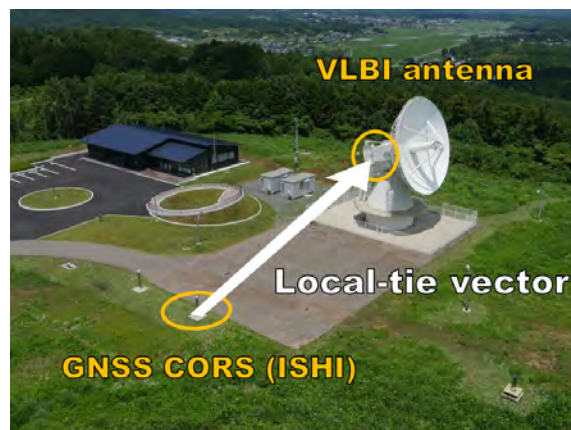

Fig. 3 VLBI-GNSS local-tie in Ishioka station.

4.4 Update of Backends in Ishioka

We are planning to update backend recorders and storage servers in Ishioka. As described in Section 2, we have used an ADS3000+ sampler and a K5/VSI data recording system. They have been used for many years, and some parts of the system need to be renovated. In addition to that, a recording system with larger storage is required because the cadence of VGOS observation has been increased recently. We are preparing for introducing a DBBC3, Flexbuff, and new storage as a replacement for the current system. The new storage has 1.5 PB, which is three times larger than the present one. They will be installed in the spring of 2023.

5 Outlook

Ishioka station will continue to participate in the S/X and the VGOS observation coordinated by IVS. We will install a new sampler DBBC3, recording system

Flexbuff, and new large-volume storage for our operating system. In addition, we will continue to conduct local-tie surveys regularly.

References

1. Matsumoto, S., T. Nakakuki, T. Yutsudo, H. Ueshiba, Y. Takagi, K. Hayashi, K. Mori, Y. Sato, T. Kobayashi, Status of the Ishioka VLBI station for the past two years, IVS 2022 General Meeting Proceedings, edited by Kyla L. Armstrong, Dirk Behrend, and Karen D. Baver, NASA/CP-20220018789, pages 56-58, 2023.
2. Matsumoto, S., H. Ueshiba, T. Nakakuki, Y. Takagi, K. Hayashi, T. Yutsudo, K. Mori, Y. Sato, T. Kobayashi, An effective approach for accurate estimation of VLBI–GNSS local-tie vectors, *Earth, Planets and Space* volume 74, article number 147, 2022.

Status Report of Koganei 11-m VLBI Station for 2021–2022

Mamoru Sekido

Abstract The Koganei 11-m station participated in T2, APSG, and AOV sessions conducted by the IVS and Asia-Oceania VLBI Group for Geodesy and Astrometry (AOV)¹. The antenna's operations were interrupted from May to August 2021 due to multiple troubles. We fixed the causes of these problems by ourselves and resumed observation in August 2021. The trees adjacent to the antenna are suspected to be a cause of lower SNR in X-band. At the end of 2022, pruning the trees and bamboos around the station was performed. We now expect productivity improvement in IVS sessions in 2023. We confirmed strong radio frequency interference (RFI) for S-band receiver. We are planning to insert a bandpass filter in front of LNAs to mitigate the RFI, even though this will cause an increase in the receiver noise temperature.

1 General Information

The Koganei 11-m diameter VLBI station is operated by the geodesy group of the Space-Time Standards Laboratory (STSL) of the National Institute of Information and Communications Technology (NICT). The antenna site is located at the northern campus in the headquarters of NICT in Koganei, Tokyo (Figure 1). These 11-m VLBI antennas were built together with three other VLBI stations for the Key Stone Project (hereafter referred to as KSP). The aim of the KSP [1]

National Institute of Information and Communications Technology

NICT Koganei-11m Network Station

IVS 2021+2022 Biennial Report

¹ <https://auscope.phys.utas.edu.au/aov/index.html>

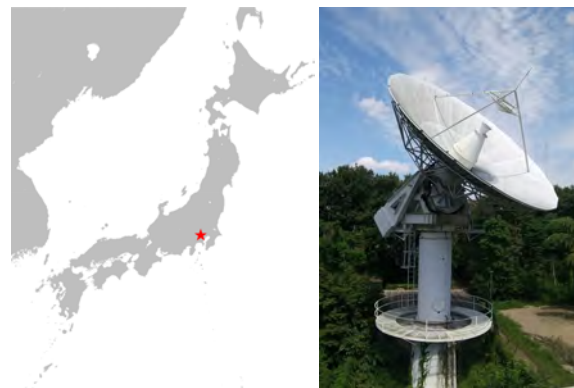

Fig. 1 Left: Location of NICT-Koganei. Right: Koganei 11-m VLBI station.

was monitoring crustal deformation around the Tokyo metropolitan area by using multiple space geodetic techniques: VLBI, GPS, and SLR. That project was operated in the period between 1995 and 2001. After the KSP project was terminated in 2001, two 11-m antennas at Miura and Tateyama were transferred to Gifu University and Hokkaido University, respectively, for radioastronomy. The two antennas of Kashima and Koganei had been used as a tool for technology developments and participated in international and domestic geodetic VLBI observations. Unfortunately, the Kashima 11-m antenna was damaged in May 2019 by rain water leakage to the waveguide system including the LNAs. That happened through holes in the feedome membrane, which might have been made by the pecking of birds. In September of the same year, the Kashima 34-m antenna was seriously damaged by the strong winds of typhoon Faxai [3]. Finally, the Kashima 34-m and 11-m antennas were dismantled in 2020 [4]. And the Kashima Space Technology Center

VLBI group, which had contributed to Japanese VLBI technology development since the 1970s, was formally dissolved in March 2021.

The remaining Koganei 11-m antenna is continuing VLBI observations, participating in the IVS and AOV sessions.

2 Component Description

2.1 Koganei 11-m Antenna

Parameters of the Koganei 11-m antenna are listed in Table 1.

Table 1 Specification of the Koganei 11-m antenna. The system temperature and SEFD values at S-band are not listed, because the measurement values are not appropriate due to RFI.

Mount Type	Azimuth / Elevation
Diameter [m]	11.0
Optics	Cassegrain
Slew Speed [deg/sec]	Az: 1.0 / El: 1.0
Az/El Range [deg]	Az: 90.0–630.0 / El: 7.0–89.0
Receiving Freq. [MHz]	S: 2,212–2,360 X-1: 7,700–8,200 X-2: 8,100–8,600
Local Freq. [MHz]	S: 3,000 / X-1:7,200 / X-2: 7,600
Typical T_{sys} [K]	S:– / X: 110
Typical SEFD [Jy]	S:– / X: 5000
Aperture Efficiency [%]	approx. 60

The System Equivalent Flux Density (SEFD) values depicted in Figure 2 show that the performance of the X-band receiver system has not significantly degraded since 2014. Those for S-band scattered since 2020, and it may represent that the radio frequency interference (RFI) to S-band receiver system became more severe since then. More detail on the status of the S-band receiver is discussed later in this paper.

2.1.1 Maintenance Events

Increase of drive resistance

Antenna operations were frequently interrupted by a thermal relay trip in May 2021. It was caused from an increase of mechanical resistance of the azimuthal roll

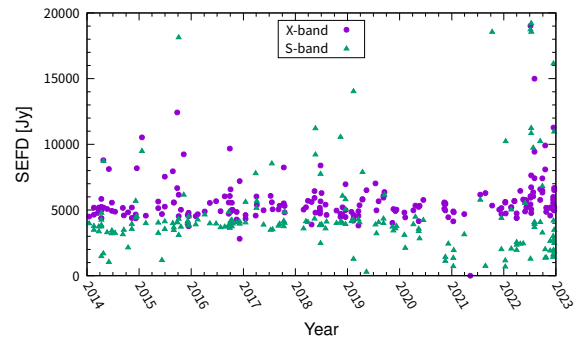

Fig. 2 SEFDs of S/X-band are plotted for the period 2014–2022.

bearing, which enabled smooth azimuthal rotation with supporting all antenna weight. The Koganei 11-m antenna has been working with a high utilization rate for VLBI and STEREO downlink data acquisition. However, maintenance work for the mechanical greasing was stopped in 2016 due to a shortage in the budget. We did the greasing of the Az/El bearing and exchanging the transmission lubrication oil ourselves. Finally, mechanical resistance was reduced, and the issue of thermal relay trip was solved in early summer of 2021. During the period from May to July, we stopped antenna operations and IVS observations.

Damage caused by thunderstorm

A strong thunderstorm hit the Koganei region on 30 July 2021. Lightning strikes in the storm damaged the Azimuth encoder, antenna controller unit (ACU), and DC power amplifier (DCPA). Fortunately, we have spare parts for these devices; we replaced the damaged equipment and resumed antenna operations on 12 August 2021.

2.1.2 X-band

Although the receiver performance at X-band does not show obvious changes, IVS Correlation Centers have reported that the fringe detection rate of the Koganei 11-m station was degrading in recent years. Since the antenna site is surrounded by tall trees, one possible cause is the blocking of the line of sight by the trees. Though the antenna height was 12.5 m, which was raised up by additional foundation, the surrounding



Fig. 3 Panoramic view around the Koganei 11-m antenna in February 2023. The picture covers 0–180 degrees (upper panel) and 180–360 degrees (lower panel) of azimuthal direction.

trees were even taller than the antenna. We performed tree pruning at a 40-m radius circular area around the antenna in the winter of 2021. Additional pruning was conducted for an extended area at the end of 2022 by another unrelated project, by chance. Figure 3 displays the panoramic view around the Koganei 11-m antenna after the pruning.

System temperature (T_{sys}) contour maps of the sky before (12 September 2022) and after (21 December 2022) the pruning are presented in Figure 4. Higher temperatures below 20 degrees of elevation in the top panel represents that line of sight was blocked at low elevation angle. T_{sys} was significantly reduced for east-south directions after the pruning, although trees in the west were not reduced sufficiently. Then T_{sys} is still high below 20 degrees of elevation in the west direction. For improving the productivity of VLBI sessions, we are going to submit revised horizontal mask information to the IVS to adjust observation schedules. Since T_{sys} is approximately expressed by linear combination of optical thickness τ and temperature T_{atm} of the atmosphere by the following equation:

$$\begin{aligned} T_{\text{sys}} &= T_{\text{rx}} + T_{\text{atm}}[1 - \exp\{-\tau/\sin(EI)\}] \\ &\simeq T_{\text{rx}} + T_{\text{atm}} \cdot \tau/\sin(EI), \end{aligned} \quad (1)$$

receiver noise temperature T_{rx} and τ can be estimated by assuming the atmospheric temperature (here we as-

sumed 200 K for atmosphere at several km height). The bottom panel of Figure 4 shows the T_{sys} plot versus $1/\sin(EI)$ for the east direction, where sky clearance was improved after tree pruning. Although the reason of deviation of data from linear trend at $EI=60$ and 90 degrees is not known yet, the model of Equation 1 gives a fairly good approximation of data. That implies that the antenna is observing the sky without blockage at high to low elevation angles.

Antenna operation time is shared with the Space Environment Laboratory (SPEL). When the antenna is free from VLBI observation, the down-link signal of the STEREO satellite² is acquired for the monitoring of solar activity.

2.1.3 S-band

The pruning of trees surrounding the antenna improved the environment at S-band as well. Figure 5 compares S-band T_{sys} maps on the sky before and after the pruning. Decreasing temperature in the southeast direction was observed. However, the T_{sys} and SEFD measurements are unstable, and it is attributed to RFI.

We investigated LNA output in January 2022, and found serious contamination of radio frequency envi-

² http://www.nasa.gov/mission_pages/ster eo/main/index.html

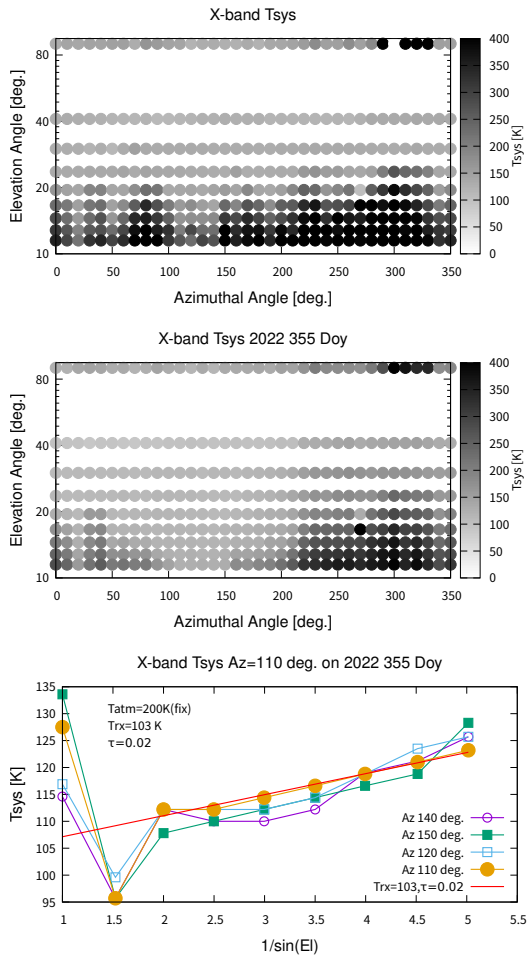

Fig. 4 Contour map of X-band T_{sys} in the sky before (top) and after (middle) the tree pruning in 2022. Bottom: Plot of T_{sys} (X-band) vs $1/\sin(EI)$ gives estimate of optical thickness τ and Receiver noise temperature (T_{rx}).

ronment in S-band. Figure 6 shows LNA is working at a non-linear region and is generating a fourth-order mutual modulation of signal at 2.11–2.17 GHz (hereafter referred to as 'fa') and at 2.55–2.57 GHz, 2.60–2.64 GHz (hereafter referred to as fb). These signals are assumed to be coming from the base station for mobile phones. This sort of serious condition is due to the location of Koganei station in the metropolitan area of Tokyo, and it could be one of the worst-case locations of any IVS station in the world. We are planning to introduce a bandpass filter to mitigate the saturation of S-band LNA.

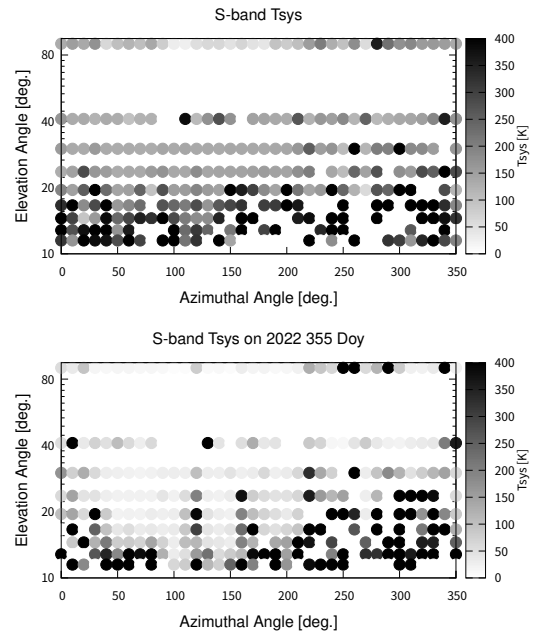

Fig. 5 S-band T_{sys} sky map before (top: 12 September 2022) and after (bottom: 22 December 2022) tree pruning.

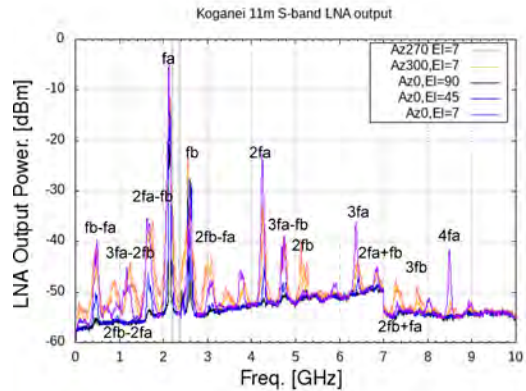

Fig. 6 The S-band LNA output of the Koganei 11-m antenna measured on 14 January 2022. Two strong signal at 2.11–2.17 GHz (referred to as 'fa') and 2.55–2.57 GHz & 2.60–2.64 GHz (referred to as 'fb') are generating mixed harmonics up to the fourth order.

2.2 Data Acquisition Systems

Data acquisition for legacy mode geodetic VLBI sessions is performed with four units of the K5/VSSP32 [5] system, where each unit has four video signal inputs. Observed data is recorded on a standard Linux

file system in K5/VSSP32 format³. Then, format conversion from the K5/VSSP32 to Mark-5B is performed by using the K5/VSSP32 software tool⁴. All the VLBI data acquired by NICT were exported to Correlation Centers over a 10-Gbps network provided by the High Speed R&D Network Testbed JGN.

The IVS and AOV sessions observed by the Koganei 11-m antenna are listed in Table 2.

Table 2 VLBI sessions for Koganei 11-m stations in 2021–2022.

Year	2021: 14 sessions	2022: 21 sessions
IVS & AOV	T2P144, AOV055, T2145, T2146, AOV059, T2147, AOV061, APSG48, T2148, APSG49, AOV064, T2149, T2P150, AOV066	T2P151, AOV067, AOV068, AOV069, T2152, AOV070, T2153, AOV071, AOV072, APSG50, T2154, AOV073, AOV074, T2155, AOV075, T2156, AOV076, AOV077, T2P157, AOV078, APSG51

3 Staff

SEKIDO, Mamoru (STSL): Working on operation and maintenance of the Koganei 11-m antenna.

ICHIKAWA, Ryuichi (STSL): Working on operation and maintenance of the GNSS station and gravimeter.

ISHIBASHI, Hiromitsu (SPEL): Working on operation of the 11-m antenna for acquiring STEREO downlink data. Supporting maintenance work of the 11-m antenna.

4 Future Plans

The Koganei 11-m antenna will keep operations to participate in IVS and AOV VLBI sessions. The modification of the S-band receiver system to mitigate the RFI is an important task to be performed.

³ https://www2.nict.go.jp/sts/stmg/K5/VSSP/vssp32_format.pdf

⁴ <http://vlbi.sci.ibaraki.ac.jp/K5WWW/index-e.html>

4.1 Local Tie Information

Responding to the call for participation to ITRF2020, local survey data for 1996–1999 and 2013 were submitted to the ITRF Combination Center in 2021 [2].

A new local survey was conducted in 2022 by a project of another group (Space communication system laboratory) of NICT. This survey contains locations of the 11-m VLBI station, a 1.5-m optical SLR telescope, a KSP-SLR telescope, and an IGS station. The survey data is still in the process of compilation. After summarizing the local tie information, it will be submitted to the IERS for the future improvement of the ITRF.

Acknowledgements

We thank the High-Speed R&D Network Testbed JGN and the Information System Section of NICT for supporting the high-speed network environment. Our e-transfer of VLBI data is enabled by JGN and APAN (Asia Pacific Advanced Network).

References

1. Special issue for the Key Stone Project, J. Commun. Res. Lab., Vol. 46, No. 1, pp. 1–221, 1999. Available at: https://www.nict.go.jp/publication/journal/46/001/Journal.Vol46.SI.No001_index.pdf
2. Sekido M., and E. Kawai, Kashima 11-m and Koganei 11-m VLBI Stations, in International VLBI Service for Geodesy and Astrometry 2019+2020 Biennial Report, edited by D. Behrend, K. L. Armstrong, and K. D. Baver, NASA/TP-20210021389, 2021.
3. Sekido M., Kashima 34-m Antenna: Damaged by Typhoon No.15 (Faxai), 2019, IVS NICT-TDC News. No. 38, pp. 30, https://www2.nict.go.jp/sts/stmg/ivstdc/news_38/pctdc_news38.pdf, 2019.
4. Sekido M., Kashima 34-m Antenna Closing Ceremony, IVS NICT-TDC News. No. 39, pp. 41–42, https://www2.nict.go.jp/sts/stmg/ivstdc/news_39/pctdc_news39.pdf, 2021.
5. Kondo, T., Y. Koyama, R. Ichikawa, M. Sekido, E. Kawai, and M. Kimura, Development of the K5/VSSP System, J. Geod. Soc. Japan, Vol. 54, No 4, pp. 233–248, 2008.

Kokee Park Geophysical Observatory

Chris Coughlin

Abstract This report summarizes the technical parameters of the VLBI systems at the Kokee Park Geophysical Observatory and provides an overview of the activities that occurred in 2021–2022.

1 Location

The Kokee Park Geophysical Observatory (KPGO) is located in Kokee State Park on the island of Kauai in Hawaii at an elevation of 1,100 meters near the Waimea Canyon, often referred to as the Grand Canyon of the Pacific. KPGO is located on the map at longitude 159.665° W and latitude 22.126° N.

2 Technical Parameters

The 20-m receiver is of NRAO (Green Bank) design (a dual polarization feed using cooled 15 K HEMT amplifiers). The antenna is of the same design and manufacture as those used at Green Bank and Ny-Ålesund. A Mark 5B+ recorder is currently used for all data recording.

The 12-m receiver is of MIT design. The ultra wide-band receiver uses a Quadruple-Ridged Flared Horn (QRFH) and LNAs, developed at the California Institute of Technology, cooled to ~ 15 K and is dual polarization. The antenna was developed by InterTronic

Solutions Inc. A Mark 6 recorder is currently used for all data recording.



Fig. 1 12-m and 20-m telescopes.

Table 1 Technical parameters of the radio telescopes at KPGO.

Parameter	20-m	12-m
Owner and operating agency	USNO-NASA	USNO-NASA
Year of construction	1993	2015
Diameter of main reflector d	20 m	12 m
Azimuth range	$\pm 270^\circ$	$\pm 270^\circ$
Azimuth velocity	$2^\circ/\text{s}$	$12^\circ/\text{s}$
Azimuth acceleration	$1^\circ/\text{s}^2$	$1^\circ/\text{s}^2$
Elevation range	$\pm 90^\circ$	$\pm 90^\circ$
Elevation velocity	$2^\circ/\text{s}$	$6^\circ/\text{s}$
Elevation acceleration	$1^\circ/\text{s}^2$	$1^\circ/\text{s}^2$
Receiver System		
Focus	Primary Focus	Cassegrain
Receive Frequency	2.2–8.9 GHz	2–14 GHz
T_{sys}	40 K	40 K
$S_{SEFDRange}$	500–2000 Jy	1500–3000 Jy
G/T	40 dB/K	43 dB/K
VLBI terminal type	VLBA4	RDBE
Recording media	Mark 5B+	Mark 6
Field System version	10.0.0	10.0.0

1. USNO
2. NASA GSFC

Kokee Park Geophysical Observatory

IVS 2021+2022 Biennial Report

Timing and frequency is provided by a Sigma Tau Maser with a second Sigma Tau Maser backup. Monitoring of the station frequency standard performance is

provided by a CNS (GPS) Receiver/Computer system. The Sigma Tau performance is also monitored via the IGS Network.



Fig. 2 KPGO site overview.

3 Staff

The staff at Kokee Park consists of seven full time employees employed by Peraton Corporation under the SENSE contract to NASA for the operation and maintenance of the observatory. Chris Coughlin (KPGO Station Manager), Kiah Imai (KPGO Lead Engineer), Lawrence Chang, Durwin Akita, Jacob Decker, and Jeffrey Batangan conduct all site VLBI operations and maintenance. Amorita Yaris provides administrative and logistical support.

4 Mission Support

Kokee Park participates in many VLBI experiments for both Legacy and VGOS Networks. KPGO (Kk) participates in the R4, R1, RDV, CRF, APSG, RD, and OHIG 24-hour sessions along with the INT1 one-hour sessions and the new midnight one-hour Intensive experiments centered on 00:00 UTC. KPGO (Kk) averaged two sessions of 24-hour duration each week, two midnight Intensive experiments of one-hour duration each week, and weekday INT1 sessions in 2021 and 2022. KPGO (K2) participates in the VO 24-hour sessions

along with the V2 one-hour sessions. KPGO (K2) averaged one experiment of 24-hour duration each week, with weekday Intensive experiments in 2021 and 2022.

Kokee Park hosts other systems, including the following: a Doppler Orbitography and Radiopositioning Integrated by Satellite (DORIS) beacon and remote control, a Quasi-Zenith Satellite System (QZSS) monitoring station, a Two-Way Satellite Time and Frequency Transfer (TWSTFT) relay station, and a Turbo-Rogue GPS receiver. Kokee Park is an IGS station.

5 Recent Activities

Much of 2021 and 2022 was limited as far as major site activities and/or upgrades due to the COVID-19 Pandemic. KPGO staff was able to report to the site and continue our mission as normal during the pandemic, achieving excellent data acquisition metrics with both the 20-m and 12-m systems. While no major activities were carried out in 2021 or 2022, there were planning efforts for upcoming improvements to the 20-m telescope, the 12-m telescope, the DORIS System, and the QZSS System. The 20-m system also started supporting a new Intensive experiment referred to as the “midnight” Intensives with one-hour sessions centered on the change of UTC day, 00:00 UTC.



Fig. 3 20-m telescope VGOS Broadband Receiver.

6 Outlook

KPGO is still planning numerous site improvements in the future. When funding is acquired, we are still planning to perform several upgrades to our 20-m system, including VGOS Broadband Signal Chain Install, New Servo System and Cabling, Reflector Backup Structure Refurbishment, Elevation Gearboxes and Gear Replacement, and Reflector RF Alignment. For the 12-m VGOS system we are planning to retrofit the system with some improved design components with recently

built systems. KPGO staff will be working on this with ISI and MIT in 2023–2024. The current, aged Doppler Orbitography and Radiopositioning Integrated by Satellite (DORIS) beacon and remote control system has a much needed upgrade scheduled for January 2023. There are also plans to upgrade the Quasi-Zenith Satellite System (QZSS) monitoring station in 2023. Peraton is working with a NASA Network Engineer and Correlator Sites to further optimize the speeds for our e-transfer circuit currently topping out around ~ 1 G.

Matera CGS VLBI Station 2021–2022 Report

Luciano Garramone¹, Giuseppe Colucci², Francesco Schiavone²

Abstract This report presents the status of the Matera VLBI station. An overview of the station and some technical characteristics of the system are also given.

1 General Information

The Matera VLBI station is located at the Italian Space Agency’s ‘Centro di Geodesia Spaziale G. Colombo’ (CGS) near Matera, a small town in the south of Italy. The CGS came into operation in 1983 when the Satellite Laser Ranging SAO-1 System was installed. Fully integrated into the worldwide network, SAO-1 was in continuous operation from 1983 until 2000, providing high precision ranging observations of several satellites. The new Matera Laser Ranging Observatory (MLRO), one of the most advanced Satellite and Lunar Laser Ranging facilities in the world, was installed in 2002, replacing the old SLR system. The CGS also hosted mobile SLR systems MTLRS (Holland/Germany) and TLRs-1 (NASA).

In May 1990, the CGS extended its capabilities to Very Long Baseline Interferometry (VLBI), installing a 20-m radio telescope. Since then, Matera has observed in 1,467 sessions up through December 2022.

In 1991 we started GPS activities, participating in the GIG 91 experiment and installing at Matera a permanent GPS Rogue receiver. In 1994, six TurboRogue SNR 8100 receivers were purchased in order to create the Italian Space Agency GPS fiducial

network (IGFN). At the moment 15 stations are part of the IGFN, and all data from these stations, together with 24 other stations in Italy, are archived and made available by the CGS Web server GeoDAF (<http://geodaf.mt.asi.it>). Six stations are included in the IGS network, while 12 stations are included in the EUREF network.

In 2000, we started activities with an Absolute Gravimeter (FG5 Micro-G Solutions). The gravimeter operates routinely at CGS and is available for external campaigns on request.

Thanks to the co-location of all precise positioning space-based techniques (VLBI, SLR, LLR, and GPS) and the Absolute Gravimeter, CGS is one of the few “fundamental” stations in the world. With the objective of exploiting the maximum integration in the field of Earth observations, in the late 1980s, ASI extended CGS’ involvement to include remote sensing activities for present and future missions (ERS-1, ERS-2, X-SAR/SIR-C, SRTM, ENVISAT, and COSMO-SkyMed).

The Matera VLBI antenna is a 20-meter dish with a Cassegrain configuration and an AZ-EL mount. The AZ axis has ± 270 degrees of available motion. The slewing velocity is two deg/sec for both the AZ and the EL axes.

The technical parameters of the Matera VLBI antenna are summarized in Table 1.

The Matera time and frequency system consists of the following frequency sources:

- Cesium beam
- Active H-maser standard
- Passive Maser
- GNSS receiver disciplined by Rubidium.

1. Agenzia Spaziale Italiana

2. e-geos – an ASI/Telespazio company



Fig. 1 VLBI antenna.

Table 1 Matera antenna technical specification.

Parameter name	Values (S/X)
Input frequencies	2210–2450 MHz 8180–8980 MHz
Noise temperature at dewar flange	<20 K
IF output frequencies	190–430 MHz 100–900 MHz
IF Output Power (300 K at inp. flange)	0.0 dBm to +8.0 dBm
Gain compression	<1 dB at +8 dBm output level
Image rejection	>45 dB within the IF passband
Inter modulation products	At least 30 dB below each of two carriers at an IF output level of 0 dBm per carrier
T_{sys}	55/65 K
SEFD	800/900 Jy

The Active iMaser 3000 H-maser from T4Science is used as a frequency source for VLBI. Specifications for this new maser can be found here: <https://www.t4science.ch/products/imaser3000/>.

2 Activities during the Past Two Years

In 2021 and 2022 heavy maintenance on the antenna wheels was performed.

In 2022 the azimuth encoder was replaced by a modern one with the same 21 bits of resolution. The replacement was necessary because no spare parts are available for the old model.

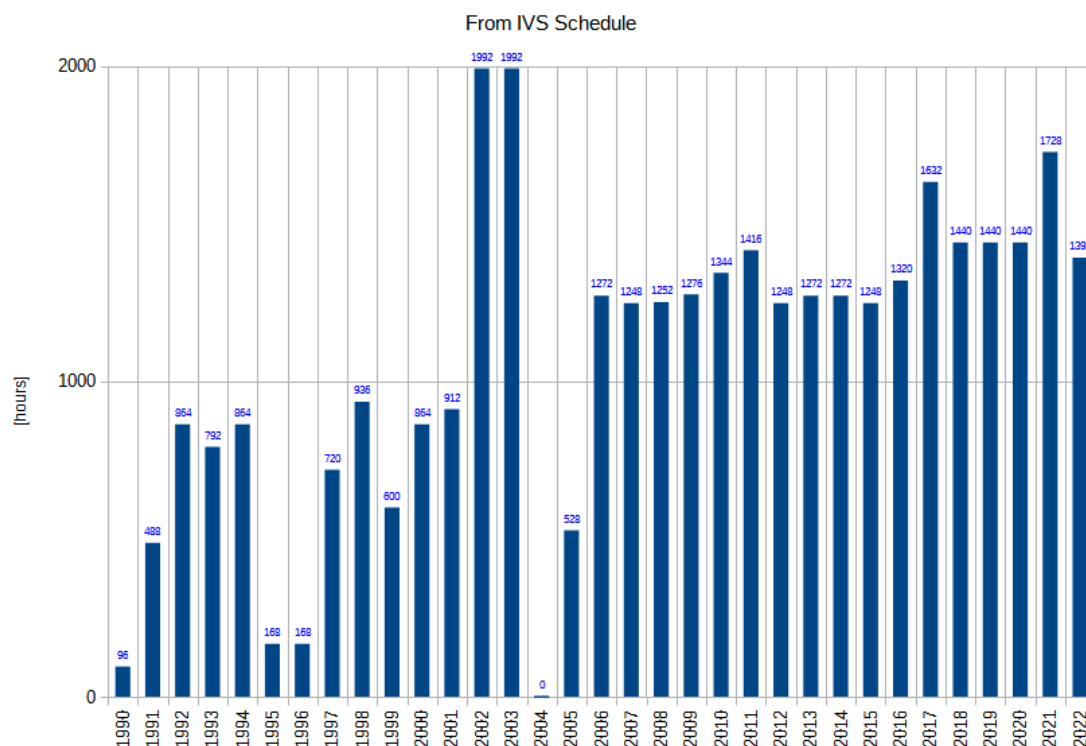

Fig. 2 Observation time.

3 Current Status

Figure 2 shows a summary of the total acquisitions per year, starting in 1990.

In 2004, in order to fix the existing rail problems, a complete rail replacement was planned. In 2005, due to financial difficulties, it was instead decided that only the concrete pedestal under the existing rail would be repaired. From then on, no rail movements were noted [1]–[3].

4 Future Plans

The replacement of the elevation encoder is planned for 2023.

Tuning of the network connection is in progress. The goal is to start electronic transfer of VLBI data at the beginning of 2023.

New VGOS system construction started in 2022; work is in progress.

References

1. M. Mannarella “Relazione sulle misure effettuate sulla rotaia dell’antenna VLBI”, Telespazio doc. OT-SPA-SM.REL.180010.1140.0222, 21/01/2004.
2. M. Mannarella “Misure sugli spostamenti indotti sulle piastre e sulla rotaia dell’antenna VLBI”, Telespazio doc. OT-SPA-SM.REL.180010.1320.0661, 06/04/2005.
3. M. Mannarella “Relazione sull’esito dei lavori di ripristino delle parti ammalorate della fondazione dell’antenna VLBI”, Telespazio Doc. OT-SPA-SM.REL.180010.1320.0732, 27/06/2005.

Medicina Station Status Report

Alessandro Orfei, Giuseppe Maccaferri

Abstract General information about the Medicina Radioastronomical Station, the 32-m antenna status, and the VLBI observations are provided. Updates to hardware and software infrastructure have been made and are briefly described.

1 The Medicina 32-m Antenna: General Information

The 32-m Medicina antenna is located at the Medicina Radioastronomical Station. The station is managed by the Institute of Radio Astronomy and is located about 33 km east of Bologna. The National Research Council was the funding agency of the Institute of Radio Astronomy until the end of 2004. Since 1 January 2005, the funding institution has been the National Institute for Astrophysics (INAF).

The antenna, inaugurated in 1983, has regularly taken part in IVS observations since 1987 and is a member of the European VLBI Network.

A permanent GNSS station (MEDI) is installed nearby, which is part of the IGS network. Another GNSS system (MSEL) is installed near the VLBI telescope and is part of the EUREF network. The observatory is therefore a co-location geodetic site, contributing to the realization of the ITRF.

Istituto di Radioastronomia INAF, Medicina

Medicina Network Station

IVS 2021+2022 Biennial Report

2 Current Status and Activities

- **Antenna:** An active surface system for the primary mirror of Medicina was funded and the works are in progress:
 - The new aluminum panels were delivered, showing a manufacturing accuracy of $< 65 \mu\text{m}$.
 - A new subreflector is in progress; its manufacturing accuracy is foreseen to be $< 50 \mu\text{m}$.
 - All of the parts for constructing 244 electro-mechanical actuators are under delivery and the assembling completion is foreseen for summer 2023. Once completed, Medicina will be able to observe at high frequencies up to 116 GHz with good overall efficiency.
- **Receivers:** In 2019, INAF was awarded a call (PON, National Operational Program) issued by the Ministry of Research. As part of this funding, our institute requested the installation on the Medicina radio telescope of a simultaneous tri-band receiver (18–26, 34–50, 80–116 GHz). The receiver was delivered in summer 2022.
- **VLBI backend:** A new DBBC3 backend was delivered and tested with the FS 10.1.0-beta2 version. A new FlexBuff was installed and configured: we can record at 4 Gbps.
- **Field System:** (a) On the FSL10 Debian machine, we are running the FS 10.0.0. (b) The Continuous_cal system is working for the Cassegrain receivers (6, 5, and 1.3 cm) and since 2/2019 is available also for primary focus receivers (3.6 and 18/21 cm).



Fig. 1 The 32-m Medicina antenna.

3 Geodetic VLBI Observations

In 2021 and 2022, Medicina participated in 52 routine geodetic sessions (28 and 24 sessions, respectively): three IVS-R1, 34 IVS-R4, four IVS-T2, one IVS-CRF, and ten R&D experiments.

technique is innovative to overcome the obstacles imposed by current clock comparison techniques in terms of cost and feasibility. Broadband VLBI observations were carried out between October 2018 and February 2019. The small antenna is expected to return to Japan in 2023.

4 Transportable NICT VLBI Antenna

Since 2018, Medicina Observatory has hosted a 2.4-m antenna designed and built by NICT to carry out broadband VLBI measurements with the aim of comparing optical clocks on an intercontinental basis. This

McDonald Geodetic Observatory

Eusebio 'Chevo' Terrazas

Abstract This report summarizes the technical parameters of the VLBI system at the McDonald Geodetic Observatory and provides an overview of the activities that occurred in 2021 and 2022.

1 General Information

The McDonald Geodetic Observatory (MGO) is located within the McDonald Observatory (McD), 16 miles north of Fort Davis, Texas at an elevation of 6,260 ft in the valley/basin between Mt. Fowlkes and Mt. Locke. MGO is located at longitude 30°40' N and latitude 104°1' W.

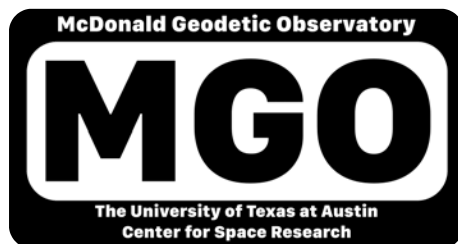

Fig. 1 MGO logo.

The McDonald Geodetic Observatory is a collaborative effort by The University of Texas at Austin's Center for Space Research within the Cockrell School

The University of Texas at Austin / Center for Space Research

MGO Network Station

IVS 2021+2022 Biennial Report

of Engineering and McDonald Observatory within the College of Natural Sciences and NASA's Space Geodesy Project.

The McDonald Geodetic Observatory consists of several geodetic elements, such as an SGLSR installation, operational in FY2025, several GNSS stations located in different areas, and a Gravimeter which is operated by associates at UT Jackson School of Geosciences.

2 Activities during the Past Two Years

During the 2021 calendar year, MGO continued operations with VGOS/VT/S2 sessions, although a number of these sessions were observed with a warm front-end due to a faulty cold head and lack of training to replace the cold head.

At the end of COVID-19 we began accepting visitors and contractors for the much needed completion of several tasks, although onsite operations remained the same. We were able to receive onsite training from MIT staff, our cold head was replaced, and MGO staff are now fully trained in cryogenic maintenance. At the beginning of 2021, we also experienced a state-wide power outage for a week, aka the 'February Winter Storm' in Texas, which caused MGO to miss one VGOS session. During 2021, MGO also began S2 Intensives with the Wettzell South station, and so far it has proven to be a good data point and a good resulting baseline. The S2 Intensives also aided Wettzell in becoming a correlation station. MGO also began routine e-transfer procedures for Intensives, utilizing a 1 Gb/s AT&T line.



Fig. 2 MGO/McD site overview.

During the 2022 calendar year, MGO continued operations with both VGOS sessions and Intensives/tests with Wettzell South. The Wettzell Correlation Center had a fast turn-around for the Intensive and test sessions because MGO was able to e-transfer scans overnight utilizing our 1 Gb/s line, and correlation took place the following day. We also calibrated our onsite RF analyzers in order to better understand and troubleshoot our front-end signals with remote assistance from the MIT Haystack staff. MGO was also able to coordinate and install a live feed video camera system that broadcasts VLBI video to the public, utilizing the YouTube live feed feature. MGO also makes our onsite weather information publicly available, utilizing the Ambient Weather hardware and website. The website based on these features can be seen here: <https://www.csr.utexas.edu/mgo/mgo-live-view-of-vlbi-station/>.

The MGO station also experienced a number of problems during 2022. The first major issue was a mechanical break in the primary elevation motor coupler, which was unexpected and was never seen in other installations before occurring onsite. MGO was able to recover with assistance from ISI and with a new coupler being shipped to MGO from Canada. After the coupler was replaced, we were operational but had remaining issues with the manual hand crank operations, which are set to be resolved in March 2023. Other issues or failures we've seen include an AZ encoder failure, timing inconsistencies, antenna controller issues, LMR400 cable replacement, and cryogenic system issues. But through all of these issues and failures, MGO has continually repaired or replaced components onsite in order to continue the operations schedule set forth by IVS.

MGO also began investigation into the possibility of obtaining a 10 Gb/s line that would help to improve and speed up the e-transfer capabilities. This task has taken a lot of effort from onsite staff and the McDonald Observatory department as well as The University of Texas's Office of Telecommunication Services (OTS) department. The project would still be under the same overview of OTS with the same IP address space but would utilize a fiber path controlled and installed by a local telecommunications company which would offer better reliability and local support for this future installation.

Table 1 Sessions completed for 2021 and 2022.

All Sessions	2021	2022
Scans Scheduled	24,431	59,800
Scans Captured	24,265	56,210
Percentage Completed	99.32%	94.00%

3 Current Status

Currently, the MGO VLBI station is fully operational. We recently replaced a failed M700 compressor with a spare compressor from the KPGO site. Our cryogenic compressor is being rebuilt, and a new compressor was ordered by Peraton for future spare capability. The compressor required onsite troubleshooting utilizing Trillium tech support and, once operational, we could begin testing and operations with a cold front-

end. MGO also had to replace the installed fiber lines which feed the back-end equipment due to poor strain relief located at the front-end. This included the signal fiber for H and V polarization, as well as control fibers for our roughing pump and turbo pump.

4 Future Plans

MGO is looking forward to continuing operations with the planned 10 Gb/s line that is still under review. With continual issues/failures, local staff are continually learning and repairing systems onsite with the hope to eventually understand all of the antenna's systems and be prepared to continue operations no matter what other issues/failures occur. In time, we also hope to be able to pass along that knowledge and provide support to future VLBI stations.

VERA 2021 and 2022 Geodetic Activities

Takaaki Jike¹, Yoshiaki Tamura¹

Abstract The geodetic activities of VERA in the years 2021 and 2022 are briefly described. The regular geodetic observations were carried out both in K- and S/X-bands. The frequency of regular observations is three times a month—twice for the VERA internal observations in K-band. The networks of the S/X sessions are AOV and IVS-T2P. The sampler/recorder commonly used for IVS-T2P and AOV is OCTAD-OCTADISK2. The raw data of the IVS-T2P and AOV sessions are electronically transferred to the Bonn and Tsukuba correlators via Internet. Gravimetric observations are carried out at the VERA stations. Superconducting gravimeters (SG) are installed at Mizusawa in order to monitor precise gravity changes, and the observations continued for two years.

1 General Information

VERA is a Japanese domestic VLBI network consisting of the Mizusawa, Iriki, Ogasawara, and Ishigakijima stations. Each station is equipped with a 20-m radio telescope and a VLBI backend. The VERA array is controlled from the Array Operation Center (AOC) at Mizusawa via Internet. Correlation processing of the data recorded by our VLBI array is performed by the software correlator at Mizusawa. Figure 1 shows the PC group of the software correlator in operation at Mizusawa.

¹Mizusawa VLBI Observatory, National Astronomical Observatory of Japan

VERA Network Station

IVS 2021+2022 Biennial Report



Fig. 1 View of the Mizusawa Software Correlator and data servers in Mizusawa Correlation Office.

The primary scientific goal of VERA by FY 2021 was to reveal the structure and the dynamics of our galaxy by determining a three-dimensional force field and mass distribution. A project to conduct experimental VLBI observations began in 2022 by widely soliciting proposals for radio astronomy observations. The first proposal was made in August 2022, and observations tentatively started in October.

The observation frequency bands of VERA are listed with the S-, C-, X-, K-, and Q-bands as regular observation bands. S- and X-band are in operation only at Mizusawa. Geodetic observations are made in S/X- and K-bands. C- and Q-band are currently not used for geodesy. Only a single beam is used even in K-band in geodetic observations, although VERA can observe two closely separated radio sources ($0.3^\circ < \text{separation angle} < 2.2^\circ$) simultaneously by using the dual beam platforms.

Table 1 Location.

Site name	Longitude	Latitude	Altitude
Mizusawa	141°07'57".199 E	39°08'00".726 N	75.7 m
Iriki	130°26'23".593 E	31°44'52".437 N	541.6 m
Ogasawara	142°12'59".809 E	27°05'30".487 N	223.0 m
Ishigakijima	124°10'15".578 E	24°24'43".834 N	38.5 m

General information about the VERA stations is summarized in Table 1, and the geographic locations are shown in Figure 2. The lengths of the baselines range from 1,080 km to 2,272 km. The skyline at Ogasawara station ranges from 7° to 18° because it is located at the bottom of an old volcanic depression. The northeast sky at Ishigakijima station is blocked by a nearby high mountain. But the majority of the skyline is below 9°. The skylines at Mizusawa and Iriki are low enough to observe sources with low elevation. Because Ogasawara and Ishigakijima are small islands in the open sea and their climate is subtropical, the humidity in the summer is very high. This brings about high system temperatures in the summer, in particular in K- and Q-bands. Iriki, Ogasawara, and Ishigakijima stations are frequently hit by strong typhoons. The wind speed sometimes reaches up to 60–70 m/s. Mizusawa often stops operating its antenna due to heavy snow in winter.

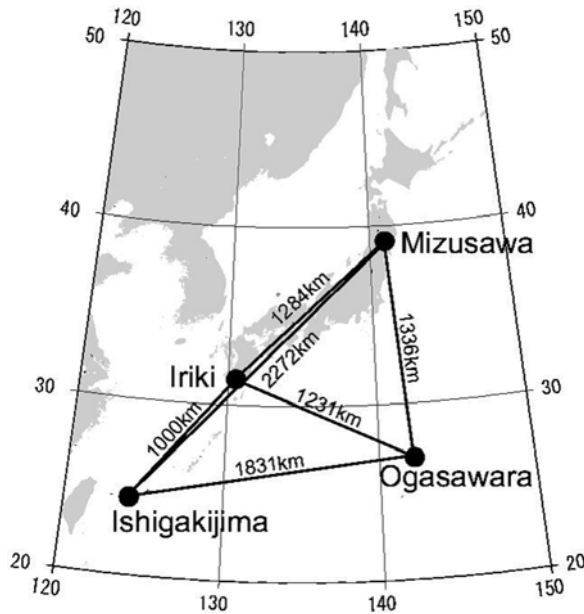
**Fig. 2** Distribution of the stations in the VERA Network.

2 Current Status

The parameters of the antennas are summarized in Table 2, and front- and backends are summarized in Table 3, respectively. The actual receiver temperature of S-band is much higher than in the notation of the table due to the influence of interference. Two observing modes are used for geodetic observations. One is the VERA internal observation in K-band with the recording rate of 1 or 2 Gbps using OCTADISK. The other is the conventional S/X-band observation with OCTAD-OCTADISK2 (1 Gbps and 512 Mbps) [1]. The AOV and T2P sessions belong to this class. Only Mizusawa participated in these sessions.

Table 2 Antenna parameters.

Diameter of main reflector	20 m	
Mount type	AZ-EL	
Surface accuracy	0.2 mm (rms)	
Pointing accuracy	<12" (rms)	
	Azimuth	Elevation
Slew range	−90° – 450°	5° – 85°
Slew speed	2.1°/sec	2.1°/sec
Acceleration	2.1°/sec ²	2.1°/sec ²
	S	X K
HPBW	1550"	400" 150"
Aperture efficiency	0.25	0.4 0.47

Table 3 Frontend and backend parameters.

	Frontend parameters		
	S	X	K
Frequency band	S	X	K
Frequency range (GHz)	2.18–2.36	8.18–9.00	21.5–24.5
Receiver temperature	>100 °K	100 °K	39±8 °K
Polarization	RHC	RHC	LHC
Receiver type	HEMT	HEMT	cooled HEMT
Feed type	Helical array		Horn
	Backend parameters		
Observation type	VERA Intl.	T2P	AOV
Sampling [MHz-bit]	32-2 or 1024-2	16-2	32-2
Channel	16 or 1	16	16
Sampler	ADS1000	DBBC	DBBC
Recorder	OCD	OCD2	OCD2
Rec. rate [Mbps]	1024 or 2048	512	1024
Deployed station	4 VERA	Mizusawa	
OCD: OCTADISK, OCD2: OCTADISK2			
DBBC: OCTAD Digital Baseband Converter			

3 Activities during the Past Years

VERA observes seven days a week, except for during a maintenance period from mid-June to mid-August. The 24-hour geodetic sessions are allocated twice or three times in a month. Among these geodetic sessions, VERA internal geodetic observations in K-band are performed once or twice in a month, and Mizusawa participates in AOV and T2P sessions in S/X-bands six to eight times a year in total. The main purpose of the VERA internal geodetic observations is to determine relative positions of the VERA antennas accurate enough for astrometric requirements. The purpose of the S/X sessions is to link the VERA coordinates into the reference frame built by VLBI.

In the VERA internal geodetic sessions, the regularly used frequency changed from S/X-bands to K-band in 2007. The reason for the shift of the observing frequency band from S/X-bands to K-band is to avoid the strong radio interference by mobile phones in S-band, particularly at Mizusawa. The interfering signal, which has line spectra, is filtered out. But this filtering considerably degrades the system noise temperature. The interference zone is increasing, so it is likely that S-band observing will become almost impossible in the near future. On the other hand, VERA has the highest sensitivity in K-band, as shown in Table 3. Thanks to the high sensitivity in this band, the maximum number of scans in K-band is 800/station/24-hours, while that in S/X-bands is 500 at most. It has been confirmed that the K-band observations are far more precise. In fact, standard deviations of the individual determinations of the antenna positions in K-band are less than half of those in S/X-bands.

In 2021 and 2022, there was a long annual maintenance period from early June to mid-August in each year. Then, there were temporary maintenance periods from September 2021 to March 2022, resulting in a significant decrease in the number of observations. With the exception of this period, VERA carried out internal geodetic VLBI observations 18 times. Mizusawa participated in ten T2P and AOV sessions. The final estimation of the geodetic parameters is derived by using the software developed by the VERA team.

Continuous GPS observations were carried out at each VERA station throughout the year. In order to accurately monitor gravity change for the purpose of monitoring height change at VERA Mizusawa station,

the superconducting gravimeter (SG) was installed to continue the acquisition of gravity data. Gravity-continuous measurement by the SG on Ishigaki-jima was completed in FY 2021.

4 Future Plans

The SKA sub-project will be established under the Mizusawa VLBI observatory in FY 2023. At the request of SKA Japan, VERA will provide a testing field to conduct basic experiments. An experiment of relativistic geodetic observation using an optical lattice clock is also planned.

5 Staff

Mareki Honma is the director of Mizusawa VLBI Observatory. The geodesy group consists of Yoshiaki Tamura (scientist) and Takaaki Jike (scientist). Jike is also responsible for the operation of the Mizusawa Correlation Office.

References

1. Y. Kono, T. Oyama, N. Kawaguchi, S. Suzuki, K. Fujisawa, H. Takaba, K. Sorai, M. Sekido, S. Kurihara, Y. Murata, H. Uose, "Real-time VLBI Network with 10GbE Connection, OCTAVE", in D. Behrend and K. Bayer, editors, *International VLBI Service for Geodesy and Astrometry 2012 General Meeting Proceedings*, NASA/CP-2012-217504, pages 96–98, 2012.

Noto Station Status Report

Andrea Orlati, Salvo Buttaccio

Abstract General information about the Noto VLBI Station and the 32-m telescope is provided. The focus is on the current status and on hardware—software upgrades during the last two years of operations.

1 General Information

The 32-m parabolic antenna is located near Noto in Sicily and is operated by the Institute of Radioastronomy of the National Institute for Astrophysics (INAF). The telescope has been active since 1989 in VLBI observations and has regularly participated in geodetic observations, even during the COVID-19 pandemic. In the past, the antenna was also involved in many different projects of radioscience and Space VLBI. Currently, the telescope's core commitments are mainly related to both the EVN and IVS networks.

A permanent GNSS station (NOT1) is installed nearby and is part of the IGS network. The observatory is therefore a co-location geodetic site, contributing to the realization of the ITRF.

2 Current Status and Activities

- **Station** – We refurbished the station air cooling system completing several interventions and installing new chillers serving the offices and laboratories. In 2021 we also replaced the UPS

with a new one. A new IF distributor is being developed and installed in the control room. The device automates and facilitates receiver setup, allowing for better and more reliable setup before experiments. A full H-maser maintenance was finalized at the end of 2022.

- **Antenna** – The 32-m antenna is fully azimuth and elevation steerable and is equipped with an active surface, allowing it to correct gravitational deformations of the primary mirror. The configuration of primary or secondary focus is done automatically by a servo system that moves the secondary mirror and the primary focus receiver box. The servo system, together with several mechanical parts of the actuators, was replaced and refurbished recently.
- **Receivers** – The primary focus receiver is an L- (1.316–1.745 GHz), S- (2.213–2.389 GHz), and X-band (8.205–8.938 GHz) system. Available secondary focus receivers are Clow- (4.62–5.02 GHz), Chigh- (5.1–7.25 GHz), and K-band (21.7–22.2 GHz). All receivers provide double, circular polarization. Clow- and K-band are cryogenics systems. Presently Chigh- and K-band have a failure in one of their IF chains (LNA). A simultaneous three-band (K, Q, W) receiver (18–26 GHz, 34–50 GHz, and 80–116 GHz) is now available and ready to be installed in the secondary focus cabin. The receiver was funded by the PON (National Operational Program) issued by the Italian Research Ministry. It can output wide IF bandwidths (K-band: 8 GHz; Q-band: 16 GHz, and W-band: 16 + 16 GHz). The final installation and commissioning of the receiver will be done in 2023, after the refurbishment of the secondary focus cabin, including the new helium line, is completed.

INAF – Istituto di Radioastronomia

Noto VLBI Station

IVS 2021+2022 Biennial Report



Fig. 1 The Noto antenna in a recent image.

- **VLBI back-end** – Noto is currently running a DBBC version 2. The firmware version is currently DDC V107 and DFB V16. The recorder is a Flexbuff system (software version 2.8.1). The Flexbuff system of Noto has a capacity of 360 TB. Also in 2022 we completed the purchase of a new, state-of-the-art Flexbuff with a capacity of 512 TB. In the framework of the PON we also managed to buy a new DBBC, version 3 (up to six IFs).

3 Geodetic VLBI Observations

Noto participated in 46 geodetic sessions (23 in 2021 and 23 in 2022): 37 IVS-R1, five IVS-CRF, and four IVS-T2 experiments.

4 Future Plans

A complete refurbishment of the secondary focus cabin (Vertex Room), the cooling system of the telescope, the helium pipes, and the power plant serving the telescope was funded by the INAF and will be done in 2023. The INAF has succeeded in a call for funding under the framework of the PNRR (EU fundings). As part of the PNRR, Noto will go through several major maintenances in the next three years. The azimuth rail, including the wheels and bearing, the elevation rack, and the secondary mirror will be replaced. Also the telescope structure coating and the primary mirror painting will be completely refurbished.

Ny-Ålesund Geodetic Observatory

Susana Garcia-Espada, Rubén Bolaño González, Gro Grinde

Abstract During 2021/2022 Ny-Ålesund Geodetic Observatory in Svalbard (Norway), operated by the Norwegian Mapping Authority (NMA), continued contributing to the VLBI network as the northernmost VLBI station. The old 20-m telescope (Ny) and the new Ny-Ålesund South (Ns) 13-m telescope at the new geodetic observatory (officially inaugurated in 2018) continued their regular contributions to the IVS observation schedule by running parallel sessions in the legacy IVS network. Ns started contributing as a core station in the legacy network in November 2021. The new Ny-Ålesund North (Nn) 13-m VGOS (VLBI Global Observing System) telescope at the new geodetic observatory started 24-hour operations as a core VGOS station for scheduled VGOS sessions correlated at Haystack from November 2022. Currently it is in the process of fully contributing to the VGOS VLBI network.

1 General Information

The Geodetic Observatory of the Norwegian Mapping Authority (NMA) is situated at 78.9° N and 11.9° E in Ny-Ålesund, Kings Fjord, on the west side of the island Spitsbergen. This is the biggest island in the Svalbard archipelago. The Geodetic Observatory features a 20-meter legacy VLBI radio telescope at the Rabben site (see Figure 1), as well as fast-slewing VGOS twin

Norwegian Mapping Authority, Geodetic Institute

Ny-Ålesund Network Station

IVS 2021+2022 Biennial Report

telescopes at the new facility at the Brandal geodetic observatory (see Figure 2).



Fig. 1 The geodetic observatory's Rabben site with the Ny 20-m telescope.



Fig. 2 The geodetic observatory's Brandal site with 13-m twin telescopes. From left to right: Ny-Ålesund 13-m North antenna (Nn), SLR dome, operations building, and Ny-Ålesund 13-m South antenna (Ns). (Image: Bjorn-Owe Holmberg)

In addition to the 20-m VLBI telescope and the 13-m twin telescopes, the geodetic observatory has three GNSS receivers in the IGS system and two Super Conducting Gravimeters which are part of the International Geodynamics and Earth Tide Service. One SCG is installed at the Rabben site, and the second SCG is installed at the Brandal site; they are approximately 1.5 km away from each other. A fourth GNSS receiver from the German Research Centre for Geosciences (GFZ) is hosted in the Rabben site. A solar radio burst monitor is set up at Rabben, and a tide gauge is in operation at the harbor in Ny-Ålesund.

The observatory also hosts an accelerograph from the Instituto Geográfico Nacional in Spain and a GISTM (GPS Ionospheric Scintillation and TEC Monitor) receiver which is operated in the frame of ISACCO, an Italian research project on ionospheric scintillation observations, led by the Italian Institute of Volcanology and Geophysics (INGV). Another Real-Time Ionospheric Scintillation (RTIS) Monitor is set up and has been operated by the NMA since November 2012. A DORIS station is located approximately 350 m from the new geodetic observatory at Brandal and is hosted by the French-German AWIPEV research base.

The NMA is working on a Satellite Laser Ranging (SLR) installation in the new geodetic observatory. The SLR dome was installed in April 2022 (see Figure 2). Gimbal and telescope assembly are planned during 2023. Laser installation is planned during 2024. The SLR technique will be operational by 2025.

2 Component Description

The radio telescope with a 20-m diameter is intended for geodetic use and receivers in S- and X-band. Its design and construction are similar to those at Green Bank and Kokee Park. A DBBC2 streams the data to a Mark5B+ recorder. Another Mark5B+ unit is used to transfer data via network to the correlators. Timing and frequency is provided by a NASA NR maser, which is monitored by a CNS system.

The fast-slewing VGOS twin telescopes at Brandal (designated as Nn and Ns) are 13.2-m in diameter. A tri-band feed is currently installed at the Ns telescope with a DBBC2 and Flexbuff forming the back-end system. At the Nn telescope a broadband receiver

(2–14 GHz) is installed, with a DBBC3 and Flexbuff as the back-end. A T4Science iMaser 3000 provides the frequency signal at Brandal.

3 Staff

The staff at Ny-Ålesund consists of five people employed at 75%, with 3.75 full-time positions currently covered (see Figure 3 for an overview). Station staff are part of the Geodesy division at the Geodetic Institute of the NMA, which has its main office in Hønefoss (near Oslo).



Fig. 3 Core team from left to right: Rubén Bolaño González, Susana Garcia Espada (station leader), Axel Meldahl, Silje Wennesland, and Thomas Gasmoe. (Image: Bjorn-Owe Holmberg)

Axel Meldahl has been working as an operations engineer at the observatory since 2015. Susana Garcia-Espada and Rubén Bolaño González joined the operations team in April 2020. Susana has been the station leader since November 2021. Thomas Gasmoe has been an operations engineer since May 2021. Silje Wennesland joined the team in November 2021.

Table 1 Staff related to VLBI operations in Ny-Ålesund.

Head of department	Per Erik Opseth
Project leader (new observatory)	Gro Grinde
Station Leader	Susana Garcia Espada
Operations engineer	Axel Meldahl
Operations engineer	Rubén Bolaño González
Operations engineer	Thomas Gasmoe
Operations engineer	Silje Wennesland
VLBI instrument responsible	Leif Morten Tangen
VLBI data analyst	Ann-Silje Kirkvik

The staff in Ny-Ålesund work closely with colleagues located on the mainland at NMA's Hønefoss

and Oslo offices: Ann-Silje Kirkvik (VLBI data analyst), Leif Morten Tangen (VLBI instrument responsible), Gro Grinde (project leader for the new geodetic observatory), and Per Erik Opseth (head of the Geodesy department) (see Table 1 for an overview).

4 Current Status and Activities

In 2021/2022 the 20-m Ny telescope in Ny-Ålesund was scheduled for 243 24-hour VLBI observations, including R1, R4, EURO, RD, T2, and RDV sessions, and for 64 one-hour observations within the Intensive program. During this period the Ny telescope had a five-month down period from June 2021 until October 2021 due to problems with the NASA NR2 maser used as the frequency standard.

Meanwhile, the 13-m Ns telescope was scheduled tagged-along for 247 24-hour VLBI sessions, including R1, R4, EURO, RD, T2, and RDV sessions, and for 57 one-hour VLBI sessions within the Intensive program.

The Ns telescope joined the legacy VLBI network as a core station in November 2021. Most of the scheduled sessions were run in parallel at both the Ny and Ns telescopes (see Figure 4).



Fig. 4 The distance from the Ny telescope at Rabben to the Ns and Nn telescopes is about 1.5 km.

In order to get the best possible estimations and results for the parallel time series between Ns–Ny, 14 24-hour VLBI local-tie short baseline sessions between the Ny and Ns telescopes (NYTIE) were observed from August 2022 until mid October. The plans are to correlate the NYTIE sessions locally. Work is in progress.

The legacy 20-m telescope at Rabben (Ny) was operative for most of 2021 and 2022. Unfortunately, from the end of June 2021 to mid October 2021, Ny suffered a major setback when the NASA NR maser failed. After investigations, spare parts sent to Ny-Ålesund, and the correspondent maintenance, the maser was fixed correctly again, making it possible to resume VLBI

operations with Ny. New problems were noticed since October–November 2022 and the Ny antenna started having a lower performance than usual. It is currently under investigation, and suspicions are on a failure of the DBBC2. Currently, a DBBC2 borrowed from the Instituto Geográfico Nacional (Spain) is being shipped from the Santa Maria station (Azores) to Ny-Ålesund observatory. At the end of December 2022, the structure of the winch that is used to install and take down the receiver in the 20-m telescope collapsed over the receiver and smashed/cut a few cables, the S-band and X-band IFs and the 5 MHz to the receiver being among them. Cables were repaired. Ny is currently waiting for the DBBC2 to be delivered in Ny-Ålesund in order to resume operations again as soon as possible before it is dismantled at the end of summer 2023.

In the last years, it has been challenging to keep the 20-m Ny telescope operational, and more efforts are being put into the new Ns and Nn antennas at Brandal. The Ns flexbuff was updated in June 2022 to increase capacity and recording performance.

The 13-m Nn telescope started operations in August 2022. Nn was scheduled tagged-along in three 24-hour VGOS sessions processed at the Haystack correlator. Since November 2022, Nn has been scheduled as a core station in the VGOS VLBI network. During this period it has observed two 24-hour VGOS sessions correlated at Haystack.

On the other hand, the VGOS receiver (installed in November 2021 in the Nn telescope) was upgraded during mid 2021 at the Yebes Observatory (Instituto Geográfico Nacional, Spain). Its LNA configuration was upgraded from single-ended to balanced configuration. The installation of the upgraded VGOS receiver in the Nn telescope was done in November 2021.

Local tie measurements were carried out at Brandal in the summers of 2021 and 2022, continuing with the stability measurement time series.

The DORIS beacon has been connected to the common frequency standard at the Brandal new geodetic observatory since July 2022. The duct cable from Brandal to DORIS houses an RF cable providing a 5 MHz reference signal from the hydrogen maser at Brandal to the DORIS beacon. It ensures that all space geodetic techniques at Brandal use a common frequency standard.

The installation of the first SLR components started in April 2022 with the installation of the SLR dome on the roof at Brandal geodetic observatory (see Figure 2).

Calibration of both SCGs at Brandal and Rabben was performed using an FG5 absolute gravimeter during October 2021. The calibration was performed with support by colleagues from Strasbourg University (France).

5 Future Plans

Fully operationalizing the twin-telescopes (Ns and Nn) at the new geodetic observatory remains the focus of the station staff.

The Nn telescope will contribute to the VGOS VLBI network, and hopefully it will begin operations as a full core station during 2023.

The Ns and Ny telescopes will continue observing parallel measurements, official IVS sessions, and local NYTIE VLBI local-tie sessions, as soon as the Ny telescope is back in operation again.

The legacy 20-m telescope at Rabben (Ny) will be dismantled at the end of summer 2023 giving an end to its VLBI operations after more than 30 years of observations and after more than three years of parallel observations together with the Ns telescope. Overall, focus will increasingly shift to operations at the new geodetic observatory when the 20-m telescope will be phased out and taken down.

The Ns telescope will continue observing at least during 2023 as part of the legacy VLBI network. A second VGOS receiver (to be installed in Ns) is planned to be upgraded at the end of 2023 at Yebes Observatory (Instituto Geográfico Nacional, Spain). Its LNA con-

figuration will be upgraded from single ended to balanced configuration, making it equal to the VGOS receiver installed in the Nn telescope. It is not decided when the Ns will be upgraded with the VGOS receiver and when it will start operations in the VGOS VLBI network. Investigations and simulations are on-going to find the best timing for the upgrade in order to have the best contributions possible for the VLBI community and ITRF. Together with the upgraded broadband receiver, a DBBC3 will be installed. In the meantime, Ns will continue observing in the VLBI legacy network through 2023.

Local tie measurements at Brandal and between Brandal and Rabben will be carried out in summer 2023 before the 20-m Ny telescope is dismantled.

Gimbal and telescope assembly for the SLR are planned to be installed after summer 2023, and the laser system will be installed in 2024. The SLR is planned to be fully operational by 2025.

The geodetic observatory is thus planned to become a fundamental station with all space geodetic techniques co-located in 2025.

References

1. Piotr Kupiszewski, Gro Grinde, Susana Garcia-Espada, Rubén Bolaño González, Ny-Ålesund Geodetic Observatory, in International VLBI Service for Geodesy and Astrometry 2019+2020 Biennial Report, edited by D. Behrend, K. L. Armstrong, and K. D. Baver, NASA/TP-20210021389, 2021.

German Antarctic Receiving Station (GARS) O'Higgins

Theo Bachem¹, Michael Seegerer¹, Robert Wildenauer¹, Thomas Klügel¹, Alexander Neidhardt², Christian Plötz¹, Torben Schüler¹

Abstract The German Antarctic Receiving Station (GARS) O'Higgins successfully contributed to the IVS observing program in the years 2021 and 2022. At the end of 2022 we were able to carry out the first maintenance cycle since the beginning of the Covid-19 pandemic. As part of the maintenance work, the receiver dewar and the coldhead of the helium cooling system were replaced. The time and frequency systems were also updated with new devices such as a new NTP time server and TCP/IP-capable multipurpose counters. The backup hydrogen maser EFOS-11 is still operational, because repairing the EFOS-50 as the main system was not yet successful. The Flexbuff recording system was extended by a second server and a tape library device. Furthermore, the defective VLBI cable delay ground module was replaced. The station IT network was prepared for an upgrade, beginning with the installation of new router devices.

1 General Information

The Antarctic station GARS O'Higgins is jointly operated by the German Aerospace Center (DLR) and the Federal Agency for Cartography and Geodesy (BKG; it is under service of the Geodetic Observatory Wettzell (GOW)). The Institute for Antarctic Research Chile (INACH) coordinates the logistics. The 9-meter radio telescope at GARS O'Higgins is mainly used for down-

loading remote sensing data from satellites, such as TanDEM-X and for the commanding and monitoring of spacecraft telemetry. The DLR operating staff and a Chilean team for maintaining the infrastructure (e.g., power and freshwater generation, technical support) were at the station for the entire period. BKG staff was on site from mid-November to mid-December 2022. Within the report time period, the O'Higgins VLBI station was scheduled in a total of 33 IVS sessions. In addition, the O'Higgins VLBI radio telescope participated in two 24-hour BKG sessions.

The carriage of passengers and cargo by air and by ship was organized by INACH in close collaboration with the Chilean Army, Navy, and Air force. All technical material and food for the entire stay are delivered from Punta Arenas via Base Frei on King George Island to O'Higgins on the Antarctic Peninsula. The conditions for landing on the glacier or accessing the base via ship are strongly weather dependent. In general, transport of staff and cargo is always a challenging task. Arrival and departure times strongly depend on the current meteorological conditions and on the logistic circumstances.

The VLBI system is continuously operational. However, maintenance and potential repair work are only possible when BKG staff are present. Frequent damages resulting from the rough climate conditions and strong storms have to be identified and repaired, e.g., wind sensors. Shipment of each kind of material, such as special tools, spare parts, or upgrade kits, has to be carefully prepared in advance. The most important station and system parameters are permanently monitored remotely.

1. Bundesamt für Kartographie und Geodäsie (BKG)

2. Forschungseinrichtung Satellitengeodäsie (FESG), Technische Universität München



Fig. 1 View of the 9-meter radio telescope at GARS.

2 Activities during the Years 2021–2022

The restrictive policy and obvious difficulties and risks with performing an on-site campaign during the Covid-19 pandemic were the main reasons why the first visit since March 2020 did not happen earlier than November 2022. Due to this delay, it was necessary to spend some extra time to work on completing all safety regulations. Therefore, the main objective of this campaign was to repair or exchange the most important system components to put the station into an operational state for at least one year.

After more than three years of continuous operation, the cold head of the VLBI receiver, as well as the dewar itself had to be replaced. After this maintenance, the system was able to reach a stable cold-stage temperature of 16 Kelvin.

Another important task of this visit was to find the reason for the defective hydrogen maser EFOS-50, which is actually the main system. It failed shortly after the last campaign on site before the Covid pan-

dem. Unfortunately, this was not achieved and had to be postponed to the next visit. The replacement of the GNSS NTP time server was more successful. It became necessary due to the end of the support cycle in combination with the GPS week number rollover problem of the old device.

3 Staff

The members of staff for operation, maintenance, and upgrade of the VLBI system and other geodetic devices are summarized in Table 1.

4 Current Status

Besides the 9-meter VLBI radio telescope, which is used for the dual purpose of receiving data from and sending commands to remote sensing satellites, and

Table 1 GARS related staff members.

Name	Affiliation	Function	Mainly working for...
Torben Schüler	BKG	head of the GOW	GOW
Thomas Klügel	BKG	deputy head of the GOW	administration laser gyro/ local systems Wetzell
Christian Plötz	BKG	head of VLBI	VLBI correlator, RTW, TTW
Theo Bachem	BKG	electrical engineer	SLR Wetzell, operator O'Higgins
Michael Seegerer	BKG	IT engineer	VLBI correlator, O'Higgins
Robert Wildenauer	BKG	IT engineer	VLBI correlator, O'Higgins
Svetlana Mähler	BKG	geodesist	survey, SLR Wetzell, logistics O'Higgins
Olaf Lang	BKG	electrical engineer	local systems/ SLR Wetzell, logistics O'Higgins
Alexander Neidhardt	FESG TUM	head of the group for microwave techniques, chief of operations group	RTW, TTW
Gerhard Kronschnabl	BKG	electrical engineer (chief engineer TTW)	TTW, RTW

performing geodetic VLBI, other geodetic-relevant instruments are also operated on site:

- Currently two H-masers (EFOS-11 and EFOS-50), an atomic Cs-clock, and a GPS time receiver realize the time and frequency basis. Due to a failure of the main EFOS-50 maser, the frequency standard had to be switched to the backup system (EFOS-11).

- Two GNSS receivers, OHI2 and OHI3, both being Galileo enabled, operate in the frame of the IGS network. The receivers worked without failure.
- A meteorological station providing pressure, temperature, humidity, and wind information, as long as the temporarily extreme conditions did not disturb the sensors.
- Two SAR corner reflectors, which were installed in March 2013 as part of a network to evaluate the localization accuracy of the TerraSAR-X mission.

5 Future Plans

The main frequency standard of the VLBI station, the EFOS-50 hydrogen maser, needs to be repaired during the next visit. The upgrade of IT equipment needs to be continued in order to achieve a reliable and performant IT infrastructure on site. The concrete pillars and base of the GNSS antennas need to be repaired.

Onsala Space Observatory – IVS Network Station Activities During 2021–2022

Rüdiger Haas, Eskil Varenius, Gunnar Elgered, Periklis-Konstantinos Diamantidis, Hans-Georg Scherneck, Maxime Mouyen, Peter Forkman, Karine Le Bail, Rebekka Handirk

Abstract During 2021 and 2022 we participated in a total of 81 IVS 24-hour legacy S/X sessions with the Onsala 20-m telescope. We observed in a total of 73 VGOS 24-hour sessions with one or both of the Onsala twin telescopes (OTT) in 2021 and 2022. In total we observed 114 VGOS one-hour Intensive sessions during 2021 and 2022, the majority together with the partner station Ishioka in Japan, but also five with Kokee Park. More than 50% of these sessions involved both Onsala twin telescopes. We also performed 22 local interferometry measurements at Onsala during 2021 and 2022 for measuring the local ties between our telescopes that are used for geodetic VLBI. In 2021 we also performed 91 short (20-minute) flux-monitoring sessions with the OTT as a standalone instrument.

1 General Information

The Onsala Space Observatory is the national facility for radio astronomy in Sweden with the mission to support high-quality research in radio astronomy and geosciences. The geoscience instrumentation at Onsala includes three antennas used for geodetic VLBI, several GNSS installations, a superconducting gravimeter, a platform for visiting absolute gravimeters, several microwave radiometers for atmospheric measurements, both GNSS-based and conventional tide gauge sensors, and a seismometer. The observatory can thus be regarded as a fundamental geodetic station. Since

Chalmers University of Technology, Department of Space, Earth and Environment, Onsala Space Observatory

Onsala IVS Network Station

IVS 2021+2022 Biennial Report

2021 the observatory has been receiving financial support for geoscience operations kindly provided by Lantmäteriet—the Swedish mapping, cadastral, and land registration authority. The staff members associated with the IVS Network Station at Onsala are listed in Table 1.

2 Legacy S/X VLBI Observations

In total, the 20-m radio telescope (On) participated in 42 of the originally planned 46 legacy S/X sessions in 2021. All sessions were recorded with the DBBC2/Flexbuff system, and the data were e-transferred for correlation. The four planned IVS sessions in 2021 that could not be observed due to a strange shaking behavior of the 20-m radio telescope were R11014, R11015, RV149, and T2148. The first three hours of RV150 were lost due to an operator error.

In 2022, the 20-m radio telescope (On) participated in 39 out of the originally planned 47 legacy S/X sessions. The cancellation of eight originally planned sessions was due to the co-observing rules introduced after the Russian invasion war against Ukraine.

3 VGOS 24-hour Observations

In 2021 Onsala participated in 28 IVS 24-hour VGOS sessions. Three sessions in 2021 were observed with only one of the OTT (Onsala twin telescopes), i.e., VO1021 (Ow: compressor problems), VO1133 (Oe: no recording disk space left), and VO1259 (Oe: DBBC3

Table 1 Staff members associated with the IVS Network Station at Onsala in 2021–2022. All e-mail addresses have the ending @chalmers.se, and the complete telephone numbers start with the prefix +46-31-772.

Function	Name	e-mail	telephone
Responsible P.I.s for geodetic VLBI observations	Rüdiger Haas	rudiger.haas	5530
	Eskil Varenius	eskil.varenius	5558
	Karine Le Bail	karine.lebail	5556
Ph.D. students involved in geodetic VLBI	Periklis-Konstantinos Diamantidis	periklis.diamantidis	5575
	Rebekka Handirk (since 2020-09-15)	rebekka.handirk	5575
Responsible for the VLBI Field System	Michael Lindqvist	michael.lindqvist	5508
	Rüdiger Haas	rudiger.haas	5530
	Eskil Varenius	eskil.varenius	5558
Responsible for the VLBI equipment	Magnus Dahlgren	magnus.dahlgren	5594
	Lars Pettersson	lars.pettersson	5568
Responsible for the VLBI operators and data recording and transfer equipment	Roger Hammargren	roger.hammargren	5551
	Simon Casey	simon.casey	5529
	Eskil Varenius	eskil.varenius	5558
Telescope scientist	Henrik Olofsson	henrik.olofsson	5564
Software engineer	Mikael Lerner	mikael.lerner	5581
Responsible for gravimetry	Maxime Mouyen	maxime.mouyen	5549
Responsible for tide gauge and radiometry	Gunnar Elgered	gunnar.elgered	5565
Responsible for aeronomy and radiometry	Peter Forkman	peter.forkman	5577
Observatory director	John Conway	john.conway	5503

phase coherence loss). All other 24-hour VGOS sessions in 2021 were observed with both OTT.

Onsala participated in 44 IVS 24-hour VGOS sessions in 2022. Two of the originally planned 46 sessions were cancelled due to a general change of the IVS VO cadence in late 2022. Out of the 44 sessions, 24 were observed with both OTT. Ow did not participate in 14 sessions between March and May 2022 because its DBBC3 was in Bonn for upgrade. Oe did not participate in VR2203 due to paint work. Oe did not participate in VO2153 due to paint work and lack of recording disk space. Oe did not participate in VO2160 due to unresolved interlock problems and did not participate in VO2181 due to a problem with the AC unit in the azimuth cabin. Oe did not participate in VO2293 due to lack of recording disk space. Ow did not participate in VR2206 due to lack of recording disk space and cryoservice. Furthermore, Ow stopped observing early during VO2132 due to DBBC3 problems, and Oe lost about one hour of observations during VO2363 due to interlock problems.

Both OTT participated in the European VGOS Research and Development session ER2201 in 2022.

4 VGOS One-hour Intensive Observations

Between January and early March 2021 Onsala observed 25 VGOS-Intensive one-hour sessions for UT1-UTC determination together with the partner station Ishioka in Japan. These sessions were observed on Saturdays and Sundays and involved both OTT. The raw data from Ishioka were e-transferred to Onsala for correlation and creation of the vgosDbs.

Between mid March and early October 2022, Onsala observed 84 VGOS-Intensive one-hour sessions for UT1-UTC determination together with the partner station Ishioka in Japan. These sessions were observed on Saturdays and Sundays, and 36 of the sessions involved both OTT. The remaining 48 sessions were observed with either Oe or Ow due to various reasons. For example, Ow did not participate from March through early May because its DBBC3 was in Bonn for upgrade. In late May Oe did not participate due to ongoing paint work on the telescope. In early June Oe did not participate due to interlock problems. In early July Oe did not participate due to a problem with the AC unit in the azimuth cabin. The raw data from Onsala were e-transferred to GSI in Tsukuba for correlation and creation of vgosDbs.

In December 2022, Oe observed five VGOS-INT-A (V2) sessions for UT1-UTC determination. A sixth planned session was cancelled due to a power outage at Kokee Park. The observed data were sent for correlation to the USNO Washington correlator, and UT1-UTC results were determined within about 24 hours.

5 Local Interferometry Observations

In 2021 and 2022 we performed 13 and nine, respectively, local interferometric 24-hour sessions involving the Onsala 20-m telescope and the OTT. These so-called ONTIE-sessions use a special X-band frequency setup that is adjusted for the local RFI environment at Onsala. The sessions were planned, scheduled, observed, correlated, fringe-fitted, and analyzed at Onsala. The majority of the sessions were 24-hour long during which typically more than 1,000 scans were observed. One of the 2022 sessions failed and could not be used to create a vgosDb. Some details are provided in [1, 2].

In 2021 we also performed 91 short (20-minute) flux-monitoring sessions with the OTT as a standalone instrument. These flux-monitoring (FM) sessions were scheduled, correlated, and analyzed at Onsala [3].

6 Monitoring Activities

We continued with monitoring activities:

Pressure sensors. In addition to the primary barometer at the Onsala site, the measurements of which are archived in the observational log files, several others are operated as a back-up resource. During 2021–2022, levelling was carried out in order to determine the height of each sensor. Analysis of these data together with differences of the observed pressure is ongoing in order to evaluate their accuracy at an absolute level. Because the pressure at sea level roughly decreases by 0.1 hPa/m, and the zenith hydrostatic delay has a sensitivity of ≈ 2.3 mm/hPa, the required accuracy of the levelling is rather modest, say at the centimeter level.

Vertical changes of the 20-m telescope tower.

We continue to monitor the vertical changes of the telescope tower using the invar rod system at the 20-m telescope. The measurements are available at <http://wx.oso.chalmers.se/pisa/>.

The local geodetic network. During the summer of 2022 a re-survey of the local geodetic network at the Onsala Space Observatory was carried out as part of a student project in collaboration with colleagues from the Frankfurt University of Applied Sciences, Germany. This included both measurements with levelling instruments as well as total stations. The vertical positions of the various meteorological stations at the observatory were determined as well.

Superconducting gravimetry. The superconducting gravimeter (SG) operated continuously during 2021 and 2022 and produced a highly accurate record of gravity variations. As part of the regular maintenance, the cold head was changed on September 30, 2021. A higher noise background was observed at low frequency (around 0.02 Hz). The problem was eventually found to be a physical contact between the coldhead and the neck of the SG's dewar. Uplifting the coldhead by a few mm solved the issue. The next coldhead swap was done on December 6, 2022. In October and December 2022 the SG had some power issues that tended to trigger spikes in the data. This was due to an excessive power load applied to the continuous self-levelling system of the device. Under the guidance of the manufacturer GWR, we adjusted the tilts of the gravimeter to reduce that load, and the spikes stopped occurring after that. Tide solutions were prepared on a weekly basis, and results are available on the SG homepage (<http://holt.oso.chalmers.se/hgs/SCG/toe/toe.html>).

Absolute gravimetry. Lantmäteriet visited the observatory twice with their FG5 instrument in 2021 and 2022. In 2022 we also hosted the NKG absolute gravimeter intercomparison at Onsala. Comparing absolute gravimeters is necessary to assess the accuracy of these instruments. The comparison was arranged as an additional comparison according to the CCM-IAG strategy for Metrology in absolute gravimetry. To guarantee traceability to the SI, its results will be linked to the International and European key comparisons (CCM.G-K2.2017 and EURAMET.M.G-K3) through

joint participants. The intercomparison campaign was held during seven weeks between May and July in 2022. In total 15 different instruments participated, of which five were from the Nordic countries. Both ballistic (FG5X, FG5, and A10) and quantum (AQG) absolute gravimeters participated in the intercomparison. The SG, located at Onsala, continuously kept track of local gravity variations, especially due to hydrological effects. It allows proper comparison of all absolute gravity measurements across the seven week duration of the intercomparison campaign.

Seismological observations. The seismometer owned by Uppsala University and the Swedish National Seismic Network (SNSN) was operated throughout the two-year period.

Water vapor radiometry. The water vapor radiometers (WVR) at Onsala, Astrid, and Konrad, are designed to measure the sky brightness temperatures at 21 GHz and 31 GHz from which the radio wave propagation delay in the atmosphere can be inferred. As reported earlier, Astrid failed during a thunderstorm in 2019, and it is unclear whether it will be operational again. If so, it will be observing towards a specific position on the sky, i.e., it will not be steerable. During 2021 Konrad was operating from April 1, 2021 to September 30, 2021. Occasionally occurring gain jumps were identified to be caused by a slightly broken waveguide which was repaired while the WVR was in the electronic lab during the first three months of 2021. In spite of the gain jumps, horizontal gradients of high quality could be estimated and used to assess four different GNSS stations at the Onsala site [4]. Starting in October 2021, maintenance was carried out until January 12, 2022. An unstable power supply was replaced as well as the more than ten-year old control and data acquisition computer. During 2022 Konrad was operating from January 12 to the end of the year. There were just a few data gaps due to computer failure, internet failure, and human interference, in total a few days. The largest loss of data was due to rain, or very heavy clouds, in the observed volume of air, which causes the retrieval algorithm to suffer from large uncertainties. In 2022 useful data were acquired during $\approx 82\%$ of the year. A new radiometer was ordered in 2022 and is expected to be delivered in the spring of 2023.

Tide gauge measurements. The official tide gauge station at Onsala is a part of the national observational network for sea level operated by the Swedish Meteorological and Hydrological Institute (SMHI). The data are available via SMHI web pages (open access). It has been in continuous operation since the summer of 2015. The Onsala tide gauge station ran uninterrupted for the entire year of 2021, excluding the yearly cleaning of the well and a sensor calibration campaign, when we artificially controlled the sea level in the well, causing a data gap of less than six hours on July 6, 2021. A second data gap of two hours occurred on August 27, 2021 when new nozzles for the pneumatic sensors were installed. During 2022 the Onsala tide gauge station ran uninterrupted for the entire year, excluding the yearly cleaning of the well, causing a data gap of less than three hours on August 10, 2022.

Onsala's other GNSS-based tide gauge was also operational continuously during 2021 and 2022, providing observations with a sampling rate of 1 Hz. The data records are nearly complete, and the data are stored in Receiver Independent Exchange Format (RINEX) format including multi-GNSS (i.e. GPS, GLONASS, Galileo, and Beidou) code- and carrierphase observations as well as signal-to-noise ratio (SNR) measurements.

7 Future Plans

In the coming two years we plan to

- participate in about 50 IVS legacy S/X sessions per year with the 20-m telescope,
- participate in as many VGOS sessions as possible,
- continue the local interferometric measurements with the Onsala telescope cluster on a regular basis,
- run an Onsala flux-monitoring program,
- continue the work concerning local tie vectors between the telescopes' reference points using classical geodetic observations as well as with gimbal-mounted GNSS-antennas on the telescopes, and
- continue the monitoring activities.

References

1. Varenus E, Haas R, Nilsson T (2021) Short-baseline interferometry local-tie experiments at the Onsala Space Observatory. *J. Geod.*, 95:54, doi:10.1007/s00190-021-01509-5
2. Handirk R, Varenus E, Nilsson T, Haas R (2023) Obtaining Local-Tie Vectors from Short-Baseline Interferometry. In: K. L. Armstrong, D. Behrend, K. D. Baver (eds.) *IVS 2022 General Meeting Proceedings*, NASA/CP-20220018789
3. Varenus E, Maio F, Le Bail K, Haas R (2022) Broad band flux-density monitoring of radio sources with the Onsala twin telescopes. *Exp Astron* 54, 137–155. doi:10.1007/s10686-022-09867-4
4. Elgered G, Ning T, Diamantidis P-K, Nilsson T J (2023) Assessment of GNSS stations using atmospheric horizontal gradients and microwave radiometry. Manuscript submitted to *Adv. Space Res.*

“Quasar” VLBI Network Stations 2021–2022 Report

Dmitry Ivanov, Alexander Ipatov, Dmitry Marshalov, Gennady Ilin

Abstract The current status and activities in 2021 and 2022 of the “Quasar” VLBI network stations are presented.

2,000 to 6,000 km. During 2021–2022, significant efforts were directed to improve the characteristics of the observatory equipment and increase its reliability.

1 General Information

The “Quasar” VLBI network is a unique Russian astronomical instrument created at the Institute of Applied Astronomy of the Russian Academy of Sciences (IAA RAS) [1].

The “Quasar” VLBI network includes three observatories located on the territory of the Russian Federation: Svetloe observatory in the Leningrad region, Badary observatory in Eastern Siberia, and Zelenchukskaya observatory in the North Caucasus (Figure 1). All observatories are equipped by radio telescopes RT-32 and RT-13 with mirror diameter of 32 and 13 meters, as well as GNSS receivers, satellite laser ranging systems, water vapor radiometers, and a weather station.

At present, a fourth observatory is included at the IAA RAS. The new observatory is located in the Far East, near the city of Ussuriysk. We plan to build a VGOS radio telescope at this observatory to carry out geodetic VLBI observations. The parameters of the future radio telescope are assumed to be identical to the parameters of the existing RT-13 radio telescopes. In a new configuration, the “Quasar” VLBI network will carry out VLBI observations with a cadence of 100–120 per hour with baseline lengths varying from



Fig. 1 Zelenchukskaya observatory.

2 Staff

The staff of the “Quasar” VLBI observatories has not changed compared to that given in the report 2019–2020 [2].

3 Current Status and Activities

During 2021–2022, the RT-32 and the RT-13 radio telescopes of the “Quasar” VLBI network participated in

IAA RAS

IAA Network Stations (“Quasar” VLBI Network Stations)

IVS 2021+2022 Biennial Report

both IVS and domestic VLBI observations. Activities of the observatories are presented in Tables 1 and 2.

Table 1 VLBI observations with the RT-32 radio telescopes.

Sessions	Sv		Zc		Bd	
	2021	2022	2021	2022	2021	2022
IVS-R1	11	10	19	11	12	13
IVS-R4	15	13	17	20	24	15
IVS-T2/IVS-T2P	2	2	2	2	2	2
CRF				3	3	3
IVS-Intensive	13	10				
RI	36	38	347	339	347	353

Table 2 VLBI observations with the RT-13 radio telescopes.

Sessions	Sw		Zv		Bv	
	2021	2022	2021	2022	2021	2022
R	1377	1627	1380	1641	1379	1648
RI-RT13			347		347	
24-h		4		4		4
X (S/X/Ka)	349	337	352	342	333	337

In 2021–2022 we performed some significant repair and upgrade works at the RT-32 telescopes. At the Zelenchukskaya observatory, the running wheel and the central bearing of the RT-32 radio telescope were replaced. At the Svetloe observatory, work has been done to replace cables in RT-32 cable loops. In all observatories, regular monitoring of radio interference was carried out and measures of state control were taken to limit the growth of RFI sources.

3.1 Absolute Gravimeter

A new gravimetric station was created at the Svetloe observatory in 2021. In the gravimetric pavilion, a decoupled foundation was built, on which the absolute ballistic gravimeter “LIAG-4” was installed (Figure 2). In ten series of 100 measurements, the LIAG-4 gravimeter shows measurements with an accuracy (rms) of no more than $4 \mu\text{Gal}$ ($4 \cdot 10^{-8} \text{ m/s}^2$).



Fig. 2 Absolute ballistic gravimeter “LIAG-4” (bottom right corner) at Svetloe observatory.

3.2 Water Vapor Radiometer

The “Quasar” VLBI network observatories are equipped with water vapor radiometers that operate continuously in automatic mode. Data processing is carried out in real time.

3.3 Multifunctional Digital Backend

The Multifunctional Digital Backend (MDBE) has been successfully operating on the RT-13 at Svetloe observatory since the end of 2020 [2]. For use on the RT-32, the MDBE was supplemented with intermediate frequency distribution modules and firmware with VLBI modes with narrow bands, and wideband radiometric and spectral selective radiometer modes (see more details in the IAA Technology Development Center Report for 2021–2022).

The first modified MDBE sample was installed at Svetloe observatory in the autumn of 2022. The system is located in the moving part of the radio telescope. To transmit the 100-MHz reference frequency signal to the moving part, a fiber-optic communication line is used. The MDBE works in parallel with the standard signal conversion system R1002M, which allows it to be tested and debugged. Twice a week, regular VLBI sessions are held for the operational determination of time using this system.

Next year we plan to install these systems on the RT-32 radio telescopes at the Zelenchukskaya and Badary observatories.

4 Future Plans

In the next two years all stations of the “Quasar” VLBI network plan to continue to participate in IVS and domestic VLBI observations. Further support of station equipment will continue in order to upgrade and replace obsolete equipment.

References

1. N. Shuygina, D. Ivanov, A. Ipatov et al., “Russian VLBI network “Quasar”: Current status and outlook”, in: *Geodesy and Geodynamics* 10 (2019), DOI: 10.1016/j.geog.2018.09.00, pp. 150–156
2. D. Marshalov, E. Nosov, G. Ilin, E. Khvostov, V. Bykov, A. Isaenko, V. Stempkovskiy, A. Shishikin “IAA Technology Development Center Report for 2019–2020”, in: *International VLBI Service for Geodesy and Astrometry 2019+2020 Biennial Report*, edited by D. Behrend, K. L. Armstrong, and K. D. Baver, NASA/TP-20210021389, pp. 279–282, 2021.

RAEGE Santa Maria Station 2021–2022 Report

João Salmim Ferreira¹, Abel García-Castellano^{1,2}, Mariana Moreira^{1,3}, Diogo Avelar¹, Valente Cuambe^{1,3}, José A. López-Pérez², Guilherme Soares¹, Nuno Mata¹, Valério Pacheco¹, Sérgio Chaves¹, Raquel Ribeiro¹, Elsa Melo¹, Francisco Wallenstein¹, Sara Pavão¹, Luísa Magalhães¹

Abstract The RAEGE Station of Santa Maria, located in the Azores archipelago (Portugal), is one of the four stations of the RAEGE Network. Highlights for this period include the installation of a new VGOS broadband receiver, the determination of the local tie pillars position, and the continuing improvements of the signal chain. In this report we present the station staff, equipment, and an activity summary for the years 2021 and 2022.

1 General Information

The RAEGE network (Portuguese/Spanish acronym for Atlantic Network of Geodynamic and Space Stations) is a cooperation project between the National Geographic Institute of Spain (IGN Spain) and the Regional Government of the Azores [1]. It is a unique geodesy project committed to the construction and operation of four Fundamental Geodetic Stations: Yebes and Gran Canaria stations in Spain and Flores and Santa Maria stations in the Azores, Portugal.

In 2017, the Government of the Azores created Associação RAEGE Açores (RAEGE-Az) to: a) implement RAEGE's infrastructures in the Azores and manage its activities; b) set up an R&D infrastructure and team dedicated to space and space-geodetic related activities, and c) communicate space science within the Azores, among other objectives. The RAEGE station

1. RAEGE-Az—Associação RAEGE Açores, Santa Maria
2. National Geographic Institute of Spain
3. Atlantic International Research Centre, Terceira

Santa Maria Network Station

IVS 2021+2022 Biennial Report

of Santa Maria is managed by RAEGE-Az with direct support and supervision from the Government of the Azores and the IGN Spain [2].



Fig. 1 RAEGE Santa Maria radio telescope and control building.

The RAEGE station of Santa Maria is located in Santa Maria, the easternmost island of the Azores archipelago, in Portugal (Figure 1). The environment in the Azores is quite extreme in terms of humidity levels (above 78% relative humidity annual average) and in terms of salinity due to the islands' dimensions, orography, and exposure to oceanic winds. The station has a 13.2-m dish radio telescope (VGOS-like), and its invariant position is described in Table 1.

Table 1 Invariant position of Santa Maria VLBI radio telescope based on ITRF2020 solution [3].

LATITUDE	LONGITUDE	ALTITUDE
36°59'07.02463"	-25°07'33.22150"	301.741 m

2 Component Description

2.1 S/X Legacy Receiver

Until September 2022, the radio telescope was equipped with a tri-band (S/X/Ka) low-noise cryogenic receiver that operated simultaneously in the three distinct bands: S (2.2–2.7 GHz), X (7.5–9 GHz), and Ka (28–33 GHz). It produced dual-circular polarization, and its measured average equivalent noise temperature was 21 K for S-band, 23 K for X-band, and 25 K for Ka-band [4]. The output signals from the cryostat were sent to their corresponding room-temperature downconverters placed in the receiver trolley for later amplification, filtering, and mixing. The final IF signal ranged from 500 to 1000 MHz in S and Ka bands and from 100 to 1000 MHz in X-band. As backend equipment, a HatLab DBBC2 was used for digitization and channeling, and two MIT Mark 5B units were used for recording and sending data via e-transfer.

2.2 VGOS Broadband Receiver

In October 2022, the new VGOS ultra-broadband receiver developed by the Yebes Observatory was installed. The cryostat contains a Quadruple-Ridge Flared Horn (QRFH) from 2 to 14 GHz, providing dual-linear polarization and balanced low-noise amplifiers. The receiver trolley also includes filtering and pre-amplification modules (FPU). The measured average receiver noise temperature is 12.5 K in the 3–14 GHz range (see Figure 2).

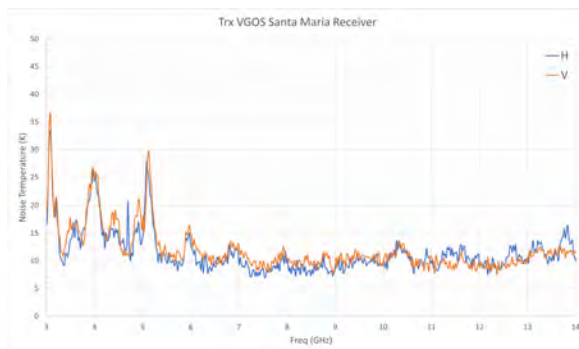

Fig. 2 VGOS receiver noise temperature [5].

The backend data chain is now made of a filter bank that, together with three downconverters, results in baseband outputs with a bandwidth of 2 GHz, in each polarization, from 2 to 14 GHz. For the digitization and channeling, Santa Maria is now using a HatLab DBBC3, and for the recording, two MIT Mark 6 units with expansion chassis. Nowadays, the total recording capacity is approximately 384 TB.

3 Staff

During 2021–2022, the Santa Maria Station established a team of 10 people (Figure 3): one IT technician, two maintenance technicians, one administrative officer, one marketing and science communication officer, three engineers and one astrophysicist for technical coordination and R&D projects duties, and the station director.



Fig. 3 RAEGE Santa Maria staff 2021–2022.

Diogo Avelar (fourth from the left in the top row) and Abel García (last from the left on the bottom row) have an MSc degree in Electronics and Telecommunications Engineering, and both give support to hardware and software issues in the VLBI operation and for the signal chain technological improvements. Mariana Moreira (first from the left in the top row) has an MSc in Aerospace Engineering and is part of the RAEGE Analysis Group in charge of VLBI data post-processing and analysis. Valente Cuambe (third from the left in the bottom row) has a Ph.D. in Astrophysics and is the astronomer on duty to support the VLBI op-

erations. João Salmim Ferreira (fourth from the left in the bottom row) has an MSc in Aerospace Engineering and is the Station Director. All of the above members are directly involved in the geodetic VLBI activity and are also responsible for the radio telescope operation.

4 Current Status and Activities 2021–2022

4.1 Corrective Maintenance

Due to the environmental conditions in the Azores, all the materials (especially the metallic parts) are extremely prone to corrosion. During the report period, several parts of the radio telescope had to be replaced by equivalent parts in stainless steel. Every year during spring, the antenna structure is subjected to a deep cleaning procedure to remove the moss that generally grows during winter and to general corrosion removal and repainting works. Concerning this topic, the major intervention performed was the replacement of the servomechanism container with a new one in early 2021 following the collapse of the container floor structure. The surrounding area of the new container was modified to improve the airflow and reduce condensation and zones with water accumulation.

Another major repair consisted of the recovery of the positioning encoder system in the azimuth axis in March 2021. The system comprises a large round tape and four encoder heads that read the tape marks at each axis of movement. The tape of the azimuth axis was found with scratches and with the marks faded in some areas, which caused the encoder heads to trigger errors at given radio telescope motion speeds. As no repair was possible, the encoder tape was replaced and the positioning system recalibrated.

The cable wrap is another system that must be inspected regularly for damages. After the rupture of the cable chain in the RAEGE Yebes antenna, an extensive assessment of the system in Santa Maria was made. It was found that when the antenna is in one of the azimuth extreme positions, the pins that support the wrap structure sometimes fail and get stuck, which can cause the rupture of the cable wrap chain. The support structure was tuned and repositioned at the end of 2022. The system range of operation is still limited between the 0° and 420° azimuth positions, and it will remain un-

der monitoring until we are confident that it can return to full range of operation.

4.2 Legacy S/X Operation

From May 2021 to the end of September 2022, the RAEGE Santa Maria station participated in 109 IVS R1 and R4 sessions, contributing to the IVS legacy network. Among these sessions, 95% were successfully correlated, and 73% of the scheduled observations were used in the analysis. Notably, the comparison between 2021 and 2022 shows an increase of 12% in the scheduled observations used for VLBI data analysis, as shown in Figure 4. The improvement in the amount of data used in the analysis demonstrates the enhancement in the station's data quality over time.

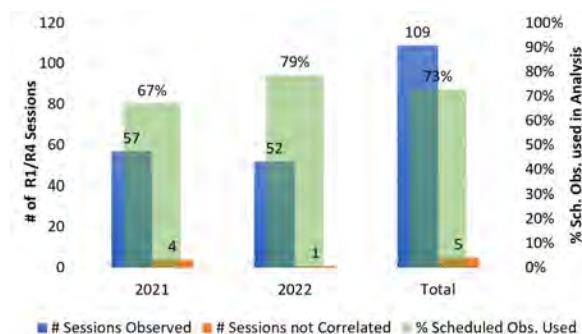

Fig. 4 Legacy S/X sessions 2021–2022 overview.

4.3 VGOS and Y-Intensives Operation

In November and December of 2022, the RAEGE Santa Maria Station participated in a series of Intensive sessions in collaboration with the Goddard and Yebes observatories. These included five one-hour sessions and five 15-minute test sessions, all conducted using the newly installed VGOS receiver. In these sessions, the correlators successfully detected fringes on the Santa Maria baselines. During the same period, Santa Maria did not participate in any IVS sessions for the VGOS network due to the ongoing tests and calibrations of the new equipment on the same days

of the VGOS sessions correlated by the Haystack Observatory.

4.4 Tri-Band Receiver Stability Tests

In 2021, with the tri-band receiver still installed, the signal chain gain stability was studied. We found that the system temperature (T_{sys}) measured varied significantly in the short term, even when observing the same reference source (such as TAU-A) successively at the same elevation. To confirm if the noise calibration diode was the reason for this issue, T_{sys} calibrations were compared with the System Equivalent Flux Density (SEFD) calibrations carried out in sequence.

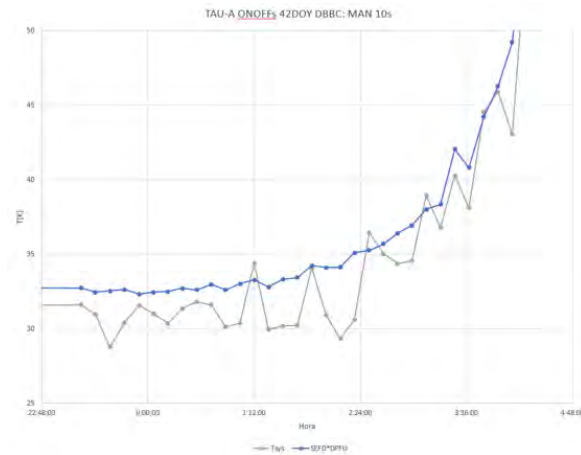

Fig. 5 System temperature (gray) vs SEFD*DPFU (blue) measured observing TAU-A [6].

Both curves present the same behavior, but the T_{sys} curve is noisier. Two hypotheses could explain this effect: a) the noise calibration diode isn't stable or b) the sensitivity is limited, and this is notable with the diode ($T_{\text{cal}} = 1.2 \text{ K}$), and it isn't when tracking TAU-A (16 K approximately). To confirm this, the same test was done with a weaker source (3C84, with 50 Jy at X-band – see [6]). Fluctuations in T_{sys} and SEFD are comparable, which suggests that the receiver gain stability was limiting its sensitivity (refer to [6] for more information).

4.5 Maser Behavior

In October 2022, after a checkup of the maser by the manufacturer, the drift of the maser was adjusted to be on the order of 10^{-13} when compared to the GPS signal. With such a small drift, an unexpected, non-linear behavior was identified when looking at long data sets.



Fig. 6 Time difference between GPS and Maser PPS signal during 84 hours in December 2022.

After checking the signal frequency response, it was clear that the repeatability had a daily frequency (see Figure 6). Some additional tests led us to conclude that there is a direct relation between the GPS-Maser difference and the ambient temperature measured by the sensor in the maser room. It was also concluded that the maximum daily deviation from the linear regression is about 13 ns.

4.6 RFI Measurements

During the period of 2021–2022, several RFI measurements were carried out in the RAEGE station of Santa Maria. An RFI survey from 0.5 to 20 GHz was done in January 2022 and compared to the one performed in 2010. Additionally, RFI measurements were performed at 2.9 GHz after receiving a new RFI signal from a radar installation in the surroundings.

The integrated power flux between 2.92 and 2.98 GHz is -46.5 dBW/m^2 , which becomes 2.7 dBm at the input of the low noise amplifier in the worst case (pointing the radio telescope towards the radar). This power level is 37 dB above the gain compression and very close to the LNA damaging input level, making it impossible to perform any observation. In the Fu-

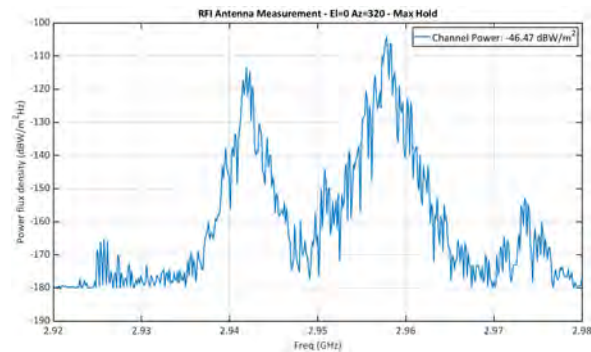

Fig. 7 Radar RFI spectrum.

ture Plans section, some mitigation solutions are introduced.

One of the problems solved when still doing legacy observations was a noisy phase cal tone. One of the RFI sources was the radio telescope motor system, injecting an 8-kHz tone through the electrical power supply line. The problem was solved by installing one line filter at the elevation cabin power supply line and another in the receiver trolley power supply line (refer to [6]).

4.7 Local Tie

In September 2022, IGN Spain staff were in Santa Maria station to develop a plan for establishing the local tie pillars position. The differential coordinates, or local tie vectors, between the invariant reference points of the instruments present at the station, namely RAEG GNSS, AZSM GNSS, and the VLBI radio telescope, were determined. The local ties were surveyed precisely in three dimensions using classical and GNSS surveying techniques. The planning process concluded that six pillars are needed to link the station’s current geodetic techniques and accommodate potential future installations (see Figure 8).

4.8 RAEGE Analysis Group

The RAEGE Project does not focus only on instrumentation and on operating the observations but also on developing analytical skills that allow RAEGE observatories to exploit the geodetic observations. Hence, a RAEGE Analysis Group was established in 2021. This

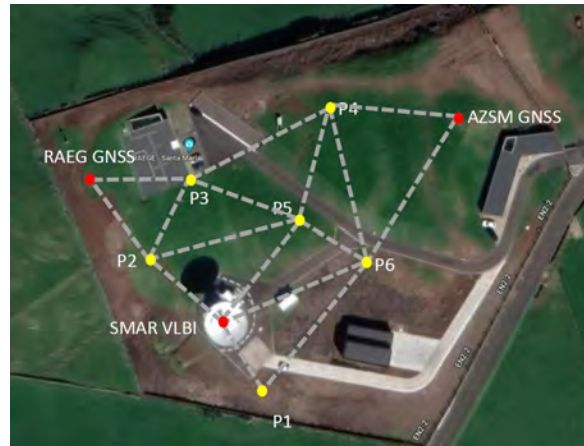

Fig. 8 RAEGE Santa Maria future local tie network [9].

group includes collaborators from the IGN Spain, the RAEGE observatories of Yebes and Santa Maria, and two researchers from the University of Alicante who joined in 2022. The group aims to promote VLBI analysis activities within the RAEGE Project, expand research activities, and facilitate participation in international projects and interactions with other groups.

The primary research focus during 2021 and 2022 has been on R1, R4, and VGOS sessions as well as multi-technique analysis by comparing VLBI and GNSS products at co-location sites. The RAEGE Analysis Group presented several contributions, including “Consistency of VLBI estimates in the CONT17 campaign” at EVGA 2021 [7] and “Analysis of VGOS sessions: Evaluation of performance with different software” at the IVS 2022 General Meeting [8], among others.

5 Future Plans

For the near future, the focus will be on calibrating all the new backend equipment to cope with VGOS quality requirements. Due to the strong RFI signal transmission near the Santa Maria station, a high-pass COTS filter rejecting 2–4 GHz will be installed in early 2023 to allow the operation of the radio telescope with no danger of damaging the receiver LNAs, entailing the loss of VGOS band A data (filter already installed at the time of writing). A superconducting notch filter is being developed by the Yebes Technological

Development Center [5] and is planned to be installed in mid-2023. Meanwhile, the admission of Santa Maria as a tag-along to the VGOS network is in discussion. For 2023, it is also planned to construct the local tie pillars. Concerning the RAEGE Analysis Group, exploring the capabilities of the complete RAEGE network in ‘stand-alone’ mode will be one of the main topics.

References

1. <https://www.raege.eu>
2. <https://www.raege-az.pt>
3. <https://itrf.ign.fr/en/solutions/itrf2020>
4. López-Pérez, José A. et al.; A Tri-band Cooled Receiver for Geodetic VLBI. *Sensors* 2021, 21, 2662 doi:10.3390/s21082662
5. López-Pérez, José A. et al.; IGN Yebes Observatory Technological Development Center 2021–2022 Biennial Report In K. L. Armstrong, D. Behrend, and K. D. Baver, editors, in *International IVS Biennial Report 2021–2022*, this volume, 2023.
6. Salmim Ferreira, J., García-Castellano, A., López-Pérez, José. A., Moreira, M., Avelar, D., Cuambe, V., Wallenstein, F., González-García, J. and Albo-Castaño, C.; RAEGE Santa Maria: Station Overview. in *International VLBI Service for Geodesy and Astrometry 2022 General Meeting Proceedings*. edited by Kyla L. Armstrong, Dirk Behrend, and Karen D. Baver, NASA/CP-20220018789, pp. 42–46, 2023.
7. Azcue, E., Puente, V., Martínez-Sánchez, E., and Moreira, M.; Consistency of VLBI estimates in the CONT17 campaign. In *25th European VLBI Group for Geodesy and Astronomy working Meeting (March 2021) book of abstracts* pp. 58.
8. Azcue, E., Puente, V., Moreira, M., and Martínez-Sánchez, E.; Analysis of VGOS Sessions: Evaluation of Performance with Different Software. in *International VLBI Service for Geodesy and Astrometry 2022 General Meeting Proceedings*, NASA/CP-20220018789, pp. 197–201, 2023.
9. Azcue, E. and Martínez-Sánchez, E.; Activities carried out at RAEGE SMAR Station, 2022.

Shanghai Station Report for 2021–2022

Bo Xia¹, Qinghui Liu¹, Zhiqiang Shen¹

Abstract In this report we summarize the observing activities at the Sheshan station (SESHAN25) and the Tianma station (TIANMA65) in 2021 and 2022. We include the international VLBI observations for astrometry, geodesy, and astrophysics as well as domestic observations for satellite tracking. We also report on updates and new developments of the facilities at the two stations.

1 General Information

The Sheshan station (SESHAN25) is located at Sheshan, 30 km west of Shanghai. It is hosted by the Shanghai Astronomical Observatory (SHAO), at the Chinese Academy of Sciences (CAS). A 25-meter radio telescope is in operation at 3.6/13, 5, 6, and 18 cm wavelengths. The Sheshan VLBI station is a member of the IVS and EVN.

The Tianma station (TIANMA65) is located in the western suburbs of Shanghai, Sheshan town, Songjiang district. It is jointly funded by CAS, the Shanghai Municipality, and the Chinese Lunar Exploration Program. The telescope construction started in the early 2009, and the majority of the mechanical system was completed in October 2012. On December 2, 2013, the Tianma 65-m telescope passed the acceptance evaluation. By design, the Tianma telescope with a diameter of 65 meters, one of the largest steerable radio telescopes in the world, is a multifunction facility, conduct-

ing, astrophysics, geodesy, astrometry, as well as space science. At the end of 2014, TIANMA65 had installed five cryogenic receiver systems (L, C, S/X, and Ku). Two further high-frequency cryogenic receiver systems (Ka, Q) were finished in 2015. A K-band cryogenic receiver system was installed at the end of the 2016. The VLBI terminal of the Tianma 65-m telescope houses a CDAS and DBBC2.

The SESHAN25 and TIANMA65 telescopes take part in international VLBI experiments on astrometric, geodetic, and astrophysical research work. Apart from its international VLBI activities, the telescope spent a large amount of time on the Chinese Lunar Project, including the testing before the launch of the Chang'E test satellite, and the tracking campaign after its launch as well as other single dish observations.

2 Activities during the Past Two Years

In 2021, the SESHAN25 telescope participated in 74

Table 1 Participation of the SHAO stations in IVS sessions in 2021 and 2022.

Session Name	2021(SH)	2022(SH)	2021(T6)	2022 (T6)
AOV	11	4	0	1
APSG	2	1	1	0
IVS-R1	20	8	0	0
IVS-T2P	2	1	0	0
IVS-RDV	6	4	0	0
IVS-R&D	1	0	0	2
IVS-INT1	0	4	0	0
IVS-INT3	32	14	0	0

1. Shanghai Astronomical Observatory, Shanghai, China

SHAO Network Station

IVS sessions (including 32 INT3 Intensive sessions), while TIANMA65 participated in one IVS session. In 2022, SESHAN25 participated in 36 IVS sessions (including 18 INT2/INT3 Intensive sessions), and TIANMA65 participated in three IVS sessions.

3 Current Status

3.1 Antenna Maintenance of SESHAN25

The Shanghai 25-m radio telescope was built in 1986 and it now faces the problems of load-carrying capacity of components weakening and steel corrosion. From September to November 2022, we brush painted and reinforced the structure of this telescope, ensuring the safety and stability of the structure and prolonging its service life.



Fig. 1 Structure reinforcement.

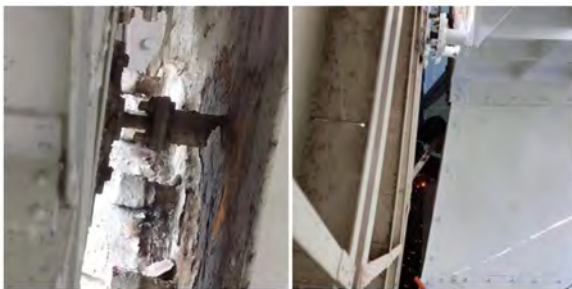

Fig. 2 Replacement of supporting bars.

3.2 Antenna Maintenance of TIANMA65

In 2022, the maintenance of the Tianma radio telescope focused on replacing the gear oil, replacing screw spacers, and checking grease status of adjusting mechanism of subreflector surface, which provides the guarantee for stable operation of telescope.

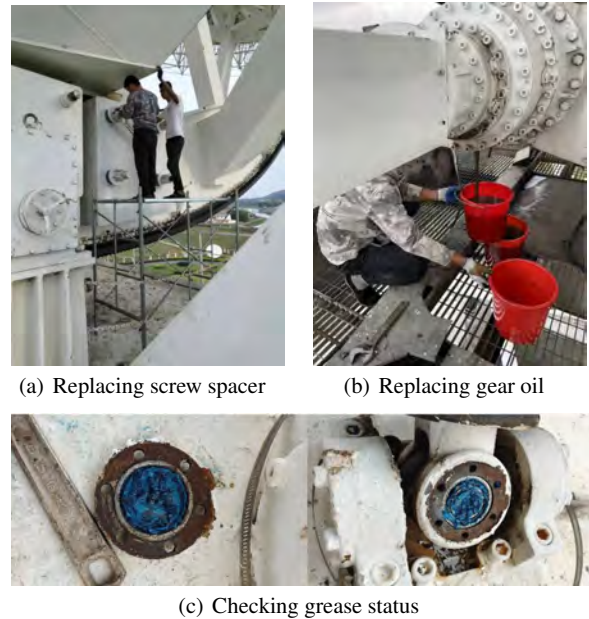

Fig. 3 Antenna maintenance on the Tianma 65-m telescope.

3.3 Other Tasks

The current lunar mission is in the long-term management stage. Observations are performed 1–2 times per week.

4 Staff of the Shanghai VLBI Station

Table 2 lists the group members at the Shanghai VLBI Station. The staff is involved in the VLBI program at the station with various responsibilities.

Table 2 Staff at the Shanghai VLBI station. All e-mail addresses end with @shao.ac.cn.

Name E-mail	Background	Position and Duty
Zhiqiang Shen zshen	Astrophysics	Deputy Director
Qinghui Liu liuqh	Radio Technique	Chief Engineer
Bin Li bing	Microwave	Technical friend, Receiver
Bo Xia bxia	Electronics	VLBI friend, VLBI terminal
Jinqing Wang jqwang	Electronics	Engineer, Antenna
Lingling Wang llwang	Software	Engineer, Timing system
Rongbing Zhao zhaorb	Software	Engineer, Antenna software
Li Fu fuli	Ant. mechanical	Engineer, Antenna
Qian Ye yeqian	Active surface	Engineer, Antenna
Weiye Zhong wyzhong	Microwave	Engineer, Receiver
Chao Zhang zhangchao	Microwave	Engineer, Receiver
Linfeng Yu lfyu	Electronics	Engineer
Yongbin Jiang jyb	Electronics	Engineer
Wen Gou gw	Electronics	Engineer
Yongchen Jiang yongchen	Electronics	Engineer, Disk shipping
Zhiqiang Xu zqxu	Microwave	Engineer, Receiver
Zhang Zhao zhaozhang	Electronics	Engineer

5 Future Plans

In 2023, we plan to continue antenna maintenance in the first quarter of the year. The telescopes will regularly track the Chang'E-4 and Tianwen-1 satellites in their lunar orbits.

Urumqi Station Status Report for 2021–2022

Guanghui Li, Hua Zhang, Hao Yan, Lang Cui, Pengfei Jiang, Ming Zhang, Jianping Yuan

Abstract The Urumqi Nanshan station is operated by the Xinjiang Astronomical Observatory of the Chinese Academy of Sciences. This report summarizes the current characteristics, activities, and technical developments of the VLBI station facilities in 2021 and 2022.

base in the summer of 2022. All the digital facilities originally working in the observation room were dismantled and moved into the new shielding box. All the facilities are now completely remounted and working normally in the shielding box (Figure 3). The shielding effectiveness of the box is being evaluated in detail.

1 Technical Developments

In the past two years, three new wideband receivers working at Q-band, C-band, and L-band, respectively, were designed and implemented by the engineer team and have been equipped chronologically in the radio cabin of the Nanshan 26-m Radio Telescope (NSRT). The new Q-band receiver, covering frequencies of 30–50 GHz, joined fringe test observations with the EVN and EAVN from late 2021 and got fringes successfully (Figure 1). Meanwhile, the new C-band receiver, covering frequencies of 4–8 GHz, also joined fringe test observations with the EAVN and successfully got 6.7 GHz maser fringes. It is expected that the new Q- and C-band receivers could formally service the VLBI community from late 2023. The new L-band receiver, covering frequencies of 1–2 GHz, was just installed on the telescope in late 2022 (Figure 2) and now is conducting single-dish commissioning observations.

In addition, in order to mitigate the RFI mainly generated by on-site digital facilities, a walk-in electromagnetic shielding box was built under the telescope

Xinjiang Astronomical Observatory (XAO), CAS

XAO-Nanshan Network Station (Ur)

IVS 2021+2022 Biennial Report

2 VLBI Terminal Status

Currently, the VLBI terminal system at Nanshan station consists of one DBBC2, one MK5B+, one MK6, one Flexbuff, and four CDAS2s. Among them, the DBBC2 and MK5B+ are mainly used for 2 Gbps international joint observations of EVN, IVS, EAVN, etc. The CDAS2 is mainly employed in Chinese VLBI observations serving for space missions. The MK6 and Flexbuff are now under on-site testing, and newly purchased DBBC3s have arrived at Nanshan station too. In addition, we are planning to purchase another three MK6s in 2023. Based on these new terminal devices, it is expected that the Nanshan station (Ur) will be able to join normally 4 Gbps VLBI observations by the end of 2023.

3 Scheduled VLBI Observations

In 2021, there were 487 VLBI experiments conducted by the NSRT serving under the EVN, IVS, and EAVN networks, as well as domestic joint observations for space missions, with a total effective observing time of about 2,578 hours. Among these observations, there were 105 EVN runs with the total time of about 712

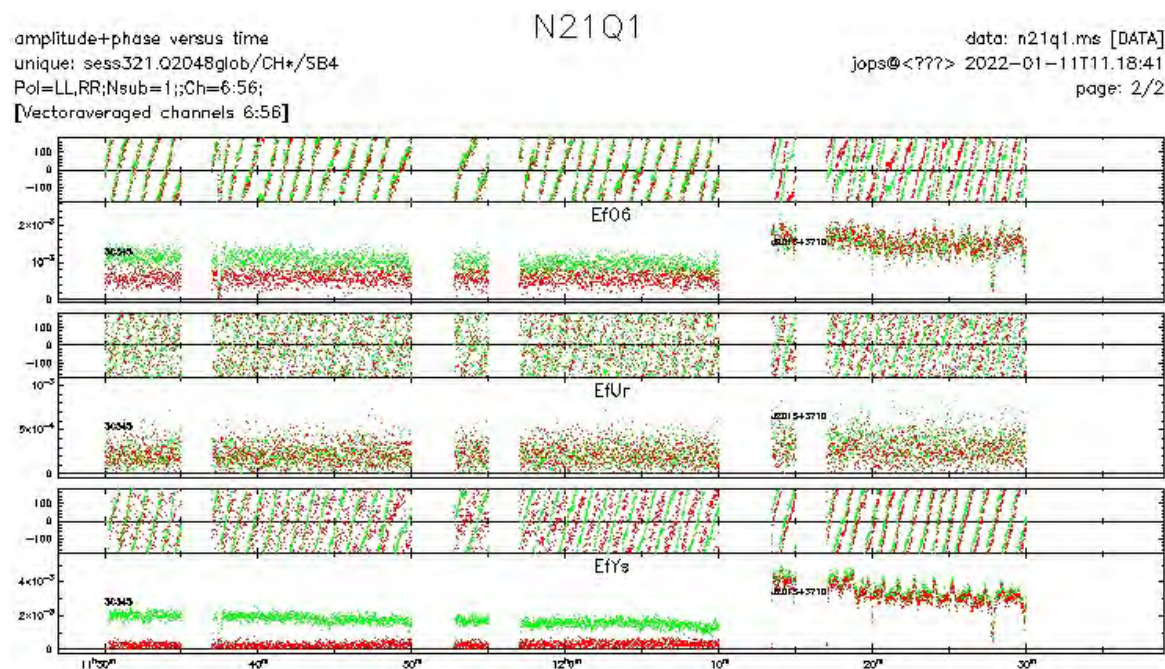

Fig. 1 The cross correlation amplitude and phase between Ef and Ur at 43 GHz, shown in the middle panel.

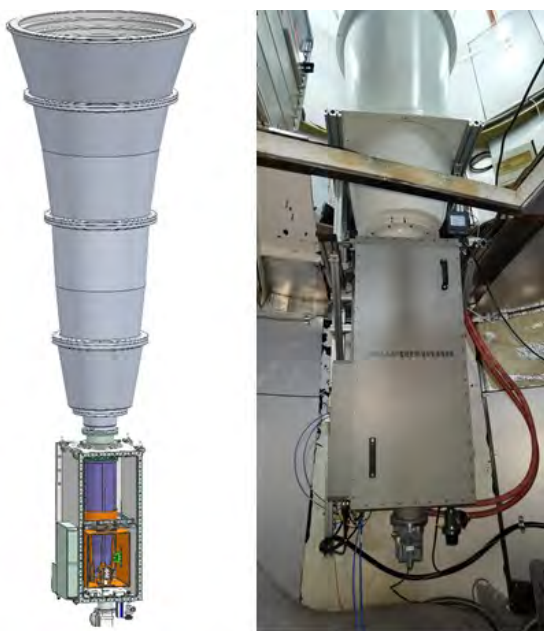

Fig. 2 The simulated picture and installation status of the new L-band receiver.

hours, including 215 hours for the EVN-FRB program. In 2022, 276 VLBI experiments were conducted for all the VLBI networks mentioned above, and the total ef-



Fig. 3 The digital backend systems for VLBI and single dish operations, working in the walk-in electromagnetic shielding box under the telescope base.

fective observing time is about 1,674 hours, of which about one half were spent serving for EVN regular observations and EVN-FRB runs.

The IVS sessions conducted by the Nanshan Station in 2021–2022 are shown in Table 1. Among them, 17 sessions were scheduled for 2021, 13 sessions were completed, and the effective observing time was about 258 hours. The unexecuted sessions are mainly due to

Table 1 IVS session statistics in 2021–2022.

No.	Observation epoch	Experiment code	Duration (hours)	Data rate (Mbps)	Data format
1	2021-007 UT18:30	R4980	Not executed	128	MK5B+
2	2021-081 UT16:30	AOV057	19	128	MK5B+
3	2021-117 UT17:30	AOV058	21	128	MK5B+
4	2021-144 UT13:00	CRF124	Not executed	128	MK5B+
5	2021-153 UT17:30	AOV060	Not executed	128	MK5B+
6	2021-180 UT17:30	CRF125	13	128	MK5B+
7	2021-189 UT18:30	R41006	24	128	MK5B+
8	2021-201 UT17:30	APSG48	21	128	MK5B+
9	2021-236 UT17:30	AOV062	24	128	MK5B+
10	2021-238 UT18:30	R41013	17	128	MK5B+
11	2021-252 UT18:30	R41015	14	128	MK5B+
12	2021-272 UT18:00	APSG49	24	128	MK5B+
13	2021-287 UT18:30	R41020	16	128	MK5B+
14	2021-320 UT17:30	AOV065	24	128	MK5B+
15	2021-321 UT18:00	CRF127	20	128	MK5B+
16	2021-322 UT18:30	R41025	21	128	MK5B+
17	2021-356 UT18:30	R41030	Not executed	128	MK5B+
1	2022-027 UT18:30	R41035	24	128	MK5B+
2	2022-048 UT18:30	R41038	24	128	MK5B+
3	2022-054 UT18:00	AOV068	24	128	MK5B+
4	2022-089 UT18:00	CRF130	24	128	MK5B+
5	2022-111 UT18:30	R41047	24	128	MK5B+
6	2022-116 UT17:30	AOV070	24	128	MK5B+
7	2022-173 UT18:00	CRF131	24	128	MK5B+
8	2022-188 UT19:00	APSG50	24	128	MK5B+
9	2022-209 UT18:30	R41061	Not executed	128	MK5B+
10	2022-216 UT19:00	AOV074	Not executed	128	MK5B+
11	2022-241 UT18:30	R41065	Not executed	128	MK5B+
12	2022-251 UT18:30	R41067	Not executed	128	MK5B+
13	2022-265 UT18:30	R41069	24 (diskpack not delivered)	128	MK5B+
14	2022-327 UT18:00	CRF133	24	128	MK5B+
15	2022-349 UT19:00	AOV078	24	128	MK5B+
16	2022-354 UT17:30	APSG51	24	128	MK5B+

Table 2 The new VLBI operation team at Ur.

Name	Position	E-mail
Hua Zhang	VLBI friend & terminal engineer	zhangh@xao.ac.cn
Hao Yan	Technical friend & receiver engineer	yanhao@xao.ac.cn
Guanghui Li	VLBI terminal engineer	ligh@xao.ac.cn
Jianping Yuan	TAC reader & scheduler	yuanjp@xao.ac.cn
Lang Cui	Head of Nanshan station & VLBI chief	cuilang@xao.ac.cn

schedule conflicts with our domestic observing missions. In 2022, 16 sessions were scheduled and 12 sessions were completed, with an effective observing time of about 288 hours. The unexecuted sessions were mainly due to the relocation of the observation equipment delayed by COVID.

4 Personnel Update

The VLBI operation team of Ur was updated in May 2022. The new personnel allocations are listed in Table. 2.

New Zealand VLBI Station Warkworth

Stuart Weston, Axl Rogers, Tim Natusch, Lewis Woodburn, Sergei Gulyaev

Abstract The Warkworth Radio Astronomical Observatory for the period 2021–2022 was operated by the Institute for Radio Astronomy and Space Research (IRASR), Auckland University of Technology (AUT), Auckland, New Zealand. It is anticipated that this arrangement will change in 2023 and is briefly discussed. Also a review of the characteristics and performance of the VLBI station facilities are presented.

1 General Information

The Warkworth Radio Astronomical Observatory 12-m antenna, shown in Figure 1, is located some 60 km north of the city of Auckland, near the township of Warkworth, on the North Island of New Zealand. Specifications of the Warkworth 12-m and 30-m antennas are provided in Table 1.

The 12-m antenna is equipped with an S/X dual-band, dual-circular polarization feed at the secondary focus, and an L-band feed at the prime focus. Backend data digitizing is handled by a digital baseband converter (DBBC) manufactured by the HAT-Lab, Catania, Italy [2].

The 30-m antenna is currently equipped with an un-cooled C-band dual-circular polarization receiver and an un-cooled X-band dual-circular polarization receiver. In addition, a 4.8-GHz un-cooled band dual-circular polarization receiver was built for RadioAstron

Institute for Radio Astronomy and Space Research, Auckland University of Technology

Warkworth Network Station

IVS 2021+2022 Biennial Report



Fig. 1 Photo of the Warkworth 12-m antenna during the southern winter of 2020 (image courtesy of Stuart Weston).

Table 1 Specifications of the Warkworth 12-m and 30-m [1] antennas.

	12-m	30-m
Antenna type	Dual-shaped Cassegrain	wheel-and-track, Cassegrain beam-waveguide
Manufacturer	Cobham/Patriot, USA	NEC, Japan
Main dish diam.	12.1 m	30.48 m
Secondary refl. diam.	1.8 m	2.715 m
Focal length	4.538 m	10.44 m
Surface accuracy	0.35 mm	1.2 mm
Mount	alt-az	alt-az
Azimuth axis range	$90^\circ \pm 270^\circ$	-179° to $+354^\circ$
Elevation axis range	7.2° to 88°	6.0° to 90.1°
Az. axis max speed	$5^\circ/\text{s}$	$0.37^\circ/\text{s}$
El. axis max speed	$1^\circ/\text{s}$	$0.36^\circ/\text{s}$

participation. We also have a separate DBBC for backend data digitizing for this antenna.

The station frequency standard is a Symmetricom Active Hydrogen Maser MHM-2010 (75001-114). We have now moved to Flexbuffs (Super-Micro servers) running jive5ab [3] for recording and data storage connected to the DBBC via fiber which allows parallel real-time streaming and recording of data. The observatory network is directly connected to the national network provided by Research and Education Advanced Network New Zealand Ltd (REANNZ) via a 10-Gbps fiber link to the site [4].

2 Status and Activities

A breakdown of IVS session types scheduled and observed over this two-year period by the Warkworth 12-m antenna is presented in Table 2 grouped by experiment type.

Table 2 Warkworth 12-m antenna participation in IVS sessions in 2021 and 2022.

Experiment	2021		2022	
	Scheduled	Observed	Scheduled	Observed
AOV	12	12	11	10
AUA	11	11	12	11
AUM	21	21	6	6
CRDS	6	5	6	5
OHIG	6	5	6	4
R1	23	12	26	18
R4	22	22	27	26
T2	2	2	–	–
Total	103	90	94	80

In 2021, the number of IVS sessions scheduled (103) for Warkworth 12-m was significantly increased w.r.t. 2019 and 2020 (59 and 41 sessions, respectively). In 2022, the number of scheduled sessions was initially scaled back, to reduce the wear and tear on the antenna. With the uncertain status of the station in the latter half of 2022, it was decided to significantly increase our commitment to IVS from that originally planned with the 12-m to try and maximize its usage in the possible time remaining. During this period we also had an extended outage due to the elevation jack screw boot being ingested inside the elevation bevel ball drive. This negatively impacted the sessions we observed compared to the number of sessions scheduled. Weather events also impacted the sessions we could observe: 13

sessions were lost in 2021 (13%) and 14 sessions were lost in 2022 (15%).

In addition, both antennas continue to be available for Australian LBA sessions each semester, with a choice of antenna dependent on frequency. Cooperation with various space agencies and companies for spacecraft tracking has also continued using the 12-m antenna, with some interest shown in using the 30 m in the future.

3 Future Status

The Auckland University of Technology decided to divest of the station in mid 2022, taking effect on the 16th of December 2022. Currently (beginning of 2023), interim funding has been provided for the next six months of operations by the New Zealand Government Ministry of Business, Innovation & Employment (MBIE), providing time to establish a consortium and new funding mechanism to assume and continue the operation of the observatory.

4 Acknowledgements

The IRASR would like to thank the IVS and other international geodetic organizations and institutes for their tremendous support in 2022 with submissions and letters of support to the New Zealand Government and others about the importance of the Ww Observatory for the global reference frame. It is felt that, to a great degree, these letters helped to inform the New Zealand Government and have allowed the observatory to continue working for at least the next six months, and it is hoped for a more extended period after June 2023. We also express our gratitude to Land Information New Zealand and the Royal Astronomical Society of New Zealand for their letters of support and invaluable assistance during the critical period and beyond.

References

1. Woodburn L, Natusch T, Weston S, Thomasson P, Godwin M, Granet C, Gulyaev S, Conversion of a New Zealand 30 metre Telecommunications antenna into a Radio Telescope,

- Publications of the Astronomical Society of Australia, Published, 2015.
2. Tuccari G, Alef W, Bertarini A, Buttaccio S, Comoretto G, Graham D, Neidhardt A, Platania PR, Russo A, Roy A, Wunderlich M, Zeithöfler R, Xiang Y, DBBC2 Backend: Status and Development Plan, In: Behrend D, Bayer KD (eds) IVS 2010 General Meeting Proceedings “VLBI2010: From Vision to Reality”, 2010, NASA/CP-2010-215864, pp 392–395, DOI 10.22323/1.344.0140, URL <http://ivscc.gsfc.nasa.gov/publications/gm2010/tuccari2.pdf>
 3. Verkouter H, jive5ab on github., URL <https://github.com/jive-vlbi/jive5ab>, Accessed: 2020-08-27
 4. Weston S, Natusch T, Gulyaev S, Radio Astronomy and e-VLBI using KAREN. In *Proceedings of the 17th Electronics New Zealand Conference*, 2010. Preprint arXiv:1011.0227.

Westford Antenna 2021+2022 Report

Mike Poirier, Alex Burns

Abstract Technical information is provided about the VLBI antenna and equipment located at the Westford site of the Haystack Observatory, which is the off-campus location of the Massachusetts Institute of Technology (MIT) in Westford, Massachusetts. Updated information is also provided about changes introduced to the VLBI systems since the last IVS Biennial Report in 2021.

1 Westford Antenna at Haystack Observatory

Since 1981, the Westford antenna has been one of the primary geodetic VLBI sites in the world. Located about 70 km northwest of Boston, Massachusetts, the antenna is part of the MIT Haystack Observatory complex (Table 1). The Westford antenna was constructed in 1961 as part of the West Ford Project by Lincoln Laboratory. The project demonstrated the feasibility of long-distance communications by bouncing radio signals off a spacecraft-deployed belt of copper dipoles flying at an altitude of about 3,600 km above the Earth's surface. The antenna was converted to geodetic use in 1981, becoming one of the first two VLBI stations of the POLARIS Project by the National Geodetic Survey (NGS). Westford has continued to perform geodetic VLBI observations on a regular basis since 1981. In recent years, Westford has been focused on, and has supported, the technology development and

operational integration of the next-generation VLBI Geodetic Observing System (also known as VGOS; e.g., Niell et al., 2018; Merkowitz et al., 2019). As the first “prototype” VGOS station, Westford continues to provide this valuable knowledge base to all of the new VGOS operational stations as they come on line around the world.



Fig. 1 Aerial view of the radome and facilities of the Westford antenna at MIT Haystack Observatory. (For scale, the diameter of the radome, which veils the 18.3-m diameter antenna, is 28 m.)

2 Technical Parameters of the Westford Antenna and Equipment

The Westford antenna is enclosed in a 28-meter air-inflated radome constructed of a 1.2-mm thick teflon fabric (Raydel R-60) (Figure 1 and Table 2). The major components of the VLBI data acquisition

MIT Haystack Observatory

Westford Antenna

IVS 2021+2022 Biennial Report

system at Westford include a VGOS broadband cryogenically-cooled receiver, RF-over-Fiber (RFoF) transmission links, an RF power distributor, four Up/Down converters (v2.1), four R2DBEs, and a Mark 6 recorder with an expansion chassis. The VGOS signal chain is controlled by the personal computer field system (PCFS) running version 10.0.0. Westford is also equipped with an MCI system, which monitors and logs parameters for key components in the system. The primary frequency standard on site is the NR-4 hydrogen maser.

Table 1 Approximate geographical location, altitude above mean sea level (m.s.l.), and shipping addresses of the Westford antenna.

Longitude	71.49° W
Latitude	42.61° N
Height above m.s.l.	116 m
MIT Haystack Observatory 99 Millstone Rd Westford, MA 01886-1299 U.S.A. https://www.haystack.mit.edu	

Table 2 Technical parameters of the Westford antenna for geodetic VLBI.

<i>Parameter</i>	<i>Westford</i>
primary reflector shape	symmetric paraboloid
primary reflector diameter	18.3 meters
primary reflector material	aluminum honeycomb
feed location	primary focus
focal length	5.5 meters
antenna mount	elevation over azimuth
antenna drives	electric (DC) motors
azimuth range	90° – 470°
elevation range	4° – 87°
azimuth slew speed	3° s ⁻¹
elevation slew speed	2° s ⁻¹
<i>Frequency range 2–14 GHz</i>	
T_{sys} at zenith	40–70 K
aperture efficiency	0.25–0.60
SEFD at zenith	1800–4500 Jy

Westford also continues to host WES2, the permanent Global Navigation Satellite System (GNSS) site of the International GNSS Service (IGS) network. The WES2 system currently consists of a Tallysman Vera-

Choke GNSS antenna and a Trimble Alloy receiver. The antenna is located on top of a tower about 60 meters from the VLBI antenna, and the receiver is housed within the Westford premises. This new receiver, as well as LMR-600 cable and an additional lightning protector, were installed in March of 2021, and the new antenna in October 2021.

3 Westford Staff

The personnel associated with the geodetic VLBI program at Westford, and their primary responsibilities, are:

- Tony Bettencourt: Technician, Observer
- Alex Burns: Technician, Observer
- Chris Eckert: Mechanical Engineer
- Pedro Elosegui: Principal Investigator
- Colin Lonsdale: Site Director
- Glenn Millson: Observer
- Arthur Niell: VLBI Science Support
- Michael Poirier: Site Manager
- Ganesh Rajagopalan: RF Engineer
- Chet Ruszczyk: Associate Principal Investigator

4 Standard Operations

From January 1, 2021 through December 31, 2022, Westford participated in 77 VGOS sessions, including three VGOS Tests (VT), 65 VGOS operational sessions (VO), and seven S/X legacy—VGOS R&D-type 24-hour sessions. Westford also supported two so-called VGOS Intensive sessions (VI and/or V2), along with many short fringe tests with other worldwide stations, thus assisting in their VGOS system configuration and operational checkout.

5 Research and Development

Presently, we are running bi-weekly 24-hour sessions supporting the core VGOS network. These sessions cover a wide range of focus from engineering testing to the standardizing of operational configuration formats supporting the expanding VGOS network.



Fig. 2 View of the Westford antenna inside the radome. The VGOS broadband receiver is located at the prime focus.

6 Outlook

Westford presently expects to continue to support the VGOS operational series of 24-hour sessions, along with supporting new development, testing, and integration of VGOS operational systems around the world.

We expect that over the next two years we will continue to upgrade our operational systems to help Westford in breaking new ground in VLBI technical development and support for the operational network of stations, along with locally running stable and consistent operations.

Acknowledgements

Funding for geodetic VLBI research and development (R&D) as well as operations at Westford is provided by the NASA Space Geodesy Program (SGP).

References

1. Niell A., J. Barrett, A. Burns, R. Cappallo, B. Corey, M. Derome, C. Eckert, et al. 2018. Demonstration of a Broadband Very Long Baseline Interferometer System: A New Instrument for High-Precision Space Geodesy. *Radio Science*, 53:1–23. doi.org/10.1029/2018RS006617.
2. Merkowitz, S. M., S. Bolotin, P. Elosegui, J. Esper, J. Gipson, L. Hilliard, E. Himwich, et al. 2019. Modernizing and Expanding the NASA Space Geodesy Network to Meet Future Geodetic Requirements. *Journal of Geodesy* 93 (11): 2263–2273. doi.org/10.1007/s00190-018-1204-5.

Geodetic Observatory Wettzell – 20-m Radio Telescope and Twin Radio Telescopes

Alexander Neidhardt¹, Christian Plötz², Gerhard Kronschnabl², Torben Schüler²

Abstract The Geodetic Observatory Wettzell, located in Germany, very successfully contributed to the IVS observing program and to some observations of the EVN in the years 2021 and 2022. Meanwhile, Wettzell supports different fields of the IVS within program coordination, observation, and correlation. Technical changes, developments, improvements, and upgrades were made to extend and increase the reliability of the entire VLBI observing system. All telescopes were regularly in use.



Fig. 1 Geodetic Observatory Wettzell with the 20-m radio telescope in the front and the twin telescopes in the background (reference: BKG web page).

1 General Information

The Geodetic Observatory Wettzell (GOW; see Figure 1) is jointly operated by the Federal Agency for Cartography and Geodesy (Bundesamt für Kartographie und Geodäsie, BKG) and the Research Facility Satellite Geodesy (Forschungseinrichtung Satellitengeodäsie, FESG) of the Technical University of Munich (TUM). Parts of the observatory are now part of the critical infrastructure of Germany for navigation and geodata. The 20-m Radio Telescope in Wettzell (RTW) has been an essential component of the IVS since 1983 and has produced the longest VLBI-data time series worldwide. The 13.2-m Twin radio Telescope Wettzell North (TTW1, Wn) also produced S/X data as a regular network station and was fitted with a VGOS receiver in late 2022. The 13.2-m Twin radio

Telescope Wettzell South (TTW2, Ws) participates in almost all VGOS and EU-VGOS sessions and is part of the VGOS Intensive program. Wettzell observatory also became an official correlation site of the IVS. It is also part of the DACH Operation Center and schedules T2, INT2, INT3, OHIGGINS, and other sessions. Using the Field System extension for remote control and monitoring, all sessions are operated completely unattended. An official on-call service was established in January 2021 to manage appearing issues outside of official business hours. All VLBI data is transferred with e-VLBI techniques to Bonn, Tsukuba, Haystack, Washington, and Socorro, using TSUNAMI or jive5ab on a 5 Gbit/s connection. Bonn and Washington correlators fetch sessions from Flexbuff systems at the Wettzell observatory.

In addition to the VLBI, an ILRS laser ranging system, several IGS GNSS permanent stations, a large laser gyroscope G (ring laser), and the corresponding local techniques (e.g., time and frequency, meteorology, and superconducting gravity meters) are operated. Wettzell also runs a DORIS beacon as a complete geodetic core site. A new radio telescope for solar flux observations is almost fully constructed. Activities

1. Forschungseinrichtung Satellitengeodäsie (FESG), Technische Universität München

2. Bundesamt für Kartographie und Geodäsie (BKG)

to monitor atmospheric parameters use a continuously growing number of equipment, including a Nubiscope, and weather balloons. A water vapor radiometer permanently scans the zenith position. A project with the company Menlo Systems as external contractor improves the timing system with compensated fiber-optic transfers and a frequency comb which is under test in parallel to the existing timing distribution. The new DFG Research Unit “Clock Metrology: A Novel Approach to TIME in Geodesy” will further investigate and improve time as a geodetic observable. The project is funded for four years.

The GOW is also responsible for the AGGO system in La Plata, Argentina, and the German Antarctic Receiving Station (GARS) O’Higgins on the Antarctic Peninsula (see separate reports).

2 Staff

The staff of the GOW consists of 42 members in total (plus student operators) mainly on permanent but also on fixed-term contracts to do research, operations, maintenance, and repairs, or to improve and develop all systems of the GOW. The staff operating VLBI is summarized in Table 1.

Table 1 Staff members of RTW.

Name	Affiliation	Function	Special tasks
Torben Schüler	BKG	head of the GOW	
Christian Plötz	BKG	BKG head of VLBI ressource, correlator chief	
Alexander Neidhardt	FESG	TUM head of the microwave group, VLBI-operation chief	
Daniel Amberger	BKG	RF eng., solar flux telescope	
Ewald Bielmeier	FESG	technician	
Martin Brandl	FESG	mechatronic engineer	
Elena Dembianny	FESG	physicist (left Feb. 2021)	
Florian Kroner	FESG	RF engineer (started Nov. 2021)	
Gerhard Kronschnabl	BKG	electronic engineer (chief engineer TTW)	
Willi Probst	FESG/BKG	Correlation, quality control	
Walter Schwarz	BKG	electronic engineer	WVR
Michael Seegerer	BKG	IT, correlation, quality control	O’Higgins
Simon Seidl	FESG	IT/electronic eng. (started Nov. 2021)	
Robert Wildenauer	BKG	IT admin, correlation	

3 Expansion Project for the GOW

The German Federal Ministry of the Interior (BMI) and the BKG have agreed to a four-year project to expand the infrastructure and operations of the GOW in 2018, which is in the final stages. The main objective of this project is to contribute to the 17 sustainable development goals of the United Nations (UN), such as promotion of high-tech-facilities in rural areas in terms of employment and education. Furthermore, Germany intends to deepen its role of supporting Europe’s satellite navigation system “Galileo,” which will also be a major task for the observatory in Wetzell in the future.

To meet these goals, the expansion-project has the following three topics:

- Further development of the existing geodetic infrastructure (VLBI, SLR, GNSS): VLBI is now ISO 9000 certified, a Domestic Coordination Office (DCO) plans and evaluates all observations, an extended quality management is established which offers weekly feedback about performance, and expanded live views show system parameters in real-time.
- Establishment of new systems: The construction phase of the Solar-Flux telescope is finished and the final testing has started. The Wetzell correlator became an IVS component and is regularly operated, the Internet data rate is extended to 2×5 Gbit/s, and magnetometers and other instruments are installed to support space weather monitoring.
- Creation of a center of excellence for space geodesy: Contracts with the district administration were signed to offer official school labs, tours are offered, and public relation and outreach are expanded.

4 Wetzell Correlator

Originally planned for domestic sessions and quality control, the new DiFX correlation facility started operation in January 2021. The correlator increases the efficiency and real-time capabilities for VLBI sessions, but can also be used to support Galileo (e.g., EOPs) for time-critical requests. Meanwhile, the facility is an official component of the IVS doing regular operations, especially for the VGOS network. Technically, it is a

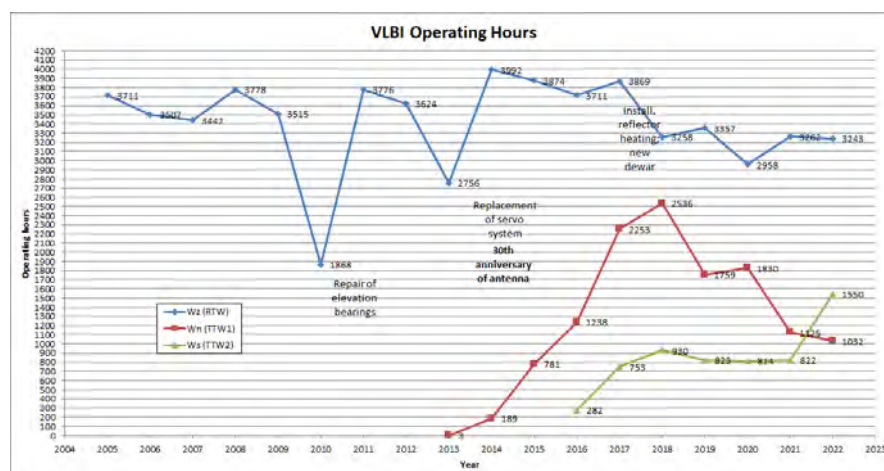

Fig. 2 Annual operation hours of the Wettzell antennas since 2005.

Dell HPC Cluster with 24 compute nodes having 48 Intel® Xeon® CPUs each with 12 cores, so that 576 cores can be used in total. The storage started with a volume of 834 TB. The extension to 2.8 PB is ongoing and will be done beginning of 2023. The software used is DiFX 2.6.1 and 2.5.4 with HOPS (Haystack Observatory Postprocessing System).

5 Legacy System

The 20-m RTW has been supporting geodetic VLBI activities of the IVS and partly other partners, such as the EVN, for over 40 years now. The telescope is still in a very good and stable state supporting legacy S/X observations. The main priority was laid on the participation in all daily one-hour Intensive sessions (INT/K/Q) in order to determine UT1-UTC. The antenna supported all main IVS 24-hour sessions and is still one of the main components of the IVS.

Operation hours in the reporting period compared to the other telescopes are plotted in Figure 2. Sessions operated by RTW in 2021 are in Table 2 and sessions in 2022 are shown in Table 3.

All sessions are recorded on local Flexbuff servers with a volume of 281 TB plus 72 TB. It is connected to the correlator head node, so that the complete volume of the correlator storage can be used. It is also the connection point for e-transfers.

Table 2 Session statistics of the year 2021 (reference: DCO Levika software).

Session	Wz	Wn	Ws	Oh	Ag	Subtotal
GOW	43	28	13	1	32	117
VG2			4			4
VGOS			151			151
IN1	240					240
IN2	93					93
IN3	43	23				66
IVS-R1	42	21			27	90
IVS-R4	47	18			2	67
IVS-T2	7	3		7	2	19
IVS-OHG				6	2	8
IVS-CRD				5	4	9
VLBA	6					6
R&D	10					10
Total	531	93	168	19	69	880

Monthly maintenance days were scheduled to give enough time to maintain the system. The NASA Field System version is 9.13.2, but new FS-PCs were bought where the FSL10 will be installed on a 64-bit operating system. The DBBC2 at the legacy system uses DDC firmware v105_1 for IVS and v107 for EVN sessions and is connected to a FILA10G to stream data over a 10 Gbit/s transfer network directly to a Flexbuff server in the TWIN operation building.

Table 3 Session statistics of the year 2022 (reference: DCO Levika software).

Session	Wz	Wn	Ws	Oh	Ag	Subtotal
GOW	15	8	54		7	84
VG2			70			70
VGOS			240			240
IN1	242	25				267
IN2	102					102
IN3	34	23				57
IVS-R1	47	16			30	93
IVS-R4	45	20				65
IVS-T2	7	4		5	2	18
IVS-OHG				6	4	10
IVS-CRD				4	5	9
VLBA	6					6
R&D	10		1			11
UNKNOWN	66		4			70
Total	574	96	369	15	48	1102

A given oil leakage in two elevation gears was fixed. RF-over-fiber signal transfers were tested and are ready for installation, so that the complete backend, clock reference connection, and control system can be moved to the main operation room in the TWIN building. Studies were done to evaluate the use of an L-band antenna in an offset-cassegrain optic. A problem is that the coldhead model 22 of CTI/Brooks is not supported any more. Therefore, a new cryo-system must be planned. Currently, refurbished models are in use. But the quality is poor that longer maintenance time periods or VLBI operations with a warm receiver had to be accepted.

The northern antenna Wn is equipped with an S/X/Ka receiving system to also support the standard S/X sessions of the IVS. It supported the same or replaced sessions of the 20-m antenna. The northern antenna was the first available antenna supporting fast slewing modes in the IVS and uses a DBBC2 (firmware DDC v105.1) in combination with a Mark5B+. Its performance can be found in Figure 2 and Tables 2 and 3. It suffered from broken bands in the DBBC2 end of 2022. It is controlled with the NASA Field System version 9.13.2.

The performance of Wn suffered from a critical failure of the azimuth encoder of the company BEI

Inc., which was not able to offer economical repairs after more than ten years of use. Because both twin antennas showed the same failure in a very tight timespan and because only one replacement set was available on location, the decision was made to first repair the VGOS system Ws. This caused a complete shutdown of the Wn antenna from July 2021 to December 2021. A complete replacement with Heidenhain encoders and suitable mechanical fitting was done in May 2022. Besides this critical issue, the failing UPS in the system and in the control room caused more instabilities than usual. Defective touch panels in the controlling system of the antenna had to be replaced in addition.

6 VGOS System

The Twin Telescope Wetzell project is Wetzell's implementation of a complete VGOS conformity. To support a complete VGOS functionality, the Wn antenna gets the QRFH feed, a new receiver front-end, and a DBBC3/Flexbuff backend. The rebuilding started at the end of November 2022 and should be available in the first half of the year 2023.

The southern antenna Ws of the twin telescope is Wetzell's first VGOS compliant antenna using a broadband feed (Elevenfeed). It uses a tunable up-down converter, two DBBC2s, and a Mark 6 to record four bands in both polarizations. Ws uses the VGOS branch of the NASA Field System vers. 9.12.7. Ws is a regular part of the IVS VGOS network, participating in weekly/bi-weekly 24-hour observations. It is also involved in the regular VGOS Intensives. Its performance can be found in Figure 2 and Tables 2 and 3.

Two weak and later defective LNAs in the Elevenfeed reduced the quality of the antenna in May 2022. A first maintenance in June/July 2022 was not successful. Therefore, there was a complete destruction of the two LNAs in November 2022, so that VGOS operations had to be stopped. The cause of the destruction was a melting isolation of the supporting cryogenic cable inside the dewar. A problem is that there is no support anymore by Omnisys and that the construction drawings and line plans are not available. Another issue was the failing BEI encoder, already described for the Wn antenna. A complete replacement with Heidenhain encoders and suitable mechanical fitting was done in May 2022. UPS failures also brought instabilities.

The plan is to bring the antenna back in the early months of 2023.

7 Other VLBI-relevant Activities

Several activities supported VLBI. In April 2021, the backbone network of the observatory was renewed with a 10 Gbit/s fiber infrastructure. This allows data streams between different Flexbuffs and correlator facilities of the observatory. The external connection was upgraded to 2×5 Gbit/s, where one line is the main connection point and the other is a equivalent backup.

A photogrammetric survey was done at the 20-m legacy and at the VGOS antennas using overflights with a UAV. The project was lead by the Frankfurt University of Applied Sciences and the Bochum University of Applied Sciences. The goal was to derive a ray-tracing-based delay model for compensating gravitational deformations of VLBI radio telescopes [1].

In November 2021, the Technical University of Munich did laser scanner observations with an automated scanner system mounted in the quadrupod of the 20-m radio telescope. The goal was a 3D deformation analysis [2].

Additionally, local surveys were carried out at the twin telescopes in October 2021.

A big issue was caused by an almost complete outage of the Internet access from January 28 to April 18, 2022. It necessitated manual movements of VLBI modules to dedicated Mark 6 systems with a separate Internet connection. Therefore, it was necessary to establish shifts again doing the data management for that time period.

Another issue is the situation with the hydrogen masers. Contracts ended with T4Science which was additionally sold to Orolia. Essential components of the masers are not available anymore, so that spare parts can not be obtained. Therefore, high efforts were forced to repair EFOS-18 and EFOS-60 in September 2022 to have functional systems again. EFOS-39 was also revised but a failure in the beam stabilizer came up which is not yet repaired, so that it is switched off.

The use of ZABBIX as monitoring and alerting system was extended. Meanwhile, it is an essential part supporting unattended observations. In combination with this local service, the IVS Seamless Auxil-

liary Data Archive (SADA) was established which collects real-time data of different telescopes. The equivalent EVN monitor is a result of the Jumping JIVE project funded by the Horizon 2020 Framework Programme of the EU. The project ended in the year 2021.

8 Future Plans

Dedicated plans for the next reporting period are:

- Establishing a complete VGOS twin telescope with two VGOS receivers and an additional possibility for S/X using a hybrid,
- Replacement of the frontend at the 20-m radio telescope because of missing coldhead support,
- Replacing masers by new systems with available components and maintenance,
- Installation of an L-band offset system at the 20-m radio telescope,
- Use of RF-over-Fiber for the 20-m radio telescope and centralizing the backends,
- Upgrade of the gears at the 20-m radio telescope,
- Extending routine correlation and post-processing,
- Upgrade of the Internet connection to 2×10 Gbit/s and connection of the HPC storage with same speed,
- Completely change to DBBC3 at all telescopes,
- Test of time and frequency distribution over compensated fiber,
- Regular cleaning of the radio telescopes.

References

1. M. Lösler, C. Eschelbach, A. Greiwe, R. Brechtken, Ch. Plötz, G. Kronschnabl, A. Neidhardt, “Ray tracing-based delay model for compensating gravitational deformations of VLBI radiotelescopes”, In De Gruyter, Journal of Geodetic Sciences, DOI: 10.1515/jogs-2022-0141, pages 165–184, 2022.
2. A. Weinhuber, A. Neidhardt, Ch. Holst, “Monitoring Gravitational Deformations of the Wettzell 20m RadioTelescope’s Main Reflector Using a Leica RTC360”, 5th Joint International Symposium on Deformation Monitoring (JISDM), DOI: 10.4995/JISDM2022.2022.13902, 2022.

Yebes Observatory Report

J. González-García¹, C. García-Miró^{1,2}, V. Pérez-Díez², F. Paredes¹, E. Martínez-Sánchez¹, F. Beltrán¹, P. de Vicente¹, C. Albo¹

Abstract We describe the observations performed by the 40-m radio telescope and the VGOS 13.2-m radio telescopes during the 2021–2022 period as part of the IVS network and the current status of the instrumentation for both telescopes. We also present recent technical developments relevant to the IVS community and future plans within Yebes Observatory to keep our stations as part of the most dynamic elements of the network.

1 General Information

The National Geographic Institute of Spain (Instituto Geográfico Nacional - IGN, Ministerio de Transportes, Movilidad y Agenda Urbana), has supported geodetic VLBI programs at Yebes Observatory since 1995 and currently operates two radio telescopes on the site that participate in the IVS observing program. The 40-m radio telescope, station code “Ys” (YEBES40M), has been operating regularly since 2008 within the S/X (now Legacy) network. The 13.2-m VGOS compatible antenna, inaugurated in 2014 with code “Yj” (RAEGYEB), has been observing bi-weekly in the VGOS 24-hour sessions. Detailed information about the RAEGE project is available on the web at <http://www.raege.net/>. IGN Yebes Observatory is also the reference station for the Spanish GNSS network, holds permanent facilities for gravimetry and

seismology, and is currently installing a Satellite Laser Ranging (SLR) station.

Currently, the observatory also has small correlation capabilities, which consist of a DiFX software correlator running on an HPC cluster of three nodes that add up to a total of 28 cores. A modest storage capacity of 144 TB on a RAID-Z system is hosted on a single Supermicro server.

Since 2014, IGN Yebes Observatory has become a Technology Development Center for the IVS. Activities are described in the corresponding contribution in this Biennial Report. More information about the Observatory, including technical details of the radio telescopes, can be found on the website https://astronomia.ign.es/en_GB/web/guest/icts-yebes/acercade

1.1 Yebes Staff

Yebes Observatory staff dedicated to geodetic and astrometric VLBI activities is formed by two support astronomers, Victor Pérez-Díez and Cristina García-Miró, the VLBI technical friend, Javier González-García, one geodesist, Elena Martínez-Sánchez, the observatory software developer, Francisco Beltrán, one IGN fellow, Felipe Paredes, and the Observatory director, Pablo de Vicente.

1. Yebes Observatory

2. National Astronomical Observatory, Spain

Yebes Network Station

IVS 2021+2022 Biennial Report

2 Yebes Activities during the Past Two Years

The following subsections review Yebes' participation in Legacy IVS observations with the 40-m radio telescope and VGOS IVS observations with the 13.2-m antenna.

2.1 Yebes 40-m Radio Telescope Operations

In 2021, the 40-m radio telescope observed eighteen IVS experiments, of which seven were R4s, nine were R1s, and two were T2s. YEBES40M additionally participated in one RUA experiment and two experiments for optical clock comparison and remote clock distribution. Due to a major failure of the radio telescope as a result of an unusual severe snowstorm in central Spain, "Filomena", we were not able to participate in many observations during the first semester. Four more observations were impacted during June and July due to different problems with the antenna. Our participation increased to a total of 23 observations in 2022, with fifteen R4 sessions, seven R1s, and one T2. No major problems were experienced during last year.

Table 1 Yebes 40-m participation in IVS Legacy observations.

YEBES40M (Ys)	2021	2022
IVS R1	9	7
IVS R4	7	15
IVS T2	2	1
EURD	0	0
R&D	0	0
CRF	0	0
EINT	0	0
TOTAL	18	23

During the reported period, the antenna sensitivity has remained in its nominal values, with the usual RFI impact on the S-band channels.

2.2 VGOS Operations and Related Activities

The year 2021 turned out to be a fateful year in terms of performance of the VGOS-type radio telescope operated by the Yebes Observatory. Even in spite of the big snowstorm "Filomena", which prevented access to the facilities for almost a week due to the large amount of snow and ice accumulated, the radio telescope could be operated remotely, thanks to its high degree of automation. From January 7th to June 9th, the telescope performed 12 VO sessions of the VGOS project, all of them successfully completed. In addition, it performed two test experiments to validate modifications to the technical operating procedure within the framework of the EU-VGOS project. It also participated up to three times in fringe-test observations as a reference station to assist the RAEGE radio telescope located in Santa María, Azores.

Unfortunately in mid-June, the telescope suffered a mechanical failure that stopped the antenna completely until the end of the year (Figure 3). As later revealed by the investigations by the Observatory's own specialized personnel in conjunction with technicians belonging to the manufacturer, mechanical alterations of the system caused by normal usage produced a malfunction of the cable winding system, which in turn caused the rupture of two cable guide chains that compose it. This system is what keeps the cabling tidy during azimuth movements. Fortunately, there was no damage to the cables themselves, neither to the signal cables nor to the power cables. The shortage of raw materials, especially aluminum, significantly delayed the repair, which was initially scheduled for September but was repeatedly delayed until it was executed during the week of December 20th.

In turn, 2022 was a more productive year. Most of the observation time was devoted to 24-hour VGOS observations, both from the VO and VR projects. Within this framework 49 sessions were scheduled, of which 41 were completed successfully, two were aborted due to equipment failure at the station, two data sets were discarded at the correlator or analysis stage, and four were partially observed. In the spring of 2022, the VGYG observing project also began, consisting of one-hour Intensive sessions involving three VGOS stations: GGAO12M, RAEGYEB, and RAEGSMAR. The one-hour sessions are followed by

a ten-minute test time to prove alternative observing configurations in the scheduling parameters. The VGYG is observed at 14:00 UT every Tuesday.

The following major system upgrades took place during this period:

- Replacement of the entire frontend. The old receiver was sent to Santa María to be installed in RAEGSMAR.
- Replacement of the broken reference cable carrying the 5 MHz from the CDMS-GU to the CDMS-AU.

Further details are given in Section 3.

Table 2 RAEGYEB 13.2-m participation in VGOS and VGYG observations.

RAEGYEB (Yj)	2021	2022
VO obs	12	47
VGYG obs	–	18

During these two years, calibration and deconvolution tasks of observations taken with the EU-VGOS subnetwork were carried out. These observations were used to develop ultra-wideband global fringe fitting (GFF) algorithms. Thanks to the use of a priori ionospheric information from GNSS data, higher quality results were achieved and in a significantly shorter calculation time than those obtained with the standard geodesy adjustment software, HOPS. These improvements were added to the PolConvert software [1]. Closure-based imaging algorithms were applied to these data, having obtained both brightness distribution and polarimetric images from various calibrator sources in the different VGOS bands (Figure 1). Thanks to the robustness of these algorithms, it was possible to obtain images of experiments with only four antennas and ten minutes of observation, which cannot be obtained with the classic CLEAN algorithm. These developments will allow a detailed analysis of the relativistic jets of the AGNs, including core shift, the relationship between the opacity and the morphological evolution of the jets, and the magnetic fields that surround them.

Additionally, since last year, a VGOS calibration server is being developed to properly extract the calibration information from the different observing logs, independently of the type of backend used. The server computes and plots the single dish system temperatures

and produces the antabfs files to properly apply the PolConvert algorithm and calibrate the total brightness and polarimetric images.

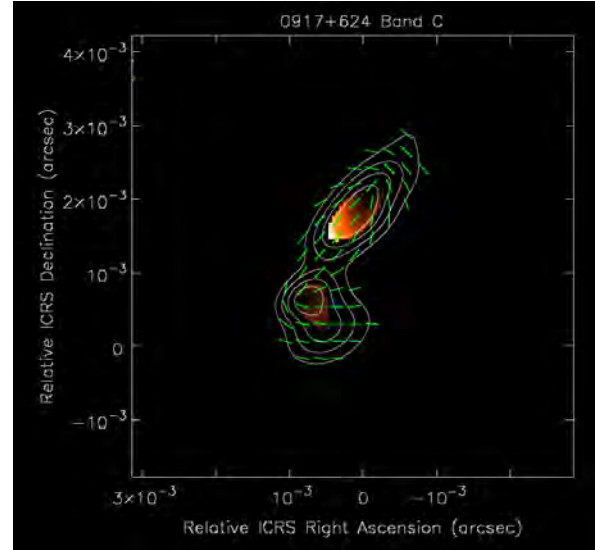

Fig. 1 Image of 0917+624 obtained from the EU-VGOS experiment EV9217 at Band C. The white contours show the brightness distribution of Stokes I. The orange raster plot shows the brightness distribution in linear polarization. The green vector map shows the EVPA.

2.3 Local Tie and Other Activities

Since December 2021, the Yebes Observatory has been part of IERS/IAG Working Group: Site Surveys & Techniques. During the regular meetings, this working group has presented best survey practices to perform the local-tie. Lately, this group has focused on antenna deformation. At Yebes, we have performed a 3D-scan survey and an Unmanned Aerial Vehicle (UAV) photogrammetry survey (Figure 2). Both produce accurate high-resolution orthophotos that can be used to obtain temperature and gravity deformation of the antenna, a very important parameter for calculating the local-tie.

In 2022, specialized Yebes staff traveled to Santa María island (Azores) to accomplish a survey for the construction of five pillars. Those pillars will be part of the RAEGE-AZ local network, which will be needed

to perform the local-tie survey between the RAEGE VLBI and RAEGE GNSS techniques.

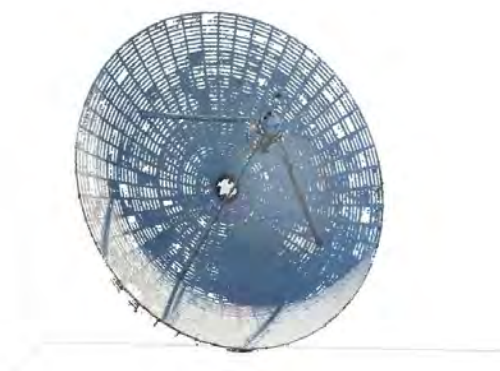

Fig. 2 Filtered dense point cloud at 65° elevation of the RT40-m main reflector, secondary mirror, and support legs.

3 Current Status

The Yebes Observatory runs two active Hydrogen masers from T4-Science that provide the frequency references (5, 10, and 100 MHz, and also the 1PPS TTL signal) for all the electronics involved in VLBI operations, in a master-backup scheme. This same setup is also used to secure the GPS time synchronization by means of two GPS receivers (CNS Clock II and Symmetricom XLi, now Microsemi).

The 40-m radio telescope is equipped with a simultaneous S/X receiver that routinely performs the observations that contribute to the IVS. A new wideband receiver that operates from 4.5 GHz to 9 GHz (C, M, and X bands) was designed and manufactured on-site and demonstrated its first VLBI fringes in December 2021. Within the last two years, the observatory also achieved another major upgrade to its astronomical capabilities, with the addition of a dichroic mirror to simultaneously observe in W band together with the K and Q receivers. To complete the triple band observing capacity, the DBBC3 backend was upgraded at Hat-Lab to incorporate four more processing units, becoming a DBBC3-6L-6H. All the receivers can record dual circular polarization except W and Q, which are linear, but lambda quarter plates are available for use in circular polarization mode. Continuous calibration is avail-

able in the S/X, C-X, and K receivers, using a noise diode driven by an 80 Hz signal generated in the back-end. Q and W band observations can be calibrated with a hot-cold load system. A phase calibration signal is available in the S/X and also in the C-X receiver.

Since its first light, the 13.2-m VGOS-type telescope has been equipped with four RDBE-G backends connected to a single Mark 6 unit. The frontend signal chain consists of a cryo-temperature QRFH feed connected to Yebes' own broadband receiver that sends the full 3 to 12 GHz band through an optical fiber link to four UDCs, each of them adapting a 512 MHz band in Nyquist zone 2 to be digitized by an RDBE-G. The frontend has experienced several modifications in 2021 and 2022, mainly focused on reducing the receiver noise temperature across the 3 to 14 GHz range. These changes consisted of replacing the LNAs to install double LNAs per polarization in a balanced scheme (including cryo-hybrids), installing a FAP module (Filter-Amplifier module, at room temperature), using better high pass filters with 3 GHz cut off frequency and using power limiters to prevent the fiber optic transceiver from being destroyed by RFI. A new version of the QRFH, developed at Yebes (third generation), was also installed. But, although these modifications proved to decrease the system noise, we detected that the Cable Delay Measurement System (CDMS) failed to report accurate measurements from time to time. This problem was traced down to a faulty coaxial cable that ended up breaking at several points after being exposed to certain bending cycles. On September 30, 2022, this cable was replaced with a brand new LMR-400UF coaxial cable. No symptoms of CDMS failure have been observed since. Reference [2] is a publication on sensors that describes the system.

Due to the high pressure on YEBES40M from the radio astronomy community, specifically for Single-Dish projects, we have begun a process of withdrawing it from geodetic observations in the framework of the IVS. However, ten IVS sessions are scheduled for 2023, all of them devoted to CRF and TRF determination, as this antenna is actively participating in the enhancement of the K-band Celestial Reference Frame [3, 4]. At the same time, it is expected that RAEGYEB will overtake this duty, nowadays doing bi-weekly observations within the VGOS core network.

The meteo data is collected by a MET4 station from Paroscientific and the Vaisala WXT532 wind sensor. Both instruments are located on a meteorological tower



Fig. 3 Detail of the cable wrap structure breakage.

about ten meters tall, 150 m NW from the 13-m telescope and 270 m W from the 40 m. Time synchronization is provided by a CNS Clock II system, and a secondary GPS receiver from Microsemi is operated as a backup.

4 Future Plans

During the second half of 2022, we have installed and configured four R2DBE systems. They are meant to replace the current RDBE on duty, but there is still a missing step that prevents us from using them in VGOS

operations. The multicast interface to the Field System has not been finished yet, so auxiliary data can not be recorded in the observation log file. This auxiliary information (system temperatures, pcal data, attenuator settings) plays an important role in the improvement of the geodetic measurements in the VGOS era; therefore to dispense with it, right now, would be a step backwards in the quality of the data provided by the station.

A complete overhaul of the HPC cluster running the DiFX correlator was designed with aid from the Spanish consultant company QUASAR to expand the correlation capabilities. The final setup will consist of 128 computing cores distributed across four nodes and almost 2 PB of available storage in a BeeGFS system for virtualization and redundancy. Infiniband technology will be used for network interconnection. After all the components have been purchased, we expect the last piece of equipment to be delivered by the end of April.

Finally, the Yebes Observatory, as part of the national high speed network for Investigation and Education (RedIRIS) in Spain, has just upgraded the networking equipment to support a new 100 Gbps connection to the RedIRIS backbone, in view of higher bit rates for data transfer of wide bandwidth observations (over 1 GHz).

References

1. I. Martí-Vidal, A. Roy, J. Conway, et al. *Calibration of mixed-polarization interferometric observations. Tools for the reduction of interferometric data from elements with linear and circular polarization receivers*. *A&A*, 587, 143, 2016.
2. P. García-Carreño, J. González-García, M. Patino-Esteban, F. J. Beltrán-Martínez, M. Bautista-Durán, P. L. López-Espí, J. A. López-Pérez, *New Cable Delay Measurement System for VGOS Stations*. *Sensors*, 22, 2308, 2022. <https://doi.org/10.3390/s22062308>
3. P. Charlot, et al. *The Celestial Reference Frame at 24 and 43 GHz. II. Imaging*. *AJ*, 644, A159, 2020.
4. A. de Witt, et al. *K-band Celestial Reference Frame: Roadmap*. *Proc. Journées 2019*, 2, 2019.

OPERATION CENTERS



CORE Operation Center 2021–2022 Report

Cynthia C. Thomas, Daniel S. MacMillan

Abstract This report gives a synopsis of the activities of the Continuous Observation of the Rotation of the Earth (CORE) Operation Center from January 2021 to December 2022. The report forecasts activities planned for the year 2023.

- VGOS-INT-A (2022): 181 sessions, scheduled for most weekdays, two-station networks;
- IVS-INT-00 (2022): 64 sessions, generally scheduled twice a week, two-station networks;
- VGOS-O (2022): 42 sessions, scheduled weekly during the first three quarters, then bi-weekly during the fourth quarter, five- to 10-station networks.

1 Changes to the CORE Operation Center’s Program

The Earth orientation parameter goal of the IVS program is to attain precision at least as good as 3.5 μ s for UT1 and 100 μ s for pole position.

The IVS program, which started in 2002, used the Mark IV recording mode for each session. The IVS program began using the Mark 5 recording mode in mid-2003. By the end of 2007, all stations were upgraded to Mark 5. Due to the efficient Mark 5 correlator, the program continues to be dependent on station availability and media storage. The following are the network configurations for the sessions for which the CORE Operation Center was responsible in 2021 and 2022:

- IVS-R1 (2021): 52 sessions, scheduled weekly and mainly on Mondays, five to 14 station networks;
- VGOS-INT-A (2021): 123 sessions, initially scheduled once to twice weekly, later scheduled up to five times weekly, two-station networks;
- IVS-R1 (2022): 52 sessions, scheduled weekly and mainly on Mondays, six- to 14-station networks;

2 IVS Sessions from January 2021 to December 2022

This section describes the purpose of the IVS sessions for which the CORE Operation Center is responsible.

- **IVS-R1:** The purpose of the IVS-R1 sessions is to provide weekly EOP results on a timely basis. These sessions provide continuity with the previous CORE series. The “R” stands for rapid turnaround because the stations, correlators, and analysts have a commitment to make the time delay from the end of data recording to the analysis results as short as possible. Participating stations are requested to ship disks to the correlator as rapidly as possible or to transfer the data electronically to the correlator using e-VLBI. The “1” indicates that the sessions are mainly on Mondays. The goal is that the time delay is at most 15 days from the end of data recording to the end of correlation. Eighty-two percent of the IVS-R1 sessions were completed in 15 or fewer days during 2021. The remaining 18% were completed in 16 to 22 days. During 2022, the percentage of R1 sessions being processed within 15 days increased from 82% to 88%. The processing times of the remaining 12% ranged from 17 to 23 days.

NVI, Inc./NASA Goddard Space Flight Center

CORE Operation Center

IVS 2021+2022 Biennial Report

During 2021, the IVS-R1 sessions were scheduled the same way as in 2020 with the extended 15-station network for half of the R1 sessions and with a data rate of 512 Mbps. The other half had fewer than 15 stations with a data rate of 256 Mbps. The two types of sessions were scheduled randomly throughout the year. Twenty-one different stations participated in the IVS-R1 network, and 13 stations participated in at least 26 of the 52 sessions. This was an increase from 2019 where 12 stations participated in at least half of the scheduled sessions.

After evaluating the sessions during 2020 and 2021 with the new scheduling scheme, the OPC (with analysis provided by the Coordinating Center) decided to change the scheduling scheme because some of the regular R1 sessions had poorer performance, which was attributed mostly to the network size and geometry of those sessions. During 2022, all the R1 sessions were planned with mostly a network size of 11 to 12 stations to provide reasonable robustness against quality falloff in the event of station dropouts. About six sessions had a network larger than 12 stations. All of the sessions were recorded with a data rate of 512 Mbps.

- **VGOS-INT-A:** VGOS-INT-A observing began in 2021. 123 sessions were scheduled during 2021. The cadence started at one session per week in January 2021, increased to two sessions per week in February 2021, and reached Monday through Friday observing by the start of December 2021. 181 sessions were scheduled during 2022. The network was Kokee-12m and Wettzell-South during both years. The number of sessions increased during 2022 because the Washington Correlator staff learned how to process the VGOS Intensive sessions more efficiently during 2021 and was able to process more sessions during 2022. Near the end of November 2022, Wettzell-South went down for repairs. Onsala-East replaced Wettzell-South in the VGOS-INT-A sessions from mid-December 2022 through late March 2023.
- **IVS-INT-00:** It was decided in January 2022 to add two additional legacy S/X Intensive sessions each week to gain experience with the operational impact of Intensives with a 00:00 UT midpoint. The two Midnight Intensive sessions were scheduled on Mondays and Thursdays at 23:30 UT after normal operations returned at Kokee and Wettzell. The Midnight Intensives were scheduled twice a week

starting March 14, 2022 when Kokee participated in an R1 session. The Midnight Intensive sessions were scheduled to run during an R1 (with Kokee as a participating station) and an R4 session because the station was staffed regularly during those periods.

- **VGOS-OPS:** The sessions include VGOS stations that have been vetted by the Haystack Correlator. The VGOS Operations sessions were scheduled by Haystack personnel until mid-May 2022. The CORE Operation Center took over the scheduling duty with VO2146, which was observed on May 26, 2022. These sessions run simultaneously with the R4 sessions on Thursdays for the most part. The VGOS-OPS sessions were observed with a weekly cadence until November 2022. The cadence changed to once every two weeks to give the correlators a chance to catch up on the backlog of sessions to be processed. During 2022, the VGOS-OPS sessions were processed by five correlators: Haystack, Bonn, Vienna, Washington, and Shanghai. Another evaluation of the cadence will be done in March 2023.

3 Current Analysis of the CORE Operation Center's IVS Sessions

The results in Tables 1 and 2 were derived from the most recent GSFC EOP series, which was based on the terrestrial reference frame of the GSFC 2020a quarterly Calc/Solve solution. The solution reference frame

Table 1 Median uncertainties and variability of EOP formal uncertainties for 2021 and 2022. The median uncertainties are shown for 2021 and 2022 in that order. The RMS variabilities of the uncertainties are given on the second lines. For the VGOS sessions, the variabilities after removing one to three large outliers are given in the third line.

	Num	X-pole (μ as)	Y-pole (μ as)	UT1 (μ s)	X nutation (μ as)	Y nutation (μ as)
R1	52, 52	46, 42 14, 6	39, 37 15, 8	2.6, 2.7 1.4, 0.4	31, 26 14, 5	32, 26 12, 6
R4	52, 52	46, 43 14, 11	44, 42 10, 12	2.8, 2.9 0.8, 0.6	36, 29 11, 11	35, 30 13, 11
VG	25, 36	41, 38 27, 24 8, 12	36, 38 14, 23 5, 7	2.0, 2.0 0.6, 1.2 0.3, 0.6	22, 27 7, 16 6, 9	23, 26 9, 14 5, 10

Table 2 Offset and WRMS differences (2021 and 2022) relative to the IGS Finals Combined Series. Values are for the 2021 and then the 2022 R1, R4, and VG series. For the R1 and the R4 series, the values in parentheses are for the entire series since 2002.

Num	X-pole		Y-pole		LOD	
	Offset (μs)	WRMS (μs)	Offset (μs)	WRMS (μs)	Offset ($\mu\text{s}/\text{d}$)	WRMS ($\mu\text{s}/\text{d}$)
R1 52, 52 (1077)	-161, -215 (-119)	92, 126 (97)	34, 125 (29.2)	85, 60 (84)	1.6, -0.5 (0.3)	13.6, 12.8 (14.7)
R4 52, 52 (1078)	-175, -230 (-113)	90, 91 (108)	17, 78 (27)	98, 96 (95)	0.2, 0.7 (0.3)	14.3, 13.7 (16.4)
VG 25, 36	-47, -23	95, 83	-11, -34	135, 97	7.7, -1.3	14.7, 10.9

was constrained to be consistent with ITRF2014 and ICRF3.

Table 1 gives the median Earth Orientation Parameter (EOP) formal uncertainties during 2021 and 2022 for the two operational series R1 and R4. Results are also shown for the VGOS 24-hour sessions that were observed from January 7, 2021 until October 26, 2022. To provide a sense of the variability of the uncertainties, the standard deviation of the uncertainties is shown. Removing one to three large outliers from the VGOS uncertainties reduced these significantly. The R1 and R4 uncertainties are close to those for the preceding two years, 2019–2020.

Table 2 provides the EOP biases and WRMS differences of the R1, R4, and VGOS 24-hour series relative to the IGS Finals series. The X-pole bias offsets from Table 2 in 2021 and 2022 are consistent between the R1 and R4 series, most likely due to a bias between the VLBI and GNSS reference frames. The Y-pole biases are less consistent, but they are probably also due to reference frame biases. The inconsistencies of the VGOS biases with respect to the R1 and R4 biases are most likely caused by the biases between the VGOS station reference frame and the S/X frame. The R1 X-pole WRMS difference in 2022 of 126 μs is due to several large outlier residuals. If the five residuals that are larger than 5-sigma (200 μs) are removed, then this WRMS is reduced to 99 μs , which is more consistent with the WRMS for 2021. The Calc/Solve session analysis for these sessions does not show any obvious reason for the outliers.

Table 3 Intensive EOP median formal uncertainty (σ) and RMS variability.

	Num	UT1 (μs)	
		σ	RMS
Midnight (2022)	60	9.1	5.7
VGOS (2021)	118	14.5	3.8
VGOS (2022)	170	11.7	3.0

GSFC scheduled two additional Intensive series during 2021 and 2022. Sixty midnight Intensives were observed in 2022 with the Kokee–Wetzell baseline from March 17 until December 21. 288 VGOS Intensive sessions were observed with the Wetzell–South and the Kokee–12m antennas during 2021 and 2022. Table 3 provides more details.

4 The CORE Operation Center Staff

Table 4 lists the key technical personnel and their responsibilities so that people reading this report will know whom to contact about their particular questions.

Table 4 Key technical staff of the CORE Operation Center.

Name	Responsibility	Agency
Karen Bayer	CORE OC analysis and preparation of VGOS-INT-A observing schedules	NVI, Inc.
Dirk Behrend	Organizer of CORE program	NVI, Inc.
Mario Bérubé	Software engineer for the Web site	NVI, Inc.
John Gipson	SKED program support and development	NVI, Inc.
Lawrence Hilliard	Procurement of materials necessary for CORE operations (through April 2023)	NASA GSFC
Ed Himwich	Principal Scientist and Field System maintenance	NVI, Inc.
Derek Hudson	Procurement of materials necessary for CORE operations (starting in May 2023)	NASA GSFC
Dan MacMillan	CORE OC analysis	NVI, Inc.
Katie Pazamickas	Maser maintenance	Peraton
Jay Redmond	Receiver maintenance	Peraton
Cynthia Thomas	Coordination of master observing schedule and preparation of most observing schedules	NVI, Inc.

5 Planned Activities during 2023

The CORE Operation Center will continue to be responsible for the following IVS sessions during 2023:

- The IVS-R1 sessions will be observed weekly and recorded in Mark 5 mode. The eight- to 14-station sessions will be scheduled for 52 sessions with the 512 Mbps data rate. The sessions will have both S/X and VGOS stations (mixed-mode) participating. There were two mixed-mode test sessions scheduled during 2022. The last of the two sessions was successfully correlated within 15 days.
- The VGOS-OPS sessions will be observed every other week for the first quarter of the year. The cadence will be re-evaluated during March 2023 to determine if the cadence can return to weekly.
- The VGOS-INT-A sessions will continue to be scheduled Monday through Friday every week, with Kokee-12m and Wettzell-South. Onsala-East will be the backup station for Wettzell-South.
- The IVS-INT-00 sessions (Midnight Intensives) will continue to be scheduled with the Kokee-Wettzell baseline. The sessions will be observed on the Mondays when Kokee is a participating station in the R1 sessions and on the Thursdays when Kokee participates in the R4 sessions.

The determining factor will be that correlators process the VGOS-OPS sessions within 30 days. The cadence will remain two-weekly until the VGOS-OPS sessions can be completed within 30 calendar days.

DACH Operation Center 2021–2022 Report

Matthias Schartner¹, Christian Plötz², Lisa Kern³, Thomas Klügel², Walter Schwarz², Torben Schüler², Johannes Böhm³, Benedikt Soja¹

Abstract The Operation Center DACH is responsible for the IVS observing programs AUS-AST, IVS-CRDS, IVS-CRF, IVS-INT-2, IVS-INT-3, IVS-INT-S, IVS-OHIG, IVS-T2, IVS-T2P, VGOS-INT-B, VGOS-INT-C, VGOS-INT-S, VGOS-INT-Y, and VGOS-RD, as well as other research and development sessions. Together, this accumulated to 205 sessions in 2021 and 376 sessions in 2022. The vast majority of these sessions are scheduled fully automatically. Besides scheduling, OC DACH performs sophisticated quality control. The fully automated scheduling pipeline is operating based on Monte Carlo simulations and well-defined scientific goals for each session to reduce human biases.

the VLBI scheduling software *VieSched++* [6]. This pipeline is currently used for the observing programs (OPs) AUS-AST [4], IVS-INT-2 [7], IVS-INT-3 [7], IVS-INT-S [1], IVS-OHIG, IVS-T2, VGOS-INT-B [3], VGOS-INT-C, VGOS-INT-S [8], and VGOS-INT-Y, as well as some BKG internal OPs. Furthermore, most of the remaining IVS OPs are also scheduled automatically for quality control.

Besides the fully automated operational scheduling, some further observing programs require manual scheduling due to their research and development characteristics (OP: VGOS-RD [5], VGOS-24INT-S) or because special adjustments to the input catalogs, or a manual fine tuning of the scheduling, is necessary (OP: IVS-CRDS, IVS-CRF, IVS-T2P).

1 General Information

The Operation Center (OC) DACH is a joint endeavor of ETH Zurich (Switzerland), the Federal Agency for Cartography and Geodesy in Germany (BKG; Germany), and TU Wien (Austria). The motivation behind the OC DACH is to combine expertise in VLBI scheduling with expertise in VLBI operations. Furthermore, with the help of this cooperation, the long-term existence of the Operation Center can be ensured. A fully automated scheduling pipeline (*VieSched++ AUTO*) was established within OC DACH. It is a Python framework, running on top of

1. ETH Zurich
2. Federal Agency for Cartography and Geodesy
3. TU Wien

DACH Operation Center

IVS 2021+2022 Biennial Report

2 Activities during the Past Two Years

Sessions

The OC DACH is responsible for a variety of OPs, listed in Table 1.

The number of sessions assigned to OC DACH increased drastically over the last few years. While in 2019, only 22 and, in 2020, only 73 official IVS sessions were scheduled at OC DACH, the number increased to 205 in 2021. In 2022, the number further increased to 376 schedules. Ensuring high-quality results for this huge workload could only be achieved through rigorous automation. The majority of the current sessions are scheduled fully automatically. It was proven that the automated scheduling approach is very robust. So far, no significant errors have been reported. Furthermore, the Python-based framework proves to be

Table 1 Number of sessions processed by the OC DACH per OP. OPs marked with * are scheduled fully automatically.

OP	2021	2022
AUS-AST*	12	12
IVS-CRDS	6	6
IVS-CRF	6	6
IVS-INT-2*	93	102
IVS-INT-3*	43	36
IVS-INT-S*	0	49
IVS-OHG*	6	6
IVS-T2*	5	5
IVS-T2P	2	2
VGOS-24INT-S	0	6
VGOS-INT-B*	17	46
VGOS-INT-C*	8	42
VGOS-INT-S*	3	36
VGOS-INT-Y*	0	13
VGOS-RD	1	6
other	3	3
Total	205	376

very flexible and easy to extend. So far, changes in the scheduling strategy or adjustments to the derived output files could be implemented easily.

Intensives

The majority of the sessions assigned to the OC DACH are VLBI Intensive sessions for the rapid determination of the Earth's phase of rotation, expressed as the time difference UT1-UTC.

By changing the scheduling strategy, the formal errors of the IVS-INT-2 sessions could be decreased by 11% for baseline IsWz, 32% for baseline KkWz, and 42% for baseline MkWz [7]. Similar improvements of up to 45% were also achieved for IVS-INT-3 sessions.

Besides the SX-Intensive programs IVS-INT-2, IVS-INT-3, and IVS-INT-S, the OC DACH is also scheduling the VGOS Intensive programs VGOS-INT-B, VGOS-INT-C, VGOS-INT-S, and VGOS-INT-Y. These programs test new baselines (VGOS-INT-B/C: IsOeOw, VGOS-INT-S: MgWs, and VGOS-INT-Y: GsYj) as well as slight modifications to the scheduling strategy. Within VGOS-INT-C the source selection is avoiding observations aligned with the direction of the source jet. Within VGOS-INT-S, a rapid alternation between high- and low-elevation scans is implemented, allowing for an increased sampling of the zenith wet delay during analysis.

VGOS-RD

Over the years 2021 and 2022, seven 24-hour VGOS research and development (VGOS-RD) sessions have been scheduled and observed. Some of these sessions required significant extensions in the VLBI scheduling software VieSched++. For example, the parameterization of the station sky coverage was extended to support individual parameters per station. Furthermore, the support for calibrator scans was extended. During

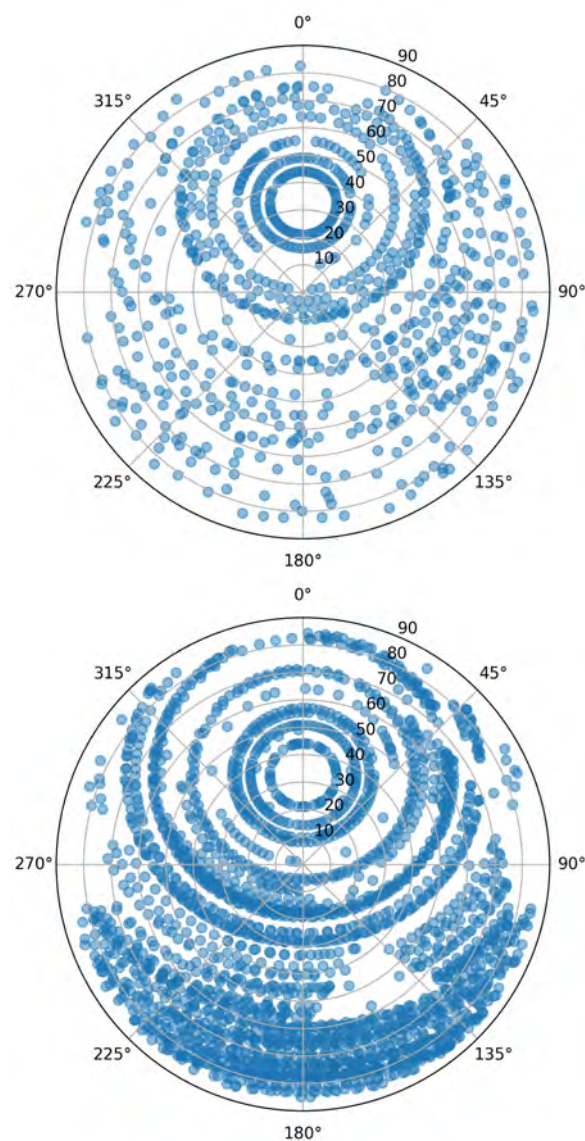

Fig. 1 Sky coverage of station ONSA13SW (Ow) for VO2132 (2022-05-12; top) and VR2303 (2022-05-19; bottom).

scheduling, the calibration scans are fixed in the first step. The calibration scans can now be chosen based on the full network (ignoring tag-along mode) to ensure that also tag-along stations are properly included in these scans. This is especially important for the new southern-hemisphere VGOS stations for which calibration scans are especially important. After the calibration scans are fixed, the actual scheduling starts by filling the time between the calibrator scans. Finally, support for a new four-band VGOS flux catalog and refined scheduling strategies were implemented as well. Due to these changes, SNR-based scheduling for VGOS sessions was utilized for the first time. With this SNR-based scheduling approach, the integration time could be reduced to 7–20 seconds, instead of using a fixed integration time of 30 seconds independent of the station sensitivity and source flux density, as is the case in the VGOS-OPS sessions. It was proven that the SNR-based integration time works. The percentage of usable observations in VGOS-RD is close to the VGOS-OPS sessions with the additional benefit that the number of observations is increased by up to a factor of two [5], while the total amount of recorded data is reduced by up to 30%. The latter point is especially important to reduce the latency of deriving VGOS results—one of the main challenges of today’s VGOS sessions—because fewer bytes have to be transferred and processed. Figure 1 depicts the ONSA13SW sky coverage of VGOS-RD session VR2303 compared to the VGOS-OPS session VO2132 from the week before. A significant improvement w.r.t. the number of observed scans can be seen. The total number of scans for ONSA13SW increased by a factor of 3.2, from 797 to 2,470.

IVS-CRDS / IVS-CRF

The IVS-CRDS and IVS-CRF sessions continue to be scheduled manually. The objective of these sessions is to focus on observing ICRF3-defining sources [2]. Therefore, the source list is adapted for each session individually. Besides astrometry, astronomical source imaging is a further essential objective for these sessions, requiring special treatment during scheduling. But imaging is not possible for all sessions, due to the lack of VLBI stations in the southern hemisphere and the resulting smaller VLBI networks in some of the sessions. Besides, some southern-hemisphere stations

have only low sensitivity, posing another difficulty for these sessions. Due to these obstacles (few stations in general with some of them having low sensitivity), the IVS-CRDS sessions are among the most challenging sessions to schedule.

3 Current Status

The number of sessions assigned to OC DACH has again increased for 2023. As of January 2023, we will support over 400 sessions, and it is expected that the number will rise further during the year. The scheduling pipeline is now based on the IVS master file format version 2.0. It is publicly available under https://github.com/TUW-VieVS/VieSchedpp_AUTO. Similarly, the VieSched++ scheduling software is available under <https://github.com/TUW-VieVS/VieSchedpp>.

The basic principle of the scheduling pipeline is that it relies on well-defined scientific goals for each session combined with large-scale Monte Carlo simulations. For each session, several hundred to a thousand different schedules are generated. Each session is further simulated a thousand times using varying tropospheric conditions, clock drifts, and measurement errors. Based on comparing the analysis results of these simulations with the scientific goals of the session, the best-performing schedule is selected. The best-performing schedule, along with vivid statistics and charts, is automatically distributed by email for human inspection. After some days, it is automatically uploaded to the IVS servers in case no human intervention is necessary. In the following days, the software checks if the upload was successful and if the station network was changed after the session was submitted. Changes are reported via email, and it is decided on a case-by-case basis whether or not a new schedule should be generated and uploaded.

4 Future Plans

It is planned to further enhance the scheduling software, as well as the automatic scheduling pipeline. This includes more options regarding the scheduling of twin telescopes, as well as enhanced support of satellite

scheduling and active satellite avoidance. For twin telescopes (or multiple telescopes on one site in general), currently, it is supported that multiple telescopes can share and optimize one common sky-coverage. But it is planned to add further options to especially favor observation constellations where the twin telescopes are observing different sub-netting scans simultaneously. Furthermore, it should be supported that twin telescopes are counted as being only one station for various statistics and optimization criteria, e.g., for imaging or closure delays. Here, it is not yet clear if it is best to implement this behavior directly within the scheduling routines or if a special form of tag-along mode is more appropriate. As of right now, in some VGOS sessions including twin telescopes, one telescope is scheduled in tag-along mode. This ensures that each scan is scheduled with at least three independent telescopes. But the downside of this approach is that during the tag-along mode, the tag-along station tends to simply follow the observations of its twin telescope and is thus not contributing to improved tropospheric sampling.

We also plan to further improve the quality control of our scheduling pipeline to ensure the release of high-quality schedules. This includes extending the quality control metrics to not only compare scheduling-related statistics but also statistics from the analysis.

References

1. S. Böhm, J. Böhm, J. Gruber, et al. Probing a southern hemisphere VLBI Intensive baseline configuration for UT1 determination. *Earth Planets Space* 74, 118 (2022). <https://doi.org/10.1186/s40623-022-01671-w>
2. P. Charlot, C. S. Jacobs, D. Gordon, et al. (2020). The third realization of the International Celestial Reference Frame by very long baseline interferometry. *Astronomy&Astrophysics* 644, A159 (2020). <https://doi.org/10.1051/0004-6361/202038368>
3. R. Haas, E. Varenius, S. Matsumoto, M. Schartner. Observing UT1-UTC with VGOS. *Earth Planets Space* 73, 78 (2021). <https://doi.org/10.1186/s40623-021-01396-2>
4. L. McCallum, L. Chin Chuan, H. Krásná, et al. The Australian mixed-mode observing program. *J Geod* 96, 67 (2022). <https://doi.org/10.1007/s00190-022-01657-2>
5. B. Petrachenko, M. Schartner, M. Xu. VGOS Technology R&D Sessions. *International VLBI Service for Geodesy and Astrometry 2022 General Meeting Proceedings*, edited by K. L. Armstrong, D. Behrend, and K. D. Baver, NASA/CP-20220018789 (2023). https://ivscc.gsfc.nasa.gov/publications/gm2022/28_petrachenko_etal.pdf
6. M. Schartner, J. Böhm. VieSched++: A new VLBI scheduling software for geodesy and astrometry, *Publications of the Astronomical Society of the Pacific*, 131(1002), ab1820, 2019. <https://doi.org/10.1088/1538-3873/ab1820>
7. M. Schartner, C. Plötz, B. Soja. Improvements and comparison of VLBI INT2 and INT3 session performance. *J Geod* 96, 26 (2022). <https://doi.org/10.1007/s00190-022-01621-0>
8. M. Schartner, L. Petrov, C. Plötz, et al. VGOS VLBI Intensives between MACGO12M and WETTZ12M for the rapid determination of UT1-UTC. *REFAG2022 proceedings*, (submitted to IAGS).

NEOS Operation Center

David M. Hall, Sara Hardin

Abstract This report covers the activities of the NEOS Operation Center at USNO for 2021 and 2022. The Operation Center schedules the IVS-R4 rapid-turnaround and the IVS-INT-1 Intensive sessions.

related at the Washington Correlator, which is located at USNO and is run by NEOS.

Additional sessions with the Mauna Kea VLBA antenna were scheduled as needed when Kokee Park experienced downtime.

1 VLBI Operation

Each week NEOS operations consisted of one 24-hour duration IVS-R4 observing session and five one-hour duration IVS-INT-1 (“Intensive”) sessions. IVS-R4 sessions were observed on Thursday-Friday and were used to measure all five Earth Orientation Parameters, while IVS-INT-1 sessions were observed daily Monday-Friday and were used to measure UT1-UTC. In 2021–2022, the operational IVS-R4 network consisted of eight to 12 stations. The regular stations for the weekday IVS Intensives were Kokee Park and Wettzell. Table 1 shows the number of sessions scheduled during the 2021–2022 period.

2 Staff

D. Hall and M. S. Carter are the main staff members of the NEOS Operation Center. Mr. Hall is responsible for the overall management, and Carter makes the schedules. M. S. Carter is located at the USNO Flagstaff Station (NOFS).

Personnel from the Washington Correlator provide support for updates and as backup. Andrew Sargent was the backup scheduler for most of 2021–2022. Sara Hardin transitioned to that role when Andrew Sargent left the VLBI group.

Table 1 Sessions scheduled in 2021–2022.

Type	Mode	Number scheduled
IVS-INT-1	S/X	483
IVS-R4	S/X	102

References

1. Vandenberg N (1999) Sked: interactive/automatic scheduling program. NASA/Goddard Space Flight Center NVI, Inc, Greenbelt

The Operation Center updated the version of SKED [1] as updates became available. All sessions are cor-

U. S. Naval Observatory

NEOS Operation Center

IVS 2021+2022 Biennial Report

CORRELATORS



Bonn Correlator Report 2021–2022

Yoon Kyung Choi^{1,2,3}, Simone Bernhart^{1,2,3}, Helge Rottmann³, Jan Wagner³, Alan Roy³, Sven Dornbusch³

Abstract We report on the status of the Bonn Correlation Center focusing on geodesy for the year 2021 and 2022, as well as technical aspects of the cluster and its performance. We summarize our duties as one of the IVS correlators and recent progress.

1 General Information

The Bonn correlator, located in Bonn, Germany, is operated jointly by the Max Planck Institute for Radio Astronomy (MPIfR) in Bonn and the Federal Agency for Cartography and Geodesy (Bundesamt für Kartographie und Geodäsie, BKG) in Frankfurt. The MPIfR hosts the correlator facility and shares with the BKG the costs of the cluster, most of the staff and the Internet connectivity. Since January 2017 the personnel responsible for the correlation of geodetic sessions are employed by the BKG via a private contractor, the Reichert GmbH.

2 Component Description

The Distributed FX software correlator (Deller et al. 2011) in various versions is used at the Bonn correlator. For geodetic production we currently use DiFX-2.6.3

1. Reichert GmbH
2. Bundesamt für Kartographie und Geodäsie
3. Max-Planck-Institut für Radioastronomie

Bonn Correlator

IVS 2021+2022 Biennial Report

for legacy S/X sessions and DiFX-2.5.4 for VGOS observations.

The correlator is running on a high-performance computing (HPC) cluster, which was renewed in 2015 to match both VGOS and mm-VLBI requirements. It consists of (1) 68 nodes with 20 compute cores each, for a total of 1,360 cores, (2) three head nodes which allow execution of several correlations and postprocessing in parallel, (3) 3.0 PB disk space in RAID units and combined in a BeeGFS parallel cluster file system, (4) 14 Mark 5 playback units, and (5) 11 Mark 6 playback units each with four and some with six bays.

The raw data are recorded at the stations either on modules (Mark 5 or Mark 6) or on storage servers, usually referred to as Flexbuffs. For geodetic experiments, the data are mostly e-transferred to the HPC cluster. The cluster is connected to the Internet both through a commercial 10-Gbit line and a 1-Gbit line. The latter is part of the German Research Network (Deutsches Forschungsnetz, DFN). Various raw data formats have already been correlated in Bonn: Mark IV, Mk5, DVP, and various types of VDIF.

The correlator output data (SWIN files) can be exported to FITS and HOPS (Mark IV) formats. For post-processing, the following software packages are available: AIPS, CASA, PIMA, and HOPS (Haystack Observatory Postprocessing System), the latter of which is the standard tool for geodesy. The correlator outputs and other important files (e.g., VEX and v2d files) are backed up daily on the HPC cluster. The final products are archived on the MPIfR archive server, where they will be kept for at least ten years. The EXPAD and COMEDIA tools are used for bookkeeping experiments and corresponding media correlated in Bonn. They are the frontends to a local database that records all relevant information such as the observation date,

participating stations, modules, and status of the experiment.

3 Staff

The geodesy group at the Bonn correlator has 1.6 FTEs.

S. Bernhart and Y. K. Choi – coordinate the data logistics including e-transfer and module shipment, prepare and supervise the correlation, carry out the post-processing, and deliver the resulting observables to the IVS repository in the form of databases. Besides these standard duties, they provide the stations with feedback on their performance and support tests of the VLBI systems, in particular for the Wettzell Observatory. Moreover, the geodesy group maintains the e-transfer web page (<http://www3.mpifr-bonn.mpg.de/cgi-bin/showtransfers.cgi>) that is used by the bulk of the IVS community in order to coordinate electronic data transfers, in particular regarding bandwidth availability and port occupancy.

The MPIfR staff at the Bonn correlator is a subgroup of the VLBI Technical Department, headed by H. Rottmann. Its members are A. Roy, J. Wagner, S. Dornbusch, and G. Tuccari (guest). In addition to the scientific staff, there is one technician (R. Märten), and one engineer (M. Wunderlich). The group is responsible for keeping the cluster software up to date, for hardware maintenance and repair, as well as for IT support and software correlator improvements. The group members are involved in several astronomical projects, which are focused on very high resolution imaging, especially with the Event Horizon Telescope (EHT), and studies of active galaxies with the Global mm-VLBI Array (GMVA).

H. Rottmann – head of the VLBI technical department, computer systems, and cluster administration, and is responsible for the beamforming/phasing software of ALMA, DiFX developer.

S. Dornbusch – soft- and firmware developer for the DBBC3 backend. Responsible for software maintenance, testing, verification, and station support for the DBBC2 and DBBC3. He is also an active soft- and firmware developer for the BRAND receiver system.

A. Roy – project manager for VLBI at the Atacama Pathfinder Experiment (APEX), for DBBC3 commissioning, and head of the polarization conversion ef-

fort for Atacama Large Millimeter/submillimeter Array (ALMA) VLBI and the BRAND system.

G. Tuccari – guest scientist from INAF, leader of the Digital Base Band Converter project (DBBC) and the Fila10G development, as well as project engineer of the BRAND receiver.

J. Wagner – general support scientist work for mm-VLBI (EHT, GMVA, APEX setup and observing), correlation of EHT and partly GMVA experiments, technical assistance also for geodetic processing.

The Bonn correlator also serves as an inherent test-bench for the DiFX and e-transfer software, so that all its personnel contribute to the debugging of these tools.

4 Current Status and Activities

4.1 IVS Correlation

Our duties include the correlation of Intensive series (INT3), R1 series as well as OHIG and T2 series for IVS legacy S/X sessions and VGOS 24-hour sessions.

In 2021 we correlated 43 INT3 (one hour, weekly on Monday) sessions, 52 R1 (24 hours, weekly) sessions, seven T2 (24 hours, bi-monthly) sessions, six OHIG (24 hours, bi-monthly) sessions and eight VGOS (24 hours) sessions. In 2022, we processed 34 INT3 sessions, 52 R1 sessions, nine T2 sessions, six OHIG sessions, and eleven VGOS sessions.

4.2 Other IVS Duties

S. Bernhart has become a member of the IVS Committee on Education and Training (IVS CTE) that organizes IVS Training Schools on VLBI for Geodesy and Astrometry, the last one was held March 22–25, 2022 (virtual format) in conjunction with the 12th IVS General Meeting.

Moreover, she was part of the IVS Working Group on the implementation of a new vgosDB naming convention and master file format.

4.3 EU-VGOS

In March 2018, on the initiative of W. Alef of the Bonn Correlation Center, a collaboration with the three

European stations of Wettzell, Onsala, and Yebes, equipped with both standard S/X and VGOS systems, was launched to carry out a VGOS proof-of-concept study. The aim of the project is to verify the processing chain for VGOS experiments end-to-end, from the scheduling to the geodetic analysis of the derived observables.

Even though there were no observations scheduled in 2021 and only one in 2022, the various subgroups (WG Correlation, WG Analysis, WG Operations and WG e-transfer) as well as the EU-VGOS management team (F. Jaron, chair and S. Bernhart, secretary) were quite active performing a number of virtual meetings in order to discuss achieved results and future plans. In October 2021, the Second EU-VGOS Workshop was held as a hybrid meeting hosted by the TU Vienna.

At the (virtual) EU-VGOS General Meeting in April 2022, it was decided to install a proposal system for future observations.

4.4 DiFX-2.5.4 and 2.5.5

In addition to our EU-VGOS correlations, we started correlating 24-hour IVS VGOS sessions in 2021. Each correlator had their own local patches and different versions of DiFX and difx2mark4 to correlate and convert the data.

In August 2021, to regain a consistent DiFX-2.5 installation for VGOS correlation at all sites, J. Wagner gathered the accumulated patches and also backported certain features from mainline DiFX-2.6. Combined with Haystack-provided HOPS 3.22, these were released to the DiFX community as DiFX 2.5.4.

In October 2022, to fix an issue in correlation of multi-datastream Ishioka data that affects the handling of IF-specific LO and clock offsets (*loOffsets*, *freq-ClockOffs*), he released DiFX 2.5.5.

4.5 Multi-datastream Correlation

Recorded bands are spread across several files and previously these VGOS data should be vmux-ed to “merge” them for single-datastream correlation under DiFX-2.5.3. This occupied disk space doubly and needed extra time/work. In Bonn we carry out

DiFX multi-datastream correlation, possible under DiFX-2.5.4/2.5.5 and 2.6.3 using multi-datastream configuration. Onsala Oe/Ow and Ishioka now observe using per-band recordings (multi-files) and e-transfer these recordings directly without prior “merging.”

4.6 10-Gbps Upgrade

Previously, we used two 1-Gbps NREN (DFN) links (BONN, RZBONN Servers). In October 2021, we upgraded to a commercial 10-Gbps link (NetCologne) for e-VLBI and replaced the “BONN” server. “RZBONN” is still working. Transfer protocols that we use are JIVE *jive5ab/m5copy*, and JIVE e-transfer etc/etd¹. After the upgrade, transfer speeds are much faster than before. For example, in the case of Onsala VGOS data (23 TB) transfer takes two days instead of two weeks.

5 Future Plans

In 2023 we are assigned to correlate 39 INT3 sessions, 52 R1 sessions, regularly planned for mixed-mode, seven T2, six OHIG, and ten VGOS sessions. The Australian stations are included in the network for the VGOS sessions from 2023.

Furthermore, the geodesy group will continue testing the latest DiFX version (currently DiFX-2.8) before applying it for normal operation. After comparing the SWIN files as well as the resulting observables of the presently used DiFX version (2.6.3) and the upcoming release, we will switch to the latter one as soon as possible—its stability presupposed.

References

1. A. T. Deller, W. F. Brisken, C. J. Phillips, J. Morgan, W. Alef, R. Cappallo, E. Middelberg, J. D. Romney, H. Rottmann, S. J. Tingay & R. Wayth, “DiFX-2: A More Flexible, Efficient, Robust, and Powerful Software Correlator”, PASP, 2011, 123, 275–287.

¹ <https://github.com/jive-vlbi/etransfer>

MIT Haystack Observatory Correlator Report 2021–2022

Mike Titus¹, John Barrett¹, Roger Cappallo¹, Brian Corey¹, Pedro Elosegui¹, Dan Hoak¹, Arthur Niell¹, Chester Rusczyk¹, Jason SooHoo¹

Abstract This report summarizes the activities of the VLBI correlator at the Massachusetts Institute of Technology (MIT) Haystack Observatory that spans the 2021–2022 biennial period.

1 Introduction

The distributed FX-type (DiFX) VLBI software correlator (*Deller et al.*, 2011) and the Haystack Observatory Postprocessing System (HOPS) software package (e.g., *Cappallo*, 2017) of the MIT Haystack Observatory (herein “MIT Haystack correlator”), located in Westford, Massachusetts, is supported by both the NASA Space Geodesy Project (SGP) and the National Science Foundation (NSF). The correlator is dedicated approximately equally to the geodetic pursuits for the International VLBI Service (IVS) and to radio astronomy imaging for the Event Horizon Telescope (EHT) project.

Besides contributing operationally to those science endeavors, the MIT Haystack correlator also serves as a development system for testing new correlation modes, such as those needed for observations with the next-generation broadband VLBI system—the so-called VLBI Global Observing System (VGOS; e.g., *Niell et al.*, 2018; *Merkowitz et al.*, 2019)—and for recorder/playback technology developments, such as the Mark 6 system.

¹MIT Haystack Observatory, Westford, MA

The MIT Haystack correlator also provides software support for the processing of VLBI experiments to similar DiFX-HOPS installations at the U.S. Naval Observatory (USNO), the Max-Planck-Institut für Radioastronomie (MPIfR) in Bonn, Germany, and to various other centers of the general IVS community.

2 Activities during the Past Two Years

2.1 General VGOS Activities

The processing of data from a variety of geodetic sessions is a primary contribution of the MIT Haystack correlator to the already operational VGOS network. Importantly, the correlator also continues to play a key role in providing feedback to stations for repairing problems, equipment tests, and commissioning or testing of new stations, as well as training and sharing general advice and practical assistance to other correlators worldwide.

In addition to what is described later in this report, dozens of 24-hour VGOS sessions as well as broadband/SX (or modern/legacy) mixed-mode sessions, VGOS Intensive sessions, and various smaller tests were correlated, processed, and analyzed under the auspices of the MIT Haystack correlator. Extensive help was rendered to station staff, VGOS engineers, analysts, and staff at other correlators.

The year 2021 was expressly dedicated to an intense effort to catch up from the slowdown in production that was created by the pandemic in 2020. A total of about 35 VGOS session types, including operations (VO), tests (VT), and Intensives (V2), were processed in full during the course of that year, as well as two

(out of three) major R&D global mixed-mode sessions that were run in 2020. The databases from all these sessions were exported to the Crustal Dynamics Data Information System (CDDIS) repository for public availability. As a result of this effort, all pending sessions from 2020 were completed except for the third and last mixed-mode experiment (a.k.a. RD2007), which will be processed when mixed-mode correlation is further advanced and streamlined.

The year 2022 was then devoted to more contemporary VO, VGOS R&D (VR), and VT sessions, which provided a better opportunity to engage in more active diagnosis and assistance in correction of station problems that had accumulated over the previous years due to lack of proper attention and timely feedback. As a result, help was provided to other correlators for correcting existing problems, especially to USNO, and issues were encountered (e.g., Wettzell band swap, Ishioka lack of phase-calibration-signal condition, McDonald failing phase-calibration signal due to a bad 5-MHz cable, Yebes polarization swaps, sampler delay changes, and various and sundry other problems, to name a few).

2.2 Various Developmental Activities

The MIT Haystack correlator was involved in a number of additional developmental activities and projects largely on an ad-hoc basis aimed to help advance VGOS. These include:

- Local-tie observing sessions between the VGOS station at the McDonald Geophysical Observatory (MGO) and the VLBA station at Fort Davis, Texas.
- Debugging projects surrounding the vgosDb utilities and the release of nuSolve software package versions.
- Extensive testing with RDBE and R2DBE at the Westford station in zero-baseline mode to resolve the upper/lower sideband (USB/LSB) swap ambiguity problem.
- Exploration into the cause of small amounts of data loss from existing recording and correlator playback methods to assess the feasibility of short scan lengths (e.g., 7 s and shorter) in the future.
- Investigations into the potential presence of radio-frequency interference (RFI) in VGOS data from transmitting satellites at 10.7 GHz.

- Participation in a EU-VGOS R&D project involving long (10-min) scans on the radio source 4C 39.25 for cross-polarization bandpass calibration.

2.3 General EHT Activities

The EHT has provided the lion's share of the equipment that comprises the MIT Haystack correlator cluster. Therefore, a few words on work related to that project are warranted and relevant to this report.

Once again, the EHT project released news of fundamental astronomical importance. An image of the black hole at the center of our galaxy, commonly known as Sagittarius A* (SgrA*), was released in May 2022 (*The EHT Collaboration et al.*, 2022). This image was obtained using data from the processing of the April 2017 observing campaign. Production processing of an observing campaign conducted in 2018 was completed and work is in progress to complete the processing of an observing campaign conducted in 2021. A dress rehearsal for a 2022 observing campaign was also conducted and results released.

2.4 Validation of New Stations Joining the VGOS Network

Three new VGOS stations were in the process of technology readiness evaluation and validation required to seamlessly join the VGOS network. The three new VGOS stations are in Australia, Norway, and Portugal.

A new VGOS antenna at the Hobart site in Tasmania, Australia, was fully commissioned and added officially to the VGOS network after several tag-along test sessions in 2022. Moreover, one of the two new VGOS antennas at the Ny-Ålesund site in Svalbard, Norway, is currently proceeding through this same process of validation. Furthermore, a new VGOS antenna located on the island of Santa Maria in the Azores, Portugal, is soon to follow the same validation efforts.

2.5 Mixed-mode Observations

There was a concerted push to get the first two of the three fundamentally important VGOS/legacy mixed-mode observing sessions run in 2020 exported in time for their inclusion in the latest TRF realization, ITRF2020. These (RD2005 and RD2006) were very significant 24-hour sessions involving a total of sixteen stations (i.e., eight VGOS and eight legacy S/X) designed to obtain a global tie between the S/X and VGOS network stations, for which new correlation and post-processing modes needed to be devised and developed.

A third mixed-mode session, RD2007, was also recorded during this biennial period. This session is in the processing queue pending assessment of the efficacy and usefulness of the RD2005 and RD2006 experiments for their intended purpose.

2.6 2021 TOW and Follow-Up Mixed-Mode Correlation Workshop

A virtual Technical Operations Workshop (TOW) was conducted at Haystack in May of 2021. Immediately after the workshop, which concentrated on training station staff in IVS operations, a VGOS correlation workshop was conducted to inform staff at other correlators about Haystack-developed procedures for processing IVS mixed-mode sessions (Barrett et al., 2019). Notes are available at: <https://www.haystack.mit.edu/conference-2/past-conferences/tow2021/>

2.7 Recovery from Effects of the Pandemic

Conditions have mostly returned to normal since the pandemic hit back in 2020. However, it is deemed important to note that remote work on setups, operations, and analysis are now routine and fully incorporated into a significant portion of the modus operandi at the MIT Haystack correlator. Production processing significantly caught up in 2021, as described above.

2.8 DiFX Version Controls

DiFX version testing for validating 2.5.4, 2.6.2, 2.7.1 and trunk versions used for the R/2DBE USB/LSB tests, CALC11 incorporation, and other DiFX features were conducted over this two-year period. Still to this day, the level of complexity in VGOS and mixed-mode operations has resulted in a complex amalgam of different versions of the DiFX software correlator package which need to be used in order to produce valid results. Efforts continue to be made to correct various software flaws in various versions in order to consolidate all the needed fixes into a single version of the DiFX build that all correlators can use.

3 Electronic Transfers of VLBI Data

Non-real-time electronic transfers (e-transfers) of VLBI data have continued during this period. Data from various stations and sessions (e.g., standard legacy S/X stations participating in the bi-monthly session with the ten-station VLBA network, as well as R4 and R&D sessions) were transferred to MIT Haystack during the past two years for in-house correlation and data hosting, and/or for conversion to Mark5/Mark6 media prior to shipping for off-site correlation. There has also been a significant increase of handled e-transfers for VGOS data from VO stations to MIT Haystack, such as for Onsala and Yebes. Also, all data from VGOS Intensive (V2) sessions that were processed by the MIT Haystack correlator over this period were e-transferred. This includes data from KPGO, Wettzell, GGAO, and Westford.

4 Experiments Correlated

A total of approximately 74 geodetic VLBI sessions were processed, at least in part, during the 2021–2022 period. These include three VGOS Tests (VT, all released), four VGOS R&Ds (VR, all released), 32 VGOS Operationals (VO, 23 released), 13 VGOS Intensives (V2, six released), and two mixed-mode VGOS+S/X (both released). Various other VGOS-related test sessions make up the remainder of the count, some of which are described above in the

developmental activities section. As mentioned earlier, this includes the completion of all sessions from 2020, which were impacted by the pandemic.

5 Existing Correlator Capabilities

5.1 Correlator Infrastructure Upgrades

One major enhancement to the capabilities of the MIT Haystack correlator cluster over the last two years was the addition of four new Mark 6 playback units. This was an essential upgrade needed in order to be able to continue to process IVS sessions in tandem with EHT processing, both of which are expanding in the number of stations participating. VGOS sessions now include up to ten stations and the EHT regularly uses at least ten, with more soon to be added.

5.2 Dedicated Room Backup A/C Improvements

Enhancements to the A/C infrastructure are currently in the process of implementation in order to increase the safety and robustness of cooling capacity in the new correlator room as described in the last report.

5.3 Description of the Correlator Cluster

The correlator cluster, as described in the last biennial report, was enhanced by the addition of the four new Mark 6 playback units and cooling improvements, as mentioned above. The correlator consists of 16 cluster PCs (each with a single deca core 2.8-GHz Intel Xeon processor controlled by two equivalent master nodes) to which 38 PCs (each with dual deca core Intel Xeon CPUs) were subsequently added. This merged monolithic (but easily subdivided) “super cluster” has over 1,152 cores.

Connecting, providing data to, and supporting this computing infrastructure are a Gb Ethernet fabric with three 100-Gb Ethernet switches, 197 TB of data storage space, and three file storage servers that can also act as DiFX compute nodes providing >200 TB of file

storage. A total of 15 Mark 6 playback units with DiFX fully installed are connected to the Gb Ethernet fabric.

In addition, racks and uninterruptible power supplies condition and stabilize power provided from a 208-volt power distribution fabric. All of this equipment is housed in a dedicated climate-controlled room, enhanced with further cooling redundancy, and with dedicated electrical infrastructure. The integrated cluster (Figure 1) is used to correlate data from EHT, VGOS, and legacy S/X observing sessions.

6 Staff

The following staff have participated in various aspects of correlation, post-processing, Mark 6, and e-VLBI development and operations.

6.1 Correlator Software Development

- John Barrett - software development and support
- Roger Cappallo - HOPS software development
- Geoff Crew - DiFX, HOPS, and Mark 6
- Dan Hoak - HOPS software development and support
- Tim Morin - cluster IT, hardware/software support
- Jason SooHoo - cluster IT, Mark 6, and e-VLBI
- Chester Ruszczyk - Mark 6 and e-VLBI

6.2 Correlator Operations

- John Barrett - technique development
- Alex Burns - Mark 6 and general technical support
- Brian Corey - correlation oversight, station evaluation, and technique development
- Dan Hoak - technique development
- Glenn Millson - correlator operations
- Dhiman Mondal - post-processing analysis
- Arthur Niell - technique development
- Don Sousa - media management and shipping
- Mike Titus - correlator operations setup, oversight, and hardware/software testing
- Ken Wilson - correlator and Mark 6 maintenance

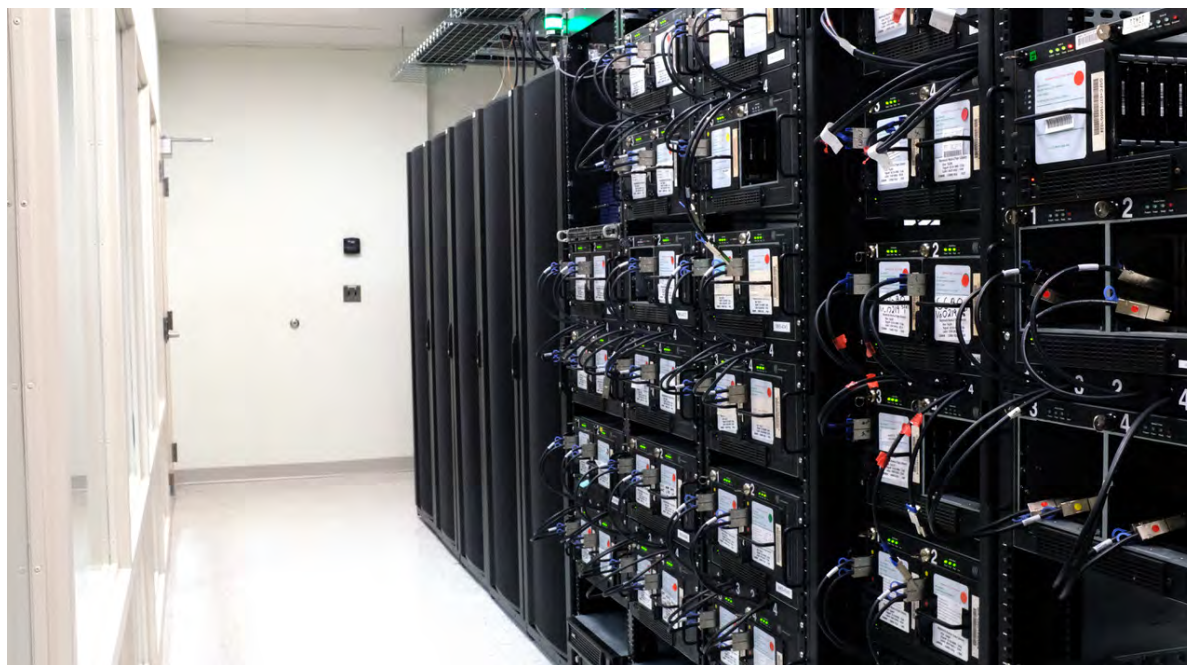

Fig. 1 (Background) Cluster correlator and (foreground) Mark 6 playback units at the MIT Haystack Observatory.

7 Conclusions and Outlook

A return to normalcy means that fresh efforts to expand and improve the VGOS network can accelerate. As has always been the case for the MIT Haystack correlator, a major focus will be on producing correlation and post-processing products of high quality, especially for the challenging mixed-mode sessions, and on improving the overall data quality when and where possible.

Close collaboration with the expanding list of operational correlators as they take on more of the VGOS processing load will continue, as will commissioning and testing activities as the VGOS station network expands. Perhaps a prime example of network expansion is the buildout of the new VGOS station at the Fortaleza Geophysical Observatory (FGO) in Brazil, which is to occur during the next (i.e., 2023–2024) biennial period.

References

- [Barrett et al., 2019] Barrett, J., R. Cappallo, B. Corey, G. Crew, P. Elosegui, A. Niell, C. Ruszczyk, and M. Titus (2019), VGOS Data Processing Manual, *MIT Haystack Observatory, version 1.0*, pp. 32.
- [Cappallo, 2017] Cappallo, R. (2017), *fourfit* user’s manual, *MIT Haystack Observatory*, <https://www.haystack.mit.edu/haystack-observatory-postprocessing-system-hops>.
- [Deller et al., 2011] Deller, A. T., W. F. Brisken, C. J. Phillips, J. Morgan, W. Alef, R. Cappallo, E. Middelberg, J. Romney, H. Rottmann, S. J. Tingay, and R. Wayth (2011), DiFX-2: A more flexible, efficient, robust, and powerful software correlator, *Pubs. Astron. Soc. Pacific*, 123(901), 275.
- [Merkowitz et al., 2019] Merkowitz, S. M., S. Bolotin, P. Elosegui, et al. (2019), Modernizing and expanding the NASA Space Geodesy Network to meet future geodetic requirements, *J. Geodesy*, 93(11):2263–73, <https://doi.org/10.1007/s00190-018-1204-5>.
- [Niell et al., 2018] Niell, A., J. Barrett, A. Burns, R. Cappallo, B. Corey, M. Derome, C. Eckert, P. Elosegui, et al. (2018), Demonstration of a Broadband Very Long Baseline Interferometer System: A New Instrument for High-Precision Space Geodesy, *Radio Science*, <https://doi.org/10.1029/2018RS006617>.
- [The EHT Collaboration et al., 2022] The Event Horizon Telescope Collaboration (2022), First Sagittarius A* Event Horizon Telescope Results I. The Shadow of the Supermassive Black Hole in the Center of the Milky Way, *Astrophys. J. Lett.* 930(L12), <https://doi.org/10.3847/2041-8213/ac6674>.

IAA Correlator Center Report 2021–2022

Igor Surkis, Voitsekh Ken, Alexey Melnikov, Ivan Arnaut, Alexander Kumeiko, Yana Kurdubova, Nadezhda Mishina, Vladimir Mishin, Violetta Shantyr, Vladimir Zimovsky, Mikhail Zorin

Abstract The IAA RAS Correlator Center activities in 2021 and 2022 are described. All regular observations of the Russian national geodetic VLBI programs were transferred to the IAA in e-VLBI mode and correlated using RASFX and DiFX correlators.

1 General Information

The Correlator Center is located in St. Petersburg, Russia, and maintained by the Institute of Applied Astronomy. The main goal of the Correlator Center is the processing of the geodetic, astrometric, and astrophysical observations made with the Russian national Quasar VLBI network [1]. The Svetloe, Badary, and Zelenchukskaya observatories are connected to the Correlator Center by a 2-Gbps link. At present, the RASFX and DiFX correlators are hosted and operated by the Correlator Center.

In 2014, the Russian Academy of Sciences FX (RASFX) six-station, near-real time GPU-based VGOS correlator was developed. The correlator software is installed on an HPC cluster with 85.34 Tflops performance, which contains 40 servers, each equipped with two Intel CPUs and two Nvidia GPUs, and is able to process up to a 96-Gbps input data rate [2].

Since 2015, multiple versions of the DiFX software correlator have been installed and run on the HPC cluster.

The Institute of Applied Astronomy of the Russian Academy of Sciences (IAA RAS)

IAA Correlator Center

IVS 2021+2022 Biennial Report

2 Activities during the Past Two Years

Starting in 2021, the Astrometric Radio interferometric Correlator (ARC) was outaged and no longer used in the routine processing. The observations carried out on RT-32 are being processed with RASFX correlator.

At the end of 2020, RT-13 “Svetloe” was equipped with a brand new digital acquisition system (DAS) Multifunctional Digital Backend (MDBE). In 2022, the MDBE was installed in parallel with the R1002M DAS on RT-32 “Svetloe.” During the 2021–2022 we have accomplished various compatibility tests using MDBE firmware versions designed for different applications. These experiments were processed by both RASFX and DiFX correlators.

Three VGOS-compatible 13.2-m radio telescopes (RT-13) located in Badary, Svetloe, and Zelenchukskaya were used to carry out observations on a regular basis. In mid-July 2020, we began experimenting on scheduling regular one-hour geodetic observations using fixed Siderial Time as the session start time. Since August 7, 2020 and until the end of 2021, we carried out four two-hour S/X sessions and one-hour S/X/Ka every day.

In 2022 we returned to the traditional approach of a fixed UT start time and observed two one-hour S/X and one 0.5-hour S/X/Ka sessions until May 2022. Since May 2022 until the end of the year, we have carried out six one-hour S/X sessions evenly distributed during the day, and one 0.5-hour S/X/Ka session. S/X observations were made using two 512-MHz bandwidth frequency channels (IFs), one IF in each band; S/X/Ka observations were made using four 512-MHz IFs, single in S- and X-band, and two IFs in Ka-band. The total recording rate was 4 Gbps and 8 Gbps for S/X and S/X/Ka observations, respectively. In 2022 we

have carried out four 24-hour experiments in *S/X* frequency mode: in March, June, October, and December. These experiments contain approximately 1,650 scans and about 5,000 observations. The RASFX and DiFX correlators were used to process the data of these sessions.

In 2021–2022, we have done a series of experiments aimed at space vehicle observations with our RT-32 and RT-13 antennae in L- and X-bands. Data processing was performed using the RASFX and DiFX correlators and during post-processing we obtained high-precision VLBI observables: time delay and delay rate. Some preliminary results were published [3]. RASFX software was refined to semi-automatical process of space vehicle observations whose coordinates are known with low accuracy. Processing of such data by traditional methods is performed in two iterations with clarification of initial models.

Finally, the Correlator Center also continued work on testing the receiving and the recording equipment. We have done a few observations in order to calculate signal delay propagation stability and the influence of the equipment delay instability on the Universal Time determination [4]. Also, we have successfully performed on RT-13 one-hour source-tracking sessions with hydrogen frequency standard and passive frequency standard to check the possibility of applying the passive one. These sessions were processed using the RASFX correlator.

3 Staff

The list of the staff members of the IAA RAS Correlator Center in 2021–2022 was as follows:

- Igor Surkis — lead researcher, software developer;
- Voytsekh Ken — GPU software developer, data processing;
- Alexey Melnikov — DiFX processing, scheduler;
- Alexander Kumeiko — software developer, PhD student;
- Vladimir Mishin — software developer, data processing;
- Nadezhda Mishina — software developer, data processing;
- Yana Kurdubova — software developer, data processing;
- Violetta Shantyr — software developer;
- Vladimir Zimovsky — data processing lead;
- Mikhail Zorin — software developer, PhD student;
- Ivan Arnaut — software developer, PhD student;
- Ekaterina Medvedeva — data processing;
- Andrey Mikhailov — Field System support;
- Ilya Bezrukov — e-VLBI data transfer lead;
- Alexander Salnikov — e-VLBI data transfer.

4 Future Plans

In the upcoming years, we will focus on the following tasks:

- routine processing of the geodetic observations;
- sessions for testing compatibility and stability of radio telescope equipment
- research on space vehicles signal processing methods;
- development of software features to increase the level of automation of the processing.

References

1. Shuygina N., Ivanov D., Ipatov A., Gayazov I., Marshalov D., Melnikov A., Kurdubov S., Vasilyev M., Ilyin G., Skurikhina E., Surkis I., Mardyshev V., Mikhailov A., Salnikov A., Vytov A., Rakhimov I., Dyakov A., Olifirov V. Russian VLBI network “Quasar”: Current status and outlook. *Geodesy and Geodynamics*, Vol. 10, Is. 2, pp. 150–156, 2019. <https://doi.org/10.1016/j.geog.2018.09.008>
2. Surkis I., Zimovsky V., Ken V., Kurdubova Ya., Mishin V., Mishina N., Shantyr V. A Radio Interferometric Correlator Based on Graphics-Processing Units. *ISSN 0020-4412, Instruments and Experimental Techniques*, Vol. 61, No. 6, pp. 772–779, 2018.
3. Vasil’ev, M.V., Zimovsky, V.F., Melnikov, A.E. et al. Space Vehicle Observations Using the Quasar VLBI Network. *Instrum Exp Tech*, Vol. 65, pp. 981–994, 2022. <https://doi.org/10.1134/S0020441222060197>
4. Vekshin Yu., Ken V., Kurdubov S. Optimal Signal Averaging Time in VLBI Sessions. *International VLBI Service for Geodesy and Astrometry 2022 General Meeting Proceedings, NASA/CP–20220018789*, pages 144–147, 2023.

Shanghai VLBI Correlator 2021–2022 Report

Xuan He¹, Fengchun Shu¹, Jiangying Gan¹, Yidan Huang¹, Zhong Chen¹, Weimin Zheng¹

Abstract This report summarizes the activities of the Shanghai VLBI Correlator during 2021 and 2022. Highlights include first operation for international VGOS data correlation as well as commissioning of the Shanghai and Urumqi VGOS stations.

1 Introduction

The Shanghai VLBI Correlator is hosted and operated by the Shanghai Astronomical Observatory (SHAO), Chinese Academy of Sciences (CAS). It is located at the Sheshan campus, about 40 kilometers from the Xujiahui headquarters of SHAO. The Shanghai correlator has been used in the data processing of the Chinese VLBI Network (CVN) which consists of Seshan25, Tianma65, Kunming, Urumqi, and Miyun50 stations. The Shanghai correlator was accepted as an IVS correlator in March 2012. It became operational for the IVS data correlation in 2015.

2 Component Description

We are operating two types of correlators. The CVN correlator, developed by SHAO, is mainly used for spacecraft VLBI tracking and produces differential VLBI observables. The data latency is less than one minute in real-time mode, and the typical accuracy is

1. Shanghai Astronomical Observatory, Chinese Academy of Sciences

Shanghai Correlator

IVS 2021+2022 Biennial Report

better than 1 ns. The second correlator is the DiFX software correlator, which is dedicated to astronomical and geodetic data correlation.

The DiFX software was installed on a high performance hardware platform, with a 420 CPU core cluster system and total 1,400 TB storage space. Three Mark 6 units can be used to playback VDIF data. The suite version is Mark6_1.3c with dplane as 1.22 and cplane as 1.0.26. Features of the DiFX cluster system are listed as follows:

- DiFX 2.6.2 & 2.6.1, HOPS 3.22, nuSolve 0.7.3.
- Head nodes: DELL R820 (E5-4610 CPU, 2.4 GHz, 2*6 cores), 64 GB Memory, DELL R730 (E5-2623 CPU, 3.0 GHz, 2*4 cores), 64 GB Memory.
- Computing nodes: 20 DELL R630 nodes, two socket Intel E5-2660 CPU (2.6 GHz, ten cores), 64 GB Memory, 400 cores in total.
- I/O nodes: RAID6, 1,400 TB raw data storage capacity.
- Data playback units: three Mark 5B and three Mark 6.
- 56 G Infiniband for internal computing network connection.
- 1/10 G Ethernet for internal and external network connection.

DiFX 2.6.1 and HOPS 3.22 were patched in order to process VGOS raw data.

3 Staff

The people involved in the operation and development of the correlator as well as the VLBI digital backend are listed below.

3.1 Operations Team

- Fengchun Shu: group head, scheduler, experiment oversight
- Zhong Chen: e-transfer support, cluster administration
- Xuan He: DiFX operation, software maintenance
- Tianyu Jiang: data playback, DiFX operation
- Yidan Huang: DiFX operation, post-correlation technique development
- Jiangying Gan: DiFX operation
- Wu Jiang: DiFX operation for astronomical data
- Zhanghu Chu: media library
- Shaoguang Guo: Mark 6 maintenance

Xuan He is the only person to work full-time on geodetic VLBI data correlation.

3.2 Technique Development Team

- Weimin Zheng: group head, software correlator and VLBI terminal development
- Juan Zhang: software correlator development and maintenance
- Lei Liu: software correlator development
- Ping Rui: visualization programming and operation for CVN correlator
- Fengxian Tong: VLBI scheduling and modeling
- Li Tong: VLBI raw data simulation
- Renjie Zhu: CDAS development
- Xiaochuan Qu: CDAS development

4 Summary of Activities

4.1 DiFX Correlation

The latest stable software versions of DiFX and HOPS were used for regular IVS data correlation. As for VGOS data, we used DiFX 2.6.1 for correlation, DiFX 2.6.2 for data conversion to Mark IV, and then HOPS 3.22 for post-processing. As mentioned in Section 2, DiFX 2.6.1 was patched to fix the extraction of the PCAL 10-MHz interval. The bug that caused the pc_phase of multiple data stream stations not to be calculated by the program was fixed in HOPS 3.22.

Our correlator has been operational for international VGOS data correlation since 2021. In addition to correlation reports and vgosDB files, we began to upload SWIN Level 1 data to the BKG Data Center¹ in 2022. We submitted SWIN files for five sessions observed in 2021. All SWIN files of the sessions correlated at SHAO in 2022 were uploaded. In some cases we produced FITS-IDI files, which can be downloaded on request by users.

We did not implement the function of Mark 6 native correlation. A software program similar to VMUX was developed and used to copy the data from modules to our disk array. A gathering rate at 10 Gbps and a de-threading rate at 9 Gbps can be reached.

4.2 e-VLBI

The network link to Seshan25 and Tianma65 is 10 Gbps. The network link to the Urumqi, Kunming, and Beijing stations is 200 Mbps for tracking spacecraft. In the Chang'e 5 lunar mission and Tianwen-1 Mars mission, we performed real-time data transfer at a 128 Mbps data rate for each station.

However, for regular geodetic observations, Urumqi and Kunming stations always ship modules to Shanghai. In 2022, we performed some Intensive UT1 experiments using Seshan13 and Urumqi13. After the end of observations, the raw data were e-transferred from Urumqi to Shanghai at a data rate of 100 Mbps.

In order to process IVS global sessions, we have established the network link to most of the IVS stations and correlators. The regular data rate is 2 Gbps. Two regular stations (MATERA and KOKEE) and three VGOS stations (GGAO12M, KOKEE12M, and MACGO12M), usually ship modules to Shanghai.

4.3 Experiments Correlated

We correlated 24 IVS sessions in 2021 and 23 sessions in 2022, including four VGOS sessions each year. Most of them are focused on VLBI absolute astrometry. There is no stringent requirement for data latency.

¹ <https://ivs.bkg.bund.de>

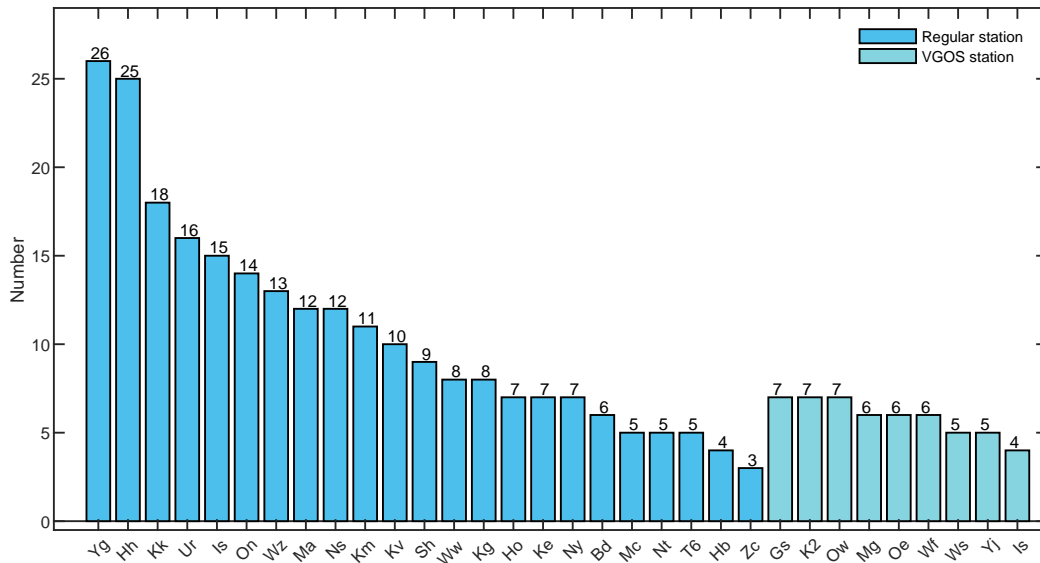

Fig. 1 Statistics of the total sessions for each station correlated at Shanghai from 2021 to 2022.

We aimed to deliver the correlation products in three months. More details can be found in Table 1.

recently, the AOV sessions are more focused on mixed-mode observations.

Table 1 Statistics of experiments correlated.

Session Type	2021	2022
AOV	5	4
APSG	2	2
IVS-CRF	6	6
IVS-R&D	7	7
VGOS-OPS	4	4
Total	24	23

4.4 International VGOS Correlation

We have correlated eight VGOS-OPS experiments, with four sessions each year. The first session correlated at Shanghai was VO1047, observed on February 16, 2021. The raw data transmission status of VO1047 is shown in Figure 2.

So far we have correlated 181 IVS sessions since 2015. The total cumulative data volume is approximately 7.7 PB. It is worth noting that the cumulative data volume from 2021 to 2022 is about 3.6 PB, collected from more than 260 station days. The top five stations with most observing days are YARRA12M, HARTRAO, KOKEE, URUMQI, and Ishioka. More details are shown in Figure 1.

All APSG sessions and some AOV sessions were scheduled by SHAO. The APSG observing sessions are dedicated to measure positions and velocities of stations in the Pacific Rim. The AOV sessions organized by SHAO were focused on astrometry of weak sources in the ecliptic plane and the southern hemisphere. Most

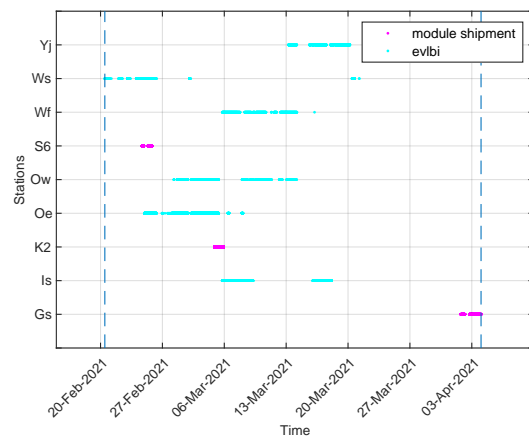

Fig. 2 Raw data transmission of VO1047.

Because we only have 2 Gbps bandwidth available for the international network link, the e-transfer of data is very time consuming. The data throughput rate is up to 18 Gbps during the correlation procedure.

In addition, we have performed nine mixed-mode AOV sessions, with the participation of two Australian VGOS stations.

4.5 Commissioning VGOS stations

During the commissioning phase, we have performed 14 experiments to test SESHAN13 and URUMQI13. Each experiment lasted for 24 hours. We first used a standard VGOS frequency sequence. In order to avoid a more serious RFI, the frequency sequence was modified. In addition to broadband observations, we also performed a few X/Ka dual band test observations.

The Chinese VGOS stations are equipped with the China Data Acquisition System (CDAS2) and Mark 6. The data produced by CDAS2 are real samples recorded in VDIF format, with eight threads and a length of 8,032 frames.

The PCAL of URUMQI13 is unstable, so we continuously performed manual phase calibrations. The PCAL of SESHAN13 is relatively stable. However, the fringes in band A are relatively weak due to RFI caused by 5G base stations. The fringes in the high-frequency band D are sometimes weak. In addition, the proxy cable delays are very noisy; thus, they are not included in the database files.

4.6 Other Geodetic Related Correlations

Following the successful K-band fringe tests, there are regular K-band geodetic sessions conducted within the East Asian VLBI Network (EAVN). The first regular session has been correlated at Shanghai.

We correlated one LBA session aimed at astrometry of vela pulsar. We managed to handle the raw data of the DSS36 station. In this experiment, its S-band fringe was relatively weak.

5 Future Plans

We will continue IVS data correlation, with an emphasis on VGOS sessions and AOV mixed-mode sessions. Due to the change of the master file format, and the vgosDB name and correlation report format, we will update the associated softwares on the platform before the first observation data processed by SHAO in 2023. After maintenance of the Tianma VGOS antenna, we plan to perform more VGOS observations using three Chinese stations.

Acknowledgements

We acknowledge the support of National Natural Science Foundation of China (Grant No. 12073065).

Tsukuba VLBI Correlator

Yu Takagi¹, Tomokazu Nakakuki¹, Tetsuya Hara^{1,2}

Abstract This report summarizes the activities of the Tsukuba VLBI Correlator during 2021 and 2022. The correlator was regularly involved in the weekend IVS Intensive (INT-2) sessions using the K5/VSSP correlation software and the Asia-Oceania VLBI Group for Geodesy and Astrometry (AOV) sessions using the DiFX and HOPS software. The correlator began processing VGOS Intensives between Ishioka and the Onsala twin telescopes at the end of March 2022.

1 Introduction

The Tsukuba Correlator, located in Tsukuba, Japan, is operated by the Geospatial Information Authority of Japan (GSI). It is fully devoted to processing geodetic VLBI observations of the International VLBI Service for Geodesy and Astrometry (IVS). Almost all of the weekend IVS Intensive (INT-2) sessions for UT1–UTC (=dUT1) estimation and five of the twelve Asia-Oceania VLBI Group for Geodesy and Astrometry (AOV) sessions, which began as regular IVS sessions in 2015, were processed at the correlator. All of the AOV sessions were conducted as mixed-mode sessions in which both S/X and VGOS stations participated and observe S- and X-bands during 2021 and 2022. The correlator began processing VGOS Intensives between Ishioka and the Onsala twin telescopes (VGOS-B and VGOS-C series) at the end of March 2022.

1. Geospatial Information Authority of Japan
2. Advanced Engineering Service Co. Ltd.

Tsukuba VLBI Correlator

IVS 2021+2022 Biennial Report

The K5/VSSP correlation software developed by the National Institute of Information and Communications Technology (NICT) was used for the processing of INT-2 sessions, while DiFX and HOPS were used for all of the AOV sessions and VGOS Intensives.

2 Component Description

2.1 e-VLBI

The Tsukuba VLBI Correlator is connected to a broadband network, and all observed VLBI data are delivered via the network. The correlator has a 10-Gbps dedicated link to the SINET6 operated by the National Institute of Informatics (NII), which is connected to several research networks in the world such as Internet2 in the U.S., GÉANT in Europe, and Asi@Connect in Asia. It enables us to transfer massive data between the correlator and overseas IVS components. The Ishioka VLBI station is connected to the correlator and SINET6 with a 10-Gbps dedicated cable.

2.2 Correlation Software

2.2.1 K5/VSSP

The correlator uses the K5/VSSP software, which was developed and has been maintained by NICT, to process the INT-2 sessions. The software consists of several programs for the calculation of a priori values of delay and delay rate (*apri_calc*), for the correlation processing for all observations (*fx_cor_new* or *cor_new*),

and for monitoring the results of the correlation processing by performing a so-called “coarse search” (*sdelay*), followed by several utilities such as *komb* for the bandwidth synthesis [1]. The software can handle not only K5 format data but also Mark 5B and VDIF format data without format conversion in the latest version.

2.2.2 DiFX and HOPS

DiFX and HOPS are also installed at the correlator and used to process AOV sessions and VGOS Intensive sessions. Although the K5/VSSP software was used for AOV sessions, DiFX and HOPS were adopted when they moved from S/X to mixed mode in 2021.

2.3 Correlation Procedure

2.3.1 INT-2 sessions

The typical process for INT-2 sessions and the programs used in each process are described below.

1. Transferring data from network stations to the correlator (*tsunami* and *tsunamid*, or *m5copy*).
2. Preparation of a priori parameter files (*apri_calc*).
3. Fringe search to find a clock offset at each pair of stations (*fx_cor_new* or *cor_new*).
4. Running correlation processing for all observations (*fx_cor_new* or *cor_new*).
5. Coarse search for estimating residual delay and delay rate, and plotting them on a 3-D diagram (*sdelay*).
6. Bandwidth synthesis to derive a multi-band delay (*komb*).
7. Database creation to be submitted to IVS Data Centers (*vgosDbMake*).

The correlation and analysis management programs developed by GSI can run the above processes consecutively and automatically. The program for the management of data transfer *rapid_transfer* can access a data server in an observing station and transfer the data automatically. It can transfer the data concurrently with the start of the session as needed. *Rapid_cor* is a program to search for a fringe for each baseline based on the clock information of each station written in the FS

log, as well as the station positions and source coordinates described in the schedule file and external a priori Earth orientation parameters. Once the fringe is detected, the main correlation processes run one after another with the clock offset and rate information derived from the fringe search process until the last observation. *Rapid_komb* executes *komb* on the stream of correlation outputs for bandwidth synthesis.

For the weekend Intensive sessions, *rapid_c5pp*, which gives an interface to VLBI analysis software *c5++*, executes analysis automatically once the bandwidth synthesis process finishes and delivers the result to the community (refer to the report “Tsukuba VLBI Analysis Center” in this volume for more details). The database is created manually with *vgosDbMake* for the *vgosDb* format [2] and is submitted to IVS Data Centers.

2.3.2 AOV and VGOS Intensives

As described above, DiFX and HOPS are used to process AOV sessions and VGOS Intensives, where VGOS stations participate. In 2021, AOV sessions moved to mixed-mode sessions, which are similar to Australian mixed-mode sessions [3], and we process the data following the method (e.g., [4]) shared amongst the AOV community. The setting of the VGOS Intensives between Ishioka and the Onsala twin telescopes is the same as VO sessions, and the data are processed in the way described in the manual released by the MIT Haystack Observatory [5].

2.4 Correlator Hardware Capabilities

The hardware supporting the activities of the correlator is summarized in Table 1. All these pieces of equipment are general purpose and commercially available products. The system of the correlator was gradually updated, and the system used as a backup system until two years ago is now the main system. At present, the main system consists of nine servers and a storage with a capacity of 753 TB.

Table 1 Correlator hardware capabilities.

	Main System	Backup System
Number of servers	10 <ul style="list-style-type: none"> • 7 for correlation processing • 2 for controlling correlation processing • 1 for data storage 	16 <ul style="list-style-type: none"> • 14 for correlation processing • 2 for controlling correlation processing
Operating System	CentOS version 7.8 and 7.9	Red Hat Enterprise Linux 6.3
CPU	Intel Xeon Gold 6130 GHz @ 2.10 GHz 16 cores x 4 Intel Xeon Gold 6230 GHz @ 2.10 GHz 20 cores x 12 Intel Xeon Silver 4215R @ 3.20 GHz 8 cores x 3 Intel Xeon X3360 @ 2.83 GHz 4 cores x 1	Intel Xeon X5678 @ 3.60 GHz 4 cores x 32
Total storage capacity	764 Tbytes	513 Tbytes
Network	Dedicated 10-Gbps line connected to SINET6 by NII	

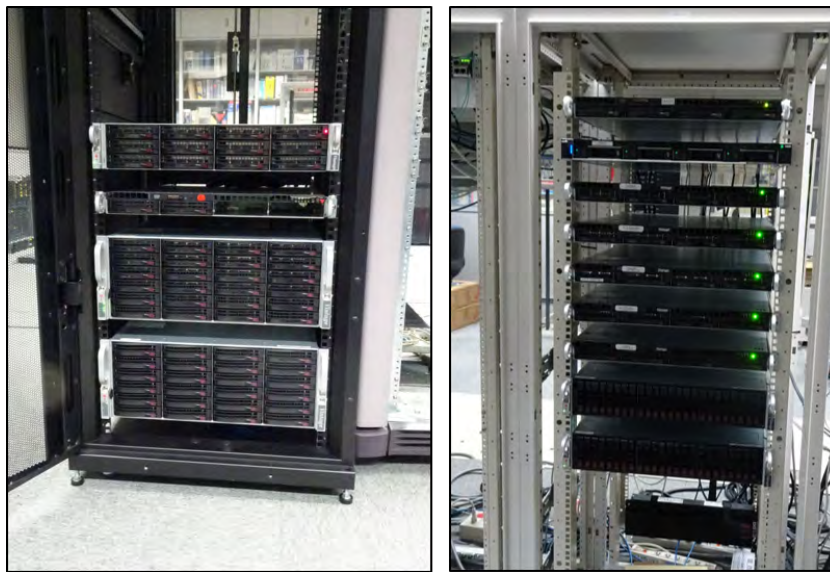
**Fig. 1** View of the main system of the Tsukuba VLBI Correlator. The left shows the storage and the right the data-processing servers.

3 Staff

The technical staff at the correlator as of December 2022 are:

- **Yu Takagi** — correlator/analysis chief, management.
- **Tomokazu Nakakuki** — correlator/analysis operator, coordination.
- **Tetsuya Hara (AES)** — correlator/analysis operator, software development.

4 Correlator Operations

4.1 *IVS Intensive for UT1–UTC*

Almost all of the weekend Intensive series (INT-2) were processed at the correlator automatically in near real-time using the *rapid_* programs (see Section 2.3). The number of sessions processed in 2021 and 2022 is listed in Table 2. Wettzell 20 m in Germany and the VLBA antenna at Mauna Kea in Hawaii, U.S., usually participated in the INT-2 sessions. Ishioka in Japan also joined while the S/X feed was installed. In addition, a few INT-3 sessions on Monday were processed at the correlator on behalf of the Bonn Correlator.

Table 2 Intensive sessions processed at the Tsukuba Correlator.

2021	Stations	# of sessions
Intensive 2	IsMkWz	12
	MkWz	46
	IsWz	15
	KkWz	17
Total		90
2022	Stations	# of sessions
Intensive 2	IsMkWz	35
	MkWz	62
	IsWz	3
Intensive 3	IsNsNyWnWz	1
	IsWz	1
Total		102

4.2 IVS AOV Sessions

The Asia-Oceania VLBI Group for Geodesy and Astrometry (AOV) is a regional subgroup of the IVS established in 2014 to foster and encourage closer collaboration in VLBI in the Asia-Oceania region. It has been coordinating regular VLBI observing sessions since 2015, and twelve sessions were organized per year in 2021 and 2022. Correlation tasks were shared by the Tsukuba VLBI Correlator, the Shanghai Correlator operated by the Shanghai Astronomical Observatory (SHAO), and the University of Tasmania. The sessions processed at the Tsukuba VLBI Correlator in 2021 and 2022 are listed in Table 3. Most of the data, not only from Japan, but also from China, Korea, Australia, and New Zealand, were transferred via the broadband network, while only the data of Syowa in Antarctica were shipped to Japan.

Table 3 AOV sessions processed at the Tsukuba Correlator.

Year	Name	Date	Stations
2021	AOV055	Jan 17	HbIsKgKmShSyVmWwYg
	AOV059	May 17	HbIsKeShSyVmWwYg
	AOV061	Jul 14	HbIsKeShSyVmWwYg
	AOV064	Oct 11	HbKeKgKmKvShVmWwYg
	AOV066	Dec 15	HbIsKeKgKmKvShVmWwYg
2022	AOV067	Jan 15	HbIsKgKmSyWwYg
	AOV071	May 30	HbIsKeKgKvVmWwYg
	AOV073	Jul 26	HbIsKeShYg
	AOV075	Sep 28	HbIsKeKgKmKvVmWwYg
	AOV077	Nov 22	HbIsKeKgVmWwYg

4.3 VGOS Intensives (VGOS-B and VGOS-C Sessions)

The correlator processed 73 sessions of the VGOS-B and VGOS-C series from the end of March 2022 to the beginning of October 2022. They were VGOS Intensives in which Ishioka and the Onsala twin telescopes participated. This was the first experience for the correlator to provide the VGOS products with the IVS community. At present, we processed all the processes of the correlation of VGOS Intensives manually. If some processes are handled automatically, the results will be provided more stably and quickly.

5 Outlook

We will continue to process the IVS S/X Intensives (mainly INT-2 sessions), AOV sessions, and VGOS Intensives. In addition to improving the existing programs for real-time processing and maintaining the hardware and network, we will develop some tools and programs to process VGOS Intensives automatically. With these developments, we will be able to provide results more stably and quickly.

References

1. Kondo, T., Y. Koyama, R. Ichikawa, M. Sekido, E. Kawai, and M. Kimura, "Development of the K5/VSSP System", *Journal of the Geodetic Society of Japan*, **54**(4), pages 233-248, 2008.
2. Bolotin, S., K. Baver, J. Gipson, D. Gordon, and D. MacMillan, "Transition to the vgosDb Format", *IVS 2016 General Meeting Proceedings*, NASA/CP-2016-219016, pages 222-224, 2016.
3. McCallum, L., L. C. Chuan, H. Krásná, J. McCallum, J. Böhm, T. McCarthy, J. Gruber, M. Schartner, J. Quick, and A. Rogers, "The Australian mixed-mode observing program", *Journal of Geodesy* **96**:67, 2022. <https://doi.org/10.1007/s00190-022-01657-2>
4. McCallum, J., L. McCallum, "An S/X Compatible VGOS System for the AuScope Array", *International VLBI Service for Geodesy and Astrometry 2018 General Meeting Proceedings*, pages 124–127, 2019.
5. Barrett, J., R. Cappallo, B. Corey, G. Crew, P. Elosegui, A. Niell, C. Rusczyk, and M. Titus, "VGOS Data Processing Manual". MIT Haystack Observatory, 2021. URL: <https://www.haystack.mit.edu/wp-content/uploads/2021/01/vgos-data-processing.pdf>

Vienna Correlator Report 2021–2022

Jakob Gruber¹, Frédéric Jaron¹, Leo Baldreich¹, Johannes Böhm¹

Abstract The Vienna Correlator is operated by the research unit Higher Geodesy of the Technische Universität Wien (TU Wien). The Vienna Scientific Cluster (VSC), a supercomputer located in Vienna, is used as a hardware component. A bandwidth of 10 GBit/s (shared by all VSC users), 480 compute cores, and 1 PByte memory for VLBI correlation are available. Three people are actively involved in VLBI correlation: J. Gruber, F. Jaron, and L. Baldreich. In 2021, seven out of a total of 27 (26%) VGOS-OPS sessions, and in 2022, 12 out of a total of 44 (27%) were correlated in Vienna. In the EU-VGOS project, sessions were observed, correlated, analyzed, and new software solutions were organized and developed.

1 General Information

The Vienna Correlator is operated by the research unit Higher Geodesy of the Technische Universität Wien (TU Wien). It became an official IVS Correlator Center in 2018. We correlate IVS VLBI sessions on an operational basis and for specific scientific projects. In particular, we contribute to the IVS by correlating the next-generation VLBI Global Observing System (VGOS) sessions. As a principal hardware component, we use a computer cluster called the Vienna Scientific Cluster-4¹ (VSC-4, see Figure 1). It is located 2.5 km

¹ Technische Universität Wien, Department für Geodäsie und Geoinformation, Wiedner Hauptstraße 8, 1040 Wien, Austria

VIEN Correlator

IVS 2021+2022 Biennial Report

¹ <https://vsc.ac.at/systems/vsc-4/>

away from our TU Wien offices and can be accessed remotely.

2 Component Description

For the correlation of VLBI Level-0 data, we use the supercomputer resources of the VSC. The high-performance cluster called VSC-4 was installed in the summer of 2019. In total, the VSC-4 consists of 790 nodes. At the research unit Higher Geodesy, we have exclusive access to ten of these nodes, which are reserved for projects related to VLBI correlation and are accessible anytime for the members of our VLBI group. In addition, 1 PByte of storage was purchased to complete the VLBI correlation's hardware system, given the enormous data volumes in the VGOS era.

2.1 VSC-4 Compute Cores and Storage

The VSC-4 is equipped with water-cooled Lenovo SD650 nodes, each with two Intel Skylake Platinum 8,173 processors with 24 cores, interconnected with 100 Gbit/s OmniPath. Each high-performance node reaches 2.7 PFlops/s and has a main memory of 96 GByte. For more information on the technical specifications of the VSC-4, please see <https://vsc.ac.at/systems/vsc-4/>.

By having access to ten of these nodes, we can utilize 480 cores for VLBI correlation. For data storage, a General Parallel File-System (GPFS) with 1 PByte is mounted to the VSC-4. This data volume is dedicated to VLBI correlation only within the VSC-4.

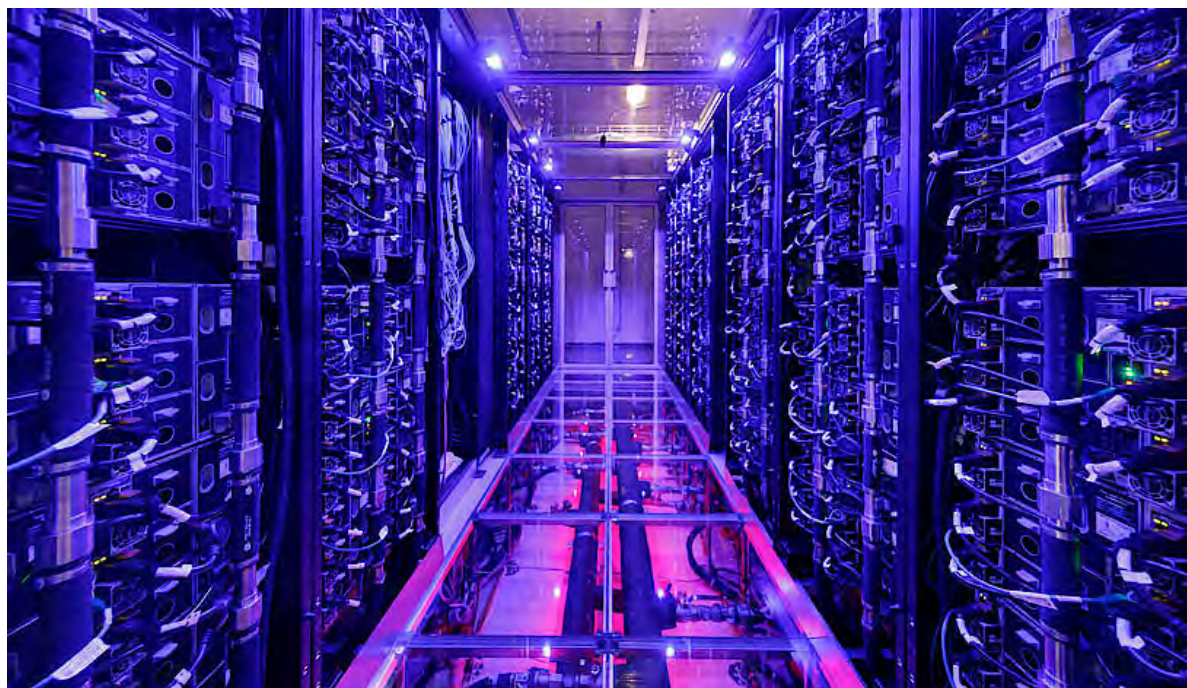

Fig. 1 VSC-4. Ten nodes and 1 PByte are reserved for VLBI correlation. Linked with 10 Gbps to the global research network GEANT. (©<http://derknopfdruecker.com/>)

2.2 Software Capabilities

For the electronic data transmission between VLBI stations and the Vienna correlator, we use the VLBI-specific e-transfer software `jive5ab`² and `etd/etc`³ developed by H. Verkouter. Additionally, the high-speed network e-transfer program `tsunami`⁴ is also installed on the VSC-4 login nodes and applied for operational Level-0 data transmission. The Distributed FX style correlation software (DiFX, [3]) is installed to realize Level-0 processing of the raw VLBI telescope data. While we continuously keep our DiFX installation up to date with the latest official releases, we also keep several older versions of DiFX to allow processing VGOS and legacy S/X observations. The Slurm⁵ workload management and job scheduling software is used to efficiently process the VLBI raw data by DiFX and

² <https://github.com/jive-vlbi/jive5ab>

³ <https://github.com/jive-vlbi/etransfer>

⁴ <https://sourceforge.net/projects/e-vlbi/files/tsunami.py/download>

⁵ <https://slurm.schedmd.com/documentation.html>

reach a high parallelization level. Besides DiFX, the Haystack Postprocessing System (HOPS), PIMA, Pol-Convert, and nuSolve are installed at the VSC-4 to complete the entire raw data VLBI processing chain. Consequently, it is possible to process raw VLBI data and provide `vgosDb` files to the IVS community.

2.3 e-Transfer Performance

The Vienna correlator is e-transfer-only. Hence, the reception of hard disks containing VLBI Level-0 data is not supported. The VSC-4 consists of ten login nodes linked to the GEANT network allowing a maximum data rate of 10 Gbit/s. The 10 Gbit/s bandwidth is shared between login nodes and other users of the VSC. Several performance tests show a limit of 1.5 Gbit/s for a single e-transfer stream [10]. The reason is unknown at the time of publication but represents an important topic for further investigation.

2.4 Correlation Performance

Slurm allows the parallelization of a single session, and several sessions can be processed in parallel. An investigation of the data throughput by DiFX on the VSC-4 showed excellent scaling with increasing the number of processing cores. For the correlation of a VGOS 24-hour session including up to nine telescopes, an optimal number of five nodes could be identified [10]. By using more than five nodes, the DiFX performance becomes data-limited rather than CPU-limited. Monitoring the total DiFX processing time of VGOS 24-hour sessions showed values between 21 and 24 hours [10]. The variation occurs due to varying Level-0 data amounts. The maximum data throughput achieved by using 480 cores was 320 Gbps.

3 Staff

Three people are involved in the work at the TU Wien IVS VLBI correlator. Their names and most important responsibilities are listed below. Additionally, Johannes Böhm is a responsible contact point for the VSC-4 team, and Axel Nothnagel acts as a consultant concerning correlation/fringe-fitting and raw data simulation.

- Jakob Gruber
 - Postdoc researcher
 - Maintenance of data transfer
 - VGOS correlation
 - Raw data simulation
 - Development of third-party software to support correlation and fringe-fitting and correlation of various other special VLBI sessions
- Frédéric Jaron
 - Postdoc researcher
 - Maintenance of data transfer
 - VGOS correlation
 - EU-VGOS correlation and organization
 - Special interest in source structure for VGOS
 - Development of third-party software to support correlation and fringe-fitting and correlation of various other special VLBI sessions

- Leo Balreich
 - Student Assistant
 - Maintenance of data transfer

4 Current Status and Activities

4.1 VGOS Correlation

The next-generation VGOS system became operational, beginning regular observing 24-hour sessions in 2020. The provision of high-quality VGOS raw data products by the Vienna VLBI correlator was examined in two comparison studies conducted by the VLBI group of the MIT Haystack Observatory in 2020. The verification showed that the Vienna VLBI correlator could provide high-quality products. As a result, the Vienna VLBI correlator became an operational IVS component for VGOS correlation in 2021. In total, there were 27 VGOS 24-hour sessions conducted this year. Seven were correlated by the Vienna VLBI correlator, eight by the Bonn correlator, six by the Washington correlator, four by the Shanghai correlator, and two by the MIT Haystack correlator. In this regard, the Vienna VLBI correlator contributed to a successful launch of operational VGOS with the correlation of 25% of all VGOS sessions in 2021 and 27% in 2022, respectively, making it an essential part of the global VGOS infrastructure.

4.2 EU-VGOS

The EU-VGOS project was initiated in 2019 with the aim of investigating methods for correlation and post-processing of VGOS data [1]. A recent description of the project's current status can be found in [2]. At the time of writing, EU-VGOS is a collaboration of about 50 individuals working at different institutes, mainly in Europe but also beyond. The project is structured into five Working Groups (WGs): 1) Management, 2) Operations, 3) e-Transfer, 4) Correlation, and 5) Analysis. Three of these WGs are led by employees of TU Wien: WGs 1 and 4 by Frédéric Jaron, and WG 3 by Jakob Gruber.

4.2.1 WG e-Transfer

The e-transfer of observational data from the stations to the correlator is still one of the most critical bottlenecks of the VGOS processing chain. It still takes significant time for the data to arrive at the correlator. Furthermore, data rates are often much below the expected values. For these reasons, the EU-VGOS collaboration established a dedicated WG for this topic. One quickly identified problem was that relatively small files (i.e., several GByte each) produce a significant overhead for e-transfer tools that significantly reduce the effective data rate. The etd/etc software overcomes this problem and can speed up the transfer. This is especially relevant when transferring multifile data. This was demonstrated in [4], where the transfer duration could be reduced from 18 down to 12 hours in one example.

4.2.2 WG Correlation

At the beginning of 2021, the correlation of VGOS data with the DiFX software correlator required several patches to be applied to the software. This quickly led to inconsistencies in the VGOS correlation software between the different Correlator Centers. This issue was discussed in the EU-VGOS Correlation meetings. As a result of these discussions, the DiFX version 2.5.4 was developed, tested by the larger DiFX user community, and eventually officially released.

The WG Correlation investigates the application of PolConvert [5, 6] to VGOS data. The main functionality of PolConvert is to convert the correlator output of linearly polarized data to circular polarization. But in order to do so, the software first estimates the complex cross-polarization gain differences between the two linear feeds of each antenna in terms of amplitude and phase. PolConvert thus offers a possibility to combine the data to Stokes I for fringe-fitting.

The session er2201 was observed in September 2022. The background of this session was that the source 4C 39.25 was identified as an ideal cross-polarization gain calibrator during the analysis of previous EU-VGOS sessions. The session was correlated at TU Wien (and also at MIT Haystack Observatory). At TU Wien, we are analyzing the data. Results so far have shown that the cross-bandpasses of the participating stations could be estimated with excellent quality, and it is possible to investigate

the time evolution of the cross-bandpasses over the six-hour duration of the session. We can already report that the principal shape of the bandpasses remains stable, but there is also perceivable variability. More details will be available in an upcoming publication.

4.3 Raw Data Simulation

As part of J. Gruber's dissertation, a novel tool for simulating VLBI raw data was developed [9]. The Vienna Raw Data Simulator (VieRDS) can be freely downloaded from Github⁶ and is available to the whole IVS community. VieRDS was successfully used to study the quality of the phase calibration signal as a function of injection power. In addition, we investigated how the characteristic station frequency response affects the signal-to-noise ratio of the observed quantity. In cooperation with H. Hase, the quality of the group delay was investigated using alternative frequency sequences [8]. In summary, VieRDS has proven to be very useful for studies of effects that cannot be simulated at the group delay level.

5 Future Plans

In the near future, we will continue to focus sharply on VGOS correlation and the organization of the EU-VGOS project. Specifically, we will correlate six VGOS-OPS sessions in 2023, with the optimization of correlation for more efficient processing of raw VLBI data as an important goal. In addition, we plan to work intensively on source structure effects for improved VGOS. The tool VieRDS developed by us will be used for this purpose.

Acknowledgements

The authors are grateful to the Austrian Science Fund (FWF) for supporting this work with the project P31625 (VGOS Squared). The computational results presented were achieved in part using the Vienna Scientific Cluster (VSC).

⁶ <https://github.com/TUW-VieVS/VieRDS>

References

1. Alef W., Anderson J. M., Bernhart S., de Vicente P., González García J., Haas R., La Porta L., et al. (2019) The EUropean-VGOS Project, *Proceedings of the 24th European VLBI Group for Geodesy and Astrometry Working Meeting, 17-19 March 2019, Las Palmas de Gran Canaria, Spain*, Eds. R. Haas, S. Garcia-Espada, and J. A. López Fernández, ISBN: 978-84-416-5634-5, pp. 107–111.
2. Albentosa E., Alef W., Bernhart S., Böhm J., Bolaño González R., Choi Y. K., Gansmoe T., et al. (2023) Current Status of the EU-VGOS Project, *International VLBI Service for Geodesy and Astrometry 2022 General Meeting Proceedings*, Eds. Kyla L. Armstrong, Dirk Behrend, Karen D. Baver, NASA/CP-20220018789, pp. 85–89.
3. Deller A. T., Brisken W. F., Phillips C. J., Morgan J., Alef W., Cappallo R., Middelberg E., et al., 2011, DiFX-2: A More Flexible, Efficient, Robust, and Powerful Software Correlator, *PASP*, 123, 275. doi:10.1086/658907
4. Jaron F., Bernhart S., Böhm J., González García J., Gruber J., Choi Y. K., Martí-Vidal I., et al. (2021) EU-VGOS activities in Vienna, *Proceedings of the 25th European VLBI Group for Geodesy and Astrometry Working Meeting, 14-18 March 2021 Cyberspace, Gothenburg, Sweden*, Ed. R. Haas, ISBN: 978-91-88041-41-8, pp. 19–23.
5. Martí-Vidal I., Roy A., Conway J., Zensus A. J. (2016) Calibration of mixed-polarization interferometric observations. Tools for the reduction of interferometric data from elements with linear and circular polarization receivers, *A&A*, 587, A143. doi:10.1051/0004-6361/201526063
6. Martí-Vidal I., Mus A., Janssen M., de Vicente P., González J. (2021) Polarization calibration techniques for the new-generation VLBI, *A&A*, 646, A52. doi:10.1051/0004-6361/202039527
7. J. Gruber, F. Jaron, A. Nothnagel, J. Böhm (2021) Vienna Correlation Center Biennial Report 2019/2020, *International VLBI Service for Geodesy and Astrometry 2019+2020 Biennial Report*, Edited by Dirk Behrend, Kyla L. Armstrong, and Karen D. Baver, NASA/TP-20210021389.
8. J. Gruber, J. Böhm, F. Jaron, A. Nothnagel (2021) Simulation of VGOS observations at the raw data level with VieRDS, *Proceedings of the 25th European VLBI Group for Geodesy and Astrometry Working Meeting, 14-18 March 2021 Cyberspace, Gothenburg, Sweden*, Ed. R. Haas, ISBN: 978-91-88041-41-8, pp. 28–33.
9. J. Gruber, J. Böhm, A. Nothnagel (2021) VieRDS: A Software to Simulate Raw Telescope Data for very Long Baseline Interferometry, *Publications of the Astronomical Society of the Pacific*, doi:10.1088/1538-3873/abeca4.
10. J. Gruber (2022) The Vienna VLBI Raw Data Simulator and Correlator in the VGOS Era, *Dissertation, Technische Universität Wien*.

Washington Correlator

David M. Hall, Sara Hardin

Abstract This report summarizes the activities of the Washington Correlator for the years 2021 and 2022. The Washington Correlator provides up to 60 hours of attended processing per week plus up to 60 hours of unattended operation, primarily supporting Earth Orientation and astrometric observations.

1 General Information

The Washington Correlator (WACO) is located at and staffed by the U. S. Naval Observatory (USNO) in Washington, DC, USA. The correlator is sponsored and funded by the National Earth Orientation Service (NEOS), which is a joint effort of the USNO and NASA. Dedicated to processing geodetic and astrometric VLBI observations, the facility spent 100 percent of its time on these sessions. All of the weekly IVS-R4 sessions, all of the IVS-INT1, and VGOS V2 Intensives, and a subset of the R&D, CRDS (southern hemisphere Celestial Reference Frame), and VGOS VO sessions were processed at WACO. The facility houses the WACO DiFX correlator.

2 Activities during the Past Years

- The Washington Correlator made the transition from the DiFX V1 correlator to the DiFX V2 software correlator, with plans in place to acquire

U. S. Naval Observatory

Washington Correlator

IVS 2021+2022 Biennial Report

and deploy the DiFX V3 (or VGOS) correlator. Work to achieve the final configuration of the correlator, its associated servers, and its network is ongoing.

- The correlator staff continues to support transfers by high-speed networks but was hampered by the long-delayed upgrade to the existing 2 Gb/s line.
- The VLBI division has taken on the task of studying the possibility of correlating in the cloud.
- The continued effort to upgrade and replace aged hardware and servers with newer, more capable ones with hot spares was largely completed, with virtually all single points of failure eliminated from the processing chain.
- Table 1 lists the IVS sessions processed during 2021–2022.

Table 1 2021–2022 sessions processed.

Type	Mode	Number processed
INT1	Legacy	483
R4	Legacy	102
CRDS	Legacy	9
V2	VGOS	294
VO	VGOS	16

3 Staff

The Washington Correlator is under the management and scientific direction of the Earth Orientation Department of the U. S. Naval Observatory. Staffing issues were persistent at WACO. In 2022 Andrew Sargent left

Table 2 Staff.

Staff	Duties
David Hall	Chief, VLBI Division
Mike Dutka	Programmer
Phillip Haftings	Astronomer
Sara Hardin	Astronomer
Bruce Thornton	Physical Science Technician
Roxanne Inniss	Media Librarian
Contractors	Company
Tim Dorman	CPI

the VLBI division for another position at USNO. Expedited efforts to hire a replacement and fill an additional position that has been approved are underway. An additional contractor, Tim Dorman, was added in 2021 to assist with the study and potential deployment of a cloud correlator.

4 Future Plans

A hardware refresh is planned for the next year and for the expansion of file storage space. Upgrading the high-speed Internet connection from 2 Gb/s to 10 Gb/s is also planned for the future.

Wettzell VLBI Correlator

C. Plötz¹, W. Probst¹, R. Wildenauer¹, M. Seegerer¹, B. Fischaleck¹, A. Neidhardt², T. Schüler¹

Abstract The correlation facility of the Geodetic Observatory Wettzell (GOW) in Germany has undergone a significant upgrade during the period of this report. An initial DiFX-based correlator was operated between 2016 and 2020 for the evaluation of local short-baseline interferometry measurements between the three VLBI radio telescopes of the GOW (Wz, Wn, and Ws) and VLBI experiments with the station AGGO (Ag). In December 2020 a new High Performance Cluster (HPC) based DiFX VLBI correlator was installed at the GOW, replacing the small, old, and obsolete hardware. In the subsequent months all necessary software was installed, and performance and verification tests were done. The new installation also offers the performance to properly handle VGOS observations. Since late 2021, the VLBI correlator at Wettzell has been acknowledged as an official IVS correlation component (WETZ), contributing to IVS correlation resources. A newly established IVS VGOS Intensive observation program between Wettzell and McDonald Geodetic Observatory (MGO) [1] was launched in December 2021 and correlated at Wettzell. Since December 2022, regular 24-hour VGOS sessions are scheduled for correlation at Wettzell.

1. Bundesamt für Kartographie und Geodäsie (BKG)

2. Forschungseinrichtung Satellitengeodäsie (FESG), Technische Universität München

Wettzell Correlator

IVS 2021+2022 Biennial Report

1 General Information

The hardware topology was specified as a High Performance Cluster (HPC) configuration. There are three head nodes (one of them acts for data transfers) and 24 compute nodes available. An Infiniband bus system interconnects all related hardware units. The complete system is illustrated as a block diagram in Figure 1. The HPC-cluster has a storage capacity of 834 TB. Additionally, a Mark 6 unit is available for correlator usage. A dual-UPS protects against power failures. The internet line capacity is 5 Gbps, but the usable data rate for VLBI e-transfer is 4 Gbps for up- and downloading VLBI raw data.

Linux CentOS 7 is the operating system for the HPC-Cluster, and the IT automation software Ansible is the software tool for provisioning, configuration management, and application deployment. DiFX [2] is used as the software correlation application, and the Haystack Observatory Postprocessing System (HOPS) is used for the subsequent fringe-fitting process. In order to manage different users and configurations for all correlation duties, the workload manager SLURM (Simple Linux Utility for Resource Management) and the Environment Modules package (<https://modules.sourceforge.net/>) were introduced. Two basic configuration sets are mainly used, one for VGOS correlation (DiFX version 2.5.4, HOPS 3.23) and another for legacy S/X correlation (DiFX 2.6.3, HOPS 3.23).

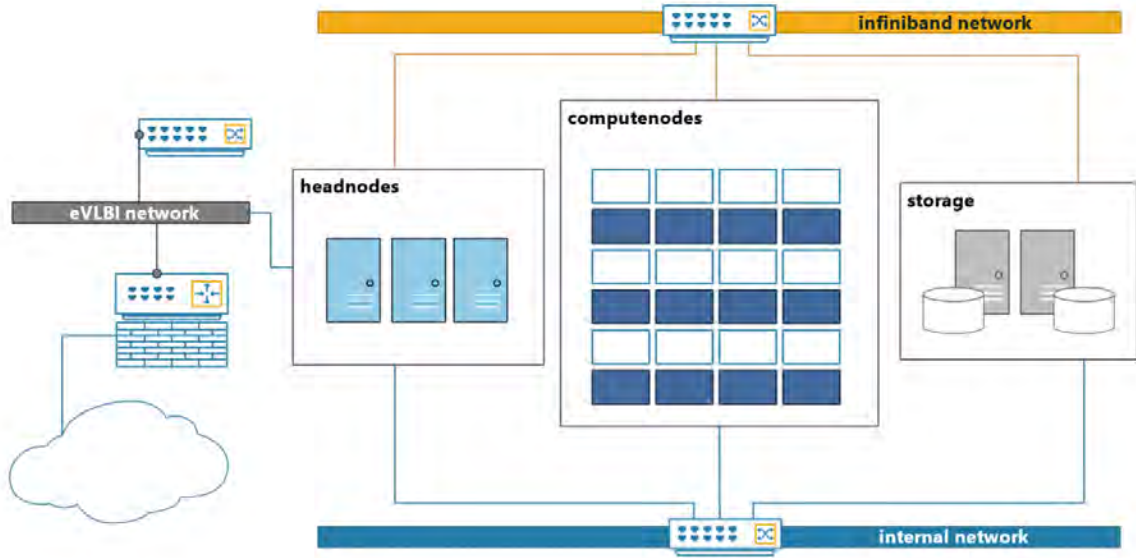

Fig. 1 Block diagram of the Wetzell VLBI Correlator HPC-cluster.

2 Activities during the Past Years 2021–2022

Within the report time period, a VGOS Intensive observation program was assigned to the Wetzell correlator. The IVS VGOS Intensive series between McDonald (Mg), located in Texas/U.S. and Wetzell (Ws) in Germany is observed on Tuesdays at 19:45 UT with a duration of one hour. After the regular VGOS Intensive session finishes, a short dedicated session is appended, which normally takes ten minutes. The purpose is to collect further insights in correlation, source, and slewing characterization of the involved radio telescopes. The raw data of the Wetzell network station are al-

ready onsite and thus are available almost instantly for correlation. Due to recent upgrades of the internet capability of Mg, its raw data are available at the following day in the morning (Wetzell time), and the correlation process can be started. This VGOS Intensive series started on December 7, 2021 with its first session. To date, there are 28 sessions completed. The workflow of scheduling, observing, correlation, and data analysis performs well. The session VO2336 scheduled in December 2022 was the first regular 24-hour session to be correlated by the VLBI correlator at Wetzell. In addition to processing the assigned IVS sessions, the new correlator at the GOW took over the duties of the old correlator.

Table 1 Staff members.

Name	Affiliation	Function	Mainly working for
Torben Schüler	BKG	head of the GOW	GOW
Christian Plötz	BKG	head of VLBI, correlator	RTW, TTW, correlator
Willi Probst	BKG	physicist	correlator
Michael Seegerer	BKG	IT engineer	correlator
Robert Wildenauer	BKG	IT engineer	correlator
Ben Fischaleck	BKG	IT administrator	IT administration
Alexander Neidhardt	FESG TUM	head of the group for microwave techniques, chief of operations group	RTW, TTW

3 Staff

The members of staff for VLBI correlation are summarized in Table 1.

4 Current Status

In December 2021 regular operations as an official IVS component started at the VLBI correlator in

Wetzell. The IVS sessions S2 and S2a were assigned to the Wetzell VLBI correlator in the time period between 2021 and 2022 and will be continued in the future. A main focus during the last year was the development of an automatic VGOS Intensive correlation workflow. Despite making good progress on that project, it couldn't be implemented to work on an operational basis until the end of 2022. The configuration and setup management of the HPC-based VLBI correlator is done with the common and well-established software tool-chains of Ansible and SLURM. The general design of the VLBI correlator hardware enables scalability, as it will be needed for future enhancements of the correlation resources. Recently, the processing of 24-hour VGOS network sessions began.

5 Future Plans

The current Internet bandwidth is 5 Gbps. An upgrade of the existing Internet bandwidth to 10 Gbps is planned, along with an adequate extension of compute nodes. The development of automatized correlation of

VGOS Intensive sessions will be continued in order to reach an operational level. The first regular 24-hour VGOS session to be correlated at Wetzell took place in December 2022. Thus, the routine handling of 24-hour VGOS sessions must be implemented for the upcoming sessions. A storage extension of 2 PB is also planned in the near future to have the necessary capacity to process regular 24-hour VGOS sessions.

References

1. M. Schartner, L. Petrov, C. Plötz, et al. VGOS VLBI Intensives between MACGO12M and WETZ12M for the rapid determination of UT1-UTC. *REFAG2022 proceedings*, (submitted to IAGS).
2. A. T. Deller, W. F. Brisken, C. J. Phillips, J. Morgan, W. Alef, R. Cappallo, E. Middelberg, J. D. Romney, H. Rottmann, S. J. Tingay, R. Wayth. DiFX-2: A More Flexible, Efficient, Robust, and Powerful Software Correlator, *PASP*, 2011, 123, 275–287.

DATA CENTERS



BKG Data Center

Anastasiia Walenta, Markus Goltz

Abstract In 2021–2022 we supported as-identical-as-possible data handling in the triad of the primary IVS Data Centers. We employ the same validation procedures and data definition files (DDFs) to accept new data as well as to keep the old data. As the storage demands of new VLBI data types, i.e. vgosDb and corresponding VGOS station log files and Level 1 data files in Swinburne format (also referred to as SWIN files), grow quickly, we address this issue by allocating disk space. Due to security reasons, the access to our server has been restricted. The File Transfer Protocol (FTP) over Secure Socket Layer (SSL) and the Hypertext Transfer Protocol Secure (HTTPS) were set up for all our users in the middle of 2022. In addition to the service for IVS, the BKG Data Center provides an exchange server for projects of relatively small disk space demands: PWLO and EU-VGOS. These projects are powered by the same ingest procedures which we have in place for the IVS. Thus, an IVS-like structure is arranged. As follows, the projects can be integrated into the official IVS structure, if it will be desired in the future. The projects are fully independent at the same time, which lets us test different data handling procedures.

1 General Information

The BKG Data Center (BKG DC) is hosted by the German Federal Agency for Cartography and Geodesy

Federal Agency for Cartography and Geodesy (BKG)

BKG Data Center

IVS 2021+2022 Biennial Report

(BKG) as one of the three primary IVS Data Centers on terms as defined by the International VLBI Service for Geodesy and Astrometry (IVS).

According to the IVS regulations we are responsible for accepting the recognized VLBI data from all IVS components—other Data Centers, Operation Centers, Network Stations, Correlators, Analysis Centers, and Combination Centers—and provide them in open access. At this time, access to our server is restricted to File Transfer Protocol (FTP) over Secure Socket Layer (SSL) and Hypertext Transfer Protocol Secure (HTTPS). The principle of the open access is empowered by anonymous downloads over both protocols. The IVS users are offered to receive an account as described at our web page (<https://ivs.bkg.bund.de/>) to upload data. To achieve a data set which is identical with the data sets of the other official IVS DCs, the mirror procedures are set up.

2 Data Center at BKG

The BKG Data Center works together with CDDIS and OPAR representatives to support the proper data ingest among the official IVS DCs [2]. In this report we highlight the major items in the operations of the BKG DC in the last two years.

- **Establishing common validation procedures, before August 2021**

The internal BKG DC structure was re-organized significantly: the development and production servers are arranged on the new machines instead of the old server. The internal testing of the ingest script was carried out on the development server for the entire data set, so that many issues could

be addressed without disturbing the Data Center routines. The work on the ingest script was finalized by establishing the script as the main routine to accept data. The common validation procedures are shared via GitHub. The DDFs are maintained by the IVS Coordinator.

- **After the switch, August 2021**

The received data has been recognized according to the Name Convention since August 2, 2021. As follows, many routinely uploaded data were moved to the designated directory ‘unknown’ for the files rejected by these procedures at the BKG DC. In some cases the validation routines had to be adjusted. In the other cases, our team was in personal contact with the users who submit the data and products as a part of an operational service to fix the issues.

- **Level 1 data, 2022**

The raw VLBI observations are referred to as Level 0 data; then these data are correlated, producing visibilities called Level 1 data. In the IVS community these data are distributed with the so-called SWIN files, short for Swinburne format to acknowledge Swinburne University of Technology, where the DiFX correlator was developed and SWIN files were created initially. The applications of the incomparably more descriptive than the VLBI group delays (vgosDb) SWIN files are expected to be exploited far beyond the geodetic IVS community. Notwithstanding the large size of the files, which exceeds extensively any other data type at the IVS DCs, the SWIN files are validated with the ingest script as any other data type. The only difference with respect to other data types is that the SWIN files are received in a separate incoming area, where a separate anti-virus check is performed because of the file size. We have established the contact to receive SWIN files from the correlator in Shanghai. SWIN files are also mirrored from CDDIS, which completes the list of all available Level 1 data at the BKG DC.

- **EU-VGOS and PWLO projects, 2021–2022**

The requirements of both projects, i.e., EU-VGOS and PWLO ([1] and [5]), were met successfully as reported at the IVS 2022 General Meeting [4]. We have faced several technical problems, the solution of which helped us to support the IVS DC in the transition from FTP to the secure protocols. The work on the projects has helped us to understand better the validation procedures of the ingest script.

- **FTP over SSL and HTTPS, Summer 2022**

The IVS users were informed about our ultimate decision to discontinue the unsecured FTP access. The ivsincoming user was told to support the transitions, so that users in a first step would adjust their routines to access with FTP over SSL. And in a following step, users were offered to obtain an account at the BKG DC in order to download and upload data according to the new procedures. The data download is also possible with HTTPS (path to the BKG DC root directory: https://ivs.bkg.bund.de/data_dir/vlbi/).

- **Renewal of the website, Summer 2022**

The BKG DC has an old website with some general information about our Analysis and Data Center team and their main tasks. The website has since been updated significantly (<https://ivs.bkg.bund.de/>). The current team members and activities of our two IVS Components, i.e., Analysis and Data Centers, are presented for historical reasons, as they belong to the same section G1 at BKG and work closely together. A brief description of the Combination Center, the third IVS component operated within section G1 at BKG, is given for the time being while the corresponding website is under maintenance. The BKG DC exercises the ability to make public the regulations on how to access and upload the data at our Data Center. The graphical representation of the user access statistics (Figure 1) is posted on a daily basis. The effect of switching to the secure protocols can be seen for uploads as well as for downloads. The amount of downloads dropped at first, but after a while, an approximately previous level through the sum of FTPS and HTTPS downloads was reached.

- **Dealing with an upload of a new complete solution (SINEX files) to the Data Center, 2021–2022**

A complete VLBI solution of Intensives or 24-hour sessions includes about 7,600 and 6,000 files, respectively. If it is uploaded all at once, it might look like a DDoS attack. Then the ingest script will attempt to ingest the massive amount of files, which will put the operational uploads of the other users on “pause” due to the absence of a prioritized selection. Moreover, many files of the new solution might be rejected and moved to the unknown area. The files need to be managed manually in the unknown directory while the incorrect file names

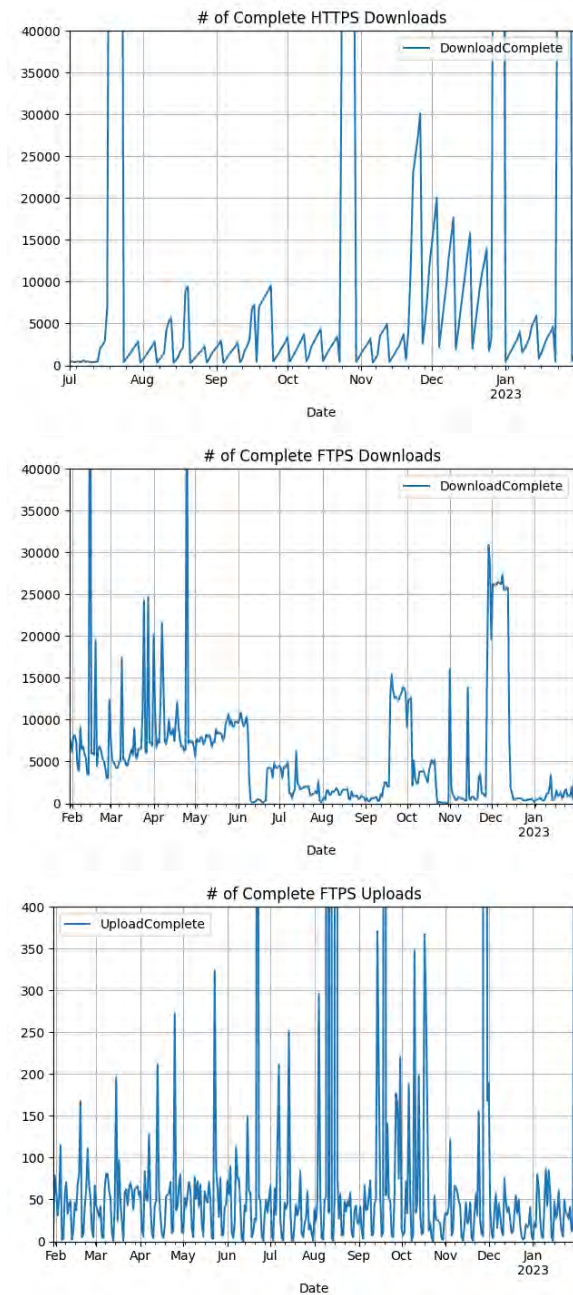

Fig. 1 User activity statistics (from top to bottom) represent the number (#) of successful downloads using HTTPS and FTPS respectively and the number of uploads via FTPS client.

are considered generally as exceptions. Multiple USNO submissions to the Data Centers have triggered CDDIS and BKG feedback, based on which the USNO group has made the exceptional effort

to facilitate the Data Centers' work. The key to the solution of a considerable data uploading is to split the files in chunks and upload them irregularly in time during a few hours. This issue might become more important, when, for instance, the switch to ITRF2020 will be effective: every AC will deliver new solutions and increase vastly the amount of incoming data.

- **Master file format version 2 and EOP 3.0 format, the very end of 2022**

The validation procedures of the ingest script as well as the script itself were adjusted to the requirements of the master file format 2 and EOP 3.0 format. In particular, the internal ingest database was modified. At this moment the EOP-I and EOP-S files in EOP 3.0 format are received by BKG DC for test purposes.

3 Personnel

- Markus Goltz:
[markus.goltz@bkg.bund.de]
- Anastasiia Walenta:
[anastasiia.walenta@bkg.bund.de]

Both team members are involved in the regular representative meetings of the official IVS Data Centers. Markus Goltz is engaged mainly in the technical Data Center support: maintenance of the server including close work with BKG internal IT support, documentation of the internal procedures, ingest support, graphical presentation of the data statistics, and web-site support. Anastasiia Walenta mainly covers the ingest support: check-ups, special cases, ingest of the new data formats, and internal documentation.

We support our users and every IVS member who wants to work with us. The BKG DC Team can be reached by writing to our mailbox: vlbi@bkg.bund.de.

4 Future Plans

For the next two years we intend to focus on covering some remaining flows in the Data Center ingest procedures. The main concern is aimed at the proper ingesting of vgosDb. Also, we will work on turning our services to being more user-oriented and user-friendly,

specifically: establishing an automatic feedback, a development of appropriate web services, and data uploading via HTTPS. We expect to increase gradually the Data Center disk space to meet VLBI Level 1 data requirements. As the Data Center efforts are significantly higher to support SWIN files, the number of users and the cadence of their access to these data will be considered, to advocate the further support of these data at the Data Center.

References

1. E. Albentosa, F. Jaron, et al., Current Status of the EU-VGOS Project, IVS 2022 General Meeting Proceedings, edited by Kyla L. Armstrong, Dirk Behrend, and Karen D. Baver, NASA/CP-20220018789, 2023.
2. D. Behrend, M. Bérubé, J. Gipson, A. Girdiuk, M. Goltz, T. Yates, P. Michael, C. Barache, Data Ingest at the IVS Data Centers, IVS 2022 General Meeting oral presentation, Finnish Cyberspace, 2022. https://space-geodesy.nasa.gov/docs/2022/GM2022_behrend_ingest.pdf
3. D. Behrend, Data Center file conventions, https://ivscc.bkg.bund.de/products-data/DataCenter_File_Conventions.pdf
4. A. Girdiuk, M. Goltz, D. Thaller, IVS Data Center at BKG, IVS 2022 General Meeting Proceedings, edited by Kyla L. Armstrong, Dirk Behrend, and Karen D. Baver, NASA/CP-20220018789, 2023.
5. A. Nothnagel, S. Böhm, R. Dach, M. Glomsda, H. Hellmers, A.-S. Kirkvik, T. Nilsson, A. Girdiuk, D. Thaller, First results of project on six-hourly EOP piecewise linear offset parameterization, IVS 2022 General Meeting Proceedings, edited by Kyla L. Armstrong, Dirk Behrend, and Karen D. Baver, NASA/CP-20220018789, 2023.

CDDIS Data Center Report for 2021–2022

Patrick Michael, Taylor Yates

Abstract This report summarizes activities during the years 2021 through 2022 and the future plans of the Crustal Dynamics Data Information System (CDDIS) with respect to the International VLBI Service for Geodesy and Astrometry (IVS). Included in this report are background information about the CDDIS, the computer architecture, archive contents, and future plans for the CDDIS within the IVS.

1 General Information

The Crustal Dynamics Data Information System (CDDIS) has supported the archiving and distribution of Very Long Baseline Interferometry (VLBI) data since its inception in 1982. The CDDIS is a central facility that provides users access to data and derived products to facilitate scientific investigation. The full CDDIS archive of GNSS (GPS, GLONASS, Galileo, etc.), laser ranging, VLBI, and DORIS data is available online for remote access. Information about the system is available via the web at the URL <https://cddis.nasa.gov>. In addition to the IVS, the CDDIS actively supports other IAG services including the International GNSS Service (IGS), the International Laser Ranging Service (ILRS), and the International DORIS Service (IDS), as well as the International Earth Rotation and Reference Systems Service (IERS), and the IAG's observing system, the Global Geodetic Observ-

ing System (GGOS). The current and future plans for the CDDIS support of the IVS are discussed below.

The CDDIS is one of NASA's Earth Observing System Data and Information System (EOSDIS) Distributed Active Archive Centers (DAACs) (see <https://earthdata.nasa.gov>); EOSDIS Data Centers serve a diverse user community and are tasked to provide facilities to search for and access science data and products. The CDDIS is also a regular member of the International Science Council (ISC) World Data System (WDS, <https://www.worlddatasystem.org>) and the Earth Science Information Partners (ESIP, <https://www.esipfed.org>).

2 System Description

The CDDIS archive of VLBI data and products is accessible to the public through encrypted ftp at [gdc.cddis.eosdis.nasa.gov](ftp://gdc.cddis.eosdis.nasa.gov) and https at <https://cddis.nasa.gov/archive>. Anonymous ftp access was deprecated in November 2020.

2.1 File Submissions

The CDDIS utilizes an https-based protocol method for the delivery of files from suppliers of data and products. The validation is performed through the EOSDIS Earthdata Login system, the same system used for access to the CDDIS real-time caster. The file uploads can be performed through a webpage interface

NASA Goddard Space Flight Center

CDDIS Data Center

IVS 2021+2022 Biennial Report

Table 1 IVS data and product directory structure.

Directory	Description
Data Directories	
vlbi/ivsdata/db/yyyy	VLBI database files for year yyyy
vlbi/ivsdata/ngs/yyyy	VLBI data files in NGS card image format for year yyyy
vlbi/ivsdata/vgosdb/yyyy	VLBI data files in vgosDB format for year yyyy
vlbi/ivsdata/aux/yyyy/sssss	Auxiliary files for year yyyy and session ssssss These files include log files, wx files, cable files, schedule files, correlator notes.
vlbi/ivsdata/swin/yyyy	VLBI SWIN files for year yyyy
Product Directories	
vlbi/ivsproducts/crf	CRF solutions
vlbi/ivsproducts/eopi	EOP-I solutions
vlbi/ivsproducts/eops	EOP-S solutions
vlbi/ivsproducts/daily_sinex	Daily SINEX solutions
vlbi/ivsproducts/int_sinex	Intensive SINEX solutions
vlbi/ivsproducts/trf	TRF solutions
vlbi/ivsproducts/trop	Troposphere solutions
Project Directories	
vlbi/ITRF2013	IVS contributions to the ITRF 2013 efforts
vlbi/ITRF2014	IVS contributions to the ITRF 2014 solution
vlbi/ivs-pilotbl	IVS Analysis Center pilot project (baseline)
Other Directories	
vlbi/ivscontrol	IVS control files (Master Schedule, etc.)
vlbi/ivsdocuments	IVS document files (solution descriptions, etc.)
vlbi/raw	Raw VLBI data
vlbi/ivsformats	IVS File Format Definitions

or a command line application that can perform an http “post” operation, which is more commonly used for scripting. This process allows data suppliers to authenticate through the Earthdata Login system and provide their files through https to CDDIS for ingest into the archive. More information on the CDDIS file upload system, including an FAQ, is available at URL: https://cddis.nasa.gov/About/CDDIS_File_Upload_Documentation.html.

2.2 File Ingest Processing

Starting in 2018, the CDDIS worked with the GSFC VLBI staff to transition code for processing incoming VLBI-related files into a new, common file ingest software. This new common ingest software would be shared with the other IVS global Data Centers to ensure that a common quality control (QC) and metadata process was shared across the global Data Centers. In late 2020, CDDIS moved its entire VLBI ingest process to this new collaborative process. Several changes were made to enable more rapid acceptance of new

data/product files by the incorporation of data definition files (DDFs). These DDFs are unique to each file type and specify a range of QC and metadata requirements for each file type. This, in turn, is parsed by the ingest software to determine the QC and metadata actions to accomplish for each incoming file before acceptance into the archive.

3 Archive Contents

The CDDIS has supported GSFC VLBI and IVS archiving requirements since 1979 and 1999, respectively. The IVS Data Center content and structure is shown in Table 1 (a figure illustrating the flow of information, data, and products between the various IVS components was presented in the CDDIS submission to the IVS 2000 Annual Report). As described above, the CDDIS has established a file upload system for providing IVS data, product, and information files to the archive. Using specified filenames, Operation and Analysis Centers upload files to this system. Automated archiving routines peruse the directories

and move any new data to the appropriate public disk area. These routines migrate the data based on the file-name DDFs to the appropriate directory as described in Table 1. Software on the CDDIS host computer, as well as all other IVS Data Centers, facilitates equalization of data and product holdings among these Data Centers by placing all new received data/products into a RECENTS directory for action by the other Data Centers. The performance of mirroring was scheduled to begin again between the IVS Data Centers located at the CDDIS, the Bundesamt für Kartographie und Geodäsie in Leipzig, and the Observatoire de Paris in late June 2021, and mirroring is now being performed.

The public file system in Table 1 on the CDDIS computer consists of a data area, which includes auxiliary files (e.g., experiment schedule information and session logs) and VLBI data (in the database, NGS card image, and new vgosDB formats). A products disk area was also established to house analysis products from the individual IVS Analysis Centers as well as the official combined IVS products. A documents disk area contains format, software, and other descriptive files.

4 Significant New Data Sets

CDDIS in late 2019 began to work with GSFC VLBI staff to archive the VLBI Level 1 correlator output files (SWIN). Because these files were previously only housed at each individual correlator, there was a significant risk that data files could be lost. Therefore, CDDIS working with the IVS created a request for NASA HQ to fund the expansion of CDDIS operations to perform quality control on this data set and archive it. In the summer of 2020, hardware was procured and installed, and by late 2020, most of the QC and ingest software had been developed. CDDIS began accepting these data in March 2021. The archiving of this data set has been slower than expected with several correlators still not pushing their full dataset collection to CDDIS.

5 Accessing the CDDIS Archive

The CDDIS has a large international user community; over 530k unique hosts accessed the system in 2022. Today, users access the CDDIS archive through any-

mous encrypted ftp and https. As per U.S. Government and NASA directives, the CDDIS moved users away from reliance on anonymous ftp and terminated all unencrypted ftp on 1 November 2020. The CDDIS has configured servers to utilize protocols that allow two new methods for system access: https (browser and command line) and ftp-ssl (command line). The https protocol is as efficient as ftp transfer and is without the firewall/router issues of ftp. The access to the CDDIS archive through both methods continues to present the same directory structure as the old, unencrypted ftp. Archive access through the https protocol utilizes the same NASA single sign-on system, the EOSDIS Earthdata Login utility, as is used for the file upload. Before using the https protocol to access the CDDIS archive, new users must initially access the webpage <https://cddis.nasa.gov/archive> to establish an account and authorize access; this page will then redirect the user to the Earthdata Login page. Earthdata Login allows users to easily search and access the full breadth of all twelve EOSDIS DAAC archives. Earthdata Login also allows CDDIS staff to know our users better, which will then allow us to improve CDDIS capabilities. Once an account is established, the user has all permissions required to access the CDDIS archive using the https protocol, via a web browser or via a command line interface (e.g., through cURL or Wget) to script and automate file retrieval. In addition, ftp-ssl access, an extension of ftp using TLS (transport layer security), can be used for scripting downloads from the CDDIS archive. The ftp-ssl is the option most similar to standard unencrypted anonymous ftp. As with https, ftp-ssl will satisfy U.S. Government/NASA requirements for encryption. Examples on using these protocols, including help with the cURL and Wget commands, are available on the CDDIS website; users are encouraged to consult the available documentation at https://cddis.nasa.gov/About/CDDIS_File_Download_Documentation.html as well as various presentations on these updates to the CDDIS archive access (see Section 7 below and <https://cddis.nasa.gov/Publications/Presentations.html>).

6 System Usage

During the 2021–2022 time period, over 11,000 distinct users accessed the CDDIS to retrieve VLBI-related files. These users, which include other IVS Data Centers, downloaded over 27.4 Tbytes (9.0 M files) of VLBI-related files from the CDDIS in this two-year period.

7 Future Plans

The CDDIS staff will continue to work closely with the IVS Coordinating Center staff to ensure that our system is an active and successful participant in the IVS archiving effort. A major area of focus will be the continued modifications to the CDDIS ingest processing software to accommodate all incoming VLBI-related files.

The staff is also testing providing a WebDAV (Web Distributed Authoring and Versioning) interface to provide another method for accessing the CDDIS archive. If feasible for CDDIS, this interface method would allow users to securely connect to the CDDIS archive as if it were a local drive on their computer.

The CDDIS has established Digital Object Identifiers (DOIs) for several of its collections of GNSS, SLR, and DORIS data and products; website landing pages have been established, linking to these published DOIs. DOIs for additional items, including VLBI data and products, are under development and review prior to registering and implementation.

Italy INAF Data Center Report

Monia Negusini

Abstract This report summarizes the activities of the Italian INAF VLBI Data Center. Our Data Center is located in Bologna, Italy, and belongs to the Institute of Radioastronomy, which is part of the National Institute of Astrophysics.

1 Introduction

The main INAF analysis activity and storage is concentrated in Bologna, where we store and analyze single databases, using Calc/Solve and the newer vSolve software.

The Institute of Radioastronomy (IRA) began storing geodetic VLBI databases in 1989; at the very beginning, the databases archived in Bologna mostly contained data including European antennas from 1987 onward. In particular, most of the databases available here had VLBI data with at least three European stations. Additionally we stored all the databases with the Ny-Ålesund antenna observations. In 2002 we decided to store the complete set of databases available to the IVS Data Centers, although we limited the time span to the observations performed from 1999 onwards. All the databases were processed and saved with the best selection of parameters for the final arc solutions. In order to perform global solutions, we have computed and stored the superfiles for all the databases.

Istituto di Radioastronomia INAF, Bologna

INAF Data Center

IVS 2021+2022 Biennial Report

Moreover, some Italian VLBI (VITA) experiments were performed in the last years and the relevant databases are available.

2 Computer Availability and Routing Access

We currently have two Linux workstations to which all VLBI data sets were migrated. One computer, on which the latest release of the Mark 5 Calc/Solve is installed, has the Internet address `geovlbi.ira.inaf.it`. The vSolve software is installed on a more recent Linux workstation and its Internet address is `antartide.ira.inaf.it`. Since 2016, a new server with a storage capacity of 11 TB has been available, and, therefore, all experiments performed in the previous years were downloaded and archived, thus completing the catalog. After the transition from the MK3-database to the vgosDB format, a new directory has been set up. All databases already analyzed were converted to the new format. At present, the MK3-databases are stored in the following directories:

- 1 = `/iranet/geo/dbase1`
- 2 = `/iranet/geo/dbase2`
- 3 = `/iranet/geo/dbase`
- 4 = `/iranet/geo/dbase3`
- 5 = `/iranet/geo/dbase4`

VgosDB databases are stored in: `/iranet/geo/vgosDb`.

The superfiles are stored in: `/iranet/geo/super.c11`.

The list of superfiles is stored in the file `/iranet/geo/solve/mk5/save_files/SUPCAT`.

The username for accessing the databases is `geo`. The password may be requested by sending an e-mail to `negusini@ira.inaf.it`.

Paris Observatory (OPAR) Data Center

C. Barache, T. Carlucci, S. Lambert

Abstract This report summarizes the OPAR Data Center activities in 2021–2022. Included is information about functions, architecture, status, future plans, and staff members of the OPAR Data Center.

1 General Information

The Paris Observatory (OPAR) has been hosting a primary Data Center for the International VLBI Service for Geodesy and Astrometry (IVS) since 1999. The OPAR is one of the three IVS Primary Data Centers, along with BKG and CDDIS. Their activities are done in close collaboration for collecting files (data and analysis files) and making them available to the community as soon as they are submitted. The three Data Centers have a common protocol and each of them:

- has the same directory structure (with the same control file),
- has the same script,
- is able to receive all IVS files (auxiliary, database, products, documents),
- mirrors the other ones every three hours, and
- gives free FTP access to the files.

This protocol gives the IVS community transparent access to a Data Center through the same directory, as well as a permanent access to files in case of a Data Center breakdown (see Figure 1). The mirroring be-

SYRTE, Observatoire de Paris - Université PSL, CNRS, Sorbonne Université, LNE

OPAR Data Center

IVS 2021+2022 Biennial Report

tween OPAR and CDDIS has been made with the new secured LFTP SSL since October 2020.

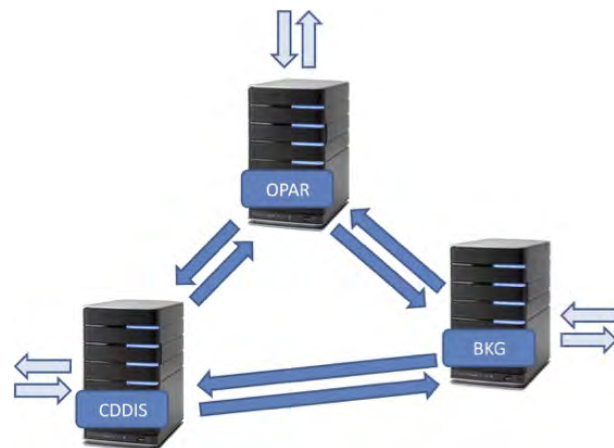

Fig. 1 The three Data Centers: dark blue arrows indicate the mirroring between them while the light blue arrows indicate the input and output data from other IVS components such as Analysis Centers or users outside the IVS.

2 Architecture

To be able to put a file in a Data Center, Operation and Analysis Centers have to be registered with the IVS Coordinating Center. The file names have to conform to the naming conventions. A script checks the file and puts it in the right directory. The uploading protocol to submit files to the `ivsincoming` directory of `ivsoapar` assumes that `cURL` is set up on the client. For Windows users, `cURL` versions exist. You can, e.g., search for a

version compatible with your version of Windows in <https://curl.haxx.se/download.html>.

Here is the submission protocol in use since 2017. The user is provided by us with a script named `submitopar`, for instance. To make the script active, the user has to replace the relevant two lines by the login and password that will be provided by us.

For UNIX-like system users, the following command submits files `xxxyyyyz.eops` and `xxxyyyyz.eops.eops.txt` to the Data Center (actually pushes them to `ivsincoming`):

```
submitopar -upload xxxyyyyz.eops
            xxxyyyyz.eops.txt
```

To list the files that are currently present in the `ivsincoming` directory:

```
submitopar -display
```

For Windows users, the cURL command line is

```
curl.exe -k -u LOGIN:PASSWD -F
"ichier=@"FILENAME -F
"mode=upload"
https://ivsoapar.obspm.fr/upload/
```

where `LOGIN` and `PASSWD` should be replaced by the provided login and password, and `FILENAME` is the name of the file the user wants to upload. Note that there is NO SPACE between '@' and the "" (double quotes) sign before `FILENAME`. One can also submit files directly via a Web browser at the address <https://ivsoapar.obspm.fr/upload/>. The script undergoes permanent improvement and takes into account the IVS components' requests.

The structure of IVS Data Centers is as follows:

- `RECENT\` is used for the new mirror method,
- `ivscntrol\` provides the control files needed by the Data Center (session code, station code, solution code...),
- `ivsddocuments\` provides documents about IVS products,
- `ivsddata\` provides files related to the observations,
- `ivsddata\aux\` provides auxiliary files (schedule, master, log...),
- `ivsddata\db\` contains observation files in database CALC format,
- `ivsddata\vgosdb\` contains observation files in database VGOS format,

- `ivsddata\ngs\` contains observation files in NGS format,
- `ivsddata\sinex\` contains observation files in SINEX format,
- `ivproducts\` provides results from Analysis Centers,
- `ivproducts\eopi\` provides Earth Orientation Parameter results from Intensive sessions,
- `ivproducts\eops\` provides Earth Orientation Parameter results from 24-hour sessions,
- `ivproducts\crf\` provides Celestial Reference Frame results,
- `ivproducts\trf\` provides Terrestrial Reference Frame results,
- `ivproducts\daily_sinex\` gives solutions in SINEX format of Earth Orientation Parameters and site positions, mainly designed for combination,
- `ivproducts\int_sinex\` gives daily Intensive solutions in SINEX format, mainly designed for combination, and
- `ivproducts\trop\` contains tropospheric time series (starting July 2003).

3 Current Status

The OPAR Data Center has been operated actually on a PC server with a Debian 10 Linux operating system since October 2020 and is located at Paris Observatory. To make all IVS products available on-line, the disk storage capacity has been significantly increased to 500 Go. The OPAR server is accessible 24 hours per day, seven days per week through a 2 MBit/s Internet connection. Users can get the IVS products by using the new secured FTP protocol. Access to this server is free for users.

In August 2021, OPAR changed its validation scripts. We now use new common data ingest scripts written in python and developed by the BKG and CDDIS Data Centers. The new software is modular and replaces the original `ivsincoming2ivs` script. It contains a validation step to check file names submitted to the Data Center and reject files for which the test fails. At the end of 2022, OPAR updated validation scripts from the BKG version to take into account the updated version of the Master Schedule format V2 and the new naming convention for `vgosDB` and SINEX files.

You can look in Table 1 at Web and ftp data bandwidth used during these two years of OPAR activities.

Table 1 User activity of the OPAR Data Center.

	No. unique visitors	No. visits	No. hits	Bandwidth (Go)
2021				
FTP	825	10882	584,593	2,307
WWW	7,152	11,981	68,149	25
2022				
FTP	1,017	7,579	760,744	182
WWW	6,914	11,655	38,407	4

4 Future Plans

We will continue to update validation scripts using versions provided by the BKG and/or CDDIS Data Centers to ensure the consistency between the three centers. At the beginning of 2023, we will upgrade our OPAR server Linux system to Debian 11. The user activity of the OPAR Data Center is summarized in Table 1.

To obtain information about the OPAR Data Center, please contact ivs.opa@obspm.fr.

ANALYSIS CENTERS



Analysis Center of Saint Petersburg University

Dmitriy Trofimov

Abstract This report briefly summarizes the activities of the Analysis Center of Saint Petersburg University during 2021 and 2022. The current status, as well as our future plans, are described.

1 General Information

The Analysis Center of Saint Petersburg University (SPU AC) was established at the Sobolev Astronomical Institute of the SPb University in 1998. The main activity of the SPU AC for the International VLBI Service before 2007 consisted of routine processing of 24-hour and one-hour observational sessions for obtaining Earth Orientation Parameters (EOP) and rapid UT1–UTC values, respectively. In 2008 we began submitting the results of 24-hour session processing. In 2021, Kalman filter processing was discontinued and we are currently in the process of upgrading the software and reprocessing our EOP series.

2 Staff

The assistant professor of Saint Petersburg University, Dmitriy Trofimov, was in charge of the routine processing of the VLBI observations. General coordination and support for the activities of the SPU AC at the Astronomical Institute were performed by the head of the chair of astronomy Sergey Petrov.

Sobolev Astronomical Institute of Saint Petersburg University

AI SPbU Analysis Center

IVS 2021+2022 Biennial Report

3 Current Status and Activities

Until December 2020, we processed 24-hour sessions in the OCCAM software version 6.2 [1] using the Kalman filtering method. Two series of EOP were supported. We planned to start a new series, based on a new catalog of radio sources, obtained by Kalman filtering. However, in the process of preparation, we decided to stop processing with the Kalman filtering method, switch to OCCAM version 6.3, and obtain a new series via the least-squares collocation method. At the moment, the existing observations from 1989 to 2022 are being reprocessed based on the least-squares collocation. We plan to complete it during 2023, after which we regularly update the new series.

Our experience and the equipment of the Analysis Center was used for giving lectures and practical work on the basics of radio interferometry to university students. As part of these workshops, the EOP were determined by the Kalman filtering method; this work is described in our old manual [2]. The next step is devoted to determining the coordinates of VLBI stations using the least-squares collocation method. In 2022, a manual on this work was prepared and we plan to publish it in 2023.

4 Future Plans

We plan to complete the processing of the series obtained by the least-squares collocation method, then submit the series on the IVS databases and start its regular addition. We are planning to publish our manual on determining the coordinates of VLBI stations using the OCCAM software. Lastly, we plan to increase the

amount of work performed by students in the framework of a special workshop.

References

1. O. Titov, V. Tesmer, J. Boehm. OCCAM v. 6. 0 Software for VLBI Data Analysis, In International VLBI Service for Geodesy and Astrometry 2004 General Meeting Proceedings, N. R. Vandenberg and K. D. Baver (eds.), NASA/CP-2004-212255, pp. 267-271, 2004.
2. V. Vityazev, I. Guseva, V. Kiyayev, M. Mishchenko, O. Titov, A. Tsvetkov. Celestial and Terrestrial Coordinates (In Russian), Manual on Astrometry, p. 301, SPb University, 2011.

Geoscience Australia Analysis Center Report

Oleg Titov

Abstract This report gives an overview of the activities of the Geoscience Australia IVS Analysis Center during 2021–2022.

1 General Information

The Geoscience Australia (GA) International VLBI Service (IVS) Analysis Center is located in Canberra within the National Geodesy Section, National Positioning Infrastructure Branch, Space Division of Geoscience Australia.

2 Activities during the Years 2021–2022

Several celestial reference frame (CRF) solutions were prepared using the OCCAM 6.3 software. The latest solution was released in December 2022 (https://ivs.bkg.bund.de/data_dir/vlbi/ivsproducts/crf/aus2022b.crf.gz). VLBI data consisting of 4,313 daily sessions from May 1993 to September 2022 were used to compute this solution. This includes 5,332 radio sources having three or more observations. Positions of 57 radio sources including four radio stars were estimated as daily parameters. The total number of observational delays used in this solution is 12,893,362. Earlier VLBI data between 1980 and 1993 were not used for this solution due to poor quality of astrometric parameters.

Geoscience Australia

GA Analysis Center

IVS 2021+2022 Biennial Report

Station coordinates were also estimated using No-Net-Rotation (NNR) and No-Net-Translation (NNT) constraints. The long-term time series of the station coordinates were used to estimate the corresponding velocities for each station. The tectonic motion for the Gilcreek VLBI site after the Denali earthquake was modeled using an exponential function typical of post-seismic deformation [1].

The adjustment was made by least squares collocation, which considers the clock offsets, wet troposphere delays, and tropospheric gradients as stochastic parameters with apriori covariance functions. The troposphere gradient covariance functions were estimated from GPS hourly values.

Four radio stars (HR1099, UX Ari, the Vela pulsar, and LSI+61 303) within our galaxy were detected with geodetic VLBI. They display a significant proper motion with a magnitude of 10–100 mas/y and an annual parallax of 5–100 mas. All other radio sources are extragalactic objects at the cosmological distance, so their proper motion and parallax are known to be zero, and the expected positional variations due to change of intrinsic structure do not exceed 3–5 mas. Only three outstanding positional changes were detected in 2016 with the Second Epoch Very Long Baseline Array (VLBA) calibrator survey [2]. For example, radio source 1524 – 136 has shifted more than 100 mas between 1997 and 2014. But it was treated as a “stable” radio source in the recent ICRF3 catalog published in 2018 because its early observations in 1997 were ignored [3].

Nonetheless, we found that more reference radio sources show an unprecedented change in their apparent positions (up to 200 mas) on time scales from several years to several decades using new observations released after 2018. This is predictably linked to the

evolution of the intrinsic source structure and brightness distribution, although the scale of these positional changes is far beyond the common astrometric instabilities. Four objects (3C48, CTA21, 1144 + 352, and 1328 + 254) were reported ([4]), and about 50 other objects are under analysis.

A potential impact of such positional instability on the statistical quality of future astrometric catalogs may be severe, should the number of the radio sources with large offsets soar during the next decade. As all the offsets were found with recent observations made in the post-ICRF3 era, this means that any radio reference frame source may suddenly demonstrate an abrupt change in its coordinates. This seems more likely for the sources with complex, extended core–jet structure at the scale of 10–100 mas or, even more, with multiple compact components in VLBI images. Therefore, a higher number of radio sources with similar positional offsets could be found with future VLBI observations.

Acknowledgments

This report has been published with the permission of the CEO, Geoscience Australia.

References

1. Titov O., Tregoning P., 2005, *JGeod.*, 79, 196. doi:10.1007/s00190-005-0459-9
2. Gordon D., Jacobs C., Beasley A., Peck A., Gaume R., Charlot P., Fey A., et al., 2016, *AJ*, 151, 154. doi:10.3847/0004-6256/151/6/154
3. Charlot P., Jacobs C. S., Gordon D., Lambert S., de Witt A., Böhm J., Fey A. L., et al., 2020, *A&A*, 644, A159. doi:10.1051/0004-6361/202038368
4. Titov O., Frey S., Melnikov A., Lambert S., Shu F., Xia B., González J., et al., 2022, *MNRAS*, 512, 874. doi:10.1093/mnras/stac038

Report for 2021–2022 from the Bordeaux IVS Analysis Center

Patrick Charlot¹, Arnaud Collioud¹, María Eugenia Gómez², Stéphane Paulin-Henriksson³

Abstract This report provides an overview of the activities of the Bordeaux IVS Analysis Center in 2021 and 2022. In this period, the imaging of the RDV sessions proceeded in the continuity of our previous work, disseminating the resulting images and related information (structure indices, source compactness, flux densities, etc.) through the Bordeaux VLBI Image Database. Based on all the images available, a study comparing the direction of the VLBI jets (calculated with an algorithm of our own) with that of the optical-radio offset vectors showed that the two directions are within 30° in about half of the sources. Activities related to the GINS software package were reactivated with a focus on the assessment of the quality of the geodetic results provided by GINS. Also carried on was our observing program to monitor optically-bright ICRF3 sources, taking advantage of the ongoing R&D sessions. In addition, observations dedicated to measuring the geodetic positions of the non-geodetic antennas of the European VLBI Network were pursued as part of our contribution to the EU-funded JUMPING JIVE project. Carried out at K-band, these observations proved also useful to image the sources with high resolution. Finally, another activity was targeted to simulate VLBI images from actual and trial VGOS schedules. The purpose was to investigate new VGOS scheduling schemes that allow for imaging, while maintaining or improving the quality of the geodetic results at the same time.

1. OASU–Laboratoire d’Astrophysique de Bordeaux

2. University of La Plata, MAGGIA and CONICET, Argentina

3. OASU–Pluridisciplinarité au service de l’Observation et de la Recherche en Environnement et Astronomie

Bordeaux Analysis Center

IVS 2021+2022 Biennial Report

1 General Information

The *Laboratoire d’Astrophysique de Bordeaux (LAB)* is a research unit funded by the University of Bordeaux and the *Centre National de la Recherche Scientifique (CNRS)*. It is part of a bigger organization, the *Observatoire Aquitain des Sciences de l’Univers (OASU)*, formerly Bordeaux Observatory. The OASU has a wider scope, covering environmental sciences besides historic activities in astronomy and astrophysics. A specific role of the observatory is to provide support for acquiring, analyzing, and archiving observations of various types in these fields, including participation in national and international services like the IVS. Delivering such support, specifically, falls within the mandate of the *Pluridisciplinarité au service de l’Observation et de la Recherche en Environnement et Astronomie (POREA)* service unit of the OASU.

VLBI activities at the LAB are carried out within the M2A (*Métrologie de l’espace, Astrodynamique, Astrophysique*) team. The contribution of the LAB to the IVS does in the first place concern the maintenance and improvement of the International Celestial Reference Frame (ICRF). This includes regular imaging of the ICRF sources and evaluation of their astrometric suitability, as well as developing specific VLBI observing programs for enhancing the frame. In addition, the group conducts VLBI analyses with the GINS software package, a multi-technique software developed by the CNES (*Centre National d’Etudes Spatiales*) which has the ability to process data from most space geodetic techniques, including GNSS, DORIS, SLR, LLR, VLBI, satellite altimetry, and other space missions [1]. In conjunction with this analysis activity, the group is also engaged in assessing the VLBI part of GINS based on comparisons with other VLBI software packages.

2 Description of Analysis Center

The Bordeaux IVS group is engaged in the analysis of the IVS-R1 and IVS-R4 sessions with the GINS software package. From these sessions, Earth Orientation Parameters (EOP) estimates with six-hour resolution were produced. The focus of such analysis work is placed upon developing a state-of-the-art operational VLBI solution with the goal of contributing to the IVS primary EOP combination in the future.

The Analysis Center is further engaged in the imaging of ICRF sources on a regular basis. This is achieved by a systematic analysis of the data from the RDV sessions, which is carried out with the AIPS and DIFMAP software packages. The aim of such regular imaging work is to assess the astrometric suitability of the sources based on the so-called “structure index.” Characterization of the source positional instabilities and comparison of those instabilities with their structural evolution is an additional direction of work. Such studies are essential for identifying sources of high astrometric quality, a requirement to define the celestial frame at the best level.

Occasionally, the group leads or participates in specific observing programs or other VLBI developments. For the present period, these include the monitoring of optically-bright ICRF sources (i.e., detected by the Gaia mission), the carrying out of K-band observations for geodetic purposes as part of the EU-funded JUMPING JIVE project, and imaging simulations to assess the potential for imaging of new VGOS scheduling methods.

3 Scientific Staff

During the period 2021–2022, four individuals contributed to one or more of our VLBI analysis and research activities. A description of what each person worked on, along with an estimate of the time spent on it, is given below. As noted in our previous biennial report, María Eugenia Gómez returned to her home institute in La Plata, Argentina, in November 2020. Since then, she has continued working closely with us and therefore is associated to this biennial report.

- Patrick Charlot (60%): researcher with overall responsibility for Analysis Center work. His primary

interests include all aspects of ICRF, comparisons with the Gaia frame, studies of radio source structure and its impact in astrometric VLBI, and astrophysical interpretation. He also led a work package about geodesy in the JUMPING JIVE project.

- Arnaud Collioud (90%): engineer with a background in astronomy and interferometry. His duties include imaging the sources observed in the RDV sessions using AIPS and DIFMAP and developing the Bordeaux VLBI Image Database and *IVS Live* tool. He also contributes to research in astrometry and astrophysics making use of these data.
- María Eugenia Gómez: researcher from the University of La Plata and CONICET, formerly a post-doc in Bordeaux. Her contribution is with the analysis of observations acquired by the EVN at K-band for the purpose of the JUMPING JIVE project and beyond. She is also involved in the GINS activities, notably in the validation at the underlying VLBI model.
- Stéphane Paulin-Henriksson (25%): engineer with a background in astronomy. His tasks are to maintain the GINS software package installation locally, to contribute to comparisons with other VLBI software packages, and to develop procedures to automate the processing for future operational analyses.

4 Current Status

As reported previously, one of our goals is to implement an operational analysis of the IVS-R1 and IVS-R4 sessions using the GINS software package. Since the VLBI capability of GINS has not been widely used, a prerequisite is to assess the quality of the results derived with GINS by validating them against equivalent results obtained with other VLBI software packages. In particular, we wish to compare the individual components of the VLBI delay model in GINS with the same such components calculated independently. Based on expertise within the group, we selected the Vienna VLBI Software (VieVS) as the reference software for these comparisons. The focus was placed first on comparing the geometric model, excluding station corrections and tropospheric corrections. This assessment shows that the calculated GINS and VieVS delays (limited to that part of the model) are within about 2 mm (see Figure 1). While this level of agreement is

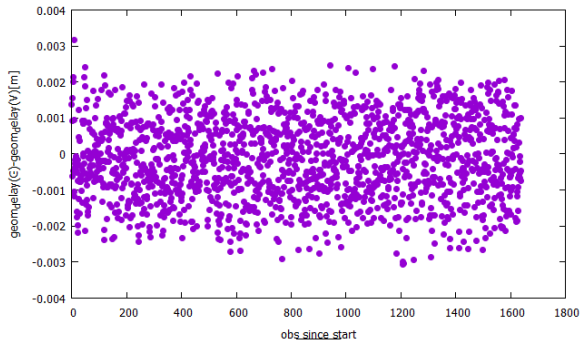

Fig. 1 Comparison of the geometric VLBI delay calculated with the GINS and VieVS software packages, excluding station corrections and tropospheric corrections, for the data of the session IVS-R1309 conducted on 2 January 2008. Differences (given in meter) are plotted as a function of the observation number.

already fairly good, it is not at the level we expect for such a comparison, the goal being rather to reach differences one order of magnitude smaller. Furthermore, a closer look at those differences reveals that they are not random but show a roughly diurnal systematic pattern for each VLBI baseline/quasar pairs. This issue is being investigated and once resolved, we will pursue the comparison for the rest of the VLBI delay model, i.e., station corrections and tropospheric modeling.

Another major part of our activity consists in systematically imaging the sources observed in the RDV sessions. During 2021 and 2022, seven such sessions were processed (RV130, RV132, RV134, RV136, RV138, RV144, and RV146), resulting in 1,012 VLBI images at either X- or S-band for 309 different sources. The imaging work load has been shared with USNO since 2007 (starting with RDV61); the USNO group processes the odd-numbered RDV sessions while the Bordeaux group processes the even-numbered ones. The VLBI images are used in a second stage to derive structure correction maps and visibility maps along with values for structure indices and source compactness (see [2, 3] for a definition of these quantities) in order to assess astrometric source quality. All such information is made available through the Bordeaux VLBI Image Database (BVID)¹ [4]. At present, the BVID comprises a total of 7,862 VLBI images for 1,514 different sources (with links to an additional 6,775 VLBI images from the Radio Reference Frame

¹ See <http://bvid.astrophys.u-bordeaux.fr>.

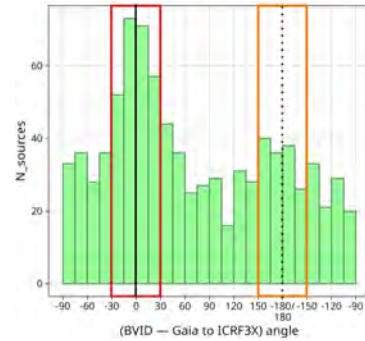

Fig. 2 Distribution of the angle between the BVID jet direction and the Gaia-CRF3 to ICRF3 S/X-band offset vector direction for 865 sources. The red and orange rectangles represent the block of sources where the optical-radio offset vector is aligned within a range of $\pm 30^\circ$ with the VLBI jet direction.

Image Database of USNO) along with 14,637 structure correction maps and as many visibility maps. These originate from 89 sessions spanning a total of 26 years.

5 Achievements

Apart from the recurring activities described in the previous section, we also developed more research-oriented work. One line of investigation was aimed to compare the direction of the VLBI jets seen in the BVID images with the direction of the offset vectors joining the ICRF3 and Gaia-CRF3 positions. For this comparison, the VLBI jet directions were determined in an automatic way for all available BVID images, based on an algorithm that we devised (see details in our previous Biennial Report). The optical-radio offset vector angles were derived in a manner similar to that used for the comparison of the ICRF3 and Gaia-CRF2 in [5]. As reported in [6], the results of this comparison show that the optical-radio offset vector predominantly aligns with the jet direction. More precisely, the alignment is within 30° for almost half of the sample (393 sources), with 253 and 140 sources in the same and opposite directions, respectively (see Figure 2). Additionally, it was found that the portion of such sources grows as the separation between the optical and radio positions (in a normalized sense) increases. For example, when the separation is larger

than 6σ , the property is verified for almost all sources (96%).

On the observing side, we are taking advantage of the R&D sessions to further pursue the monitoring of some under-observed optically-bright ICRF3 sources (i.e., detected by Gaia). Starting from summer 2020, our initial strategy [7] was refined in a way that the list of targets is now adjusted prior to each R&D session. Only sources not observed for the past 30 days, taking into account all IVS sessions are scheduled, with preferences given to those that are brighter than magnitude 18, and then 19 and 20 (in decreasing order), all of which are subject to having a structure index smaller than three (as previously mentioned). This new scheme was made possible thanks to the *IVS Live* web tool (see below) which allows us to obtain the observing status of any given source at any given moment. A total of twenty such R&D sessions were scheduled in 2021 and 2022.

Additionally, we pursue observations at K-band with the European VLBI Network (EVN). The initial objectives of these observations were (i) to exercise the geodetic capability of the EVN software correlator at JIVE (SFXC) that was implemented as part of the JUMPING JIVE project and (ii) to determine the geodetic positions of the EVN non-geodetic antennas, also a goal of JUMPING JIVE. To this end, two dedicated EVN experiments were carried out in June 2018 and October 2020. The analysis of the data from these experiments allowed us to derive the position of the EVN antennas in the ITRF2014 terrestrial reference frame with centimeter-level precision [8]. The data are currently being re-analyzed to place those positions directly in the newly-released ITRF2020 terrestrial frame. In the course of the project, it was also realized that the network may also be quite suitable for VLBI imaging thanks to the large number of antennas with K-band capability. The experiment from October 2020 was used as a test bed for this purpose. Figure 3 shows one of the images produced, confirming the potential of the EVN for imaging ICRF3 sources at K-band through these geodetic-style experiments [9].

Besides the above activities, the period also gave us the opportunity to reactivate the imaging simulations that we developed when the VLBI2010 system was designed. This emerged from discussions within the VTC source structure sub-group, chaired by Patrick Charlot, which showed the need to investigate new scheduling methods that would allow for source structure imaging

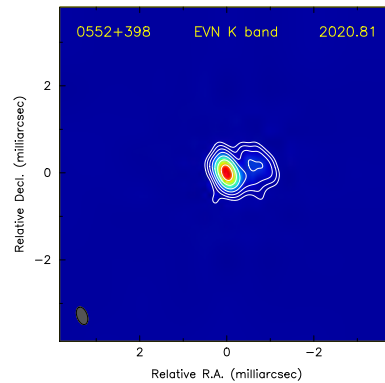

Fig. 3 VLBI image at K-band of the source 0552+398 observed during the EVN experiment EC076, conducted on 23 October 2020. Contour levels are drawn at $\pm 1, 2, 4, 8, 16, 32$, and 64% of the peak brightness of the image.

from routine VGOS sessions. To this end, the pipeline previously built [10] was used again to simulate images in the four VGOS bands based on trial schedules generated with the VieSched++ software package. Statistics on the image quality were derived by using the image dynamic range as an indicator of such quality. Interestingly, the simulations showed that the UV coverage does depend on the VGOS band—it degrades from band A to band D—although one might think otherwise. This is due to the (fixed) bandwidth becoming a smaller fraction of the total frequency as the frequency increases. Additionally, the dynamic range was also found to depend at some level on the source structure. In all, the work contributed to the development of a new “source-centric” scheduling approach that allows for imaging twice as many sources compared to the standard “station-centric” scheduling scheme, while also leading to improved geodetic performance [11].

6 Dissemination and Outreach

The *IVS Live* website², a specific tool developed by the Bordeaux group, provides “Live” information about ongoing IVS sessions, including VLBI images of the observed sources [12]. The website is updated automatically based on the IVS Master Schedule. It now incorporates 12,124 IVS sessions, involving 88 stations

² Available at <http://ivslive.astrophy.u-bordeaux.fr>.

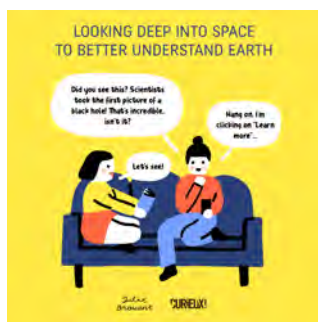

Fig. 4 First slide of the English version of the VLBI comic.

and featuring 3,113 sources. Tracing the connections indicates that there were 614 visits from 481 different users in 43 countries in 2021 and 2022. The statistics of access to the BVID, 2,167 visits from 1,250 different users in 75 countries, reveal increased interest, with twice as many visits and users compared to the previous period. As for dissemination, Patrick Charlot gave a lecture on radio sources at the 4th IVS Training School on VLBI for Geodesy and Astrometry, held online between 22–25 March 2022. During 2021 and 2022, he also gave seven lectures about geodetic VLBI, also online, for African students participating in the DARA (Development in Africa with Radio Astronomy) program. Of interest is also the development of a cartoon about VLBI as part of the outreach activities for the JUMPING JIVE project. In the comic, two friends embark in a journey through space sparked by curiosity after seeing the first image of a black hole. In their journey they learn about VLBI and its applications. The comic is available in both French and English (Figure 4).

7 Future Plans

Our plans for the next two years will follow the same analysis and research lines. In particular, we expect to have a final assessment of the quality of the GINS results by performing additional comparisons against the VieVS software package. Imaging the RDV sessions and evaluating the source astrometric suitability, a specificity of the Bordeaux group, will also be carried on. Going beyond our study on the alignment of the optical-radio offset vectors and VLBI jet directions, we plan to further explore the relationship between source

structure and the observed positional offsets—either between optical and radio or between the three ICRF3 bands—by taking advantage of all of the images available in BVID. On the observing side, the R&D sessions dedicated to monitor under-observed optically-bright ICRF3 sources are expected to be carried on until the end of the Gaia mission around 2025. In addition, we plan to conduct further EVN observations at K-band, in the continuation of JUMPING JIVE, for mixed geodesy, astrometry, and imaging goals.

Acknowledgements

We would like to thank the OASU for continued support of the Bordeaux IVS Analysis Center. The JUMPING JIVE project received funding from the European Union’s Horizon 2020 Research and Innovation Programme under grant agreement No. 730884.

References

1. Bourda, G., Charlot, P., Biancale, R.: 2007, GINS: A New Tool for VLBI Geodesy and Astrometry, 18th EVGA Working Meeting, Eds. J. Böhm, A. Pany, and H. Schuh, IGG Vienna, pp. 59–63.
2. Fey, A. L., Charlot, P.: 1997, VLBA Observations of Radio Reference Frame Sources. II. Astrometric Suitability Based on Observed Structure, *ApJS*, 111, 95–142.
3. Charlot, P.: 2008, Astrophysical Stability of Radio Sources and Implication for the Realization of the Next ICRF, 5th IVS General Meeting, Eds. A. Finkelstein and D. Behrend, pp. 345–354.
4. Collioud, A., Charlot, P.: 2019, The Second Version of the Bordeaux VLBI Image Database (BVID), 24th Meeting of the European VLBI Group for Geodesy and Astrometry, Eds. R. Haas, S. Garcia-Espada, and J. A. López Fernández, pp. 219–223.
5. Charlot, P., Jacobs, C. S., Gordon, D., et al.: 2020, The third realization of the International Celestial Reference Frame by very long baseline interferometry, *A&A*, 644, A159.
6. Collioud, A., Charlot, P., Lambert, S.: 2023, Exploring Source Structure with the Bordeaux VLBI Image Database - Comparing Jet Directions with Optical-Radio Offset Vectors, IVS 2022 General Meeting Proceedings, Eds. Kyla L. Armstrong, Dirk Behrend, and Karen D. Baver, NASA/CP-20220018789, pp. 212–216.
7. Le Bail, K., Gipson, J., Gordon, D., et al.: 2016, IVS Observation of Gaia-ICRF2 transfer sources, *AJ*, 151, id. 79.
8. Gómez, M. E., Charlot, P., Campbell, R. M., Kettenis, M., Keimpema, A.: 2021, Analysis of EVN station positions, JUMPING JIVE Deliverable D6.3.

9. Charlot, P., Gómez, M. E., Campbell, R. M., Keimpema, A., Kettenis, M., Collioud, A.: 2023, Imaging ICRF3 sources at K band with the European VLBI Network, Proceedings of the 15th EVN Symposium (in press).
10. Collioud, A., Charlot, P.: 2012, VLBI2010 Imaging and Structure Correction Impact, IVS 2012 General Meeting Proceedings, Eds. D. Behrend and K. D. Baver, NASA/CP-2012-217504, pp. 47–51.
11. Schartner, M., Collioud, A., Charlot, P., Xu, M. H., Soja, B.: 2023, Bridging astronomical, astrometric and geodetic scheduling for VGOS, *JoG*, 97:17.
12. Collioud, A.: 2011, IVS Live: All IVS on your desktop, 20th Meeting of the European VLBI Group for Geodesy and Astrometry, Eds. W. Alef, S. Bernhart, and A. Nothnagel, Universität Bonn, IGG, Schriftenreihe 22, pp. 14–18.

BKG VLBI Analysis Center

Gerald Engelhardt, Anastasiia Walenta, Dieter Ullrich, Claudia Flohrer

Abstract In 2021 and 2022, the activities of the BKG VLBI Analysis Center, as in previous years, consisted mainly of routine VLBI analysis for IVS. Our solutions are computed with the geodetic VLBI software vSolve [5] for the analysis of sessions in the vgosDB data format and the Calc/Solve software, release 2019.11.21, revision date 2020.01.23. In 2021 the generation of the BKG AC contribution for ITRF2020 was completed.

We are also supporting new software developments for the Bernese GNSS Software, in order to process VLBI data of vgosDB version 4.

It is worth highlighting that the BKG AC makes an effort to maintain the analysis workflow starting with the computed group delays given in version 1 of the wrapper file of the vgosDB data format.

The processing chain of VGOS databases for generating IVS products in the reporting period was further developed and refined. The technical VLBI data handling supports routine acquisition from the Data Center, preliminary evaluation with vSolve routines, product-based evaluation with Calc/Solve, and final preparation of the products for IVS, which includes the products' delivery to the BKG Data Center.

1 General Information

The German Federal Agency for Cartography and Geodesy (BKG) maintains the VLBI Analysis Center with the status of an operational Analysis Center as defined by the International VLBI Service for Geodesy and Astrometry (IVS).

The BKG VLBI Analysis Center is responsible for the computations of Earth orientation parameter (EOP) EOP-S time series derived from 24-hour sessions and EOP-I *Intensive* sessions as well as corresponding (Solution INdependent EXchange format) SINEX products. The VLBI group at BKG continues regular submissions of the tropospheric parameter time series. The quarterly updated solutions were obtained as well in both years to produce terrestrial reference frame (TRF) and celestial reference frame (CRF) products.

BKG

BKG Analysis Center

IVS 2021+2022 Biennial Report

2 Data Analysis at BKG

The initial step of the data analysis is carried out with the interactive geodetic VLBI software vSolve [5]. The Mark 5 VLBI data analysis software system Calc/Solve, release 2019.11.21 [4], is utilized for the processing of the so-called level 4 of the vgosDB provided by vSolve to build the IVS products.

- **Processing of version 1 of the wrapper file of the vgosDB data format**

The BKG group continued the processing of the calibrated databases in the vgosDB format starting with the version 1 wrapper file for all of the sessions in the master files. The vgosDb is filled, then, with the required reductions to generate the version 2 and 3 wrapper files by means of vSolve routines vgosDbCalc and vgosDbProcLogs. The corrections for the ambiguities and ionosphere are computed independently with vSolve [5], where it is required, in the first step of the data analysis. In the second step, the minimum parameteriza-

tion is applied in vSolve to remove the outliers, and the final results are stored as the version 4 wrapper file. We note that ionospheric corrections are taken into account in available group delays for the VGOS observations, where the ambiguities resolution is also facilitated by broadband data advantage. The obtained level 4 data is available at the designated area of the BKG DC (see ftp://ivs.bkg.bund.de/pub/vlbi/ivsdata/vgosdb_bkg/).

- **Responsibility of the BKG AC to deliver level 4 of the vgosDB**

The analyzed sessions (level 4 of the vgosDB) correlated at the Max Planck Institute for Radio Astronomy (MPIfR)/BKG Astro/Geo Correlator at Bonn, namely OHIG and T2, are delivered to the IVS Data Centers to fulfill the BKG AC responsibility as assigned according to the master file.

- **BKG EOP time series**

The BKG EOP time series bkg2020a is supported as described [1], which data set is extended by all available broadband VGOS sessions according to the master file. The station coordinates of stations DSS13 (USA), ISHIOKA (Japan), RAEGYEB (Spain), TIANMA65 (China), and WETTZ13N (Germany) were determined now as global parameters due to the collected observation period longer than three years. A number of new VLBI stations were included in the data processing: DSS26 (USA) and DSS56 (Spain) as well as the new VGOS stations GGAO12M (USA), KOKEE12M (USA), MACGO12M (USA), ONSA13NE (Sweden), ONSA13SW (Sweden), and WETTZ13S (Germany). Each time after preprocessing of a new VLBI session, a new global solution including over 6,300 24-hour sessions since 1984 was computed, and the operational EOP time series bkg2020a was built. In this solution the station coordinates and velocities were globally estimated, as well as the source positions and EOP. The datum definition was realized by applying no-net-rotation and no-net-translation conditions for 46 selected station positions and velocities with respect to ITRF2014 and a no-net-rotation condition for 303 defining sources with respect to ICRF3.

The station coordinates of the telescopes AGGO (Argentina), AIRA (Japan), CHICHI10 (Japan), CTVASTJ (Canada), DSS26 (USA), DSS34 (Australia), DSS36 (Australia), DSS56

(Spain), KASHIM11 (Japan), KASHIM34 (Japan), KOGANEI (Japan), NYALE13S (Norway), OHIGGINS (Antarctica), PT_REYES (USA), RAEGSMAR (Azores), SEST (Chile), SINTOTU3 (Japan), SVERT13V (Russia), TIDBIN64 (Australia), TIGOCONC (Chile), TSUKUB32 (Japan), UCHINOUR (Japan), VERAISGK (Japan), VERAMZSW (Japan), WARK30M (New Zealand), WIDE85.3 (USA), and YEBES40M (Spain) were estimated as local parameters in each session.

The next generation series bkg2022a was introduced in 2022 as soon as ITRF2020 was released. The new time series is supported along with the operational bkg2020a series. The main difference with respect to the existing solution bkg2020a is the use of the newly available ITRF2020 for the a priori station coordinates and velocities as well as the associated post-seismic deformation model. The bkg2022a series is to become the operational EOP and SINEX product, when the IVS announces the switch to ITRF2020.

- **BKG UT1 *Intensive* time series**

The analysis of the UT1-UTC *Intensive* time series bkg2020a was continued. The time series bkg2020a is generated with the station positions fixed to ITRF2014 and source positions fixed to ICRF3. The a priori EOP are taken from the USNO finals time series [6]. The estimated parameters are UT1-TAI, station clocks, and zenith wet delay. In 2022, a new UT1-UTC *Intensive* time series bkg2022a was created similar to the EOP-S products, where the only difference with respect to the existing solution bkg2020a is the use of the new a priori ITRF2020.

A total of 1,255 *Intensive* sessions were analyzed for the period from 2021.01.03 to 2022.12.31.

- **Quarterly updated solutions**

In 2021, the quarterly updated solutions were computed for the IVS products TRF and CRF. There are no differences in the solution computation strategy compared to the continuously obtained EOP time series bkg2020a. In 2022, the quarterly solutions were calculated also according to the description of the time series bkg2022a as defined above. The results of the radio source positions were submitted to IVS in IERS format. The TRF solution is made available in SINEX format version 2.1 and includes the station coordinates, station velocities, and radio source coordinates together with the covariance

matrix, information about constraints, and the decomposed normal matrix and vector.

- **Tropospheric parameters**

Calc/Solve allows the generation of so-called tropospheric path delay (TRP) files, which deliver the parameter estimates based on the Vienna Mapping Function (VMF1/VMF3) data. The TRP files contain the following information to describe the troposphere on a scan-by-scan basis: the a priori delay, dry and wet mapping functions, and the gradient mapping functions. The VMF3 data were downloaded daily from the server of the Vienna University of Technology [7]. The VLBI group of BKG continued the regular submissions of long time series of tropospheric parameters in the SINEX format as the tropospheric product to the IVS (wet and total zenith delays and horizontal gradients) for all VLBI sessions since 1984. In 2022, a new tropospheric parameter time series bkg2022a was created in addition to the bkg2020a series based on a global solution with a priori ITRF2020. The tropospheric parameters were extracted from the standard global solutions and transformed into tropospheric SINEX format for both IVS submissions: bkg2020a and bkg2022a.

- **Daily SINEX files**

The VLBI group at BKG supports the regular submissions of daily SINEX files (bkg2020a) for all available 24-hour sessions to contribute to the IVS combined products and for the IVS time series of baseline lengths. The daily SINEX files include the session-wise estimates of station coordinates, radio source coordinates, and EOP including the X, Y-nutation parameters. The a priori datum for TRF is defined by the ITRF2014, and ICRF3 is used for the a priori CRF information. A second series of daily SINEX files (bkg2022a) was generated with a priori ITRF2020 with no further changes regarding the solution strategy.

- **SINEX files for *Intensive sessions***

The creation of SINEX files for all *Intensive sessions* (bkg2020a) continued. Also another set of SINEX files for *Intensive sessions* (bkg2022a) was generated based on a priori ITRF2020. The following estimated parameters are delivered in SINEX files: station coordinates, pole coordinates and their rates, and UT1-TAI and its rate. The normal equations stored in the SINEX files are feasible for

further intra-technique combination or combination with other space geodetic techniques.

- **Contribution to ITRF2020**

In 2021, the BKG Analysis Center submitted the remaining SINEX files for 24-hour sessions to support the IVS Combination Center to build the combined solution as the IVS contribution to ITRF2020. There is no difference in the parameterization with respect to our IVS product – daily SINEX files bkg2020a.

- **Contribution to EU-VGOS and PWLO projects**

We are involved in the EU-VGOS collaboration [2], in which Anastasiia Walenta takes care of the organization of the analysis group activity, where the analysis results are presented and discussed.

In the last year we have taken part in the PWLO project, where the SINEX files were prepared. The scope of the project was presented [3].

3 Developments

Currently we are also looking into VLBI data analysis using the *Bernese GNSS Software* [8]. This software package is used at BKG for GNSS and SLR data processing so far. We commissioned the Astronomical Institute of the University of Bern, Switzerland (AIUB), to enhance the *Bernese GNSS Software* in order to process VLBI data. This work is still under development. We expect a first basic version to be available for BKG within this year. It will allow us to process vgosDB data version 4 and will not only be used for VLBI data analysis and comparisons but also for the combination of the different space-geodetic techniques VLBI, SLR, and GNSS.

4 Personnel

- Gerald Engelhardt, gerald.engelhardt@bkg.bund.de
- Anastasiia Walenta (formerly Girduik), anastasiia.walenta@bkg.bund.de
- Dieter Ullrich, dieter.ullrich@bkg.bund.de
- Claudia Flohrer, Claudia.Flohrer@bkg.bund.de

5 Future

We are interested to learn how to bridge data analysis and correlation. The availability of level 1 data facilitates the analysis group's learning of its capabilities in order to improve the obtained results and, thus, IVS products. Besides, we are going to consider the analysis optimization options in view of the growing amount of the coming VLBI observations.

References

1. G. Engelhardt, A. Girdiuk, M. Goltz, D. Ullrich. BKG VLBI Analysis Center, in: International VLBI Service for Geodesy and Astrometry 2019+2020 Biennial Report, edited by D. Behrend, K. L. Armstrong, and K. Baver, NASA/TP-20210021389, 2021.
2. E. Albentosa et al., Current Status of the EU-VGOS Project, in: IVS 2022 General Meeting Proceedings, edited by K. L. Armstrong, D. Behrend, and K. D. Baver, NASA/CP-20220018789, 2023.
3. A. Nothnagel, S. Böhm, R. Dach, A. Girdiuk, M. Glomsda, H. Hellmers, A.-S. Kirkvik, T. Nilsson, A. Girdiuk, D. Thaller, First results of project on six-hourly EOP piecewise linear offset parameterization, in: IVS 2022 General Meeting Proceedings, edited by K. L. Armstrong, D. Behrend, and K. D. Baver, NASA/CP-20220018789, 2023.
4. GSFC, NASA (2019): Release of Mark 5 VLBI Analysis Software Calc/Solve from November 21, 2019 (Web reference: https://ivscc.gsfc.nasa.gov/IVS_AC/IVS-AC_contact.htm).
5. GSFC, NASA (2022): Release of vSolve 0.7.6 from July 13, 2022 (Web reference: <https://sourceforge.net/projects/nusolve/>).
6. USNO (2022): Earth orientation parameter series from finals USNO series 2022, (Web reference: https://cdis.nasa.gov/archive/vlbi/gsf/ancillary/solve_apriori/usno_finals.erp).
7. re3data.org: VMF Data Server; editing status 2020-12-14; re3data.org - Registry of Research Data Repositories. <http://doi.org/10.17616/R3RD2H>
8. R. Dach, S. Lutz, P. Walser, P. Fridez (Eds); 2015: Bernese GNSS Software Version 5.2. User manual, Astronomical Institute, University of Bern, Bern Open Publishing. DOI: 10.7892/boris.72297; ISBN: 978-3-906813-05-9.

BKG/DGFI-TUM Combination Center

Sabine Bachmann¹, Hendrik Hellmers¹, Sadegh Modiri¹, Sandra Schneider-Leck¹, Mathis Bloßfeld², Daniela Thaller¹

Abstract This report summarizes the activities of the BKG/DGFI-TUM Combination Center in 2021 and 2022 and outlines the planned activities for 2023 and 2024. The main focus in 2021 and 2022 was submitting the IVS contribution to the ITRF2020. Furthermore, we included additional Analysis Centers in the combined solution. In 2023 and 2024, we intend to improve the combination strategy for small station networks, to expand the consistent realization for EOP, and to evaluate the impact of the different ITRS realizations (DTRF2020, ITRF2020, and JTRF2020) on the combined EOP.

1 General Information

The BKG/DGFI-TUM Combination Center was established in October 2008 as a joint effort of the Federal Agency for Cartography and Geodesy (Bundesamt für Kartographie und Geodäsie, or BKG) and the German Geodetic Research Institute (Deutsches Geodätisches Forschungsinstitut, or DGFI). The participating institutions, as well as the tasks and the structure of the IVS Combination Center, are described in [12]. The tasks comprise quality control and a timely combination of the session-based intermediate results of the IVS Analysis Centers (ACs) into a final combination product (e.g., Earth orientation parameters, or EOP). In coordination with the IVS Analysis Coordinator, the com-

ination results are released as official IVS products. The Combination Center is also expected to contribute to generating the official IVS input for any ITRF activities.

The BKG/DGFI-TUM Combination Center performs a combination of session-based results of the IVS ACs on an operational basis. The strategy for the combination is based on the combination of normal equations and was adopted from the combination process as developed and performed by the IVS Analysis Coordinator (cf. [10], [11]).

At BKG, the following tasks are performed:

- Quality control of the AC results: checking the format of the results and their suitability for combination, identification, and reduction of outliers, comparison of the Analysis Centers' results with each other, and comparison of the results with external time series provided by the IERS, IGS, and ILRS.
- Feedback to the Analysis Centers: quality control results are available on the BKG IVS Combination Center web pages [8].
- Generation of high-quality combination products and timely archiving and distribution: combination products are created by using the combination part DOGS_CS of DGFI-TUM's software package DOGS (DGFI orbit and geodetic parameter estimation software) [3].
- Submission of official IVS combination products to the IERS: the products are submitted to the responsible IERS components to be used for IERS product generation (e.g., for EOP rapid products and the EOP series IERS C04).
- Generation of the official IVS input to the ITRF: the combined session products (from 1979 to present) are submitted for ITRF computation in the form of normal equations in SINEX format [4]. This work

1. Federal Agency for Cartography and Geodesy (BKG)

2. Technische Universität München, Deutsches Geodätisches Forschungsinstitut (DGFI-TUM)

is also supported by the staff of the IERS Central Bureau hosted by BKG.

- Final results are archived in the BKG Data Center and mirrored to the IVS Data Centers at Observatoire de Paris (OPAR) and the Goddard Space Flight Center (GSFC). This work is assisted by the staff of the BKG Data Center.

DGFI-TUM is in charge of the following Combination Center functions:

- DGFI is developing state-of-the-art combination procedures. This work, as well as the following item, is related to the ITRS Combination Center at DGFI.
- The software DOGS_CS is updated by implementing and documenting the developed state-of-the-art combination procedures.
- The DGFI DOGS software package is continuously updated to be in accordance with the IERS Conventions.

2 Activities during the Past Two Years

At BKG, the following activities were performed in 2021 and 2022:

- Integration of the new DOGS_CS software into the IVS combination process.
- Generation of a combined solution for IVS 24-hour rapid sessions twice a week.
- Generation of a combined long-term solution of IVS 24-hour sessions every three months.
- Ensuring that the combination process is in agreement with the IERS2010 Conventions.
- Generation of the IVS combined contribution to the ITRF2020 for the IERS ITRS Combination Centers.
- Validation of the ITRF2020 solution and investigation of the scale behavior as a contribution to the IVS Working Group.
- Pilot project on piecewise linear EOPs: generation and validation of the combined EOP solution.
- Inclusion of new ACs: Vienna University of Technology (VIE) into the routine rapid combination.
- Testing of potential new ACs: University of Alicante, Spain (UAV).
- Refinements of the combination procedure and implementation of source position combination.

For the operational rapid combination, the contribution of one additional AC was added; AC VIE using VieVS was introduced in the combination routine. This increases the number of regularly contributing ACs to 12.

At DGFI-TUM, the following activities were performed in 2021 and 2022:

- Construction and integration of restitution equations.
- Update of the similarity transformation program.

2.1 IVS Contribution to ITRF2020

One of the main tasks was the submission of the IVS contribution to the ITRF2020 and its evaluation. The IVS contribution to the ITRF2020 was finalized and submitted to the IERS ITRS Combination Centers in the beginning of June 2021. Altogether eleven ACs contributed with their reprocessed series, and the variety of software packages used by the ACs could be greatly increased to seven. The reprocessed series contains approximately 6,500 sessions. For the first time, an ITRF also contains VGOS sessions so that station coordinates for the new VGOS sites could be estimated along with the legacy network. Overall, 171 different stations observed between 1979.0 and 2021.0 are included in the contribution. Thereby the number of stations could be increased by five in comparison to the previous ITRF2014.

For the evaluation of the combined contribution, various investigations were made in order to ensure high quality of the submitted files. Figure 1 shows the WRMS values for both the stations and the Earth's rotation (Polar Motion, dUT1) for the combined and the individual AC solutions. As expected, an improvement of the statistics for the combined solution is evident. More details on the combined IVS contribution can be found in [4] and [6].

The IVS Combination Center also contributed to the IVS Working Group for investigating the suspicious behavior of the scale time series seen by the ITRF2020 [5]. Figure 2 shows the scale of single combined sessions with respect to DTRF2020 preliminary (orange), ITRF2014 (magenta), and ITRF2020 (black). An improvement for ITRF2020 compared to ITRF2014 is clearly seen. But the behavior for the most recent years still needs to be understood.

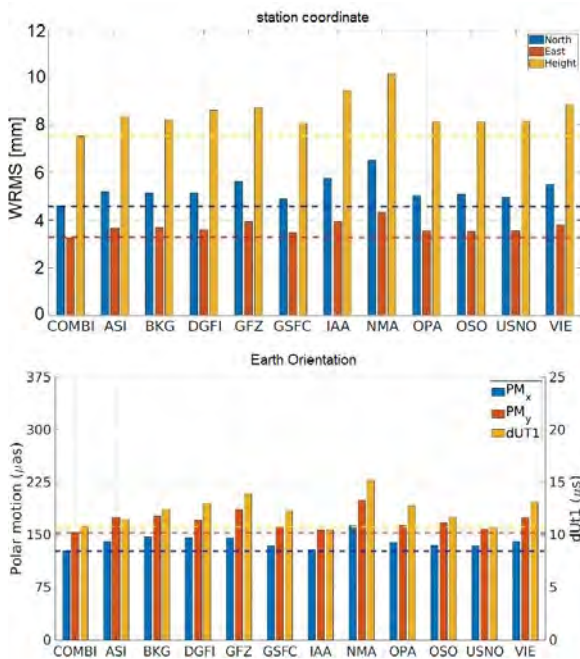

Fig. 1 Station coordinate WRMS of all stations (upper figure). WRMS for Polar Motion and dUT1 (lower figure).

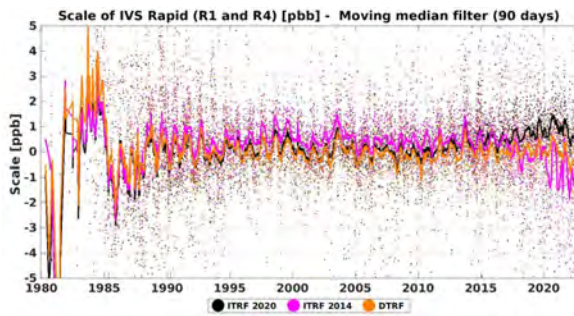

Fig. 2 Scale between single combined sessions and DTRF2020 preliminary (orange), ITRF2014 (magenta), and ITRF2020 (black).

2.2 Project on Six-hourly EOP Piecewise Linear Offset Parameterization

While the estimation of Earth Orientation Parameters (EOP) in conventional VLBI sessions is done at the midpoint of the 24-hour observation interval, the parameterization of EOP in this project is done with continuous piecewise linear functions w.r.t. six-hour intervals [9]. Because most IVS sessions observe between 18h00 UT on the start day and 18h00 UT on the fol-

lowing day, the EOP estimates refer to the mean observation epoch of 6h00 UT on the following day. As a result, the corresponding EOP rate, which is interpolated on the basis of the second and the third day boundary, represents only 3/4 of the entire observation interval. Figure 3 shows the representation of an EOP rate for conventional 24-hour VLBI sessions. Because this

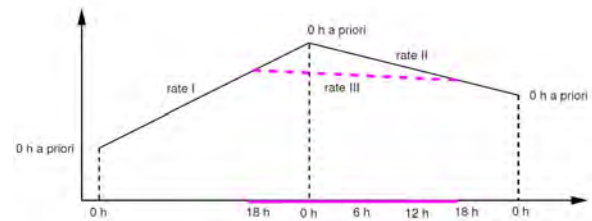

Fig. 3 Representation of EOP rate for a generic observing session from 18h00 UT to 18h00 UT.

EOP representation differs from the representation in other space geodetic observation techniques (the standard representation is from 0h00 UT to 24h00 UT), the parameterization of the EOP in this project is done continuously piecewise linear in a six-hour interval. The corresponding EOP offsets refer to the epochs 18h00 UT – 0h00 UT – 6h00 UT – 12h00 UT – 18h00 UT (Figure 4), so that the resulting estimates can be clearly compared with the estimates of other space geodetic observation techniques.

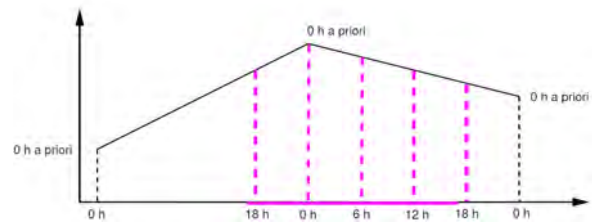

Fig. 4 Six-hourly intervals for a generic observing session from 18h00 UT to 18h00 UT.

In order to validate the estimated EOP, we calculated a time series based on 52 IVS-R1 sessions in 2020 with six-hour piecewise linear offsets. In this case, four different IVS Analysis Centers provided pre-analyzed normal equations included in the SINEX file format. Because of the cross-day observation interval, we estimated the EOP offsets of all individual contributions,

Table 1 Staff members of the BKG/DGFI-TUM Combination Center.

Name	Affiliation	Function	E-Mail
Sabine Bachmann	BKG	Combination procedure development	sabine.bachmann@bkg.bund.de
Hendrik Hellmers	BKG	ITRF2020; Combination procedure	hendrik.hellmers@bkg.bund.de
Sadegh Modiri	BKG	ITRF2020; Operational combination	sadegh.modiri@bkg.bund.de
Sandra Schneider-Leck	BKG	Operational combination	sandra.schneider-leck@bkg.bund.de
Sonja Geist	BKG	IVS CC Web pages	sonja.geist@bkg.bund.de
Daniela Thaller	BKG	Scientific and strategic advice	daniela.thaller@bkg.bund.de
Mathis Bloßfeld	DGFI-TUM	DOGS_CS; Combination strategies	mathis.blossfeld@tum.de

as well as a combined solution at times 12h00 UT – 18h00 UT – 0h00 UT – 6h00 UT – 12h00 UT – 18h00 UT. The calculation of the combination was carried out by the IVS Combination Center at BKG by applying equivalent procedures as for ITRF2020 [4]. Because the nutation and the pole coordinates cannot be determined independently of each other with this parameter setup, we used conditions in the form of known sine periods for the celestial pole offsets.

For investigating the accuracy of Polar Motion and dUT1, the differences were determined with respect to the IERS 14 C04 time series, which is used as a reference. The EOP epochs were interpolated within the corresponding days, accordingly.

**Fig. 5** WRMS of six-hourly dUT1 estimates compared to IERS 14 C04.

Figure 5 shows the resulting Weighted Root Mean Square values of dUT1 at the corresponding epochs of the day. Because the first day is outside the observation interval, the resulting deviation from the reference series is not representative. The other estimates are in the range of 15 μ s. In this case, the combination solution shows slightly lower WRMS values. Although the deviations per time of day are slightly higher than the deviations with the conventional off-

set/drift representation (a WRMS value of up to 10 μ s can be expected for the dUT1), the resolution of the ERP estimate can be increased by the six-hour parameterization. Consequently, consistent comparisons with other space geodetic observation techniques are possible. Thus, the use of continuous piecewise linear estimation is the next step in VLBI analysis. Moreover, it has been demonstrated that it is possible to obtain a correct representation of ERP rates for observation intervals extending beyond midnight.

3 Staff

The list of the staff members of the BKG/DGFI-TUM Combination Center in 2021 and 2022 is given in Table 1.

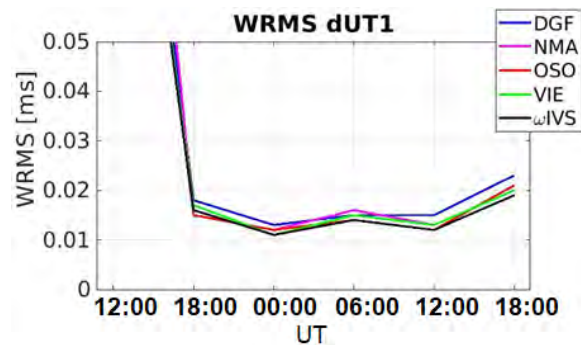
4 Current Status

By the end of 2022, 12 IVS ACs (ASI, BKG, DGFI-TUM, GFZ, GSFC, IAA, IGE, NMA, OPA, OSO, USNO, and VIE) contributed regularly to the IVS combined rapid and quarterly products (see [8]). The AC UAV (University of Alicante, Spain) is currently under review and will probably become an IVS Operational AC in the near future. The rapid solutions only contain R1 and R4 sessions, and new data points are added twice a week as soon as the SINEX files of at least four IVS ACs are available. Long-term series are generated quarterly and include all 24-hour sessions since 1984. The quarterly series include long-term EOP, station positions, and velocities. Furthermore, a VLBI TRF is generated and submitted to the IVS Data Centers.

The IVS combined EOP series have been submitted in the new EOP format version 3 since the beginning of 2023.

Several tests of new software versions are in progress to prepare for the transition from the ITRF2014 to the ITRF2020 reference frame. The transition is planned for March 2023.

The results of the combination process are archived by the BKG Data Center. Unfortunately, the IVS Combination Center website [8] has been offline for quite some months now. We are working on its re-establishment, so that the combined rapid EOP series, as well as the results of the quality control of the AC results, will soon be available directly at the website again. Meanwhile, some of this information is accessible also via the IVS Analysis Coordinator website.

5 Future Plans

In 2023 and 2024, the work of the BKG/DGFI-TUM Combination Center will focus on the following aspects:

- Implementation of the new master file format.
- Transition to ITRF2020 in the first months of 2023.
- Investigating the impact of different ITRS realizations (DTRF2020, ITRF2020, and JTRF2020) on the combined EOP.
- Including new ACs into the routine rapid and quarterly combination.
- Improving the combination strategy.
- Re-launch of the IVS Combination Center website.
- Establish EOP predictions based on IVS combined EOP products.

References

1. Bachmann, S., Thaller, D., Roggenbuck, O., Lösler, M., Messerschmitt, L. IVS contribution to ITRF2014. *Journal of Geodesy*, 90(7):631–654, doi:10.1007/s00190-016-0899-4
2. Bachmann, S., Thaller, D.(2016) Adding source positions to the IVS combination—First results. *Journal of Geodesy*, doi:10.1007/s00190-016-0979-5
3. Gerstl, M., Kelm, R., Müller, H., Ehrnsperger, W. (2004) DOGS-CS: Kombination und Lösung großer Gleichungssysteme. Deutsches Geodätisches Forschungsinstitut, MG/01/1995/DGFI
4. Hellmers, H., Modiri, S., Bachmann, S., Thaller, D., Bloßfeld, M., Seitz, M., Gipson, J. Combined IVS Contribution to the ITRF2020. In: International Association of Geodesy Symposia. Springer, Berlin, Heidelberg. https://doi.org/10.1007/1345_2022_170
5. Hellmers, H., Modiri, S., Bachmann, S., Thaller, D., Bloßfeld, M., Seitz, M., Gipson, J. (2023, January). Scale Evaluation of the ITRF2020 Solution. In International VLBI Service for Geodesy and Astrometry 2022 General Meeting Proceedings, Edited by K. Armstrong, D. Behrend, and K. Baver, NASA/CP-20220018789, pp. 237-242.
6. Hellmers, H., Modiri, S., Bachmann, S., Thaller, D., Bloßfeld, M., Seitz, M., Gipson, J. (2022, May). Evaluation of the IVS contribution to the ITRF2020. In EGU General Assembly Conference Abstracts (pp. EGU22-5116).
7. Hase, H., BKG/DGFI Combination Center at Frankfurt, IVS Newsletter 36, 2-3, 2013. <http://ivsec.gsfc.nasa.gov/publications/newsletter/issue36.pdf>.
8. <http://ccivs.bkg.bund.de/> BKG Combination Center website.
9. Nothnagel, A., Böhm, S., Dach, R., Glomsda, M., Hellmers, H., Kirkvik, A.-S., Nilsson, T., Girdiuk, A., Thaller, D. (2023, January). First results of project on six-hourly EOP piecewise linear offset parameterization. In International VLBI Service for Geodesy and Astrometry 2022 General Meeting Proceedings, Edited by K. Armstrong, D. Behrend, and K. Baver, NASA/CP-20220018789, pp. 217-222.
10. Nothnagel, A., Böckmann, S., Artz, T., *Analysis Coordinator Report*, in: *International VLBI Service for Geodesy and Astrometry 2007 Annual Report*, NASA/TP-2008-214162, D. Behrend and K. D. Baver (eds.), 16-17, 2008.
11. Nothnagel, A., Böckmann, S., Artz, T., *Analysis Coordinator Report*, in: *International VLBI Service for Geodesy and Astrometry 2009 Annual Report*, NASA/TP-2010-215860, D. Behrend and K. D. Baver (eds.), 45–47, 2010.
12. Schwegmann, W., Gerstl, M., Heinkelmann, R., BKG/DGFI Combination Center Annual Report 2008, in: *International VLBI Service for Geodesy and Astrometry 2008 Annual Report*, NASA/TP-2009-214183, D. Behrend and K. D. Baver (eds.), 250–252, 2009.
13. Thaller, D., Flohrer, C., Engelhardt, G., Girdiuk, A., Hellmers, H., König, D., Modiri, S., Bachmann, S., Dick, W., Geist, S., Goltz, M., Lengert, L., Schneider-Leck, S., Ullrich, D. (2022): The contributions by BKG to the realization of the global geodetic reference frame. IAG International Symposium on Reference Frames for Applications in Geosciences (REFAG 2022). url: <https://www.refag2022.org/wp-content/uploads/2022/10/78.pdf>.

Matera CGS VLBI Analysis Center

Roberto Lanotte¹, Simona Di Tomaso¹, Giuseppe Bianco²

Abstract This paper reports the VLBI data analysis activities at the Space Geodesy Center (CGS) of the Italian Space Agency (ASI) in Matera, performed from January 2021 through December 2022, and the contributions that the CGS intends to provide in the future as an IVS Analysis Center.

1 General Information

The CGS VLBI Analysis Center is located at the Matera VLBI station, close to the town of Matera in the middle of Italy. The Matera VLBI station became operational at the ASI/CGS in May 1990. Since then, it has been active in the framework of the most important international programs. The CGS, operated by E-GEOS S.p.A. (an ASI/Telespazio company) under an ASI contract, provides full scientific and operational support using the main space geodetic techniques: VLBI, SLR, and GPS. The work presented in this report is carried out by the E-GEOS staff consisting of Roberto Lanotte and Simona Di Tomaso.

2 Activities during the Past Two Years

During 2021–2022, the following activities were performed at CGS:

1. E-GEOS S.p.A., Centro di Geodesia Spaziale
2. Italian Space Agency, Centro di Geodesia Spaziale

CGS Analysis Center

IVS 2021+2022 Biennial Report

- **Global VLBI Solutions asi2021a and asi2022a.** We continued the annual realization of global VLBI solutions. The solutions are named asi2021a and asi2022a and were realized using the CALC/SOLVE software developed at NASA/GSFC. The main and final characteristics of them are:

asi2021a:

- Data span: 1984.01.04–2020.12.29 for a total of 5,113 sessions.
- Estimated Parameters:
 - Celestial Frame: Right ascension and declination as global parameters for 4,791 sources and as local parameters for 435 sources;
 - Terrestrial Frame: Coordinates and velocities for 72 stations as global parameters and coordinates as local parameters for 51 stations;
 - Earth Orientation: X pole, Y pole, UT1, Xp rate, Yp rate, UT1 rate, dX and dY for each session.

asi2022a:

- Data span: 1984.01.04–2021.12.29 for a total of 5,301 sessions.
- Estimated Parameters:
 - Celestial Frame: Right ascension and declination as global parameters for 4,791 sources and as local parameters for 536 sources;
 - Terrestrial Frame: Coordinates and velocities for 72 stations as global parameters and coordinates as local parameters for 50 stations;

- Earth Orientation: X pole, Y pole, UT1, Xp rate, Yp rate, UT1 rate, dX and dY for each session.
- **IVS Tropospheric Products.** Regular submission of tropospheric parameters (wet and total zenith path delays, east and north horizontal gradients) for all VLBI stations observing in the IVS R1 and R4 sessions continued during 2021–2022. Currently, 2,182 sessions have been analyzed and submitted, covering the period from 2002 to 2022. The results are available at the IVS data centers.
- **Daily Solution Files (DSNX).** Regular submission of daily sinex files for the IVS project “Daily EOP + station-coordinates solutions” continued during 2021–2022. All sessions lasting at least 18 hours were analyzed and at the present about 6,450 sessions were submitted to IVS.
- **Software development.** We continued the development of the software “*resolve*.” The main purpose of this software is the visual editing of a VLBI database. One of the reasons that led us to develop this software was to have the capability to work on the output obtained from a run of SOLVE in BATCH mode. We now have used *resolve* to edit approximately 100% of the databases of the daily sinex production.

3 Staff at CGS Contributing to the IVS Analysis Center

- Dr. Giuseppe Bianco, responsible for CGS/ASI (primary scientific/technical contact).
- Dr. Rosa Pacione, responsible for scientific activities, E-GEOS.
- Dr. Roberto Lanotte, geodynamics data analyst, E-GEOS.
- Dr. Simona Di Tomaso, geodynamics data analyst, E-GEOS.

4 Future Plans

- Continue and improve the realization of our global VLBI solution, providing its regular update on time.
- Continue to participate in the IVS analysis projects.

DGFI-TUM Analysis Center

Matthias Glomsda, Manuela Seitz, Detlef Angermann, Michael Gerstl

Abstract This report describes the activities of the DGFI-TUM Analysis Center (AC) in 2021 and 2022. We investigated our own and the combined IVS contribution to the ITRS 2020 realizations and computed several secular terrestrial reference frame (TRF) solutions. One focus of attention was the analysis and integration of the new VLBI Global Observing System (VGOS) broadband measurements. Another one was the reduction of non-tidal loading (NTL) in VLBI (and TRF) analysis.

1 General Information

DGFI-TUM has been serving as an IVS AC since the establishment of the IVS in 1999. Since November 2008, we are an operational AC regularly submitting datum-free normal equations for the rapid turnaround sessions in SINEX format. Since 2008, we are also involved in the BKG/DGFI-TUM Combination Center at the Bundesamt für Kartographie und Geodäsie (BKG) by maintaining the combination software DOGS-CS (DGFI Orbit and Geodetic parameter estimation Software – Combination & Solution).

DGFI-TUM is an institute of the Technische Universität München (TUM) since January 2015 and is located in the city center of Munich, Germany. The research performed at DGFI-TUM covers many different fields of geodesy (e.g., reference systems, satellite altimetry, Earth system modeling) and includes contri-

Deutsches Geodätisches Forschungsinstitut der Technischen Universität München (DGFI-TUM)

DGFI-TUM Analysis Center

IVS 2021+2022 Biennial Report

butions to national and international scientific services and research projects, as well as various functions in scientific organizations (see <http://www.dgfi.tum.de>).

2 Staff

For the last two years, Matthias Glomsda was responsible for the operational IVS analysis and the development of the VLBI analysis software DOGS-RI (Radio Interferometry). He was supported and deputized by Manuela Seitz. Detlef Angermann was the head of the *Reference Systems* research area at DGFI-TUM, to which the IVS AC belongs. Michael Gerstl, the originator of DOGS-RI, retired in 2018 but is still occasionally providing advice. Table 1 lists all VLBI related staff members.

Table 1 Staff members and their main areas of activity.

Name	Tasks
Detlef Angermann	Head of research area <i>Reference Systems</i>
Matthias Glomsda	Operational data analysis; software development
Manuela Seitz	CRF/TRF combination; combination of different space geodetic techniques
Michael Gerstl	Software development; advice

3 Current Status and Activities

Since 2020, the activities of our research area have been dominated by DGFI-TUM's ITRS 2020 re-

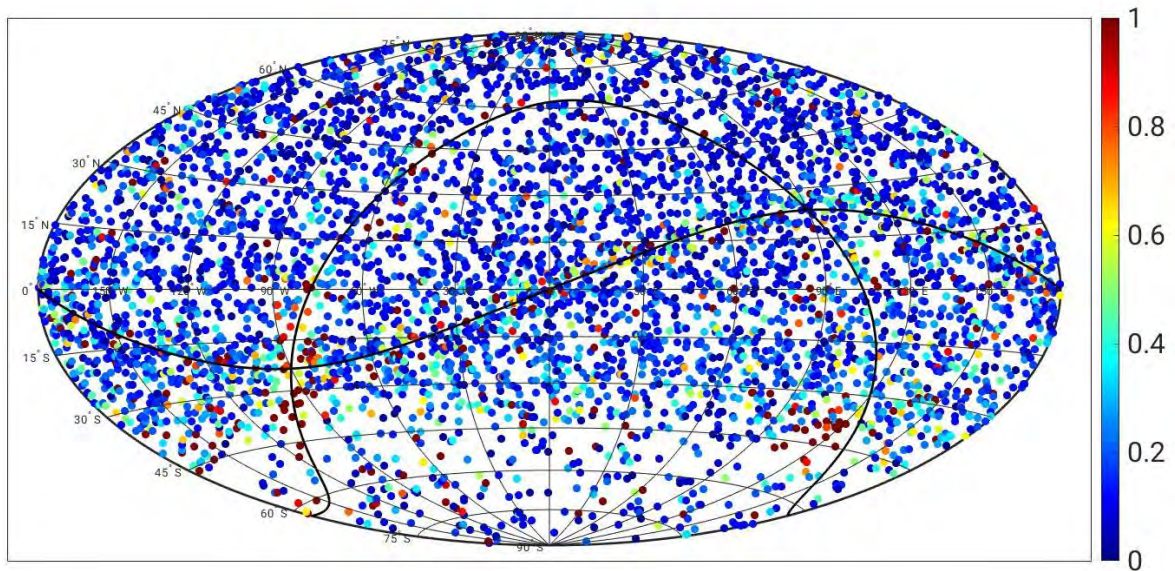

Fig. 1 Geocentric positions and formal errors (in [mas]) of the estimated source coordinates in the basic TRF/CRF solution in [1], i.e., without VGOS data.

alization work. The resulting DTRF2020 [4] will be released in 2023. Regarding VLBI, we analyzed the IVS input data, which was created by the IVS Combination Center. It represents a combination of the distinct AC solutions (including the solution by DGFI-TUM) at the normal equation level, which was performed with DOGS-CS. The explicitly estimated and combined parameters are session-wise station positions and Earth orientation parameters (EOP), and both parameter types are used for the computation of the DTRF2020.

However, the original contributions by the IVS ACs to the ITRS 2020 realizations also contained free source positions for the celestial reference frame (CRF). Hence, we used our solution *dgf2020a* to compute several consistently combined TRF/CRF solutions [1]. For the latter, the EOP were reduced and not explicitly estimated. Furthermore, the source velocities were fixed to the values derived from Galactic aberration, and only the source coordinates at 2015.0 have been estimated (see Figure 1).

The biggest challenge, though, was the inclusion of the new VGOS data. In contrast to the legacy S/X system, VGOS provides delay observations from broadband measurements with a joint ionospheric delay calibration. As a consequence, the legacy and the VGOS antenna networks are separated on principle,

and the source positions might deviate due to the different observation frequencies. To overcome the first issue, *mixed-mode* sessions are introduced, in which VGOS antennas observe in legacy S/X mode together with the legacy antennas. As it turned out, more connecting information is needed. Thus, the DTRF2020 (while fixing the CRF) also makes use of local ties between legacy and VGOS antennas, combines the velocities of such co-located antennas, and incorporates dedicated short baseline measurements between the legacy and VGOS antennas (e.g., at Onsala, Sweden [5]).

We further investigated the new VGOS data by comparing the results of three years of simultaneous legacy and VGOS sessions from 2019 to 2021 [2]. In general, there are fewer antennas per VGOS session, but since these antennas are mostly smaller and faster than their legacy counterparts, they collect more observations per unit time. In addition, the formal errors of the VGOS broadband measurements are usually smaller (compare Figure 2). However, the global distribution of VGOS antennas is poor, since none of them was operating in the Southern hemisphere as of December 2021. Probably as a consequence, we observe mean offsets of about 0.1–0.2 mas in the estimated polar motion parameters w.r.t. the IERS 14 C04 reference series for the VGOS sessions. DUT1, on the

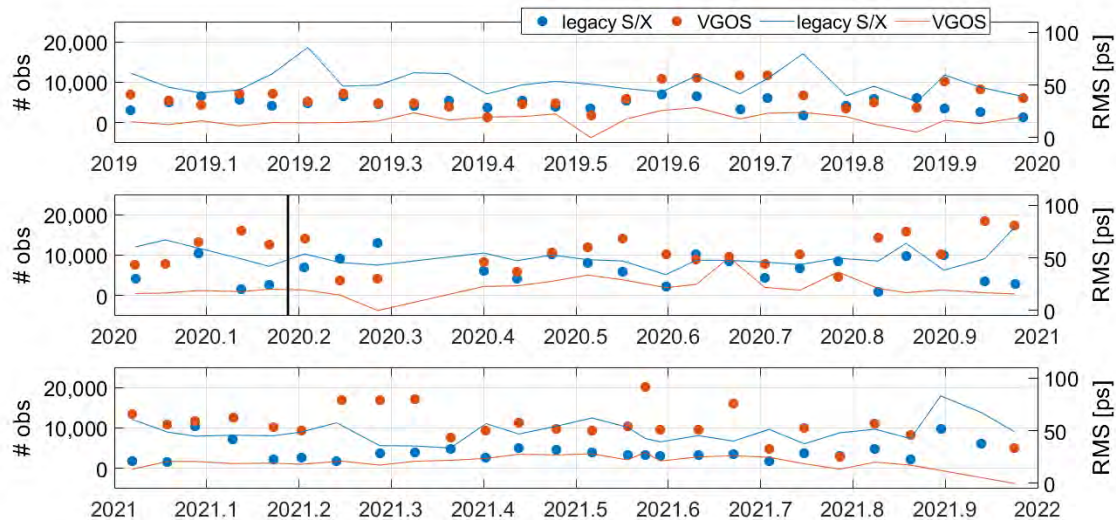

Fig. 2 Number of observations (dots) and RMS of the observation residuals (lines) per simultaneous—yet separately solved—legacy (blue) and VGOS (red) sessions.

other hand, is not noticeably different compared to the legacy results and the C04 series. In our session-wise solutions, we could also not determine a significant difference between the estimated source coordinates with legacy and VGOS observations. The estimation of VGOS antenna velocities still suffers from the short (and sometimes sparse) observation time spans, though.

Finally, we continued our studies on the reduction of NTL in VLBI analysis [3]. We applied NTL at both the observation and the normal equation levels in a secular VLBI-only TRF. The results might provide insights into the application of NTL at the normal equation level in the DTRF2020, albeit the latter represents a combination of all four geodetic space techniques. We found that the impact of NTL is largest for antenna velocities based on short observation time spans and that the results for the antenna motions are very similar for both application levels. The jointly estimated EOP, on the other hand, depend more strongly on the application level and also on the solution type, i.e., single-session vs. secular TRF.

4 Future Plans

A prominent issue w.r.t. the ITRS 2020 realizations is a contingent scale drift in the combined IVS contribution and/or the single AC solutions. We are participating in the corresponding IVS Working Group to investigate this matter.

These ITRS 2020 realizations will give rise to a new operational DGFI-TUM solution *dgf2023a*. Additional empirical gravitational deformation models and a new session naming convention require (albeit small) further software developments.

We finally began to analyze *Intensive* sessions, so that these can be run routinely soon. The same is planned for the increased number of VGOS sessions. The estimated parameters of both session types shall be further compared to and/or combined with the legacy R1/R4 parameters. This includes continuing studies of the connection (combination) of VGOS and legacy networks (observations) for consistent TRF/CRF/EOP solutions.

References

1. M. Glomsda, M. Seitz, M. Bloßfeld, A. Kehm, M. Gerstl, and D. Angermann, "First VLBI-only TRF/CRF solution based on DGFI-TUM data for ITRF2020." In: Rüdiger Haas (Ed.), Proceedings of the 25th EVGA Working Meeting, 2021.
2. M. Glomsda, M. Seitz, and D. Angermann, "Comparison of simultaneous VGOS and legacy VLBI sessions." In: Kyla L. Armstrong, Dirk Behrend, and Karen Baver (Eds.), IVS 2022 General Meeting Proceedings, NASA/CP-20220018789, 2023.
3. M. Glomsda, M. Seitz, M. Bloßfeld, and F. Seitz, "Effects of non-tidal loading applied in VLBI-only terrestrial reference frames," submitted.
4. M. Seitz, D. Angermann, M. Bloßfeld, M. Glomsda, S. Rudenko, and J. Zeitlhöfler, "DTRF2020: the ITRS 2020 realization of DGFI-TUM." IAG International Symposium on Reference Frames for Applications in Geosciences (REFAG), 2022.
5. E. Varenius, R. Haas, and T. Nilsson, "Short-baseline interferometry local-tie experiments at the Onsala Space Observatory." Journal of Geodesy, Vol. 95(54), 2021.

ETHZ Analysis Center Report

Matthias Schartner¹, Grzegorz Kłopotek¹, Benedikt Soja¹

Abstract The new Associate Analysis Center at ETH Zurich was established in 2020 as a part of the Chair of Space Geodesy. Its current activities include the investigation of the performance of IVS observing programs, especially those assigned to the Operation Center DACH. Furthermore, it conducts large-scale simulation studies on various topics, spanning from current VLBI Intensives to future VGOS observations.

1 General Information

With the establishment of the Chair of Space Geodesy at ETH Zurich and the resulting migration of VLBI experts, a new Associate Analysis Center (AC) was established at ETH Zurich (ETHZ) in October 2020. Besides the application of Machine Learning for geodesy, current research topics contain a variety of VLBI-related activities, including VLBI scheduling, simulation, analysis, observations of satellites, and, recently, investigations of spaceborne radio frequency interference (RFI). Table 1 lists the staff members in conjunction with their respective activities.

Table 1 Members of the AC ETHZ and their activities.

Name	Function
Benedikt Soja	coordination
Matthias Schartner	simulations, analysis
Grzegorz Kłopotek	analysis, satellite observations

ETH Zurich

ETHZ Analysis Center

IVS 2021+2022 Biennial Report

2 Activities during the Past Year

The primary focus of the AC during the past two years was on conducting simulation studies as well as quality control of existing observing programs.

Analysis Results: IVS-INT-2 / IVS-INT-3

As a part of our quality control for the S/X Intensives scheduled at the Operation Center DACH, the IVS-INT-2 and IVS-INT-3 observing programs were investigated, with the results published in [6]. Part of this study included an investigation of the UT1-UTC estimates obtained from the IVS-INT-2 sessions, grouped per baseline and AC. It was revealed that biases of some μs are present w.r.t. the JPL EOP2 solution as listed in Table 2. Similarly, a comparison with the

Table 2 Bias and standard deviation (std) w.r.t. JPL EOP2 solution per AC and IVS-INT-2 baseline (from [6]).

	bias μs			std μs		
	IsWz	KkWz	MkWz	IsWz	KkWz	MkWz
BKG	2.5	-7.3	1.9	18.2	23.4	14.6
GSF	-7.3	-9.0	-2.5	35.3	20.8	12.4
GSI	6.1	-5.7	-0.5	36.5	25.6	14.9
IAA	6.5	-12.5	2.5	39.0	28.4	24.0
OPA	-22.1	-16.2	-	75.5	15.9	-
USN	15.8	-1.8	-15.1	33.5	22.6	13.4
VIE	-1.7	-5.8	4.8	18.4	21.6	9.7

IERS C04 solution revealed different biases with similar magnitudes. It is assumed that the biases are mostly due to the utilization of different software packages, as well as different a priori information, especially for the station coordinates.

Furthermore, the impact of changes in the scheduling strategy was investigated. By changing the scheduling strategy, the formal errors of the IVS-INT-2 sessions could be improved by 11% for baseline IsWz, 32% for baseline KkWz, and 42% for baseline MkWz [6]. Similar improvements of up to 45% were also achieved for IVS-INT-3 sessions.

Simulation Study: Optimal VLBI Baseline Geometry for UT1-UTC Intensive Observations

Within the work published in [5], the optimal baseline geometry of Intensive sessions was investigated. So far, it was common knowledge that long east-west baselines provide the highest UT1-UTC sensitivity. But it is now revealed that this is only true up to a certain length, as well as for baselines located at mid-latitudes. Baselines close to the equator suffer from a reduced spread of the right ascension angle of the visible sources, resulting in a lack of variety in the partial derivatives during the least-squares adjustment, while very long baselines suffer from the reduced area of the commonly visible sky. The study investigated a total of 3,000 globally distributed baselines representing all possibilities on a 10×10 degree grid of VGOS-style telescopes. Figure 1 depicts the simulated UT1-UTC accuracy for one station being held at a latitude of 70 degrees, while the other station is placed in each available grid cell. More detailed discussions of the obtained results, as well as results for reference stations at other latitudes, are available in [5].

Simulation Study: Bridging Astronomical, Astrometric, and Geodetic Scheduling for VGOS

Within the VGOS technical committee source structure subgroup, simulation studies regarding an improved VGOS scheduling approach for VGOS were conducted. Within these studies, the VGOS networks of VO1203 (seven stations) and VO1119 (nine stations) were investigated. The simulated repeatability values based on the actual geodetic schedule (g) were compared with a new source-centric scheduling approach (a2–a7). The new source-centric scheduling approach aims at a better distribution of scans among sources, in particular, allowing for better imaging performance. The approach was tested for different minimum

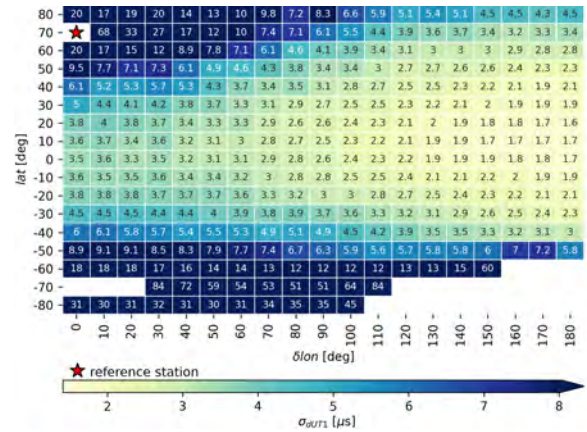

Fig. 1 The performance of every investigated baseline in terms of standard deviation σ_{dUT1} . One station with a latitude of 70 degrees is fixed as the reference station, highlighted by a red star. The second station forming the investigated baseline is placed in the other grid cells. The average dUT1 precision on the corresponding baseline is color-coded and noted in each cell. White areas mark baselines that did not provide sensible results in the analysis. (Modified from [5])

numbers of stations per scan (noted as the number in a2–a7) because the minimum number of stations per scan and the resulting subnetting is one of the main differences between geodetic and astronomical VLBI scheduling. The schedules were analyzed based on Monte Carlo simulations to obtain their geodetic and astrometric performance. Furthermore, two independent imaging pipelines were utilized to assess the expected astronomical imaging potential. One pipeline is based on investigating the dynamic range of the simulated maps, based on [3], while the other pipeline assessed the performance based on the NRMSE metric [2]. It is revealed that the source-centric scheduling strategy not only significantly improves the imaging capability (twice the number of sources meet the requirements for successful imaging) as well as the astrometric performance (by a factor of two), but it also does not degrade the geodetic performance at all. In fact, according to the Monte Carlo simulations, small improvements w.r.t. the current scheduling strategy can be seen as well. It is further revealed that a high minimum number of stations per scan degrades the performance due to the reduced common visibility of radio sources in local skies. More details concerning the described simulation results will be available in [7].

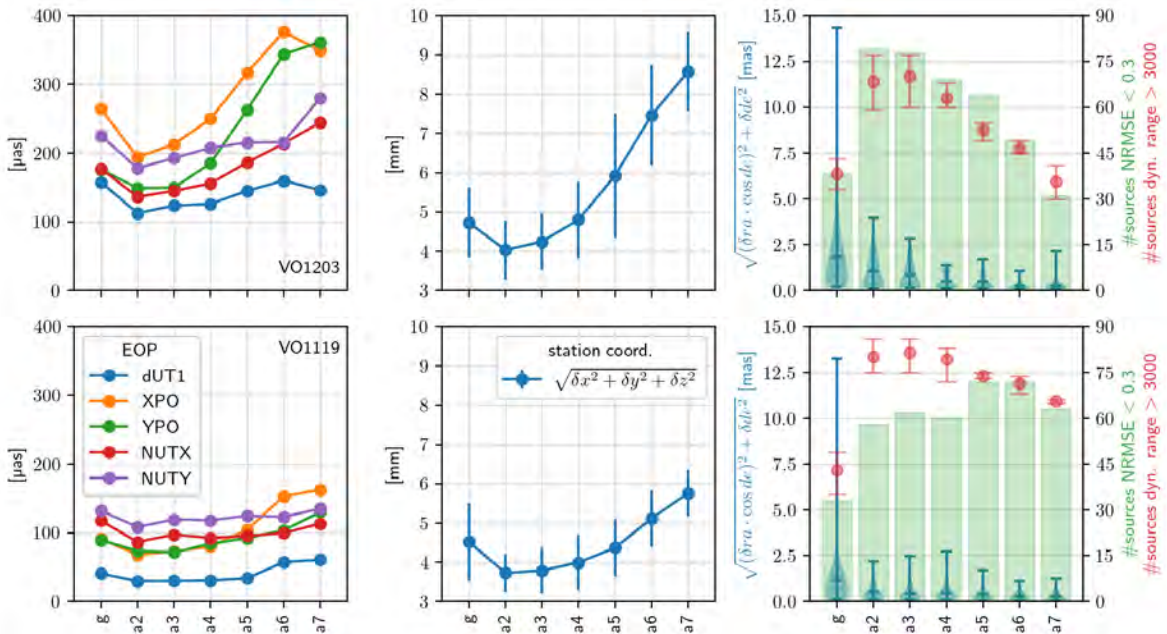

Fig. 2 Session performance for geodetic (g) and source-centric schedules (a2–a7). Top charts: VO1203. Bottom charts: VO1119. Left charts: EOP precision. Middle charts: average station coordinate precision and standard deviation between the telescopes. Right charts, blue bars: spread of source position precision; the horizontal lines mark the minimum, maximum, and median precision, while the shaded blue areas depict the distribution among the sources. Right charts, green wide bars: astronomical performance based on the NRMSE metric. Right charts, red bars: average astronomical performance based on the dynamic range metric per band as well as the minimum and the maximum between bands. From [7].

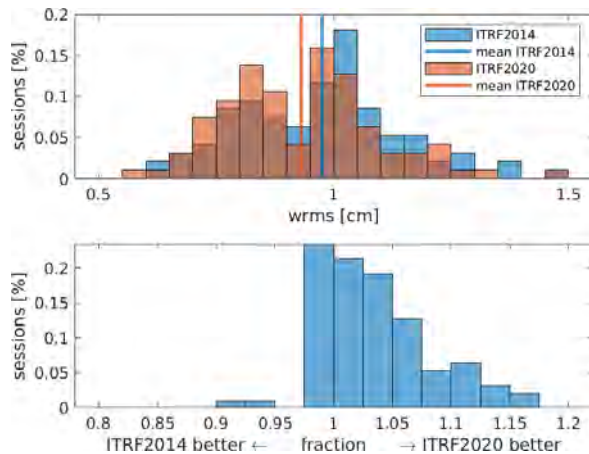

Fig. 3 Preliminary results for automated VLBI analysis: comparison of ITRF2014 and the pre-release ITRF2020 solution.

Automated Analysis

With our automated VLBI analysis pipeline [8] we tested the pre-release of ITRF2020 on IVS-R1 and

IVS-R4 sessions, evaluating the improvement w.r.t. the current release of the International Terrestrial Reference Frame (ITRF). Figure 3 depicts the weighted root mean squared (WRMS) value of residuals obtained from the analysis.

With fixed station coordinates, a clear improvement of ITRF2020 w.r.t. ITRF2014 can be identified. Within the analysis, clock breaks were automatically identified and resolved, and cable cal data were automatically verified. But it should be noted that the automated VLBI analysis pipeline is still in a preliminary state of development, see Section 4. Currently, development is on hold and will be resumed as soon as more resources are available.

3 Current Status

Within the AC ETHZ, we are utilizing the analysis software packages *VieVS* [1] and *vSolve* for analysis and *VieSched++* [4] for simulation studies. A significant fraction of the AC ETHZ activities is related to qual-

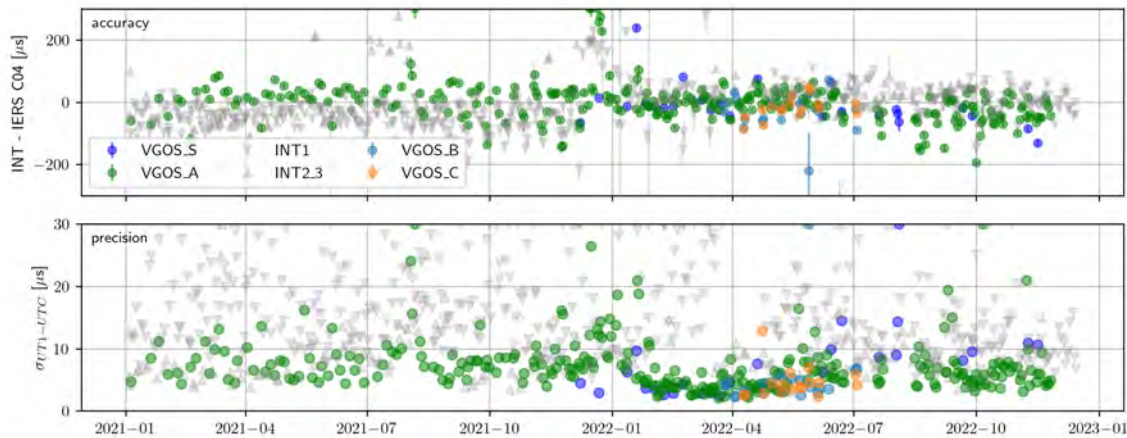

Fig. 4 VLBI Intensive accuracy w.r.t. IERS C04 (top) and precision (bottom) obtained from the official analysis reports for quality control.

ity control of the observing programs scheduled at the Operation Center DACH. Within this activity, the solutions from the official analysis reports, as well as from other ACs are investigated and compared. New simulation studies are planned as well.

Quality Control

The AC ETHZ regularly compares the UT1-UTC performance from various observing programs based on the official IVS analysis reports, in particular, to check the performance of the VGOS-INT-B, VGOS-INT-C, VGOS-INT-S, IVS-INT-2, and IVS-INT-3 observing programs. Based on Figure 4, it can be seen that the performance of the VGOS Intensives is significantly better than the S/X Intensives. With the help of these investigations, problems at individual observing programs can be identified and resolved. For example, the VGOS-INT-S sessions had a period of lower performance during the summer of 2022. The performance degradation was swiftly identified and discussed with the stations and correlators. A hardware problem was identified and resolved based on these activities.

Simulation Study: Impact of Spaceborne Radio Frequency Interference (RFI)

Currently, the impact of satellite mega-constellations such as Starlink, OneWeb, or Amazon Kuiper are being investigated. In this context, future mega-constellations with up to 30,000 satellites and potential

future VGOS networks are being simulated. Within the simulations, it is assumed that the emitted signals from satellites saturate the antenna receivers if an observation is scheduled in the direction of the satellite, rendering the observations useless during analysis. Simulated repeatability values of the estimated geodetic parameters are calculated for three scenarios: (A) a situation with satellite mega-constellations, (B) a situation without satellite mega-constellations, and (C) a situation with satellite mega-constellations but also with active avoidance of observations close to interfering satellites during scheduling. Potential threats of satellite mega-constellations can be assessed by comparing (A) with (B). By comparing (A) with (C) the expected degradation due to the additional scheduling constraints can be evaluated. Comparing (B) with (C) highlights the necessity of active satellite avoidance during scheduling. Preliminary results reveal that active satellite avoidance during scheduling has the potential to reduce the impact of potentially harmful satellite RFI, especially for smaller mega-constellations. But additional measures such as the development and implementation of hardware filters at the receivers might also be an essential mitigation tool.

4 Future Plans

In the future, it is planned to resume our work on the development of an automated analysis pipeline [8]. It should run as a Python-based framework, similar to the

fully automated scheduling software used at the Operation Center DACH, providing an interface to existing analysis software packages. The idea is that the framework executes the underlying analysis software package and parses the analysis output. After analyzing the output, problems such as clock breaks should be detected and resolved.

Acknowledgments

We acknowledge TU Wien for developing the VLBI analysis software package VieVS and NVI Inc./GSFC for developing vSolve.

References

1. J. Böhm, S. Böhm, J. Boisits, et al. Vienna VLBI and Satellite Software (VieVS) for Geodesy and Astrometry, *Publications of the Astronomical Society of the Pacific*, Vol. 130(986), 044503, (2018). <https://doi.org/10.1088/1538-3873/aaa22b>.
2. A.A. Chael, M.D. Johnson, K.L. Bouman, et al. Interferometric Imaging Directly with Closure Phases and Closure Amplitudes. *The Astrophysical Journal* (Vol. 857, Issue 1, p. 23) (2018). <https://doi.org/10.3847/1538-4357/aab6a8>
3. A. Collioud, P. Charlot. VLBI2010 Imaging and Structure Correction Impact. IVS 2012 General Meeting Proceedings, pp. 47–51, edited by D. Behrend and K. Baver, NASA/CP-2012-217504, (2012). <https://ivscc.gsfc.nasa.gov/publications/gm2012/collioud.pdf>
4. M. Schartner, J. Böhm. VieSched++: A new VLBI scheduling software for geodesy and astrometry, *Publications of the Astronomical Society of the Pacific*, 131(1002), ab1820 (2019). <https://doi.org/10.1088/1538-3873/ab1820>
5. M. Schartner, L. Kern, A. Nothnagel, et al. Optimal VLBI baseline geometry for UT1-UTC Intensive observations. *J Geod* 95, 75 (2021). <https://doi.org/10.1007/s00190-021-01530-8>
6. M. Schartner, C. Plötz, B. Soja. Improvements and comparison of VLBI INT2 and INT3 session performance. *J Geod* 96, 26 (2022). <https://doi.org/10.1007/s00190-022-01621-0>
7. M. Schartner, A. Collioud, P. Charlot, et al. Bridging Astronomical, Astrometric and Geodetic Scheduling for VGOS. *J Geod* (in press 2023).
8. B. Soja, M. Schartner, G. Kłopotek. The New IVS Associate Analysis Center at ETH Zurich. Poster at *25th European VLBI Group for Geodesy and Astrometry Working Meeting* (2021).

GFZ Analysis Center 2021–2022 Report

Robert Heinkelmann¹, Susanne Glaser¹, Harald Schuh^{1,2}, Kyriakos Balidakis¹, Georg Beyerle¹, Sujata Dhar¹, Chaiyaporn Kitpracha^{1,2}, Susanne Lunz², Nicat Mammadaliyev^{1,2}, Shashank Parthak², Partist Poopat², Shrishail Subash Raut^{1,2}, Patrick Schreiner¹, Jungang Wang¹, Minghui Xu¹

Abstract This report provides general information and a component description of the IVS Analysis Center at GFZ. Current activities and recent results are described, planned future work is outlined.

1 General Information

The Helmholtz Centre Potsdam, GFZ German Research Centre for Geosciences is the national research center for Earth sciences in Germany. Within Department 1 “Geodesy,” Section 1.1 “Space Geodetic Techniques” the Working Group “Geodetic and astrometric VLBI,” led by Robert Heinkelmann, was established in late 2012. The VLBI group is an Associate Analysis Center (AC) of IVS. Within department 1 it closely co-operates with the recently formed Working Group “Combination of Space Geodetic Techniques” led by Susanne Glaser.

2 Activities during the Past Two Years

Within our activities of supporting ITRF realizations, we analyzed all (6,516 X/S and 38 VGOS) sessions listed by the IVS for inclusion in ITRF2020, utilizing GFZ’s analysis software tool PORT, the Potsdam Open Source Radio Interferometry Tool [16]. Based

1. Helmholtz Centre Potsdam, GFZ German Research Centre for Geosciences

2. Technische Universität Berlin, Chair of Satellite Geodesy

GFZ Analysis Center

IVS 2021+2022 Biennial Report



Fig. 1 Members of the GFZ Working Groups “Geodetic and astrometric VLBI” and “Combination of Space Geodetic Techniques” in June 2022. (S. Glaser not pictured in the photograph.)

on the single-band correlation quality codes, selected ionosphere-free multi-band group delays were calculated, employing information nested within the—at the time of analysis—latest version of the vgosDB dataset produced by GSFC. An independent analysis was carried out for the identification of clock breaks (both true and apparent mainly due to erroneous cable-cal, phase-cal, or in situ barometer records), set-up of baseline offsets, re-weighting of observations in a baseline-, station-, and AGN-dependent manner, identification of observations that do not agree with the deterministic and stochastic models adopted (outliers), as well as selection of stations and AGN that participated in the datum definition. Our SINEX includes two normal equation systems featuring station and AGN coordinates as well as the full set of EOP and ERP rates, where the displacement effects of non-tidal atmospheric load-

ing were or were not mitigated, employing in-house models developed at the GFZ. New models were implemented for pole tidal loading, galactic aberration, antenna gravitational deformation, and high-frequency Earth rotation variations. For stations with poor observation geometry the set-up of piece-wise linear parameters, such as atmospheric delay and clock coefficients, was modified, in order to reduce the impact of the stochastic constraints adopted. Our contribution to ITRF2020 (solution code ‘gfz2020b’) is publicly available in SINEX format.

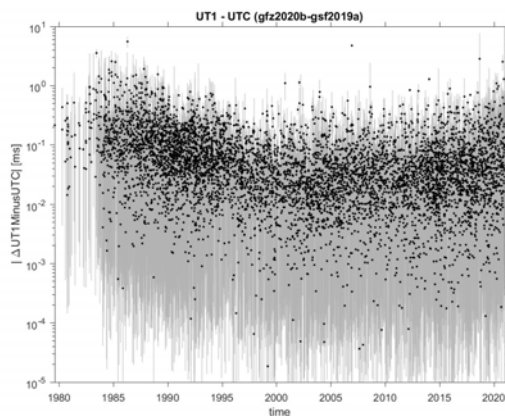

Fig. 2 Comparison of two estimates of UT1–UTC, one derived from GFZ’s contribution to ITRF2020 (‘gfz2020b’), the other extracted from GSFC’s data set (‘gsf2019a’). The black dots mark the modulus of the difference, the uncertainties of the difference are plotted as grey lines.

Based on actual VGOS observations, we demonstrated that the instrumental noise level in VGOS observations is only about 2 ps, one order of magnitude better than that in the typical legacy observations, and the effects of source structure are on average about 20 ps [21].

Xu et al. (2021b) [22] have, for the first time, successfully derived high-quality structure maps from VGOS observations through a technique of closure imaging that overcomes the problem of missing antenna calibration information. The closure imaging is now done routinely for VGOS observations through pipelines. The effects of source structure in VGOS observations are better understood through these maps.

A simulation study, performed to investigate the impacts of image alignment over frequency for VGOS

and new methods, including ones using phase delays, were developed to solve this problem [24]. The differences in radio source positions, estimated from VLBI observations and measured by Gaia, are investigated and radio source structure is found to be one of the major factors contributing to these differences [23].

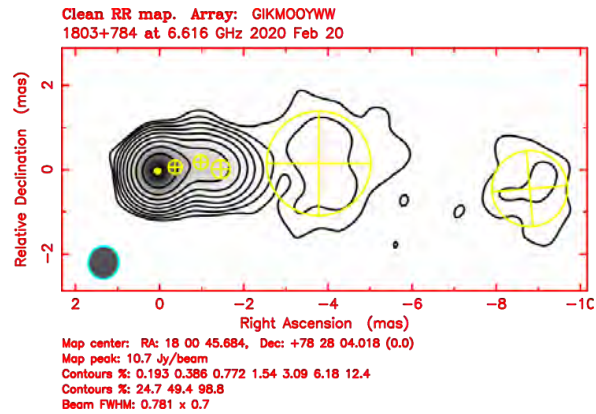

Fig. 3 Image of source structure for source 1803+784 at 6.6 GHz that was obtained from VGOS session VO0051 (20 Feb 2020). The six Gaussian components shown as yellow ellipses were determined by model fitting in DIFMAP.

Baseline vector repeatability at the sub-mm level was obtained based on an analysis of phase delays of the very short baseline WETTZ13N–WETTZELL from 93 experiments of the legacy VLBI, as shown in Figure 4 [25].

An important part of GFZ’s research activities focuses on the exploitation of VLBI observations for comparison and external validation with other space geodetic techniques. In Männel et al. (2021) [11], zenith total delays (ZTDs) from VLBI data analyses at the stations NYALES20 and NYALE13S were used for comparison to GNSS during the MOSAiC expedition. Overall, there is a good agreement between the ZTDs from VLBI and those derived from GNSS observations aboard RV “Polarstern” and at the IGS station NYA2.

Simulations and combinations of all four space-geodetic techniques, including VLBI, to a space-tie satellite were performed within the project GGOS-SIM-2 (“Simulation of the Global Geodetic Observing System”), funded by the German Research Foundation. All techniques were combined via co-location in space for six different space-tie satellite scenarios [15]. VLBI observations of satellites carrying VLBI transmitter

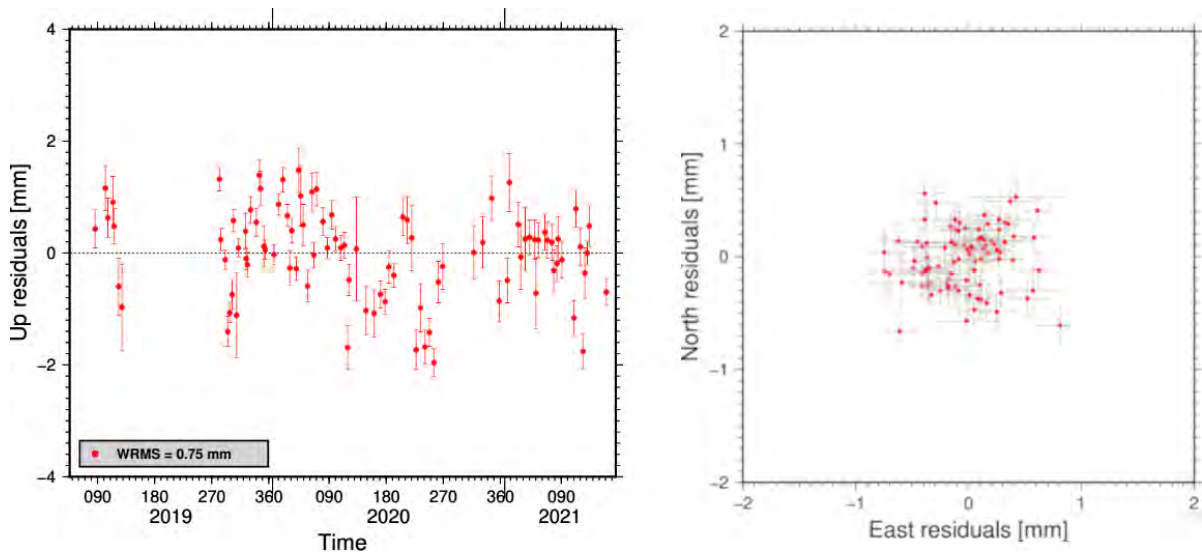

Fig. 4 Residuals of the estimated coordinates of antenna WETTZ13N from phase delays of the baseline WETTZ13N–WETTZELL in 93 VLBI experiments [25]. Left: up component. Right: north component vs. east component.

payloads allow to access the geocenter of the Earth [10]. We also contributed to the co-location in space satellite proposal GENESIS, which recently was approved by ESA [1, 6, 7]. In the framework of the DFG-funded project NextGNSS4GGOS, a VLBI transmitter as a new type of observation for next-generation GNSS satellites was simulated [14].

For the purpose of realizing consistent TRF, CRF, and EOP, we implemented the multi-technique integrated processing modules in the Positioning And Navigation Data Analyst (PANDA) platform, which can now process GNSS, VLBI, and SLR observations [17]. Based on the platform, we demonstrated that applying tropospheric ties improves the VLBI network stability and EOP estimates in CONT05–CONT17 sessions [18]. We also demonstrated that UT1–UTC estimates in the Intensive sessions are improved by tropospheric ties [19]. Moreover, the determination of CRF also benefits from the integrated GNSS and VLBI solutions [20].

To explore the potential of atmospheric ties being used in addition to local/global/space ties in the multi-technique combination, an IAG Joint Working Group (JWG 1.3) was established by R. Heinkelmann in 2015. In the current IAG term (2019–2023) K. Balidakis and D. Thaller (BKG) have taken over the responsibility for the JWG “Intra- and Inter-Technique Atmospheric Ties.”

At GFZ we have studied the intra- and inter-technique differences mainly induced by varying frequency, position, and the observing system. By employing simulated observations we performed a multi-technique combination, utilizing NWM-derived atmospheric ties. The benefit of estimating common tropospheric parameters for co-located VLBI radio telescopes utilizing atmospheric ties was explored by Kitpracha et al. (2022a) [8]. The study demonstrates the potential of using atmospheric ties in aiding a datum transfer between two VLBI parallel networks during CONT17. The impact of tropospheric tie models and instrumental biases on atmospheric ties was investigated in Kitpracha et al. (2022b) [9]. This study conducted a dedicated GNSS co-location site experiment using various GNSS antennas to investigate instrumental biases and it proposed a calibration method.

In order to fulfill operational and scientific user requirements on low-latency information of Earth’s orientation in space, we have investigated and used machine learning (ML) algorithms to predict the EOP. These algorithms make data driven predictions based on pattern recognition and computation learning on the data. The ML algorithms were combined with the filter-based approach to capture the stochastic seasonal behavior of EOP time series. The geophysical phenomenon correlated to EOP were also incorporated in

the prediction algorithm for a better and robust prediction [3, 4].

During the reporting period simulation studies were used to obtain empirical results about the performance of new VLBI stations and observation strategies in India. Specifically, the impact on the geodetic parameters, such as EOP, TRF coordinates, and CRF coordinates, were studied. These geodetic parameters are estimated from the simulated VLBI observations that are generated using scheduling, simulation, and analysis. Then, the results are compared for studying the impact of the new strategy. The primary metric of comparison is the mean formal error or baseline length repeatability. We used this technique to study the favorable locations for the addition of new VGOS antennas in India. The impact of additional antennas was studied with respect to the current and future IVS networks for a comprehensive assessment. To make the assessment more realistic, local environmental conditions of the new antenna locations were also incorporated in the study. These environmental conditions were considered based on their effect on the quantity and quality of the VLBI observations. For this, a weighted scoring model was developed with the scores and weights based on the probable impact and occurrence frequency of disrupting environmental factors, respectively. This approach will avoid the possibility of new VLBI antennas ending up in an unfavorable location and underperforming substantially in terms of the expected improvement of geodetic parameters as determined from the simulation study. Thus, it would help to mark the high performing favorable locations for the new VLBI establishment. The results show that VGOS antennas at favorable locations in India outperform other locations by a factor of 1.1 to 5.0 in improvement percentage of derived geodetic parameters [2, 5].

Finally, we investigated the influence of El Niño-Southern Oscillation (ENSO) on LOD using the Wavelet Coherence method for the three major El Niño events in 1982, 1997, and 2015. This method also provides phase information. For details see Raut et al. (2021) [12]. In addition, Raut et al. (2022a) [13] evaluated and compared dUT1 from various networks (e.g., VGOS, legacy S/X, and three different types of Intensive sessions) during the CONT17 campaign.

3 Current Status and Future Plans

In late 2022, project COCAT “Combination of Space Geodetic Observations with Clock Ties and Atmospheric Ties” (PI K. Balidakis, co-PI H. Schuh) was approved within the DFG research unit TIME (spokesperson Professor Ulrich Schreiber, TU Munich). Work within COCAT builds upon advances in numerical weather prediction as well as in precise timekeeping and synchronization between frequency standards realized by time coherence observables, and will be directed towards the combination of VLBI, GNSS, and SLR employing atmospheric and clock ties in addition to local and global ties, at the observation equation level within a single software package. Within the same DFG research unit the project “Novel clock technologies for combination on ground and in space: real data and simulation” (PIs are Manuela Seitz, DGFI-TUM and Susanne Glaser, GFZ) also received funding approval and will investigate the impact of a common clock and a common reference point on the combined solution, the global terrestrial reference frame.

A European Research Council (ERC) starting grant has been awarded to Minghui Xu. The project is called “Astrogeodesy.” It aims to develop a new data processing strategy for VGOS and will investigate source structure effects. A new group will be established at the GFZ in 2023 with the support of this project.

As already mentioned, PORT is GFZ’s VLBI analysis software package and is routinely employed for the timely processing of VLBI sessions and post-processing activities. The estimation procedures take into account all relevant data analysis models and conventions that are recommended by the IVS for routine VLBI single-session processing. PORT constitutes a framework for research and development activities within the VLBI Working Group and is part of the tool set employed in educating young researchers at GFZ. The current source base is open-source, licensed under the terms of the GNU General Public License and available for download from GFZ’s GitLab server. Future plans include code refactoring efforts to clarify procedure interfaces, improve modularization and readability, as well as support for Microsoft Windows® and MacOS® operating systems. Additional development resources will be devoted to improving the PORT installation and its documentation.

Acknowledgements

Part of the work described in this report is supported by the German Research Foundation (Deutsche Forschungsgemeinschaft, DFG) within the projects GGOS-SIM-2 (Simulation of the Global Geodetic Observing System, grant number SCHU 1103/8-2), NextGNSS4GGOS (Next generation GNSS constellations for GGOS-compliant geodetic solutions, grant number GL 1028/1-1), and AGORA (Alignment of Gaia optical and radio reference frames).

References

1. Delva P., Altamimi Z., Blazquez A., Blossfeld M., Böhm J., Bonnefond P., Boy J.-P., Bruinsma S., Bury G., Chatzinikos M., Couhert A., Courde C., Enderle W., Exertier P., Dach R., Dehant V., Dell’Agnello S., Elgered G., Glaser S., Haas R., Huang W., Hugentobler U., Jäggi A., Karatekin O., Lemoine F., Le Poncin-Lafitte Ch., Lunz S., Männel B., Mercier F., Metivier L., Meyssignac B., Müller J., Nothnagel A., Perosanz F., Riethbroek R., Rothacher M., Sert H., Sosnica K., Testani P., Ventura-Traveset J., Wautelet G., Zajdel R. (2022): GENESIS: Co-location of Geodetic Techniques in Space, Earth Planets and Space, doi: 10.1186/s40623-022-01752-w
2. Dhar, S., Glaser, S., Heinkelmann, R., Schuh, H., Nagara-jan, B., Dikshit, O., (2022a): Selection of favorable locations for VGOS in India. Proceedings of International VLBI Service General Meeting, 27–30 April, 2022.
3. Dhar, S., Heinkelmann, R., Glaser, S., Schuh, H., Nagara-jan, B., Dikshit, O. (2022b): Effect of future intensives on short term UT1 predictions. Committee on Space Research (COSPAR) 2022, Athens, Greece, 16-24 July 2022.
4. Dhar, S., Pathak, S., Heinkelmann, R., Belda, S., Schuh, H., and Balasubramanian, N. (2022c): Prediction of UT1-UTC by machine learning techniques, EGU General Assembly 2022, Vienna, Austria, 23–27 May 2022, EGU22-12091, doi: 10.5194/egusphere-egu22-12091, 2022.
5. Dhar, S., Glaser, S., Heinkelmann, R., Schuh, H., Nagara-jan, B., Dikshit, O., (2023): Favorable locations for new VGOS Antennas in India depending on the assessment of geodetic parameters and environmental factors. Earth, Planets and Space. in review. doi: 10.21203/rs.3.rs-2129275/v1
6. Glaser, S., Schreiner, P., Mammadaliyev, N., König, R., Schuh, H. (2022): Co-location in space simulations, GENESIS-1 Online Workshop, Co-location of Geodetic Techniques in Space, April 26, 2022, genesis-1.sciencesconf.org/resource/page/id/2
7. Heinkelmann, R., Lunz, S., Glaser, S. et al. (2022): User requirements for ICRF applications of a co-location satellite, GENESIS-1 Online Workshop, Co-location of Geodetic Techniques in Space, April 26, 2022, genesis-1.sciencesconf.org/resource/page/id/2
8. Kitpracha, C., Nilsson, T., Heinkelmann, R., Balidakis, K., Modiri, S., and Schuh, H. (2022a): The impact of estimating common tropospheric parameters for co-located VLBI radio telescopes on geodetic parameters during CONT17. *Advances in Space Research*, 69(9), 3227–3235. doi: 10.1016/j.asr.2022.02.013
9. Kitpracha, C., Heinkelmann, R., Ramatschi, M., Balidakis, K., Männel, B., and Schuh, H. (2022b): Validation of tropospheric ties at the test setup GNSS co-location site in Potsdam, Atmos. Meas. Tech. Discuss. [preprint], in review. doi: 10.5194/amt-2022-238
10. Mammadaliyev, N., Glaser, S., Neumayer, K. H., Schreiner, P., Balidakis, K., König, R., Heinkelmann, R., Schuh, H. (2023): On the potential contribution of VLBI to geocenter realization via satellite observations, *Advances in Space Research*, (under revision)
11. Männel, B., Zus, F., Dick, G., Glaser, S., Semmling, M., Balidakis, K., Wickert, J., Maturilli, M., Dahlke, S., Schuh, H. (2021): GNSS-based water vapor estimation and validation during the MOSAiC expedition. *Atmospheric Measurement Techniques*, 14, 7, 5127-5138. doi: 10.5194/amt-14-5127-2021
12. Raut, S., Modiri, S., Heinkelmann, R., Balidakis, K., Belda, S., Kitpracha, C., Schuh, H. (2021): Investigating the relationship between length of day and El-Niño using wavelet coherence method. *International Association of Geodesy Symposia Series*.
13. Raut, S.; Heinkelmann, R.; Modiri, S.; Belda, S.; Balidakis, K.; Schuh, H. (2022a): Inter-comparison of UT1-UTC from 24-Hour, intensives, and VGOS sessions during CONT17. *Sensors* 2022, 22, 2740. doi: 10.3390/s22072740
14. Raut, S., Glaser, S., Mammadaliyev, N., Schreiner, P. A., König, R., Schuh, H. (2022b): Assessing the potential of VLBI transmitters on next generation GNSS satellites for geodetic products, Abstracts, IAG International Symposium on Reference Frames for Applications in Geosciences (REFAG 2022) (Thessaloniki, Greece 2022), www.refag2022.org/wp-content/uploads/2022/10/23.pdf
15. Schreiner, P., Mammadaliyev, N., Glaser, S., König, R., Neumayer, K. H., Schuh, H. (2022): On how multi-technique co-location in space can contribute to the Global Geodetic Observing System goals (key paper), IAG International Symposium on Reference Frames for Applications in Geosciences (REFAG 2022) (Thessaloniki, Greece 2022), www.refag2022.org/wp-content/uploads/2022/10/REFAG_BOA_2022_31-OCT-2022.pdf
16. H. Schuh, R. Heinkelmann, G. Beyerle, J. M. Anderson, K. Balidakis, S. Belda, S. Dhar, S. Glaser, O. S. Jenie, M. Karbon, C. Kitpracha, P. Küreç Nehbit, L. Liu, S. Lunz, N. Mammadaliyev, S. Modiri, T. J. Nilsson, S. Raut, B. Soja, J. Wang, and M. H. Xu (2021): The Potsdam Open Source Radio Interferometry Tool (PORT), Publications of the Astronomical Society of the Pacific, 133 104503, doi: 10.1088/1538-3873/ac299c
17. Wang, J. (2021): Integrated processing of GNSS and VLBI on the observation level. PhD Thesis, GFZ German Research Centre for Geosciences, Potsdam. doi: 10.48440/GFZ.b103-21079

18. Wang, J., Ge, M., Glaser, S., Balidakis, K., Heinkelmann, R., Schuh, H. (2022a): Impact of Tropospheric Ties on UT1-UTC in GNSS and VLBI Integrated Solution of Intensive Sessions. *Journal of Geophysical Research: Solid Earth*, 127, 11, e2022JB025228, doi: 10.1029/2022JB025228
19. Wang, J., Ge, M., Glaser, S., Balidakis, K., Heinkelmann, R., Schuh, H. (2022b): Improving VLBI analysis by tropospheric ties in GNSS and VLBI integrated processing. *Journal of Geodesy*, 96, 32, doi: 10.1007/s00190-022-01615-y
20. Wang, J., Ge, M., Glaser, S., Balidakis, K., Heinkelmann, R., Schuh, H. (2022c): On the contribution of global, local, and tropospheric ties to TRF and CRF in GNSS and VLBI integrated solution, Abstracts, EGU General Assembly 2022 (Vienna, Austria and Online 2022). doi: 10.5194/egusphere-egu22-6387
21. Xu, M. H., Anderson, J. M., Heinkelmann, R., Lunz S., et al., (2021a): Observable quality assessment of broadband very long baseline interferometry system, *J. Geodesy*, 95, 51. doi: 10.1007/s00190-021-01496-7
22. Xu, M. H., Savolainen, T., Zubko, N., Poutanen, M., et al., (2021b): Imaging VGOS Observations and Investigating Source Structure Effects, *J. Geophys. Res. Solid Earth*, 126, 4. doi: 10.1029/2020JB021238
23. Xu, M. H., Lunz, S., Anderson, J. M., Savolainen, T., et al., (2021c): Evidence of the Gaia-VLBI position differences being related to radio source structure, *Astron. & Astrophys.*, 647, A189. doi: 10.1051/0004-6361/202040168
24. Xu, M. H., Savolainen, T., Anderson J. M., Kareinen N., Zubko N., Lunz S., Schuh H., (2022a): Impacts of the image alignment over frequency for VLBI Global Observing System, *Astron. & Astrophys.* 663, A83. doi: 10.1051/0004-6361/202140840
25. Xu, M. H., Savolainen, T., Bolotin S., Bernhart, S., et al., (2022b): Baseline vector repeatability at the submillimeter level enabled by radio interferometer phase delays of intrasite baselines, submitted to *J. Geophys. Res. Solid Earth*, doi: 10.1002/essoar.10507984.1

GSFC VLBI Analysis Center Report

Karen Bayer^{1,2}, Mario Bérubé^{1,2}, Sergei Bolotin^{1,2}, John Gipson^{1,2}, Nlingi Habana^{2,3}, Frank Lemoine², Daniel MacMillan^{1,2}, Leonid Petrov²

Abstract This report describes the GSFC VLBI Analysis Center and its activities during 2021 and 2022. The GSFC VLBI Analysis Center analyzes all IVS sessions, makes regular IVS submissions of data and analysis products, performs limited scheduling, and performs research and software development aimed at improving the VLBI technique.

1 Introduction

The GSFC VLBI Analysis Center (AC) is located at NASA's Goddard Space Flight Center in Greenbelt, Maryland, USA. It is part of a larger VLBI group which also includes the IVS Coordinating Center, the CORE Operation Center (OC), a Technology Development Center, and a VGOS station. The Analysis Center participates in all phases of geodetic and astrometric VLBI analysis, software development, and research, and it schedules a VGOS Intensive series. The AC supports several services, including the International Mass Loading Service (atmosphere pressure loading, hydrology loading, and nontidal ocean loading), the Network Earth Rotation Service, and the International Path Delay Service (troposphere raytraced delays for VLBI sessions). The AC maintains several important data and information files for the IVS and the larger geodetic community, including VMF1/VMF3 TRP files for every IVS session, various station information files, a

mean gradients file, and a JPL planetary ephemeris file for *Calc/Solve/vSolve*.

2 Staff

The staff consists of two GSFC civil servants and six staff members who work under contract to GSFC. The first civil servant, Dr. Leonid Petrov, is the GSFC VLBI Lead Scientist. He engages in a variety of VLBI research and software development activities. The second civil servant, Dr. Frank Lemoine, participates in the planning, execution, and monitoring of VLBI experiments. He also focuses on the derivation of the ITRF, reducing the systematic error in each of the techniques of Space Geodesy. Five of the contractors work for NVI, Inc. They are Dr. John Gipson (who is the GSFC VLBI Project Manager for NVI, as well as the IVS Analysis Coordinator and an IVS Directing Board member), Karen Bayer, Mario Bérubé, Dr. Sergei Bolotin, and Dr. Daniel MacMillan (now working part time). The final contractor is Dr. Nlingi Habana of Science Systems and Applications, Inc.

The AC hosted six interns in 2021 and 2022. Four came from Sweden's Chalmers University of Technology: Adrian Lundell and Samuel Wagner (remotely, in 2021) and Tuss Anzelius and Ludvig Rodung (2022). The others were Simon Matin (University of New Mexico, 2022) and Joseph Skeens (University of Texas at Austin, 2022).

1. NVI, Inc.

2. NASA Goddard Space Flight Center

3. Science Systems and Applications Inc.

3 Software Development

The GSFC VLBI AC develops and maintains the *Calc/Solve* analysis system, a package of ~ 120 programs and 1.2 million lines of code. The AC released three new versions in 2021 and 2022. Important new *Solve* features include the ability to use the new Post-Seismic Deformation models from ITRF2020, support for source structure in *vgosDB*, increased precision in various a priori files, and the ability to override the default “near” distance in applying pressure loading displacements. Further information is available in each *Calc/Solve* version’s release notes.

Bolotin continued the development of *vSolve* and the *vgosDB* software and utilities, including the following four features. Matrix triangularization calculations in *vSolve* are now done in parallel for speed, using POSIX threads. Bolotin also developed a Java script to simulate interactive analysis of actual observed Intensive sessions, and a comparison of the script’s output to five years of Intensive interactive analysis by analysts (2,494 sessions) gave identical results for half the sessions and scaled dUT1 estimate differences between -1 and $+1$ for 87% of the sessions (Bolotin et al. 2023). Bolotin also updated *vSolve* and the *vgosDB* utilities to handle the new post-2022 master schedule format and IVS session naming convention. Finally, Bolotin replaced third party code in *vSolve* with his own code. The latest *vSolve* code was split into a *vSolve* package and a *libCalc* package that contains the *Calc* source code. These packages are available at <https://sourceforge.net/projects/nusolve> and <https://sourceforge.net/projects/libcalc>, respectively.

Bérubé developed software to finish operational processing after *vSolve* analysis (*APS*). *APS* combines the functions of the earlier *Opa* and *Anl_comments* programs, e.g., generating EOP and SINEX files, submitting *vgosDB*, EOP, and SINEX files to IVS, and generating analysis report templates. Bérubé continued to maintain the *Vget* script, which downloads and pre-processes new sessions.

Gipson continued development of *SimpleSimul*, a simulation program. This program can compare the performance of different networks, and it is used by the CORE Operation Center in developing the Master Schedule. It can also be used to compare different schedules using the same network. The CORE OC uses

SimpleSimul in this fashion to schedule some Intensive sessions.

Habana and Petrov began to develop a software package, *ATP*, to study the baseline telemetry metrics at NASA-managed VLBI stations. This study involves running weekend-long single-dish experiments at each station in stow position, transforming the log file to an ASCII antenna calibration (.anc) file with the *vSolve log2ant* routine, and converting the .anc file to a binary format (.bnc) file. Then scan averages and their respective root mean errors are computed and written back to ASCII format. Although the *ATP* library extracts all telemetry data from the log file, the statistical analysis is only done on the Tsys, phase calibration, and formatter clock difference data thus far. It will be expanded to include the SEFD data.

Five interns developed software. Anzelius and Roding developed Python scripts to generate source-flux models from source images. Lundell developed Python scripts to compute the Helmert transformation between two reference frames. Skeens wrote a tool to automate the detection of spurious signals in VLBI phase calibration data. Wagner enhanced Python *vgosDB* utilities to make them faster.

4 Analysis Activities

The GSFC VLBI AC analyzes all IVS sessions using the *Calc/Solve/vSolve* system. The AC submitted analyzed databases to IVS for all R1, RV, R&D, AUST, AUG, AOV, AUA, APSG, CRF, CRDS, INT01, INT03, and VGOS sessions. In 2021 and 2022, Bolotin and Baver analyzed approximately 490 S/X and 73 VGOS 24-hour sessions and approximately 944 S/X and 428 VGOS one-hour UT1 sessions when they were initially correlated. This breakdown categorizes the sessions by whether they were primarily S/X or VGOS, but some of the sessions were actually mixed mode. Updated EOP and daily SINEX files were submitted to IVS immediately following analysis. The AC re-analyzed many sessions after the late submission of stations or other circumstances.

Baver used *Calc/Solve* to generate *csolve* quarterly solutions 2021a–2021d, which provided 24-hour global, 24-hour baseline, and Intensive plots and data. She began work on the 2022a solution but placed this on hold while Gipson investigated a slope in the

estimated X-wobble with respect to USNO finals. Petrov used his *Solve* version, *Psolve*, to generate solutions *psolve* 2021a–2021d and 2022a–2022c. Bayer generated auxiliary (e.g., baseline evolution) files for these solutions.

5 Research Activities

EOP and Scale Parameter Comparison: MacMillan compared EOP and scale parameters that were estimated from the CONT17 session involving two legacy networks and a VGOS network (MacMillan 2022). He determined that the biases between EOP estimates from the three networks were mostly at the 1-sigma level. Three-corner hat analysis of polar motion from the two legacy networks and the IGS Finals GNSS series indicated that the precision of the Legacy 1 network was only slightly less than the precision of the GNSS series over the CONT17 observing period. Baseline length repeatabilities at the level of 0.4 ppb for the relatively small demonstration VGOS five station network were a little better than those for the two legacy networks.

MACGO12M–WETTZ13S Intensives: Lemoine and Petrov participated in an R&D VLBI Intensive program, VGOS-INT-S, which observed the MACGO12M–WETTZ13S baseline for the rapid determination of the Earth’s phase of rotation, expressed as UT1-UTC (Schartner et al. 2023). The observation series in 2022 consisted of 25 one-hour Intensive sessions and six 24-hour Intensive sessions. The one-hour S2 Intensive program used a special observation strategy, the rapid alternation between high- and low-elevation scans, which improves the determination of delays caused by the neutral atmosphere. The 24-hour sessions tested alternate observation strategies for zenith troposphere delay determination. The sessions were scheduled by Mathias Schartner (ETH Zürich) and correlated at Wettzell by Christian Plötz (BKG). In early 2022, the sessions were highly accurate, until multiple technical problems impacted the sessions’ performance. The S2 Intensives also typically included approximately 1.5 times as many observations in one hour as the V2 Intensives.

Mauna Kea Earthquake’s Effect on UT1-UTC: MacMillan was a co-author of a study by Chris Dieck (USNO) on the effect of the Mauna Kea Earthquake in 2018 on UT1-UTC estimates from Intensive sessions

that use the Mauna Kea/PieTown baseline (Dieck et al. 2022). The study showed that the observed UT1 offset was consistent with the displacement of the GNSS station co-located with the Mauna Kea VLBA antenna. The GNSS position can therefore be used to correct the a priori position of the VLBI station, which is critical for maintaining the accuracy of UT1-UTC. Without a co-located GNSS receiver, the VLBI station position model would likely not be modified for months.

Midnight Intensives: Gipson was involved in studying S/X Intensives centered around 0:00 UT. The rationale for this series is that interpolation is not required to compare them to external series, which generally report values at 0:00 UT or at 0:00, 6:00, 12:00, and 18:00 UT. Preliminary studies indicated that the midnight Intensives performed as well as the standard Intensives in terms of precision. Because the midnight Intensives are observed five hours later than the standard Intensives, latency was a potential concern, but this turned out not to be an issue.

R1 and R4 Performance: Cynthia Thomas (CORE OC, GSFC), MacMillan, and Karine Le Bail (Onsala) wrote a paper about the performance of the R1 and R4 sessions (Thomas et al. 2022). The paper investigated the evolution of these series from 2002.0 to 2020.0 in terms of their observing networks, discussed the construction and scheduling of sessions, and determined the precision of polar motion and UT1. Since 2002.0, the precisions of polar motion and UT1 improved by a factor of 2–3 and 1.5, respectively. The main reason for the improvement was the increased size of the networks.

Reference Frames: As the IVS Analysis Coordinator, Gipson directed the efforts of the IVS ACs during the final stages of submitting the data for ITRF2020. Eleven ACs submitted solutions, which included S/X sessions from 1979–2020, as well as VGOS sessions (CONT17 and sessions from 2019–2020). Gipson also chaired ad hoc IVS Working Groups on the evaluation of ITRF2020P (the preliminary version of ITRF2020) and wrote the report summarizing their findings.

RFI Mitigation: Habana was involved in tasks for developing a dynamic mask to mitigate the threat of spaceborne radio frequency interference (RFI). Such a mask is especially necessary when considering the exponential growth of low Earth orbiters that provide Internet downlinking within the same frequency band as the VGOS spectrum. Habana developed routines for

converting Two Line Elements (TLE) to cartesian coordinates based on [1] and subsequently to a satellite's look angles from a given station.

Satellite Threat Database: Habana is responsible for the development of a database to host information about any satellite that may pose a threat to VLBI observations. Matin assisted in combing through the FCC website and perusing the documents of each satellite constellation of interest. This information was used to update the database of over 2,000 satellites. It includes, but is not limited to, the satellite's designated frequency band(s), Effective Isotropic Radiated Power (EIRP), polarization, and emitter. From the winter of 2021 through the fall of 2022, Habana, with assistance from Lawrence Hilliard (GSFC) and Derek Hudson (GSFC), made multiple observations to track spaceborne RFI sources using a field antenna at the Goddard Geophysical and Astronomical Observatory (GGAO).

Scale: Zuheir Altamimi (IGN) reported anomalous behavior of the VLBI scale after about 2014 with respect to ITRF2020. Gipson chaired an ad hoc working group to study this. IVS ACs see this scale difference with respect to ITRF2020. But if they use a VLBI-derived reference frame as an a priori, the effect disappears.

Schedule Characteristics: Wagner used machine learning to analyze Intensive schedules to search for common characteristics of successful schedules.

VGOS Intensive Scheduling Simulations: Baver investigated the expected number of observations if NYALE13N is tagged onto the KOKEE12M–WETTZ13S baseline. She also evaluated the effect of a warm receiver at GGAO12M, KOKEE12M, MACGO12M, and WESTFORD in turn.

6 Scheduling Activities

Baver, Gipson, and Petrov were involved in a pilot program in 2021 and 2022 that studied VGOS Intensives using the KOKEE12M (K2) and WETTZ13S (Ws) antennas. Baver scheduled more than 300 V2 K2–Ws VGOS Intensives for the same time as the INT01 S/X Intensives that the NEOS OC scheduled using KOKEE and WETTZELL. The VGOS Intensives performed much better than the S/X ones. For example, the RMS difference of the UT1 estimated from the VGOS sessions and temporally close R1 and R4 sessions was 16 μ s, while it was 25 μ s for the S/X sessions.

The V2 series observed K2 and Ws, unless one of those stations could not observe. Baver wrote schedules for ten GGAO12M–KOKEE12M, four ISHIOKA–WETTZ13S, and ten KOKEE12M–ONSA13NE V2 sessions.

Improvements to scheduling focused on the K2/Ws baseline. The main improvement was increasing the number of scheduled observations. Baver and Gipson ran simulations that determined that this could be accomplished by decreasing the maximum scan length from 200 to 60 seconds and by decreasing the target SNRs from 20 to 15 to compensate for the decreased number of available sources under the decreased scan length. This change was implemented in January 2022 and evaluated in Gipson et al. 2023 and Baver et al. 2023. Baver also ran simulations to evaluate the robustness of the K2–Ws schedules under a warm receiver at either or both stations. This resulted in a change to the SEFDs used in scheduling. Finally, Baver began to update the source list used in scheduling the K2–Ws sessions. She replaced a weak source with a stronger source, and she began to investigate an alternative source list from Petrov.

Baver also ran a simulation to determine which of eight combinations of maximum scan lengths and target SNRs would generate the highest average number of scheduled GGAO12M/KOKEE12M observations. She used this information for writing the ten GGAO12M/KOKEE12M schedules.

7 Submitted/Accepted/Published Works

K. Baver, J. Gipson, F. Lemoine. “The First Year of KOKEE12M–WETTZ13S VGOS Intensive Scheduling: Status and Efforts Towards Improvement”, in IVS 2022 General Meeting Proceedings, pp. 182–186, edited by K. L. Armstrong, D. Behrend, and K. D. Baver, NASA/CP-20220018789, 2023.

M. Bérubé, J. Gipson, J. Lovell, D. Lakins. “Improving IVS Communication through a VLBI Communications Center”, in IVS 2022 General Meeting Proceedings, pp. 114–118, edited by K. L. Armstrong, D. Behrend, and K. D. Baver, NASA/CP-20220018789, 2023.

S. Bolotin, K. Baver, M. Bérubé, J. Gipson. “Automatic Processing of INT Sessions with nuSolve”, in IVS 2022 General Meeting Proceedings, pp. 159–163,

edited by K. L. Armstrong, D. Behrend, and K. D. Bayer, NASA/CP-20220018789, 2023.

S. Britzen, M. Zajacek, L. C. Popović, C. Fendt, A. Tramacere, I. N. Pashchenko, F. Jaron, R. Pánis, L. Petrov, M. F. Aller, H. D. Aller. “A ring accelerator? Unusual jet dynamics in the IceCube candidate PKS 1502+106”, in *Monthly Notices of the Royal Astronomical Society*, 503 (3): 3145-3178, doi: 10.1093/mnras/stab589 (2021).

S. Bruzewski, F. K. Schinzel, G. B. Taylor, L. Petrov. “Radio Counterpart Candidates to 4FGL-DR2 Unassociated Sources”, in *Astrophysical Journal*, 914 (1): 42, doi: 10.3847/1538-4357/abf73b (2021).

C. Dieck, M. C. Johnson, D. S. MacMillan. “The importance of co-located VLBI Intensive stations and GNSS receivers: A case study of the Mauna Kea VLBI and GNSS stations during the 2018 Hawai‘i earthquake”. *J Geod*, accepted (2022).

J. Gipson, K. Bayer, S. Bolotin, F. Lemoine, P. Elosegui, C. Rusczyk, D. Mondal, A. Sargent, P. Haftings, C. Coughlin, C. Plötz, T. Schüler, A. Neidhardt. “Evaluation of KOKEE12M-WETTZ13S VGOS Intensives”, in *IVS 2022 General Meeting Proceedings*, pp. 177–181, edited by K. L. Armstrong, D. Behrend, and K. D. Bayer, NASA/CP-20220018789, 2023.

H. Hellmers, S. Modiri, S. Bachmann, D. Thaller, M. Bloßfeld, M. Seitz, J. Gipson. “Combined IVS contribution to the ITRF2020”, in *Proceedings of the 25th European VLBI Group for Geodesy and Astrometry Working Meeting*, pp. 61–65, edited by R. Haas, ISBN 978-91-88041-41-8, 2021.

H. Hellmers, S. Modiri, S. Bachmann, D. Thaller, M. Bloßfeld, M. Seitz, J. Gipson. “Scale Evaluation of the ITRF2020 Solution”, in *IVS 2022 General Meeting Proceedings*, pp. 237–242, edited by K. L. Armstrong, D. Behrend, and K. D. Bayer, NASA/CP-20220018789, 2023.

H. P. Kierulf, W. van Pelt, L. Petrov, M. Daehnn, A.-S. Kirkvik, O. Omang. “Seasonal glacier and snow loading in Svalbard recovered from geodetic observations”, in *Geophysical Journal International*, 229, 1, 408–425, doi: 10.1093/gji/ggab482 (2022).

H. Krásná, L. Petrov, “The use of astronomy VLBA campaign MOJAVE for geodesy”, in *Journal of Geodesy*, 95:10, doi: 10.1007/s00190-021-01551-3 (2021).

D. S. MacMillan. “Comparison of EOP and scale parameters estimated from the three simultaneous CONT17 VLBI observing networks”. in *J Geod*

96, 25, <https://doi.org/10.1007/s00190-022-01611-2>, 2022.

D. Mondal, P. Elosegui, J. Barrett, B. Corey, A. Niell, C. Rusczyk, M. Titus, J. Gipson. “Quality Assessment of UT1-UTC (dUT1) Estimates Using VGOS Observations”, in *IVS 2022 General Meeting Proceedings*, pp. 172–176, edited by K. L. Armstrong, D. Behrend, and K. D. Bayer, NASA/CP-20220018789, 2023.

L. Petrov. “Single band VLBI absolute astrometry”, submitted to the *Astronomical Journal*, 2022.

L. Petrov, J. York, J. Skeens, R. Ji-Cathrin, D. Munton, K. Herry. “Precise VLBI/GNSS ties with micro-VLBI”, submitted to the *International Association for Geodesy Symposia on Reference Frames for Applications in Geosciences (REFAG 2022)*, 2023.

R. D. Ray, J.-P. Boy, B. K. Arbic, G. D. Egbert, S. Y. Erofeeva, L. Petrov, J. F. Shriver. “Problematic ψ_1 ocean tide”, in *Geophys. J. Int.*, 227, 1181–1192 (2021).

T. Savolainen, G. Giovannini, Y. Y. Kovalev, M. Perucho, J. M. Anderson, G. Bruni, P. G. Edwards, A. Fuentes, M. Giroletti, J. L. Gomez, K. Hada, S. S. Lee, M. M. Lisakov, A. P. Lobanov, J. Lopez-Miralles, M. Orienti, L. Petrov, A. V. Plavin, B. W. Sohn, K. V. Sokolovsky, P. A. Voitsik, J. A. Zensus, “RadioAstron discovers a mini-cocoon around the restarted parsec-scale jet in 3C 84”, submitted to *Astronomy & Astrophysics*, 2021.

M. Schartner, L. Petrov, C. Plötz, F. G. Lemoine, E. Terrazas, B. Soja. “VGOS VLBI Intensives between MACGO12M and WETTZ13S for the rapid determination of UT1-UTC”, submitted to the *International Association for Geodesy Symposia on Reference Frames for Applications in Geosciences (REFAG 2022)*, 2023.

C. C. Thomas, D. S. MacMillan, K. Le Bail. “Performance of the IVS R1 and R4 sessions”, submitted to *Advances in Space Research* (2022).

References

1. F. R. Hoots, P. W. Schumacher Jr., R. A. Glover. “History of Analytical Orbit Modeling in the U.S. Space Surveillance System”, in: *J. Guidance, Control, & Dynamics*. Doi:10.2514/1.9161 (2004).

IAA VLBI Analysis Center Report

Alexey Kudelkin, Sergei Kurdubov, Svetlana Mironova, Elena Skurikhina, Renata Urunova

Abstract This report presents an overview of the IAA VLBI Analysis Center activities in 2021 and 2022 as well as future plans.

1 General Information

The IAA IVS Analysis Center (IAA AC) operates at the Institute of Applied Astronomy of the Russian Academy of Sciences, St. Petersburg, Russia. The IAA AC contributes to IVS products, such as daily SINEX files, TRF and CRF solutions, and rapid and long-term series of EOP obtained from the IVS observational sessions. The IAA AC generates NGS files from vgosDb files for their use with the QUASAR and OCCAM/GROSS software packages. Besides the IVS VLBI data, the IAA AC deals with the data treatment of domestic observations produced by both the RT-32 radio telescopes (SVETLOE, ZELENCHK, and BADARY) and the RT-13 VGOS radio telescopes (ZELRT13V, BADRT13V, and SVERT13V).

2 Staff

- Dr. Sergey Kurdubov: development of the QUASAR and analysis software.
- Dr. Elena Skurikhina: team coordination, VLBI data processing, development of the

IAA RAS

IAA Analysis Center

IVS 2021+2022 Biennial Report

OCCAM/GROSS and QUASAR software packages.

- Svetlana Mironova (until March 2022): development of the QUASAR software, VLBI data processing, global solution and DSNX file calculation, data combination with SINCOM software.
- PhD Student Alexey Kudelkin: studies in the field of the stochastic data modeling, development of new techniques for scheduling VLBI observations.
- SPbGU student Renata Urunova: VLBI data processing, development of the QUASAR software.

3 Activities during the Past Years

During 2021 and 2022, the IAA AC analyzed data of the IVS (legacy S/X and VGOS) and domestic VLBI observations, submitted to the ITRF2020, and made some investigations.

3.1 Routine Analysis

In 2021 and 2022, the IAA AC continued to generate daily SINEX (DSNX) files from analysis of IVS-R1 and IVS-R4 sessions using the QUASAR software. DSNX files were submitted to the IVS for combination with results of other analysis centers. The IAA AC did not submit DSNX files in the second half of 2022 due to a necessary upgrade of the QUASAR software.

The IAA AC operationally processed the 24-hour and Intensive VLBI sessions using the OCCAM/GROSS software and submitted the results

to the IERS and the IVS on a regular basis. The processing of the Intensive sessions is fully automated.

3.2 Analysis of Domestic Sessions

The IAA Analysis Center processes all observational data of domestic VLBI programs RI, R, and test sessions.

Table 1 presents the main types of the Russian domestic sessions. We use the standard IVS designations for the stations: Sv (Svetloe), Zc (Zelenchukskaya), and Bd (Badary) for RT-32 and Bv (Badary), Zv (Zelenchukskaya), and Sw (Svetloe) for RT-13. Test sessions named RX at S/X/Ka bands were performed, as a rule, once a day with a duration of 0.5 hours on the baseline Bv–Zv.

Table 1 Statistics for sessions for the years 2021 and 2022.

Program	Number of sessions used	rms [μs]	bias [μs]
2021			
RI	365	65.2	−13.0
R	1380	25.7	+22.8
2022			
RI	364	64.9	−30.4
R	1623	23.8	+14.5

Observational data from all these sessions are transmitted to the correlators using e-vlbi data transfer. The processing of the RI sessions is fully automated. The calculated UT1–UTC time series is available at <ftp://quasar.ipa.nw.ru/pub/EOS/IAA/eopi-ru.dat>.

In 2021 and 2022, we observed 728 RI sessions using the QUASAR legacy S/X network (usually on the baseline Badary–Zelenchukskaya with Svetloe replacing one of the stations if needed), and 3,003 sessions were observed using the QUASAR VGOS three-station network. The RI sessions were the most rapid with a latency of about 2.5 hours. The latency for the R sessions was about 6 hours.

SVERT13V was commissioned on 24/11/2020.

The program X is an experimental series at S/X/Ka bands. It is of 0.5-hour or 1-hour duration.

4 Current Status

The IAA AC processes the data of all kinds of VLBI geodetic observation sessions. We use the QUASAR and the OCCAM/GROSS software packages for VLBI data analysis. All observation models in these packages are compliant with the IERS Conventions (2010). Both packages use NGS files as input data. The QUASAR and the OCCAM/GROSS software packages are supported and developed further. The QUASAR software was modified to adhere to the ITRF2020 requirements.

5 Future Plans

- To continue submitting all types of IVS product contributions.
- To continue investigations of EOP, station coordinates, and tropospheric parameter time series.
- To improve algorithms and software for processing VLBI observations.

References

1. E. Skurikhina et al, “IAA VLBI Analysis Center 2017–2018 Biennial Report”, in International VLBI Service for Geodesy and Astrometry 2017+2018 Biennial Report, edited by K. L. Armstrong, K. D. Baver, and D. Behrend, NASA/TP-2020-219041, pages 211–214, 2020.

IGN Argentino Associate Analysis Center Report

Facundo Nahuel Barrera, Micaela Carbonetti, Hernán Guagni

Abstract This report briefly presents a description of the IGN VLBI Analysis Center and its activities from 2021 to 2022. Recent results and plans for the future are mentioned. Since April 2020, IGN has been managed as an IVS Associate Analysis Center by the National Geographic Institute of Argentina (IGN-Ar). During this period, it has incremented its participation in the generation of geodetic products, planning to continue with this in the future.

1 General Information

The IGN Analysis Center is the agency in charge of VLBI processing within the Research Center for Applied Geodesy (CIGA). It is supported and operated by the National Geographic Institute (Figure 1) in Buenos Aires, Argentina.

IGN-Ar is the institution responsible for the determination of Geodetic Reference Frames in Argentina. It is in charge of updating the National Geodetic Reference Frame POSGAR (Argentine Geodetic Positions), the development and maintenance of the Argentine CORS Network (RAMSAC), the National Leveling Network (RN-Ar) and the National Gravimetric Network (RG-Ar). Moreover, its GPS data processing has been contributing with the Geocentric Reference System for the Americas (SIRGAS) since in 2011.

In 2017, IGN developed CIGA aimed to process geodetic data obtained in AGGO and provide solutions

Instituto Geográfico Nacional de Argentina

IGN-Ar Analysis Center

IVS 2021+2022 Biennial Report

to different international services such as IVS, ILRS, and SIRGAS. The main activities of the IGN VLBI group consist of routine processing of 24-hour observational sessions to obtain an estimate of Earth Orientation Parameters (EOP), station coordinates, and station velocities, together with radio source positions.



Fig. 1 National Geographic Institute of Argentina.

2 Staff

The National Geographic Institute has approximately 300 employees. Its responsibilities include contributing to the maintenance of international, regional, and national geodetic networks; production and dissemination of knowledge and geographic information on the Argentine Republic, and the management, production, and publication of geospatial information under international standards and norms.

Members who are contributing to the VLBI Analysis Center are listed in Table 1 (in alphabetical order).

Table 1 Staff members.

Name	Function	Email
Barrera, Facundo	Operational data analyst	fbarrera@ign.gob.ar
Carbonetti, Micaela	Head of CIGA group and Operational data analyst	mcarbonetti@ign.gob.ar
Etchegoyen, María del Rosario	VLBI group assistant	metchegoyen@ign.gob.ar
Fernandez, Daniel	Web site and database maintenance	dfernandez@ign.gob.ar
Guagni, Hernán	Head of Geodesy Direction	hguagni@ign.gob.ar

3 Activities during the Past Two Years

During the past two years, 2021 and 2022, our VLBI group has constantly sought to improve the IGN analysis center based on trainings and studies.

Our center is unique in Latin America; however we think that more advances related to VLBI are required in this part of the world. We saw the need to spread the technique over the region in order to increase the interest in it. Because of this, we have presented our work at many congresses and conferences related to VLBI explaining the importance of the technique. We have taken part in the “XIX Scientific Meeting of the Argentine Association of Geodesy and Geophysics”, in the “Annual Meeting of the Argentine Association of Astronomy”, and in several VLBI seminars within national universities.

Besides this, we have analyzed all R1/R4 sessions available in Data Centers from 2014 to nowadays, among others. We usually do comparisons with different centers’ products in order to control our results. A comparison between IERS and IGN results for polar motion is shown in Figure 2.

Additionally, during last year, we studied the AGGO and TIGO stations’ performances in their participation in the IVS sessions to determine their influences on the stations’ networks. Moreover, a

communication channel was opened with AGGO’s staff in order to attend to each other within topics related to VLBI.

Finally, we think it is important to mention that in November 2022, the BKG and IGN-Ar signed the extension of an agreement that benefits the development of activities in CIGA.

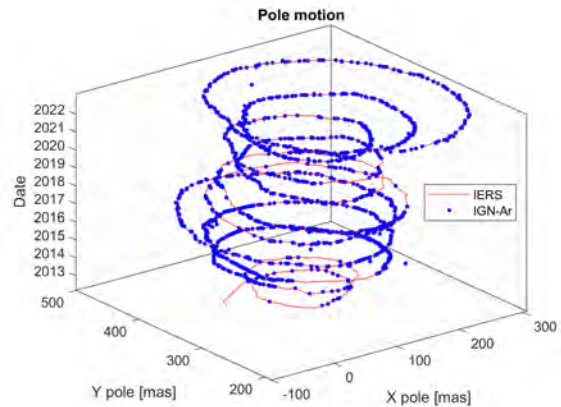

Fig. 2 Polar motion XPO-YPO calculated by IGN and IERS.

4 Current Status

The VLBI group at the IGN-Ar generates daily solution files, containing an estimate of 24-hour Earth orientation parameters and site positions, as well as their covariances and decomposed normal equations. Moreover, results with a 48-hour epoch per session are generated in order to get two EOP offsets. These offsets are estimated at midnight before and after the session. Thereby, our solutions have the faculty to be integrated into the routine IVS combination.

Currently, IGN uses VieVS scientific software (Vienna VLBI and Satellite Software), developed by Vienna University, in the department of Geodesy and Geoinformation. During past years, we applied the following models and international standards:

- Earth Reference Frame: ITRF2014
- Celestial Reference Frame: ICRF3
- Troposphere mapping function: VMF3
- Oceanic loading model: TPX07.2
- Polar drift model: LINEAR IERS2019

- Antenna thermal deformation model: Nothnagel
- Atmospheric loading model: GSFC
- Precession/Nutation model: IAU_2006/2000
- A priori EOPs: IERS C04 14
- High Frequency EOP model (HF-EOP): Desai & Sibois (2016)

Since ITRF2020 was published, however, we are now turning the mentioned models to those adjusted to the new frame.

Moreover, the VLBI group is willing to produce its own global solution routinely.

In addition to improving the VLBI Analysis Center, new activities on geodesy research will be carried out. Furthermore, we want to keep promoting the technique and contribute to the advancement of scientific research in our region.

One of the main goals of the IGN-Ar is becoming an Operational Analysis Center. Its VLBI group will continue its efforts to achieve this.

5 Future Plans

In future activities, IGN-Ar plans to continue with the analysis and submission of 24-hour sessions to IVS, and it plans to extend this to Intensive sessions as well.

National Geographic Institute of Spain Analysis Center Report

Víctor Puente, Esther Azcue, Christian Palomar

Abstract This report gives an overview of the service and research activities of the National Geographic Institute of Spain IVS Analysis Center for the period 2021–2022.

1 General Information

The National Geographic Institute of Spain (IGN Spain, Instituto Geográfico Nacional) is the mapping agency dependent on the Ministry of Transport, Mobility and the Urban Agenda of Spain.

Among several activities such as mapping production, astronomic research or geophysical monitoring, one of the main activities of IGN Spain is the design and maintenance of the national geodetic networks, together with the exploitation of the data. The geodetic infrastructure managed by IGN Spain currently includes a network of permanent GNSS stations, tide gauges and levelling network, legacy and VGOS VLBI telescopes, and an upcoming SLR station [1].

In order to strengthen its contribution to geodetic VLBI analysis beyond the infrastructure and the technological developments of Yebes Observatory and taking advantage of the experience gained as a GNSS Analysis Center for 20 years, IGN Spain set up an analysis team in 2018 with the goal of becoming an IVS Analysis Center. As a result of this effort, IGN Spain has been submitting regular VLBI solutions since March 2020. In order to avoid confusion with

National Geographic Institute of Spain

IGE Analysis Center

IVS 2021+2022 Biennial Report



Fig. 1 IGN headquarters in Madrid (Spain).

the National Geographic Institute of France, the IVS AC code that was selected is IGE (Instituto Geográfico Nacional de España).

2 Staff

The VLBI analysis activities are performed by staff allocated to the Geodesy department of IGN Spain. The department has approximately 20 employees, who maintain the different geodetic networks of the country (GNSS CORS, gravimetry, levelling, and tide gauges) and manage a GNSS Analysis Center and a network-RTK positioning service. During 2021 and 2022, the staff of the IGE AC consisted of three members, who are listed in Table 1 in alphabetical order. There is also a frequent exchange of information with the colleagues from the IGN Yebes Observatory Technology Development Center, and there is a line of collaboration with the staff of the VGOS Santa María Station and the University of Alicante Analysis Center (UAVAC).

Table 1 VLBI analysis group.

Name and email	Role	Dedication
Esther Azcue eazcue@mitma.es	Analyst and researcher	Part-time
Christian Palomar cpalomar@mitma.es	Analyst	Full-time
Víctor Puente vpuente@mitma.es	Analyst and researcher	Part-time

3 Service Activities

The operational processing of IVS R1 and R4 sessions is fully automatized through Linux scripts except for the visual inspection of the residuals that is normally needed in VLBI analysis to exclude outliers and to identify clock breaks.

The software package that is used for the operational analysis of the VLBI sessions is Where [2]. Rotating shifts were established between the analysts to provide the solutions in the established time. The submitted solutions can be found at the IVS Data Centers with the solution code 2020a.

Over these years, the effort of the analysis team has been also focused on the reprocessing of historical VLBI data since 1979. This activity is almost finished, and we expect to submit the solutions to the IVS servers in February 2023.

The processing environment was updated in January 2023 to be compatible with the new version of Where (v2.0.0), which supports the new VLBI naming convention. Together with this change, the switch to ITRF2020 will be carried out.

4 Research and Training Activities

The IGE VLBI group is pursuing different research lines, specifically:

- Study of inter- and intra-technique consistency in CONT campaigns [3], [4], [5].
- Assessment of the performance of VGOS sessions [6].
- Analysis of the consistency of reference frames [7].

For research activities, the VieVS software package [8] is also frequently used.

In 2022, the group hosted a traineeship of a student who also developed her final degree project within the group [9]. The work was focused on the automatic detection of clock breaks in VLBI analysis.

5 Future Plans

Quality checks on the EOP accuracy with respect to conventional series and the latency of the solution submissions are currently under development, and we expect to provide them through the IGN Spain webpage in the near future.

In addition, the automatic processing of the Intensive sessions was recently deployed in the IGE processing environment. Once the accuracy and availability of the solutions is ensured, it is foreseen to contribute to the operational analysis of this kind of sessions.

Acknowledgments

We want to thank the Norwegian Mapping Authority VLBI team for their support in the usage of the Where software package.

References

1. J. C. Rodríguez, E. Azcue, V. Puente et al. Geodetic Analyses at the National Geographic Institute of Spain. In: International Association of Geodesy Symposia. Springer, Berlin, Heidelberg (2022). doi: 10.1007/1345_2022_182
2. A.-S. Kirkvik, G. A. Hjelle, M. Dähnn, I. Fausk, E. Mysen. Where - A new software for geodetic analysis. 23rd EVGA Working Meeting and 18th IVS Analysis Workshop (2017).
3. V. Puente, E. Azcue, E. Martínez, M. Moreira, M. García. Consistency of VLBI estimates in the CONT17 campaign. 25th European VLBI Group for Geodesy and Astronomy Working Meeting (2021).
4. V. Puente. A priori zenith wet delays in the analysis of VLBI CONT sessions. Adv. Space Res 67:2359–2367 (2021). doi: 10.1016/j.asr.2021.01.027 14.
5. V. Puente, E. Azcue, Y. Gomez-Espada, S. Garcia-Espada. Comparison of common VLBI and GNSS estimates in CONT17 campaign. J Geod 95, 120 (2021). doi:10.1007/s00190-021-01565-x
6. E. Azcue, V. Puente, M. Moreira, E. Martínez-Sánchez. Analysis of VGOS sessions: Evaluation of performance

- with different software (2023). IVS 2022 General Meeting Proceedings, NASA/CP-20220018789.
7. M. Moreira, E. Azcue, M. Karbon, S. Belda, V. Puente, R. Heinkelmann, D. Gordon, J. Ferrándiz. VLBI-based assessment of the consistency of the conventional EOP series and the terrestrial reference frames. Reference Frames for Applications in Geosciences Congress (2022).
 8. J. Böhm, S. Böhm, J. Boisits, A. Girdiuk, J. Gruber, A. Hellerschmied, H. Krásná, D. Landskron, M. Madzak, D. Mayer, J. McCallum, L. McCallum, M. Schartner, K. Teke. Vienna VLBI and Satellite Software (VieVS) for Geodesy and Astrometry, Publications of the Astronomical Society of the Pacific, Vol. 130(986), 044503 (2018). doi: 10.1088/1538-3873/aaa22b
 9. I. Rubio. Earth Orientation Parameters (original in Spanish). Final work project. Faculty of Mathematics. Complutense University of Madrid (2022).

Italy INAF Analysis Center

Monia Negusini, Roberto Ricci, Matteo Stagni

Abstract This report summarizes the activity of the INAF VLBI Analysis Center. Our Analysis Center is located in Bologna, Italy and belongs to the Institute of Radio Astronomy (IRA), which is part of the National Institute for Astrophysics (INAF). The IRA runs the observatories of Medicina and Noto, where two 32-m twin VLBI AZ-EL telescopes are located. This report contains the AC's VLBI data analysis activities and illustrates the latest experiments, involving the Italian antennas and correlator, carried out in the last two years.

1 Current Status and Activity

Following the installation of the DiFX software correlator DiFX in 2012 in Bologna, there have been a number of experiments to test the correlation pipeline for geodesy. These VLBI experiments were performed at first on the single baseline Medicina–Noto and subsequently extended to Matera after seeking a collaboration with ASI, which manages the antenna facility. The VITA (ITALian VLbi network) project was launched as a national pilot project, obtaining observing time at the stations and successful experiments.

In these last years the group has been involved in the IQB (Italian Quantum Backbone) development, in collaboration with INRiM (National Institute of Metrology), which set up a distributed time and frequency optical link to some scientific and commercial

facilities, such as the Milan financial District, the Medicina Radioastronomical Observatory, the Italian Laboratory for Non-linear Spectroscopy (LENS) in Florence, the Telespazio Facility in the Fucino Plain, where one of the main stations of the European Galileo satellite network for global navigation is located, and the National Institute of Optics in Pozzuli, to finally reach the Matera Center for Space Geodesy.

In 2021, our group continued a series of VLBI experiments aimed at the characterization of atomic clock synchronization and frequency transfer.

On January 11, 2021 the Medicina antenna took part in a 24-hour rapid session (R1981) in which the clock frequency reference was shared with the Matera antenna via the Italian Quantum Backbone fiber link infrastructure [1]. The data of the participating antennas were correlated by both the Bologna and the Bonn DiFX correlators and locally analyzed via *vSolve* to extract clock model information.

On February 13 and 24, 2021 the Medicina antenna was part of a VLBI experiment in which all of the four Italian antennas observed a few extragalactic sources at 8.4 GHz. A particular frequency set-up was chosen so that both Matera and the Sardinia Radio Telescope could take part in the runs. SRT, in particular, used a narrow-band (40 MHz) receiver operated by the Italian Space Agency for satellite tracking that overlaps with the geodetic X-band frequency range. The data of two six-hour runs were correlated by the Bologna DiFX correlator, fringe fitted, and analyzed using the software package AIPS. The February 13th experiment was performed with Medicina and Matera operating in common-clock mode, whereas the February 24th experiment had all the antennas operating with their local clocks. The statistics on the observed phase stability were extracted and the clock frequency contribution

Istituto di Radioastronomia INAF, Bologna

INAF Analysis Center

IVS 2021+2022 Biennial Report

characterized. Preliminary results were presented at the EVN mini-symposium in July 2021 [2].

New efforts to compare optical atomic clock frequencies at intercontinental distances via VLBI/GPS techniques were undertaken with a new Italian-Korean collaboration, after the completion of the Italian-Japanese project involving transportable small broadband dishes, whose scientific achievements were detailed in publications [3] and [4]. As a first step of the Italian-Korean collaboration the frequencies of the INRiM Ytterbium optical clock and the KRISS Ytterbium optical clock were compared in a 24-hour K-band geodetic VLBI experiment in December 2021 involving six antennas, where the Medicina and Sejong antennas were connected via optical fiber to the INRiM and KRISS, respectively, hosting their optical clocks. In 2022 the data were correlated by the Bologna DiFX correlator and analyzed via vSolve. Future optical clock frequency comparison will make use of the Korean-designed Compact Triple-band Receiver to be also installed in 2023/24 on the Italian antennas as part of a major infrastructure upgrade.

2 Data Analysis and Results

The IRA started to analyze VLBI geodetic databases in 1989, using the Calc/Solve package on an HP workstation, first located at the Medicina observatory and later

at the Bologna headquarters. Since 2007, Linux workstations have been set up for the migration of all the VLBI data analysis, and Mark 5 Calc/Solve has been installed. During the last years, our Analysis Center had some inner problems, and we did not participate regularly in the IVS activities. However, we continued to update the catalog, and we installed and tested the latest releases of Calc/Solve and vSolve.

References

1. C. Clivati *et al.* Common-clock very long baseline interferometry using a coherent optical fiber link, *Optica*, 7, 1031-1037, <https://doi.org/10.1364/OPTICA.393356>, 2020
2. R. Ricci, M. Negusini, F. Perini *et al.* VLBI experiments with the dissemination of a common clock via coherent optical fiber link, *European VLBI Network Mini-Symposium and Users' Meeting 2021*, <https://doi.org/10.22323/1.399.0029>, 2021
3. M. Sekido, K. Takefuji, H. Ujihara *et al.* A broadband VLBI system using transportable stations for geodesy and metrology: an alternative approach to the VGOS concept, *J. Geodesy*, 95, 41, <https://doi.org/10.1007/s00190-021-01479-8>, 2021
4. M. Pizzocaro, M. Sekido, K. Takefuji *et al.* Intercontinental comparison of optical atomic clocks through very long baseline interferometry, *Nat. Phys.*, 17, 223-227, <https://doi.org/10.1038/s41567-020-01038-6>, 2021

KTU-GEOD Analysis Center Report

Emine Tanır Kayıkçı¹, Kamil Teke², Pakize Küreç Nehbit³, Özge Karaaslan⁴, Mualla Yalçınkaya¹, Haluk Konak³

Abstract This report summarizes the activities of the KTU-GEOD Analysis Center (AC) in 2021 and 2022 and outlines the planned activities for 2023 and 2024. Our specific interests and focused subjects for 2021 and 2022 were as follows: (1) analyzing precision criteria of the radio sources in the daily IVS sessions, (2) monitoring the changing precision of radio sources realizing the Celestial Reference Frame in continuous VLBI campaigns, (3) investigating the sensitivity levels of VLBI stations in the CONT14 campaign by combination with GNSS, evaluation of daily CONT17 sessions with the Potsdam Open Source Radio Interferometry Tool (PORT), (4) estimating station velocities of the European IGS and VLBI sites, and (5) estimating the amplitudes and Greenwich phase-lags of the principal semidiurnal and the diurnal tides of the ocean tide loading displacements at the worldwide distributed 37 VLBI stations.

1 General Information

The IVS [1, 2] KTU-GEOD Analysis Center (AC) [3] is located at the Department of Geomatics Engineering, Karadeniz Technical University, Trabzon, Turkey. The Geomatics Engineering Departments at Hacettepe Uni-

1. Karadeniz Technical University, Department of Geomatics Engineering
2. Hacettepe University, Department of Geomatics Engineering
3. Kocaeli University, Department of Geomatics Engineering
4. Gümüşhane University, Department of Geomatics Engineering

KTU-GEOD Analysis Center

IVS 2021+2022 Biennial Report

versity, Kocaeli University, and Gümüşhane University support the activities of the KTU-GEOD AC through analyzing the VLBI observations as well as interpreting the geodetic and geodynamic parameters.

2 Staff at KTU-GEOD Contributing to the IVS Analysis Center

Members who contributed to the KTU-GEOD AC research in 2021 and 2022 are listed in Table 1 (in alphabetical order) by their main focus of research and working location [3, 4, 5, 6].

Table 1 Staff of the KTU-GEOD Analysis Center.

Name	Working Location	Main Focus of Research
Emine Tanır Kayıkçı	Karadeniz Technical Univ., Dept. of Geomatics Eng., Trabzon, Turkey	responsible person from AC, parameter combination
Mualla Yalçınkaya	Karadeniz Technical Univ., Dept. of Geomatics Eng., Trabzon, Turkey	data analysis
Haluk Konak	Kocaeli Univ., Dept. of Geomatics Eng., Kocaeli, Turkey	data analysis
Kamil Teke	Hacettepe Univ., Dept. of Geomatics Eng., Ankara, Turkey	data analysis
Özge Karaaslan	Gümüşhane Univer., Dept. of Geomatics Eng., Gümüşhane, Turkey	data analysis
Pakize Küreç Nehbit	Kocaeli Univ., Dept. of Geomatics Eng., Kocaeli, Turkey	data analysis



Fig. 1 Members of the KTU-GEOD AC at the Turkish National Geodesy Commission Scientific Meeting held in November 2022, Gebze Technical University.

3 Current Status and Activities

3.1 Analyzing Precision Criteria of the Radio Sources in the Daily IVS Sessions

The quality criteria of a geodetic network are determined by the precision criteria computed from the co-factor matrix of the unknown parameters. In two-dimensional networks—and the celestial reference frame realized by extragalactic radio sources can be considered as such—the Helmert mean error ellipse consists of three parameters which are the semi-major and semi-minor axes of the error ellipse and the direction of the semi-major axis. In a well-designed geodetic network, the error ellipses should have homogeneous structures. In other words, the semi-axes of the error ellipses for all radio sources should be similar. In this study, daily CONT17 sessions were evaluated with The Potsdam Open Source Radio Interferometry Tool (PORT) and the parameters of the Helmert mean error ellipses were computed for the radio sources for each session (Figure 2). The results are also compared with the number of observations and the angular position of the radio sources. The results of this study show how the precision criteria are affected depending on the angular position of the radio sources [7].

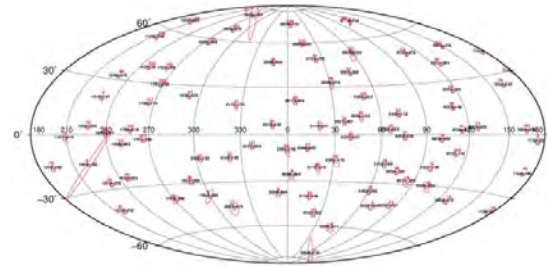

Fig. 2 Error ellipses and the number of observations to the radio sources in the 17DEC08XB session of CONT17.

3.2 Monitoring the Changing Precision of Radio Sources Realizing the Celestial Reference Frame in Continuous VLBI Campaigns

The changing precision of radio sources realizing the Celestial Reference Frame (CRF) in continuous VLBI campaigns was analyzed by different precision criteria. The quality of a geodetic network is classically determined by the precision criteria obtained from the co-factor matrix of the unknown parameters. The Helmert mean error ellipse, which is one of the precision criteria, consists of semi-major axis, semi-minor axis, and the direction of the semi-major axis. In a well-designed geodetic network, it is expected that the error ellipses should have homogeneous structures. In this study, the CONT17 sessions, having a Legacy-1 observation network, were evaluated with PORT. Parameters of the Helmert mean error ellipses of the radio sources were computed in each session of the CONT17. The relationship between the Helmert mean error ellipse parameters and the angular positions and the observation numbers of each radio source has been investigated.

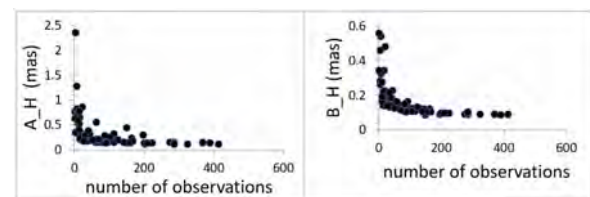

Fig. 3 Comparing the number of observations with the semi-major (A_H) and the semi-minor (B_H) axes (Figure drawn by Susanne Lunz).

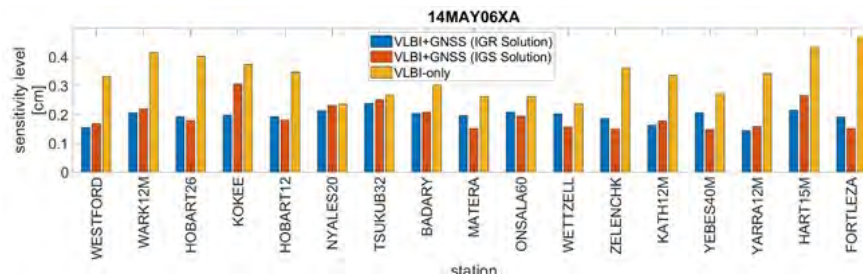

Fig. 4 Comparing the sensitivity levels of the VLBI antennas with combined VLBI and GNSS in session 14MAY06XA of CONT14.

Accordingly, it was seen that values of the semi-axis are directly related to the number of observations of the radio sources (Figure 3) [8].

3.3 Improving the Sensitivity Levels Generated from Hypothesis Testing by Combining VLBI with GNSS Data

The individual space-geodetic techniques have different advantages and disadvantages. For instance, the global observing network of VLBI consists of much fewer stations with a poorer distribution than GNSS. The sensitivity level of any geodetic network provides information on the detection capacity of observing stations based on undetectable gross errors in a geodetic network solution. Furthermore, sensitivity can be understood as the minimum value of the undetectable gross errors by hypothesis testing. The location of the station in the network and the total weight of observations contribute to the sensitivity levels thereof. The total observation number of a radio source and the quality of the observations are also critical for the sensitivity levels of the radio sources. Besides these criteria, a radio source having a larger structure index has a larger sensitivity level.

In this study, it is investigated whether the sensitivity levels of VLBI stations in the CONT14 campaign improve by combination with GNSS. The combination was performed on the normal equation level using 153 GNSS stations in total, 17 VLBI radio telescopes, and local ties at five co-located stations which are ONSA-ONSALA60, NYA1-NYALES20, ZECK-ZELENCHK, MATE-MATERA, and HOB2-HOBART26 during the CONT14 campaign spanning 15 days. To evaluate the observations of GNSS and

VLBI, the software of EPOS8 and VieVS@GFZ (G2018.7, GFZ, Potsdam, Germany) were used respectively. In the VLBI-only solution, FORTLEZA shows the poorest sensitivity level compared to the other VLBI radio telescopes (Figure 4). As a result of the GNSS combination, it can be seen that the sensitivity levels of FORTLEZA improved by about 60% in all sessions of CONT14. It can be concluded that VLBI stations, which are poorly controlled by the other radio telescopes in the network, can be supported by the other space-geodetic techniques to improve the overall quality of the solution [9].

3.4 Estimating Station Velocities of the European IGS and VLBI Sites

We formed two networks (Network #1, Network #2) over European continent covering IGS (International GNSS Service) stations to review the effect of the increase in the number of stations on the velocity estimation in the analysis. Network #1 contains 12 stations, while Network #2 contains 41 stations. The common GNSS stations in Network #1 and Network #2 are: CRAO (Ukraine), MADR (Spain), MATE (Italy), MEDI (Italy), METS (Finland), NOT1 (Italy), ONS1 (Sweden), SVTL (Russian Federation), TIT2 (Germany), WTZR (Germany), YEBE (Spain), and ZECK (Russian Federation). The velocities of these stations were compared according to the density in the network.

The observations performed for three years at IGS stations and during the GNSS campaign measurements of 2017, 2018, and 2019 were used as input data. Coordinates of the geodetic points were calculated in the ITRF2014 reference frame using the Bernese 5.2

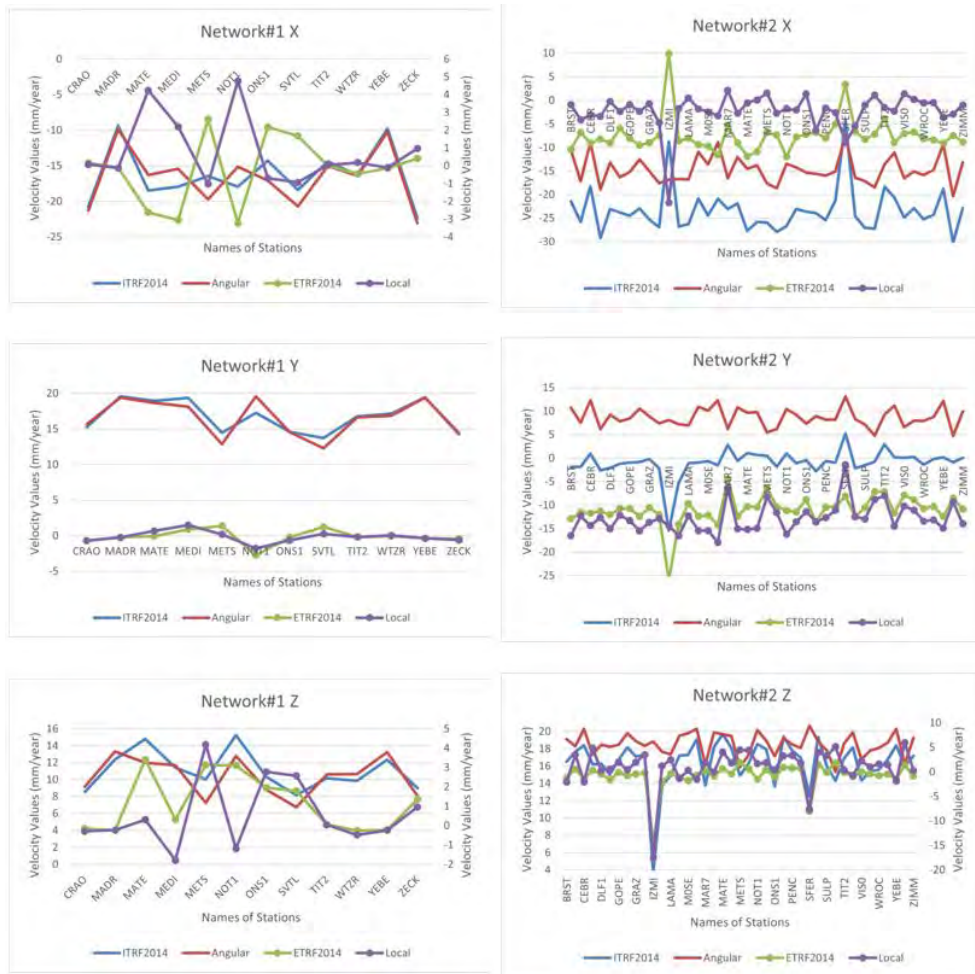

Fig. 5 ITRF2014 velocities, ETRF2014 velocities, local velocities, and the calculated angular velocities at IGS stations for Network #1 and Network #2.

GNSS Software. ITRF2014 velocity values obtained from Bernese 5.2 GNSS Software analyses were converted to ETRF2014 velocity values. ETRF velocities are obtained as a result of analyses made from stations across Europe, minus the crustal movements. Then, the calculation of the velocities, called angular velocity and local velocity (velocities on the surface of the earth), was performed. These velocities were compared with velocities obtained from the Bernese 5.2 GNSS Software and with the velocities obtained by coding (Figure 5).

Calculated angular velocities are expected to be compatible with ITRF2014 velocities, and calculated local velocities will be compatible with the ETRF2014 velocities. Although we achieved an agreement in the

other stations at the level of ± 1 mm, it was not seen at the IZMI IGS station in Network #2. We can interpret this situation as ITRF2014 velocities are found higher due to the discrete and incomplete data of the IZMI IGS station [10].

3.5 The Principle Diurnal and Semidiurnal Tides of the Ocean Loading Displacements from VLBI

In this study, the amplitudes and Greenwich phase-lags of the principal semidiurnal tides and the diurnal tides of the ocean tide loading displacements were

estimated at the worldwide distributed 37 VLBI stations. The analysis of the daily IVS sessions, covering 36 years of geodetic VLBI observations from 1984 to 2020, was done using Vienna VLBI and Satellite Software (VieVS, [11]). Long-term variations are detected in the semidiurnal and diurnal tidal coefficients, i.e., the amplitudes and the Greenwich phase-lags from the sequential solutions of the Kalman filter [12].

4 Future Plans

In 2023 and 2024, our group will be working on (1) estimating the velocities using the VLBI observables of the Network #1 stations co-located with GNSS stations, and comparing the results with those derived from GNSS, (2) quality assessment of the VLBI stations, (3) estimating the in-phase and quadrature components of the phasor vectors of the semidiurnal and the diurnal prograde polar motion caused by the ocean tides and the libration as well as the semidiurnal retrograde polar motion using a Kalman Filter (KF). In this KF estimation, the state vector will be updated for each IVS daily session. The CIP coordinates in TRF at, e.g., 30 minutes intervals derived from the analysis of the IVS daily sessions will be considered as the measurements along with their fully occupied covariance matrices. To suppress the retrograde polar motion at tidal diurnal frequencies to zero, a new type of constraint will be imposed, i.e., different to those introduced in, e.g., [13] and [14].

Acknowledgements

We are thankful to the governing board of the IVS [1, 2]. We are grateful to Karadeniz Technical University, Hacettepe University, Kocaeli University, and Gümüşhane University for their financial support to KTU-GEOD AC research activities.

References

1. H. Schuh, D. Behrend, VLBI: a fascinating technique for geodesy and astrometry, *Journal of Geodynamics*, 61, 68–80, 2012.
2. A. Nothnagel, T. Artz, D. Behrend, Z. Malkin, International VLBI Service for Geodesy and Astrometry – Delivering high-quality products and embarking on observations of the next generation, *Journal of Geodesy*, 91(7), 711–721, 2017.
3. URL 1: <http://www.ktu.edu.tr/spacegeod>, Date of Access: February 2022.
4. URL 2: <https://avesis.ktu.edu.tr/etanir>, Date of Access: February 2022.
5. URL 3: <http://vlbi.hacettepe.edu.tr/en>, Date of Access: February 2022.
6. URL 4: <http://harita.kocaeli.edu.tr/>, Date of Access: February 2022.
7. P. Küreç Nehbit, S. Glaser, S. Lunz, R. Heinkelmann, H. Schuh, H. Konak, Applying Precision Criteria to the Radio Sources in the Daily IVS Sessions, *EGU General Assembly 2022*, 23–27 May 2022, Vienna, Austria.
8. P. Küreç Nehbit, S. Glaser, S. Lunz, R. Heinkelmann, H. Schuh, H. Konak, Quality Inquiries for Radio Sources Used in Continuous VLBI Campaigns, *Turkish National Geodesy Commission 2022 Scientific Meeting*, 02–04 November 2022, Kocaeli, Turkey.
9. P. Küreç Nehbit, S. Glaser, K. Balidakis, P. Sakic, R. Heinkelmann, H. Schuh, H. Konak, Improving the sensitivity levels generated from hypothesis testing by combining VLBI with GNSS data, *EGU General Assembly 2021*, 19–30 Apr 2021, online.
10. E. Tanır Kayıkçı, Ö. Karaaslan, The Effect of GNSS Station Density on Velocity Estimation and Relationship of ITRF2014, ETRF2014, Angular and Local Velocity Values, *EUREF 2022 Symposium*, May 31, 2022 to June 03, 2022, Zagreb, Croatia.
11. J. Böhm, S. Böhm, J. Boisits, A. Girdiuk, J. Gruber, A. Hellerschmied, H. Krásná, D. Landskron, M. Madzak, D. Mayer, J. McCallum, L. McCallum, M. Schartner, K. Teke, Vienna VLBI and Satellite Software (VieVS) for Geodesy and Astrometry, *Publications of the Astronomical Society of the Pacific*, 130, 044503, 2018.
12. K. Teke, The principle diurnal and semidiurnal tides of the ocean loading displacements and their long-term variability as observed by VLBI, *Acta Geodaetica et Geophysica*, 56(2), 231–261, 2021.
13. E. Brockmann, Combination of solutions for geodetic and geophysical applications of the global positioning system (GPS), *Ph.D. Thesis*, Geodätisch-Geophysikalische Arbeiten in der Schweiz, Band 55, 1997.
14. J. Hefty, M. Rothacher, T. Springer, R. Weber, G. Beutler G, Analysis of the first year of Earth rotation parameters with a sub-daily resolution gained at the CODE processing center of the IGS. *J Geod*, 74(6):479–487, 2000.

Norwegian Mapping Authority Analysis Center Report

Ann-Silje Kirkvik

Abstract During 2021 and 2022, the Norwegian Mapping Authority Analysis Center has contributed to the ITRF2020 and the operational daily SINEX product. The Analysis Center has participated in several working groups and projects and continued the development of the analysis software **Where**. The Analysis Center has also investigated the performance of the NYALES20-NYALE13S baseline. The Analysis Center has successfully transitioned to the new VLBI naming convention and will continue with its current activities.

1 General Information

The Norwegian Mapping Authority (NMA) has been an Associate Analysis Center within the IVS since 2010. The Analysis Center is operated by the Geodetic Institute at NMA with its headquarters in Hønefoss, Norway. NMA is a governmental agency with approximately 800 employees, and the IVS activities at NMA are completely funded by the Norwegian government.

NMA is using the analysis software **Where**, which is developed at NMA. **Where**¹ and its companion library **Midgard**² are freely available as open source at GitHub. **Where** is at the moment capable of analyzing single sessions of VLBI data. Efforts have been made to be able to analyze weekly SLR data with **Where**, but

this work is currently halted. **Where** has also been developed to do some special analysis within the GNSS domain, but this is not a part of the open source code.

2 Staff

The Geodetic Institute at NMA is led by Per Erik Opseth and has approximately 50 employees. Some of its responsibilities include maintaining the national reference frame, geoid, and height system. The Geodetic Institute also provides a network-RTK positioning service and operates the VLBI stations in Ny-Ålesund [3].

The Analysis Center was a part of a department called Global Geodesy in 2021 and 2022. Global Geodesy was one of four departments in the Geodetic Institute. In June 2022 Zeljka Jakir replaced Hans Christian Munthe-Kaas as the head of the department. At the end of 2022, the department Global Geodesy ceased to exist and a new organizational model was implemented.

The VLBI analysis group consists of one software developer and three part-time analysts (see Table 1). The development of the SLR analysis is led by Ingrid Fausk, while the development of the GNSS applications is led by Michael Dähnn.

Table 1 NMA Analysis Center staff.

Name	Role
Ann-Silje Kirkvik	Developer and analyst
Åsmund Skjæveland	Analyst
Hans Sverre Smalø	Analyst

Norwegian Mapping Authority (NMA)

NMA Analysis Center

IVS 2021+2022 Biennial Report

¹ <https://kartverket.github.io/where>

² <https://kartverket.github.io/midgard>

3 Activities during the Past Two Years

For the NMA Analysis Center, the years 2021 and 2022 have involved many different activities. These include finalizing the ITRF2020 submission, operational submissions for the daily SINEX product, and participation in working groups and projects. In addition, the Analysis Center has kept an extra eye on the performance of the stations in Ny-Ålesund and continued the development of **Where**.

3.1 ITRF2020

For the first time since NMA became an analysis center within the IVS, the Analysis Center has contributed to the realization of the International Terrestrial Reference Frame: ITRF2020. Most of the analysis and necessary software updates to **Where** were done prior to 2020 [8]. But the final analyses for the ITRF2020 and submissions to the IVS Combination Center were done in April 2021.

For the ITRF2020 contribution, the individual analysis centers processed historical 24-hour VLBI sessions from 1979 until the end of 2020. This includes over 6,500 S/X sessions and 38 VGOS sessions. In total eleven analysis centers contributed to the ITRF2020 using seven different software packages [5].

3.2 Daily SINEX

Since 2019 NMA has submitted processed VLBI sessions routinely in the form of normal equations in the SINEX format (Solution INdependent EXchange format). This is an analysis product that provides estimates of Earth orientation and site positions for each 24-hour session. For the rapid sessions R1 and R4, a timely turnaround of 14 days from observation to final product is desired. These sessions provide up to date Earth Orientation Parameters (EOP) to the global community. The contribution from NMA is included in the IVS combined solution.

In addition to processing R1 and R4 sessions, the Analysis Center also processes and submits SINEX files for VGOS, T2, and RV sessions. The submitted

solutions can be found at the IVS Data Centers with the solution code 2020a.

3.3 Ny-Ålesund

In February 2020 the new VLBI station NYALE13S had its first successful 24-hour session with a tri-band receiver. The goal was to have parallel observations with NYALE13S and NYALES20 to be able to confirm that the two stations have the same velocity. There have been many technical issues with the stations since then [3], but a decent number of parallel sessions have been observed. The NMA Analysis Center has looked more closely into these sessions [4]; see Figure 1 for an up to date analysis of the baseline length and its repeatability. The formal error of each individual session is a bit higher than desired. The performance of the NYALES20–NYALE13S baseline will have an impact on the decision on when to dismantle the NYALES20 antenna. But the condition of the antenna with necessary repair costs will have a higher impact.

3.4 Working Groups and Projects

The NMA Analysis Center has participated in several working groups and projects.

3.4.1 EU-VGOS

The EU-VGOS project began in 2018 with the aim of using the VGOS infrastructure in Europe to investigate methods for VGOS data processing. The project is now structured into Working Groups dealing with operations (stations), e-transfer, correlation and post-processing, and analysis [2]. NMA is participating in the analysis and operations working groups. One of the planned activities of the analysis working group is to look more closely at higher resolution troposphere estimates. Normal S/X sessions typically estimate the zenith wet delay part of the troposphere every hour, but with the increased number of observations that VGOS is capable of achieving, it should be possible to estimate troposphere parameters every 20 minutes. So far, there are not too many sessions available in the

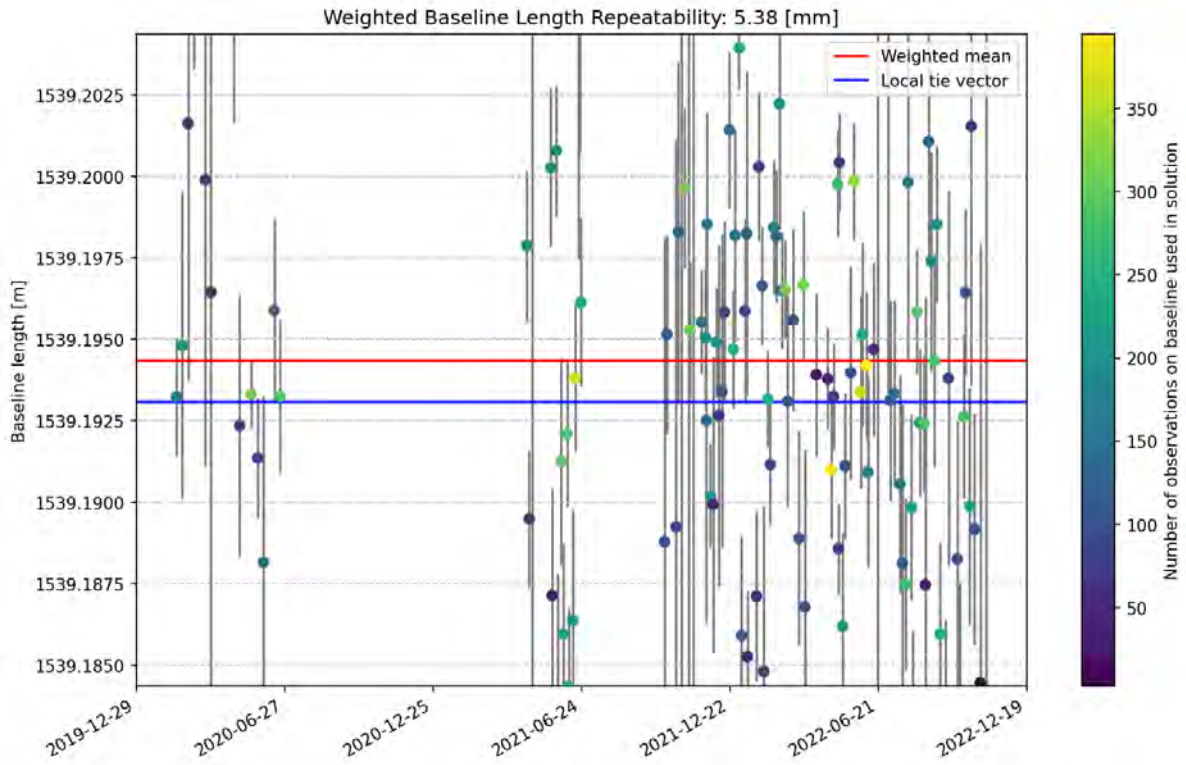

Fig. 1 NYALES20–NYALE13S baseline lengths and weighted baseline length repeatability. The red line is the weighted mean of the individual solutions, and the blue line is the local tie vector.

EU-VGOS project. Further activities are planned once different correlation methods are being tested.

an empirical model for 2020. The preliminary results show that robust networks with many observations per time interval are essential for this approach [1].

3.4.2 Six-hourly EOP Piecewise Linear Offset Parameterization

3.4.3 VLBI Scale

For a long time there has been a desire within the IVS to be able to estimate Earth Orientation Parameters (EOP) at specific epochs to better align the results with EOP estimates from other space geodetic techniques. In addition, it is interesting to investigate the feasibility of providing EOP estimates at a higher resolution than 24 hours, which is common today. A project, led by Axel Nothnagel, was established to look into this possibility.

When Zuheir Altamimi and his team created the ITRF2020, it became apparent that there is a drift in the VLBI scale after 2013.75, and the reasons for this drift are unknown [6]. After the IVS 2022 General Meeting, the IVS Directing Board decided to create an ad hoc working group to investigate this drift. The working group, led by John Gipson, presented the preliminary results of this investigation at the Unified Analysis Workshop in Thessaloniki, Greece, in October 2022 [7]. The reasons for the drift in the VLBI scale are still not fully understood. Figure 2 shows the scale drift computed with **Where**.

By modeling the EOP as continuous piecewise linear functions, the project estimated the Earth Rotation Parameters (ERP) polar motion and UT1-UTC every six hours starting at midnight. The project used R1 sessions from 2020 and fixed the celestial pole offset to

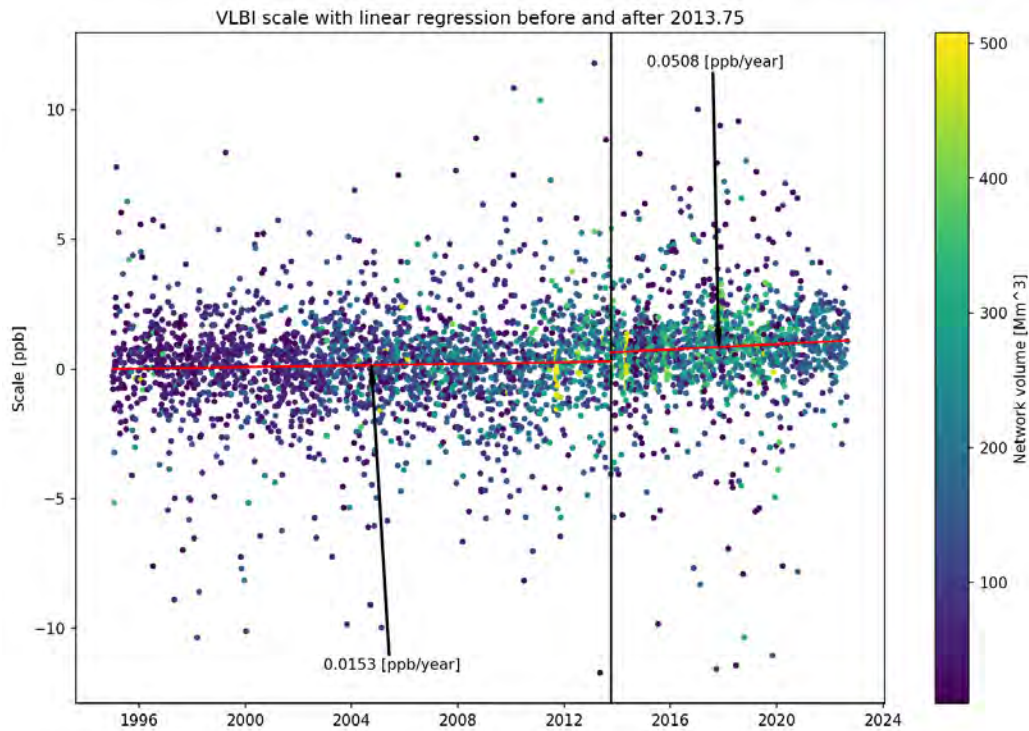

Fig. 2 VLBI scale with regard to ITRF2020 computed with **Where**. The vertical black line is the epoch 2013.75 and the red lines are a linear regression of the sessions before and after 2013.75.

3.5 Where

At the beginning of 2023 a new naming convention for VLBI data files and a new format for the VLBI master file will be implemented. This change required updates to **Where**, and a new version has been made available to the community.

To be able to participate in the working groups, new features have been added to **Where**, such as the possibility of estimating parameters as continuous piecewise linear functions and computing session-wise Helmert parameters.

In addition, several minor improvements and bug-fixes have been implemented during 2021 and 2022.

4 Current Status

Currently, the NMA Analysis Center is working on the transition to the new naming convention. The transition seems to be successful so far.

A new operational solution, 2023a, for the daily SINEX product is under way. This solution will use ITRF2020 as the a priori for station positions and velocities and include the new gravitational deformation models that have been added since the prior solution.

5 Future Plans

NMA will continue with the operational analysis of 24-hour sessions and contribute to the daily SINEX product. This also involves keeping **Where** up to date with current conventions.

NMA also intends to continue participating in analysis working groups and projects when time allows and the scope of the work is within the capabilities of **Where** and the Analysis Center.

As NYALE13N starts to observe more VGOS sessions, these sessions will be of special interest to the NMA Analysis Center in the near future.

References

1. A. Nothnagel et al. "First Results of Project on Six-hourly EOP Piecewise Linear Offset Parameterization." In: IVS 2022 General Meeting Proceedings, edited by K. Armstrong, D. Behrend, and K. Baver, NASA/CP-20220018789, 2023.
2. E. Albentosa et al. "Current Status of the EU-VGOS Project." In IVS 2022 General Meeting Proceedings, edited by K. Armstrong, D. Behrend, and K. Baver, NASA/CP-20220018789, 2023.
3. S. Garcia-Espada et al. "Status at Ny-Ålesund Geodetic Earth Observatory." In: IVS 2022 General Meeting Proceedings, edited by K. Armstrong, D. Behrend, and K. Baver, NASA/CP-20220018789, 2023.
4. A.-S. Kirkvik et al. "First results from the new station NYALE13S." In: Proceedings of the 24th European VLBI Group for Geodesy and Astrometry Working Meeting. Edited by Rüdiger Haas, 2019. ISBN: 978-91-88041-41-8.
5. H. Hellmers et al. "Combined IVS contribution to the ITRF2020." In: Proceedings of the 24th European VLBI Group for Geodesy and Astrometry Working Meeting. Edited by Rüdiger Haas, 2019. ISBN: 978-91-88041-41-8.
6. Z. Altamimi et al. "ITRF2020 and the IVS Contribution." In: IVS 2022 General Meeting Proceedings, edited by K. Armstrong, D. Behrend, and K. Baver, NASA/CP-20220018789, 2023.
7. <https://ivscc.gsfc.nasa.gov/publications/newsletter/issue64.pdf>
8. A.-S. Kirkvik, "Norwegian Mapping Authority Analysis Center Biennial Report 2019–2020." In: International VLBI Service for Geodesy and Astrometry 2019+2020 Biennial Report, edited by D. Behrend, K. L. Armstrong, and K. D. Baver, NASA/TP-20210021389, 2021.

Service and Research at Paris Observatory (OPAR) Analysis Center

S. Lambert, C. Barache, T. Carlucci, E. F. Arias, F. Taris, J. Souchay

Abstract We report on the VLBI-related service and research activity at the Paris Observatory (OPAR) Analysis Center during the years 2021 and 2022. Featured items include the opa2021 diurnal and Intensive solutions, the identification of *Gaia* centroids with pc-scale radio features thanks to absolute VLBI astrometry and VLBA mapping, with insight into locating the emission of γ -ray photons, and the study of several approaches to estimate large-scale systematics in catalogs.

1 General information

The service activities in link with the IVS, including the processing of VLBI data and the maintenance of the website, are ensured by one person (S. Lambert). This does not include the maintenance of the Data Center (see the report on the Data Center in this volume) that is ensured by C. Barache, helped by our IT manager T. Carlucci. The rest of the authors mentioned in this report are involved in the valorization of VLBI data through their scientific exploitation and research but cannot participate directly in IVS activities.

SYRTE, Observatoire de Paris – Université PSL, CNRS, Sorbonne Université, LNE

OPAR Analysis Center

IVS 2021+2022 Biennial Report

2 Service

In 2021–2022, OPAR continued the processing of IVS data, both diurnal and Intensive sessions, in the opa2021a and opa2021i solutions with Calc/Solve. SINEX files were produced routinely for opa2021a so that OPAR could contribute to the IVS combination. Solution opa2021a uses the ICRF3 as its a priori radio source catalog and includes a model for the Galactic aberration, i.e., a dipolar displacement field of the quasars toward the Galactic center of amplitude $5.8 \mu\text{as}$ per year, as recommended by the IVS Working Group 8 (MacMillan et al., 2019) and as used for the production of the ICRF3 catalog (Charlot et al., 2020). The reference epoch of the Galactic aberration modeling is 2015.0, consistent with the ICRF3. As a consequence, the opa2021a quasar coordinate catalog should be read as follows: coordinates listed in the catalog correspond to the apparent position of the sources at 2015.0; at another epoch, the position of the sources should be corrected by the Galactic aberration effect using the above amplitude.

OPAR continued to update radio source coordinate time series, station coordinate time series, and baseline length time series, as non-official products. The radio source coordinate time series are offered in two versions. A first version is obtained with independent session processing of the opa2021a rapid solution, allowing updates as new observations arrive. More accurate time series are obtained by four global solutions in which one fourth of the defining sources are downgraded as local parameters. These series exhibit a substantially lower scatter of the data and allow monitoring of more subtle variations of the position of the radio centroid than with the first version, but they are not up-

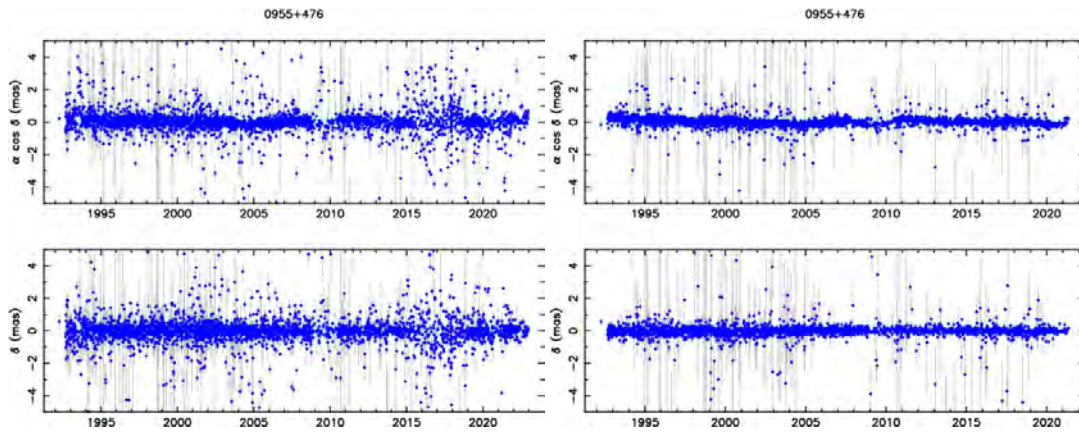

Fig. 1 Time series of the position of the blazar 0955+476 about its mean value.

dated until the processing of new global solutions (see Figure 1).

OPAR also offers a monitoring of the free core nutation (FCN) by fitting its amplitude and phase over a seven year sliding window to the available nutation time series provided by IVS Analysis Centers and the IERS (Figure 2). For each series, we make available a table of yearly amplitudes (that can be used within a routine to model and predict the evolution of the oscillation) and a time series of the FCN values at the epochs of the data.

All these products are made available at the OPAR website (<http://ivsopar.obspm.fr>).

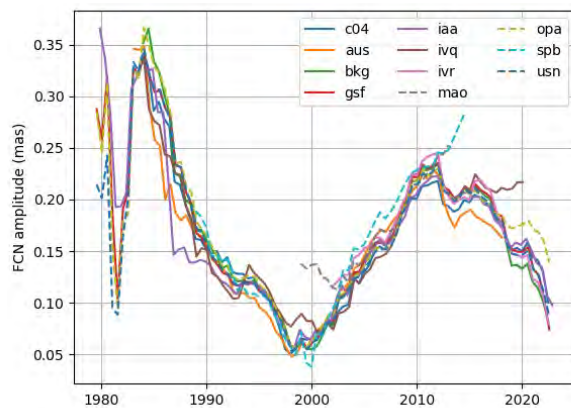

Fig. 2 Amplitude of the free core nutation fitted to several nutation time series.

3 Research

Most of the research using VLBI data in the Paris Observatory team was turned toward the radio-optical offsets between VLBI and *Gaia* with a goal extended to identifying the optical emission mechanism(s) contributing to offsetting the optical centroid with respect to the radio centroid. If the radio centroid designated by geodetic VLBI can be located over a radio structure map with a relatively good accuracy (generally falling close to the brightest feature), the *Gaia* centroid rises from the optical emission integrated over about 100 mas, englobing possibly separate contributions from the jet (one or more knots), the disk, and a halo. Using MOJAVE maps (Lister et al., 2021), we compared absolute ICRF3 and *Gaia* DR3 positions (Prusti et al., 2016; Vallenari et al., 2022) with structures (although ICRF3 is 8 GHz and structures are 15 GHz) to attempt to identify if the *Gaia* emission comes from a radio feature. We showed that, for about 60% of the source sample (with a total sample of about 400 sources), the *Gaia* centroid falls within 3σ of the radio core. For about half of this population, the *Gaia* centroid is susceptible to coinciding with a VLBI component different from close, although very close (called category B for “base”). In contrast, for the rest of this population, the optical centroid falls onto the radio core (category C for “core”). For about 30% of the sample, the *Gaia* centroid coincides with a jet (ejected) component (category J for “jet”). For another 10%, the *Gaia* centroid does not fall onto a clear VLBI feature (category O for “other”) (Lambert et al., 2022a). The study

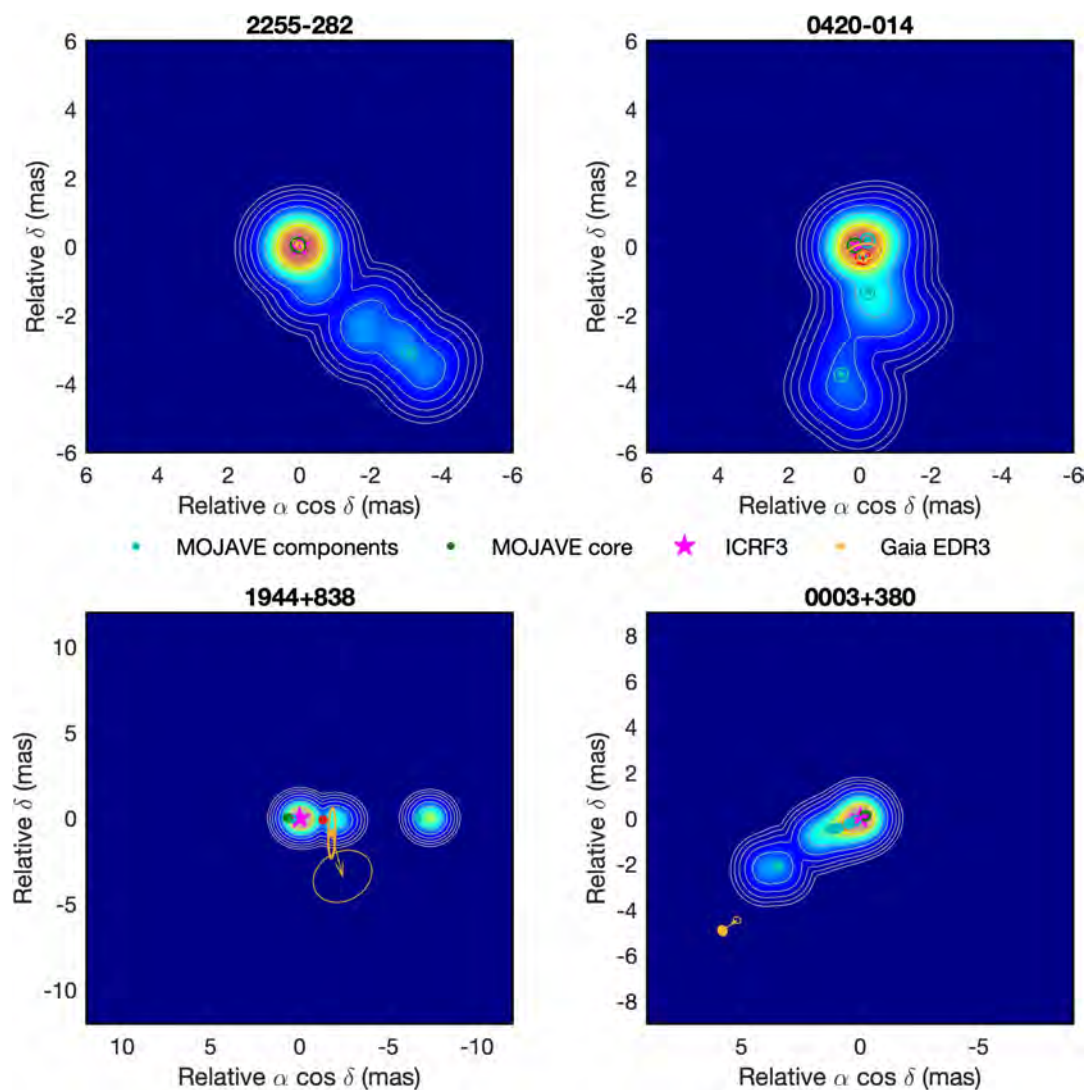

Fig. 3 Example of sources in the four C (2255-282), B (0420-014), J (1944+838), and O (0003+380) categories (see text for details).

of their B-R indices and radio and optical polarization support earlier results from Plavin et al. (2019) and Kovalev et al. (2020). Indeed, the B, J, and O categories exhibit a redder color index than C, favoring a possible contribution of the disk for the latter in contrast to non-thermal (synchrotron) emissions for the former categories. The fractional linear polarization in radio is higher for category J (optically thin in the jet, synchrotron emission in a somewhat organized magnetic field), followed by categories C and B (optically thick cores).

We extended the above comparisons to the very high energy (TeV) domain by using the Fermi-LAT

measurements (Abdollahi et al., 2020) together with radio-optical centroid distances and color index B-R (Lambert et al., 2022b; Sol et al., 2022; Lambert et al., 2022c). Time domain correlations observed between optical, X-ray, and γ -ray fluxes suggest correlated mechanisms (inverse-Compton, synchrotron), so that large emissions of radio, optical, and γ photons could originate from the same region. A recent global approach by Kramarenko et al. (2022), based on correlations between Fermi-LAT fluxes and delayed radio fluxes, favored a γ -ray emission outside the broad line region at several parsecs from the core. Using a sample of about 800 sources, we showed that

highest γ -ray fluxes coincide with sources exhibiting an intermediate color index and an optical emission close to the base of the jet (but not on the core). For these sources and, more generally, for sources for which the optical centroid is in the jet (i.e., B and J of the previous paragraph), the *Gaia* centroid provides an interesting tool for locating the TeV emission site. For low radio-optical separations, the *Gaia* centroid can also locate the dominant γ -ray emission zone for BL Lacs, but the situation is less obvious for FSRQs because of the disk contribution to the optical emission.

Studies were also devoted to characterizing anomalous offsets and/or proper motion either in the optical or the radio domain. Souchay et al. (2022) used the Large Quasar Astrometric Catalog (LQAC, Souchay et al., 2019) as a statistical basis for isolating anomalous proper motions of *Gaia* DR3 (> 10 mas/year) and separating those potentially due to halos or companions from those requiring specific follow-up in the coming years to determine their causes. In the radio domain, Titov et al. (2022) pointed out VLBI sources showing abrupt variations in positions (several mas) and explained them by abrupt variations in their structure or relative fluxes of components.

A more technical study was devoted to characterizing large-scale deformations in VLBI catalogs. In Lambert and Malkin (2023) we compared several methods for estimating the 16 deformation parameters investigated in Charlot et al. (2020). Our methods were inspired by L1-norm minimization and division of the sphere into cells of equal area (Malkin, 2019) with the classical L2-norm-based methods such as used in Charlot et al. (2020) and the more sophisticated L2-iterative. Using simulated catalogs (for which we knew the true values of the deformation parameters), we concluded that all methods converged on the expected values within a few microarcseconds. The identification and elimination of outliers was best achieved with a hybrid L2/L1 method (L1 being used for outlier identification) or iterative L2 method. These two methods provided the best accuracy in the estimated parameters.

References

- Abdollahi S., F. Acero, M. Ackermann, et al. Fermi large area telescope fourth source catalog. *The Astrophysical Journal Supplement Series*, 247(1): 33, 2020.
- Charlot P., C. Jacobs, D. Gordon, et al. The third realization of the International Celestial Reference Frame by very long baseline interferometry. *Astronomy & Astrophysics*, 644: A159, 2020.
- Kovalev Y., D. Zobnina, A. Plavin, and D. Blinov. Optical polarization properties of AGNs with significant VLBI–*Gaia* offsets. *Monthly Notices of the Royal Astronomical Society: Letters*, 493 (1): L54–L58, 01 2020.
- Kramarenko I., A. Pushkarev, Y. Kovalev, et al. A decade of joint MOJAVE-Fermi AGN monitoring: localisation of the gamma-ray emission region. *Monthly Notice of the Royal Astronomical Society*, 510: 469, 2022.
- Lambert S. and Z. Malkin. Estimation of large-scale deformations in VLBI radio source catalogs with mitigation of impact of outliers: A comparison between different L1- and L2-norm-based methods. *Astronomy & Astrophysics*, 2023.
- Lambert S., A. Pierron, and H. Sol. Identification of the optical emission detected by *Gaia* with radio structures in parsec-scale AGN jets. *Astronomy & Astrophysics*, in preparation, 2022a.
- Lambert S., A. Pierron, and H. Sol. Parsec-scale Jets in AGN: Insights into the Location of the γ -Ray Emission from Geodetic VLBI, *Gaia* EDR3, and Fermi-LAT. In *IVS 2022 General Meeting Proceedings*, edited by K. L. Armstrong, D. Behrend, and K. D. Baver, NASA/CP-20220018789, 2022b.
- Lambert S., H. Sol, and A. Pierron. Can VLBI-*Gaia* absolute astrometry and Fermi measurements unveil the location of the gamma-ray emission region? *Astronomy & Astrophysics*, in preparation, 2022c.
- Lister M., D. Homan, K. Kellermann, et al. Monitoring of jets in active galactic nuclei with VLBI experiments. XVIII. Kinematics and inner jet evolution of bright radio-loud active galaxies. *The Astrophysical Journal* 923 (1): 30, 2021.
- MacMillan D., A. Fey, J. Gipson, et al. Galactocentric acceleration in VLBI analysis. Findings of IVS WG 8. *Astronomy & Astrophysics*, 630: 93, 2019.
- Malkin Z. A new equal-area isolatitudinal grid on a spherical surface. *Astronomical Journal*, 158 (4): 158, 2019.
- Plavin A., Y. Kovalev, and L. Petrov. Dissecting the AGN disk–jet system with joint VLBI-*Gaia* analysis. *The Astrophysical Journal*, 871 (2): 143, 2019.

- Prusti T., J. de Bruijne, A. Brown, et al. The Gaia mission. *Astronomy & Astrophysics*, 595: 1, 2016.
- Sol H., S. Lambert, and A. Pierron. Locating the blazar gamma-ray emitting zone from astrometric VLBI and Gaia data? In *Proc. 7th Heidelberg International Symposium on High-Energy Gamma-Ray Astronomy (Gamma2022)*, 2022.
- Souchay J., C. Gattano, A. Andrei, et al. Lqac-5: The fifth release of the large quasar astrometric catalogue – a compilation of 592 809 objects with 398 697 gaia counterparts. *Astronomy & Astrophysics*, 624: 145, 2019.
- Souchay J., N. Secrest, S. Lambert, et al. Quasars with large proper motions: A selection from the lqac-5 catalogue combined with gaia edr3. *Astronomy & Astrophysics*, 660, 2022.
- Titov O., S. Frey, A. Melnikov, et al. Unprecedented change in the position of four radio sources. *Monthly Notices of the Royal Astronomical Society*, 512: 874, 2022.
- Vallenari A., A. Brown, T. Prusti, et al. Gaia Data Release 3. Summary of the contents and survey properties. *Astronomy & Astrophysics*, 2022.

Onsala Space Observatory – IVS Analysis Center Activities During 2021–2022

Rüdiger Haas¹, Eskil Varenius¹, Rebekka Handirk¹, Karine Le Bail¹, Periklis-Konstantinos Diamantidis¹, Tobias Nilsson², Gunnar Elgered¹, Peng Feng¹, Maxime Mouyen¹, Hans-Georg Scherneck¹

Abstract This report briefly summarizes the activities of the IVS Analysis Center at the Onsala Space Observatory during 2021–2022 and gives examples of results of ongoing work.

- Gravimetry
- Ocean tide loading

1 General Information

We concentrate on research topics that are relevant for space geodesy and geosciences. These research topics are related to data observed with geodetic VLBI and complementing techniques.

2 Activities during the Past Two Years

We worked primarily on the following topics:

- Short-baseline interferometry
- Radio source flux-density monitoring
- Combination on the observation level
- Maintenance of IVS products
- Contribution to ITRF2020
- Investigating the VLBI scale drift
- Analysis of VGOS sessions
- Scheduling IVS R&D sessions
- Atmospheric delays in space geodesy
- Coastal GNSS interferometric reflectometry

¹ Chalmers University of Technology, Department of Space, Earth and Environment, Onsala Space Observatory

² Lantmäteriet, the Swedish Mapping, Cadastral and Land Registration Authority

Onsala Analysis Center

IVS 2021+2022 Biennial Report

3 Short-baseline Interferometry

We extended the ONTIE series [1] of local interferometry observations with the three geodetic stations of the Onsala telescope cluster, i.e., the 20-m radio telescope (On) and the Onsala twin telescopes (Oe, Ow), equaling 20 new sessions during 2021 and 2022. The goal is to monitor the local baselines and their stability and to investigate potential seasonal phenomena due to, e.g., thermal deformation of the radio telescopes [2].

4 Radio Source Flux-density Monitoring

We used data of the so-called VGOS-B2 series, i.e., VGOS Intensives involving the Onsala twin telescopes (OTT) and the VGOS station Ishioka (Japan), to monitor the flux-densities of radio sources [3]. Furthermore, we used the OTT as a standalone instrument in a series of dedicated flux monitoring sessions [4].

5 Combination on the Observation Level

We explored the impact of combination on the observation level (COL) for the analysis of space geodetic data of several different techniques as follows.

The first study was done for the CONT17 campaign [5]. VLBI and GPS data were combined in inter-

and intra-technique solutions for the determination of the terrestrial reference frame (TRF) as well as Earth Orientation Parameter (EOP) products [6]. Combining data from different techniques at co-located sites, i.e., VLBI and GPS, addressed the inter-technique aspect. Common tropospheric parameters for the co-located stations were estimated, which led to an improvement in the determination of VLBI station positions and baseline repeatability by up to 25%. By combining data of two different and simultaneously operating VLBI networks, i.e., the so-called L1 and L2 networks during CONT17, the intra-technique aspect was addressed. The estimation of a common set of EOP for both networks resulted in an improvement in the precision of the derived polar motion and UT1 values by 20% to 30% when comparing to independently derived GPS-based estimates.

The second study addressed using COL for VLBI Intensive sessions [7]. Data from co-located GNSS stations were used to provide consistent troposphere information for Intensive VLBI data. This was done by combining three hours of encapsulating GNSS data for a one-hour Intensive VLBI session. This new strategy was used for both legacy S/X and VGOS Intensives [8] and was shown to increase the UT1-UTC precision by 15%. The agreement of the two types of simultaneous VLBI sessions improved by 65% when using COL and estimating gradients with a three-hour temporal resolution. Higher temporal resolution for the gradients improved the agreement even more. Comparing length-of-day with independently derived results from GNSS shows that the COL approach leads to 55% better agreement than individual analyses.

6 Maintenance of IVS Products

We provide and maintain the IVS Source Name Translation Table, available on CDDIS at the url: https://cddis.nasa.gov/archive/vlbi/gsf/ancillary/solve_apriori/IVS_SrcNamesTable.txt.

7 Contribution to ITRF2020

We used the VLBI data analysis software ASCOT [9] and analyzed the full set of vgosDb from 1979 through 2020. The resulting SINEX files of these sessions were submitted to the IVS Combination Center to be included in the official IVS combination solution for the ITRF2020 [10]. Our solution is unique in the sense that it is the only one out of the 11 submissions to the IVS Combination Center that used the ASCOT software. The IVS Combination Center used these 11 submissions to produce the final IVS contribution to the ITRF2020 [11].

8 Investigating the VLBI Scale Drift

The new realization of the International Terrestrial Reference System, the ITRF2020 [11], became available in April 2022. It shows a significant change, after 2013.175, in the behavior of the scale defined by VLBI. We investigated possible reasons for such a change by studying the impact of geophysical mis-modeling, observation network non-homogeneity, and including data from stations with technical problems. The scale drift seems to be affected by a combination of these factors. This work is still ongoing.

9 Analysis of VGOS Sessions

We investigated the performance of the 24-hour VGOS sessions observed during 2019–2021 [14]. Station positions and the EOP were compared with corresponding results from legacy S/X VLBI sessions. This study showed that the VGOS station position repeatabilities are significantly better than those obtained from the legacy S/X VLBI sessions. On the other hand, the VGOS-derived EOP were less accurate than those from the legacy S/X sessions. The reason for this is probably the small number of operational VGOS stations and the poor global coverage of the VGOS network.

10 Scheduling IVS R&D Sessions

Between 2013 and 2020 and following the acceptance of the proposal [12], 55 IVS R&D sessions were dedicated to the observation of 195 ICRF2-Gaia transfer sources selected by the Bordeaux Observatory: a set of ICRF2 sources that were observed in the optical realm by the Gaia instrument. The primary goal of these observations is the alignment of the ICRF with the Gaia Celestial Reference Frame (GCRF). In 2021 and 2022, we scheduled 20 IVS R&D sessions (RD2101–RD2110 and RD2201–RD2210) using the scheduling software *sked*, with the same goal of strengthening the observations of a core set of sources observed both by geodetic VLBI and Gaia. Due to the adoption of the ICRF3 [13] by the IAU, the extension of the Gaia mission with the expected release of position time series and the IVS R&D session network, the source selection strategy was revised in November 2020 by K. Le Bail, P. Charlot, and C. Gattano. The source list is now variable: the goal is to build a regular observation history for these sources. This will allow for a comprehensive comparison of the source position time series of the ICRF and the GCRF.

11 Atmospheric Delays in Space Geodesy

We continued our research efforts concerning atmospheric delay effects in space geodesy as follows.

We used GNSS observations at the Onsala Space Observatory from 2019 to estimate linear horizontal gradients in the wet propagation delay, and we compared these to the corresponding ones from a co-located microwave radiometer [15]. Various different temporal resolutions and elevation cutoff angles were tested. Using multi-GNSS data increased the correlation w.r.t. radiometer results by 11% and 20% for the east and north gradients, respectively. The highest correlation was achieved for the east and north gradients with a temporal resolution of two hours and six hours, respectively. Using weak constraints in the GNSS analyses helps to track large short lived gradients.

Using local interferometric observations at Onsala [1] we studied differential zenith wet delays and compared these to linear horizontal gradients derived from the co-located microwave radiometer [16]. The gradi-

ents derived from the radiometer were projected on the local baseline between the telescopes. Correlation coefficients in the range of 0 to 0.2 were obtained, which agrees with results based on simulations.

Data of the VGOS R&D VR2101 were analyzed with a five-minute temporal resolution for zenith wet delay and horizontal gradients [17]. This high temporal resolution is equivalent to what is used in standard GNSS processing and the analysis of microwave radiometer data and thus allows comparisons without need of interpolation. The zenith total delays from VGOS and GNSS revealed correlation coefficients larger than 0.9 for all but one of the participating sites in the VR2021 session. The horizontal gradients from VGOS and GNSS had correlation coefficients between 0.2–0.5 for the east components and 0.4–0.7 for the north components. For Onsala, the only site participating in VR2101 that was equipped with a co-located microwave radiometer, the correlation between VGOS and the microwave radiometer was 0.96 for the zenith total delays. The corresponding horizontal gradients showed correlation coefficients of about 0.2 and 0.5 for the east and the north component, respectively.

12 Coastal GNSS Interferometric Reflectometry

We continued our research in GNSS interferometric reflectometry (GNSS-IR). One topic was to derive an improved model for the tropospheric error in GNSS-IR. Another topic was to investigate the impact of different GNSS antenna models on the retrieval of sea level results with GNSS-IR. Both topics are under further investigation. Figure 1 depicts a temporary installation of several different GNSS antennas directly at the sea next to the permanent GNSS-R installation at Onsala.

13 Gravimetry

During seven weeks in the summer of 2022, Onsala organized an international comparison campaign for absolute gravimeters. In total, 15 different instruments participated, both ballistic (FG5X, FG5, A10) and quantum (AQG) absolute gravimeters. The



Fig. 1 Several different GNSS antenna types mounted close to the sea next to the permanent GNSS-R installation at Onsala (right).

superconducting gravimeter (SG) located at Onsala continuously kept track of local gravity variations, especially due to hydrological effects. The analysis of the data set is ongoing.

Degree-3 gravimetric tidal constituents were derived for 16 SGs, based on a hypothesis-free wave grouping approach [18]. The agreement of the mean signal amplitude of the derived empirical values was shown to agree to corresponding modeled constituents on a level of 63–80%. The latter were derived using a barotropic, data-unconstrained ocean tide model that is optimized with respect to a tide-gauge data set.

In 2022, the data of the SG, that are publicly shared via the International Geodynamics and Earth Tide Service of the International Association of Geodesy, were given a DOI (Digital Object Identifier), which should be cited [19] when its data are used. Following the publication of the FAIR Data Principles [20], an increasing number of journals encourage/require authors to include data citations as part of their reference list. This should help to enhance the visibility of Onsala’s gravimeter data and to monitor their usage.

14 Ocean Tide Loading

The Automatic Ocean Tide Loading service was operated throughout the year. It is heavily used by the international scientific community. Two new ocean models, EOT20 and TPXO.9.5a, were

included during the last two years, see <http://holt.oso.chalmers.se/loading/>.

15 Future Plans

The IVS Analysis Center at the Onsala Space Observatory will continue its efforts to work on specific topics relevant to space geodesy and geosciences. We plan to intensify our work in particular concerning tropospheric parameters sensed by space geodetic techniques, as well as monitoring radio source flux-densities with local interferometry. We also plan to analyze the global VLBI data set on a more regular basis and to contribute to, e.g., the IVS quarterly solutions. This work will be done in collaboration with Lantmäteriet, the Swedish mapping, cadastral, and land registration authority.

References

1. Varenus E., Haas R., Nilsson T. (2021). Short-baseline interferometry local-tie experiments at the Onsala Space Observatory. *Journal of Geodesy*, 95:54, doi:10.1007/s00190-021-01509-5
2. Handirk R., Varenus E., Nilsson T., Haas R. (2023). Obtaining Local-Tie Vectors from Short-Baseline Interferometry. In: K. L. Armstrong, D. Behrend, and K. D. Baver (eds.) *IVS 2022 General Meeting Proceedings*, 134–138, NASA/CP-20220018789
3. Le Bail K., Varenus E., Haas R. (2021). Source flux-density monitoring in the VGOS era. In: R. Haas (ed.) *Proc. 25th EVGA Working Meeting*, 90–94,
4. Varenus E., Maio F., Le Bail K., Haas R. (2022). Broad band flux-density monitoring of radio sources with the Onsala twin telescopes. *Experimental Astronomy* 54, 137–155. doi:10.1007/s10686-022-09867-4
5. Behrend D., Thomas C., Gipson J., Himwich E., Le Bail K. (2020). On the organization of CONT17. *Journal of Geodesy* 94:100, doi:10.1007/s00190-020-01436-x
6. Diamantidis P. K., Klottek G., Haas R. (2021). VLBI and GPS inter- and intra-technique combinations on the observation level for evaluation of TRF and EOP. *Earth, Planets and Space*, 73:68, doi:10.1186/s40623-021-01389-1
7. Diamantidis P. K., Haas R., Varenus E., Schartner M., Matsumoto S. (2022). Combining VGOS, legacy S/X and GNSS for the determination of UT1. *Journal of Geodesy*, 96:55, doi:10.1007/s00190-022-01648-3
8. Haas R., Varenus E., Matsumoto S., Schartner M. (2021). Observing UT1-UTC with VGOS. *Earth, Planets and Space*, 73:78, doi:10.1186/s40623-021-01396-2

9. Artz T., Halsig S., Iddink A., Nothnagel A. (2016). ivg::ASCOT: Development of a New VLBI Software Package. In: D. Behrend, K. D. Baver, and K. L. Armstrong (eds.) *IVS 2016 General Meeting Proceedings*, 217–221, NASA/CP-2016-219016
10. Hellmers H., Modiri S., Bachmann S., Thaller D., Bloßfeld M., Seitz M., Gipson J. (2022). Combined IVS Contribution to the ITRF2020. In: International Association of Geodesy Symposia. Springer, Berlin, Heidelberg. doi:10.1007/1345_2022_170
11. ITRF2020 (2022) <https://itrf.ign.fr/en/homepage>
12. Bourda G., Charlot P. (2012). Observations of ICRF2 Sources to Improve the Astrometry of the Future Radio-optical Transfer Sources. IVS Memorandum 2012-001v01 (<https://ivscc.gsfc.nasa.gov/publications/memos/index.html>)
13. Charlot P., Jacobs C., Gordon D., Lambert S., de Witt A., Böhm J., Fey A., Heinkelmann R., Skurikhina E., Titov O., Arias F., Bolotin, S., Bourda G., Ma C., Malkin Z., Nothnagel A., Mayer D., MacMillan D., Nilsson T., Gaume R. (2020). The third realization of the International Celestial Reference Frame by very long baseline interferometry. *Astronomy & Astrophysics*, 644, A159; 1–28, doi:10.1051/0004-6361/202038368
14. Nilsson T., Haas R., Varenus E. (2023). The Current and Future Performance of VGOS. In: K. L. Armstrong, D. Behrend, and K. D. Baver (eds.) *IVS 2022 General Meeting Proceedings*, 192–196, NASA/CP–20220018789
15. Ning T., Elgered G. (2021). High temporal resolution wet delay gradients estimated from multi-GNSS and microwave radiometer observations. *Atmospheric Measurement Techniques*, 14(8), 5593–5605, doi:10.5194/amt-14-5593-2021
16. Elgered G., Haas R. (2021). Small scale atmospheric variations sensed with very short baseline interferometry (VSBI) and microwave radiometry. In: R. Haas (ed.) *Proc. 25th EVGA Working Meeting*, 110–114
17. Haas R., Johansson J., Elgered G., Diamantidis P. K., Nilsson T. (2023). Assessment of Parameters Describing the Signal Delay in the Neutral Atmosphere Derived from VGOS Observations. In: K. L. Armstrong, D. Behrend, and K. D. Baver (eds.) *IVS 2022 General Meeting Proceedings*, 248–252, NASA/CP-20220018789
18. Sulzbach R., Wziontek H., Hart-Davis M., Dobsław H., Scherneck H. G., Van Camp M., Dahl Omang O. C., Antokoletz E. D., Voigt C., Dettmering D., Thomas M. (2022). Modeling gravimetric signatures of third-degree ocean tides and their detection in superconducting gravimeter records. *Journal of Geodesy*, 96(35), doi:10.1007/s00190-022-01609-w
19. Scherneck H. G., Mouyen M., Reldin J. (2022). Superconducting Gravimeter Data from Onsala - Level 1 *GFZ Data Services*, doi:10.5880/igets.os.11.001
20. Wilkinson M., Dumontier M., Aalbersberg J., Appleton G., Axton M., Baak A., Blomberg N., Boiten J. et al. (2016). The FAIR Guiding Principles for scientific data management and stewardship. *Scientific Data*, doi:10.1038/sdata.2016.18

PMD Analysis Center Report

Vincenza Tornatore

Abstract This report summarizes the activities of the Politecnico di Milano (PMD) Analysis Center (AC) during the years 2021 and 2022. Different methods used by space-geodetic techniques to assess both tropospheric and ionospheric effects on radio signals have been of specific interest for the AC. Problems related to the defense of those parts of the spectrum used during experiments carried out by legacy VLBI and VGOS antennas have been tackled under scientific need and considering current international regulations. The AC has collaborated with the “Large-scale dimensional measurements for geodesy” GEOMETRE project on European Metrology Programme for Innovation and Research (EMPIR).

1 General Information

The PMD Analysis Center is hosted at the Department of Civil and Environmental Engineering (DICA) of the Politecnico di Milano, which brings together professors, researchers, PhD students, and technical and administrative staff. DICA takes care of several laboratory facilities. Following a renovation, people and offices belonging to the thematic division Geodesy and Geomatics have been moved from building number 3 of the Politecnico di Milano Campus “Leonardo” to the new building 3A (called Lerici). The PMD AC is also located in the new Lerici building now. The construction has two floors above ground and a final flat

Politecnico di Milano, Department of Civil and Environmental Engineering (DICA), Geodesy and Geomatic Area

PMD Analysis Center

IVS 2021+2022 Biennial Report

roof with floors set at different heights. The composition of the volumes has made it possible to create three levels of green roofs (see Figure 1). The architectural structure, even if in a smaller size, follows modern ambitious metropolitan reforestation projects through the vertical densification of greenery.



Fig. 1 Politecnico di Milano Campus Leonardo, new building 3A with three green roofs, where the PMD AC is hosted.

Analyses of VLBI sessions have been carried out with VieVS-VLBI v3.2 software, a module of Vienna VLBI and Satellite Software [1]. Schedules and simulations have been tested using VieSched++ v1.1. Both modules run on a Matlab installation (R2016b). Another software developed and maintained by TU Wien is Ray-traced Delays in the Atmosphere (RADIATE) [2]. This software has also been used at PMD to calculate the Zenith Total Delay (ZTD), the Zenith Hydrostatic Delay (ZHD), and the Zenith Wet Delay (ZWD) at sites and epochs of interest. Three parameters—Geopotential height Z [m], specific humidity Q [g/kg], and absolute temperature T [K]—were used as input

on 25 pressure levels and with a spatial resolution of 1×1 degrees. RADIATE computations are based on Numerical Weather Models (NWM) and can compute also other tropospheric ray-traced parameters useful for space or satellite geodetic techniques.

2 Current Status and Activities

2.1 Studies on Assessment of Tropospheric Parameters

Investigations into the assessment of the accuracy of precipitable water vapor (PW) retrieval by space and in-situ techniques, calculated by numerical models, have been carried out in Arctic and Antarctic regions. Data are still scarce and often not easy to collect in polar regions, but, anyway, long-time series of water vapor content (PW) have been estimated. The PW varies both in space and time, and its measurement is challenging. Water vapor content in the polar regions is a significant indicator for Earth's climate state and evolution on the whole. Water vapor is present in the list of the Essential Climate Variables (ECV), contributing to the characterization of Earth's climate according to the definition given by the Global Climate Observing System (GCOS).



Fig. 2 The nine-meter VLBI antenna of O'Higgins Antarctic Station. [Credit: DLR (CC BY-NC-ND 3.0)]

Precipitable water vapor estimated at GNSS sites has been compared with PW estimates by radio sondes (RS) when co-located with GNSS stations. These values have also been compared with PW obtained by the ERA-Interim reanalysis model provided by the Eu-

ropean Centre for Medium-Range Weather Forecasts (ECMWF) that recently has been superseded by the ERA5 reanalysis [3]. Studies have been made also on estimations of ZWD and PW using data from the O'Higgins VLBI station (see Figure 2) in the Antarctic Peninsula.

But these products are still under investigation because they look very noisy and epochs in common with GNSS values are very sparse. After validation of different methods to retrieve water vapor, long-term trends in the Arctic and Antarctic regions were estimated. More details on the work and on the results can be found in [4]. This work has been developed in collaboration with the Italian INAF IVS AC.

2.2 Estimation of Ionospheric Parameters at the Regional Level

Vertical Total Electron Content (VTEC) can be retrieved from the measurements of most space geodetic techniques; often different methods inside the same technique are used to estimate the same parameters. The International GNSS Service (IGS), for example, provides global ionospheric maps (GIMs) of global ionospheric vertical total electron content (VTEC) in a standard format known as IONosphere map EXchange (IONEX). These files provide global values of VTEC every two hours with the spatial resolution of 2.5° in latitude and 5° in longitude. To know the value of VTEC at a single point where a GNSS station is installed, GIMs need to be interpolated to the coordinates and epochs under consideration.

Another method, known as the Cirarolo method (see the description in [5]), uses receiver-independent exchange (RINEX) files containing GPS carrier phase observables at the L1 and L2 frequencies. The implemented algorithm calculates the VTEC values for each single GPS station. To evaluate possible discrepancies between the two methods at the regional level, we have compared VTEC values obtained from GIMs at three Italian stations belonging to the GPS permanent network "Rete Integrata Nazionale GPS (RING)" (see Figure 3) of the "Istituto Nazionale di Geofisica e Vulcanologia" (INGV).

The main steps of the analysis and results obtained in this work have been published in [6]; differences between the two methods have been found. These differ-



Fig. 3 GNSS stations of the INGV “Rete Integrata Nazionale GPS (RING).” [Credit: “Istituto Nazionale di Geofisica e Vulcanologia” (INGV)]

ences increase as the latitude decreases and as the solar activity intensifies. Possible developments of this study could be to use GPS stations co-located with VLBI radio telescopes in Italy, to compare VTEC estimates at these stations from GIMs and the Cirarolo method and with VTEC from VLBI observations.

2.3 Spectrum Management Activities for Protection of VGOS Systems

The PMD AC has been deeply involved in activities related to the protection of the frequencies observed during geodetic VLBI experiments with legacy antennas and new advanced VGOS radio telescopes. Due to the development of technology for wideband devices and space commercialization, active international telecommunication organizations are asking for and using increasing bandwidth both on the Earth (e.g., 5G) and in space (wide satellite constellations). Because geodetic VLBI has no allocated frequency bands at the International Telecommunication Union (ITU) level, it has become urgent at least to raise the awareness of the risks of the pollution and of the presence of detrimental signals in the 2–14 GHz band. Anyone involved in geodetic VLBI, or in Earth sciences, including researchers, engineers, and policymakers, needs to be informed about the ongoing importance of geodetic VLBI and VGOS technology for accurately measuring the Earth’s rotation and other geodetic parameters.

The action of spectrum management and protection of the Radio Astronomy Service (RAS) in Europe has been taken by the European Committee on Radio Astronomy Frequencies (CRAF) in the so-called ITU Region 1 since 1988. A VGOS Working Group has been formed in order to discuss strategies and actions to be taken at this aim. The group has met in several regular internal meetings; some group members also participate in meetings of interest at the level of the ITU or of the Electronic Communications Committee of European Conference of Postal and Telecommunications Administrations (CEPT/ECC) [7]. The group has also carried out simulations of the impact of signals from telecommunication services on geodetic VLBI observations and fundamentals for the redaction of official documents to defend VGOS observations.

One of the main achievements that has been reached is the approval and publication of the first ITU-R document on geodetic VLBI: the Report RA.2507 “Technical and operational characteristics of the existing and planned Geodetic Very Long Baseline Interferometry” [8]. The report summarizes recent advances in VLBI technology and techniques, including improvements in antenna design and signal processing. It presents also in the annex a list of threshold levels of interference detrimental to VLBI observations for VGOS radio telescopes. The report was approved during the meeting of the Study Group 7 (Scientific Services) of the ITU Radio Communication Section held in Geneva, Switzerland, in October 2022.

2.4 Large-Scale Dimensional Measurements for Geodesy

The AC has taken part in the Stakeholder advisory board of the GEOMETRE project, a joint research project within the European Metrology Research Programme (EMPIR) “Large-scale dimensional measurements for geodesy” (see [9] and the reference therein). The project’s aim was to develop a new generation of large-scale dimensional metrology instruments for geodesy. New algorithms and analysis procedures were developed and applied to improve the quality and reliability of global positioning.

During the project new distance meters with a range of up to 5 km were designed and produced. High-precision systems based on measuring principles

based on simultaneous laser multilateration have been developed for large structure monitoring. A novel strategy for GNSS-based distance determination was also developed. New devices for acoustic thermometry and vertical temperature gradients in outdoor measurements have been realized, and also spectroscopic thermometry has been used in campaigns at Nummela (near the Metsähovi observatory) and Warsaw. To reduce the meteorological uncertainties in precise distance measurements, different methods for refractivity compensation were established and characterized; they were based on classical sensors, on dispersion, on spectroscopic thermometry, and on the speed of sound. Once these systems were validated they were used to study European standard baseline EURO5000 at the Pieniny Kippen Belt, Poland.

Among sensor-based baseline refractive index compensation we show a multi-wavelength interferometer TeleYAG-II that has been developed for measurements under outdoor conditions. After indoor calibration it has been also used to calibrate the baselines of the reference network of the space geodetic station in Metsähovi, Finland.

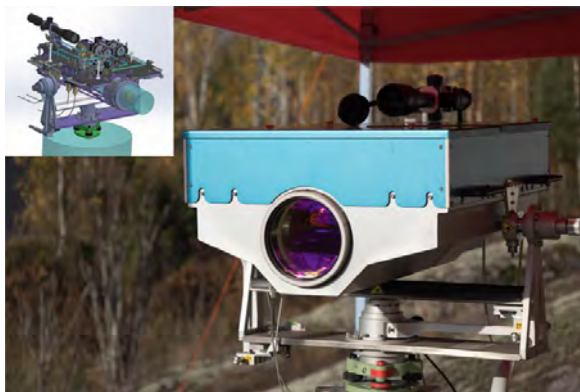

Fig. 4 Multi-wavelength interferometer TeleYAG-II. [Credit: National Metrology Institute of Germany (Physikalisch-Technische Bundesanstalt, PTB)]

The small schematic picture on the left in Figure 4 shows the optical interferometer setup within the system (light beams are indicated in green). Measurements were successfully carried out; in the process, the instrument was able to demonstrate the targeted resistance to external influences as well as its structural long-term stability.

Also, enhanced local tie metrology at GGOS space geodetic core stations was investigated and its benefit for the complex measurement analysis and for the final product critically assessed. Close-range photogrammetry for reference point determination of space geodetic telescopes has also been used. A local gravity field to consider the deviations of the vertical was used in the data processing to reduce the uncertainty of coordinate transformations.

Four progress meetings were organized in the period of project development. The PMD AC participated in two of them during 2020 and in the other two on June 29–30 and November 15–16, 2021. These meetings were online, while the final project meeting was both online and in person at the central office of measurements (GUM) Warsaw during November 21–22, 2022.

3 Future Plans

The PMD AC plans concern continuation of studies on tropospheric parameters in polar regions. Ionospheric parameter estimation in regional areas will also be deeply investigated. Comparisons with products of other space techniques are intended to be carried out, e.g., using satellite measurements or images. Activities to protect the VGOS spectrum from unwanted emissions will be one of the main points to be tackled. New investigations and experiments on time transfer using the VLBI technique are also intended to be carried out during the next biennial period.

Acknowledgements

We acknowledge the Department of Civil and Environmental Engineering (DICA) of Politecnico di Milano University, in particular the Geodesy and Geomatics Area for hosting and supporting the IVS PMD AC activities. We also thank CRAF and IVS for their activities and support and for the provision of data and products. We thank the IRA INAF AC and the Italian “Rete Integrata Nazionale GNSS (RING)” managed by Istituto Nazionale di Geofisica e Vulcanologia (INGV) for research collaborations.

References

1. Böhm J., Sigrid Böhm, Janina Boisits, Anastasiia Girdiuk, Jakob Gruber, Andreas Hellerschmied, Hana Krásná, Daniel Landskron, Matthias Madzak, David Mayer, Jamie McCallum, Lucia McCallum, Matthias Schartner, Kamil Teke. Vienna VLBI and Satellite Software (VieVS) for Geodesy and Astrometry, Publications of the Astronomical Society of the Pacific, Vol. 130(986), 044503, 2018. <https://iopscience.iop.org/article/10.1088/1538-3873/aaa22b>
2. Hofmeister, A. Determination of Path Delays in the Atmosphere for Geodetic VLBI by Means of Ray-Tracing. Ph.D Thesis, Department of Geodesy and Geoinformation, Wien, Austria, 2016.
3. Hoffmann, L.; Günther, G.; Li, D.; Stein, O.; Wu, X.; Griessbach, S.; Heng, Y.; Konopka, P.; Müller, R.; Vogel, B.; Wright, J. S. From ERA-Interim to ERA5: the considerable impact of ECMWF's next-generation reanalysis on Lagrangian transport simulations, *Atmos. Chem. Phys.*, 19, 3097–3124, 2019. <https://doi.org/10.5194/acp-19-3097-2019>
4. Negusini M.; Boyan H. P.; Tornatore V.; Barindelli S.; Martelli L.; Sarti P.; Tomasi C. Water Vapour Assessment Using GNSS and Radiosondes over Polar Regions and Estimation of Climatological Trends from Long-Term Time Series Analysis, *Remote Sensing* 13, No. 23: 4871, doi:10.3390/rs13234871, pp. 1–27, 2021. <https://www.mdpi.com/2072-4292/13/23/4871>
5. Ciraolo, L.; Azpilicueta, F.; Brunini, C.; Meza, A.; Radicella, S.M. Calibration errors on experimental slant total electron content (TEC) determined with GPS. *J. Geod.*, 81, 111–120, 2007.
6. Tornatore V.; Cesaroni C.; Pezzopane M.; Alizadeh M.M.; Schuh H. Performance Evaluation of VTEC GIMs for Regional Applications during Different Solar Activity Periods, Using RING TEC Values. *Remote Sensing*, 13(8):1470, pp. 1–19, 2021. <https://doi.org/10.3390/rs13081470>
7. H. Hase, J.A. Lopez-Perez, M. Bautista-Duran, J. Kallunki, P. Kupiszewski, V. Tornatore, W. Madkour, M. Lindqvist, B. Winkel. Spectrum Management for the VGOS, in 25th European VLBI Group for Geodesy and Astrometry Working Meeting, Cyberspace, 15-18 March 2021, edited by R. Haas, ISBN: 978-91-88041-41-8 E-book, pp. 43-48, 2021. https://www.oso.chalmers.se/evga/25_EVGA_2021Cyberspace.pdf
8. URL 1: https://www.itu.int/dms_pub/itu-r/opb/rep/R-REP-RA.2507-2022-PDF-E.pdf Date of Access: February 2023
9. F. Pollinger, S. Baselga, C. Courde, C. Eschelbach, L. García-Asenjo, P. Garrigues, J. Guillory, P. O. Hedekvist, T. Helojärvi, J. Jokela, U. Kallio, T. Klügel, P. Köchert, M. Lösler, R. Luján, T. Meyer, P. Neyezhmakov, D. Pesce, M. Pisani, M. Poutanen, G. Prellinger, A. Sauthoff, J. Seppä, D. Truong, T. Underwood, K. Wezka, J.-P. Wallerand, M. Wiśniewski. “The European GeoMetre project: developing enhanced large-scale dimensional metrology for geodesy”, *Appl Geom*, 2023. (DOI: 10.1007/s12518-022-00487-3)

Pulkovo Observatory (PUL) Analysis Center Report 2021–2022

Zinovy Malkin

Abstract This report briefly presents activities of the IVS Analysis Center at the Pulkovo Observatory (PUL) during 2021–2022 and plans for the coming years. The main topics of the scientific investigations at the PUL AC in that period were ICRF-related studies and research in the field of Earth rotation and geodynamics. Regular activities include computation of CPO and FCN models (series), OCARS catalog support, and support of the PUL archives of data and products.

1 General Information

The PUL IVS Analysis Center was organized in September 2006. It is located at and sponsored by the Pulkovo Observatory of the Russian Academy of Sciences. It is a part of the Pulkovo EOP and Reference Systems Analysis Center (PERSAC) [1]. The main topics of our IVS-related activity in 2021–2022 were:

- Improvement of the International Celestial Reference Frame (ICRF).
- Analysis of Earth rotation parameters (EOP).
- Modeling of the celestial pole offset (CPO) and free core nutation (FCN).
- Computation and analysis of IVS observation statistics.

The PUL IVS AC webpage [2] is supported, which presents general information about the AC and obtained results.

Pulkovo Observatory

Pulkovo Analysis Center (PUL)

IVS 2021+2022 Biennial Report

2 Staff

The following persons contributed to the PUL activity in 2021–2022:

1. Zinovy Malkin (80%).

3 Activities and Results

3.1 General Activities

Team members participated in the activity of several International study groups such as IAU WG “Multi-waveband International Celestial Reference Frame (optical+VLBI)” in preparation of the next generation ICRF, IAG/IAU/IERS Joint WG “Consistent realization of TRF, CRF, and EOP” (CRTCE), IAG Sub-Commission 1.4 “Interaction of Celestial and Terrestrial Reference Frames”, and IAU/IAG Joint WG “Improving Theories and Models of the Earth’s Rotation” (ITMER).

3.2 ICRF-related Research

- Support of the OCARS catalog (Optical Characteristics of Astrometric Radio Sources) [3] continued. This compiled catalog provides VLBI and *Gaia* positions, source type, redshift info, photometric data in 13 visual bands (including three *Gaia* bands) and three NIR bands, and a cross-identification table with general radio, optical, NIR, Gamma-ray, X-ray, and UV catalogs for 13,690 radio sources

(as of December 2022). The OCARS catalog is updated every several weeks and is available on the PUL webpage [4]. Starting in 2022, each OCARS release consists of six files:

<code>ocars.txt</code>	main catalog file
<code>ocars_p.txt</code>	VLBI position data
<code>ocars_g.txt</code>	Gaia astrometric data
<code>ocars_m.txt</code>	photometry data
<code>ocars_n.txt</code>	cross-identification table
<code>ocars.csv</code>	OCARS in CSV format

- Some new considerations for extending the ICRF source list were discussed in [5]. Statistical analysis of the ICRF catalog allows us to identify less populated sky regions where new ICRF sources or additional observations of the current ICRF sources are most desirable to improve both the uniformity of the source distribution and the uniformity of the distribution of the position errors. It is also desirable to include more sources with a high redshift in the ICRF list. These sources may be of interest for astrophysics. To select prospective new ICRF sources, the OCARS catalog is used. The number of sources in OCARS is about three times greater than in the ICRF3, which gives us an opportunity to select new ICRF sources that were already tested and detected in astrometric and geodetic VLBI experiments.
- To mitigate the impact of outliers on the results when comparing source position catalogs, a new method is proposed in [6], which is based on pixelization data over the equal-area cells, followed by median filtering of the data in each cell. After this, a new data set is formed, consisting of data points near-uniformly distributed over the sphere. The vector spherical harmonics (VSH) decomposition is then applied to this data to finally compute the orientation parameters between ICRF and *Gaia* frames. Several tests with the ICRF3, *Gaia* DR2, and OCARS catalogs showed that the proposed method is practically insensitive to outliers and thus provides robust results of catalogs comparison. Further investigation of two possible sources of random and systematic errors of this method was continued in [7]. Based on several computational tests, the dependence of the results of the determination of the orientation parameters between the ICRF and *Gaia*-CRF catalogs on the number of cells and on the displacement of the pixelization

grid relative to the right ascension origin was estimated. It was found that the results of computations obtained in different test variants differ noticeably, but these differences are within the formal errors of the orientation parameters. Additional tests showed that the main source of these differences is an uneven distribution of the common sources in the compared catalogs over the celestial sphere.

3.3 Earth Rotation Research

- Team members contributed to the investigation of the interconnection between celestial pole motion (CPM) and geomagnetic field (GMF) [8]. The study was based on a joint analysis of the VLBI CPO series and GMF parameters. The results of this study reveal interesting common features in the CPM and GMF variations, which show the potential to improve the understanding of the GMF contribution to the Earth's rotation. Special attention was given to the investigation of the signal correlation between the FCN and GMF, and time lag between geomagnetic jerks and rotational variations.
- A new large jump in the FCN phase in 2022 was detected in [9]. This is only the second such large FCN phase jump in more than 30 years of FCN monitoring by means of VLBI technique. The new event was revealed and confirmed by analyzing two FCN models derived from a long-time series of VLBI observations. A connection of the new FCN phase jump with the recent geomagnetic jerk that started in 2020 is suggested.
- Team members contributed to an investigation of the combined effect of modeling Galactic aberration and ICRF evolution on the EOP derived from VLBI observations [10]. Moving from ICRF2 to ICRF3 leads to constant offsets of 3–15 microarcseconds in dX , dY , and $UT1$. The GA effect was found to be approximately $0.3 \pm 0.3 \mu\text{s}/\text{yr}$ in dY only, which may impact on the results of precession modeling. The performed analysis showed that the VLBI network evolution is an additional factor influencing the GA effect. It decreases when using a set of more uniformly distributed sources or stations in most recent decades.

3.4 Other IVS-related Research

- A correction to paper [11] was published in [12] related to the history of the term “radio astrometry.” In the introduction to the original paper, it was written:

“This can be considered the beginning of the radio astrometry era, although the term itself appeared apparently in the early 1970s (the earliest paper containing this term found by the author was dated 1973).”

After publication of this paper, the author found the text of the lecture given by Thomas Clark at the Institute of Applied Astronomy in 2005 [13]. In this lecture, Clark quoted his note addressed to Robert Coates on February 27, 1969, where he had written:

“we hope to measure positions [of radio sources] to similar accuracies—seconds of arc. These measurements might best be called “Radio Astrometry.”

Thus, the term radio astrometry appeared as early as in 1969, several years earlier than it was assumed in [11].

3.5 Regular Activities

- Computation of two CPO and two FCN series. Some series also include prediction. All the computed series are based on the analysis of the IVS combined CPO solution. The resulting series are available on the PERSAC webpage [1].
- Archiving IVS data in the NGS cards format.
- Archiving IVS and IERS products.
- Development of algorithms and software for data processing and analysis continued.

4 Future Plans

Plans for the coming years include:

- Continuing ICRF-related studies.
- Continuing research on Earth rotation and geodynamics based on VLBI and other space geodesy observations.
- Continuing support of the OCARS catalog.

References

1. <http://www.gaoran.ru/english/as/persac/>
2. http://www.gaoran.ru/english/as/ac_vlbi/
3. Malkin Z. A new version of the OCARS catalog of optical characteristics of astrometric radio sources. *Astrophys. J. Suppl.*, 2018, V. 239(2), id. 20. DOI: 10.3847/1538-4365/aae777
4. http://www.gaoran.ru/english/as/ac_vlbi/#OCARS
5. Malkin Z. On the selection of prospective sources for ICRF extension. In: Proc. 25th EVGA Working Meeting, 14–18 Mar 2021 Cyberspace, Ed. R. Haas, 2021, 34–38. ISBN: 978-91-88041-41-8.
6. Malkin Z. Towards a robust estimation of orientation parameters between ICRF and Gaia celestial reference frames. *MNRAS*, 2021, 506(4), 5540–5547. DOI: 10.1093/mnras/stab2100
7. Malkin Z.M. On Densification of the ICRF Catalog and the Reliability of Its Link to the Gaia Catalog. *Astron. Rep.*, 2022, Vol. 66, No. 9, 778–785. DOI: 10.1134/S1063772922090086
8. Modiri S., Heinkelmann R., Belda S., Malkin Z., Hoseini M., Korte M., Ferrandiz J.M., Schuh, H. Towards Understanding the Interconnection between Celestial Pole Motion and Earth’s Magnetic Field Using Space Geodetic Techniques. *Sensors*, 2021, 21(22), id. 7555 (15 pp.). DOI: 10.3390/s21227555
9. Malkin Z., Belda S., Modiri S. Detection of a New Large Free Core Nutation Phase Jump. *Sensors*, 2022, 22(16), id. 5960. DOI: 10.3390/s22165960
10. Yao J., Liu J.-C., Liu N., Malkin Z., Zhu Z., Huda I.N., Lambert S. Effect of Galactic aberration on Earth orientation parameters: From the ICRF2 to the ICRF3. *Astron. Astrophys.*, 2022, Vol. 665, id. A121. DOI: 10.1051/0004-6361/202243852
11. Malkin Z. Statistical Analysis of the Results of 20 Years of Activity of the International VLBI Service for Geodesy and Astrometry. *Astron. Rep.*, 2020, Vol. 64, No. 2, 168–188. DOI: 10.1134/S1063772920020043
12. Malkin Z.M. Erratum to: Statistical Analysis of the Results of 20 years of Activity of the International VLBI Service for Geodesy and Astrometry. *Astron. Rep.*, 2022, Vol. 66, No. 1, 92. DOI: 10.1134/S1063772922020032
13. Clark T. A., Building the Geodetic VLBI Network. Some Personal Recollections of Tom Clark. Lecture given at Institute of Applied Astronomy (St. Petersburg, 2005), <https://ivscc.gsfc.nasa.gov/meetings/tow2005/Clark.Lec.pdf>

Tsukuba VLBI Analysis Center

Yu Takagi¹, Tomokazu Nakakuki¹, Tetsuya Hara^{1,2}

Abstract The Tsukuba VLBI Analysis Center has been regularly performing near real-time analysis of the weekend IVS Intensive (INT-2) sessions using *c5++* analysis software. This report summarizes the results of the INT-2 analysis and some activities of the Analysis Center during 2021 and 2022.

1 Introduction

The Tsukuba VLBI Analysis Center, located in Tsukuba, Japan, is operated by the Geospatial Information Authority of Japan (GSI). A major role of the Analysis Center is to regularly analyze the weekend IVS Intensive (INT-2) sessions and deliver the results to the community. The analysis is performed in near real-time, and the estimate of UT1-UTC (=dUT1) is provided to the community rapidly after the end of observing. A dedicated link to the SINET6 operated by the National Institute of Informatics (NII) and several process management programs make it possible to derive the solutions rapidly. Our products are utilized for more accurate dUT1 prediction by the U. S. Naval Observatory (USNO) as the IERS Rapid Service/Prediction Center, which is responsible for providing Earth Orientation Parameters (EOP) on a rapid turnaround basis, primarily for real-time users and others needing the highest quality of the EOP information sooner than that available in the final EOP series [1, 2].

1. Geospatial Information Authority of Japan
2. Advanced Engineering Service Co., Ltd.

Tsukuba VLBI Analysis Center

IVS 2021+2022 Biennial Report

2 Component Description

2.1 Analysis Software

An analysis software named *c5++*, which was jointly developed by Hitotsubashi University, the National Institute of Information and Communications Technology (NICT), and the Japan Aerospace Exploration Agency (JAXA) for various space geodetic techniques including SLR, GNSS, and VLBI, is officially used to estimate dUT1 in the regular INT-2 sessions at the Analysis Center [3]. Currently, the analysis software is updated by the institutions mentioned above and by the Onsala Space Observatory [4]. At present, the Analysis Center uses the version 0.0.1 (rev 926) of the analysis software.

The correlation and analysis management programs, so-called *rapid_* programs developed by GSI, can execute all the processes from data transfer through analysis and provide the results consecutively and automatically. *Rapid.c5pp* runs *c5++* on outputs of the bandwidth synthesis process and estimates dUT1 to be delivered to the community quickly. Please refer to the report “Tsukuba VLBI Correlator” in this volume for further details of the *rapid_* programs.

The Analysis Center creates version 4 databases for submission to IVS using *vSolve* developed by NASA GSFC [5]. The version of *vSolve* is 0.6.3 as of December 2022.

2.2 Analysis Center Hardware Capabilities

At the Analysis Center, *c5++* and *vSolve* are installed on several general-purpose and commercially-produced Linux computers to perform dUT1 analysis. The main analysis server has two 10 TB hard disk drives where the VLBI databases and necessary a priori files are stored. One is used as main storage and mirrored by the other regularly.

3 Staff

The technical staff members at the Tsukuba VLBI Analysis Center as of December 2022 are:

- **Yu Takagi** — correlator/analysis chief, management.
- **Tomokazu Nakakuki** — correlator/analysis operator, coordination.
- **Tetsuya Hara (AES)** — correlator/analysis operator, software development.

4 Analysis Operations

4.1 Updates of the Analysis Environment

• New EOP File Format

The IVS decided to update the EOP file format from version 2 to version 3. Following the decision, we modified our program so that the EOP file we provide, *gsiint2c.eopi*, is created in the new format. It is provided in the new file format from the processing of q22323 on November 19, 2022. In addition to the EOP file format, it was decided that the master file format and the name convention of the database would be changed from the beginning of 2023. We are now improving our programs so that they can handle these changes.

• Hardware Update

The Analysis Center hardware underwent a few minor updates during this period. First, we installed a new computer that has a more powerful CPU than the previous one. Second, the hard disk drive used to store the

analysis results such as databases was updated to 10 TB, which enables us to store more results.

Table 1 INT-2 sessions analyzed at the Tsukuba Analysis Center in 2021 and 2022. Is, Mk, Wz and Kk represent ISHIOKA, MK-VLBA, WETTZELL, and KOKEE, respectively.

Year	Baseline	# of sessions	Ave. of dUT1 formal uncertainties
2021	IsMkWz	12	5.9 μ sec
	MkWz	46	6.7 μ sec
	IsWz	15	10.8 μ sec
	KkWz	17	13.0 μ sec
Total		90	8.5 μ sec
2022	IsMkWz	35	7.5 μ sec
	MkWz	62	7.0 μ sec
	IsWz	3	21.0 μ sec
	Total	100	7.7 μ sec

Table 2 Summary of automated processing results.

	2021	2022
# of sessions	90	100
Success in real-time processing	66	56
– Ave. of Latency	1 h 45 m	4 h 19 m
Failed in real time processing	24	44
– Data quality (outlier)	15	14
– <i>rapid_</i> programs failure	1	10
– Station or data transfer failure	8	20

4.2 Summary of UT1-UTC Results

All of the weekend INT-2 sessions were automatically processed at the Analysis Center in near real-time using the *rapid_* programs. The results for INT-2 sessions that were processed at the Analysis Center in 2021 and 2022 are summarized in Table 1. The results were submitted to the IVS Data Centers as *gsiint2c.eopi*. Since 2021, the VLBA antenna at Mauna Kea (MK-VLBA) in Hawaii, U. S., and the Wettzell 20-m station (WETTZELL) in Germany have participated mainly in the INT-2 sessions. The Ishioka station (ISHIOKA) in Japan also participated in INT-2 sessions while it was installing the S/X feed. When MK-VLBA and ISHIOKA were unavailable, Kokee Park (KOKEE) in

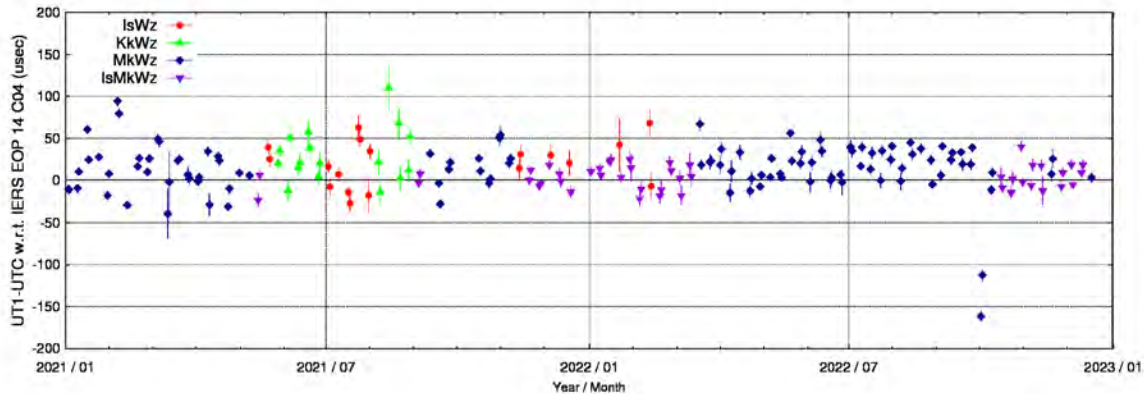

Fig. 1 The time series of UT1-UTC solutions obtained at the Analysis Center with respect to IERS EOP 14C04 from 2021 to 2022. Error bars represent $1\text{-}\sigma$ formal uncertainties.

Hawaii, U. S., replaced them. The average formal errors for total sessions were about 8 microseconds for both 2021 and 2022 (Table 1). It is also shown that the formal errors did not exceed 15 microseconds except in the sessions for the baseline ISHIOKA-WETTZELL in 2022, which were carried out only three times (Table 1). Figure 1 shows the difference of estimated dUT1s from the IERS EOP 14C04 from January 2021 through December 2022.

The results of near real-time processing of INT-2 sessions for 2021 and 2022 are outlined in Table 2. We successfully processed 66 sessions out of 90 sessions in near real-time in 2021, while 56 sessions out of 100 sessions succeeded in real-time processing in 2022. In 2022, we experienced some troubles, including the failure of data transfer and unexpected names for the data files. We created new programs to handle some of these problems. For the sessions processed in near real-time, data transfer took a longer time in 2022 than in 2021. This is the main reason why the latency exceeded four hours in 2022.

5 Outlook

We will continue to analyze the IVS S/X intensive sessions and provide dUT1 products in near real-time. In order to improve the accuracy of dUT1 estimates and to submit more stable products, we will keep updating our automatic processing programs.

References

1. Stamatakos, N., M. Davis, N. Shumate, and M. S. Carter, “Rapid Service/Prediction Centre”, IERS Annual Report 2017, Edited by Wolfgang R. Dick and Daniela Thaller. International Earth Rotation and Reference Systems Service, Central Bureau. Frankfurt am Main: Verlag des Bundesamts für Kartographie und Geodäsie, ISBN 978-3-86482-131-8 (print version), pages 94–116, 2017.
2. Stamatakos, N., M. Davis, N. Shumate, and M. S. Carter, “Rapid Service/Prediction Centre”, IERS Annual Report 2018, Edited by Wolfgang R. Dick and Daniela Thaller. International Earth Rotation and Reference Systems Service, Central Bureau. Frankfurt am Main: Verlag des Bundesamts für Kartographie und Geodäsie, ISBN 978-3-86482-136-8 (print version), pages 102–124, 2020.
3. Hobiger, T., T. Otsubo, M. Sekido, T. Gotoh, T. Kubooka, and H. Takiguchi, “Fully automated VLBI analysis with c5++ for ultra-rapid determination of UT1”, *Earth Planets Space*, **62**, pages 933–937, 2010.
4. Haas, R., T. Hobiger, H.-G. Scherneck, N. Kareinen, G. Klopotek, P.-K. Diamantidis, and J. Strandberg, “Onsala Space Observatory – IVS Analysis Center Activities During 2017-2018”, *IVS 2017+2018 Biennial Report*, Edited by K. L. Armstrong, K. D. Baver, and D. Behrend, NASA/TP-2020-219041, pages 234–238, 2020.
5. Bolotin, S., K. Baver, J. Gipson, D. Gordon, and D. MacMillan, “The First Release of vSolve”, *IVS 2012 General Meeting Proceedings*, Edited by D. Behrend and K. D. Baver, NASA/CP-2012-217504, pages 222–226, 2012.

Universidad de Alicante VLBI Analysis Center (UAVAC) Report

M. Karbon¹, S. Belda¹, A. Escapa², J. M. Ferrándiz¹

1 Abstract

This report describes the VLBI Analysis Center in Alicante and its activities done in 2022 with the aim of becoming an operational certification body. The main objective of the VLBI Analysis Center in Alicante is to analyze all IVS sessions, to regularly send data and analysis products to the IVS Combination Center, and to research and develop models and software to improve the VLBI technique.

2 Introduction

In the first quarter of 2022, we began taking the first steps towards becoming an operational Analysis Center (AC), with the ultimate goal of being a full contributor to future ICRF and ITRF realizations, as well as operational products such as IVS combined EOP products. In this report, we present our group, our technical hardware and software, and our current activities to the community.

3 Alicante Analysis Center Staff

The staff currently consists of five people:

- Jose Manuel Ferrándiz: group leader, EOP theory
- Maria Karbon: Reference frames, operational data analysis, and software development

1. Department of Applied Mathematics, University of Alicante

2. Department of Aerospace Engineering, University of Leon

- Santiago Belda and Alberto Escapa: EOP modeling and theory
- Juan Antonio Martínez Marín: IT and hardware.



Fig. 1 Front row, left to right: Jose Manuel Ferrándiz, Maria Karbon, Santiago Belda; back row, left to right: Alberto Escapa, and Juan Antonio Martínez Marín.

We have a close cooperation with GFZ (GeoforschungsZentrum Potsdam), making efforts to improve the CPO models and validating our results by performing VLBI analysis. Together with GFZ and BKG, we are also participating in the IERS Second EOP Prediction Comparison Campaign. Further, we have close collaborations with the IGN (Instituto Geográfico Nacional), namely Esther Azcue Infanzón and Víctor Puente García, as well as with Mariana Moreira working at the VLBI station on Santa Maria, within the RAEGE project. The aim is sharing know-how and to make the best use and retrieve the most scientific output from the available infrastructure.

4 RAEGE

RAEGE began in 2011 with a Memorandum of Understanding between the Government of the Azores and the Government of Spain to install a VLBI observing network to meet the international requirements required for VGOS, the global VLBI observing system. RAEGE stands for “Red Atlántica de Estaciones Geodinámicas y Espaciales” in Spanish and “Rede Atlântica de Estações Geodinâmicas e Espaciais” in Portuguese.



Fig. 2 The RAEGE network (<https://www.ign.es/web/recursos/COP25/geodesiaespacial.html>)

Figure 2 shows the final configuration of the network; Yebes and Santa Maria are currently operational, Gran Canaria is starting construction, and Flores is in the planning phase. Where possible, VLBI stations are complemented by GNSS, SLR, and superconducting gravimeters. For more information see [López-Pérez, J.A. et al. (2022)] and references therein. The main feature of the RAEGE core sites is their location on three different tectonic plates (Figure 2): the Eurasian plate (Yebes Observatory, Spain), the North American tectonic plate (Flores, Azores), and the African tectonic plate (Gran Canaria, Canary Islands and Santa Maria, Azores), the latter station being on the Azores microplate. This network will go a long way in constraining plate motions, particularly the rotation of the African plate, where we only have one VLBI observatory in South Africa, as well as a notoriously poor network of GNSS stations. It will also provide participating institutions with extensive scientific skills related to hardware and

software development, model extension and testing, conducting custom observing sessions, and more.

5 Hard- and Software

By summer 2022, we installed our first server dedicated mainly to operational analysis: a generic commercially manufactured Linux machine with a 500 GB hard drive (expansion in progress) to which we automatically download the VLBI databases and all required auxiliary files.

On this machine we maintain a frozen version of our analysis software. The upload to the IVS Combination Center is also carried out from this PC. For our operational analysis we are currently using the Vienna VLBI software VieVS, version 3.2. In the future we also plan to use PORT [Schuh et al. (2021)], a VieVS derivative developed at the GFZ. In addition, we are developing a Kalman filter solution in-house to be able to automate analysis as much as possible in near real time [Karbon et al. (2014)].

6 Main Research Topics

The main research activities and results of the UAV IVS Analysis Center during 2022 included:

- EOP prediction
 - implementation of machine-learning techniques
 - active membership in the EOP Prediction Comparison Campaign and the hosting of two related workshops in Alicante
- CPO and FCN related research
 - reevaluation of the nutation theory
 - improved modeling of the FCN
- ICRF related research
 - handling of source position variations
 - comparison and combination of radio source catalogs

7 Current Status and Future Plans

In 2022 we dedicated most of our time to the setup of our hard- and software and to re-analyzing the VLBI data archive, also in view of the ITRF2020 reprocessing. Finally, in March 2023 we are submitting our VLBI analysis results to the IVS Combination Center on a regular basis.

We will continue our fundamental research focused on precession nutation theory, free core nutation, and the celestial reference frame. Our goal is to improve these individual components and therefore all dependent parameters, and to propose methods to improve their consistency and methods for their reliable prediction. In software development, we strive for independence from external tools and as much automation as possible. Furthermore, we intend to take full advantage of the facilities provided by RAEGE and therefore propose our VLBI observations to demonstrate the capabilities of the network, also in combination with other stations. Because some of the RAEGE stations will host not only a VLBI antenna and a GNSS receiver but also an SLR station or a superconducting gravimeter, we strive to directly or indirectly connect these technologies and to extend a technology by using the incorporated information obtained from the others.

8 Acknowledgements

The UAVAC activity is mainly supported by the Generalitat Valenciana through grant PROMETEO/2021/030 from the Conselleria de Innovación, Universidades, Ciencia y Sociedad Digital. Contribu-

tions to partially support the authors' work are from Generalitat Valenciana (SEJIGENT/2021/001), the European Union-NextGenerationEU (ZAMBRANO 21-04), and the Spanish Project PID2020-119383GB-I00 funded by Ministerio de Ciencia e Innovación (MCIN/AEI/10.13039/501100011033/).

References

- Karbon et al. (2014). Maria Karbon, Benedikt Soja, Tobias Nilsson, Robert Heinkelmann, Li Liu, C. Lu, Julian Andres Mora-Diaz, V. Raposo-Pulido, M. H. Xu, Harald Schuh. ERP Estimation using a Kalman Filter in VLBI. In: *Earth Planet Sp* 67, 136 (2015). <https://doi.org/10.1186/s40623-015-0307-y>.
- López-Pérez, J.A. et al. (2022). José A. López-Pérez, João S. Ferreira, Javier González-García, Francisco J. Beltrán-Martínez, Carlos Albo-Castaño, Beatriz Vaquero-Jiménez, Abel García-Castellano, Javier López-Ramasco, Esther Azcue-Infanzón, Pablo de Vicente-Abad, José A. López-Fernández, Francisco M. Wallenstein, Luís R. Santos, Sara Pavão. The Atlantic Network of Geodynamic and Space Stations (RAEGE). In: *International Association of Geodesy Symposia*. Springer, Berlin, Heidelberg (2022). https://doi.org/10.1007/1345_022_152.
- Schuh et al. (2021). H. Schuh, R. Heinkelmann, G. Beyerle, J. M. Anderson, K. Balidakis, S. Belda, S. Dhar, S. Glaser, O. S. Jenie, M. Karbon, C. Kitpracha, P. Küreç Nehbit, L. Liu, S. Lunz, N. Mammadaliyev, S. Modiri, T. J. Nilsson, S. Raut, B. Soja, J. Wang, M. H. Xu. The Potsdam Open Source Radio Interferometry Tool (PORT). In: *Publications of the Astronomical Society of the Pacific*, 133:104503 (13pp) (2021). <https://doi.org/10.1088/1538-3873/ac299c>.

U.S. Naval Observatory VLBI Analysis Center

David Gordon, Megan Johnson, Christopher Dieck, Phil Cigan, Remington Sexton, Andrew Sargent, Lucas Hunt

Abstract This report summarizes the activities of the VLBI Analysis Center at the United States Naval Observatory for calendar years 2021–2022. During this period, Analysis Center personnel analyzed and made timely submissions to IVS of all R4, RV, CRF, and CRD databases and analysis reports; generated seven quarterly EOP updates; made and analyzed VLBA astrometry sessions for ICRF maintenance and enhancement; and engaged in research on active galactic nuclei (AGNs).

1 Introduction

The USNO VLBI Analysis Center is supported and operated by the United States Naval Observatory (USNO) in Washington, DC. It is a part of the Radio Optical Reference Frame Division (RORFD) in the Celestial Reference Frame Department at USNO. The primary services provided by the Analysis Center are the analysis of diurnal and UT1–UTC Intensive sessions and the production of periodic VLBI global solutions for estimation of the Terrestrial Reference Frame (TRF), the Celestial Reference Frame (CRF), and Earth Orientation Parameters (EOP). The Analysis Center continued the submission to the IVS of Intensive (EOP-I) and session-based (EOP-S) Earth Orientation Parameters based on USNO VLBI global solutions. Analysis Center personnel maintain the necessary software required to continue these services to the IVS includ-

ing periodic updates of the GSFC CALC/SOLVE software package. In addition to operational VLBI analysis, Analysis Center personnel are actively engaged in improving the precision and accuracy of UT1–UTC measurements from Intensives and in research related to future updates of the celestial and terrestrial reference frames. The RORFD also actively performs astrophysical research of active galactic nuclei (AGNs) at radio, optical, and X-ray wavelengths.

2 Analysis Center Activities

2.1 IVS Session Analysis and Database Submission

During 2021–2022, personnel at the USNO VLBI Analysis Center continued the timely analysis and submission to IVS of all R4 sessions within 24 hours of database release from the correlators. The Analysis Center also assumed responsibility for the timely analysis and submission of all CRF and CRD sessions and for the scheduling, analysis, and submission of all RDV sessions. Analysis personnel also analyzed all R1, T2, and OHIG diurnal sessions as well as the INT-1, INT-2, INT-3, and INT-00 Intensive sessions released during the period. Automated analysis of Intensive sessions with nuSolve was tested and found to be satisfactory but is not yet actively being used. Further development will be pursued.

United States Naval Observatory

USNO VLBI Analysis Center

IVS 2021+2022 Biennial Report

2.2 Quarterly Solutions

The Analysis Center generated three EOP/TRF/CRF quarterly solutions (usn2021a, usn2021b, and usn2021c) during 2021 and four during 2022 (usn2022a, usn2022b, usn2022c, and usn2022d). These quarterly solutions included diurnal EOP series (EOP-S), UT1–UTC Intensive series (EOP-I), and SINEX solution files for diurnal and Intensive sessions. The latest USNO solutions can be found at <https://crf.usno.navy.mil/quarterly-vlbi-solution>.

2.3 VLBA Intensive Sessions

The Analysis Center continued a program using the Very Long Baseline Array (VLBA), operated by NRAO, to provide a low-latency measurement of UT1–UTC through a variety of Intensive sessions. After 9.5 years of observing VLBA Intensives on the Mauna Kea and Pietown stations of the VLBA, observations on that baseline ceased on April 29, 2021. Simulations from VieSched++ and limited empirical data collected over the preceding decade indicated that Intensives observed on the baseline between the Mauna Kea and Hancock stations would be superior to the existing Intensives. Increased bandwidth to the Hancock VLBA station enabled the Analysis Center to begin testing of 90-minute Intensive sessions observed between the Mauna Kea and Hancock stations in May 2020. The testing validated the simulations, so the Mauna-Kea–Hancock Intensives became the primary VLBA Intensive series on April 30, 2021. At that same time, they began to be scheduled with the VieSched++ package using a semi-automated process to allow for dynamic session scheduling.

2.4 VLBA Celestial Reference Frame Sessions

The Analysis Center scheduled, observed, processed, and analyzed monthly X/S astrometry sessions run on the VLBA for the purpose of ICRF3 maintenance and expansion and for imaging of ICRF3 sources at X/S bands. Approximately 3,000 sources were re-observed multiple times to improve their ICRF positions, and

approximately 360 new sources were added to the X/S CRF. Analysis Center personnel also processed and analyzed monthly VLBA and several southern hemisphere sessions at K-band (24 GHz) as part of a collaboration between USNO and personnel at the South African Radio Astronomy Observatory and the Jet Propulsion Laboratory to maintain and expand the ICRF3-K catalog. During the period, approximately 800 K-band sources were re-observed multiple times to improve their positions, and approximately 90 new K-band sources were added to the K-band CRF. Also during the period, the position and the proper motion of Sagittarius A*, the radio source associated with the supermassive black hole at the center of our galaxy, were determined for the first time in the ICRF3 frame at K-band.

2.5 Source Position Time Series Analysis

Analysis Center personnel generated several source position time series solutions at both X/S and K-band during the period. These solutions give the position of each source for each epoch for which it was observed. These solutions are being used to study the positional stability of ICRF sources. The latest time series solutions can be found at our website at <https://crf.usno.navy.mil/quarterly-vlbi-solution>.

2.6 VGOS Session Analysis

Analysis Center personnel are investigating the use of the VGOS Intensive and diurnal sessions for future EOP and TRF solutions. A preliminary VGOS Intensive UT1 series has been generated and is being periodically updated for research purposes. Also, X/S plus VGOS global solutions have been made in order to locate the new VGOS stations into the TRF. But it has been found that these solutions introduce small rotations of the celestial reference frame, indicating some issues in aligning the X/S TRF with the VGOS TRF. Further study is ongoing.

3 Staff

The Analysis Center is composed of seven USNO personnel. Their responsibilities and research areas are listed in Table 1.

Table 1 USNO VLBI Analysis Center staff in 2021–2022.

Name	Responsibilities
Megan Johnson	Diurnal session analysis, quarterly solutions, ITRF2020 solutions, USNO VLBA management, AGN research.
David Gordon	Diurnal session analysis, CRF/TRF/EOP solutions, RV and VLBA scheduling and analysis, ICRF solutions, ITRF2020, VGOS TRF/EOP solutions, source time series analysis.
Christopher Dieck	Intensive and diurnal session analysis, VLBA Intensive analysis and PI, internal software development and support.
Phil Cigan	Quarterly TRF/EOP/CRF solutions, diurnal session analysis, source time series analysis, AGN research.
Remington Sexton	Diurnal session analysis, AGN research at radio and optical wavelengths.
Andrew Sargent	Systems administration, Intensive and diurnal session analysis, AGN research.
Lucas Hunt*	VLBA and RDV calibration and imaging CRF source structure research, VLBA time allocation management.

*Now at NRAO

4 Future Activities

The following activities for 2023–2024 are planned:

1. Continue development of automated Intensive processing.
2. Determine VGOS station positions and velocities in support of operational analysis of VGOS Intensives.
3. Disseminate the master files and vgosDBs of the Mk–Pt and Hn–Mk VLBA Intensives to IVS.
4. Continue maintenance and expansion of the ICRF-X/S and ICRF-K catalogs and participate in the

next realization of the ICRF at multiple radio and optical wavelengths.

5 Relevant Publications

1. “A New Wiggle in the Wobble? Uncovering Periodic Signals in Intensive Series”, Christopher Dieck, Megan Johnson, IVS 2022 General Meeting Proceedings, Kyla L. Armstrong, Dirk Behrend, and Karen D. Bayer, editors, NASA/CP-20220018789, 2023.
2. “Current CRF Status at X/S and K Bands”, David Gordon, Aletha de Witt, Christopher S. Jacobs, IVS 2022 General Meeting Proceedings, Kyla L. Armstrong, Dirk Behrend, and Karen D. Bayer, editors, NASA/CP-20220018789, 2023.
3. “Three Years of ICRF3 Source Positions”, Phil Cigan, David Gordon, Megan Johnson, IVS 2022 General Meeting Proceedings, Kyla L. Armstrong, Dirk Behrend, and Karen D. Bayer, editors, NASA/CP-20220018789, 2023.
4. “Sources with Significant Astrometric Offsets Between the S/X and K-band Celestial Frames”, Aletha de Witt, Christopher S. Jacobs, David Gordon, Lucas Hunt, Megan Johnson, IVS 2022 General Meeting Proceedings, Kyla L. Armstrong, Dirk Behrend, and Karen D. Bayer, editors, NASA/CP-20220018789, 2023.
5. “ICRF3 Position and Proper Motion of Sagittarius A* from VLBA Absolute Astrometry”, David Gordon, Aletha de Witt, Christopher S. Jacobs, IVS 2022 General Meeting Proceedings, Kyla L. Armstrong, Dirk Behrend, and Karen D. Bayer, editors, NASA/CP-20220018789, 2023.
6. “Overview and Status of the International Celestial Reference Frame as Realized by VLBI”, Aletha de Witt, Patrick Charlot, David Gordon, Christopher S. Jacobs, 2022, *Universe* 2022, 8, 374. (<https://www.mdpi.com/2218-1997/8/7/374>)
7. “Position and Proper Motion of Sagittarius A* in the ICRF3 Frame from VLBI Absolute Astrometry”, David Gordon, Aletha de Witt, Christopher S. Jacobs, 2023, *The Astronomical Journal*, 165:49. (<https://iopscience.iop.org/article/10.3847/1538-3881/aca65b/pdf>)

USNO Analysis Center for Source Structure

Megan Johnson, Lucas Hunt, Phil Cigan, David Gordon, Christopher Dieck

Abstract This report summarizes the activities of the United States Naval Observatory Analysis Center for Source Structure for the 2021 and 2022 calendar years.

1 Introduction

The Analysis Center for Source Structure is supported and operated by the United States Naval Observatory (USNO). It was accepted by the IVS as a “Special Associate Analysis Center” in January 2000, with the charter to provide products directly related to the IVS determination of the “definition and maintenance of the celestial reference frame.” These products are to include radio images of International Celestial Reference Frame (ICRF) sources, intrinsic structure models derived from the radio images, and an assessment of the astrometric quality of the ICRF sources based on the radio images.

Over the past two years, USNO has developed and deployed new web pages which include the new Fundamental Reference Image Data Archive (FRIDA), in support of the Analysis Center for Source Structure hosting images of ICRF sources across the radio spectrum. FRIDA is available through USNO’s new web interface located at the following link: <https://crf.usno.navy.mil/FRIDA>. FRIDA includes images of quasars at radio frequencies at 2.3 GHz (S-band), 8.4 GHz (X-band), 15 GHz (Ku-band), 22 GHz (K-band), and 43 GHz (Q-band). USNO intends to grow

United States Naval Observatory

USNO Analysis Center for Source Structure

IVS 2021+2022 Biennial Report

the number of images in the coming years and expand to other areas of the electromagnetic spectrum.

In this report, we present an overview of FRIDA and highlight some of its features and current capabilities. We also describe the calibration and imaging efforts that have enabled this data archive of radio images. We highlight some scientific interests using the results from our imaging efforts and conclude with future plans for making improvements and upgrades to explore with FRIDA.

2 Analysis Center for Source Structure Operation

The primary service of the Analysis Center for Source Structure is to populate and maintain a web-accessible data archive of radio frequency images of ICRF sources. Originally developed beginning in mid-1996, this data archive was previously known as the ‘Radio Reference Frame Image Database’ (RRFID). Its web-accessible database contained JPEG files of X and S images of most ICRF sources north of -30° declination, mainly from the IVS-supported Research and Development VLBI (RDV) sessions, which are sessions using the Very Long Baseline Array (VLBA) plus IVS geodesy stations. USNO images these RDV sessions jointly and in collaboration with the University of Bordeaux. The astrometry of the RDV sessions is measured and maintained in collaboration with USNO and the Goddard Space Flight Center (GSFC).

Beginning in 2017, this data archive was renamed the ‘Fundamental Reference Image Data Archive’ (FRIDA) and has since been developed with an

improved and more functional interface. FRIDA¹ was made publicly available in 2022. FRIDA currently contains ~15,000 VLBI images collected over the past ~30 years.

2.1 FRIDA Overview

The USNO web interface for FRIDA can be found here: FRIDA, and Figure 1 displays a screenshot of the FRIDA homepage.

The top left panel shows an all-sky map of the ICRF sources available in FRIDA with right ascension along the x-axis and declination along the y-axis. The default settings when FRIDA loads are set to highlight all of the ICRF-defining sources from all three realizations of the reference frame. The selected sources are indicated with the green-filled red circles on the all-sky map. The data for all of these selections are provided in the interactive list shown on the right side of the screen. Users are able to download all of the selections by clicking on the ‘Download Now’ button in the top right corner. But users should be sure that the filter settings are set appropriately for downloading, as FRIDA will download all data for all sources shown in the list in the right panel. Users can search, filter, and refine searches using the options listed under the all-sky map.

If users click on one of the green-filled red circles shown on the all-sky map, a pop-up window will appear with the source images available per the search criterion selected. The default setting will show all images for all radio frequencies available for the selected source. In addition to the images, FRIDA also provides some diagnostic plots and figures on the individual images shown in the image panel. Figure 2 shows an example of ICRF-defining source IERS 0722+145.

FRIDA shows a list of the common names for the selected source in the top panel and gives the center coordinates of the source in the upper right hand corner of the pop-up window. FRIDA displays a timeline at the bottom of the window with the available bands and corresponding images for the source shown by the color-filled circles. For example, the X-band images are designated by the solid blue circles, while the K-band images are shown by the solid yellow circles. The user can load multiple images into the image panel shown

in the middle left side of the window by clicking on these color-filled circles and then page through the images using the buttons under the image panel itself. In the middle panel, FRIDA displays the uv -coverage map and, in the far right panel, the amplitude and phase distributions as functions of uv distance. These three diagnostic plots can be used to gauge image quality.

Users are able to adjust the contour levels and contrast scaling shown in the image panel by clicking on the Settings wheel in the upper right of the image panel. Figure 3 shows an example of the settings that can be toggled and adjusted for a given image.

If users wish to download any of the images for a given source, they simply return to the main FRIDA website homepage and filter the selection to show the source they are interested in accessing and then click on the ‘Download Now’ button. FRIDA provides image FITS files, calibrated uv data files, model files created and used in the Common Astronomy Software Applications (CASA) imaging process, and imaging log files (where available), among other image-related files and information (see Section 3.1 for details).

Images of ICRF sources can also be obtained from the Bordeaux VLBI Image Database (BVID) at BVID, as well as through the Radio Fundamental Catalog (RFC).

3 Current Activities

3.1 VLBA Imaging

VLBA observations for maintenance of the celestial and terrestrial reference frames have been carried out since approximately 1994, when the VLBA was in its early commissioning days. The RDV sessions described in Section 2 are 24 hours in duration and observe approximately 80 ICRF sources at S- and X-bands (2.3/8.4 GHz) using the canonical geodetic style of observing where both bands are observed simultaneously. These sessions combine the VLBA together with up to ten additional geodetic VLBI antennas. Images have been produced from some of these sessions and made available through FRIDA.

Beginning in January 2017, USNO entered into a timeshare agreement with the National Science Foundation (NSF) for supporting 50% of the oper-

¹ <https://crf.usno.navy.mil/FRIDA>

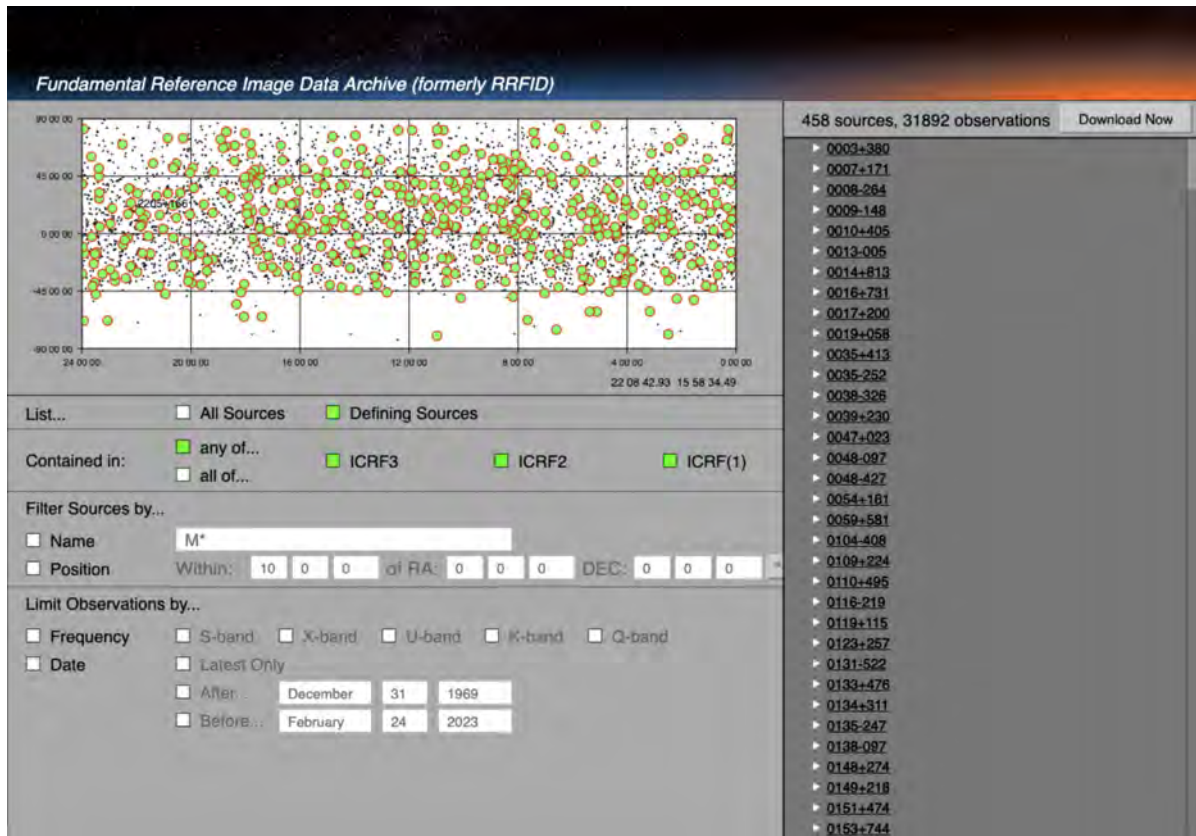

Fig. 1 FRIDA website homepage.

ational costs of the VLBA in exchange for 50% of the observing time. USNO began observing ICRF sources for the purposes of astrometry, geodesy, and imaging under this timeshare agreement. Since the start of the 50% timeshare agreement, in collaboration with GSFC, USNO has been running a VLBA-only series of observations called the UF/UG/UH-series. This series is observed at S/X-band (2.3/8.4 GHz) and is dual purpose in that the 24-hour experiments are designed for astrometry and geodesy but scheduled to optimize the uv coverage of each source for imaging. The UF/UG/UH-series contains roughly 225 sources per 24-hour session, most of which have been either ICRF-defining sources or weaker ICRF sources under-observed in IVS sessions. Understanding the source structure characteristics of these sources is paramount to improving and maintaining the ICRF because they constitute the majority of the ICRF and future ICRF sources.

In addition to the UF/UG/UH-series, USNO has also been supporting a series of K-band observations with the VLBA through the timeshare agreement. The principal investigator of this project is Dr. Aletha de Witt from the South African Radio Astronomy Observatory. Nearly all of the K-band data that are included in the recently adopted ICRF3 have come from this VLBA project. These observations are also optimized for imaging, and these data and images are planned to be included in a future version of FRIDA.

3.2 CASA Imaging Pipeline

A CASA calibration and imaging pipeline for producing the VLBA images in FRIDA was developed by Dr. Lucas Hunt over the course of several years. The details of the calibration and imaging process used for FRIDA are described in Hunt et al. 2021. The CASA pipeline

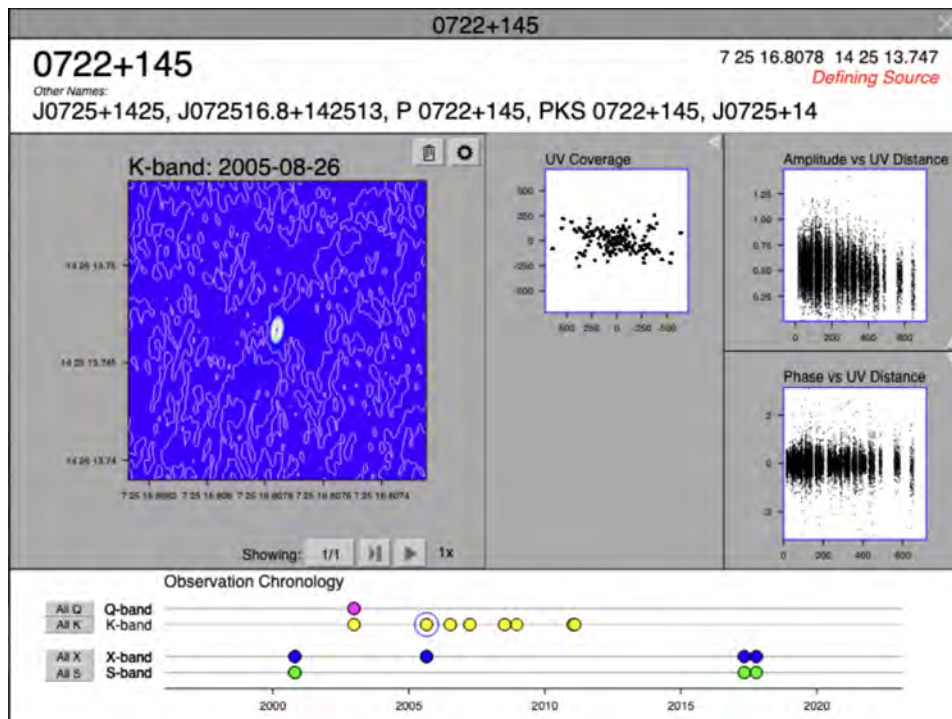

Fig. 2 FRIDA pop-up window displaying single source data and images.

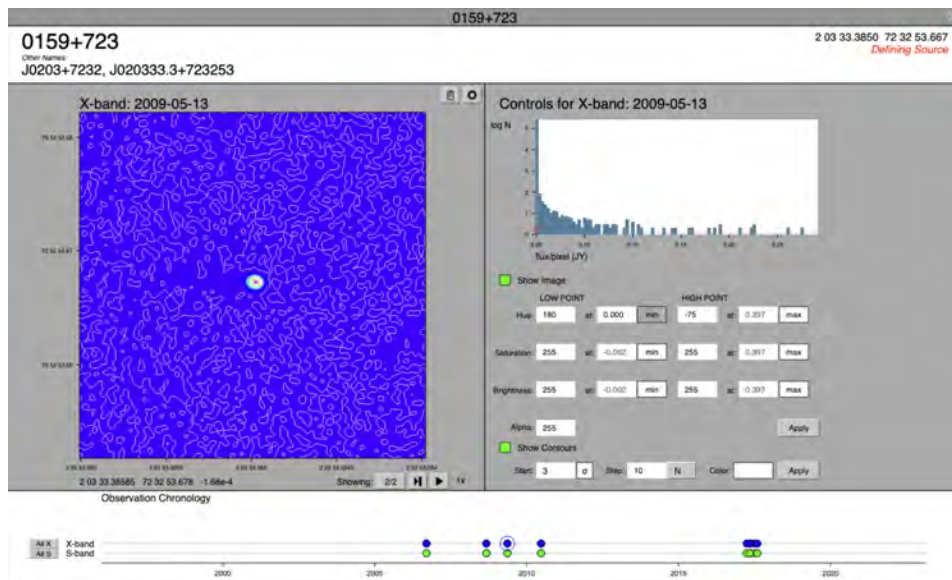

Fig. 3 FRIDA control settings pop-up display.

includes an automated Radio Frequency Interference (RFI) removal algorithm that is implemented in the calibration process using a standalone flagging algorithm called AOFlagger (Offringa et al. 2012). The current

versions of the calibration and imaging pipelines can be applied to S- and X-band VLBA datasets, and users can access these scripts through the USNO website at the following links: calibration and imaging.

4 Conclusion and Future Work

Over the past two years, USNO has taken on a large initiative to revamp, improve, and refine its role as the Analysis Center for Source Structure and has developed and deployed a new image archive called FRIDA. FRIDA is available through a website interface where users have access to $\sim 15,000$ images of ICRF sources that span a temporal baseline of nearly three decades. USNO has many research initiatives underway that make use of the VLBA imaging work described herein.

During April, May, and June of 2021, the Analysis Center for Source Structure participated in consecutive X/S-, K-, and Q-band VLBA astrometry sessions using the same source lists and schedule files. The goal was to obtain near-simultaneous images of approximately half of the K-band ICRF sources at four frequencies. Our collaborators in the project were Dr. Aletha de Witt at the South African Radio Astronomy Observatory and Christopher Jacobs at the Jet Propulsion Laboratory. Source images have been made for all of these sessions, and each source is being compared at the four frequencies. Details of these observations and first results can be found in Hunt et al. 2022. Exploring the ICRF source structure and flux intensity at higher frequencies is an ongoing effort for understanding what the optimal frequency band(s) are in the radio domain for future iterations of the ICRF.

The Analysis Center for Source Structure is working on improving, modifying, and adding new features and data to FRIDA over the coming few years. Some features we aim to improve are mitigating the latency issues users have experienced when first loading the homepage to FRIDA as well as adding new data to the archive. USNO also aims to add new information such as measured fluxes from the images at the different frequencies observed.

5 Staff

The staff of the Analysis Center for Source Structure during 2021–2022 consisted of Lucas Hunt², Megan Johnson, Phil Cigan, Christopher Dieck, and David Gordon. Lucas Hunt has been the primary lead in developing the CASA imaging pipeline and generating

new images displayed in the current instance of FRIDA.

6 Relevant Publications

Publications of relevance to Analysis Center activities:

1. “Imaging Sources in the Third Realization of the International Celestial Reference Frame”, Hunt, Lucas R., Johnson, Megan C., Cigan, Phillip J., Gordon, David, & Spitzak, John, 2021, *The Astronomical Journal*, 163, 121
2. “Comparing Images of ICRF Sources at X-, K-, and Q-band”, Hunt, Lucas R., de Witt, Aletha, Gordon, David, Jacobs, Christopher S., & Johnson, Megan C., 2023, *IVS 2022 General Meeting Proceedings*, Kyla L. Armstrong, Dirk Behrend, and Karen D. Baver, editors, NASA/CP-20220018789
3. “CASA Architecture and Applications,” McMullin, J. P., Waters, B., Schiebel, D., Young, W., & Golap, K., 2007, *Astronomical Data Analysis Software and Systems XVI (ASP Conf. Ser. 376)*, ed. R. A. Shaw, F. Hill, & D. J. Bell (San Francisco, CA: ASP), 127
4. “A morphological algorithm for improving radio-frequency interference detection,” Offringa, A. R., van de Gronde, J. J., & Roerdink, J. B. T. M., 2012, *Astronomy & Astrophysics*, 539, A95

Acknowledgements

The authors acknowledge use of the Very Long Baseline Array under the U.S. Naval Observatory’s time allocation. This work supports USNO’s ongoing research into the celestial reference frame and geodesy. The authors acknowledge use of the automated flagging algorithm, AOFlagger, developed and provided by André Offringa (Offringa et al. 2012). The National Radio Astronomy Observatory is a facility of the National Science Foundation operated under cooperative agreement by Associated Universities, Inc. The authors acknowledge use of CASA in this work, which is provided by the National Radio Astronomy Observatory.

² Now at NRAO

Vienna Analysis Center Report 2021–2022

Hana Krásná¹, Leo Baldreich¹, Johannes Böhm¹, Sigrid Böhm¹, Jakob Gruber¹, Andreas Hellerschmied², Frédéric Jaron¹, Lisa Kern¹, David Mayer², Axel Nothnagel¹, Olivia Panzenböck¹, Helene Wolf¹

Abstract The IVS Analysis Center VIE is jointly run by the Technische Universität Wien (TU Wien) and the Bundesamt für Eich- und Vermessungswesen (Federal Office of Metrology and Surveying, BEV) since 2018. During the last two years, we contributed to the realization of the International Terrestrial Reference Frame 2020 with the reanalysis of VLBI sessions. Beside the regular operational analysis of VLBI sessions and estimation of global terrestrial and celestial reference frames along with Earth orientation parameters, we work on a variety of topics. For example, we focused on the optimization of scheduling and analysis of simulated data to satellites, on studies regarding Intensive sessions, and on an extended Earth rotation parameterization with continuous piecewise linear functions.

1 General Information

Technische Universität Wien (TU Wien) and the Federal Agency of Metrology and Surveying (BEV) are jointly running the VLBI Analysis Center VIE in Vienna as agreed upon in the summer of 2018 by signing a memorandum of understanding. At TU Wien the Analysis Center is attached to the Research Unit Higher Geodesy (HG), which is one of eight Research Units within the Department of Geodesy and Geoinformation (GEO). Besides VLBI, the research focus of Higher Geodesy is on satellite navigation and studies

1. Technische Universität Wien

2. Bundesamt für Eich- und Vermessungswesen

VIE Analysis Center

IVS 2021+2022 Biennial Report

in the field of the Earth system. At BEV the Analysis Center is attached to the Department of Control Survey, which, e.g., is running the satellite positioning service APOS. Figure 1 shows members of the Research Unit Higher Geodesy and the BEV during the retreat in Payerbach-Reichenau. Since that time (September 2022) Hana Krásná has been chairing the VLBI Analysis Center VIE in Vienna.

2 Activities during the Past Two Years

2.1 Vienna VLBI and Satellite Software

The label VieVS (Vienna VLBI and Satellite Software for Geodesy and Astrometry, [1]) embraces all software developed and maintained by the HG group. Free access to all VLBI-related modules is offered via our GitHub account at <https://github.com/TUW-VieVS>. We provide VLBI analysis software, a VLBI raw data simulator VieRDS [2], and the VLBI scheduling tool VieSched++ [3], which is now continued and further developed by Matthias Schartner at ETH Zürich with ongoing cooperation in the field of satellite observations. The latest version of VieVS-VLBI (after release tag V3.3) incorporates ITRF2020 [4] site positions, velocities, and post-seismic deformation and can handle vgosDB files with the new naming convention (master file version 2). More information about VieVS can be found on our revamped Wiki page <https://viewswiki.geo.tuwien.ac.at> and at the VieVS YouTube channel.

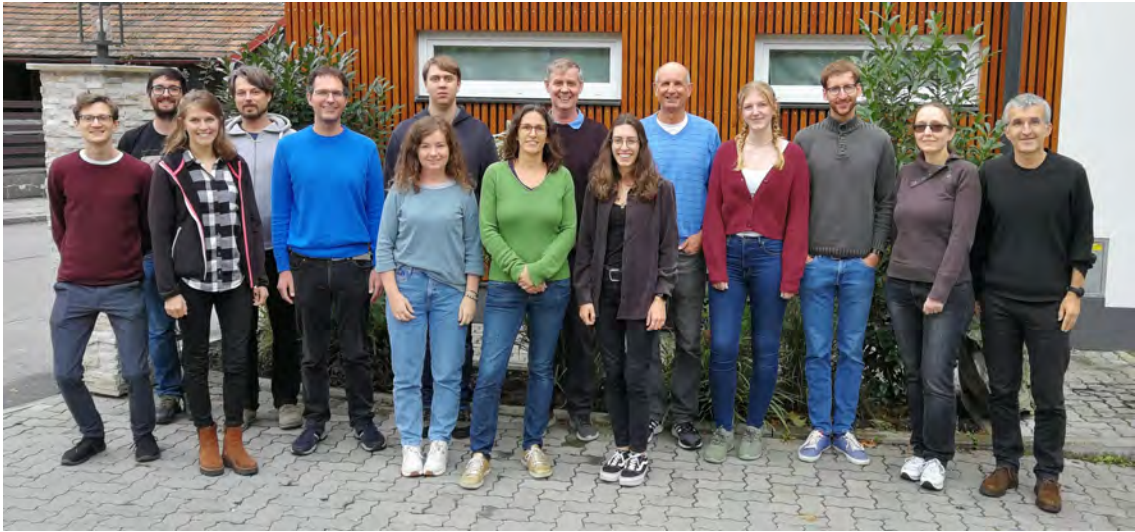

Fig. 1 Members of the Research Unit Higher Geodesy and BEV at the retreat in Payerbach-Reichenau (Austria) in September 2022.

Table 1 VIE members ordered alphabetically with their main tasks related to VLBI.

Leo Baldreich (since 01/2022)	Operational VLBI processing, student assistant
Johannes Böhm	Reference frames, Chair of HG
Sigrid Böhm	VieVS administrator, Earth orientation
Jakob Gruber	Correlation and fringe-fitting, raw data simulation
Andreas Hellerschmied	Operational VLBI processing
Frédéric Jaron	EU-VGOS, correlation and fringe-fitting
Lisa Kern	Intensive sessions, Earth orientation
Hana Krásná	Reference frames, VLBI global solutions
David Mayer	Operational VLBI processing, ITRF2020 submission
Axel Nothnagel	Consultant
Olivia Panzenböck	Analysis of EU-VGOS sessions, student assistant
Helene Wolf	VLBI observations to satellites, website

2.2 VLBI Observations to Satellites

In the last few years, the software VieSched++ was equipped with a satellite scheduling module that enables the planning of satellite observations in a schedule together with quasar observations, either manually or automatically [5].

Further, so-called Dilution of Precision (DOP) factors were introduced representing the sensitivity of a satellite observation with VLBI towards the components of the satellite position in the local orbital frame with the normal, tangential, and cross-track directions [6]. The results demonstrated that the normal compo-

nent is significantly worse determinable compared to the tangential and cross-track components. The highest sensitivities towards the tangential and cross-track directions arise if the satellite track and the observing baseline are parallel or orthogonal, respectively. These DOP factors could be used as an optimization criterion during the scheduling process of a satellite scan.

Additionally, the software package VieVS was equipped with the estimation of piecewise linear offsets of the individual components of the satellite position and the orbital elements, i.e., right ascension of the ascending node as a first test. For this, schedules were created using VieSched++ and simulated and

analyzed using VieVS, and the results were assessed based on the repeatabilities and mean formal errors [7].

2.3 EU-VGOS

The EU-VGOS project [8, and references therein] was initiated in 2019 with the aim of investigating methods for the post-processing of Level-1 VGOS data. VGOS telescopes observe in dual-linear polarization mode. One of the main purposes of the EU-VGOS project is to explore how to best combine the two linear polarizations to Stokes I . EU-VGOS is currently a collaboration of about 50 individuals from different research institutes, mainly located in Europe but also beyond. The EU-VGOS collaboration has observed a number of research and development sessions, which are available for analysis. The network of these sessions consists of the European VGOS stations (i.e., Oe, Ow, Ws, and Yj at the time of observation) and is sometimes joined by Is in Japan.

At TU Wien we investigate how to best make use of these sessions in the framework of a geodetic analysis with VieVS with a special focus on tropospheric parameter estimation and with Earth orientation parameters being the estimated parameters of interest. This will help in the future to enable the investigation of differences between databases created from fringe-fitting *pseudo*-Stokes I data (generated by the Haystack VGOS pipeline) and data that have been calibrated and converted to circular polarization using the PolConvert software [9].

2.4 Earth Orientation and Intensive Sessions

At TU Wien, we routinely analyze the IVS VLBI sessions. In the last few years, we have refined our automatic processing of VLBI Intensive sessions and re-processing of 24h sessions. This includes an iterative analysis with VieVS and an automated generation of an EOP file on a daily basis (current version *vie2022b.eopi* available at <https://www.vlbi.at/products>). A daily updated *.eoxy* file, including the EOP from standard 24h sessions, can also be found on our website.

Furthermore, studies regarding VLBI Intensive sessions and their performance have been carried out at TU Wien. It has been shown that the orientation of the single baseline, the selection and distribution of observed sources, especially in right ascension, the scheduling optimization strategy as well as the accuracy of the a priori values have a high impact on the accuracy of the UT1 estimate [10, 11, 12]. Additionally, a study regarding the Southern Intensives (SI) program, initiated by our group in late 2019, has been published. On the basis of 53 sessions from 2020 and 2021 observed between Hartebeesthoek (HART15M, Ht), Yarragadee (YARRA12M, Yg), and Hobart (HOBART12, Hb), we were able to show the competitiveness of the SI sessions in comparison to regularly observed Intensive sessions [13].

2.5 Extended Earth Rotation Parameterization with Continuous Piecewise Linear Functions

Continuous piecewise linear functions are a helpful way of parameterizing time series in least-squares adjustments employing a Gauss-Markov model. This approach is investigated for extended Earth rotation parameterization in collaboration of several IVS Analysis Centers under the lead of TU Wien [14]. The current approach of Earth rotation parameter estimation with 24-hour offsets and rates has deficits stemming from the mismatch of tabulated a priori EOP values at day boundaries and the two-calendar-day spanning of contemporary IVS observing sessions. In addition, the current EOP parameterization causes a mismatch of the IVS-derived EOPs labeled with “24 hours” with the daily EOPs derived from other space-geodetic techniques.

The project provided the first results in 2022 concluding that differences between celestial pole offset estimates and fixed modeled a priori values lead to systematics in the sub-daily piecewise linear polar motion estimates. A solution for handling celestial pole offsets in a rigorous way for operational purposes is under investigation.

2.6 Vienna VLBI Contribution to the ITRF2020

The VIE group contributed to the generation of the ITRF2020 by submitting sessions to the IVS Combination Center. More than 6000 sessions were analyzed including, for the first time, the new VGOS sessions. A state-of-the-art VLBI analysis was performed with the ITRF2014 [15] and ICRF3 [16] as a priori reference frames and the IERS EOP 14C04 series [17] as a priori EOP. The IERS Conventions 2010 [18] were used to calculate the computed delay. Since the creation of the ITRF2014, a couple of new models have emerged. The following new models were included in the contribution to the ITRF2020:

- New mean pole-tide model
- New high-frequency EOP model [19]
- Galactic aberration
- Gravitational deformation of VLBI antennas [20]

The VIE solution is the only VLBI submission that uses piecewise linear offsets for the parameterization of the EOP. After initial complications the combination with the other submissions was successful.

2.7 Reference Frames

At VIE we generate our own global terrestrial and celestial VLBI reference frames. The solutions are created in a common least-squares adjustment using the software VieVS. The recent solution VIE2022b [21] contains observations until June 2022 (with and without VGOS sessions), and together with the Earth orientation parameters, it is publicly available at <https://www.vlbi.at/products>. Within the established VLBI Working Group on TRF Scale, several possible reasons for the present discrepancy between the scale of the ITRF2020 and the scale coming from VLBI observations have been investigated. Furthermore, Hana Krásná analyzes K-band (24 GHz) VLBI observations and compares the resulting CRF and EOP with solutions provided by David Gordon at the United States Naval Observatory.

3 Future Plans

In addition to the continuation of the work described above, we have plans for new research:

- Under the umbrella of VieVS, we are going to develop stand-alone Python software for the combination of VLBI sessions. At a later stage, this software will also allow the combination with other space-geodetic techniques.
- The regular update of the reference frames at VIE is foreseen.
- In project SOFT, approved by the Austrian Science Fund, we will concentrate on source structure in VGOS fringe-fitting.

Acknowledgements

We are very grateful to the Austrian Science Fund (FWF) for supporting our work with the projects Galactic VLBI (T 697), VGOS Squared (P 31625), and VLBI2Galileo (P 33925).

References

1. J. Böhm, S. Böhm, J. Boisits, A. Girdiuk, J. Gruber, A. Hellerschmied, H. Krásná, D. Landskron, M. Madzak, D. Mayer, J. McCallum, L. McCallum, M. Schartner, K. Teke. Vienna VLBI and Satellite Software (VieVS) for Geodesy and Astrometry. *Publications of the Astronomical Society of the Pacific*, 130(986), 044503, 2018.
2. J. Gruber, A. Nothnagel, J. Böhm. VieRDS: A Software to Simulate Raw Telescope Data for Very Long Baseline Interferometry. *Publications of the Astronomical Society of the Pacific*, 133(1022), 2021.
3. M. Schartner, J. Böhm. VieSched++: A new VLBI scheduling software for geodesy and astrometry. *Publications of the Astronomical Society of the Pacific*, 131(1002), ab1820, 2019.
4. Z. Altamimi, P. Rebischung, X. Collilieux, L. Métivier, K. Chanard. ITRF2020: main results and key performance indicators. *EGU General Assembly 2022*, 3958, doi:10.5194/egusphere-egu22-3958, 2022.
5. H. Wolf. Satellite scheduling with VieSched++. *Master thesis, Technische Universität Wien*, doi:10.34726/hss.2021.87526, 2021.
6. H. Wolf, J. Böhm, M. Schartner, U. Hugentobler, B. Soja, A. Nothnagel. Dilution of Precision (DOP) factors for evaluating observations to Galileo satellites with VLBI. *Internationa-*

- tional Association of Geodesy Symposia*, Springer, Berlin, Heidelberg, doi:10.1007/1345_2022_165, 2022.
7. H. Wolf, J. Böhm, A. Nothnagel, U. Hugentobler, M. Schartner. Adjustment of Galileo Satellite Orbits with VLBI Observations: A Simulation Study. *IVS 2022 General Meeting Proceedings*, edited by Kyla L. Armstrong, Dirk Behrend, and Karen D. Baver, NASA/CP-20220018789, 288-292, 2023.
 8. E. Albentosa *et al.*. Current Status of the EU-VGOS Project. *IVS 2022 General Meeting Proceedings*, edited by Kyla L. Armstrong, Dirk Behrend, and Karen D. Baver, NASA/CP-20220018789, 2023.
 9. I. Martí-Vidal, A. Roy, J. Conway, A. J. Zensus. Calibration of mixed-polarization interferometric observations. Tools for the reduction of interferometric data from elements with linear and circular polarization receivers. *A&A*, 587, A143, doi:10.1051/0004-6361/201526063, 2016.
 10. L. Kern, M. Schartner, J. Böhm, S. Böhm, A. Nothnagel, B. Soja. Impact of the Source Selection and Scheduling Optimization on the Estimation of UT1-UTC in VLBI Intensive Sessions. *IVS 2022 General Meeting Proceedings*, edited by Kyla L. Armstrong, Dirk Behrend, and Karen D. Baver, NASA/CP-20220018789, 167-171, 2023.
 11. L. Kern, M. Schartner, J. Böhm, S. Böhm, A. Nothnagel, B. Soja. On the importance of accurate pole and station coordinates for VLBI Intensive baselines. *submitted to Journal of Geodesy*, 2023.
 12. M. Schartner, L. Kern, A. Nothnagel, J. Böhm, B. Soja. Optimal VLBI baseline geometry for UT1-UTC Intensive observations. *Journal of Geodesy*, 95:75, 2021.
 13. S. Böhm, J. Böhm, J. Gruber, L. Kern, J. McCallum, L. McCallum, T. McCarthy, J. Quick, M. Schartner. Probing a southern hemisphere VLBI Intensive baseline configuration for UT1 determination. *Earth, Planets and Space*, 74:118, 2022.
 14. A. Nothnagel, S. Böhm, R. Dach, M. Glomsda, H. Hellmers, A.-S. Kirkvik, T. Nilsson, A. Girdiuk, D. Thaller. First results of project on six-hourly EOP piecewise linear offset parameterization, *IVS 2022 General Meeting Proceedings*, edited by Kyla L. Armstrong, Dirk Behrend, and Karen D. Baver, NASA/CP-20220018789, 217-222, 2023.
 15. Z. Altamimi, P. Rebischung, L. Métivier, X. Collilieux. ITRF2014: A new release of the International Terrestrial Reference Frame modeling nonlinear station motions. *Journal of Geophysical Research: Solid Earth*, 121(8):6109–6131, doi:10.1002/2016JB013098, 2016.
 16. P. Charlot, C. S. Jacobs, D. Gordon, S. Lambert, A. de Witt, J. Böhm, A. L. Fey, R. Heinkelmann, E. Skurikhina, O. Titov, E. F. Arias, S. Bolotin, G. Bourda, C. Ma, Z. Malkin, A. Nothnagel, D. Mayer, D. S. MacMillan, T. Nilsson, R. Gaume. The third realization of the International Celestial Reference Frame by very long baseline interferometry. *A&A*, 644:A159, doi:10.1051/0004-6361/202038368, 2020.
 17. C. Bizouard, S. Lambert, C. Gattano, O. Becker, J.-Y. Richard. The IERS EOP 14C04 solution for Earth orientation parameters consistent with ITRF 2014. *Journal of Geodesy*, 93(5):621-633, doi:10.1007/s00190-018-1186-3, 2019.
 18. G. Petit, B. Luzum. IERS Conventions 2010. *IERS Technical Note No. 36*, Frankfurt am Main: Verlag des Bundesamts für Kartographie und Geodäsie, 2010.
 19. S. D. Desai, A. E. Sibois. Evaluating predicted diurnal and semidiurnal tidal variations in polar motion with GPS-based observations, *Journal of Geophysical Research: Solid Earth*, 121(7):5237-5256, doi:10.1002/2016JB013125, 2016.
 20. T. Artz, A. Springer, A. Nothnagel. A complete VLBI delay model for deforming radio telescopes: the Effelsberg case. *Journal of Geodesy*, 88(12):1145-1161, doi:10.1007/s00190-014-0749-1, 2014.
 21. H. Krásná, L. Baldreich, J. Böhm, S. Böhm, J. Gruber, A. Hellerschmied, F. Jaron, L. Kern, D. Mayer, A. Nothnagel, O. Panzenböck, H. Wolf. VLBI Celestial and Terrestrial Reference Frames VIE2022b. <https://doi.org/10.48550/arXiv.2211.07338>, 2022.

TECHNOLOGY DEVELOPMENT CENTERS



GSFC Technology Development Center

John Gipson, Ed Himwich, Mario Bérubé

Abstract This report summarizes the activities of the GSFC Technology Development Center (TDC) and describes plans for the future. The GSFC TDC develops station software including the Field System (FS), IVS session webpage software, and scheduling software (*sked*); hardware including tools for station timing and meteorology; scheduling algorithms, and operational procedures. It provides a pool of individuals to assist with station implementation, check-out, upgrades, and training.

1 General Information

The IVS GSFC Technology Development Center (TDC) develops hardware, software, algorithms, and operational procedures. It provides manpower for station visits for training and upgrades. Other technology development areas at GSFC are covered by other IVS components such as the GSFC Analysis Center. The current staff of the GSFC TDC consists of John Gipson, Ed Himwich, and Mario Bérubé. The remainder of this report covers the status of the main areas supported by the TDC.

2 Field System

The GSFC TDC is responsible for the development, maintenance, and documentation of the Field System

(FS) software package. The FS provides equipment control at VLBI stations. It interprets the *.snp* schedule and *.prc* procedure files (both as prepared by *drudg* from the *.skd* schedule file). The FS controls the antenna, data acquisition hardware, and related ancillary equipment needed for making VLBI measurements. All major VLBI data acquisition backends are supported. The FS is customizable to allow it to control station-specific equipment. It is used at almost all of the IVS Network Stations (more than 35) and also at many stations that perform VLBI only for astronomical observations. The only major VLBI facilities not using the FS are the DSN, LBA, VLBA, and VERA.

2.1 Work This Period

The first 32/64-bit version of the FS, 10.0.0, was released during this period. This version also merged the main branches (9.13.x) and VGOS branches (9.12.x). The code was imported into *git* and is now distributed via *GitHub*. The import into *git* included all existent versions, over 130 FS9 versions, 17 FS8 versions (VENIX), and two older versions (HP-RTE/1000/A), back to version 5.5.

The first version with extensive support for DBBC3s, FS 10.1.0, was released. That work was funded by the EVN. This version also had many other improvements including streamlined *onoff* output, clean-up of *gnplt* comment handling, and changing the default *git* branch to *main*.

NVI, Inc./NASA Goddard Space Flight Center

GSFC Technology Development Center

IVS 2021+2022 Biennial Report

2.2 Plans for the Future

A new FS version, 10.2, is expected to be released in 2023. It will have many improvements including support for longer experiment names (including IVS 12-character session codes), support for FSL11, and expanded DBBC3 support (funded by the EVN). Also, the *plotlog* utility for plotting the data in the logs has been expanded and brought up to date for VGOS.

Support for R2DBEs is expected, in FS 10.3, during 2023.

The new FS Linux distribution, FSL11, was developed in collaboration with the EVN during the period of this report but was released afterwards. This distribution is based on Debian *Stretch* and is expected to have support through June 2026.

3 Automation

The GSFC TDC is responsible for maintaining the IVS session webpages, displaying the Master Schedule, and providing information about the analysis and the scheduling of IVS sessions. A fully automated system has been operational for a few years with no major problems (see the 2019+2020 Biennial Report for a detailed description of the system). Some applications were modified to accept version 2 of the master files and the new naming convention for vgosDB files.

4 Ingest

GSFC has supported the IVS Data Centers by providing the initial version of the “ingest” software used to validate files uploaded by the VLBI community. The operational version is maintained by GSFC and the IVS Data Centers.

5 VLBI Communications Center (VCC)

The current VLBI communication method was developed more than 25 years ago and relies mainly on emails, the archiving system, and the dedicated people monitoring the information relevant to them.

This is no longer a suitable communication system for operational VLBI. To improve the actual system, the GSFC group at NASA has developed a VLBI Communications Center (VCC) and tools for near real-time, machine-to-machine, two-way communication between IVS components. The VCC is a web service supported by a database and a message broker using formatted information designed for access by computers. The database keeps up-to-date data on schedules, catalogs, and all relevant information on various IVS components (e.g., station availability, latest SEFDs). The message broker is used to inform any IVS components that some data/information at the VCC are relevant for them. The VCC knows who acknowledges the message and who uploaded the schedule, allowing full traceability of data/information exchanges.

The VCC concept was presented at the IVS 2022 General Meeting, and a detailed description is available at https://ivscc.gsfc.nasa.gov/publications/gm2022/25_berube_etal.pdf.

The central VCC server has been set up on an NVI computer and is accessible by ssh tunnelling. A VCC-client python package has been developed to facilitate access to the VCC server by any IVS component. Specific applications have been developed for the Coordinating Center, Operation Centers, Analysis Centers, Correlators, and Network Stations. A dashboard is also available for visualizing the status of any VLBI session. The VCC-client package includes a configurable client that monitors the user “inbox” for new messages in near-real time. There is a special application for Network Stations that downloads new schedules and uploads logs, SEFDs, and any other relevant information to the VCC server. A specific interface was developed to notify any affected IVS component about antenna down time.

Because each IVS component has limited roles, the VCC server is able to validate data based on the incoming information and the sender identity. For example, only the Coordinating Center can modify the Master Schedule. Schedule files can only be uploaded by the designated Operation Center. To ensure that these criteria are enforced, each user needs a special key to access the VCC. The keys are provided by the VCC manager (contact Mario Bérubé at mario.berube@nviinc.com for details). Many members of the same organization

can have their own key so that everybody can receive the same messages.

The VCC-client package requires Python 3.8 or higher. It has been tested on FS 11 for Network Stations and could be installed on FS 10 by upgrading the Python package. For other components, the package was tested on Ubuntu, MacOS, and Windows.

We plan to test the VCC client at some stations and provide a demonstration at TOW 2023.

6 *sked* and *drudg*

The GSFC TDC is responsible for the development, maintenance, and documentation of *sked* and *drudg*. These two programs are very closely related, and they operate as a pair for the preparation of the detailed observing schedule for a VLBI session and its proper execution in the field. In the normal data flow for a geodetic schedule that is written with *sked*, *sked* is run first at an Operation Center to generate the *.skd* file that contains the full network observing schedule. Then each station uses the *.skd* file as input to *drudg* to make the FS schedule and procedures for that station. Catalogs are used to define the equipment, stations, sources, and observing modes that are selected when writing a schedule with *sked*.

Changes to *sked* and *drudg* are driven by changes to equipment and by feedback from the users. The following sub-section summarizes some of the important changes to these programs during the report period. This summary includes only the most important bugs that were found and fixed over this period. A more complete summary of the changes can be found in the `changelog.txt` files associated with *sked* and *drudg*.

6.1 *drudg* Changes

Here is a summary of some important changes made in *drudg* during this period.

- The major change to *drudg* was adding support for DBBC3.
- Obsolete code dealing with tape recorders was removed on an ad hoc basis—that is, no systematic

attempt was made to remove it, but when it was encountered in the normal course of business it was removed. Examples of this include getting rid of references to tape passes, tape length, tape speed, S2 recorders, and so on.

- *Drudg* was made compatible for both *gfortran* and *fortran77*.
- In support of the new IVS session naming convention, *drudg* now supports 16-character session codes.

6.2 *sked* Changes

Here is a summary of some important changes to *sked*.

- *sked* was modified to reduce output written to the screen. This has the side effect that the program runs more smoothly.
- To avoid damaging the electronics, the antenna must travel around, not through, the radar mask. This is built into the FS, but *sked* did not know about this. Because of this, in many observations not enough time was allocated for GGAO to slew to the source. We wrote a custom slewing algorithm for GGAO based on what the FS actually does. This eliminated late-on-source error messages in the FS.
- The slew speed for the twin telescopes at Onsala depends not only on the location but on the direction in which the antennas are moving. As an antenna approaches a limit, it slows down. We wrote a custom algorithm to model this behavior correctly.

6.3 *sked* Catalogs

The GSFC TDC is responsible for maintaining the *sked* catalogs which are used in scheduling VLBI sessions. These catalogs include information about sources, antennas, equipment at stations, and observing modes. These catalogs are used by both *sked* and *VieSched++*.

A major change during this period was to make the catalogs available via *Github*. Any time a change is made, it is first tested locally at GSFC, and then the change is pushed to *Github*.

- `flux.cat` (which has simple models of source fluxes) was updated on a monthly basis. Timely updates are crucial because the source fluxes change with time.
- `equip.cat` (which contains information about the equipment at a station) was updated when the equipment changed. This catalog also contains information about station SEFDs, so it was updated whenever a station ran warm and updated again when it ran cold.
- Other catalogs (e.g., `lo.cat`, `modes.cat`, `rx.cat`, `rec.cat`) were updated as necessary. This might happen if equipment at a station was changed or a mode was not defined for a station.

IAA Technology Development Center Report for 2021–2022

Dmitry Marshalov, Evgeny Khvostov, Maxim Zotov, Dmitrii Ivanov, Vladimir Bykov, Victor Stempkovskiy, Alexander Shishikin, Vitaliy Chernov, Sergey Grenkov, Anton Berdnikov, Leonid Fedotov, Alexey Melnikov, Ilya Pozdnyakov, Ismail Rahimov, Igor Shakhnabiev, Alexey Lavrov, Yury Vekshin

Abstract The main activities of the IAA Center for Technological Development in 2021–2022 were focused on the work with a mobile VLBI station prototype and modernization of the Multifunctional Digital Backend system for upgrading the 32-m radio telescope equipment. This report provides a brief overview of these activities.

antenna system, it was possible to partially eliminate these shortcomings. The antenna position sensors were replaced, which ensured rotation in absolute coordinates in azimuth and elevation with a resolution of $20''$. The problem of low speed and limited angle of motion is solved by a modified procedure for planning VLBI observations.

1 The Prototype of a Mobile VLBI Station

One of the most effective ways of expanding the “Quasar” VLBI network is to create a mobile VLBI station. Mobile stations provide direct measurements of coordinates and time at any location with an accuracy of about 1 cm in coordinates and 0.1 ns in time per day [1]. In 2017, the concept of a mobile VLBI station with a radio telescope with a 1–5 m main reflector diameter was proposed. In 2021, the prototype of a mobile VLBI radio telescope compatible with the “Quasar” VLBI Network was developed.

The decommissioned ground based satellite station (GBSS) TESLA S11 DD 424 served as the antenna system (Figure 1). GBSS is equipped with a double-reflector antenna system with a 4.3-m primary reflector diameter. The surface quality of the reflector system satisfies the frequency range of 8.0–12.0 GHz (X-band). Significant limitations for GBSS use are low speed ($2^\circ/\text{min}$), limited pointing accuracy, and azimuth limits ($\pm 40^\circ$). As a result of the refinement of this



Fig. 1 The TESLA S11 DD 424 ground-based satellite communication station.

For slewing and tracking, a modified software part of the RT-32 monitoring and control workstation was used. The control computer software calculates the trajectory of the source and provides control of the electric drive and execution of the slew algorithm. The tracking algorithm was improved to achieve the best accuracy [2].

Institute of Applied Astronomy (IAA RAS)

IAA Technology Development Center

IVS 2021+2022 Biennial Report

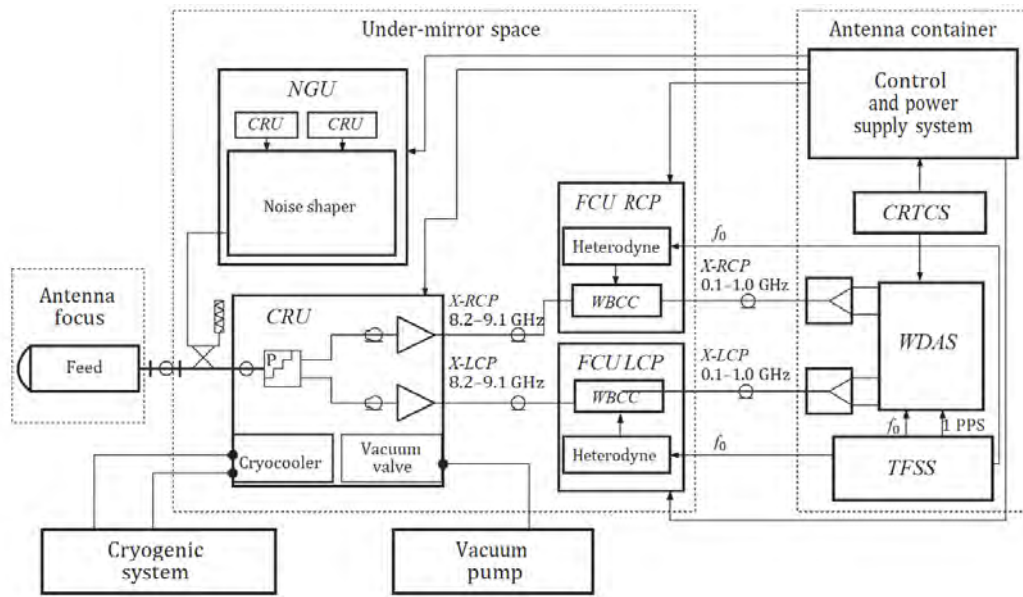

Fig. 2 The structure of the of the mobile VLBI station prototype: Cryogenic Receiver Unit (CRU), Noise Generator Unit (NGU), Frequency Converter Unit (FCU), Wideband Data-Acquisition System (WDAS), and Time-and-Frequency Synchronization System (TFSS).

For the radio telescope, a receiving system was developed for the frequency range of 8.2–9.1 GHz, which simultaneously receives signals of right and left circular polarization. An X-band feed was developed using a conical scalar horn whose phase center coincides with the secondary focus of the antenna system.

To reduce the receiver temperature, two cooled low-noise amplifiers based on HEMTs, together with a polarization separator, are installed in the cryochamber. The amplifier has a built-in directional coupler with a 20-dB attenuation. Such a coupler is used for the injection of both the amplitude and phase calibration signals. The cryogenic system with a closed cooling cycle on the basis of a two-stage cryocooler (15/77 K) and an air-cooled compressor is used to cool the polarization separator and low-noise amplifiers to temperatures of about 15 K. The functional diagram of the developed receiver system [3] is shown in Figure 2.

The modules of CRU, NGU, and FCUs are located in the backside antenna space.

The radio frequency (RF) signal (8.2–9.1 GHz) is converted to an intermediate frequency (IF) range of 100–1,000 MHz. The signals from the outputs of the corresponding FCUs are transmitted over RF cables to the power dividers and the corresponding inputs of the wideband data-acquisition system (WDAS). The

control and power-supply system, the WDAS, and several time-and-frequency synchronization system (TFSS) units are located in the antenna container near the radio telescope.

The noise temperature of the receiving system was determined by the Y-factor method using a special low-temperature noise generator. The receiving system noise temperature without feed and waveguide is 25 K, and with a waveguide it is 36 K. The estimated system noise temperature is 59 K. More information on measurements can be found in [4].

The system equivalent flux density (SEFD) parameter was measured to determine the radio telescope aperture efficiency. The measurements were carried out using the Cygnus A cosmic radio source. The SEFD and the aperture efficiency were measured as 17 kJy and 0.7, respectively.

To determine the position of the mobile station prototype, observations were carried out with the “Quasar” VLBI network. Mobile station prototype coordinates were estimated from two sessions independently and from the joint processing of the two sessions. The coordinates obtained with geodetic measurements and those refined as a result of joint equalization by VLBI sessions with the formal errors of X, Y, Z (cm): 8, 3, and 6, respectively. Taking into account the limitations

associated with the design of the mobile station prototype and the relatively short observation sessions, we can consider the obtained positions accuracy to be acceptable. In the case of a daily session, by increasing the number of observations, it is possible to achieve 1 cm accuracy.

2 Multifunctional Digital Backend

In 2020, the IAA RAS developed the Multifunctional Digital Backend (MDBE) system that performs digital signal processing in the intermediate frequency range (up to 2 GHz) in a digital form [6]. The MDBE is built on a modular principle, has ample opportunities for re-configuring operating modes due to the programmable logic integrated circuits (FPGA) used in its composition, and the design of the system ensures its placement on the focal cabin of the antenna. Since the end of 2020, the MDBE prototype has been routinely operated on the 13-meter radio telescope of the Svetloe observatory of the “Quasar” VLBI network.

The MDBE prototype was upgraded in 2021–2022 to use the MDBE on the RT-32 radio telescopes. It was supplemented with modules of intermediate frequency distributors and a set of software tools that implement support for VLBI modes of operation with narrow frequency bands, broadband radiometric recording of signals, and spectral selective radiometer modes.

Work was carried out to interface the MDBE with the data recording and transmission system (DTRS) [7] and the radio telescope time-frequency synchronization system. A set of MDBE control programs for the central control computer of the radio telescope was created, which provides tuning and diagnostics of the system operation during VLBI and radiometric observations. After a series of experiments, the MDBE was installed on the RT-32 radio telescope and used for regular VLBI observations at Svetloe observatory.

For RT-32 radio telescopes, four digital processing modules (DSP) are enough to capture and process IF signals coming from the radio astronomy receiving system in the frequency range of 100–1,000 MHz. To provide selection of IF signals from ten receivers in five frequency bands (L, S, C, X, and K) in two polarizations, two cassettes of IF signal distributors are used in the upgraded MDBE.

The MDBE is based on a 19-inch Europac PRO 3U chassis (Figure 3) designed for rugged environments. The chassis contains four DSP modules (positions 1, 2, 7, and 8 in Figure 3), a module of synchronization and control, and two IF distributor cassettes (positions 3–6 and 9–12).



Fig. 3 The MDBE prototype for the RT-32 radio telescope.

The functions performed by the MDBE are determined by the embedded software (ES) loaded in the form of firmware into the FPGA. The upgraded MDBE prototype implements the following firmware configurations:

- VLBI mode with broadband channels (512 or 1,024 MHz);
- VLBI mode with narrowband channels (up to 16 channels of 0.5, 2, 4, 8, 16, or 32 MHz bandwidth);
- Spectral-selective radiometer mode.

Table 1 The main results of the MDBE installation on the RT-32 radio telescope.

Parameter	R1002M+Mark5B+	MDBE+DTRS
Frequency range	0.1–1 GHz	0.1–1 GHz
Number of wide- / narrowband channels	– / 16	4 / 4*16
Channel bandwidth	0.5; 2; 4; 8; 16; 32 MHz	0.5; 2; 4; 8; 16; 32; 512; 1024 MHz
Data rate	2 Gbps	16 Gbps
Output format	Mark5B	VDIF, 10GE
Continuous amplitude calibration	No	Yes
Upgradable, including remote	No	Yes
Operating modes	Only VLBI	VLBI; Radiometer; Spectral-selective
Placement in the signal path of the radio telescope	Control room, the presence of AZ and EL loops	Focal cabin, connection to receiver outputs

The radiometric registration of signals in the MDBE is implemented in all modes listed above. A separate power measurement is carried out on two half-cycles of modulation, both in the entire input frequency band (at analog to digital converter input), and for the given bands of narrowband or wideband channels.

To fully support the modes and functions on the radio telescopes of the “Quasar” VLBI network, the software for controlling the MDBE was integrated into the software structure of the central control computer of the radio telescope, which is a standard for international VLBI networks.

As a result of the installation of the upgraded MDBE, an improvement in the technical and operational parameters of the data acquisition equipment of the radio telescope is noticeable (see Table 1). An equipment upgrade for the remaining “Quasar” observatories is scheduled for 2023–2024.

References

1. Ichikawa R., Ishii A., Takiguchi H., Takefuji K., Ujihara H., Koyama Y., Kondo T., Kurihara S., Miura Y., Kawabata R., Kokado K., Machida M., Takashima K., Fujisaku J., Tanimoto D., and Nozawa K., *J. Natl. Inst. Inf. Commun. Technol.*, 2010, vol. 57, nos. 3/4, p. 241.
2. Stempkovskii, V. G., Antenna’s system mathematic model, *IAA RAS Trans.*, 24, pp. 87–91, 2012.
3. Zotov M. B., Ivanov D. V., Pozdnyakov I. A., Khvostov E. Yu., and Chernov V. K., Two-channel X-band receiving system for 4m dish radio telescope prototipe, *IAA RAS Trans.*, 48, pp. 50–55, 2019.
4. Zotov M. B., Ivanov D. V., Bikov V. Yu., Grenkov S. A., Pozdnyakov I. A., Rahimov I. A., Stempkovsky V. G., Tsaruk A. A., Chernov V. K., Shakhnabiev I. V., and Shishikin A. M., The Results of the Development of the Mobile VLBI Station Prototype, *Instrum. Exp. Tech.*, Vol. 63, No. 6, pp. 91–96., 2020.
5. Nosov E., Khvostov E., Vytnov A., IAA Technology Development Center Report for 2017–2018, *International VLBI Service for Geodesy and Astrometry 2017+2018 Biennial Report*. Edited by K.L. Armstrong, K.D. Baver, and D. Behrend NASA/TP-2020-219041, pp. 271–274.
6. Nosov E., Marshalov D., Fedotov L., Sheynman Y., Multifunctional Digital Backend for Quasar VLBI network. *Journal of Instrumentation*, V.16, doi:10.1088/1748-0221/16/05/p05003, P05003, 2021.
7. Bezrukov I. A., Salnikov A. I., Yakovlev V. A., Vylegzhanin A. V., A Data Buffering and Transmission System: A Study of the Performance of a Disk Subsystem. *Instrum. Exp. Tech.*, 61, doi:10.1134/S0020441218040164, pp. 467–472, 2018.

Onsala Space Observatory – IVS Technology Development Center Activities during 2021–2022

Rüdiger Haas, Eskil Varenius, Gunnar Elgered

Abstract We give a brief overview on the technical development related to geodetic VLBI done during 2021 and 2022 at the Onsala Space Observatory.

1 General Information

The technical development work for geodetic VLBI at the Onsala Space Observatory (OSO) was dedicated to the Onsala twin telescopes (OTT) and the Onsala 20-m telescope (On), see Figure 1. The main activities are summarized as follows and discussed in detail in the subsequent sections:

- Focal adjustment of the OTT
- Flux density monitoring of quasars with the OTT
- Testing new e-transfer software
- Testing 32 and 64 Gbps recording with the OTT
- Fringes up to 15 GHz with the OTT
- An assessment of using future VGOS receivers for radiometric corrections of the signal delay due to atmospheric water vapor.

2 Focal Adjustment of the OTT

As already reported in [1], an adjustment of the receiver position in the eastern OTT (Oe) was done using a motorized focal-finder developed in-house. This

Chalmers University of Technology, Department of Space, Earth and Environment, Onsala Space Observatory

OSO Technology Development Center

IVS 2021+2022 Biennial Report



Fig. 1 The three telescopes at Onsala used for IVS observations: Ow (left), Oe (middle), On (right).

work was started in 2020 and an optimized position for the receiver was determined for Oe. The focal-finder equipment had to be left on Oe during the Covid-19 pandemic and could only be taken down in March 2022, leaving the Oe receiver at the +20 mm position. Unfortunately, there is a suspicion that the focal-finder itself was not as stable as expected and introduced small elevation-dependent tilt movements of the receiver during observations, which were detected during the analysis of the ONTIE sessions [2]. It was thus decided to remove the focal-finder in March 2022 from Oe and to not use it for a similar work on the western OTT (Ow). For Ow the optimization work was done instead using fixed distance pieces, so-called shims. On July 11, 2022, the preliminary best receiver position was determined to be +15 mm and has been used since then in all VGOS observations.

3 Flux Density Monitoring of Quasars with the OTT

During 2021 and 2022 we used the OTT to observe a small sample of quasars to verify the system temperature measurement systems now installed on the telescope control systems. We found that the electronics and calibration tables used to monitor system temperatures for the Onsala twin telescopes are working as expected within the nominal 10% uncertainty. With minor improvements to the model of antenna gain vs. elevation, and corrections for backend systematics, flux densities of ~ 500 mJy-sources could in the future be monitored to within a few percent in the 3–15-GHz band. Example light curves are shown in Figure 2. For more details on this flux monitoring project, we refer to [3]. Once the full international VGOS network is capable of routinely monitoring system temperatures during observations, the astronomical community may get regular broadband flux density monitoring (and full-polarization mapping) of hundreds of sources “for free” during geodetic VLBI observations.

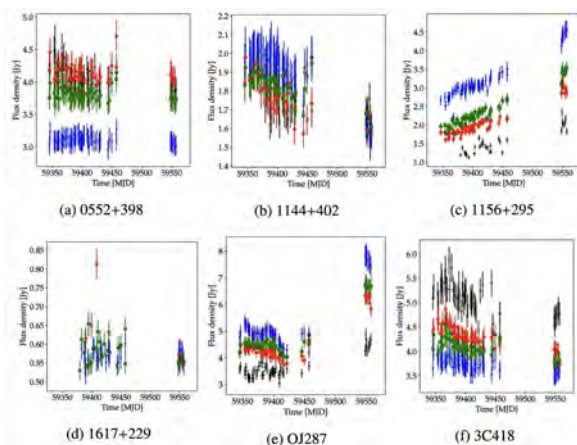

Fig. 2 Multi-frequency light curves of six sources observed in the FM-sessions [3]. Flux densities in the four VGOS bands 1, 2, 3, and 4 are shown with black crosses, red circles, green squares, and blue dots respectively. Note that the vertical scale is different for the different sources.

4 Testing New e-Transfer Software

Geodetic VLBI observations produce voltage data which need to be copied from the stations to the correlator before the correlation and subsequent geodetic analysis can take place. Especially with the new VGOS observations, the data volumes can be significant—typically ~ 24 TB for a 24-hour session with the current bandwidth and scan times. While some other stations send data as physical shipment of hard drives, Onsala transfers all data electronically via the Internet, also called *e-shipping*. Special e-shipping software has been developed for this purpose, within the astronomy and geodesy VLBI communities, with the two major packages in use today being *tsunamid/tsunami* (server/client) and *jive5ab/m5copy* (server/client). While these work, they have limitations and issues which are increasingly severe when dealing with the large data sets from VGOS antennas. In particular, because transfers may take several days and nights, it is desired to minimize user input and supervision and to simplify fast recovery in case transfers are aborted before completion.

A new software, simply called “*etransfer*”, was developed by M. Verkouter at JIVE. This consists of a server/client pair called *etd/etc*, and it has a number of improvements compared to existing software packages. In particular, the overhead time used to establish the connection for sending many files (important for Onsala VGOS data which are recorded in eight parallel files per scan) is minimal (the *jive5ab/m5copy* overhead here is significant), and there is a fast and reliable option to *resume* broken transfers (not available in *tsunami*). The only current drawback with *etc/etd* is that it cannot read directly from VBS file systems, and hence data have to first be mounted using the tool *vbs_fs*, but direct VBS reading may come in the future.

An example of *m5copy* transfer of 6-TB EU-VGOS data from Onsala to VIEN correlator can be seen in Figure 3. With *m5copy*, the large files are transferred with the maximum available bandwidth of 1.3 Gbps, while the smaller files suffer significant overhead and the effective transfer rate is only 657 Mbps. The resulting average speed is only 762 Mbps. With *etd/etc*, the maximum 1.3 Gbps is achieved for all files.

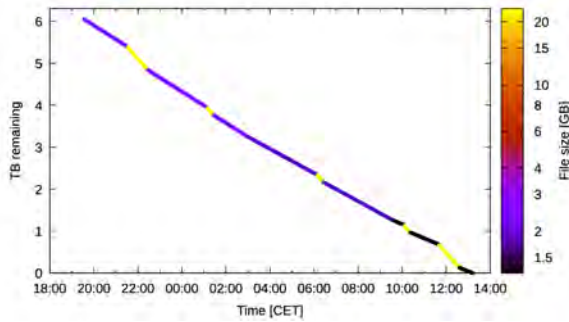

Fig. 3 Example of m5copy transfer of 6 TB EU-VGOS data from Onsala to VIEN correlator. (Image credit: F. Jaron at VIEN correlator.)

5 Testing 32- and 64-Gbps Recording with the OTT

Current VGOS observations with OTT use 8 Gbps bandwidth (some S/X still use 128 Mbps). More bandwidth means better signal-to-noise ratios for geodetic delay measurements (for the same observing time), and possibly shorter scan times (for the same scan SNR), i.e., more possible scans, which lead to better measurements of the geodetic parameters for, e.g., Earth orientation.

While the current 8-Gbps limit is in place for practical reasons (data transfer times to correlators, correlation time, etc.) the OTT hardware in principle supports higher data rates. We carried out test observations with a 32-Gbps data rate to test and verify the OTT hardware capabilities. We found that while our recording machines (flexbuffs) can handle up to 50 Gbps for longer periods of time, the network topology was limited to 32 Gbps. Changing the network, we managed to record 64 Gbps for 60 seconds using RAM buffers, but sustained recording for longer periods needs changes in our flexbuff setup.

Also, the current backend firmware (DBBC3 firmware version 124) only supports 8 Gbps, so for this test we used a preliminary version 125 which supports higher bit rates. With this, we successfully recorded data at 32 Gbps. We correlated these data and found fringes, proving that the full chain works. But we found that the v125 firmware was not fully stable. We now await the next v126 firmware which should enable more flexible DBBC3 configurations with higher bit rates in a stable way.

6 Fringes up to 15 GHz with the OTT

Going to higher (than normal VGOS, i.e., > 11 GHz) frequencies is desirable because it will improve geodetic delay measurements (larger bandwidth equals better constraints), open frequency bands with less RFI, and allow for different sources and/or source positions (e.g., core-shift effects) to be studied in more detail. While the OTT are in principle ready to receive frequencies up to 15 GHz, the cable patching of the signals coming from the telescope to the backend limits the upper frequency to 11.4 GHz.

But, by changing the cable connections we can use the 11.4–15.2-GHz band with existing hardware and investigate the sensitivity (SEFD) and search for fringes up to 15 GHz. Preliminary SEFD measurements on Cas A for the eastern OTT antenna (Oe) are shown in Figure 4. Fringes for the uppermost BBCs towards the bright source 0059+581 (a common VGOS fringe-finder source) are shown with the HOPS fourfit software in Figure 5.

We conclude that OTT can observe up to 15 GHz with existing equipment but currently needs cables to be moved from the standard VGOS setup. Preliminary SEFD measurements report 3000–4000 Jy in the 14–15-GHz band. Fringes were found in both linear polarizations on the OTT baseline towards 0059+581

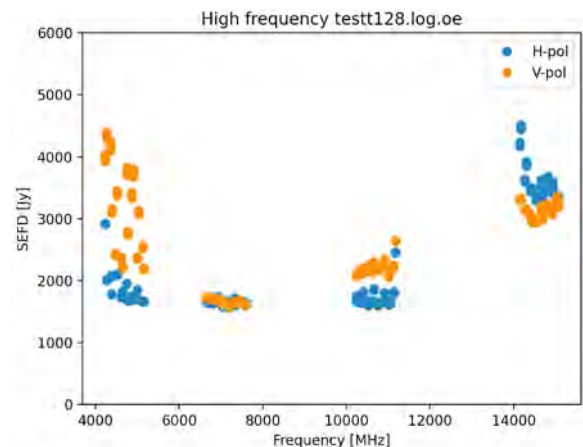

Fig. 4 Preliminary SEFD measurements up to 15 GHz using the eastern OTT antenna towards Cas A. We note that there was a minor Field System bug in ONOFF for BBCs wider than 32 MHz (these were done with 128 MHz during the 32 Gbps test), which was fixed after these figures were made. It could alter the frequencies slightly but not impact the results in a significant way.



Fig. 5 HOPS fourfit plot showing the upper eight BBCs used in the high

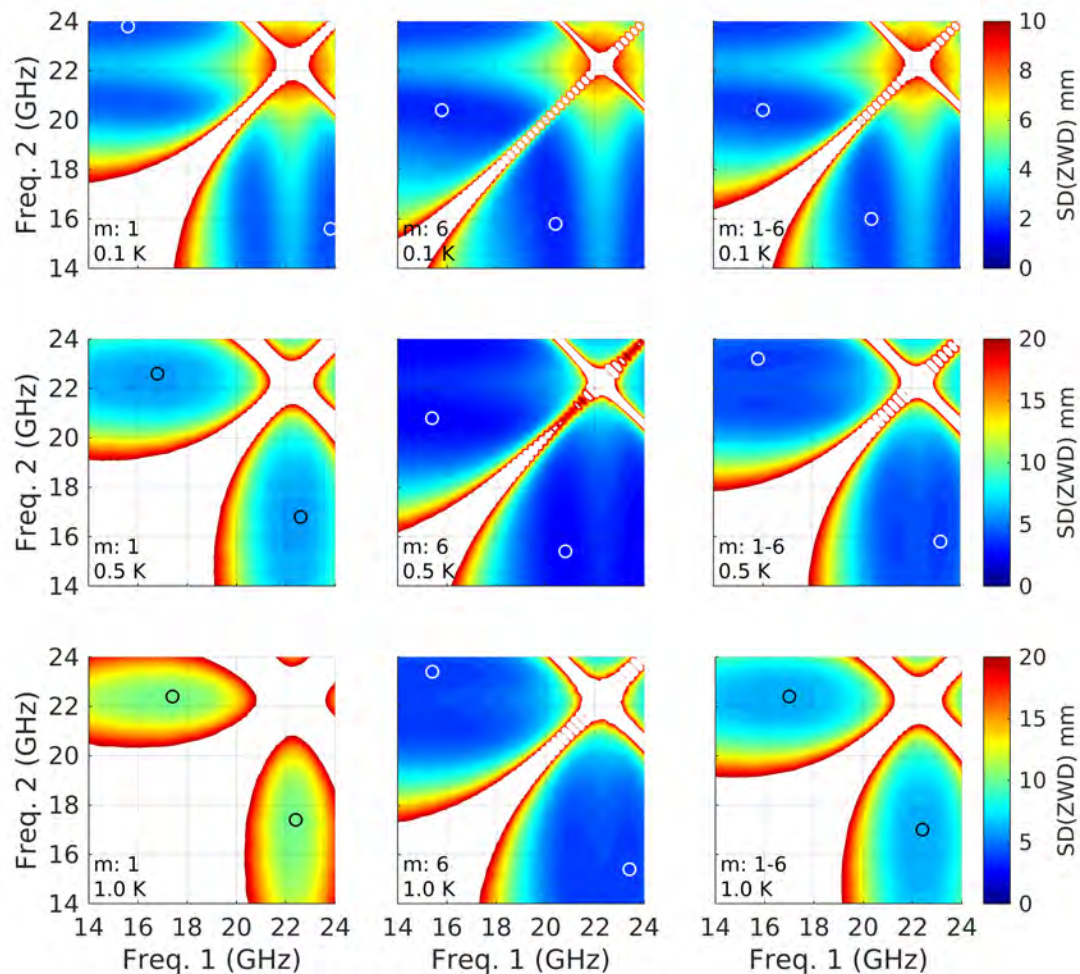

Fig. 6 Simulations of the expected ZWD rms error (standard deviation) for the two-frequency algorithm for one air mass (left column), six air masses (middle column), and one to six air masses (right column). The receiver noise is 0.1 K (top row), 0.5 K (middle row), and 1.0 K (bottom row). The white areas correspond to rms errors larger than the upper limit of the scale to the right, and the circles mark the lowest rms error obtained for the optimum frequency pair, from [6].

References

1. Haas R, Varenius E, Petterson L, Helldner L, Johansson K-Å, Kylanfall U, Dahlgren M (2021) Onsala Space Observatory – IVS Technology Development Center Activities during 2019–2020. In: *International VLBI Service for Geodesy and Astrometry 2019+2020 Biennial Report*, edited by D. Behrend, K. L. Armstrong, and K. D. Baver, NASA/TP-20210021389
2. Varenius E, Haas R, Nilsson T (2021) Short-baseline interferometry local-tie experiments at the Onsala Space Observatory. *J. Geod.*, 95:54, doi:10.1007/s00190-021-01509-5
3. Varenius E, Maio F, Le Bail K, Haas R (2022) Broad band flux-density monitoring of radio sources with the Onsala twin telescopes. *Exp Astron* 54, 137–155. doi:10.1007/s10686-022-09867-4
4. Elgered G, Davis J L, Herring T A, Shapiro I I (1991) Geodesy by radio interferometry: water vapor radiometry for estimation of the wet delay. *J Geophys Res*, 96:6541–6555. doi:10.1029/90JB00834
5. Nilsson T, Soja B, Karbon M, Heinkelmann R, Schuh H (2017) Water Vapor Radiometer Data in Very Long Baseline Interferometry Data Analysis. In: *International Symposium on Earth and Environmental Sciences for Future Generations*, IAG Symp. 147, eds. Freymueller J T, Sánchez L, doi:10.1007/1345_2017_264
6. Forkman P, Flygare J, Elgered G (2021) Water vapour radiometry in geodetic very long baseline interferometry telescopes: assessed through simulations. *J. Geod.*, 95:117, doi:10.1007/s00190-021-01571-z

IGN Yebes Observatory Technology Development Center 2021–2022 Report

J. A. López-Pérez, C. Albo-Castaño, R. Amils-Samalot, L. Barbas-Calvo, M. Bautista-Durán, F. J. Beltrán-Martínez, M. Díez-González, J. D. Gallego-Puyol, P. García-Carreño, A. García-Castellano, A. García-Marín, O. García-Pérez, G. Gómez-Molina, J. González-García, I. López-Fernández, I. Malo-Gómez, E. Martínez-Sánchez, M. Patino-Esteban, D. Regajo-Rodríguez, J. C. Rodríguez-Pérez, F. Tercero-Martínez, B. Vaquero-Jiménez, P. de Vicente, J. A. López-Fernández

Abstract The main technical developments of the Yebes Observatory (IGN, Spain) in 2021 and 2022 related to geodetic VLBI are introduced.

1 General Information

Yebes Observatory has been a Technological Development Center of the IVS since 2015. The main areas of expertise include low-noise cryogenic receivers at centimeter and millimeter wavelengths, cryogenic low-noise amplifiers, antennas and feeds, passive devices (i.e., filters, OMTs, septums, microwave hybrids, and couplers), cryogeny and vacuum, modules for receiver calibration, antenna control software, microwave holography for large reflector antennas' surface characterization, RFI detection and measurements, and topographic measurements for the local-tie.

Yebes Observatory operates two radio telescopes, 13.2 m and 40 m in diameter, respectively, that are integrated into the IVS (see Figure 1). The first one runs regular VGOS observations, and the second one has been running legacy IVS observations since 2008. The details are explained in the corresponding station report [1].

The 13.2-m radio telescope belongs to the RAEGE (Red Atlántica de Estaciones Geodinámicas y Espaciales) and is the first operative radio telescope of the four foreseen within that network (Yebes, Santa Maria, Gran Canaria, and Flores) [2]. Yebes Obser-



Fig. 1 General view of Yebes Observatory.

vatory also manages two GNSS receivers: one integrated into the International GPS Service (IGS) and a second one in the Spanish national GNSS network (Red Geodésica Nacional de Estaciones de Referencia GNSS, ERGNSS). It also runs an absolute gravimeter (FG5) and a relative superconductor gravimeter (OSG); the data collected by these gravimeters is sent to the International Geodynamics and Earth Tide Service (IGETS).

Santa Maria was the second operative RAEGE station. A detailed description can be found in [3].

Additionally, the project for the construction of an SLR station (YLARA project) started in late 2020, and it is expected to be finished by mid-2023. A detailed description of the YLARA status can be found in [4]. Yebes Observatory will become a GGOS core station once YLARA starts its operation within the International Laser Ranging Service (ILRS).

Finally, we are installing a DifX VLBI correlator for RAEGE, which could also be part of VGOS and EU-VGOS performing distributed correlation, if this idea is realized.

Yebes Observatory, IGN

IGN Yebes Observatory Technology Development Center

IVS 2021+2022 Biennial Report

These activities are performed by a staff of engineers, astronomers, and technicians, with the help of the instrumentation located in the laboratories and workshops.

In the following sections we describe the most relevant technical activities performed during 2021 and 2022.

2 VGOS Broadband Receivers

During the period to report, Yebes Observatory has upgraded the VGOS receiver for the RAEGE Yebes 13.2-m radio telescope. These upgrades are detailed in [5]. The measured average receiver noise temperature is 11.5 K in the 3–14 GHz range (see Figure 2). The upgraded receiver was installed in June 2022.

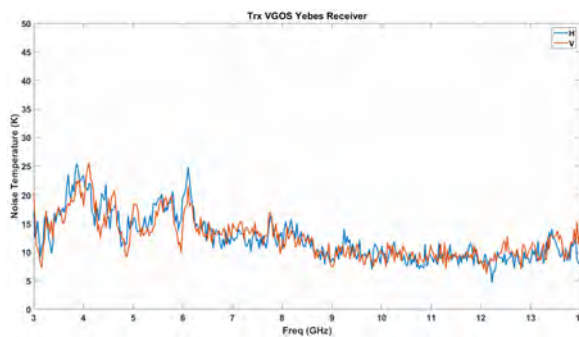

Fig. 2 RAEGE Yebes VGOS receiver noise temperature.

Additionally, Yebes Observatory also upgraded the Santa Maria VGOS receiver, previously installed in the Yebes RAEGE radio telescope until the upgrade of the Yebes VGOS receiver. The measured average receiver noise temperature is 12.5 K in the 3–14 GHz range (see Figure 3). After the upgrade in the lab, the receiver was shipped to Santa Maria in August 2022 and installed in October 2022. This receiver replaced a tri-band S/X/Ka one, mainly used for S/X legacy observations. Fringes were detected with the Santa Maria VGOS receiver on November 29 with the 12-m GGAO and 13.2-m RAEGE Yebes radio telescopes.

Concerning VGOS receiver developments for other institutions, the second VGOS receiver for the Norwegian Mapping Authority (NMA) was delivered in 2021

to Ny-Ålesund (Svalbard), and a team from Yebes assisted NMA during the installation.

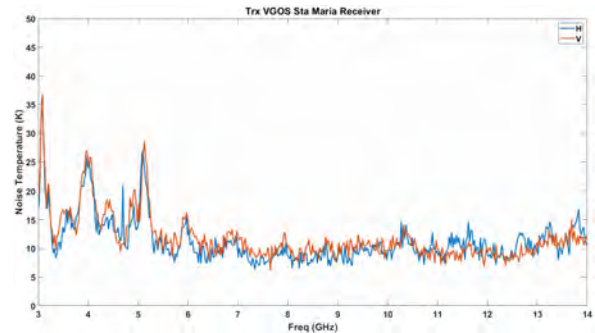

Fig. 3 RAEGE Santa Maria VGOS receiver noise temperature.

In parallel, Yebes Observatory was commissioned to build three complete new cryogenic VGOS broadband receivers, from the dewar and frontend (QRFH and LNAs) to the room temperature signal chain up to the input of the backends, including the PhaseCal and NoiseCal modules, the Cryogenics and Vacuum Control Unit, and the receiver control software.

These receivers will be delivered to the Hartebeesthoek VGOS station in South Africa, the Matera VGOS station in Italy, and the next Songkhla VGOS station in Thailand (NARIT). Only the frontend will be provided to the NARIT VGOS receiver, according to the scope of supply.

Upon the delivery of these receivers, Yebes Observatory will have built eight receivers for the VGOS community. This number will increase to ten after the completion of the RAEGE Gran Canaria and Flores stations within the next few years.

See [6] and [7] for related VGOS developments.

3 Low-noise Wideband Amplifiers

Throughout this reporting period, a significant number of 2–14 GHz cryogenic balanced amplifiers were prepared and characterized for their use in VGOS receivers. Some of them, such as the ones planned for NMA 2, are upgrades of single-ended amplifiers that require only two LNAs and four hybrid couplers, while others (Matera, HartRAO, NARIT) need four amplifiers and four hybrids each to cover both polarizations.

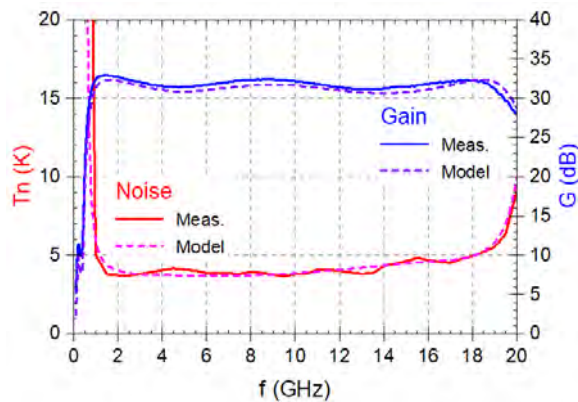

Fig. 4 Measured and modeled gain and noise temperature of the 2–18 GHz LNA at 6 K ambient temperature.

In the last five years, Yebes has been developing a new generation of state-of-the-art InP transistors with superb noise performance in collaboration with Diramics¹. The availability of these devices has motivated a redesign of the 2–14 GHz cryogenic LNA used in VGOS balanced amplifiers. This redesign encompasses two main changes: first, the adaptations in the matching networks needed to incorporate one of the new transistors into the first stage of the amplifier, and secondly, a general optimization of the design needed to exploit the advantages of a balanced configuration (the input and output return loss of the balanced LNAs are set by the excellent reflection of the hybrid couplers and are no longer a requirement of the single LNAs). Consequently, noise temperature improves significantly (around 33%), having higher gain and being a factor of two flatter, despite power dissipation being reduced by one third. The results of this enhanced amplifier version will be published soon. So far only RAEGE stations (Yebes and Santa Maria) have been equipped with balanced units of this new type. A total of eight amplifiers and hybrid couplers were manufactured to assemble four balanced amplifiers for the two polarizations of both receivers.

These optimized transistors have also facilitated another development based on the 2–14 GHz amplifier: a new LNA with an expanded ultra-wideband 2–18 GHz range and a 4 K noise temperature [8]. Figure 4 illustrates the noise and gain performance of this amplifier. To improve the input matching with the antenna, a bal-

anced architecture is recommended in direct amplification receivers. The required 3 dB 90° 2–18 GHz hybrid has not been designed yet but could be produced by scaling the existing one developed by our group for the BRAND receiver (1.5–15.5 GHz).

4 Cryogenic Directional Couplers

VLBI receivers include calibration subsystems that inject amplitude and phase calibration signals in the front-end by means of a directional coupler. It is usually placed after the feed horn to take into account the maximum number of receiver components in the calibration.

In VGOS receivers, the directional coupler is placed before the LNA at cryogenic temperature, reducing the impact on the noise temperature from its dissipative losses. There are commercial off-the-shelf devices available, but they are not specially conceived to survive thermal cycles from ambient to cryogenic temperature. Some of them were measured at Yebes, showing degradation of their cryogenic performance ([9], [10]) and a potential risk of failure due to the thermal stress on the connector contact. For these reasons, we developed a 30 dB cryogenic directional coupler specially suited for cryogenic operation, improving the performance and reliability of commercial units. It works in the 2–14 GHz frequency band, although its best performance was in the 3–14 GHz range because of the high level of RFI present in the lower part of the VGOS band.

The materials and mechanical construction were carefully selected following the stripline structure in [11]. The result is a very compact, reliable, and low thermal mass device, able to withstand extreme thermal cycling. The coupling and reflection characteristics show a very low temperature dependence. Their main characteristics are the following: coupling of 29.2 dB \pm 1 dB with a return loss better than 20 dB in the direct path ports, plus an average effective insertion loss lower than 0.1 dB and directivity higher than 16 dB [12].

Eight units were built to meet the needs of the Yebes, Santa Maria, HartRAO, and Matera VGOS receivers. One unit is shown in Figure 5.

¹ Diramics AG, Switzerland (<https://diramics.com>)



Fig. 5 30 dB cryogenic directional coupler.

5 NoiseCal and PhaseCal Developments

All Yebes-developed VGOS receivers are equipped with a broadband noise source that can be turned ON or OFF or to an 80 Hz rate under remote control. This feature is useful for amplitude calibration. The excess noise (Tcal) generated by the noise source is injected in front of the LNAs and is carefully measured in the laboratory and reported.

Concerning the PhaseCal Antenna Unit, the envelope of the pulse train was equalized to have a flatter spectrum with the help of a COTS unit. Details are given in [5].

With regard to the Cable Delay Measurement System (CDMS), a new version was developed, and the results were published in [13].

To measure the accuracy of the system, a Narda manual phase shifter was used. It allows the manual insertion of known phase offsets in the 5 MHz signal path, from 0° to 180° at 1 GHz, which corresponds to offsets from 0° to 0.9° at 5 MHz (0.9° at 5 MHz equals 500 ps). Therefore, it is possible to introduce very precise and known delays into the system to verify that they are detected and measured correctly.

Figure 6 shows the measured delay for 10 ps steps (two-way). It can be seen that these changes are easily detected. However, it must be taken into account that the changes are made manually, using the shifter's wheel, and the wheel settings can be affected by a little slack or play.

The noise of the system provides a value of the measurement error introduced by the system itself. This error is the ultimate accuracy that the system can reach in the absence of the effects on the cable to be measured. It was measured inside the Yebes gravimeter room, where the temperature has a gradient of \pm

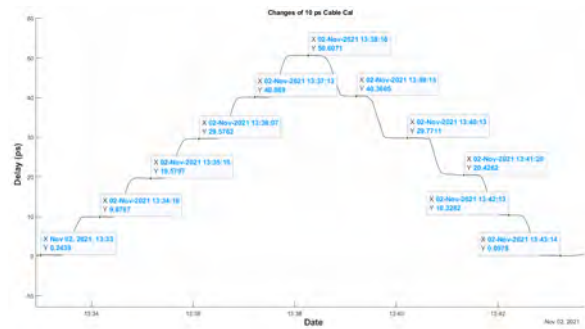

Fig. 6 CDMS response to 10 ps delay steps.

1° only, with a 1 m cable for the connections between units.

The RMS noise computed in one hour is below 0.1 ps. It is shown in Figure 7.

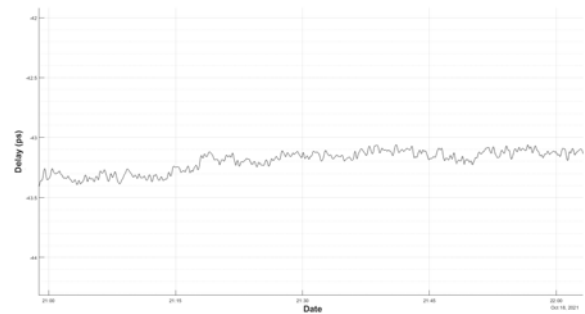

Fig. 7 CDMS noise during one hour.

6 RFI Measurements

During the period of 2021–2022, several works related to RFI were carried out in Yebes Observatory. These encompass hardware development for RFI systems, RFI monitoring system campaigns, and software development related to RFI.

Concerning the hardware, some additional modules of filtering and amplification were developed at Yebes Observatory to improve the sensitivity of the RFI system in order to evaluate some specific RFI signals (i.e., Starlink and the second harmonic from IMT800).

In relation to RFI monitoring campaigns / measurements, we tried to detect RFI from Starlink satellites by

using the RFI permanent system (RAFITA), installed at the rooftop of the labs building and with the VGOS radio telescope. Both measurements showed some Starlink channels over Yebes Observatory. The difficulty is to prove if these signals come through the main beam or side-lobes. The goal of the measurements is to obtain the flux at the input of both antennas. Calibrated measurements were obtained with RAFITA only.

Additionally, RFI measurements were performed at 3 GHz from pulsed RFI signals that were received during the pointing scans in VGOS A-band with the RAEGE radio telescope.

Monitoring campaigns with RAFITA covered the VGOS frequency range, across the whole sky over five hours. The data is stored and later post-processed to create 3D maps with the total RFI power at specific frequency ranges (see Figure 8).

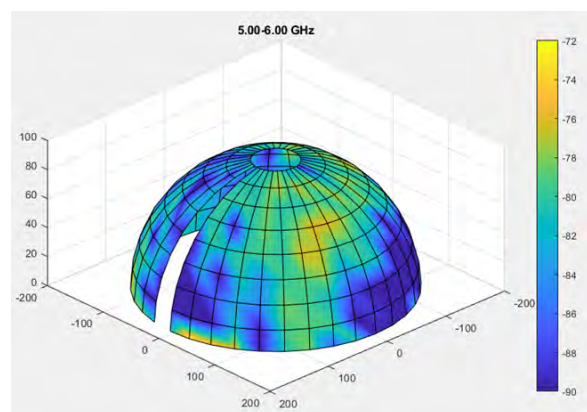

Fig. 8 3D map of RFI power in the range 5–6 GHz.

Finally, regarding RFI software development related to the monitoring campaigns with RAFITA, some software in MATLAB was developed to calibrate the data and to integrate the RFI power and plot the RFI-3D maps.

7 VLBI Correlator

Yebes Observatory is installing a DIFX VLBI correlator for RAEGE, which could also be part of VGOS and EU-VGOS performing distributed correlation (see [1] for further details).

For the past two years, a small prototype of correlator with 28 computing cores was used to get training with the processing pipeline. As a result of this stage, it could be used to confirm the first interferometric fringes between the new Ny-Ålesund VGOS antenna and RAEGYEB, as well as the baseline RAEGSMAR and RAEGYEB. Currently, it is on duty to correlate the VGOS Intensive sessions run by GGAO, RAEGYEB, and RAEGSMAR.

In 2023, a significant upgrade of the hardware is expected to allow the processing of VGOS-type experiments with more baselines. The specifications for the new HPC consist of up to 128 computing cores and 1 PB of storage space.

8 New Developments

After the installation of the VGOS receiver at the RAEGE Santa Maria station, a strong radio signal was detected near 3 GHz. This signal was so strong that the receiver was saturated and intermodulated at the LNA stage. Therefore, observations were not possible. As a quick temporal solution, it was decided to install COTS high-pass filters (4–16 GHz) at the input of the LNAs at the cost of losing the VGOS A-band. Detailed information on the performance of these commercial filters is available in [14]. This is a temporary solution while a high-temperature superconducting notch filter is developed. Its design started in November 2022, and it will be ready for installation by June 2023 if the characterization in the lab is successful. This filter will allow observing in the VGOS A-band.

Additionally, HTS filters were designed to notch the SLR radar signals around 9.4 GHz in the Matera and HartRAO VGOS receivers. Similarly, these filters will be assembled in 2023 prior to their characterization in the laboratory.

Acknowledgments

Special thanks are given to all Yebes and Santa Maria staff for their valuable contributions to the technological developments and radio telescopes' operations.

References

1. J. González et al.: “Yebes Observatory Report”. In IVS 2021+2022 Biennial Report, this volume, edited by K. A. Armstrong, D. Behrend, and K. D. Baver. 2023.
2. José A. López-Pérez, João S. Ferreira, Javier González-García, Carlos Albo-Castaño, Abel García-Castellano, P. de Vicente-Abad, José A. López-Fernández, Francisco W. Macedo, Luís R. Santos, Sara Pavão: “The current status of RAEGE”. 25th EVGA meeting. March 15-18, 2021.
3. João S. Ferreira, Abel García-Castellano, José A. López-Pérez, Mariana Moreira, Diogo Avelar, Valente Cuambe, Francisco Wallenstein, Javier González-García, Carlos Albo-Castaño: “RAEGE Santa Maria: Station Overview”. IVS 2022 General Meeting Proceedings, pp. 42-46, edited by Kyla L. Armstrong, Dirk Behrend, and Karen D. Baver. NASA/CP-20220018789. 2023.
4. Beatriz Vaquero, José A. López-Pérez, José C. Rodríguez, Adolfo García-Marín, Elena Martínez, Carlos Albo-Castaño, Laura Barbas, José A. López-Fernández, Pablo de Vicente: “Yebes Laser Ranging Station (YLARA), development status 2022”. 22nd ILRS workshop, Guadalajara, Spain.
5. José A. López-Pérez, F. Tercero-Martínez, J. D. Gallego-Puyol, I. López-Fernández, C. Albo-Castaño, I. Malo-Gómez, M. Díez-González, M. Patino-Esteban, P. García-Carreño, O. García-Pérez, J. González-García, G. Gómez-Molina, M. Bautista-Durán, R. Amils-Samalot, A. Rivera-Lavado: “Description of RAEGE Yebes VGOS receiver upgrades”. IVS 2022 General Meeting Proceedings, pp. 47-51, edited by Kyla L. Armstrong, Dirk Behrend, and Karen D. Baver. NASA/CP-20220018789. 2023.
6. D. Regajo, O. García-Pérez, F. Tercero: “QRFH antenna for (YQR-03-003)”. CDT Technical Report 2021-14.
7. G. Gomez-Molina, O. García-Pérez, J. M. Serna-Puente, F. Tercero: “New Designs in VGOS frontends in Yebes Observatory”. 25th EVGA meeting. March 15-18, 2021.
8. I. López-Fernández, J. D. Gallego, C. Díez, I. Malo, R. I. Amils, R. Flückiger, D. Marti: “2 – 18 GHz Ultra-wideband Cryogenic Amplifier with 4 K Noise Temperature”. Proceedings of the 32nd International Symposium on Space Terahertz Technology. 2022.
9. I. Malo, J. D. Gallego, J. González, I. López-Fernández, C. Díez, R. Amils: “New 30 dB coupler for the injection of the calibration signal to the 2 – 14 GHz wideband VGOS receiver”. CDT Technical Report 2019-16.
10. I. Malo, J. D. Gallego, I. López-Fernández, C. Díez, R. Amils: “Krytar 30 dB coupler for the injection of the calibration signal to the 2 – 14 GHz wideband VGOS receiver”. CDT Technical Report 2020-16.
11. I. Malo, J. D. Gallego, C. Díez, López-Fernández, C. Briso: “Cryogenic hybrid coupler for ultra low noise Radio Astronomy balanced amplifiers”. IEEE Transactions On Microwave Theory And Techniques, vol. 57, no. 12. December 2009.
12. I. Malo, J. D. Gallego, M. Díez, López-Fernández, R. Amils, R. García, G. Martínez: “Yebes 30 dB cryogenic directional coupler for the injection of the calibration signal to the 2 – 14 GHz wideband VGOS receiver”. CDT Technical Report 2022-15.
13. Pablo García-Carreño, Javier González-García, María Patino-Esteban, Francisco J. Beltrán-Martínez, Marta Bautista-Durán, Pablo Luis López-Espí, José A. López-Pérez: “New Cable Delay Measurement System for VGOS Stations”. Sensors 22, no. 6: 2308. <https://doi.org/10.3390/s22062308>
14. I. Malo, J. D. Gallego, I. López, M. Díez, R. Amils, A. García, R. García, G. Martínez: “Cryogenic Measurement of two LTCC Commercial Filters for Interferences Reduction in Radio Astronomy Receivers”. CDT Technical Report 2022-14.

IVS Information



IVS Terms of Reference

1 Summary

1.1 Charter

The International VLBI Service for Geodesy and Astrometry (IVS) is an international collaboration of organizations which operate or support Very Long Baseline Interferometry (VLBI) components. IVS provides a service which supports geodetic and astrometric work on reference systems, Earth science research, and operational activities. IVS is a Service of the International Association of Geodesy (IAG) and of the International Astronomical Union (IAU).

1.2 Objectives

IVS fulfills its charter through the following objectives:

1. foster and carry out VLBI programs. This is accomplished through close coordination of the participating organizations to provide high-quality VLBI data and products.
2. promote research and development activities in all aspects of the geodetic and astrometric VLBI technique.
3. advance the education and training of VLBI participants through workshops, reports, and other means.
4. support the integration of new components into IVS.
5. interact with the community of users of VLBI products. IVS represents VLBI in the Global Geodetic

IVS 2021+2022 Biennial Report

Observing System (GGOS) of the IAG and interacts closely with the International Earth Rotation and Reference Systems Service (IERS).

In support of these objectives, IVS coordinates VLBI observing programs, sets performance standards for VLBI stations, establishes conventions for VLBI data formats and data products, issues recommendations for VLBI data analysis software, sets standards for VLBI analysis documentation, and institutes appropriate VLBI product delivery methods to ensure suitable product quality and timeliness. IVS coordinates its activities with the astronomical community because of the dual use of many VLBI facilities and technologies for both astronomy and astrometry/geodesy.

1.3 Data Products

VLBI data products contribute uniquely to these important activities:

- defining and maintaining the celestial reference frame,
- monitoring universal time (UT1),
- monitoring the coordinates of the celestial pole (nutation and precession).

These results are the foundation of many scientific and practical applications requiring the use of an accurate quasi-inertial reference frame, such as high-precision positioning, navigation, and timing. In addition IVS provides a variety of VLBI products with differing applications, timeliness, detail, and temporal resolution, such as:

- all components of Earth orientation parameters,
- terrestrial reference frame,
- baseline lengths,
- tropospheric parameters.

All VLBI data and products are publicly available in appropriate formats from IVS Data Centers.

1.4 Research

The IVS data and products are used for research in many areas of geodesy, geophysics, and astronomy, such as:

- UT1 and polar motion excitation over periods of hours to decades,
- solid Earth interior research (e.g., mantle rheology, anelasticity, libration, and core modes),
- characterization of celestial reference frame sources and improvements to the frame,
- tidal variations (solid Earth, oceanic, and atmospheric),
- improvements in the terrestrial reference frame, especially in the scale,
- climate studies (e.g., sea level change, deglaciation, and water vapor),
- regional and global geodynamics,
- general relativity.

To support these activities, there are ongoing research efforts to improve and extend the VLBI technique in areas such as:

- instrumentation, data acquisition, and correlation,
- data analysis techniques,
- spacecraft tracking and navigation (Earth-orbiting and interplanetary),
- combination of VLBI data and results with other techniques.

2 Permanent Components

IVS acquires, correlates, and analyzes VLBI data to produce geodetic, astrometric, and other results that are archived and publicized. IVS accomplishes its objectives through the following permanent components:

- Network Stations,
- Operation Centers,
- Correlators,
- Analysis Centers,
- Data Centers,
- Technology Development Centers,
- Office for Outreach and Communications,
- Coordinating Center.

2.1 Network Stations

The IVS observing network consists of high performance VLBI stations.

- Stations may either be dedicated to geodesy or have multiple uses (including astronomical observations or satellite tracking applications).
- Stations comply with performance standards for data quality and operational reliability specified by the Directing Board.
- Stations provide local tie information, timing and meteorological data to the IVS Data Centers.
- VLBI data acquisition sessions are conducted by groups of Network Stations that may be distributed either globally or over a geographical region.

2.2 Operation Centers

The IVS Operation Centers coordinate the routine operations of specific networks. Operation Center activities include:

- planning network observing programs,
- supporting the network stations in improving their performance,
- generating the detailed observing schedules for use in data acquisition sessions by IVS Network Stations,
- posting the observing schedule to an IVS Data Center for distribution and archiving.

IVS Operation Centers follow guidelines from the Coordinating Center for timeliness and schedule file formats.

2.3 Correlators

The IVS Correlators process raw VLBI data. Their other tasks are to:

- provide timely feedback to the Network Stations about data quality,
- jointly maintain the geodetic/astrometric community's media pool and transport,
- manage electronic data transfer,
- make processed data available to the Data Centers,
- regularly compare processing techniques, models, and outputs to ensure that data from different Correlators are identical.

2.4 Analysis Centers

The IVS coordinates VLBI data analysis to provide high-quality products for its users. The analyses are performed by:

- Operational Analysis Center,
- Associate Analysis Centers,
- Special Analysis Centers for Specific Observing Sessions, and
- Combination Centers.

All Analysis Centers maintain and/or develop appropriate VLBI analysis software.

Operational Analysis Centers are committed to producing results to the specifications of the IVS Analysis Coordinator and always on schedule to meet IVS requirements. In addition, Operational Analysis Centers may produce Earth orientation parameters, station coordinates, and source positions in regular intervals.

Operational Analysis Centers place their final results in IVS Data Centers for dissemination to researchers and other users. They adhere to IVS recommendations for the creation of high-quality products and their timely archiving and distribution. Any deviations that an Operational Analysis Center makes from IVS recommendations are properly documented. Operational Analysis Centers provide timely feedback about station performance. In addition to these regular services, Operational Analysis Centers may also perform any task of an Associate Analysis Center.

Associate Analysis Centers are committed to regularly submit specialized products using complete series or subsets of VLBI observing sessions. The analysis is performed for specific purposes as recognized by the Directing Board, such as exploitation of VLBI data for new types of results, investigations of regional phenomena, reference frame maintenance, or special determinations of Earth orientation parameters. The Associate Analysis Centers place their final results in IVS Data Centers for dissemination to researchers and other users. They adhere to IVS recommendations for the creation of high-quality products and their timely archiving and distribution. Any deviations that an Associate Analysis Center makes from IVS recommendations are properly documented.

Special Analysis Centers for Specific Observing Sessions have responsibility for ongoing series-related investigations of one or more existing session types. They perform detailed and comparative analyses of each session of a series within a reasonable time after correlation. In addition, they report deficits and technical complications to the observing sites, the correlators, and to the schedulers as well as to the IVS Network and Analysis Coordinators.

Combination Centers are committed to produce combination results from the individual submissions of the Operational Analysis Centers as official IVS products. For this purpose they monitor the quality of the submissions. The official IVS products include, but are not limited to, EOP time series derived from session-based results for 24-hour network sessions and one-hour Intensive sessions. Combination Centers also contribute to the generation of the official IVS input to International Terrestrial Reference Frame (ITRF) computations. The combination work is done in a timely fashion and in close cooperation with the IVS Analysis Coordinator.

2.5 Data Centers

The IVS Data Centers are repositories for VLBI observing schedules, station log files, data and products. Data Centers may mirror other Data Centers to make the distribution and maintenance of data more efficient and reliable.

- Data Centers are the primary means of distributing VLBI products to users.

- Data Centers work closely with the Coordinating Center and with the Analysis Centers to ensure that all the information and data required by IVS components are quickly and reliably available.

Data Centers provide the following functions:

- receive and archive schedule files from Operation Centers,
- receive and archive log files and ancillary data files from the Network Stations,
- receive and archive data products from the Analysis Centers,
- provide access and public availability to IVS data products for all users.

2.6 Technology Development Centers

The IVS Technology Development Centers contribute to the development of new VLBI technology for improvement of the VLBI technique. They:

- investigate new equipment and approaches,
- develop, test, and document new hardware, firmware, and software for operations,
- assist with deployment, installation, and training for any new approved technology,
- maintain and support operational equipment.

2.7 Office for Outreach and Communications

The IVS Office for Outreach and Communications (OOC) creates and maintains an outreach program to promote knowledge of the VLBI technique and the activities of the IVS, and to foster an understanding of the importance of its products for the scientific communities and the general public. The OOC is mandated with improving collaboration with regional and global organizations and institutions, including sponsor organizations and scientific associations. The OOC works together with all components of the IVS and in particular with the IVS Coordinating Center.

2.8 Coordinating Center

The IVS Coordinating Center is responsible for coordination of both the day-to-day and the long-term activities of IVS, consistent with the directives and policies established by the Directing Board. Specifically, the Coordinating Center monitors, coordinates, and supports the activities of the Network Stations, Operation Centers, Correlators, Data Centers, Analysis Centers, and Technology Development Centers. The Coordinating Center works closely with the Technology Coordinator, the Network Coordinator, and the Analysis Coordinator to coordinate IVS activities.

The primary functions of the Coordinating Center are to:

- coordinate observing programs approved by the Directing Board,
- create and maintain the master schedule of observing sessions in coordination with IVS Network Stations and astronomical observing programs,
- foster communications among all components of the IVS,
- coordinate the best use of community resources,
- develop standard procedures for IVS components,
- organize training in VLBI techniques,
- organize workshops and meetings, including IVS technical meetings,
- produce and publish reports of activities of IVS components,
- maintain the IVS information system and archive all documents, standards, specifications, manuals, reports, and publications,
- coordinate IVS outreach and educational activities,
- provide liaison with the IAU, IAG, GGOS, IERS, and other organizations,
- provide the Secretariat of the Directing Board.

2.9 Becoming a Permanent Component

IVS will accept proposals at any time to become a permanent component. Such proposals will be reviewed for approval by the Directing Board.

3 Coordinators

Specific IVS activities regarding network data quality, products, and technology are accomplished through the functions performed by three coordinators: a Network Coordinator, an Analysis Coordinator, and a Technology Coordinator.

3.1 Network Coordinator

The IVS Network Coordinator is selected by the Directing Board from responses to an open solicitation to all IVS components. The Network Coordinator represents the IVS Network Stations on the Directing Board and works closely with the Coordinating Center. The Network Coordinator is responsible for stimulating the maintenance of a high quality level in the station operation and data delivery. The Network Coordinator performs the following functions:

- monitors adherence to standards in the network operation,
- participates in the quality control of the data acquisition performance of the network stations,
- tracks data quality and data flow problems and suggests actions to improve the level of performance,
- coordinates software development for station control and monitoring.

The Network Coordinator works closely with the geodetic and astronomical communities who are using the same network stations for observations. The Network Coordinator takes a leading role in ensuring the visibility and representation of the network stations.

3.2 Analysis Coordinator

The IVS Analysis Coordinator is selected by the Directing Board from responses to an open solicitation to the IVS Analysis Centers. The Analysis Coordinator is responsible for coordinating the analysis activities of IVS and for stimulating VLBI product development and delivery. The Analysis Coordinator performs the following functions:

- fosters comparisons of results from different VLBI analysis software packages and different analysis strategies,
- encourages documentation of analysis and combination software,
- participates in comparisons of results from different space geodetic techniques,
- monitors Analysis Centers' products for high quality results and for adherence to IVS standards and IERS Conventions,
- ensures that IVS analysis and combination products from all Analysis Centers are archived and are available to the scientific community, and
- supervises the formation of the official IVS products specified by the IVS Directing Board.

The Analysis Coordinator plays a leadership role in the development of methods for generation and distribution of VLBI products so that the products reach the users in a timely manner. The Analysis Coordinator interacts with GGOS and the IERS and promotes the use of VLBI products by the broader scientific community. The Analysis Coordinator works closely with the astronomical communities who are using some of the same analysis methods and software.

3.3 Technology Coordinator

The IVS Technology Coordinator is selected by the Directing Board from responses to an open solicitation to the IVS Technology Development Centers. The Technology Coordinator performs the following functions:

- stimulates advancement of the VLBI technique,
- maintains awareness of all current VLBI technologies and ongoing development,
- coordinates development of new technology among all IVS Technology Development Centers,
- encourages technical compatibility with the astronomical community,
- encourages and oversees development of VLBI-related technical standards,
- coordinates the distribution of and access to technical documents and standards,
- helps promulgate new technologies to the IVS community.

The Technology Coordinator works closely with the astronomical community, both to maintain techni-

cal compatibility between the geodetic and astronomical communities and to take advantage of technology development activities in the astronomical community.

4 Directing Board

4.1 Roles and Responsibilities

The Directing Board sets objectives, determines policies, adopts standards, and sets the scientific and operational goals for IVS. The Directing Board exercises general oversight of the activities of IVS including modifications to the organization that are deemed appropriate and necessary to maintain efficiency and reliability. The Directing Board may determine appropriate actions to ensure the quality of the IVS products.

The Directing Board will receive and review proposals for non-IVS research programs that request IVS resources.

4.2 Membership

The Directing Board consists of representatives of the IVS components, members at-large, appointed members, and ex officio members. The members are:

Representatives of IVS Components (see below):

- Correlators and Operation Centers representative (1)
- Analysis and Data Centers representatives (2)
- Networks representatives (2)
- Technology Development Centers representative (1)

Elected by the Directing Board upon recommendation from the Coordinating Center (see below):

- Members at large (3)

Selected by Directing Board upon review of proposals from IVS Member Organizations:

- Coordinating Center Director
- Director of Office for Outreach and Communications

- Network Coordinator
- Analysis Coordinator
- Technology Coordinator

Appointed members:

- IAU representative
- IAG representative
- IERS representative

Through a reciprocity agreement between IVS and IERS, the IVS serves as the VLBI Technique Center for IERS, and as such its designated representative(s) serve on the IERS Directing Board. In turn, the IERS Directing Board designates a representative to the IVS Directing Board. This arrangement is to assure full cooperation between the two services.

Total number: 17

The members appointed by IAU, IAG, and IERS are not subject to institutional restrictions.

The six members who are the representatives of the IVS components are elected by the IVS Associate Members. All elected members serve staggered four-year terms once renewable.

At-large members are intended to ensure representation on the Directing Board of each of the components of IVS and to balance representation from as many countries and institutions and IVS interests as possible. At-large members serve two-year terms once renewable.

A Directing Board member who departs before the end of his/her term is replaced by a person selected by the Directing Board. The new member will serve until the next official elections. The position will then be filled for a full term.

An individual can only serve two consecutive full terms on the Board in any of the representative and at-large positions. Partial terms are not counted to this limit. After serving two consecutive full terms, an individual becomes eligible again for a position on the Board following a two-year absence.

The three Coordinators are selected by the Directing Board on the basis of proposals from IVS Member Organizations. On a two-thirds vote the Directing Board may call for new proposals for any Coordinator when it determines that a new Coordinator is required. Coordinators are encouraged to give at least six months notice before resigning.

4.3 Elections

Election of Board members from the IVS components shall be conducted by a committee of three Directing Board members, the chair of which is appointed by the chair of the Directing Board. The committee solicits nominations for each representative from the relevant IVS components. For each position, the candidate who receives the largest number of votes from the Associate Members will be elected. In case of a tie the Directing Board will make the decision.

4.4 Chair

The chair is one of the Directing Board members and is elected by the Board for a term of four years with the possibility of reelection for one additional term. The chair is the official representative of IVS to external organizations.

4.5 Decisions

Most decisions by the Directing Board are made by consensus or by simple majority vote of the members present. In case of a tie, the chair decides how to proceed. If a two-thirds quorum is not present, the vote shall be held later by electronic mail. A two-thirds vote of all Board members is required to modify the Terms of Reference, to change the chair, or to replace any of the members before their normal term expires.

4.6 Meetings

The Directing Board meets at least annually, or more frequently if meetings are called by the chair or at the request of at least three Board members. The Board will conduct periodic reviews of the IVS organization and its mandate, functions, and components.

5 Definitions

5.1 Member Organizations

Organizations that support one or more IVS components are IVS Member Organizations. Individuals associated with IVS Member Organizations may become IVS Associate Members.

5.2 Affiliated Organizations

Organizations that cooperate with IVS on issues of common interest, but do not support an IVS component, are IVS Affiliated Organizations. Affiliated Organizations express an interest in establishing and maintaining a strong working association with IVS to mutual benefit. Individuals affiliated with IVS Affiliated Organizations may become IVS Corresponding Members.

5.3 Associate Members

Individuals associated with organizations that support an IVS component may become IVS Associate Members. Associate Members take part in the election of the incoming members of the Directing Board representing the IVS components.

5.4 Corresponding Members

IVS Corresponding Members are individuals who express interest in receiving IVS publications, wish to participate in workshops or scientific meetings organized by IVS, or generally are interested in IVS activities. Ex officio Corresponding Members are the following:

- IAG Secretary General
- Chair of GGOS
- President of IAG Commission 1 – Reference Frames
- President of IAG Commission 3 – Earth Rotation and Geodynamics

- President of IAU Division A – Fundamental Astronomy
- President of IAU Commission A1 – Astrometry
- President of IAU Commission A2 – Rotation of the Earth
- President of IAU Commission A3 – Fundamental Standards
- President of IAU Commission B4 – Radio Astronomy
- President of URSI Commission J – Radio Astronomy

Individuals are accepted as IVS Corresponding Members upon request to the Coordinating Center.

Last modified: 24 May 2019

Links to Additional IVS Information

This page provides links to information about the individuals and groups that support IVS. Member organizations are organizations that support one or more permanent components. Permanent components are groups that formally commit to provide support in one of six categories: coordination of network operations (Operation Centers), collection of VLBI data (Network Stations), processing of raw data (Correlators), archival and distribution of data and products (Data Centers), analysis of data and generation of products (Analysis Centers), and development of new technology (Technology Development Centers).

Associate Members are individuals that are associated with a member organization and have been granted Associate Member status. Associate Members generally support IVS by participating in the activities of one or more components.

Affiliated organizations cooperate with IVS on matters of common interest but do not support a component.

Information Category	Link
Associate Members	
(listed alphabetically by last name)	https://ivscc.gsfc.nasa.gov/about/org/members/assoc_name.pdf
(listed alphabetically by their organization's country)	https://ivscc.gsfc.nasa.gov/about/org/members/assoc_org.pdf
Permanent Components	
Network Stations	https://ivscc.gsfc.nasa.gov/about/org/components/ns-list.html
Operation Centers	https://ivscc.gsfc.nasa.gov/about/org/components/oc-list.html
Correlators	https://ivscc.gsfc.nasa.gov/about/org/components/co-list.html
Data Centers	https://ivscc.gsfc.nasa.gov/about/org/components/dc-list.html
Analysis Centers	https://ivscc.gsfc.nasa.gov/about/org/components/ac-list.html
Technology Development Centers	https://ivscc.gsfc.nasa.gov/about/org/components/td-list.html
Member Organizations	https://ivscc.gsfc.nasa.gov/about/org/members/memberorgs.html
Affiliated Organizations	https://ivscc.gsfc.nasa.gov/about/org/members/affilmemberorgs.html

