

Population Accommodation for NASA Spacesuit and Hardware

Han Kim

Garima Gupta

Karen Young

Nathaniel Newby

Leidos, Inc. / NASA Johnson Space Center

Aegis Aerospace / NASA Johnson Space Center

Leidos, Inc. / NASA Johnson Space Center

KBR Inc./NASA Johnson Space Center

March 12, 2024



This work was in part supported by NASA Extravehicular Activity and Human Surface Mobility Program (EHP) and Human Health and Performance Contract (NNJ15HK11B).

NASA Anthropometry and Biomechanics Facility (ABF)

- ABF is the primary NASA source for assessments of human-suit interaction
 - Suit fit and accommodation modeling, including suit and human 3D scans
 - Suited performance assessments using motion capture and kinematic analyses
 - Ergonomic analyses of humans working in the spacesuit

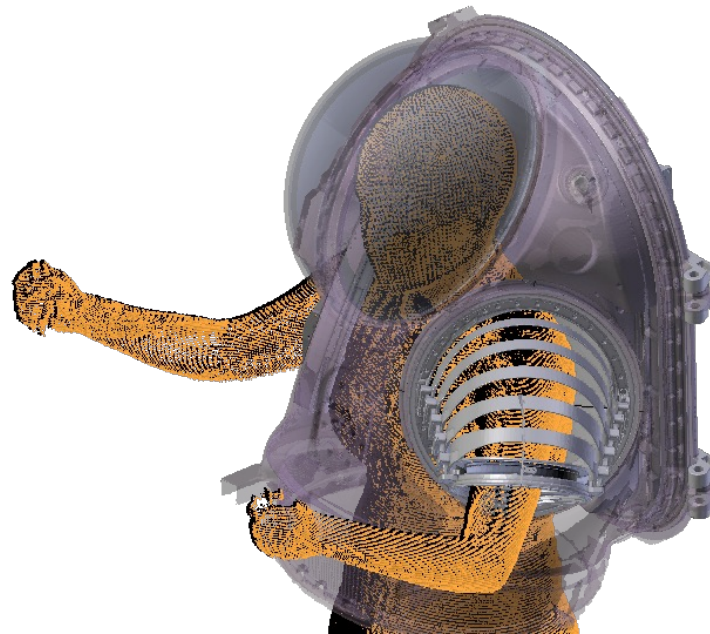
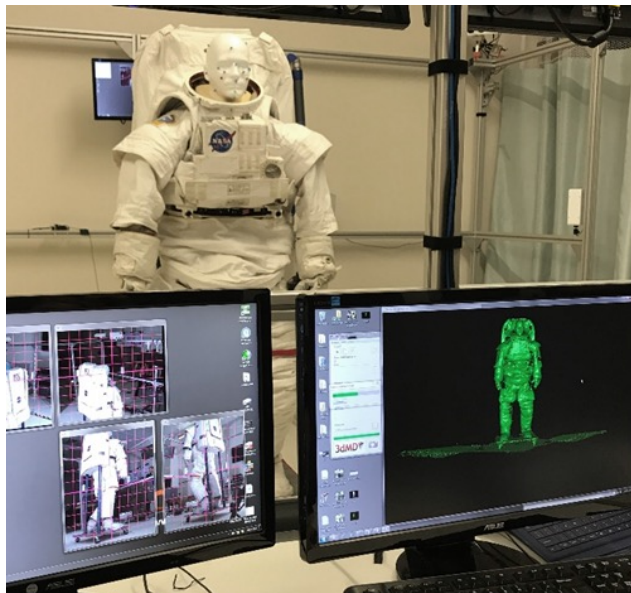

Anthropometry for Spaceflight

- Body sizes used to be “homogeneous” in early space ages
- Today, crews are in a wide variety of body sizes
- Optimal design and sizing are crucial for crew safety and performance



Crewmembers in 1960's



Crewmembers in 2000's



Artemis Era Crewmembers

Anthropometry in Space Hardware Design

- Spacesuit and vehicle designs can be drastically different depending on the specific approach to anthropometry
- Defining the extreme-to-extreme ranges of the astronaut population is critical for hardware design



Soyuz Capsule



SpaceX Dragon Capsule

Person-to-Person Variation is Complex and Multi-Dimensional

- Single measurement values (or percentiles) do not accurately represent body shape variations
- Even for persons of average stature and body weight, the specific shape variations can be substantial
- The table below shows 10 sample subjects whose stature and body weight are near the 50th percentiles
- Their other body measurements vary substantially within, ranging from 1st to 97th percentiles

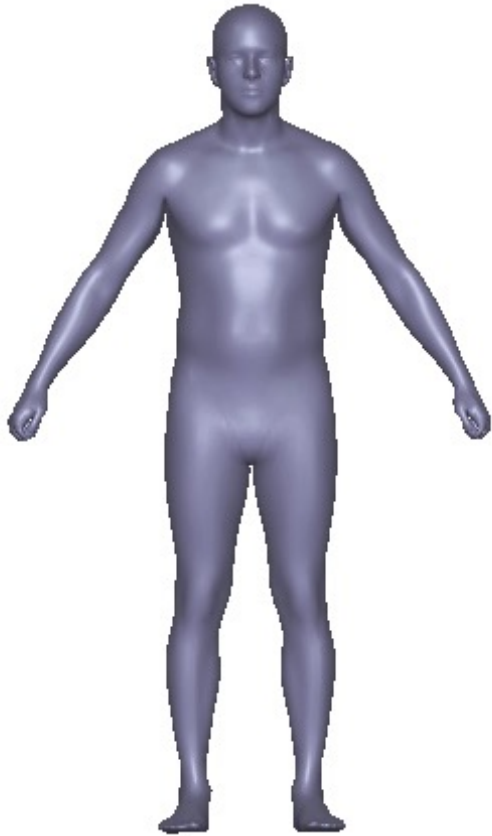

Males: 5 ft. 9 in. tall, 165 lb.



Females: 5 ft. 4 in. tall, 155 lb.

Measurement Percentiles

	Head Circumference	Chest Circumference	Waist Circumference	Thigh Circumference
Subject 1	5	70	65	68
Subject 2	84	94	64	59
Subject 3	57	76	43	23
Subject 4	77	97	24	20
Subject 5	77	57	13	33
Subject 6	91	28	54	25
Subject 7	38	60	96	9
Subject 8	14	15	26	72
Subject 9	40	33	54	25
Subject 10	17	36	1	80

Defining Accommodation Thresholds

- Multi-variate nature of anthropometric data imposes a unique challenge in design and accommodation
- In most design problems, multiple measurements (e.g., stature and body weight) are simultaneously considered
- For example, some NASA programs intend to accommodate 90% of people in astronaut-like population
- To accommodate 90% of people, at which percentile extreme do we want to truncate each measurement?

Goal: Accommodate 90% of population
So how about 5th & 95th percentiles?

Step 1: Exclude cases with *stature* < 5th percentile and > 95th percentile

Step 2: Exclude cases with *body weight* < 5th and > 95th percentile

Question: How many people will be remaining after truncations? 90% or 80%?

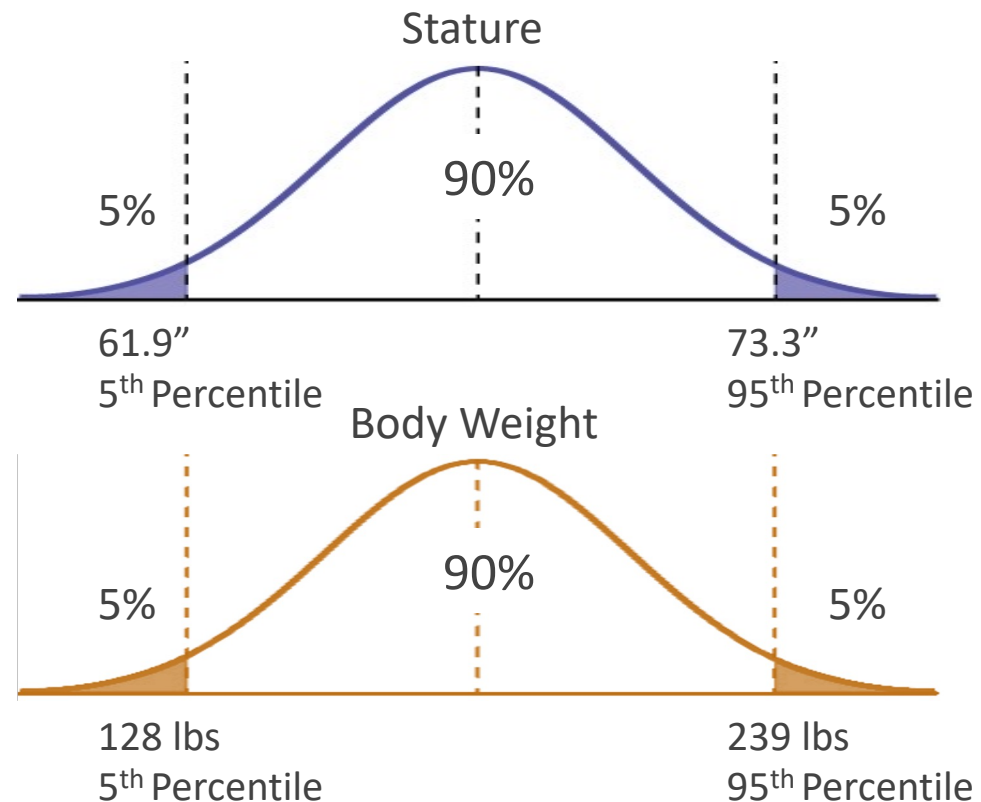

Difficulty of Multiple Measurement Truncation

Hypothetical Univariate-Like Scenario: Stature and body weight perfectly covary with each other

Step 1: Truncate by stature at 5th and 95th percentiles. 90% of cases are remaining after truncation

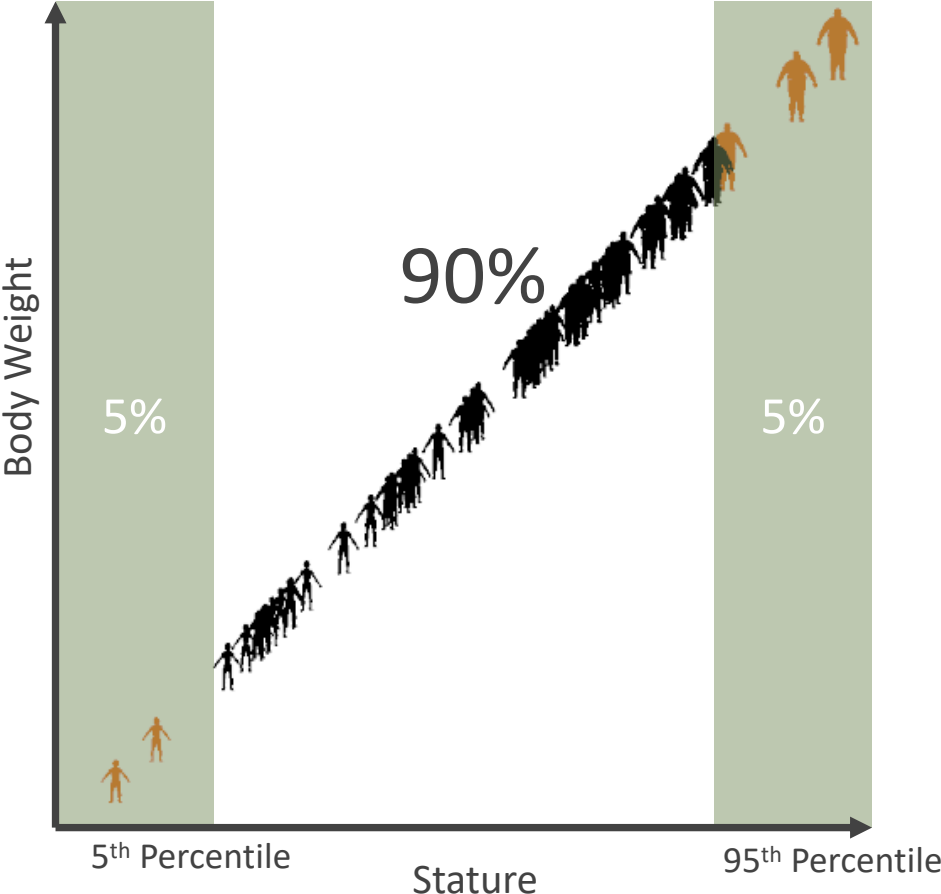

Step 2: Truncate by body weight. But no data left to be truncated. 90% of cases are still remaining.

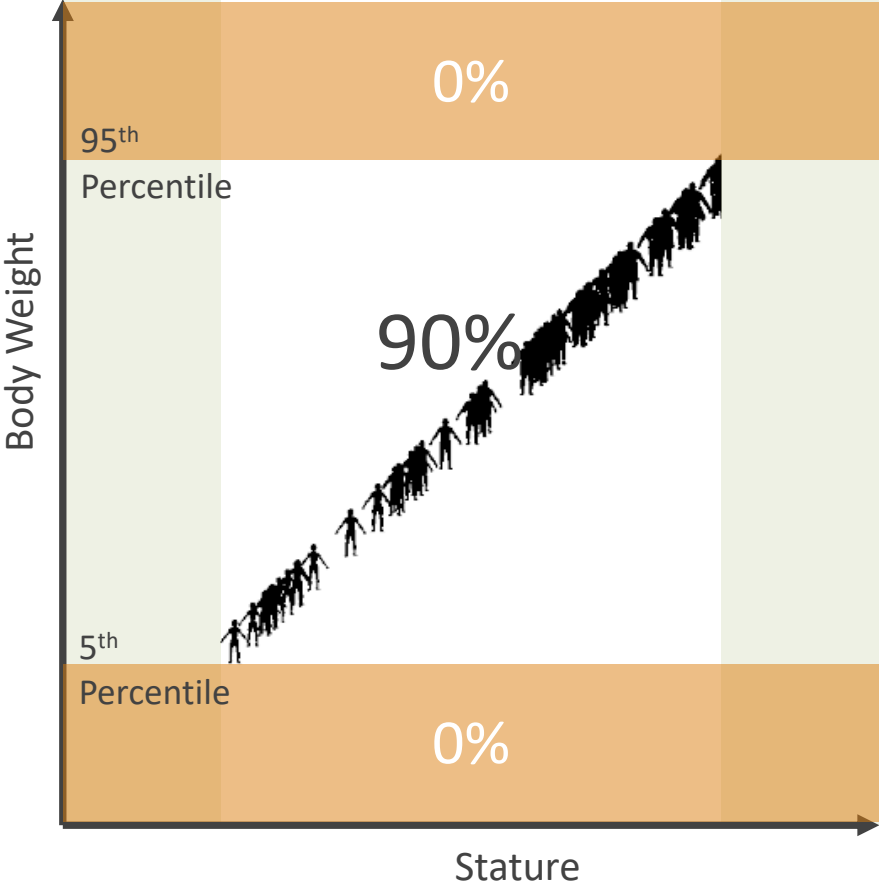

Difficulty of Multiple Measurement Truncation (Multivariate Condition)

Hypothetical Multivariate-Like Scenario: Stature and body weight vary with each other only in part

Step 1: Truncate by stature at 5th and 95th percentiles.
90% of people remain after truncation

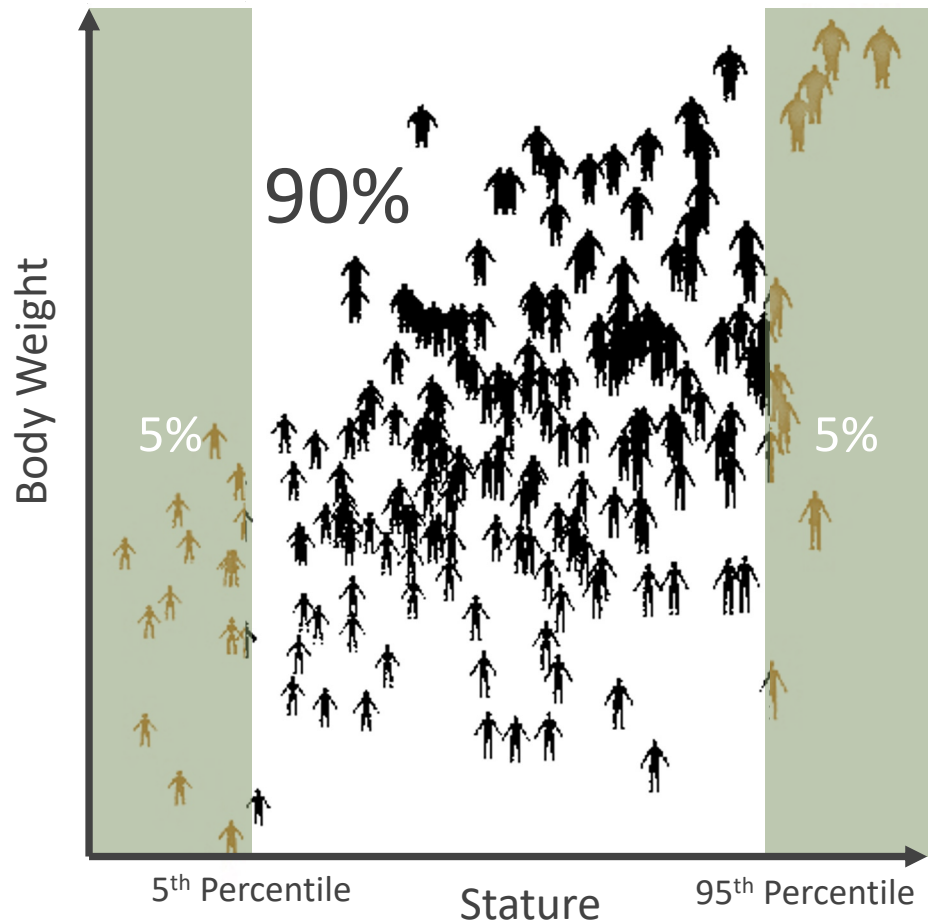

Step 2: Truncate by body weight, additional 8% cases are excluded. 82% of people remain.

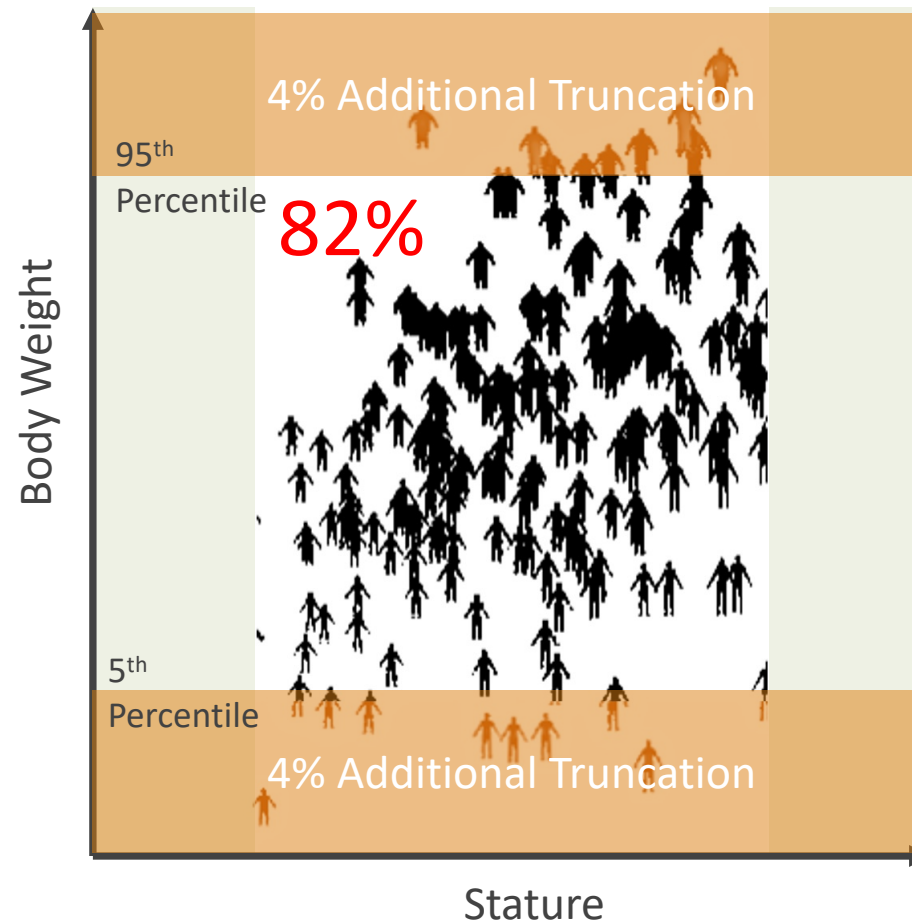

Simulation Results for Multiple Measurement Truncation

- As we include more measurements, more people are excluded with truncation
- For example, if 6 measurements are necessary for designing a spacesuit:
 - Truncation at 5th and 95th percentiles: 45% cases excluded, 55% retained
 - Truncation at 2.5th and 97.5th percentiles: 23% excluded, 77% retained
 - Truncation at 1st and 99th percentiles: 9% excluded and 91% retained
- In other words, if we want to accommodate 90% of population and we need to consider 6 body measurements for design, the data should be truncated at 1st and 99th percentiles, not 5th and 95th percentiles.

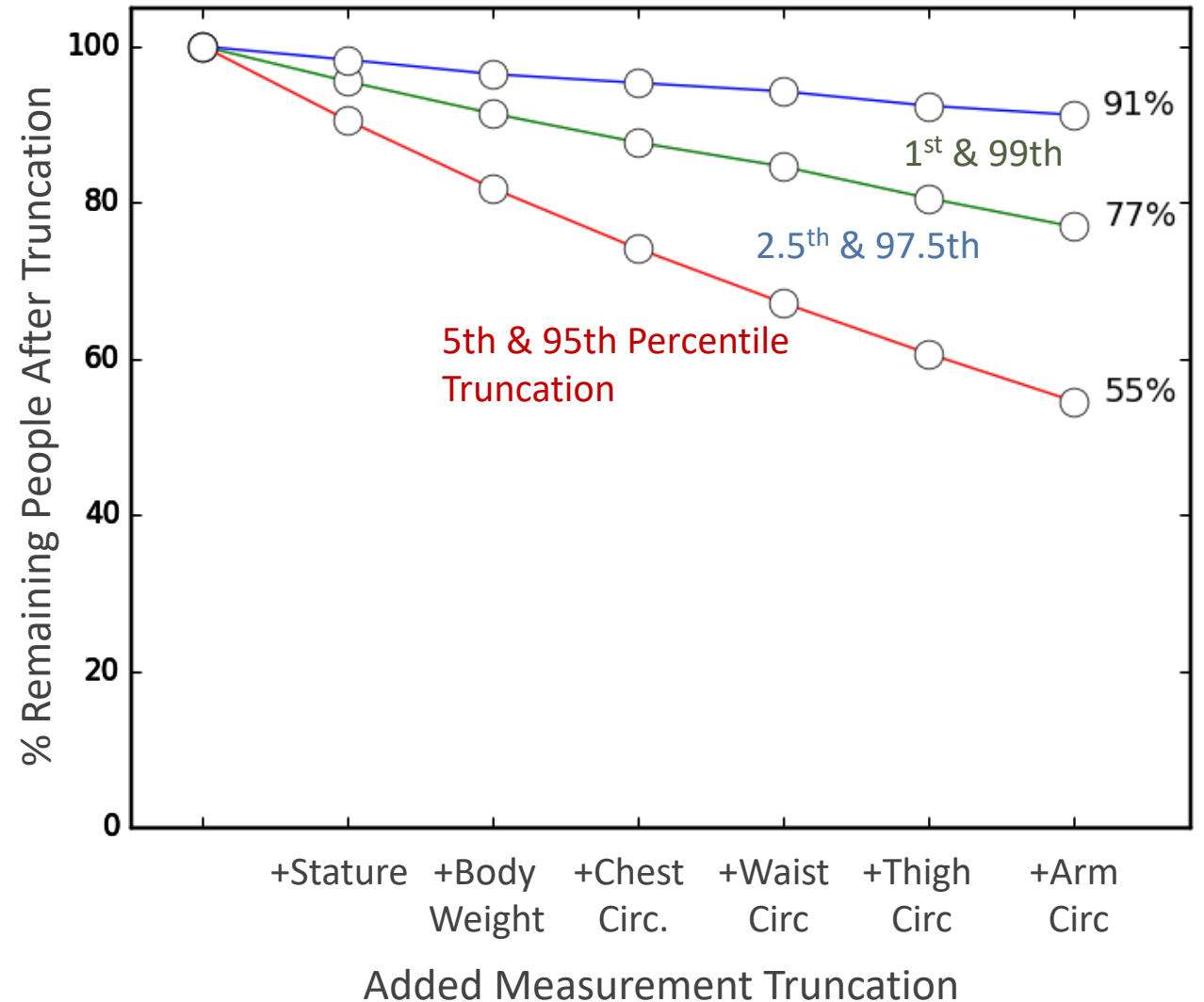

NASA Population and Critical Measurement Definition

- In the past, NASA Standards and Requirements defined hardware accommodation limit by 5th females to 95th males (e.g., International Space Station Program)
- However, past crew selections indicated many anthropometry dimensions exceed 5-95th percentile range
- Thus, some hardware may not accommodate 90% crew population when multiple measurements are incorporated
- New standards were established:
 - Parent database based on US Army ANSUR 1988
 - Down selected cases by astronaut age range (35-50 years old)
 - Growth trend was estimated from NHANES, and projected for population characteristics in 2015
 - 1st and 99th percentiles were identified for critical measurements

Critical Dimension	Application Example	Minimal Clothing	
		Min (cm, (in))	Max (cm, (in))
Stature, Standing ³	Maximum vertical clearance	148.6 (58.5)	194.6 (76.6)
Sitting Height ²	Vertical seating clearance	77.7 (30.6)	101.3 (39.9)
Eye Height, Sitting ²	Placement of panels to be within line-of-sight	66.5 (26.2)	88.9 (35.0)
Acromial Height, Sitting ²	Top of seatback	49.5 (19.5)	68.1 (26.8)
Thigh Clearance, Sitting	Placement of objects that may be overlap (panels, control wheel, etc.)	13.0 (5.1)	20.1 (7.9)
Knee Height, Sitting	Height of panels in front of subject	45.5 (17.9)	63.5 (25.0)
Popliteal Height, Sitting	Height of seat pan	33.0 (13.0)	50.0 (19.7)
Wrist Height, Sitting (with arm to the side)	Downward reach of subject	39.6 (15.6)	54.6 (21.5)
Biacromial Breadth	Placement of restraint straps	32.3 (12.7)	44.5 (17.5)
Bideloid Breadth	Width of seatback	37.8 (14.9)	56.1 (22.1)
Forearm-Forearm breadth	Side clearance envelope, possible seatback width	38.9 (15.3)	66.0 (26.0)
Hip Breadth, Sitting ¹	Width of seat pan	31.5 (12.4)	46.5 (18.3)
Buttock-Popliteal Length, Sitting	Length of seat pan	42.2 (16.6)	57.2 (22.5)
Buttock-Knee Length, Sitting	Placement of panels in front of subject	52.1 (20.5)	69.0 (27.5)

Case Study 1: Design by Truncated Multiple Measurements

- Spacesuit Liquid Cooling and Ventilation Garment (LCVVG) sizing was assessed by multiple measurements
- Three measurements were identified critical for fit. Min and max were defined from NASA requirements
- Parent database was truncated by min and max (1st and 99th percentiles) for each measurement
- Selected cases represent the target astronaut population

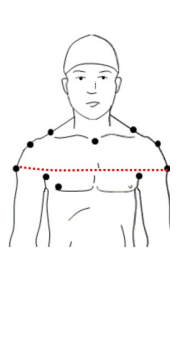
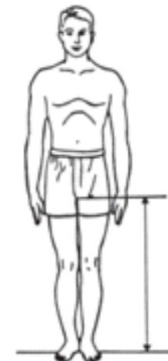

	Vertical Trunk Diameter	Shoulder Circ.	Crotch Height
Min	22.2"	35.6"	26.2"
Max	29.9"	52.7"	37.7"
			

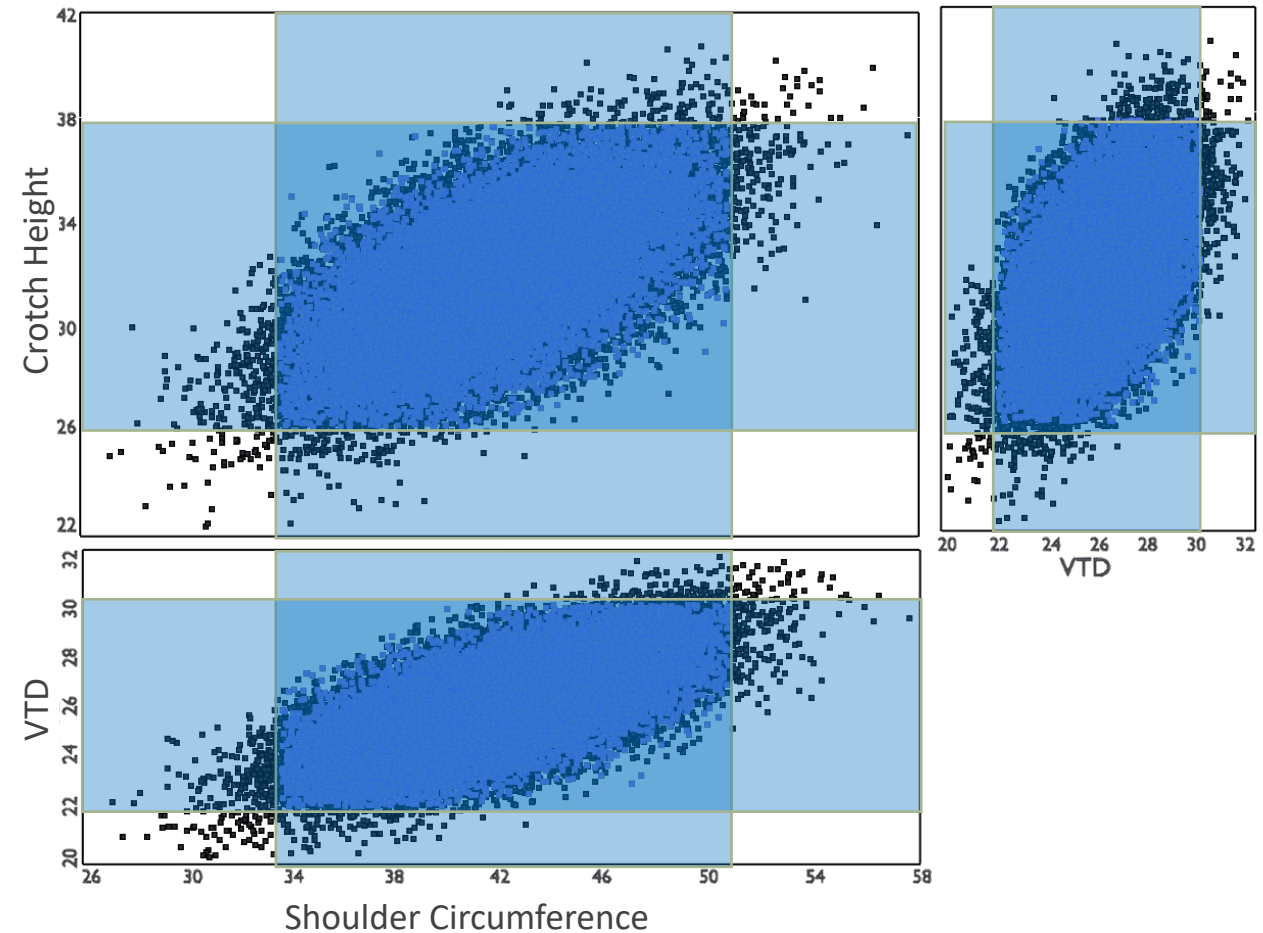

Case Study 1: Design by Truncated Multiple Measurements (Cont'd)

- Sizing schemes were built on truncated measurements
- Each box represents a size bucket, the dots within which denote the accommodated cases
- Different sizing schemes were tested; Resultant fit case proportions and coverage ranges were assessed

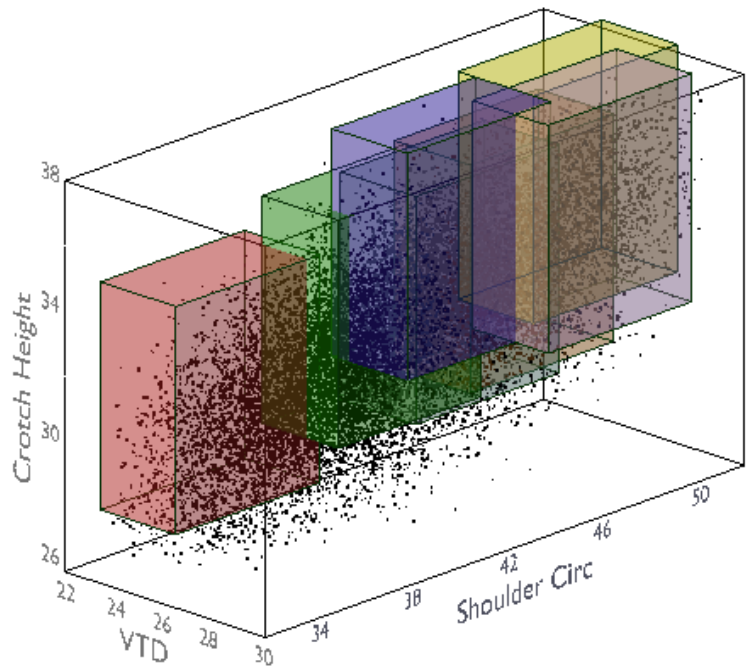

Original Sizing Scheme

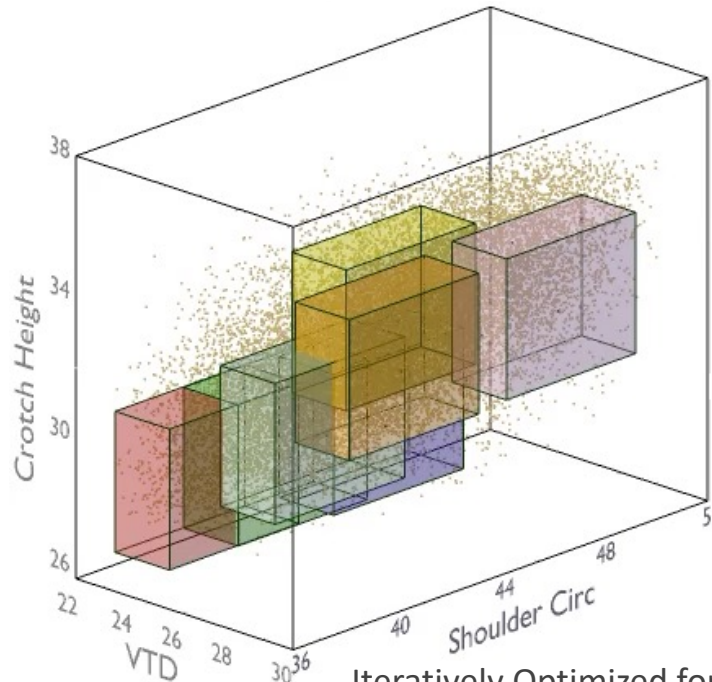

Iteratively Optimized for Maximum Fit Cases

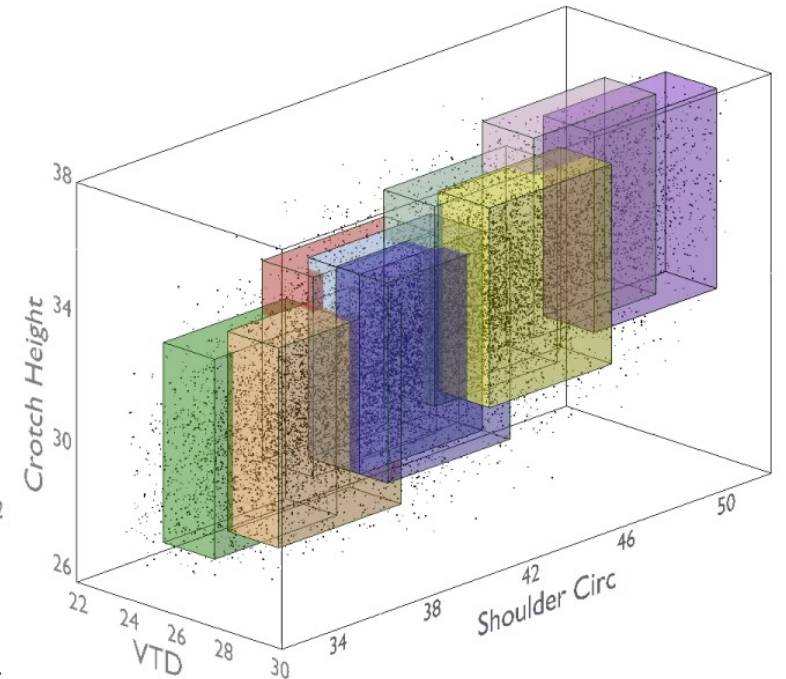

+2 Size Buckets

Fitted Case Proportion		68.5%	82.7%	89.6%
Coverage	VTD	0.7 - 98.9	1.3 - 99.1	0.7 - 99.1
	Shoulder Circ	1.3 - 99.4	1.6 - 98.6	1.3 - 99.0
Percentiles	Crotch Height	3.5 - 99.7	0.9 - 99.4	0.9 - 99.6

Case Study 2: 3D Volumetric Assessments as Alternative Approach

- Linear measurements guided the design of the past and currently deployed suits (Extravehicular Mobility Unit; EMU)
- However, linear measurements do not capture the complex 3D geometry of the human body
- For more complex designs like spacesuits, a lot more critical measurements can be involved
- Thus, matching with 1-99th percentiles for all measurements can be costly and sometimes overly conservative

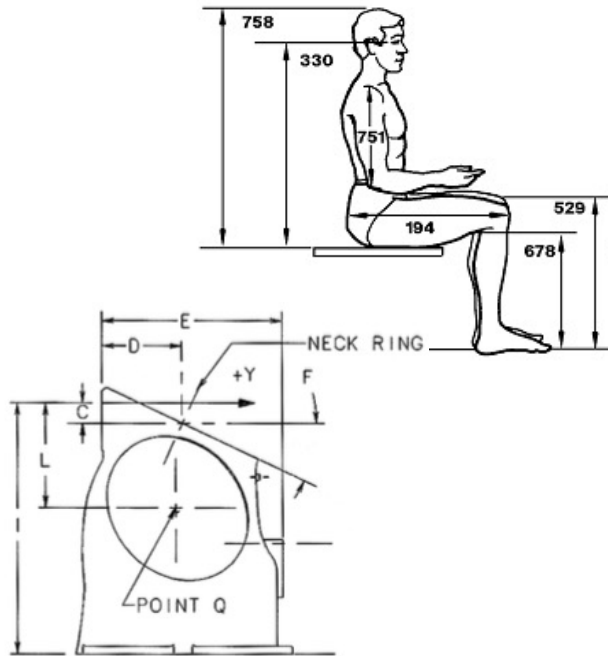

Case Study 2: 3D Volumetric Assessments (Cont'd)

- Question: can we assess fit directly using 3D body manikins, without relying on linear measurements?
- The next generation government reference design Exploration EMU (xEMU) was developed using volumetric virtual fit tests
- 3D scans overlaid with CAD. Suit-to-body contact location and magnitudes were calculated for hard upper torso (HUT) and lower torso assembly (LTA)

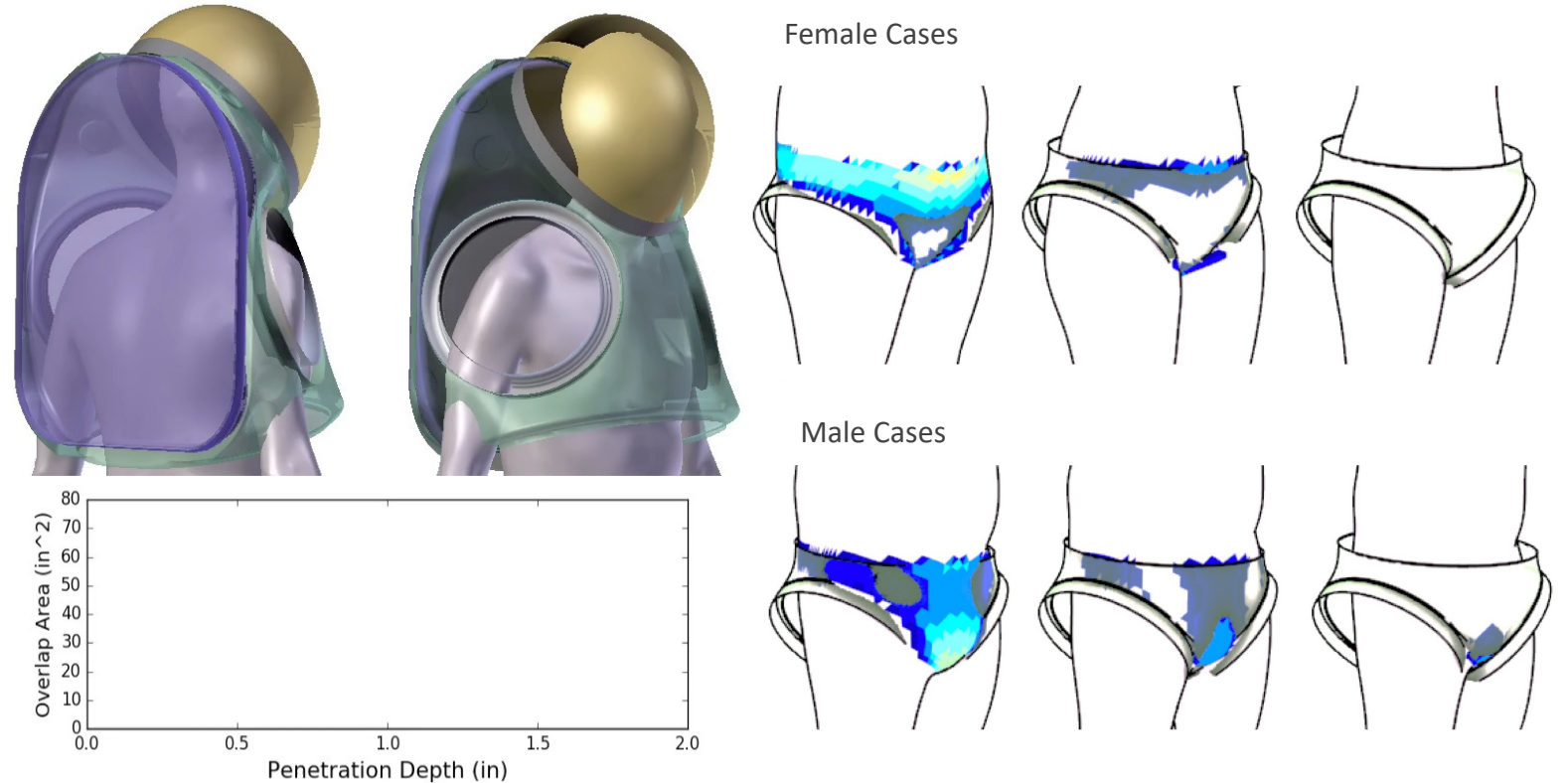

Case Study 2: 3D Volumetric Assessments (Cont'd)

- The contact patterns were used as parameters for a fit probability model, which was trained by physical fit test outcome
 $\text{Probability}(\text{Fit}) = f(\text{suit-to-body contact patterns})$
- Physical fit test subjects were selected from the “borderline fit” group and assessed for fit using 3D printed mockup

Maximum Overlap

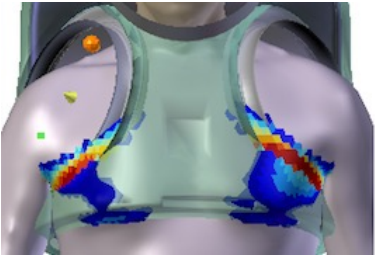

Unlikely to fit

Intermediate Overlap

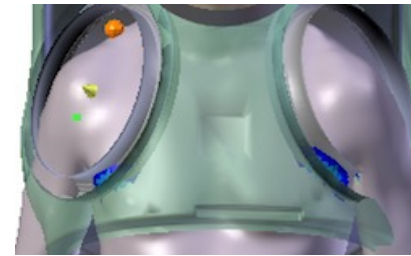
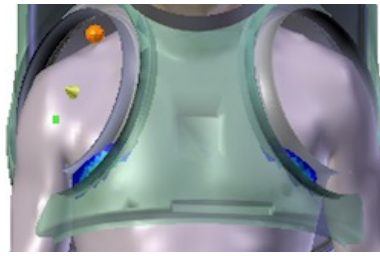
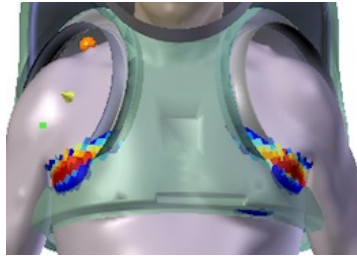

Minimum Overlap

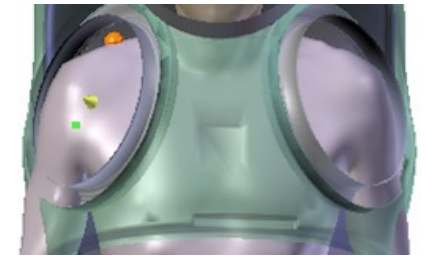

Likely to fit

← Borderline fit →

Selected for physical tests



Case Study 2: 3D Volumetric Assessments (Cont'd)

- Once trained by physical fit testing, the probability model was projected onto a large 3D body shape database ($n = 1,796$)
- The cases with fit probability ≥ 0.5 represent the proportion of population accommodated by the suit
- This technique determined the xEMU suit (hard upper torso and lower torso assembly) can accommodate over 90% of astronaut population

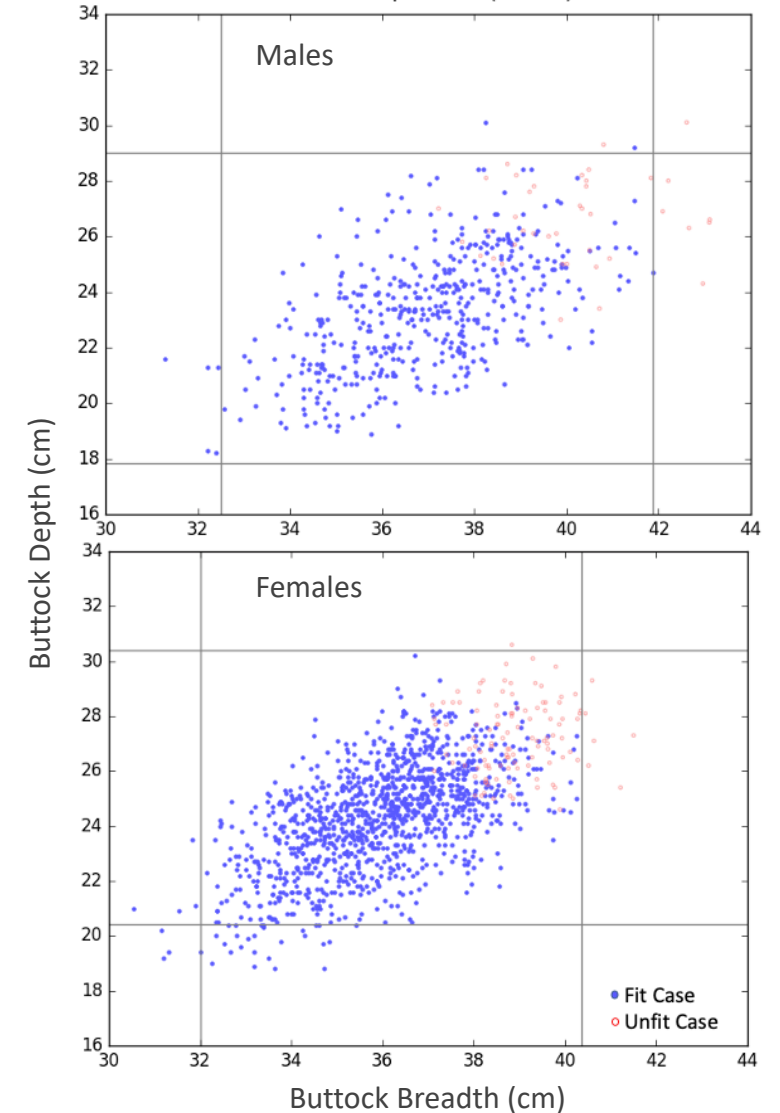
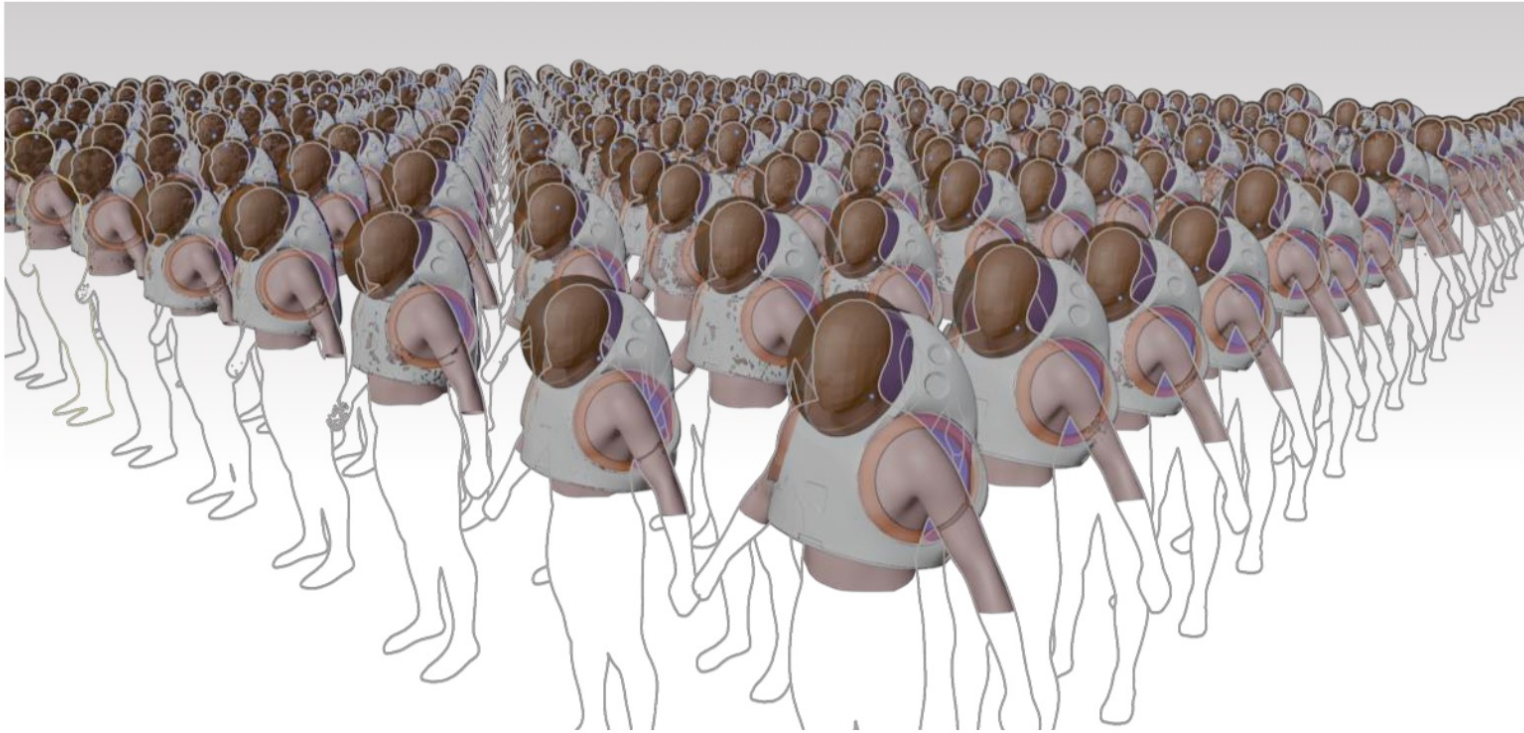

Case Study 3: Spacesuit Weighout by Volumetric Analysis

- Astronauts are trained in underwater reduced gravity analogues
- Accurate weighout of the spacesuit is critical for simulation quality and training

NASA Neutral Buoyancy Laboratory
(NBL: 202 ft × 102 ft × 40 ft diving tank)



Case Study 3: Spacesuit Weighout by Volumetric Analysis (Cont'd)

- Individual 3D body scans were segmented and calculated for segment-wise center of gravity (CG)
- Suit CG was also calculated by measuring each component, then combined with body for system CG
- Weight packs were added to cancel out the buoyancy effect and match the CG with the model calculation
- The weighout performance was assessed by motion and center of pressure measurements

Body Segment-Wise CG

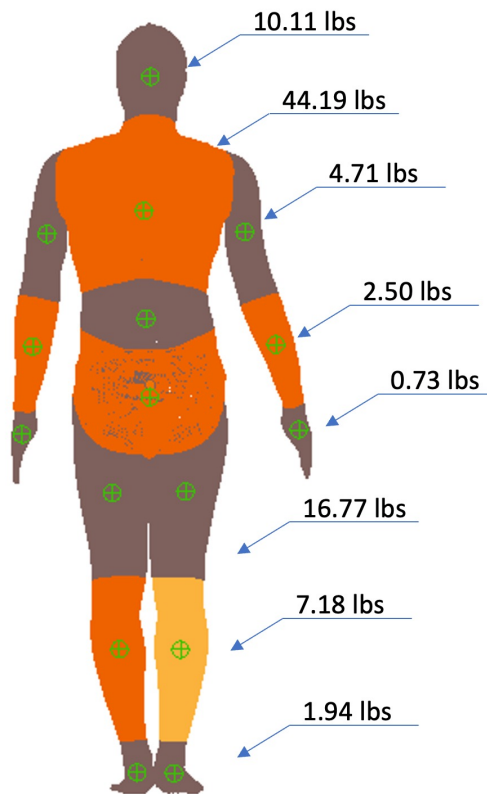

Suit Component-Wise CG



Combined System CG

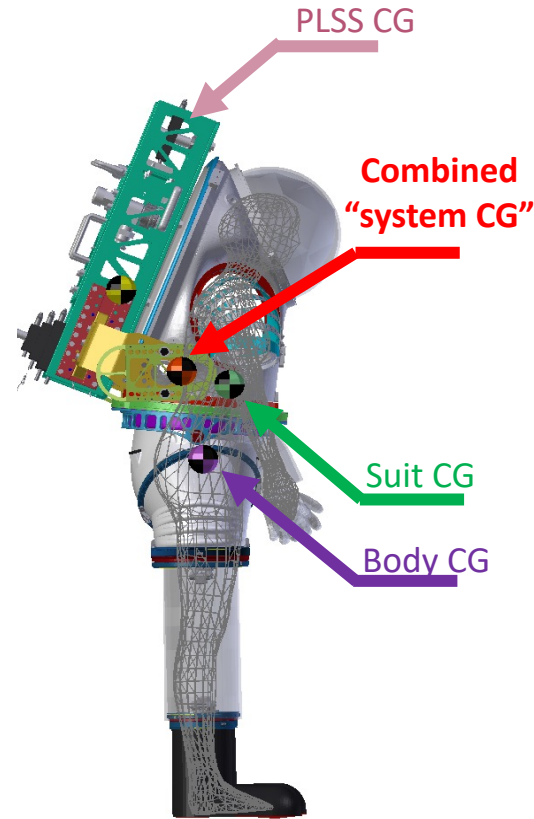

CG Adjustments by Weight Pack

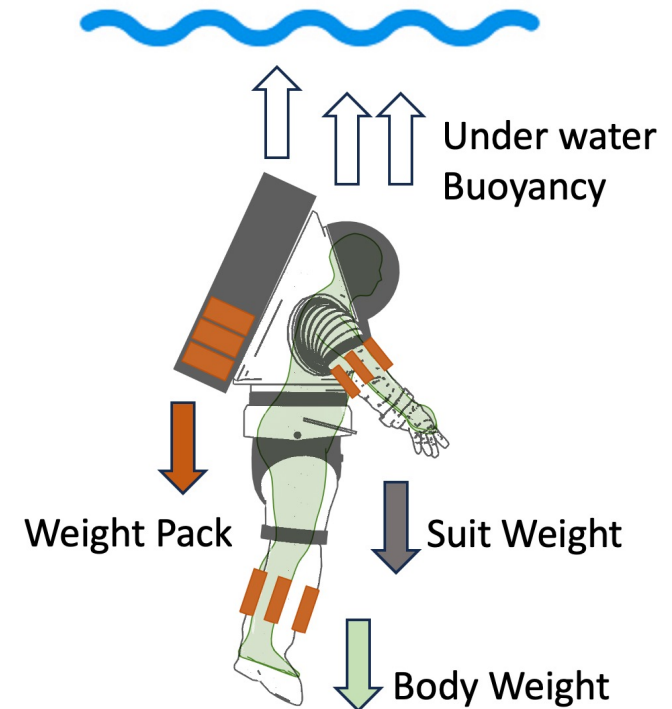

Conclusion

- This work reviewed the population accommodation principles and methodologies NASA Johnson Space Center has developed for the spacesuit and hardware
- NASA has defined the astronaut population characteristics (Human-System Integration Requirements), which is based on the US Army ANSUR, screened for age 35-50 years old and adjusted for growth trend
- Accommodation ranges were defined for critical body measurements, as NASA aims to accommodate 1st percentile female to 99th percentile male of the crew-like population
- Case studies demonstrated how the target population definition was used for fit and accommodation of the new suit and hardware design
- However, given the limitation of linear measurements, 3D volumetric representations provide unique advantages for fit assessments

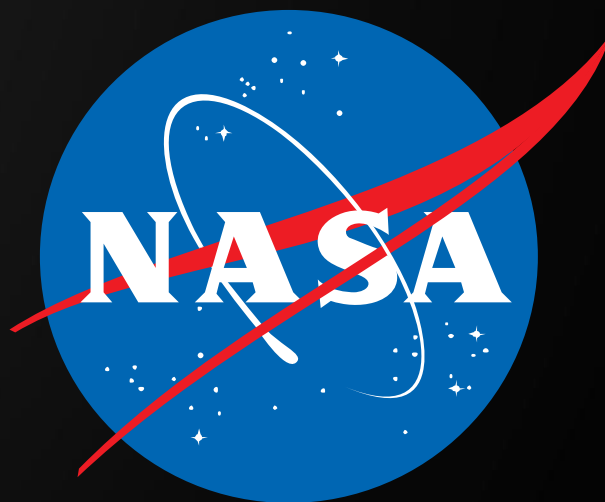

Primary POC: Han Kim (han.kim@nasa.gov)

