

NASA Technical Memorandum 103290

Reappraisal of Solid Selective Emitters

Donald L. Chubb
Lewis Research Center
Cleveland, Ohio

Prepared for the
21st Photovoltaic Specialists Conference
sponsored by the Institute of Electrical and Electronics Engineers
Kissimmee, Florida, May 21-25, 1990



(NASA-TM-103290) REAPPRAISAL OF SOLID
SELECTIVE EMITTERS (NASA) 16 p CSCL 21H

N91-11801

Unclas
63/20 0312053

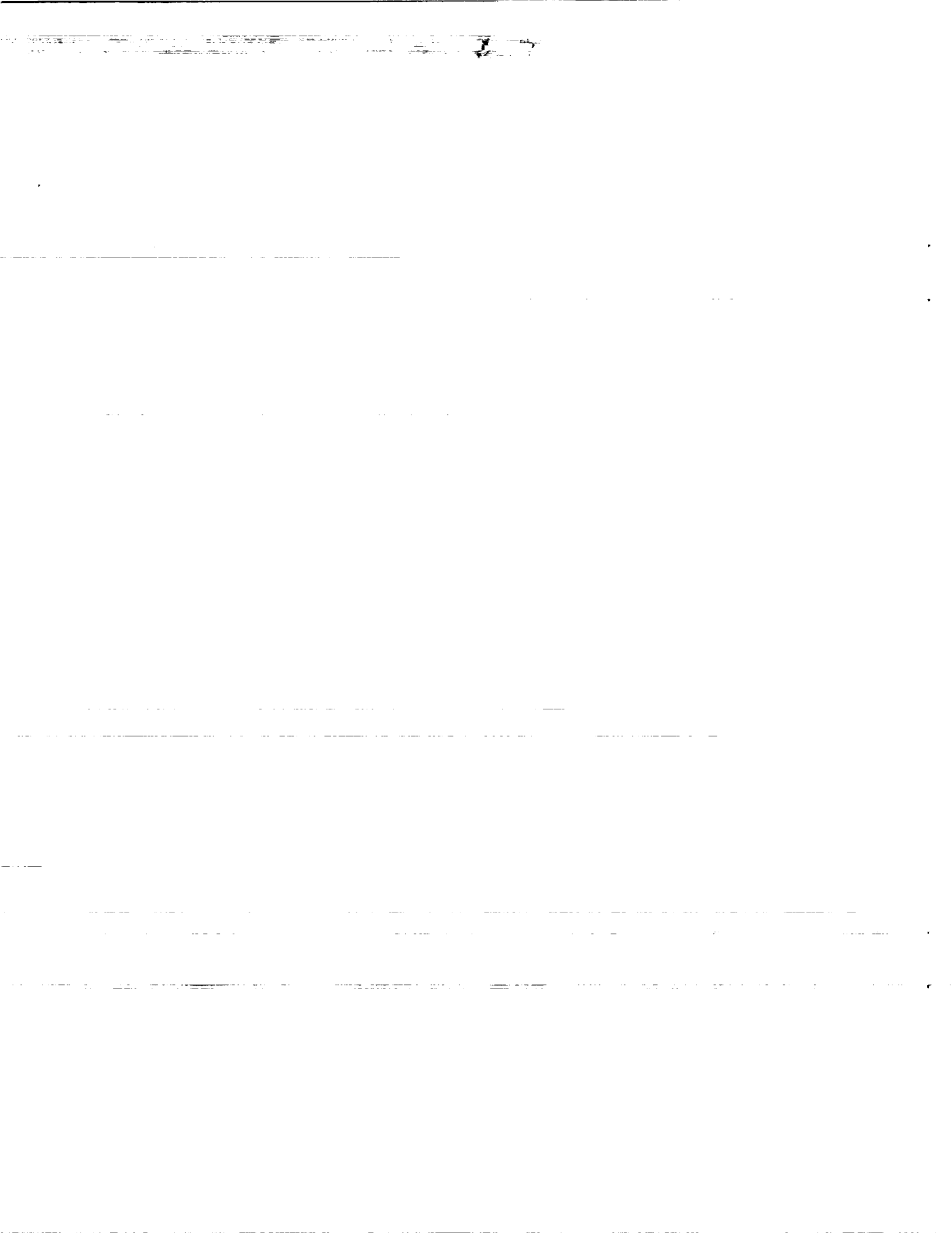

REAPPRAISAL OF SOLID SELECTIVE EMITTERS

Donald L. Chubb
National Aeronautics and Space Administration
Lewis Research Center
Cleveland, Ohio 44135

SUMMARY

New rare earth oxide emitters show greater efficiency than previous selective emitters. As a result, based on a simple model the efficiency of these new emitters was calculated. Results indicate that the emission band of the selective emitter must be at relatively low energy (≤ 0.52 eV) to obtain maximum efficiency at moderate emitter temperatures (≤ 1500 K). Thus low bandgap energy PV materials are required to obtain an efficient thermophotovoltaic (TPV) system. Of the four specific rare earths (Nd, Ho, Er, Yb) studied Ho has the largest efficiency at moderate temperatures (72 percent at 1500 K). A comparison was made between a selective emitter TPV system and a TPV system that uses a thermal emitter plus a band pass filter to make the thermal emitter behave like a selective emitter. Results of the comparison indicate that only for very optimistic filter and thermal emitter properties will the filter TPV system have a greater efficiency than the selective emitter system.

INTRODUCTION

The early work of White and Schwartz (ref. 1) recognized the benefits of selective emitters for efficient thermophotovoltaic (TPV) energy conversion. However, finding an efficient selective emitter has been a difficult task. The most promising solid selective emitters have been the rare earth elements (ref. 2). For doubly and triply charged ions of these elements in crystals the orbits of the valence 4f electrons, which account for emission and absorption, lie inside the 5s and 5p electron orbits. As a result, the rare earth ions in the solid state have radiative characteristics much like they would have if they were isolated. They emit in narrow bands rather than in a continuum as do most solids. The 5s and 5p electrons "shield" the 4f valence electrons from the surrounding ions in the crystal. The spectra of these rare earth ions in crystals have been extensively studied. Most of this work is summarized in the text of Dieke (ref. 3).

The rare earths to be considered in this study are neodymium, Nd, holmium, Ho, erbium, Er, and ytterbium, Yb in the oxide form (Nd_2O_3 , Ho_2O_3 , Er_2O_3 and Yb_2O_3).

Early spectral emittance work (ref. 2) on rare earth oxides that are suitable for TPV showed strong emission bands. However, the emittance for photon energies below the bandgap for PV materials was also significant. As a result, the efficiency of these emitters was low. In the last few years, however, Nelson and coworker (refs. 4 and 5) have reported a large improvement in rare earth oxide emitters. Their emitters are constructed of fine (5 to 10 μm) rare earth oxide fibers similar to the construction of the Welsbach mantle used in gas lanterns. The very small characteristic dimension of the

emitter results in low emittance for the low energy part of the spectrum, thus giving a much higher efficiency than previous emitters.

This study models the emissive properties of the rare earths in order to calculate the radiative efficiency. From the radiative efficiency results conclusions are made about where each of the considered rare earths is most appropriate for a TPV system. Finally, a selective emitter TPV system is compared to a TPV system that uses a band pass filter to make a thermal emitter behave like a selective emitter.

EMITTER EFFICIENCY ANALYSIS

As already mentioned, the new rare earth oxide emitters (refs. 4 and 5) show a single strong emission band centered around some photon energy, E_g . For photon energies above and below this emission band the emissivity is greatly reduced. Therefore, the following model is used to describe the rare earth oxide emitters. There is a single emission band of width ΔE_g centered about photon energy, E_g . Outside this emission band the emissivity is ϵ_l for $E \leq E_l = E_g - 1/2 \Delta E_g$ and ϵ_u for $E \geq E_u = E_g + 1/2 \Delta E_g$. Now define the emitter radiative efficiency as follows,

$$\eta_E = \frac{P_E}{P_{RAD}} \quad (1)$$

where P_E is the useful emitted radiative power per unit area from emission band at E_g and P_{RAD} is the total emitted radiative power per unit area. Obviously, this efficiency does not include thermal conductive or convective heat loss. A photovoltaic (PV) material with bandgap energy just slightly less than E_g is capable of efficient conversion of this useful energy, P_E .

The two powers in equation (1) can be written as follows:

$$P_E = \epsilon_g \int_{E_l}^{E_u} e_b dE \quad (2)$$

$$P_{RAD} = \epsilon_l \int_0^{E_l} e_b dE + \epsilon_g \int_{E_l}^{E_u} e_b dE + \epsilon_u \int_{E_u}^{\infty} e_b dE \quad (3)$$

Where, $\epsilon(E)$ is the total hemispherical emissivity and e_b is the black body emissive power so that,

$$\epsilon_l = \frac{\int_0^{E_l} \epsilon e_b dE}{\int_0^{E_l} e_b dE} \quad (4a)$$

$$\epsilon_g = \frac{\int_{E_1}^{E_u} \epsilon e_b dE}{\int_{E_1}^{E_u} e_b dE} \quad (4b)$$

$$\epsilon_u = \frac{\int_{E_u}^{\infty} \epsilon e_b dE}{\int_{E_u}^{\infty} e_b dE} \quad (4c)$$

and,

$$e_b dE = \frac{2\pi}{h^3 c_0^2} \frac{E^3}{\left[\exp\left(\frac{E}{kT_E}\right) - 1 \right]} dE \quad (5)$$

where, h is the Planck constant, c_0 is the speed of light in vacuum, k is the Boltzmann constant and T_E is the emitter temperature (K). Substituting equations (2) and (3) in (1) yields the following.

$$\eta_E = \frac{\epsilon_g \int_{E_1}^{E_u} e_b dE}{\epsilon_g \int_{E_1}^{E_u} e_b dE + \epsilon_u \int_{E_u}^{\infty} e_b dE + \epsilon_l \left[\sigma T_E^4 - \int_{E_1}^{\infty} e_b dE \right]} \quad (6)$$

In obtaining equation (6) the following result was used.

$$\int_0^{E_1} e_b dE = \sigma T_E^4 - \int_{E_1}^{\infty} e_b dE \quad (7)$$

Where σ is the Stefan-Boltzmann constant ($5.67 \times 10^8 \text{ W/m}^2\text{K}^4$). For the rare earths and emitter temperatures of interest the smallest value of $E_1/kT_E \approx 1.9$. Therefore, it is a good approximation to assume $e^{E/kT_E} - 1 \approx e^{E/kT_E}$ in equation (5). As a result, the integrals in equation (6) can be carried out so that the emitter efficiency becomes the following.

$$\eta_E = \frac{1}{1 + (\epsilon_l/\epsilon_g)G[E_g/kT_E, \Delta E_g/E_g] + (\epsilon_u/\epsilon_g)H[E_g/kT_E, \Delta E_g/E_g]} \quad (8)$$

Where,

$$G[u, z] = \frac{\frac{\pi^4}{15} \text{Exp}(x_l) - F[x_l]}{F[x_l] - F[x_u]\text{Exp}(-zu)} \quad (9a)$$

$$H[u, z] = \frac{F[x_u]\text{Exp}(-zu)}{F[x_l] - F[x_u]\text{Exp}(-zu)} \quad (9b)$$

$$x_l = \frac{E_l}{kT_E} = u\left(1 - \frac{z}{2}\right) \quad (9c)$$

$$x_u = \frac{E_u}{kT_E} = u\left(1 + \frac{z}{2}\right) \quad (9d)$$

$$z = \frac{\Delta E_g}{E_g} \quad (9e)$$

$$u = \frac{E_g}{kT_E} \quad (9f)$$

$$F(x) = x^3 + 3x^2 + 6x + 6 \quad (9g)$$

As equation (8) shows, there are four parameters that determine the efficiency; $\Delta E_g/E_g$, E_g/kT_E , ϵ_l/ϵ_g and ϵ_u/ϵ_g . In figure 1 the efficiency is shown as a function of E_g/kT_E for several values of $\epsilon_u/\epsilon_g = \epsilon_l/\epsilon_g$, and $\Delta E_g/E_g = 0.1$. As can be seen there is an optimum value for E_g/kT_E to obtain maximum η_E . These results also show that it is essential to have small ϵ_l/ϵ_g and ϵ_u/ϵ_g in order to obtain maximum efficiency. This was not the case for the early rare earth oxide emitters and therefore they were inefficient.

The case of figure 1 where $\epsilon_u/\epsilon_g = \epsilon_l/\epsilon_g$ and $(E_g/kT_E)_{\text{opt}} = 4.0$ leads to the result that an emitter with $E_g \leq 0.69$ eV is required if $T_E \leq 2000$ K. Also, if it is desirable to have $T_E \leq 1500$ K then $E_g \leq 0.52$ eV is required to obtain maximum η_E . Thus in order to obtain a high efficiency TPV system at moderate emitter temperatures relatively low bandgap PV materials are required.

In figure 2 the effect on efficiency of variable below emission band emissivity, ϵ_l , is demonstrated. Reducing ϵ_l obviously increases η_E . However, changing ϵ_l also causes the $(E_g/kT_E)_{\text{opt}}$ to shift. As ϵ_l decreases, $(E_g/kT_E)_{\text{opt}}$ increases. This is a desirable situation since maximum efficiency for a given E_g can be attained at lower temperature. As figure 2 shows, however, $\epsilon_l/\epsilon_g \leq 0.05$ in order to produce a significant increase in $(E_g/kT_E)_{\text{opt}}$.

Efficiency dependence on the above emission band emissivity, ϵ_U is illustrated in figure 3. As expected, η_E increases as ϵ_U decreases. However, the increase in η_E is less than the increase that results from decreasing ϵ_l . For $\epsilon_l/\epsilon_g = 0.01$ and $\epsilon_U/\epsilon_g = 0.1$, $[\eta_E]_{MAX} \geq 0.7$ but for $\epsilon_l/\epsilon_g = 0.1$ and $\epsilon_U/\epsilon_g = 0.01$, $[\eta_E]_{MAX} \leq 0.6$. Also, decreasing ϵ_U/ϵ_g causes an undesirable shift in $(E_g/KT_E)_{opt}$ to lower values. Therefore, higher temperatures are required to obtain maximum efficiency.

The effect of dimensionless emission bandwidth, $\Delta E_g/E_g$, was also investigated. As expected, the emitter efficiency increases with increasing bandwidth. However, for $\Delta E_g/E_g \leq 0.5$ the location of $[\eta_E]_{MAX}$ is not changed. Also the width of the η_E versus E_g/kT_E curve increases as $\Delta E_g/E_g$ increases.

Based on the results of this model for the rare earth selective emitters the following two important conclusions can be made. First of all, to obtain maximum efficiency at moderate temperatures (< 1500 K), the emission band must be centered at relatively low energy ($E_g \leq 0.52$ eV). Thus low bandgap PV materials are required to obtain an efficient TPV system. Also to obtain high efficiency at moderate temperature, it is more important to reduce the below emission band emissivity, ϵ_l , than the above band emissivity, ϵ_U .

EMITTER EFFICIENCY FOR SELECTED RARE EARTHS

Now consider the emitter efficiency, η_E , for each of the rare earths shown in Table I. The relative spectral exitance data for the fibrous emitters of Nelson and coworkers (refs. 4 to 6) were used to obtain ϵ_l/ϵ_g , ϵ_U/ϵ_g and $\Delta E_g/E_g$. Values for $\Delta E_g/E_g$ were calculated from these data, however, the emissivity ratios, ϵ_l/ϵ_g and ϵ_U/ϵ_g , are only estimates rather than actual integrations of the data (see eq. (4)). The temperature dependence of the emissivity ratios was neglected. This should be a good approximation for the small temperature range (1000 to 3000 K) considered. Nelson's data was taken in the 1800 to 2000 K temperature range. The emissivity ratios used here are conservative estimates based on that data. However, since he presents no data for $E < 0.5$ eV ($\lambda > 2.5 \mu m$) the ϵ_l/ϵ_g ratios are not as reliable as the ϵ_U/ϵ_g ratios. More will be said about the emissivity ratios when efficiencies of each of the 4 rare earths are discussed.

Ytterbia, Yb_2O_3 , is of great interest for two reasons. First of all, the emission band at $E_g = 1.29$ eV is a good match to silicon, which has a bandgap energy of 1.12 eV at 300 K. Secondly, it has only a single strong emission band (refs. 2, 4, and 5). Ytterbium has only one observed energy level above the ground state (ref. 3). Figure 4 shows η_E as a function of T_E for $\epsilon_U/\epsilon_g = 0.01$ and $\epsilon_l/\epsilon_g = 0.07$. The value for ϵ_l/ϵ_g was obtained from reference 5. Since the Yb spectrum shows negligible radiation for $E > E_g$ the low value of $\epsilon_U/\epsilon_g = 0.01$ was chosen. Also, the experimental value for η_E of Parent and Nelson (ref. 5), which is close to the theoretical value, (ref. 5) is shown in figure 4. Note that for $T_E < 2000$ K the efficiency is far from the maximum. Thus, even though Yb has low values of ϵ_l/ϵ_g and ϵ_U/ϵ_g high efficiency is only possible if $T_E \approx 3000$ K can be attained.

The close match of erbium's emission band at $E_g = 0.827$ eV with germanium's bandgap of 0.66 eV makes Er_2O_3 a good candidate for a TPV system

(ref. 7). Also, the ternary semiconductor, $\text{Ga}_{.47}\text{In}_{.53}\text{As}$ (ref. 9) has a bandgap of 0.75 eV, which matches Er very well. Nelson's (ref. 4) Er_2O_3 data show a narrow bandwidth for Er, $\Delta E_g/E_g = 0.05$. Also, negligible emissivity above and below E_g is shown in Nelson's data (ref. 4). Therefore, $\epsilon_u/\epsilon_g = 0.01$ and $\epsilon_l/\epsilon_g = 0.05$ were chosen as representative of Er. With this input the emitter efficiency for Er was calculated and is shown in figure 5. The narrow bandwidth for Er limits the maximum efficiency to approximately 0.55. Also, for $\eta_E \geq 0.5$ the emitter temperature must be high ($T_E > 2000$ K).

Holmium has a strong emission band at $E_g = 0.62$ eV, which is slightly below the bandgap of germanium (0.66 eV at 300 K.) However, increasing the germanium temperature to 408 K reduces the bandgap of germanium to 0.62 eV (ref. 8) although this would also decrease the PV efficiency. In addition the bandgap of the ternary semiconductor, $\text{Ga}_x\text{In}_{1-x}\text{As}$, can be varied by changing the ratio of Ga_x and In_{1-x} . This has been accomplished in the construction of infrared detectors (ref. 10). Nelson's (ref. 6) spectral data for Ho_2O_3 above the emission band at 0.62 eV show a weak radiation band at ~ 1.0 eV with negligible emissivity everywhere else down to $E = 0.5$ eV. Therefore, it was assumed that $\epsilon_u/\epsilon_g = 0.02$ and $\epsilon_l/\epsilon_g = 0.05$. Using this data η_E was calculated and is shown in figure 6. As can be seen, $\eta_E > 0.7$ for $T_E \geq 1500$ K. Thus Ho has the potential for large efficiency at moderate emitter temperatures.

The final rare earth oxide considered is neodymia, Nd_2O_3 . It is of interest because it has the potential for the highest efficiency at the lowest temperature. Neodymium has a strong emission band at 0.496 eV resulting from the ${}^4\text{I}_{13/2} \rightarrow {}^4\text{I}_{9/2}$ transition (ref. 6). Nelson (ref. 6) also detects two much lower intensity emission bands at 1.5 and 0.74 eV. Nelson (ref. 6) has no data for photon energies less than the strong emission band at $E_g = 0.496$ eV. However there are possibilities for 0.25 eV ($\lambda = 5 \mu\text{m}$) photons from ${}^4\text{I}_{15/2} \rightarrow {}^4\text{I}_{13/2}$ and ${}^4\text{I}_{11/2} \rightarrow {}^4\text{I}_{9/2}$ transitions (ref. 3). Therefore, to model Nd the following emissivity ratios were chosen $\epsilon_l/\epsilon_g = 0.1$ and $\epsilon_u/\epsilon_g = 0.1$. Figure 7 shows the Nd efficiency results. Maximum efficiency occurs at $T_E \approx 1400$ K. Therefore, Nd is well suited for operation at moderate temperatures (< 1500 K). However, because Nd has larger ϵ_u/ϵ_g and ϵ_l/ϵ_g the maximum efficiency for Nd is less than the other rare earths.

The low energy emission band ($E_g = 0.496$ eV) for Nd leads to η_E being attained at low temperature. However, the low E_g means that a new low energy bandgap PV cell must be developed in order for a Nd emitter to be used in a TPV system. Indium arsenide, InAs, has a bandgap of 0.36 eV and is a good candidate for matching with a Nd emitter in a TPV system. Again the ternary semiconductor, $\text{Ga}_x\text{In}_{1-x}\text{As}$, is also a possible PV material to match with a Nd emitter. One disadvantage of a low temperature (< 1500 K) TPV system is the resulting lower power density. Remember that the power density is proportional to T_E^4 and thus sensitive to emitter temperature changes.

COMPARISON OF FILTER TPV AND SELECTIVE EMITTER TPV

Rather than using a selective emitter a thermal emitter plus filter can also be used in a TPV system. In a thermal emitter system a narrow band filter is placed in front of the emitter to make it perform like a selective emitter.

The ideal filter allows all photons with $E_l \leq E \leq E_u$ to pass from the emitter to the PV cell and reflects all photons with $E < E_l$ and $E > E_u$ back to the emitter. The filter recycles the inefficient photons back to the emitter. Such solar TPV systems have been considered by many researchers (refs. 11 to 15). The critical component in these systems is the filter. As Bell (ref. 12) and Sirkl and Ries (ref. 15) point out introducing only a 10 percent filter loss reduces the ideal (no filter losses) efficiency by more than a factor of 1.5. It should also be mentioned that a real emitter will not have perfect black body properties (emissivity = absorptivity = 1).

Now consider the following simple comparison of a TPV system that uses a thermal emitter with a bandpass filter to a TPV system that uses a selective emitter. Figure 8 is a schematic drawing of the two systems. The thermal input power, P_t , is assumed the same for both systems. This thermal input could be from a solar concentrator, a chemical combustion process or a nuclear reactor.

In both systems the PV array will "see" mainly the useful photons that are in the energy interval, $E_l \leq E \leq E_u$. Therefore, it is assumed that the photovoltaic efficiency, η_{PV} , is the same in both systems.

In the thermal emitter system a portion $\bar{\tau}_f P_{RAD}^O$ of the emitted power, P_{RAD}^O is transmitted to the PV array and a portion, $\bar{r}_f P_{RAD}^O$ is reflected back to the emitter. Of the reflected power a portion, $\bar{\alpha}_E \bar{r}_f P_{RAD}^O$ is absorbed by the emitter, where $\bar{\tau}_f$ is the total transmission of the filter, \bar{r}_f is the total reflectivity of the filter and $\bar{\alpha}_E$ is the total absorptivity of the emitter.

Also, for conservation of energy,

$$\bar{\tau}_f + \bar{r}_f + \bar{\alpha}_f = 1 \quad (10)$$

Where $\bar{\alpha}_f$ is the total absorptivity of the filter. An energy balance on the emitter yields the following.

$$P_{RAD}^O + P_L^O = P_t + \bar{\alpha}_E \bar{r}_f P_{RAD}^O \quad (11)$$

Where P_L^O is the conductive and convective heat loss to the surroundings of the emitter.

Defining the emitter thermal efficiency as

$$\eta_{th}^O = \frac{P_{RAD}^O}{P_t} = 1 - \frac{P_L^O}{P_t} \quad (12)$$

and combining with equation (11) yields

$$P_{RAD}^O = \frac{\eta_{th}^O P_t}{1 - \bar{\alpha}_E \bar{r}_f} \quad (13)$$

Therefore, if η_{PV} is the PV efficiency the electrical power output is the following.

$$P_{EL}^O = \eta_{PV} \eta_f \eta_{th}^O P_t \quad (14)$$

Where,

$$\eta_f = \frac{\bar{\tau}_f}{1 - \bar{\alpha}_E^O \bar{\tau}_f} = \frac{\bar{\tau}_f}{1 - \bar{\alpha}_E^O (1 - \bar{\alpha}_f - \bar{\tau}_f)} \quad (15)$$

can be considered as the efficiency of the filter.

Now consider the selective emitter TPV system. In this case the electrical output power is the following.

$$P_{EL} = \eta_{PV} \eta_E \eta_{th} P_t \quad (16)$$

Where η_E is the emitter efficiency defined by equation (1) and

$$\eta_{th} = \frac{P_{RAD}}{P_t} = 1 - \frac{P_L}{P_t} \quad (17)$$

is the thermal efficiency of the selective emitter, which includes the conductive and convective heat loss, P_L , of the emitter. For similar designed systems it is expected that $\eta_{th}^O \approx \eta_{th}$.

Assuming $\eta_{th}^O \approx \eta_{th}$, equations (13) and (15) yield the following,

$$\frac{P_{EL}^O}{P_{EL}} = \frac{\eta_f}{\eta_E} \quad (18)$$

Thus if,

$$\eta_f > \eta_E \quad (19)$$

then the filter TPV system electrical output, P_{EL}^O , will be greater than the selective emitter electrical output, P_{EL} . Obviously, if the emitter is a perfect black body ($\bar{\epsilon}^O = \bar{\alpha}_E^O = 1$) and there are no filter losses ($\bar{\alpha}_f = 0$) then $\eta_f = 1$ (see eq. (15)). In this case the filter system will always be superior to the selective emitter system.

For the filter system consider the filter to have the following spectral transmission, τ_f .

$$\tau_f = 0 \quad \text{for } E < E_l \quad (20a)$$

$$\tau_f = \tau_g \quad \text{for } E_l \leq E \leq E_u \quad (20b)$$

$$\tau_f = 0 \quad \text{for } E > E_u \quad (20c)$$

Thus all the "inefficient" photons are not transmitted and a fraction, τ_g of the efficient photons are transmitted. The ideal filter results if $\tau_g = 1$. For τ_f given by equation (20) the total transmission of the filter is the following.

$$\bar{\tau}_f \equiv \frac{P_E^0}{P_{RAD}} = \tau_g \frac{\int_{E_l}^{E_u} \epsilon^0 e_b dE}{\bar{\epsilon}^0 \sigma T_E^4} \quad (21)$$

Where ϵ^0 is the spectral hemispherical emissivity of the thermal emitter, $\bar{\epsilon}^0$ is the total hemispherical emissivity of the emitter and T_E is the temperature of the thermal emitter.

By using the hemispherical emissivity in equation (21) to calculate P_E we are assuming all radiation leaving the emitter reaches the PV array. Comparing equations (1) and (21) it can be seen that $\bar{\tau}_f$ for the filter TPV system is equivalent to η_E for the selective emitter TPV system.

Define the emissivity in the "useful" energy band $E_l \leq E \leq E_u$ similar to the selective emitter case (eq. (4b)). Therefore,

$$\epsilon_g^0 = \frac{\int_{E_l}^{E_u} \epsilon^0 e_b dE}{\int_{E_l}^{E_u} e_b dE} \quad (22)$$

and equation (21) becomes the following,

$$\bar{\tau}_f = \frac{15}{\pi^4} \left[\frac{\epsilon_g^0}{\bar{\epsilon}^0} \right] \tau_g \text{Exp}(-x_l) [F(x_l) - F(x_u) \text{Exp}(-z_u)] \quad (23)$$

where it has been assumed that $\text{Exp}\left[\frac{E}{kT_E^0}\right] - 1 \approx \text{Exp}\left[\frac{E}{kT_E^0}\right]$ in the black body emissive power, e_b (eq. (5)) and x_l , x_u , z , u , and F are given by equations (9c) to (9g). If the emitter is a perfect black body $\epsilon_g^0 = \bar{\epsilon}^0 = 1$. For a nonblack body emitter $\bar{\epsilon}^0 < 1$ and is a function of T_E . Therefore, $\epsilon_g^0/\bar{\epsilon}^0 < 1$ or $\epsilon_g^0/\bar{\epsilon}^0 > 1$ depending on T_E^0 . For unpolished tungsten, which is a good candidate for an emitter material, $\bar{\epsilon}^0 \approx 0.6$ for $1100 \leq T_E^0 \leq 2600$ K (ref. 16). Polished tungsten has a much lower emissivity. Also, for the photon energy range $0.5 \leq E_g \leq 1.3$ eV ($2.5 \geq \lambda \geq 1$ μm) of interest for TPV systems the spectral emissivity of unpolished tungsten is less than 0.5 (ref. 15). Therefore, $\bar{\epsilon}^0 < 0.6$ and for $\bar{\epsilon}^0 \approx 0.6$ the ratio, $\epsilon_g^0/\bar{\epsilon}^0 < 1$. However, in order to make τ_f as large

as possible for comparing the filter TPV and selective emitter TPV systems assume $\epsilon_g^0/\bar{\epsilon}^0 = 1$ in equation (23).

To compare the two TPV systems η_E and η_f were calculated as functions of E_g/kT_E . When $\eta_f > \eta_E$ the filter TPV system will be more efficient than the selective emitter system. In figure 9 results are shown for $\epsilon_U/\epsilon_g = \epsilon_l/\epsilon_g = \Delta E_g/E_g = 0.1$ for the selective emitter system. This is a conservative representation of the four rare earths in this study. For the filter TPV system in figure 9 the optimistic assumption of a black body emitter ($\bar{\epsilon}^0 = \bar{\alpha}_E^0 = \epsilon_g^0 = 1$) was made. Also, an optimistic filter transmission in the emission band, $\tau_g = 0.95$ was assumed. Results for three filter absorptivities, $\bar{\alpha}_f = 0.01, 0.05, 0.1$ are shown in figure 9. As can be seen, for $\bar{\alpha}_f = 0.01$ the filter system is significantly better than the selective emitter system. For $\bar{\alpha}_f = 0.05$ the filter system is still more efficient than the selective emitter system. However, for $\bar{\alpha}_f = 0.1$ the selective emitter system becomes more efficient than the filter system.

Even with a perfect black body emitter the filter TPV system efficiency will be less than the selective emitter system efficiency for a filter loss of 10 percent or more ($\bar{\alpha}_f \geq 0.1$). For a nonblack body emitter the superiority of the selective emitter system is even greater. This is illustrated in figure 10 where η_E and η_f are compared for three values of the filter system emitter emissivity (and absorptivity), $\bar{\alpha}_E^0 = \bar{\epsilon}^0 = 0.6, 0.7, 0.8, 0.9$, and $\epsilon_g^0/\bar{\epsilon}^0 = 1$.

The selective emitter conditions are the same as figure 9 and optimistic values for the filter performance were chosen ($\bar{\alpha}_f = 0.01, \tau_g = 0.95$). As can be seen, even for $\bar{\alpha}_E^0 = \bar{\epsilon}^0 = 0.9$ the selective emitter system has a larger efficiency.

Based on the results shown in figures 9 and 10, it appears that, $\tau_g \geq 0.95$, and $\bar{\alpha}_f < 0.01$ and $\bar{\epsilon}^0 = \bar{\alpha}_E^0 > 0.9$ are required for the filter TPV system to have greater efficiency than the selective emitter TPV system.

CONCLUSION

The development of new high efficiency rare earth oxide emitters has caused renewed interest in TPV energy conversion. Theoretical emitter efficiency calculations yield two important conclusions. First of all, the emission band of the selective emitter must be centered at relatively low energy ($E_g \leq 0.52$ eV) to obtain maximum efficiency at moderate emitter temperatures ($T_E \leq 1500$ K). Thus low bandgap PV materials are required to obtain an efficient TPV system. Secondly to obtain high emitter efficiency at moderate temperatures, it is more important to reduce the off band radiation that lies below the emission band than the radiation that lies above the emission band. Theoretical efficiency calculations for Yb, Er, Ho, and Nd were made. Yb and Er are of interest because their emission bands are well matched to the bandgaps of silicon and germanium respectively. The experimental efficiency data of references 5 and 6 for Yb comes close to the theoretical efficiency. However, in order to approach the maximum efficiency for Yb, emitter temperatures approaching 3000 K are required. Erbium has a narrow emission band ($\Delta E_g/E_g = 0.05$) which limits its efficiency. However, near maximum efficiency can be reached for $T_E \approx 2000$ K. Holmium is an excellent candidate for a

selective emitter since high efficiency is possible for moderate temperatures ($\eta_E = 0.72$ for $T_E = 1500$ K). Neodymium is a low temperature candidate since its maximum efficiency occurs at 1450 K. However, Nd has larger off emission band emissivities so that its maximum efficiency ($[\eta_E]_{MAX} = 0.55$) is lower than Ho maximum efficiency. Both Ho and Nd require new PV materials if they are to be used in a TPV system. However, there are good candidate PV materials that can be used with Ho and Nd.

Finally, a comparison was made between a rare earth selective emitter TPV system and a TPV system that uses a thermal emitter plus a band pass filter that makes the thermal emitter perform like a selective emitter. In order for the filter TPV system to have a greater efficiency than the selective emitter system nearly impossible filter and thermal emitter properties are required. The filter absorption must be 1 percent or less, filter transmission must be zero outside the photon energy band of interest and 95 percent or greater within the energy band. Also, the thermal emitter must have an emissivity of 0.9 or greater.

REFERENCES

1. D.C. White, and R.J. Schwartz; "P-I-N Structures for Controlled Spectrum Photovoltaic Converters," AGARD Colloquium, Cannes, France, 1964, New York: Gordon Breach Science, 1967, pp. 897-922.
2. G.E. Guazzoni, "High-Temperature Spectral Emittance of Oxides of Erbium, Samarium, Neodymium, and Ytterbium," Appl. Spectr., vol. 26, pp. 60-65, 1972.
3. G.H. Dieke, Spectra and Energy Levels of Rare Earth Ions in Crystals, New York: Interscience, 1968.
4. R.E. Nelson, International Power Sources Symposium, 32nd; Proceedings. Pennington, NJ: Electromechanical Society, 1986.
5. C.R. Parent and R.E. Nelson; "Thermophotovoltaic Energy Conversion with a Novel Rare Earth Oxide Emitter," in 1986 Intersociety Energy Conversion Engineering Conference, San Diego, CA, Aug. 25-29, 1986; Proceedings, Paper 869299.
6. R.E. Nelson, Unpublished Data, TPV Energy Systems, Waltham, MA.
7. E.S. Vera, J.J. Loferski, M. Spitzer and J. Severns; "Operating Characteristics of Thin Thermophotovoltaic Cells with Minority Carrier Mirrors and Optical Mirrors Using Selective Radiators of Erbium and Ytterbium Oxides," in Photovoltaic Solar Energy Conference; Proceedings of the Fourth International Conference, Stressa, Italy, May 10-14, 1982, pp. 659-665.
8. S.M. Sze, Physics of Semiconductors, 2nd ed. New York: Wiley, 1981, p. 15.
9. B. Beaumont, G. Nataf, P. Carabédian, J.C. Guillaume, and C. Vèrié; "Ga_{0.47}In_{0.53}As Photovoltaic Booster Cells for Tandem Solar Energy Conversion," Sol. Cells, vol, 26, no. 4, pp. 313-321, 1989.

10. G.H. Olsen, A.M. Joshi, V.S. Ban, K.M. Woodruff, G.A. Gasparian, M.J. Lange, G.C. Erickson, E. Mykietyn, and S.R. Forrest; "Multiplexed 256-Element InGaAs Detector Arrays for 0.87-1.7 μm Room Temperature Operation," in Proceedings of SPIE, vol. 972, pp. 279-288, 1988.
11. R.M. Swanson, "Proposed Thermophotovoltaic Solar-Energy Conversion System," Proc. IEEE, vol. 67, no. 3, pp. 446-447, 1979.
12. R.L. Bell, "Concentration Ratio and Efficiency in Thermophotovoltaics," Sol. Energy, vol. 23, no. 3, pp. 203-210, 1979.
13. F. Demichelis, and E. Minetti-Mezetti; "A Solar Thermophotovoltaic Converter," Sol. Cells, vol. 1, no. 4, pp. 393-403, 1980.
14. J.L. Duomarco, and R. Kaplow; "Theroetical Estimation of the Efficiency of Thermophotovoltaic Systems Using High-Intensity Silicon Solar-Cells," Sol. Energy, vol. 32, no. 1, pp. 33-40, 1984.
15. W. Spirkel, and H. Ries; "Solar Thermophotovoltaic - An Assessment," J. Appl. Phys., vol 57, pp. 4409-4414, 1985.
16. Y.S. Touloukian and D.P. DeWitt, Thermophysical Properties of Matter, vol. 7. Plenum Press, New York: 1970.

TABLE I. - RARE EARTH OXIDE EMISSION BAND DATA USED IN ANALYSIS

Element	Transition	Photon energy at center of emission band, eV	Photon wavelength at center of emission band, μm	Dimensionless bandwidth, $\Delta E_g/E_g$
Ytterbium, Yb	$^2F_{5/2} \rightarrow ^2F_{7/2}$	1.29	0.955	0.18
Erbium, Er	$^4I_{13/2} \rightarrow ^4I_{15/2}$.827	1.5	.05
Holmium, Ho	$^5I_7 \rightarrow ^5I_8$.62	2.0	.10
Neodymium, Nd	$^4I_{13/2} \rightarrow ^4I_{9/2}$.496	2.5	.15

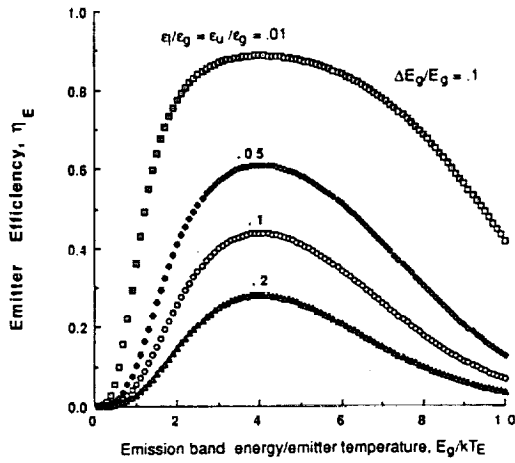

Fig.1 Dependence of Emitter Efficiency on Equal Above and Below Emission Band Emissivities, $\epsilon_l = \epsilon_u$

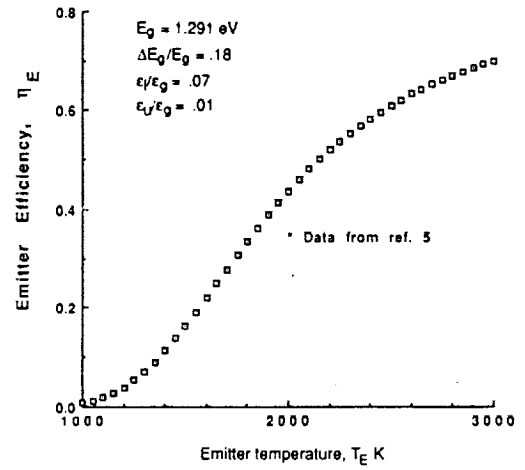

Fig. 4 Ytterbium Emitter Efficiency

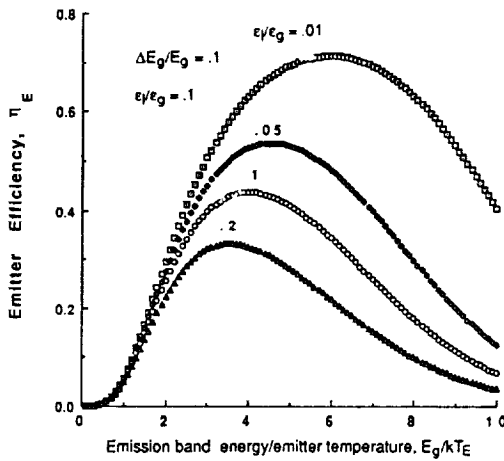

Fig. 2 Dependence of Emitter Efficiency on Below Emission Band Emissivity, ϵ_l

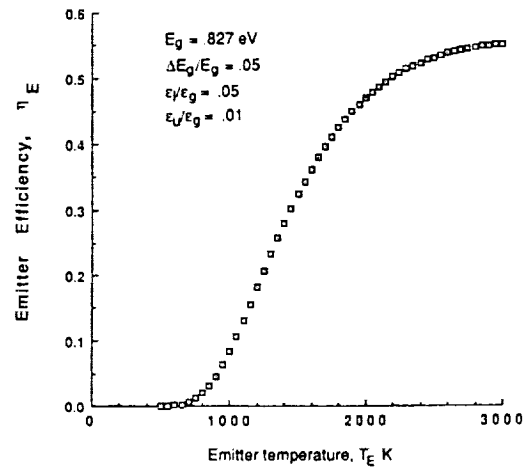

Fig. 5 Erbium Emitter Efficiency

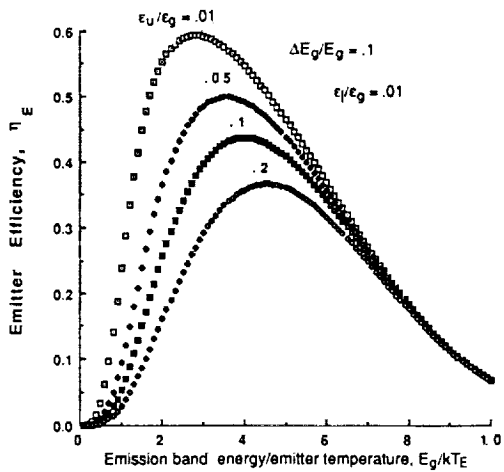

Fig. 3 Dependence of Emitter Efficiency on Above Band Emissivity, ϵ_u

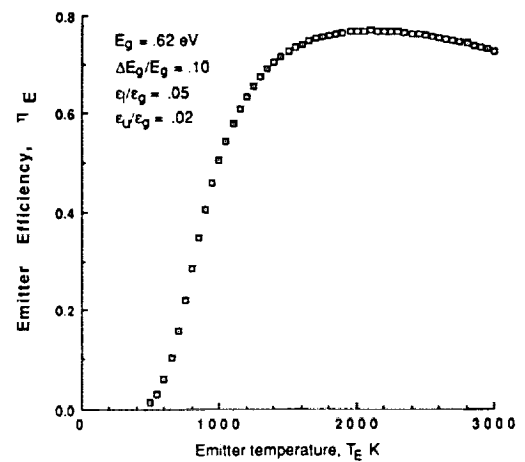

Fig. 6 Holmium Emitter Efficiency

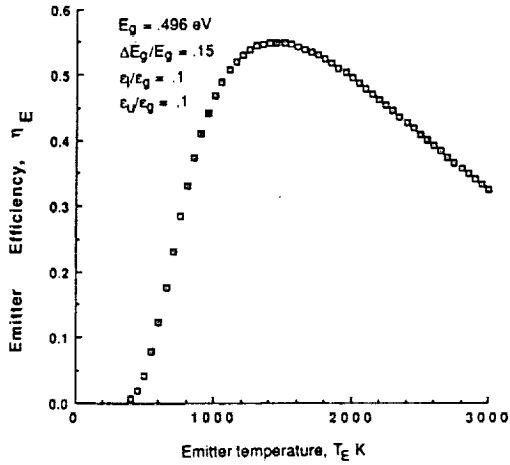

Fig. 7 Neodymium Emitter Efficiency

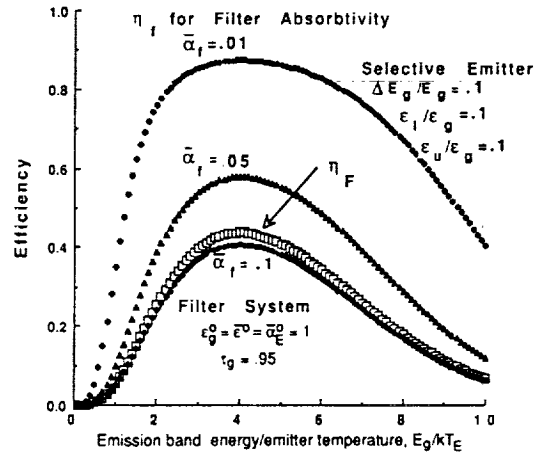

Fig.9 Comparison of Filter TPV System with Black Body Emitter and Selective Emitter TPV System for Variable Filter Absorptivity

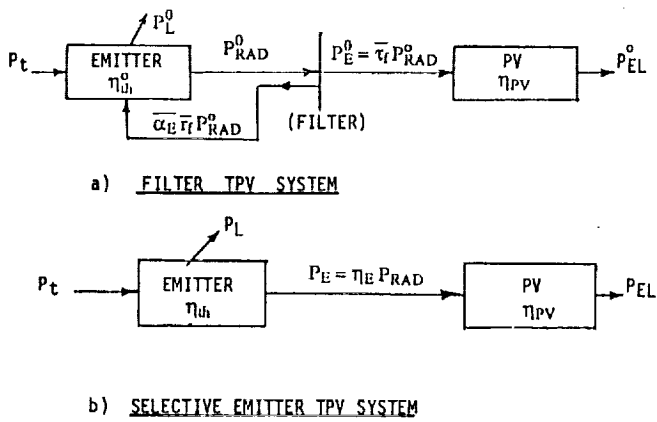

Fig. 8. COMPARISON OF FILTER TPV AND SELECTIVE EMITTER TPV

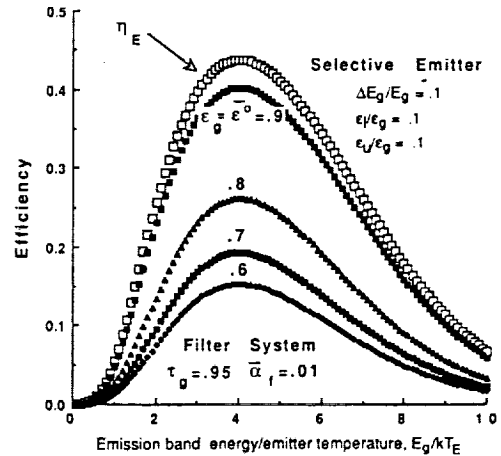

Fig.10 Comparison of Filter TPV System with Thermal Emitter and Selective Emitter System for Variable Thermal Emitter Emissivity

1. Report No. NASA TM-103290		2. Government Accession No.		3. Recipient's Catalog No.	
4. Title and Subtitle Reappraisal of Solid Selective Emitters				5. Report Date	
				6. Performing Organization Code	
7. Author(s) Donald L. Chubb				8. Performing Organization Report No. E-5750	
				10. Work Unit No. 506-41-11	
9. Performing Organization Name and Address National Aeronautics and Space Administration Lewis Research Center Cleveland, Ohio 44135-3191				11. Contract or Grant No.	
				13. Type of Report and Period Covered Technical Memorandum	
12. Sponsoring Agency Name and Address National Aeronautics and Space Administration Washington, D.C. 20546-0001				14. Sponsoring Agency Code	
15. Supplementary Notes Prepared for the 21st Photovoltaic Specialists Conference sponsored by the Institute of Electrical and Electronics Engineers, Kissimmee, Florida, May 21-25, 1990.					
16. Abstract New rare earth oxide emitters show greater efficiency than previous selective emitters. As a result, based on a simple model the efficiency of these new emitters was calculated. Results indicate that the emission band of the selective emitter must be at relatively low energy ($\leq .52$ eV) to obtain maximum efficiency at moderate emitter temperatures (≤ 1500 K). Thus low bandgap energy PV materials are required to obtain an efficient thermophotovoltaic (TPV) system. Of the 4 specific rare earths (Nd, Ho, Er, Yb) studied Ho has the largest efficiency at moderate temperatures (72 percent at 1500 K). A comparison was made between a selective emitter TPV system and a TPV system that uses a thermal emitter plus a band pass filter to make the thermal emitter behave like a selective emitter. Results of the comparison indicate that only for very optimistic filter and thermal emitter properties will the filter TPV system have a greater efficiency than the selective emitter system.					
17. Key Words (Suggested by Author(s)) Selective emitters Rare earth Thermal photovoltaics				18. Distribution Statement Unclassified - Unlimited Subject Category 20	
19. Security Classif. (of this report) Unclassified		20. Security Classif. (of this page) Unclassified		21. No. of pages 16	22. Price* A03

