

NASA Case No. LEW-15,027-2

PRINT FIG. 2

NOTICE

The invention disclosed in this document resulted from research in aeronautical and space activities performed under programs of the National Aeronautics and Space Administration. The invention is owned by NASA and is, therefore, available for licensing in accordance with the NASA Patent Licensing Regulation (14 Code of Federal Regulations 1245.2).

To encourage commercial utilization of NASA-owned inventions, it is NASA policy to grant licenses to commercial concerns. Although NASA encourages nonexclusive licensing to promote competition and achieve the widest possible utilization, NASA will consider the granting of a limited exclusive license, pursuant to the NASA Patent Licensing Regulations, when such a license will provide the necessary incentive to the licensee to achieve early practical application of the invention.

Address inquiries and all applications for license for this invention to NASA Patent Counsel, Lewis Research Center, Mail Stop LE-LAW, 21000 Brookpark Road, Cleveland, OH 44135. Approved NASA forms for application for nonexclusive or exclusive license are available from the above address.

Serial No.: 07/824,858

Filed Date: December 24, 1991

LeRC

(NASA-Case-LEW-15027-2) VINYL CAPPED
ADDITION POLYIMIDES Patent Application
(NASA) 15 p CSCL 11C

N92-24053

Unclas

63/27 0087671

AWARDS ABSTRACT

VINYL CAPPED ADDITION POLYIMIDES

5 Polyimide resins are generally useful where high strength and temperature capabilities are required at temperatures up to about 700°F. Polyimide resins have been particularly useful in applications such as jet engine compressor components, for example, blades, vanes, air seals, air splitters and engine casing parts.

10 Aromatic vinyl capped addition polyimides are obtained by reacting a diamine, an ester of tetracarboxylic acid, and an aromatic vinyl compound. Low void materials with improved oxidative stability when exposed to 700°F air may be fabricated as fiber reinforced high molecular weight capped polyimide composites.

15 The aromatic vinyl capped polyimides are provided with a more aromatic nature and are more thermally stable than highly aliphatic, norbornenyl-type end-capped polyimides employed in PMR resins. The substitution of aromatic vinyl end-caps for norbornenyl end-caps in addition polyimides results in polymers with improved oxidative stability.

INVENTORS: Raymond D. Vannucci
Diane C. Malarik
Peter Delvigs
EMPLOYER: NASA Lewis Research Center
EVALUATOR: Salvatore J. Grisaffe
SERIAL NO.: 07/824,858
FILING DATE: December 24, 1992

VINYL CAPPED ADDITION POLYIMIDES

ORIGIN OF THE INVENTION

The invention described herein was made by employees of the U.S. government and may be manufactured and used by or for the government without the payment of any royalties thereon or therefor.

BACKGROUND OF THE INVENTION

1. Field of the Invention

The present invention is directed to polyimide resins having improved thermo-oxidative stability. The polyimide resins are generally useful in applications where high strength and temperature capabilities are required at temperatures up to about 700°F. Polyimide resins have been particularly useful in applications such as jet engine compressor components, for example, blades, vanes, air seals, air splitters, and engine casing parts.

2. Description of the Prior Art

Polyimides having excellent high temperature oxidative and thermal stability and outstanding mechanical properties have been described, for example, in U.S. Patent No. 3,745,149 to Serafini et al. These polyimides, also referred to as PMR polyimides, are the most widely used addition-type polyimide matrix resins for aerospace applications requiring use temperatures of 450°F and higher. There are two versions of PMR polyimide resins which are referred to as first and second generation PMR's. These addition-type polyimides comprise monomer components of diester, diamine and an end-capper in a stoichiometric ratio of n moles of diester, $n+1$ moles of diamine and 2 moles of the end-capper. The first generation PMR polyimides comprise the monomethyl ester of 5-norbornene-2,3-dicarboxylic acid, the dimethyl ester of 3,3',4,4'-benzophenonetetracarboxylic acid and 4,4'-methylenedianiline. The monomers used for second generation PMR polyimides are the monomethyl ester of 5-norbornene-2,3-dicarboxylic acid, the dimethyl ester of 4,4'-(hexafluoroisopropylidene)-bis(phthalic acid), and p-phenylenediamine. These polyimides both employ the

- 2 -

monomethyl ester of 5-norbornene-2,3 dicarboxylic acid as the end-capper, but differ in the diester and diamine used to prepare the resin.

5 Commercially available first generation PMR polyimides employ an n value of 2.087. Higher molecular weight resin formulations become increasingly more difficult to process because of the increasing melt viscosity associated with increasing n values. The same is true for the second generation PMR resins. To improve the thermo-oxidative stability of PMR polyimides, higher molecular weight formulations must be employed. Higher molecular weight formulations of second generation PMR resins have been used and provide improved thermo-oxidative stability when used in a laminate preparation. See Vannucci et al, 10 700°F Properties of Autoclaved PMR-II composites, Proc. of 20th Int. SAMPE Tech. Conf., Sept. 1988. While higher molecular weight PMR resins provide some degree of improvement in thermo-oxidative stability, it is desirable to provide further improvements.

20 One type of PMR polyimide is disclosed in U.S. Patent No. 4,560,742 to Pater. The disclosed polyimides are derived from a dialkyl or tetraalkyl ester of an aromatic tetracarboxylic acid, an aromatic diamine, an end-cap of a monoalkyl or dialkyl ester of a dicarboxylic acid, and an N-arylnadimide such as N-phenylnadimide. 25 Graphite composites may be formed from the polyimide resins having a life of 1700 hours at 600°F in air.

Low curing temperature PMR polyimides are disclosed by Serafini et al, "Lower-Curing-Temperature PMR Polyimides", NASA Technical Memorandum 81705, Thirty-sixth 30 Annual Conference of the Reinforced Plastics Composites Institute of the Society of the Plastics Industry, Inc., 1981. An endcap of m-aminostyrene was used for reducing the cure temperature requirements of PMR polyimides. The use temperature of these composites, however, is limited 35 to about 260°C (500°F).

A number of other materials are known which are formed having end-caps. For example, U.S. Patents Nos.

- 3 -

3,748,310 and 3,748,311 to Burns et al disclose chemically stable alicyclic end-capped aromatic prepolymers. The prepolymers of the '310 patent are obtained by reacting stoichiometric amounts of tetraacids or derivatives with an aromatic tetraamine and an end-capping substituted alicyclic endo component. The prepolymers of the '311 patent are made by reacting proper stoichiometric amounts of an aromatic dicarboxylic derivative with a polyfunctional substituted aromatic amine, such as tetraamine, dithioldiamine, or a dihydroxydiamine, and an end-capping alicyclic endo compound.

U.S. Patent No. 4,739,030 to Lubowitz et al discloses difunctional end-capped monomers. The monomers are imidophenol monomers which include two unsaturated functionalities capable of cross-linking upon thermal or chemical activation.

U.S. Patent No. 3,803,081 to Lubowitz discloses a polymerizate consisting essentially of polyamide-acid prepolymers and polyimide prepolymers. The polymerizates containing the prepolymers are obtained by coreacting approximately stoichiometric amounts of at least one polyfunctional amine, polyfunctional anhydrides, and a particular monoanhydride. The polyamide-acids and polyimide prepolymers are converted pyrolytically to high-molecular weight polyimide resins.

U.S. Patent No. 3,919,172 to Rhein et al discloses polyfunctional anhydrides which provide effective chain extension of hydroxy-terminated prepolymers. The polyfunctional anhydrides include tetrahydrofuran tetracarboxylic dianhydride, pyromellitic dianhydride and benzophenone tetracarboxylic dianhydride. The prepolymers include poly(ethylene oxides) and poly(butadienes).

While the above patents are directed to resins having certain desirable properties, there continues to be a need for polyimide resins having improved properties, and in particular, having improved thermo-oxidative stability.

- 4 -

SUMMARY OF THE INVENTION

The present invention is directed to polyimides having improved thermo-oxidative stability. In particular, the present invention is directed to aromatic vinyl compound (preferably aminostyrene) capped polyimides. The capped polyimides may be obtained by reacting a diamine, an ester of tetracarboxylic acid, and an aromatic vinyl compound. Low void materials with improved oxidative stability when exposed to 700°F air may be fabricated as fiber reinforced high molecular weight capped polyimide composites.

BRIEF DESCRIPTION OF THE DRAWINGS

A more complete understanding of the present invention can be obtained by reference to the accompanying drawings, wherein:

Fig. 1 is a schematic illustration of the vacuum bag system used for autoclave fabrication of fiber reinforced composites of the invention; and

Fig. 2 is a plot illustrating process procedures of temperature against time for autoclave curing of fiber reinforced polyimide composites of the invention.

DETAILED DESCRIPTION OF PREFERRED EMBODIMENTS

The present invention provides aromatic vinyl compound capped polyimides having improved thermo-oxidative stability. Aromatic vinyl compounds such as aminostyrene, having a more aromatic nature, provide a more thermally stable reactive end-cap than the less stable, highly aliphatic, norbornenyl-type end-cap employed in PMR resins. Thus, the substitution of an aromatic vinyl end-cap for norbornenyl end-caps in addition polyimides results in polymers with improved oxidative stability. A problem with aminostyrene reactants is the low temperature at which the styrene reacts prior to molecular weight build-up. This reactivity may cause problems during fabrication of fiber reinforced laminates. The present invention also provides a process for obtaining polyimides with enhanced thermo-oxidative stability.

- 5 -

The capped polyimides of the invention may be obtained by reacting three monomers to obtain a prepolymer. The prepolymer may then be cross-linked to obtain a cross-linked macropolymer. In particular, the monomers which may be used to obtain the capped polyimides include a diamine, an ester of tetracarboxylic acid, and an aromatic vinyl compound in a molar ratio of $n:(n+1):2$ when the aromatic vinyl compound contains nitrogen, and in a ratio of $(n+1):n:2$ when the aromatic vinyl compound does not contain nitrogen, where n is preferably a value between about 5 and about 20.

Three types of monomers employed in the present invention are represented by the following formulas:

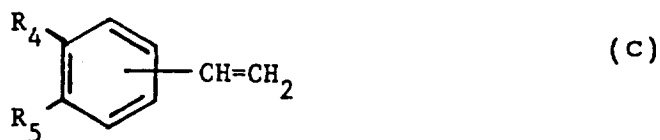
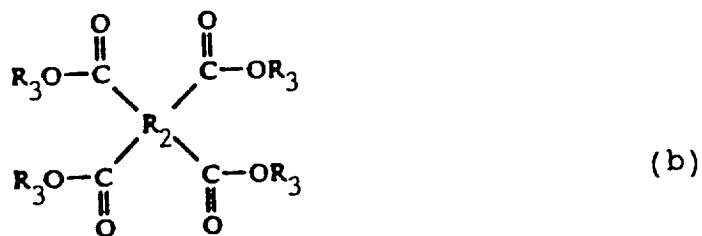

where R_1 is a divalent aryl radical such as phenyl, R_2 is a tetravalent aryl radical, R_3 is a lower alkyl radical, for example methyl, ethyl, n-propyl, isopropyl, and the like, preferably methyl, or hydrogen, and at least two R_3 are alkyl, R_4 is an $-\text{NH}_2$, R_5 is hydrogen, or, alternatively, R_4 and R_5 are $-\text{COOR}_3$ groups where R_3 is as defined above and at least one R_3 is alkyl.

- 6 -

Diamines defined in (a) above include, for example, benzidine, 4,4'-methylenedianiline, 4,4'-oxydianiline, 4,4'-sulfonyldianiline, 4,4'-thiodianiline, p-phenylenediamine, and m-phenylenediamine.

5 Esters of the tetracarboxylic acid defined in (b) above may be readily prepared according to known methods from the corresponding dianhydrides of the formula:

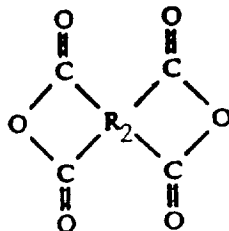

wherein R_2 is as defined above. Examples of dianhydrides which may be employed include pyromellitic dianhydride, 3,3',4,4'-benzophenonetetracarboxylic dianhydride, 4,4'-(hexafluoroisopropylidene)-bis(phthalic anhydride), bis(3,4-dicarboxyphenyl) sulfone dianhydride, bis(3,4-dicarboxyphenyl) ester dianhydride, 1,2,5,6-naphthalene tetracarboxylic dianhydride, 2,3,6,7 naphthalene tetracarboxylic dianhydride, 2,2',3,3'-diphenyl tetracarboxylic dianhydride, and 1,4,5,8-naphthalene tetracarboxylic dianhydride.

25 End-capping groups defined in (c) above can be readily prepared according to known methods. Examples of end-capping groups include p-aminostyrene and m-aminostyrene.

30 An organic solvent may be employed to dissolve the above three monomers. The solvent must not react with the ester or amine during the processing conditions. Representative examples of suitable solvents include aliphatic alcohols (preferably methanol or ethanol), aliphatic alcohol ethers, and aprotic solvents such as N,N-dimethyl formamide. Mixtures of two or more solvents may also be employed. The solutions of monomers are prepared with a solids content of 30 to 70% by weight.

35 When the monomer solutions are heated at temperatures of about 120°F to about 300°F (50°C to 150°C), the

- 7 -

monomers react within about 60 to about 75 minutes to form end-capped prepolymers. The molecular weights of these prepolymers may range, for example, from about 3000 when $n=5$ to about 11,000 when $n=20$. Preferably, the reaction is carried out under vacuum.

If an end-capping monomer is selected where R_4 is an $-NH_2$ group and R_5 is hydrogen, the structure of the prepolymer may be represented by the formula:

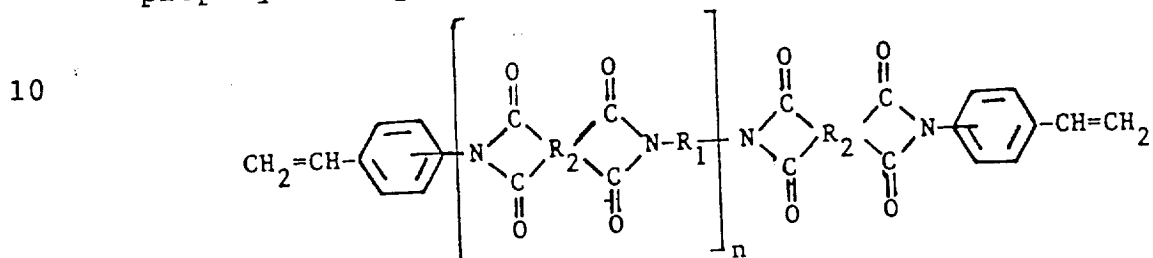

15 wherein n is about 5 to about 20, and R_1 and R_2 are as defined above. The molecular weight of such end-capped prepolymers may be adjusted to desired values by varying the value of the number n between 5 and 20, provided that a molar ratio of $n:(n+1):2$ is maintained for the relationship of $a:b:c$.

20 If an end-capping monomer is selected where R_4 and R_5 are $-COOR_3$ groups, the structure of the prepolymer may be represented by the formula:

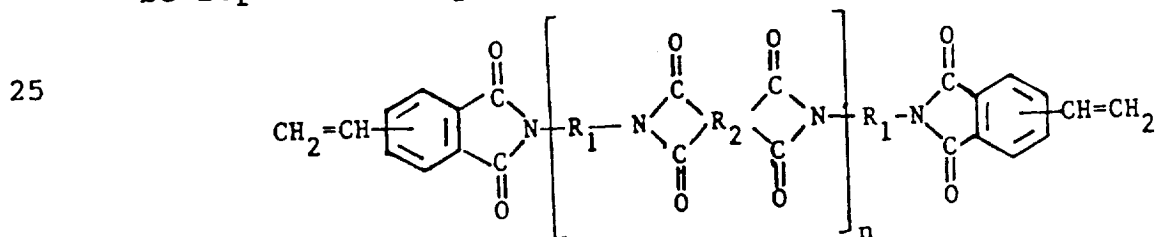

30 wherein n , R_1 and R_2 are as defined above. Since R_4 and R_5 do not contain a nitrogen group, a molar ratio of $(n+1):n:2$ must be maintained for the relationship of $a:b:c$. Further, R_3 of $-COOR_3$ is cleaved as a condensation byproduct in the reaction forming the aminostyrene end-cap, and may be removed, if desired, after the prepolymerization.

35

- 8 -

5 The above prepolymers may be cured to form cross-linked macropolymers. Crosslinking is obtained by heating the prepolymers at elevated temperatures, for example 700°F (370°C) or higher. The average molecular weight of these macropolymers will be based on the molecular weights of the prepolymers and the degree of crosslinking. For example, a macropolymer formed from prepolymers with n values between about 5 and about 20 would have an average molecular weight between crosslinks of about 3000 to about 11,000.

10 The capped polyimides of the present invention may be used, for example, to fabricate fiber reinforced composites from prepreg materials using autoclave fabrication procedures. For example, graphite fiber may be impregnated with a solution containing the monomers of the present invention and cured. Fig. 1 shows a vacuum bag system 10 which may be used to cure the impregnated fibers into laminates using an autoclave. The vacuum bag system 10 generally comprises a Kapton (tm) bagging film 13 secured to a steel plate 14 by a high temperature sealant 19 and a spring steel paper clamp 11. The Kapton (tm) bag is a polyimide film bag available from du Pont. The steel plate 14 having a thermocouple well 15, along with a steel molding frame 16 and a pressure plate 17 hold the impregnated fibers in place. A vacuum port 18 is also provided for maintaining a vacuum within the Kapton (tm) bag during curing. The system is placed into an autoclave where curing takes place under heat and pressure. Sealant 19 is provided within the clamping frame 12.

20 25 30 35 A bleeder layup permits condensation products to be evacuated from the bagged layup. In particular, the bleeder layup comprises a porous Teflon (trademark for polytetrafluoroethylene)/glass 21, two plies of glass bleeder 22, a porous Teflon/glass 23, the prepreg 24, a porous Teflon/glass 25, two plies of glass bleeder 26, and non-porous Teflon/glass 27. The porous teflon glass is glass fabric which is coated with Teflon, and is used as a release ply (also known as a peel ply).

- 9 -

The invention will further be illustrated in the following, non-limiting examples, it being understood that these examples are intended to be illustrative only and that the invention is not intended to be limited to the materials, conditions, process parameters and the like recited therein.

EXAMPLE I

A mixture of 1.1697g of p-aminostyrene, 24.967g of the dimethyl ester of 4,4'(hexafluoroisopropylidene)-bis(phthalic acid), and 4.777g of p-phenylenediamine is dissolved in 32g of methanol at room temperature. The resulting solution (unreacted) contains 50 percent monomers by weight and upon heating at about 300°F (150°C) for about 30 minutes will yield an imidized end-capped prepolymer having a formulated molecular weight of 5290. The value of n is 9.00.

Approximately 38g of graphite fiber are impregnated with the above solution by first winding the graphite fiber onto a mandrel, then applying the solution evenly to the fiber with a brush. The impregnated fiber is then dried at room temperature to reduce the solvent content to 3 to 7 percent by weight. The impregnated fiber is then cut into 3 inch by 8 inch plies and stacked unidirectionally into a 12 ply stack and bagged for final curing as shown in Fig. 1, and is then autoclave cured into laminates according to the schedule shown in Fig. 2. Fig. 2 is a graph of temperature versus time of the process. The process steps are represented as steps A-G in Fig. 2. During steps A-F, the prepreg is held under a 29 inch vacuum within the bag.

In step A, the temperature is increased at a rate of 7°F (about 3.9°C) per minute. In step B, the temperature has reached about 300°F (150°C) and is held steady for 30 minutes. During this time, the solution of monomers is reacting to form prepolymers. After 30 minutes, 25 lbs. per square inch (PSI) pressure is applied to the autoclave chamber. The temperature is again increased at a rate of 7°F (about 3.9°C) per minute in steps C and D.

- 10 -

In step C, 50 PSI pressure is applied to the autoclave chamber when the temperature reaches 350°F (175°C). When the temperature reaches 450°F (230°C), the pressure is increased at step D to 200 PSI. Subsequently, the increase in temperature is reduced to 5°F (about 2.8°C) per minute at step E until 700°F (370°C) is reached. The temperature is held at 700°F (370°C) until step F wherein the heat is discontinued and the prepreg is allowed slowly to cool to 450°F (230°C). At step G, water is applied to cool the prepreg quickly to room temperature.

The resulting polyimide-graphite fiber laminate is essentially void free and exhibits excellent oxidative stability and mechanical properties at temperatures up to 700°F (370°C). The laminate exhibits a glass transition temperature T_g of 780°F (450°C) after a 24 hour postcure in nitrogen at 750°F (400°C).

EXAMPLE 2

A mixture of 0.8098g of p-aminostyrene, 26.1485g of the dimethyl ester of 4,4'-(hexafluoroisopropylidene)-bis(phthalic acid), and 5.73g of p-phenylenediamine is dissolved in 33g of methanol at room temperature. The resulting solution contains 50 percent monomers by weight and upon heating for about 30 minutes at about 300°F (150°C) will yield an imidized end-capped prepolymer having a formulated molecular weight of 7870. The n value is 14.

Approximately 43g of graphite fiber is then impregnated, dried, cut, stacked, and fabricated into a laminate using the procedure outlined in Example 1 above. After postcuring the laminate in nitrogen for 24 hours at 750°F (400°C), the laminate exhibits a T_g of 800°F (425°C). After 1000 hrs exposure to air at 700°F (370°C), the laminate exhibits a weight loss of 9.7%.

While the invention has been described with reference to particular preferred embodiments, the invention is not limited to the specific examples given, and other embodiments and modifications can be made by those

- 11 -

skilled in the art without departing from the spirit and scope of the invention.

12
~~16~~ABSTRACT OF THE DISCLOSURE

Polyimide resins having improved thermo-oxidative stability are provided having aromatic vinyl end-caps. The polyimides are prepared by the reaction of a mixture of monomers comprising (a) a diamine, (b) an ester of tetracarboxylic acid and (c) an aromatic vinyl compound in a molar ratio of a:b:c of $n:(n+1):2$ when the aromatic vinyl compound contains nitrogen and in a ratio of $(n+1):n:2$ when the aromatic vinyl compound does not contain nitrogen, wherein n ranges from about 5 to about 20.

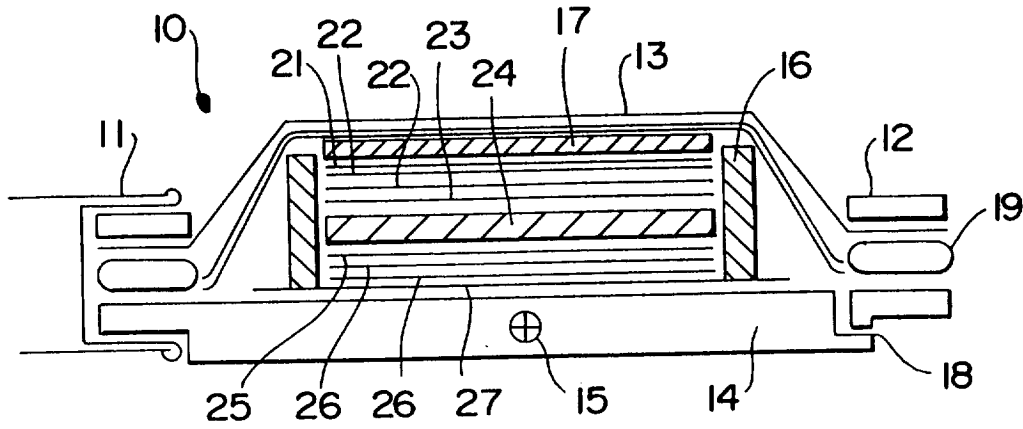

Fig- 1

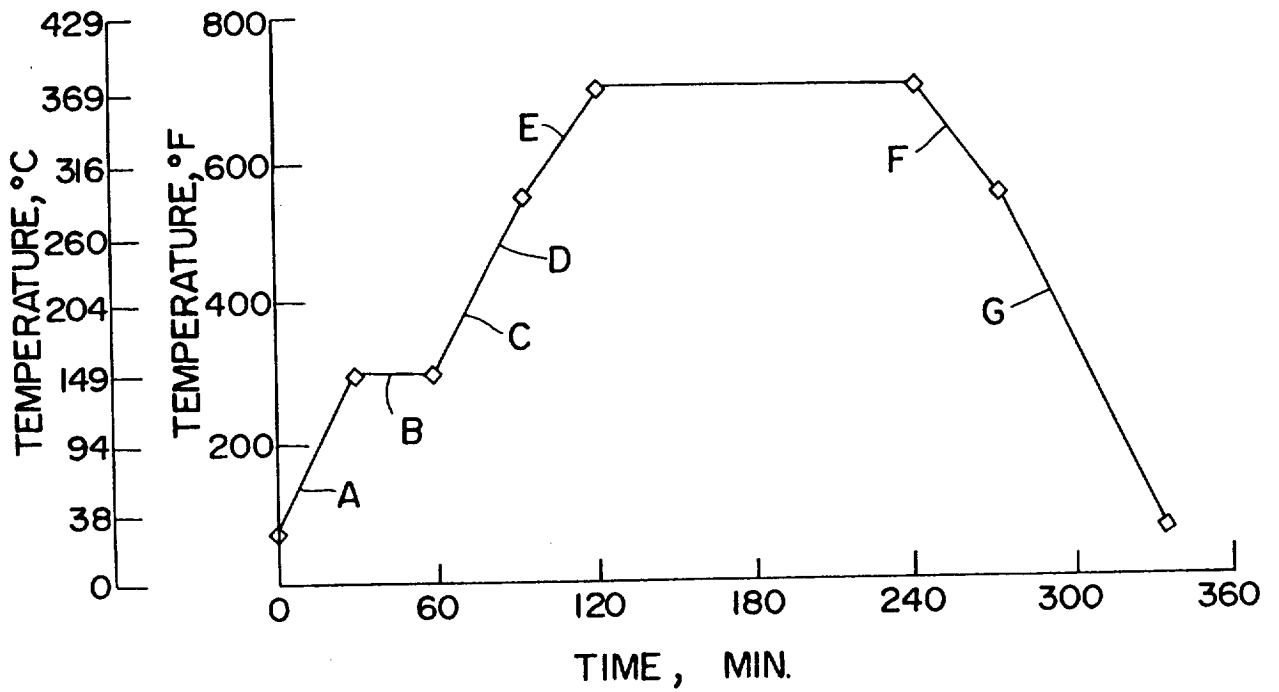

Fig- 2