

PLASMA REACTOR WASTE MANAGEMENT SYSTEMS

N 9 3 - 1 4 0 0 U

Robert O. Ness Jr., John R. Rindt, and Sumitra R. Ness

University of North Dakota
 Energy and Environmental Research Center
 P.O. Box 8213
 University Station
 Grand Forks ND 58202

The University of North Dakota is developing a plasma reactor system for use in closed-loop processing that includes biological, materials, manufacturing, and waste processing. Direct-current, high-frequency, or microwave discharges will be used to produce plasmas for the treatment of materials. The plasma reactors offer several advantages over other systems, including low operating temperatures, low operating pressures, mechanical simplicity, and relatively safe operation. Human fecal material, sunflowers, oats, soybeans, and plastic were oxidized in a batch plasma reactor. Over 98% of the organic material was converted to gaseous products. The solids were then analyzed and a large amount of water and acid-soluble materials were detected. These materials could possibly be used as nutrients for biological systems.

INTRODUCTION

With the launching of the U.S. space station scheduled for the mid-1990s, the likelihood of longer manned missions to the Moon and Mars, and eventual lunar and martian bases, there is a need to develop more comprehensive Environmental Control/Life Support Systems (ECLSS) for use in extraterrestrial activities. Both energy and physical size requirements will dictate the type of ECLSS that will be necessary. Three options are available for extended space living, including (1) systems in which consumables such as oxygen and food are not recycled; (2) totally closed-loop systems with recovery of all consumables; or (3) partially closed systems. The decision regarding the percentage of consumable material that will be recycled will be based primarily on the size and energy requirements of the closed-loop system.

Environmental Control/Life Support Systems, as they exist in current spacecraft, are primarily concerned with subsystems that will provide life support. The raw materials for these systems have been self-contained and, to a large extent, not recycled. For larger systems, such as bases, the processing must be expanded to allow manufacturing, materials handling, and waste treatment. The interaction between the groups (biological, materials, manufacturing, and waste processing) in the closed-loop processing (CLP) resource management system is illustrated by Fig. 1.

The primary objective of this research program at the University of North Dakota is to develop the application of low-temperature plasma reactor systems to closed-loop processing. Closed-loop processes are those that require essentially no raw materials, while producing little or no by-product or waste. Typical applications of these systems are those that will be used in either remote processing or habitation communities such as isolated research communities, both terrestrially and in space.

The systems that will be used on the lunar surface will integrate the biological systems and the material processing systems as closely as possible. A plasma reactor could be a central processing unit that will serve to integrate the operation of waste treatment, biological processing, materials processing, and manufacturing, all of which are being conducted at a remote site where resupply and waste disposal are impossible, or at least difficult and costly.

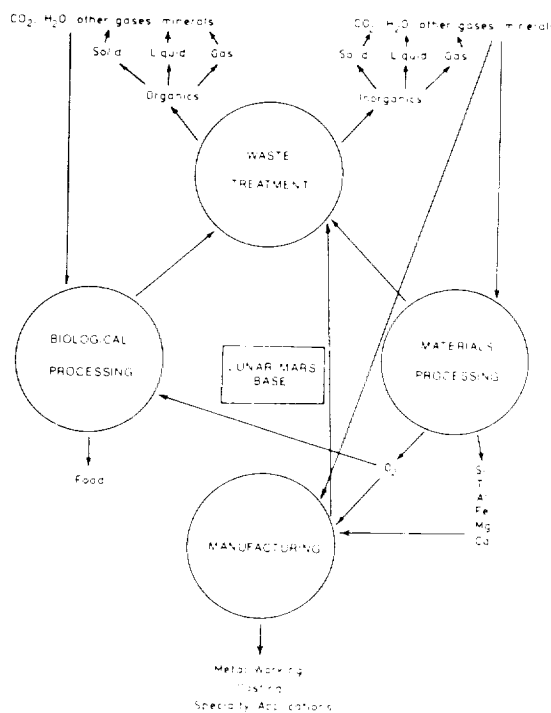

Fig. 1. Closed-loop processing (CLP) resource management system.

The intent of the project and future research is to pass products from one or more of the CLP areas to another in which they will serve as reactants.

BASIC PLASMA GENERATION

A plasma is a highly ionized gas that is electrically neutral and composed of ions, electrons, and neutral particles. The various species are formed when gas molecules acquire energy by intermolecular collisions or from electromagnetic radiation.

There are three basic methods of plasma generation: (1) direct thermal; (2) direct-current discharges; and (3) high-frequency discharges. Figure 2 is a block diagram summarizing the generation types. Each pertinent group will be discussed in the following paragraphs.

Direct-current (dc) and high-frequency discharge both produce ions by one or a combination of two mechanisms: (1) molecular absorption of photons and (2) inelastic electron-molecular collisions. These reactions occur simultaneously, in equilibrium, with the termination reactions that include (1) desorption of a photon, (2) elastic electron-molecular collision, and (3) reaction of the ion with other molecules to form new compounds.

The first initiation mechanism is the molecular absorption of a photon (i.e., the Compton Effect; *Betser*, 1981). The activated molecule may then react with other reactants to form products, such as ions, or it can release the energy by emitting a photon. When the products of these reactions are ions, the electromagnetic field will also provide kinetic energy to the ionic molecules, which in turn will promote the production of additional ions through collisions. Because a particular wavelength activates certain molecules, selective activation of a single species in a multi-component system may be accomplished.

The second method of ionization is by electron-molecular collisions. The kinetic energy of the molecules is then increased by elastic electron-molecular collisions, while inelastic collisions lead to excitation, fragmentation, or ionization of the molecule. In every case, the rate at which the collisions occur per unit gas volume is directly proportional to the bulk gas pressure and the electron density (*Baddour and Timmins*, 1967, pp. 1, 55-59).

Either of the two mechanisms of ion production will promote the production of more ions. The mechanism that predominates will depend on electron temperature, bulk gas temperature, electric field intensity, and the concentration of molecules in the system.

UNIQUE ASPECTS OF PLASMA REACTOR SYSTEMS

Plasma reactors offer several characteristics that make them particularly attractive for use in space applications, where the ability to control the reactor and the moderate operating temperatures and pressures contribute to relatively safe operation. While engineering details change, the overall concept will work in both microgravity and gravity fields. Particular operating characteristics that contribute to the usefulness and safety of plasma reactors are

1. Reaction Specificity. The efficiency of energy transfer from the electromagnetic source to the parent gas molecules depends on the frequency of the radiation. Therefore, when a specific frequency is used, particular molecules will ionize and cause specific reactions to occur. With the ability to vary the frequency, the plasma reactor can be used for a variety of reactions, thus providing a very versatile system.

2. Reaction Rate Control. Because the rate of ion generation is directly related to electromagnetic field strength, the concentration of activated species and, consequently, the reaction rate can be very easily controlled.

3. Rapid Reactor and Reaction Shutdown. The ion production rate in the "ion generator" is inversely proportional to the concentration of reacting molecules in the system. Therefore, a hole or leak into the generator will result in an

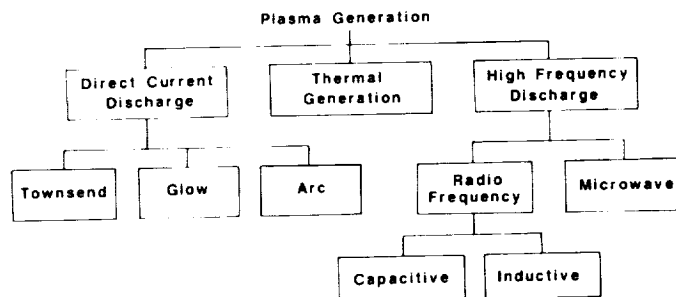

Fig. 2. Plasma generation techniques.

increase in system pressure, and the rate of ion production will decrease markedly. The result would be an orderly shutdown of the reacting system.

OXYGEN PLASMA WASTE CONVERSION (OPWC) RESEARCH

Preliminary testing of the feasibility of using oxygen plasma reactor systems for the removal of organics from waste material has just been completed. Samples of oats, sunflowers, freeze-dried human fecal waste, and a plastic bag (Baggie) were reacted in a batch oxygen plasma system. Table 1 shows an HCN (hydrogen-carbon-nitrogen) analysis of the material remaining in the reactor.

TABLE 1. Data summary for oxygen plasma waste conversion unit.

<i>Freeze-dried Human Fecal Sample</i>	
OPWC % Residue*	31.00
% Carbon	5.205 + 0.145
% Nitrogen	0.885 + 0.045
% Hydrogen	1.380 + 0.06
% Conversion [†]	98.39
% 6M-HCl-Soluble	73.86
% Water-Soluble	32.33
<i>Sunflower Root, Stalk, and Head Sample</i>	
OPWC % Residue	18.52
HCN Analysis of Residue	
% Carbon	5.220 + 0.27
% Nitrogen	0.440 + 0.04
% Hydrogen	1.655 + 0.095
% Conversion	99.03
% Water-Soluble	82.36
<i>Oat Root, Stalk, and Head Sample</i>	
OPWC % Residue	11.15
HCN Analysis of Residue	
% Carbon	1.810 + 0.06
% Nitrogen	0.260 + 0.02
% Hydrogen	1.035 + 0.085
% Conversion	99.8
<i>Soybean Root, Stalk, and Head Sample</i>	
OPWC % Residue	17.45
HCN Analysis of Residue	
% Carbon	3.955 + 0.155
% Nitrogen	0.490 + 0.01
% Hydrogen	0.890 + 0.05
% Conversion	99.31
<i>Plastic (Baggie) Sample</i>	
OPWC % Residue	1.40
% Conversion	98.60

* (Weight of residue out of OPWC)/(weight of sample in OPWC).

[†] Standard HCN on a Control Equipment Corporation unit.

[‡] 1 - (OPWC residue - nonorganic weight)/(OPWC sample weight - nonorganic weight).

Conversion was based on the amount of C left in the sample and was defined as one minus the weight of inorganic free residue divided by the initial inorganic free sample weight. The carbon content was determined by a standard HCN analysis (*Control Equipment Corporation*). The human and plastic samples exhibited the lowest conversions of 98.4% and 98.6%, respectively.

Figure 3 shows the results of a simple residence time experiment completed using human fecal matter. Every two hours the sample was removed from the chamber, cooled in a desiccator, weighed, stirred, and replaced in the reactor. Stirring is necessary to remove any residue formed at the surface. Conversion takes place rapidly up to approximately 80% and then the rate of conversion declines.

Processing of the waste materials included two steps: dehydration and organic conversion. Figure 4 summarizes the composition of a typical fecal sample including the mass of water, material converted, water-soluble residue, and insoluble residue. The figure gives a perspective of the percentage of material the two steps need to handle. The dehydration and organic conversion step removed 99.56% of the material.

The remaining 0.0012 lb of inorganic material was evaluated by water and acid (HCl) solubility tests and X-ray diffraction and fluorescence analysis. Figure 5 shows the results of the solubility tests and Table 2 shows the X-ray fluorescence test results. These materials have amorphous structures since the X-ray diffraction analysis did not yield any crystalline structures above 5% of the total mass.

The X-ray fluorescence results verify the solubility test results. The only component that is readily soluble in water is P₂O₅, which decomposes. The solubility test indicated approximately 32% of the residue to be soluble, while the X-ray fluorescence indicates 31.7% of the material to be P₂O₅. The acid solubility tests also correspond. Magnesium oxide, Al₂O₃, P₂O₅, SO₃, CaO, and Fe₂O₃ are HCl soluble. The solubility test (83%) and the X-ray fluorescence (81.57%) indicate this relationship. Further tests are being done to determine potential end uses for this residue.

These figures show a systematic reduction of 99.56% of the material by dehydration followed by the conversion of an organic material. Since the primary goal of determining if an oxygen plasma system could process a quantity of materials with high conversion was achieved, further analysis of the products and process development is needed to determine electrical requirements, size, residence times for fluidized beds, etc. This information will determine feasibility for space use.

The gas stream from the oxygen plasma conversion unit was not analyzed. It is assumed that most of the gaseous products were CO₂; however, the gas stream from the plastic bag probably contained some chlorine compounds.

TABLE 2. Energy-dispersive X-ray analysis.

	RESULTS			
	Weight %	Std. Dev.	Oxide %	Std. Dev.
O	37.340			
Mg	3.319	0.044	MgO	5.504
Al	0.279	0.008	Al ₂ O ₃	30.527
Si	1.330	0.010	SiO ₂	2.844
P	13.840	0.040	P ₂ O ₅	31.720
S	1.809	0.008	SO ₃	4.516
Ca	27.800	0.100	CaO	38.900
K	6.917	0.049	K ₂ O	7.465
Ti	0.471	0.010	TiO ₂	0.786
Fe	0.279	0.003	Fe ₂ O ₃	0.399
TOTAL	92.660			0.004

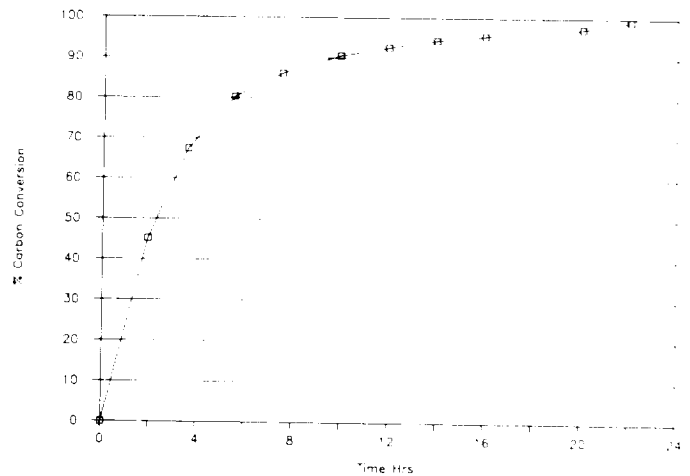

Fig. 3. Percent combustor carbon conversion.

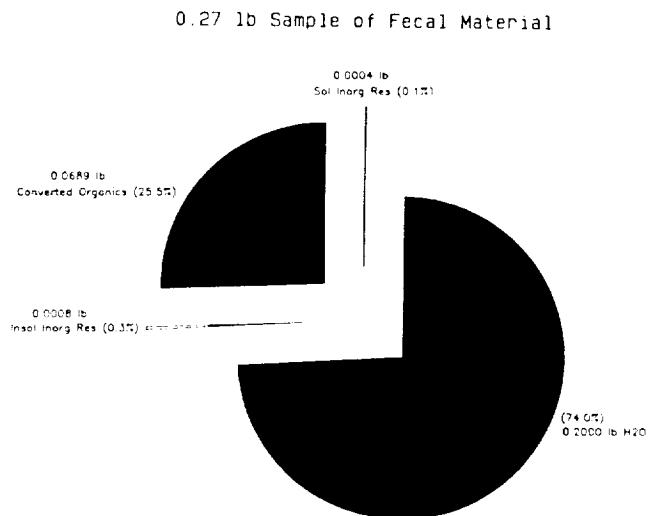

Fig. 4. Fecal sample composition.

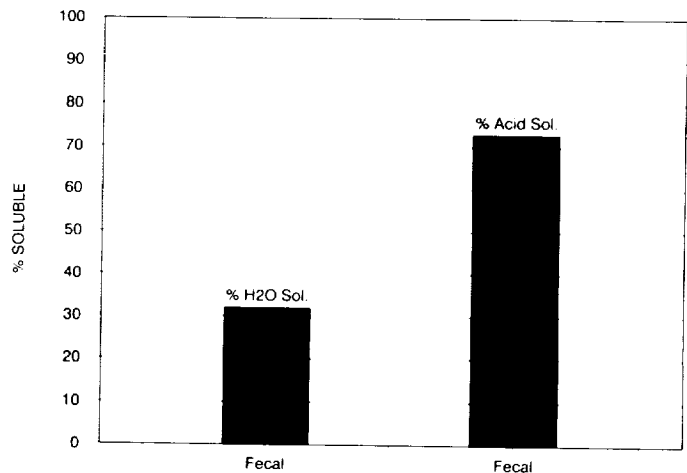

Fig. 5. Combustor residue solubility.

APPLICATIONS OF PLASMA REACTORS TO SPACE ENGINEERING SYSTEMS

A process flow diagram, as shown in Fig. 6, could be used to process waste material from a space station or lunar base. Similar processes have been proposed for terrestrial use, but because of relatively high electrical costs as compared with those of other biological processes, the systems were uneconomical. In space environments, factors other than electrical costs play important roles. This system could be either independent of a biological treatment system or in conjunction with such a system. These types of systems could complement each other because they could provide operating flexibility by changing electrical requirements, size, weight, residence time, and allow high conversion of all organic feed materials.

In terrestrial processes, the following technical and economical factors must be considered: (1) operating conditions (temperature, pressure, pH); (2) operating complexity; (3) equipment maintainability; (4) size; (5) weight; (6) electrical requirements; (7) storage of processing and processed materials; (8) location of raw materials; (9) heat rejection; and (10) safety. Due to the many operating restrictions, the plasma reactor system may have operational advantages over other schemes based on the following: (1) low operating temperatures; (2) low operating pressures; (3) mechanical simplicity; (4) can be used to process solids, liquids, and gases; (5) relatively safe operation; and (6) ease of operation.

A plasma reactor may oxidize or reduce specific components of a process stream while leaving the remainder of the stream unaffected. This, in effect, is a separation and conversion process taking place in one reactor. An example is the conversion of the organic fraction of plants, human waste, and plastics to gases while the inorganic fraction remains unchanged. The inorganic materials can then be directly recycled to other operations.

Plasma reactors are relatively simple to operate because they do not require high temperatures or pressures, or the addition of caustics or acids for chemical reactions. Aqueous solutions can be treated by using a microwave drying step before the oxidation step. Because the system operates under mild conditions, the plasma reactor may offer an alternative to high-temperature processes. The system does not require a heating or cooling period, so reactions can be very tightly controlled; this contributes to the efficiency and safety of the system.

Other applications for the use of plasma reactors could be in the reduction of lunar soils for the production of oxygen. Presently, researchers are thermally heating hydrogen to

approximately 900°C and reducing ilmenite to Fe, TiO₂, and water (Gibson and Knudsen, 1985). The water is then electrolyzed to produce hydrogen and oxygen. Since this system requires the injection of large quantities of heat, which will require the presence of larger radiators on the lunar surface, reduction by a hydrogen plasma atmosphere may be practical. While this presents advantages in reducing process severity, there remain many technical questions that need to be addressed.

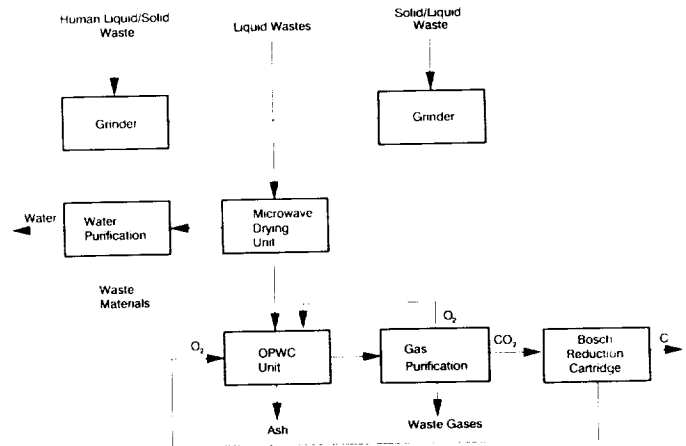

Fig. 6. Waste management process flow diagram.

REFERENCES

- Baddour R. F. and Timmins R. S. (1967) *The Application of Plasmas to Chemical Processing*. Massachusetts Institute of Technology, Cambridge.
- Beiser A. (1981) *Concepts of Modern Physics*, pp. 132-133. McGraw-Hill, New York.
- Control Equipment Corporation (date unknown) *CHN Analysis Scheme*. Available upon request at the UND Energy and Environmental Research Center, Box 8213, University Station, Grand Forks ND 58202 (Phone 701-777-5000).
- Gibson M. A. and Knudsen C. W. (1985) Lunar oxygen production from ilmenite. In *Lunar Bases and Space Activities of the 21st Century* (W. W. Mendell, ed.), pp. 543-558. Lunar and Planetary Institute, Houston.

DISTRIBUTION OF HUMAN WASTE SAMPLES IN RELATION TO SIZING WASTE PROCESSING IN SPACE

N 9 3 - 1 4 0 0 1

Dick Parker

*University of North Dakota
Grand Forks ND 58202*

S. K. Gallagher

*U.S. Department of Agriculture
Agricultural Research Service
Human Nutrition Research Center
Grand Forks ND 58202*

INTRODUCTION

Human waste processing for closed ecological life support systems (CELSS) in space requires that there be an accurate knowledge of the quantity of wastes produced. Because initial CELSS will be handling relatively few individuals, it is important to know the variation that exists in the production of wastes rather than relying upon mean values that could result in undersizing equipment for a specific crew. On the other hand, because of the costs of orbiting equipment, it is important to design the equipment with a minimum of excess capacity because of the weight that extra capacity represents. We were fortunate to have available to us a considerable quantity of information that had been independently gathered on waste production; we examined that information in order to obtain estimates of equipment sizing requirements for handling waste loads from crews of 2 to 20 individuals.

METHODS

Overall, some 25,000 person days of data were available. These data were obtained from 15 metabolic studies conducted at the USDA Human Nutrition Research Center in Grand Forks, North Dakota. The 15 diets for these studies were designed to approximate diets consumed by typical Americans, and were fed in 3-day cycles. Intake was adjusted to maintain weight to within 2% of admission weight. To minimize the variability of composition, fresh fruit or vegetables were not used. Volunteers consumed only what was given to them by the metabolic kitchen. Volunteers were chaperoned at all times to assure nothing was eaten outside the laboratory and that collection of samples was complete.

All collection periods were from 0800 to 0800 (24 hours). Urine was collected in its entirety in large plastic containers that had an acid preservative. If a specimen was inadvertently missed, an estimate of the amount lost was made. Urine volumes were measured to within ± 10 ml. Stool samples were collected in individual collection bags. Toilet tissue was not collected. Collection bags were preweighed within 0.05 g. Sample weights were obtained immediately after collection. Bag weights were

subtracted from total weights to give wet weight. Individual samples were lyophilized using standard freeze drying techniques. A dry weight minus bag weight was then obtained.

Menstrual samples were collected in 24-hour collection bags. Pads, tampons, or pantyliners were used. The weight of 20 of each lot number of products was used to calculate an average weight of the product. A complete as possible collection was obtained by cleaning genital areas with wet gauze; the gauze was added to the collection bag. A record of weights of water and gauze was kept. The number of products used for each 24-hour collection period was recorded. Wet and dry weights were collected and appropriate calculations for amount of menstrual fluids lost were performed.

RESULTS

A total of 25,171 person days of data were available. Sample collection problems, spilled samples, etc. produced smaller sample sizes for each analysis. Dry weight of stool samples was not measured during all experiments, hence this sample size is considerably smaller.

Stool

Stool sample data were available in both wet weight and dry weight. The number of bowel movements combined into a day's sample was also recorded.

Analysis of 24,888 24-hour stool samples gave a mean wet weight of 95.5 g per day (s.d. 95.7 g). A large part of the variation for the standard deviation resulted from no bowel movements 30% of the days (7581), and thus zero weight. The dotted line in Fig. 1a shows the distribution of these 24-hour samples. The solid line shows the distribution of individual mean values for 171 individuals. Much of the variation is caused by individual differences. Figure 1b shows the distribution of samples as a multiple of the individual's mean, thus presenting a measure of variation within individuals. The highest value was 25.6 for the size of one day's sample when divided by that individual's mean; this is equivalent to more than three weeks. This individual usually had one day a month with a 24-hour stool sample that exceeded

14 times the individual's mean. Values over four times the individual's mean were common among individuals.

Mean daily stool weight correlated ($p < 0.001$) with caloric intake, which is a measure of the quantity of food. However, the R^2 value is only 0.28, indicating that 72% of the variation in individual means is not explained by the quantity of food eaten. Additional fiber in the diet is known to increase daily stool weight (Tucker et al., 1981). The subjects in this study were on a relatively low-fiber diet, not unlike that eaten while in space.

The size of the stool sample produced on a given day is influenced by the size of the sample of the previous day, particularly by zero sample days. We made computer simulation runs of 100 days for crews of 2 to 20 individuals. One hundred days of data were available for 128 individuals in our sample. "Crews" were selected in sequence from this group, with each individual being used only once for a crew of each size from 2 to 20. Consequently we had 64 crews of 2 but only 6 crews of 20 individuals in our simulation runs. In a given run, the first day's waste quantity of all crew members was summed and the waste processor capacity subtracted from the total. If unprocessed waste remained, it was carried forward as "surge capacity," otherwise the next day started at zero. This was done sequentially for the 100 days. A variety of waste processor sizes was assumed, starting from just slightly larger than the mean (corrected for crew size) to 10 times the mean. The number of days not generating surge capacity was counted. In addition, the distribution of the surge capacity values was obtained. The processing capacity required in order to never need surge capacity and the capacity needed to use surge capacity on only 1% of the days is shown for the various crews in Fig. 1c. The mean is included in the figure for comparison purposes.

Dry Stool Weight

Dry stool weight was measured in 14,963 24-hour samples. The mean weight was 20.5 g per day (s.d. 19.5 g). The minimum was zero and maximum was 201.8 g. There were 4575 days with no movements; hence only 10,288 samples were actually dried. Figure 2a represents the distribution of 24-hour values (dashed line) and individual means (solid line). Figure 2b shows 24-hour values as a multiple of the individual's mean. The mean fraction of the sample remaining after drying is 0.25. Substantial variation, 0.15 to 0.40, existed between individuals. However, the mean value of individual means was similar at 0.26.

Results of simulation runs for crews of 2 to 20 persons are shown in Fig. 2c. The number of runs is based upon 100 days' data for 74 individuals; higher crew sizes are represented by only 3 runs.

Frequency of Bowel Movements

Individuals had bowel movements on 70% of the days. The mean number of bowel movements per day was 0.855. Individuals had a range of average number of movements between 0.21 and 2.54 movements per day. On 99% of the days individuals had 3 or fewer movements.

Urine

Analysis of 24,919 24-hour combined urine samples shows a mean value of 2066 ml (s.d. 1234). This value is 38% larger than the 1500 ml used in some other studies (Schubert et al., 1985; Slavin et al., 1986; Nitta et al., 1985). Figure 3a shows the

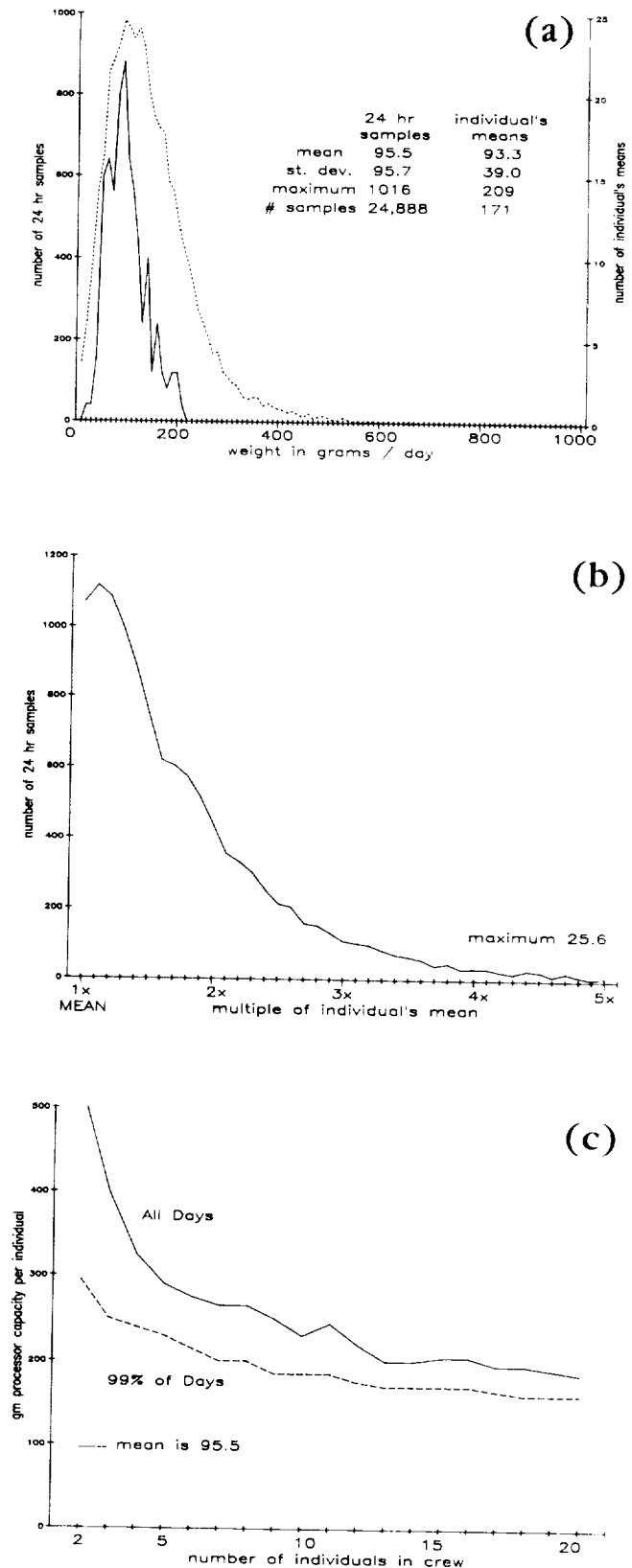

Fig. 1. 24-hour stool sample. (a) Dashed line is 24-hour samples, solid line is means of individuals. (b) Distribution of samples represented as a multiple of that individual's mean. The 43% of samples that exceed the mean are shown. (c) Required per-person stool processing capacity vs. crew size. The mean is included for comparison.

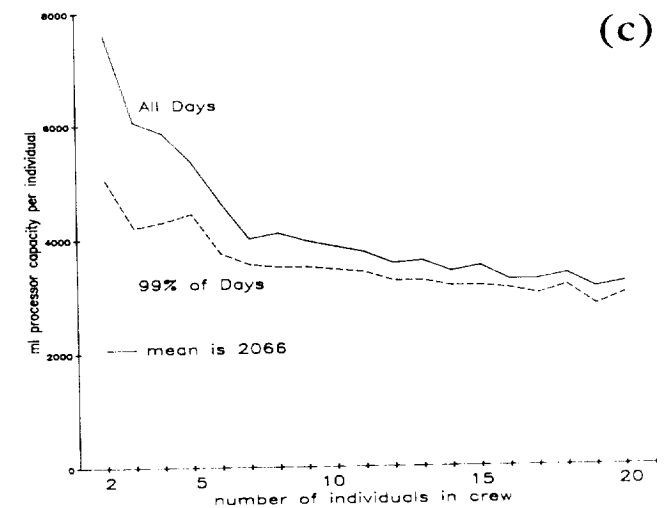
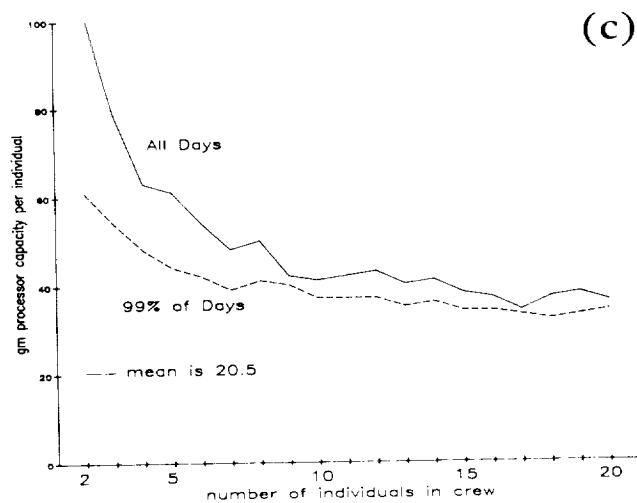
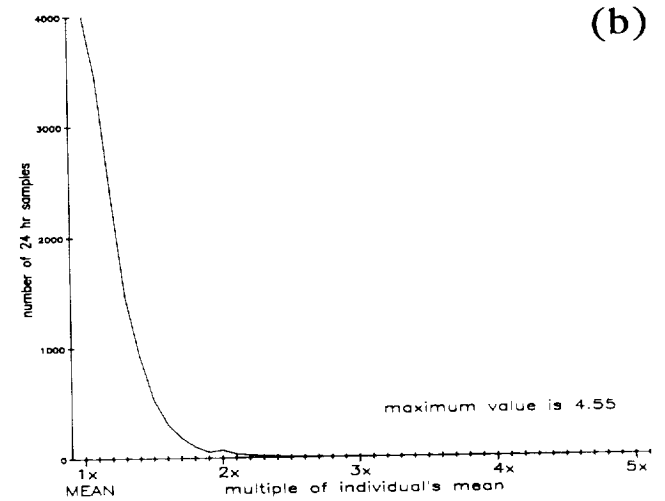
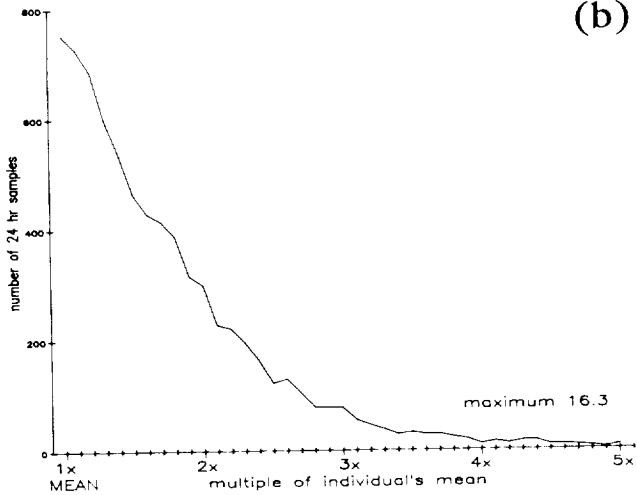
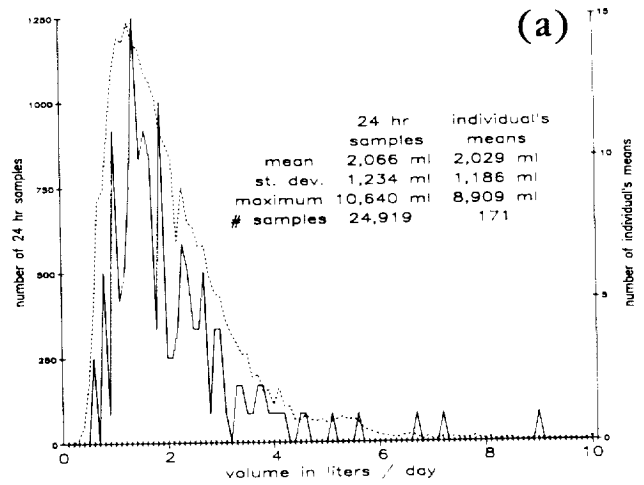
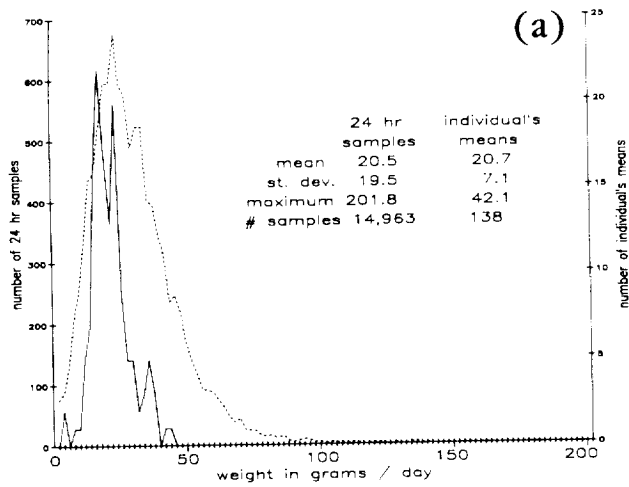

Fig. 2. 24-hour dry stool samples. (a) Dashed line is 24-hour samples, solid line is means of individuals. (b) Distribution of samples represented as a multiple of that individual's mean. The 45% of samples that exceed the mean are shown. (c) Required per-person dry stool processing capacity vs. crew size. The mean is included for comparison.

Fig. 3. 24-hour urine samples. (a) Dashed line is 24-hour samples, solid line is means of individuals. (b) Distribution of samples represented as a multiple of that individual's mean. The 39% of samples that exceed the mean are shown. (c) Required per-person urine processing capacity vs. crew size. The mean is included for comparison.

distribution of 24-hour urine samples (dashed line) and the distribution of the 171 individuals' means (solid line). As expected, the distribution of individuals' means is somewhat narrower than that for the daily values. Figure 3b shows the distribution of daily samples as a fraction of the individuals' mean values. Simulation runs for crews of 2 to 20 individuals are presented in Fig. 3c.

Variation in urine output is primarily dependent on fluid intake (78% of the variation in urine volume is explained by variation in fluid consumed in a sample of 11,748 days). The regression (with standard errors) for 24-hour urine samples against fluid consumed is

$$\text{ml urine} = -683 (\text{SE } 14) + 0.800 (\text{SE } 0.004) \times \text{ml fluid consumed.}$$

Though many of the subjects in our sample were of college age, no beer drinking occurred during the studies, thus avoiding one factor that is known to produce high urine volumes. However, some subjects were normally drinking large quantities of water, and thus producing large quantities of urine. The extreme individual averaged 10,435 ml of drinking water per day over the 2-month study period. It is possible to bring the means of individuals with high values down by limiting their fluid intake. However, we assume that this limitation on people's normal habits is not appropriate.

There is a shift in distribution of body fluids when an individual goes into zero gravity, resulting in the body dumping fluids for the first few days in space (*Leach and Rambaut, 1977*).

No direct measurements were made on these samples for the dry weight of the urine. Urine was analyzed for specific items of interest in each department.

Menstrual Flow

Menstrual flow is quite variable between individuals. A typical value is about 10 g of solids per menstrual period (estimated from an average of 28 ml blood loss per period) (*Hallberg and Nilsson, 1964, p. 356*); that amount would have little impact on waste handling equipment design. However, the menstrual pads and tampons used during a period do add significantly to the load on the solid waste management.

We have data on 1 to 5 menstrual periods for 34 women for a total of 105 menstrual periods. *Umoren and Kies (1982, p. 719)* present information on the number of pads and tampons used during 30 periods. The mean value was 11.8 with a range of 4-35 in 30 sampled periods. Our comparable results are 16.2 with a range of 3-34. The combined 135 sampled periods shown in Fig. 4 averaged 15.2 per period. Our 105 samples showed 28% of the pad and tampons being used on the second day (peak flow) of the period, or an average of 4.5, with the highest number, 10, occurring once, 9 occurring 5 times, and 6 or more occurring 26% of the time.

A mean weight of six brands of tampons gave an average weight of 2.60 g (range 2.24-2.91 g). Three brands of pads were weighed and averaged 10.65 g (range of 10.6-10.7 g). The mean weight of 9 products is 6.4 g for the first item, so there would be a solid material load of 29 g (6.4×4.5) from pads and tampons on the second day of a period. We assume that there are 5 g of solids in menstrual flow on the second day of a period.

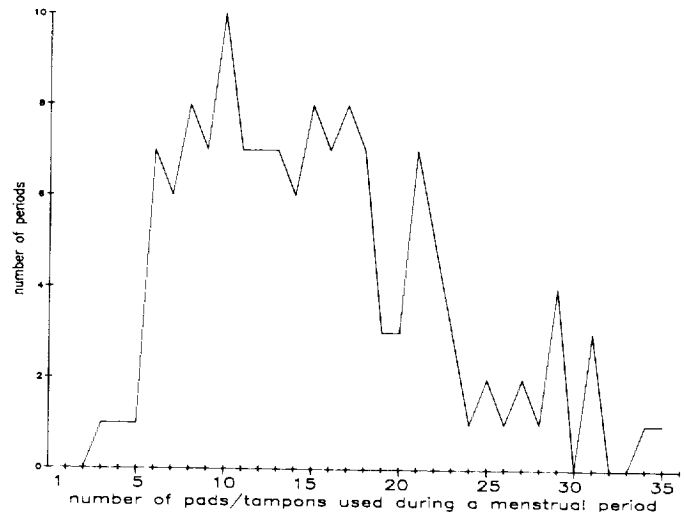

Fig. 4. Distribution of pad and tampon use per menstrual period.

Toilet Paper

Toilet paper adds to the solids load of the waste handling equipment. We have no statistical sample of toilet paper use but estimate about 6 g of toilet paper per movement or per urination by a woman. At 0.855 movements/day, the toilet paper would add 5.1 g, and at 6 urinations/day, toilet paper usage would be increased by 36 g/day/woman.

DISCUSSION

Since the distributions of human waste production are skewed considerably (Figs. 1a, 2a, 3a), it would be unwise to design waste handling equipment around mean values. The crew for a small space facility could easily have a urine or stool output that is significantly above the mean value multiplied by that number of individuals.

To monitor the micronutrients over the length of the studies from which our data came, it was necessary to provide food from consistent sources. Consequently, fresh fruit and vegetables were not included in the diet, and the diet is slightly lower than the average American diet in fiber. Quantity of fiber is known to increase the quantity of stool solids. Our values are likely to be slightly lower in quantity of stool solids than the average American diet, but probably similar to space diets before local food growth is developed.

Total Waste Load

Table 1 summarizes our assessment of the waste load design criterion for a crew of eight. Values are given for both 100% coverage and 99% coverage of daily waste production based upon our simulation runs. Separate values are given for the additional sanitary supplies used by women.

The reliability of the values in Table 1 varies. Urine volume, stool water, and stool dry weight are highly reliable, being based on several thousand samples. Urine solids are based on a literature mean value, and we are unable to incorporate statistical variation into this category. Thus, the urine solids value is too small by an

TABLE 1. Suggested daily waste load design level for a crew of eight.

Item	100% level	99% level	Added for women	Daily mean value	Literature
Urine	4,100 ml/person	3,500 ml/person		2,066 ml/person	1,500 ml/person
Stool H ₂ O	215 ml/person	159 ml/person		75 ml/person	90 ml/person
Total fluid	4,315 ml/person	3,659 ml/person		2,141 ml/person	1,590 ml/person
Crew of 8 total	34,520 ml/day	29,272 ml/day			
Recommended	34.5 liters/day				
Urine solids*	59 g/person	59 g/person			59 g/person
Stool solids	50 g/person	41 g/person		20.5 g/person	32 g/person
Toilet paper	6 g/person	6 g/person			
Menstrual pads	(37) g/person [‡]		36 g/person [†]		
Menstrual flow			29 g/person [§]		
Total solids	115 g/person	106 g/person	5 g/person		
Total			70 g/person		91 g/person
(50% women)	154 g/person**	145 g/person**			
Crew of 8, total	1,232 g/day	1,160 g/day			
Recommended	1.25 kg/day				

* Urine solids probably vary less than fluid volume. Lacking data we assumed no variation.

† Assumed 6 urinations per day.

‡ Assumed 6 pads/tampons, the 75%ile level.

§ Average of 4.5 pads/tampons times 6.4 g each.

** The weight added for women is $(36 + 37 + 5) \times 0.5 = 39$ g.

Literature values from Schubert et al. (1985), Slavin et al. (1986), and Nitta et al. (1985).

unknown factor. Toilet paper weight may be unreliable, being based upon one brand and an estimate of usage amounts. Menstrual pad and tampon usage is based on a modest sample, 135 periods, with distribution during the period based on 105 periods. Variation in weight between brands of pads and tampons (seven tested) is considerable as well, so the peak flow day weight load is only modestly reliable. However, other studies (Schubert et al., 1985; Slavin et al., 1986) have ignored menstrual supplies entirely, which is inappropriate. Reliability of toilet paper usage by women after urination is low.

This work was done with the intent of obtaining parameters for the design of waste handling facilities for a space facility. In the near future all such systems will be designed for relatively small crews, and statistical variation between individuals is always an issue when dealing with small populations. If a system is designed to handle three individuals, it is likely that a proportion of the possible three-person crews would generate waste loads that are higher than the average of a population, especially when individuals randomly selected for the crew are from a population that has a highly skewed distribution. As the number of individuals to be handled by a system grows, the impact of extreme individuals diminishes. However, as long as small crew sizes are being considered, the design criterion should exceed the population mean by a substantial margin.

We attempted with our computer simulation runs to determine if it was worthwhile building in surge capacity to deal with variations. We concluded that surge capacity would not be helpful because relatively large surge capacity would be required for small decreases in capacity. Surge capacity utilization showed up primarily with the extreme crew rather than with the extreme days for many crews. Since we did not feel that it was appropriate, or likely, to select crew members based upon the individual's physiological and/or behavioral characteristics in these areas we

decided to recommend building adequate capacity to process wastes produced by crews with the largest waste production loads.

We did not simulate pad and tampon usage during menstrual periods. Though the average pad and tampon usage on the second day of the menstrual period is 4.5 units, we based our design criterion on 6 units, the 75-percentile level. It has been suggested that menstrual periods of women in close proximity have a tendency to become synchronous. Our design criterion allows for this to happen in the very confined quarters of space habitats. Since this is so obviously grouped in time, it might be reasonable to design temporary storage for this waste; however, though peak menstrual pad and tampon usage and flow occurs only one day a month, we recommend that equipment should be designed to handle this known load.

Emesis (vomit) values are not included in the design estimate because they are assumed to substitute for other items that would be proportionally reduced.

For a crew of eight, we recommend designing for a fluid load of 4315 ml/person/day (34.5 liters for the crew). The average 2141 ml/person/day is likely to be exceeded by a substantial portion of crews.

Our recommended solids waste load design criterion is at least 154 g/person/day (1.25 kg for the crew of eight) for a mixed crew of men and women. The value should be slightly higher than this, but we lack data to show the statistical variation in urine solids.

Table 1 includes values from some recent studies of closed life support systems (Schubert et al., 1985, p. 30; Slavin et al., 1986, p. 14; Nitta et al., 1985, p. 205), and shows some important differences between these studies and our own. Most importantly, we have given considerable emphasis to the wide variation within the human population, while the other studies did not. We do

not believe crews should be selected on the basis of this physiological characteristic. Our mean urine volume is one-third higher than values used in the other studies. Restricting fluid intake reduces urine output, but, again, we believe drinking water should not be limited. Our inclusion of sanitary supplies (toilet paper and pads and tampons) increases the solid waste load by a third. This material was not included in the studies cited.

SUMMARY

We recommend that a design for waste handling systems of a space facility be such that it will permit selection of the crew without consideration of the individual's level of waste production. We have examined the distribution of urine and stool wastes from a sample of 25,000 days and find the data highly skewed. Information is presented to permit estimates of design criteria for crews of 2 to 20 individuals. We suggest design for a crew of 8 to be 34.5 liters per day (4315 ml/person/day) for urine and stool water and a little more than 1.25 kg per day (154 g/person/day) of human waste solids and sanitary supplies.

REFERENCES

- Hallberg L. and Nilsson L. (1964) Constancy of individual menstrual blood loss. *Acta Obst. Gynec. Scandinav.*, 43, 352-360.
- Leach C. and Ranbaut P. (1977) Biochemical responses of the Skylab crewman: An overview. In *Biomedical Results from Skylab* (R. Johnston and L. Dietlein, eds.,) pp. 204-216. NASA, Washington, DC.
- Nitta K., Ashida A., Mitani K., Ebara K., and Yamada A. (1985) Water recycling system using thermoperevaporation method. In *CELSS '85 Workshop* (R. MacElroy et al., eds.), pp. 201-225. NASA TM 88215. NASA Ames Research Center, Moffett Field, California.
- Schubert F. H., Wynveen R. A., and Quattrone P. D. (1985) Advanced regenerative environmental control and life support systems; air and water regeneration. In *Controlled Ecological Life Support Systems* (R. D. MacElroy, ed.), pp. 29-38. NASA CP-2378. NASA Ames Research Center, Moffett Field, California.
- Slavin T., Liening F., Oleson M., and Olson R. L. (1986) *Controlled Ecological Life Support Systems (CELSS) Physiochemical Waste Management Systems Evaluation*. NASA Contractor Report 177422. NASA Ames Research Center, Moffett Field, California.
- Tucker D., Sandstead H., Logan G. Jr., Klevay L., Mahalko J., Johnson L., Inman L., and Inglett G. (1981) Dietary fiber and personality factors as determinants of stool output. *Gastroenterology*, 81, 879-883.
- Umoren J. and Kies C. (1982) Menstrual blood losses of iron, zinc, copper, and magnesium in adult female subjects. *Nutr. Rep. Int.*, 26, 717-726.