

TM 948

**U.S. DEPARTMENT OF COMMERCE  
National Technical Information Service**

**N62-57948**

**A SIMPLE APPROXIMATION METHOD FOR OBTAINING  
THE SPANWISE LIFT DISTRIBUTION**

**National Advisory Committee for Aeronautics  
Washington, D. C.**

**Aug 40**



**N O T I C E**

**THIS DOCUMENT HAS BEEN REPRODUCED FROM  
THE BEST COPY FURNISHED US BY THE SPONSORING  
AGENCY. ALTHOUGH IT IS RECOGNIZED THAT CER-  
TAIN PORTIONS ARE ILLEGIBLE, IT IS BEING RE-  
LEASED IN THE INTEREST OF MAKING AVAILABLE  
AS MUCH INFORMATION AS POSSIBLE.**

1

1

NATIONAL ADVISORY COMMITTEE FOR AERONAUTICS

TECHNICAL MEMORANDUM NO. 948

A SIMPLE APPROXIMATION METHOD FOR OBTAINING  
THE SPANWISE LIFT DISTRIBUTION\*

By O. Schrenk

PRELIMINARY REMARKS

In this paper a simple approximation method is presented for rapidly computing the lift distributions of arbitrary airfoils. The numerical results are compared with those obtained by an exact method and for many purposes show a satisfactory degree of accuracy. The latter, for all practically occurring cases, can be estimated at the start of the computation work with the aid of the comparison examples given.

The method described below enables the approximate determination of the lift distributions in a few minutes with an accuracy sufficient for many purposes. It is also characterized by a certain simplicity which is useful in the clarification of many questions and is in accord with the engineer's point of view. Finally, the method is applicable to cases for which all other methods are entirely unsuitable (for example, wings with end plates).

Similar methods, as the author subsequently found, have already appeared elsewhere. The surprising accuracy of such simple methods is, however, generally unrecognized, so that a presentation of comparison computations which provide a measure of the degree of accuracy obtainable, should lead to an extended application of the method.

The author wishes to express his appreciation to his co-worker at Göttingen, Mr. N. Hiorth, for carrying out the laborious computations required for the comparison.

---

\*"Ein einfaches Näherungsverfahren zur Ermittlung von Auftriebsverteilungen langs der Tragflügelspannweite."  
Luftwissen, Bd. 7, Nr. 4, April 1940, pp. 118-120.

## FUNDAMENTAL IDEA OF THE METHOD

The plausible assumption is made that the real lift distribution lies between an ideal distribution independent of the wing shape and a distribution determined in a simple manner by the wing shape. The ideal distribution is that with minimum induced drag and constant induced downwash velocity - that is, for the usual monoplane, the elliptic distribution; while the distribution dependent on the the shape is proportional to  $\alpha t$  at each position of the wing.

## COMPUTATION PROCEDURE

In the case of the untwisted wing the angle of attack is not absolutely necessary. There is drawn instead (for the monoplane) the semiellipse of equal area with the chord-distribution curve, and the lift distribution is obtained by forming the arithmetical mean between the two curves.

In the case of twisted wings (and similarly for wings with aileron or flap deflection) there is first determined the zero lift direction of the entire wing. A sufficient approximation for this is the direction of the mean aerodynamic twist

$$\bar{\delta} = \frac{\overline{\delta(x) t(x)}}{\bar{t}}$$

Where the bars denote mean values,  $\delta(x)$  and  $\bar{\delta}$  are the twist angles between the reference direction of the entire airplane and the local and mean zero lift directions, respectively. For all further computations, the angles of attack and twist are reckoned from the zero lift direction given by  $\bar{\delta}$ .

With angles reckoned as indicated above, the lift is decomposed into a component without twist and a twist component without lift. The second component is determined on the basis of a mean value which has the zero line instead of the ellipse as the ideal distribution, and for which the twist angle must always be considered.

The general case with twist is most conveniently com-

puted with the aid of the following formula, which requires no explanation:

$$\frac{dA}{dx} = \frac{1}{2} q \frac{dc_a}{d\alpha} \alpha \left\{ t(x) + \frac{4}{\pi} \bar{t} \sqrt{1 - \left(\frac{x}{b}\right)^2} \right\} + \frac{1}{2} q \frac{dc_a}{d\alpha_\infty} \delta(x) t(x)$$

In the above relation  $\frac{dc_a}{d\alpha}$  and  $\frac{dc_a}{d\alpha_\infty}$  can generally be taken as constant along the span. A somewhat more accurate formula is given below.

The trial computation of  $\frac{dc_a}{d\alpha}$  and  $\frac{dc_a}{d\alpha_\infty}$  may be somewhat refined by the introduction of a correction factor  $(1 + \kappa)$  setting:

$$\frac{dc_a}{d\alpha} = \frac{\frac{dc_a}{d\alpha_\infty}}{1 + \frac{dc_a}{d\alpha_\infty} \frac{F}{\pi b^2} (1 + \kappa)}$$

The constant  $\kappa$  for various taper ratios was determined by trial in such a way that the lift determined with our approximation method is given as correctly as possible (fig. 1). In the case of the rectangular wing the value thus determined agrees with the theoretically determined value of Glauert. For other taper ratios the agreement has not been checked and in this connection is not required. A further refinement in the value of  $\kappa$ , nevertheless, seems unnecessary.

The computation procedure thus consists of the following steps:

- a) Computation of  $\bar{\delta}$  by forming the mean.
- b) Trial computation of  $dc_a/d\alpha$  and  $dc_a/d\alpha_\infty$ .
- c) Computation of the lift distribution by the formula for  $dA/dx$ .

## ACCURACY OF THE METHOD

The comparisons given in figures 2 to 13, between the accurate values computed by the method of Multhopp and the results of the approximation method, show in general a satisfactory, and to some extent even surprising, agreement. The error arising through the assumption of a constant value of  $dc_a/d\alpha$  along the span in unfavorable cases, can be eliminated by computing a mean value

$$\overline{\frac{dc_a}{d\alpha}} = \frac{\overline{\frac{dc_a(x)}{d\alpha_\infty}} t(x)}{\bar{t}}$$

and then computing the lift by the only slightly altered formula

$$\frac{dA}{dx} = \frac{1}{2} q \alpha \left\{ \frac{dc_a(x)}{d\alpha} t(x) + \frac{dc_a}{d\alpha} \frac{4}{\pi} \bar{t} \sqrt{1 - \left(\frac{x}{b/2}\right)^2} \right\} + \frac{1}{2} q \frac{dc_a(x)}{d\alpha_\infty} \delta(x) t(x)$$

The sharp difference between lift without twist and twist without lift, to be sure, no longer arises. This correction has not been applied in the example here given.

Further refinement through additional computations, at the expense of brevity and simplicity, does not appear to be of advantage. The deviations, moreover, occur at such positions where the exact theoretical solution does not agree with actuality. - for example, for unrounded wing tips and at transition positions of ailerons and flaps.

The deviations at the transition positions of ailerons and flaps can be readily balanced by hand with the aid of examples given in the figures.

## POSSIBILITIES OF APPLICATION

The method, as may be seen, is suitable for all prob-



lems where too great accuracy is not required; that is, in general, for investigations with regard to the maximum lift coefficient  $c_{a_{max}}$ , stalling, and static equilibrium problems. By the decomposition into an ideal, plan form, and twist distribution, simple and time-saving relations may be set up for frequently repeated computations of bending moments, transverse forces, and torsional moments along the span. For the computation of the induced drag and for the downwash computation, the method is not directly applicable.

The method is suitable for the determination of lift distributions also in cases for which the usual methods fail completely. Thus, it is applicable to monoplane wings with end plates. Ideal distributions that take the place of the ellipse can be computed on the basis of an investigation of the Aerodynamic Experimental Institute (reference 1) - the distributions there given being for smallest induced drag and constant downwash. The relation for the lift distribution now becomes:

$$\frac{dA}{dx} = \frac{1}{2} \rho \frac{dc_a}{d\alpha} \alpha \ t(x) + \bar{t} \frac{f(x)}{\frac{b}{2}} + \frac{1}{b} \int_{-\frac{b}{2}}^{\frac{b}{2}} f(x) d(x) + \frac{1}{2} \rho \frac{dc_a}{d\alpha_\infty} \delta(x) t(x)$$

where  $f(x)$  is the function denoted by Mangler as the "ideal function" for the given case with end plates.

The method should likewise find application to biplanes and other arrangements.

#### SUMMARY

The approximation method described makes possible lift-distribution computations in a few minutes. Comparison with an exact method shows satisfactory agreement. The method is of greater applicability than the exact

method and includes also the important case of the wing with end plates.

Translation by S. Reiss,  
National Advisory Committee  
for Aeronautics.

#### REFERENCE

1. Mangler, W.: The Lift Distribution of Wings with End Plates. T.M. No. 856, NACA 1938.

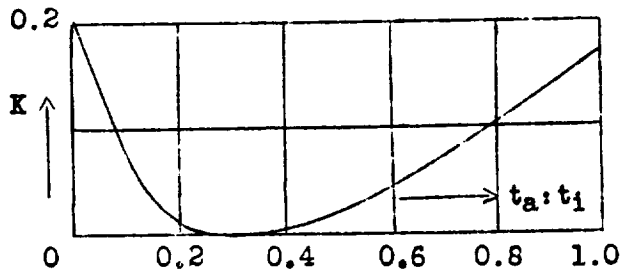
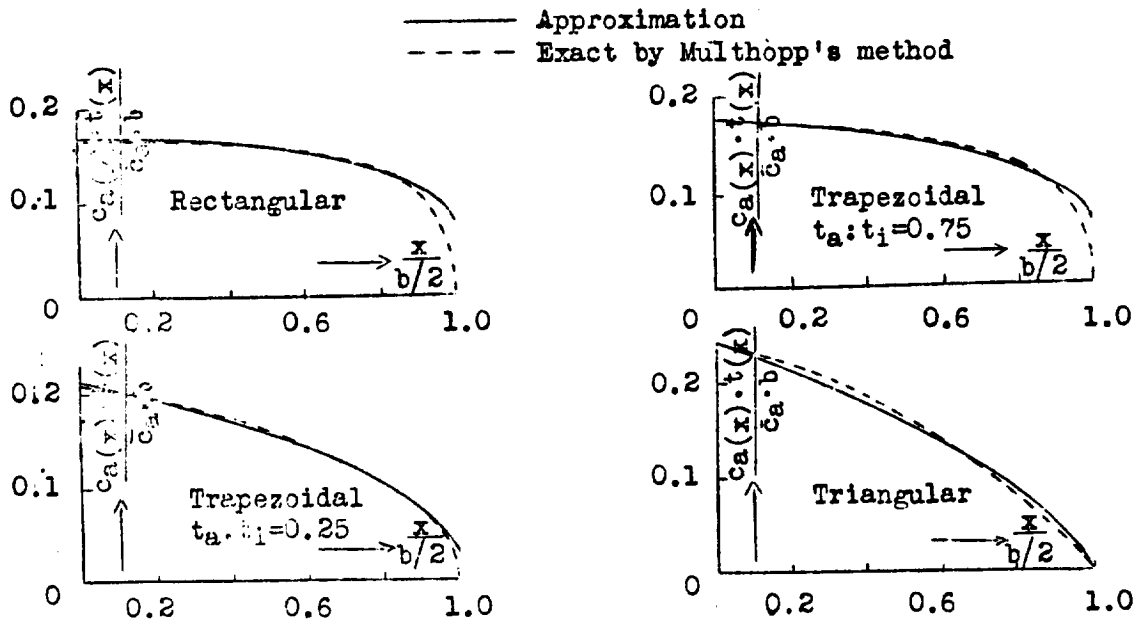

Figure 1.- The values of  $K$  that occur in the formulas for  $dA/dx$ . For non-trapezoid shaped wings the nearest value of the taper ratio is used for the determination of  $K$ .



Figures 2 to 5.- Comparison curves with  $b^2/F=6.67$  for various taper ratios. The comparison for  $t_a:t_1=0.5$  is given on Fig. 6. No twist.

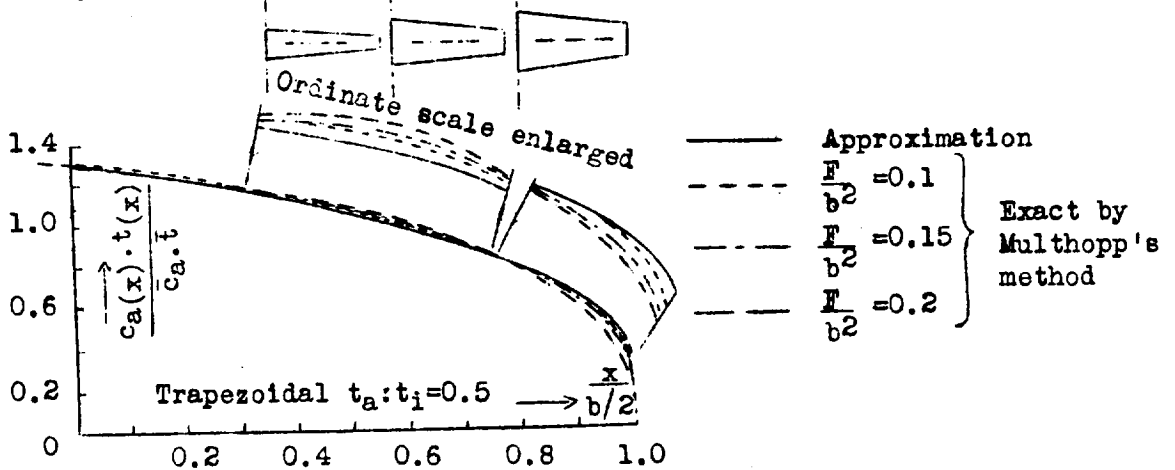
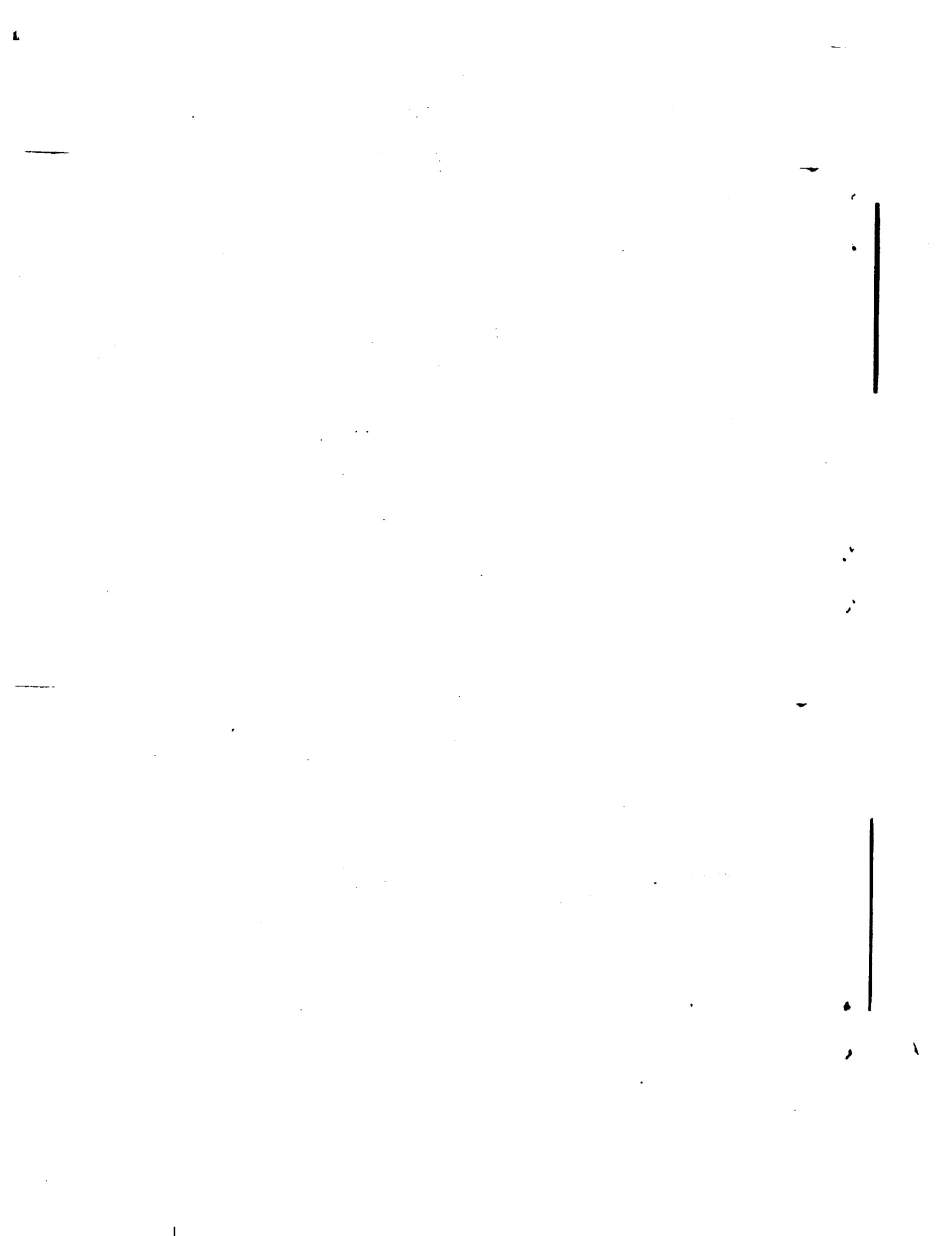

Figure 6.- Comparison curves for  $t_a:t_1=0.5$  for various values of  $F/b^2$ . No twist.



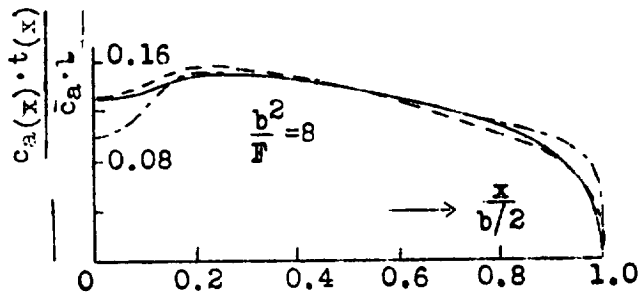

Figure 7.- Comparison curves for a wing without twist with cut-out in center. All three curves enclose equal area.

Key for Fig. 7.

- Chord distribution
- Approximation
- · - · - Exact by Multhopp's method.

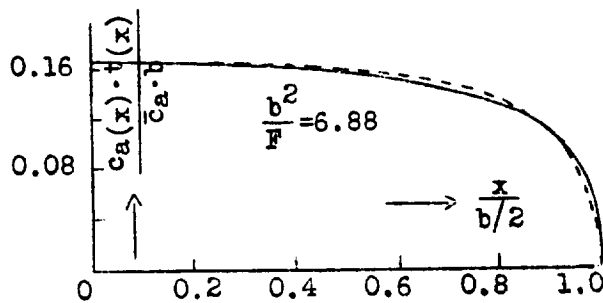

Figure 8.- Comparison curves for a rectangular wing with semicircular rounding, without twist. The deviation of the approximation method at the wing tip for the non-rounded rectangular wing here almost completely disappears.

Key for Figs. 8, 9, 10.

- Approximation
- · - · - Exact by Multhopp's method

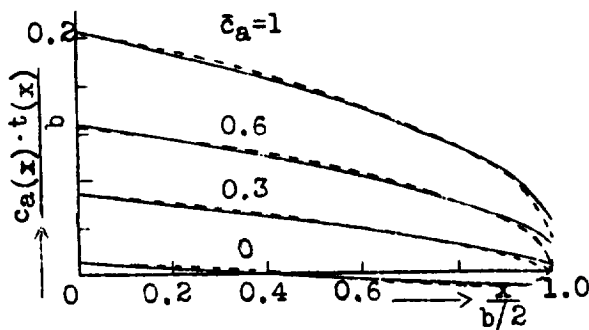

Figure 9.- Comparison curves for a wing with  $t_a:t_t=0.5$  and  $b^2/F=6.67$  for various values of  $c_a$  with a linear twist which is  $0^\circ$  at the center and  $3^\circ$  downwards at the wing tip.

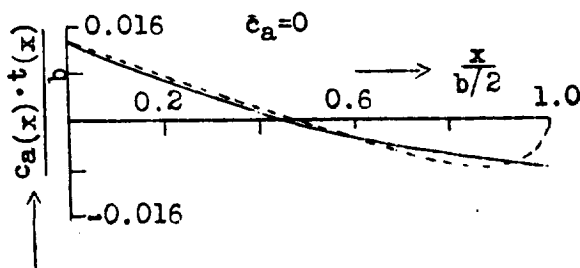
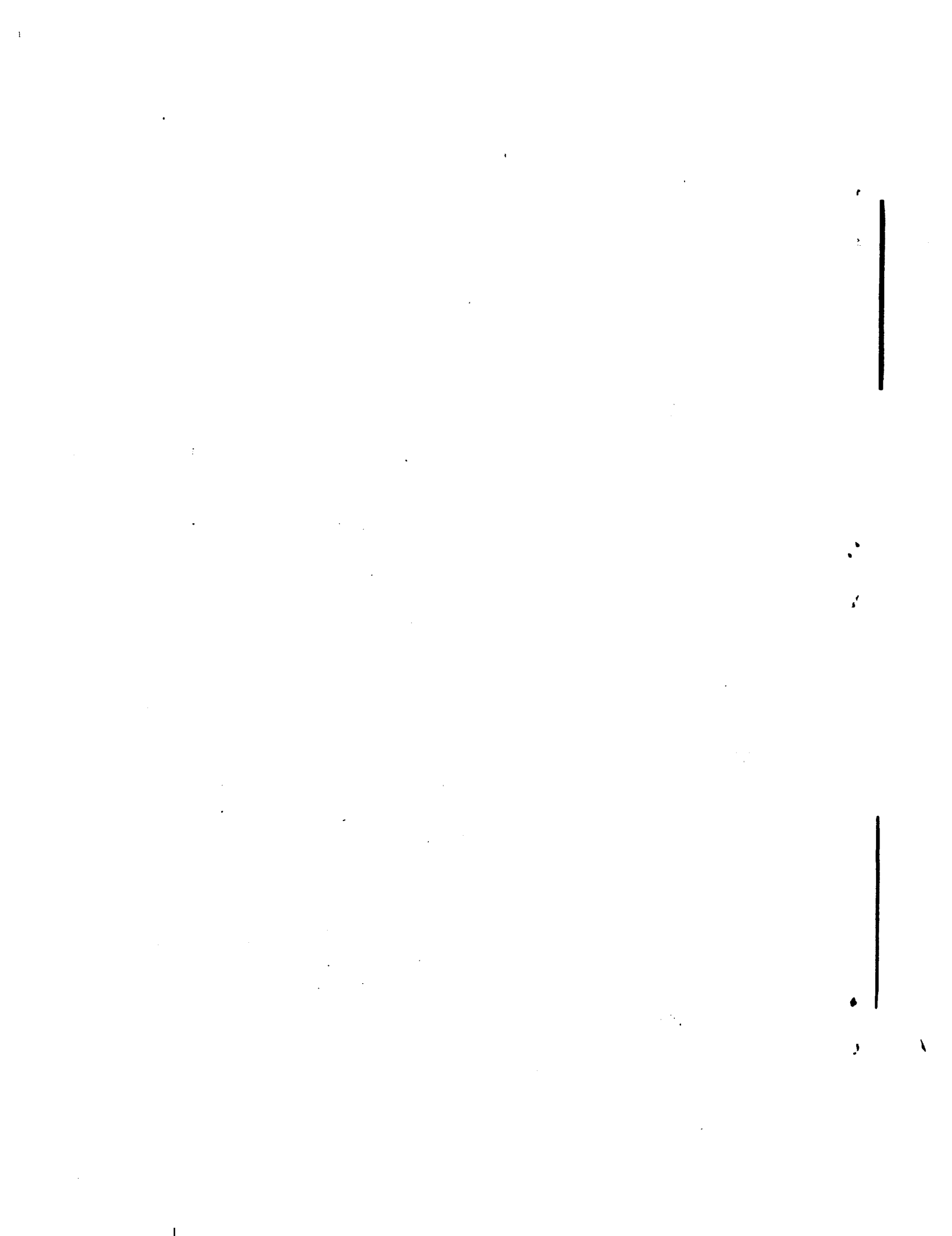

Figure 10.- Larger scale representation of the curves for  $c_a=0$  from Fig. 9.



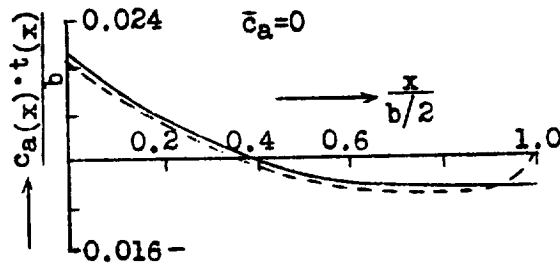

Figure 11.- Results for  $c_a=0$  as in Fig. 10 with a twist which similarly amounts to  $3^\circ$  at the wing tip but increases parabolically.

- Key for Figs. 11, 12, 13-

- Approximation
- - - Exact by Multhopp's method

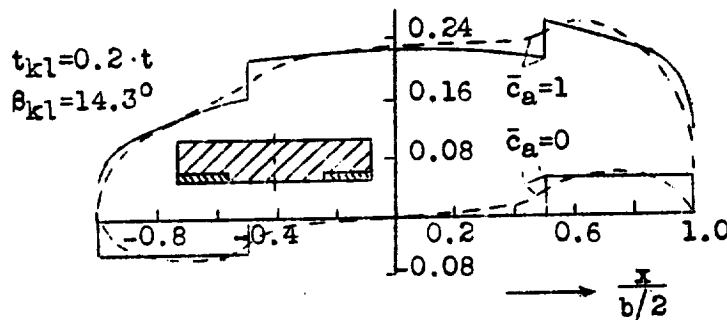

Figure 12.- Comparison curves for a rectangular wing with  $b^2/F=5$  for an aileron deflection  $\beta=0.25=14^\circ$  with and without lift. The corners of the approximation curve can practically be well rounded off by hand following the example given and thus considerably better agreement is obtained. The rolling moments of the non-rounded off approximation curve very well agree with the exactly computed values.

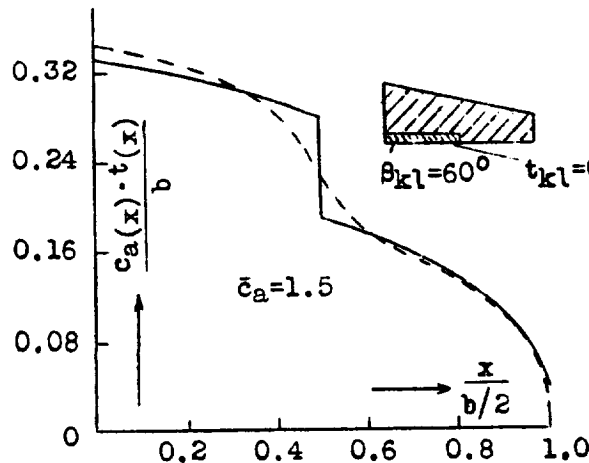

Figure 13.- Comparison curves for a tapered wing with  $t_a:t_i=0.5$  and  $b^2/F=6.67$  with  $60^\circ$  deflected split flap along center half of span.

