

02396

## Spaceborne Fiber Optic Data Bus (SFODB)

J.W. Bretthauer<sup>a</sup>, C.H. Chalfant<sup>b</sup>, F.J. Orlando<sup>c</sup>, P. Parkerson<sup>d</sup>, E. Rezek<sup>e</sup>, M. Sawyer<sup>f</sup>

<sup>a</sup>NASA Goddard Space Flight Center, Code 561; Greenbelt, MD

<sup>b</sup>Optical Networks, Inc., San Jose, CA

<sup>c</sup>Orlando & Associates, Melbourne, FL

<sup>d</sup>University of Arkansas, Fayetteville, AR

<sup>e</sup>TRW, Redondo Beach, CA

<sup>f</sup>Broadband Communications Products (BCP), Melbourne, FL

### ABSTRACT

Spaceborne Fiber Optic Data Bus (SFODB) is an IEEE 1393 compliant, gigabit per second, fiber optic network specifically designed to support the real-time, on-board data handling requirements of remote sensing spacecraft. The network is fault tolerant, highly reliable, and capable of withstanding the rigors of launch and the harsh space environment. SFODB achieves this operational and environmental performance while maintaining the small size, light weight, and low power necessary for spaceborne applications.

On December 9, 1998, SFODB was successfully demonstrated at NASA's Goddard Space Flight Center (GSFC).

### INTRODUCTION

The SFODB technology was jointly funded by the Department of Defense (DoD) and NASA. SFODB was also scheduled for integration on NASA's Earth Orbiter-1 (EO-1) satellite. The Science Advisory Team chose SFODB for its design flexibility and widespread applicability to future Earth Science missions. The Spaceborne Fiber Optic Data Bus (SFODB) Technology was selected by the New Millennium Program/Integrated Product Development Teams as a high payoff, revolutionary technology suitable for flight validation upon the Earth Orbiter-1 Mission. For this mission, science users rated SFODB highest among all cross cutting spacecraft technologies. SFODB addresses the prevalent need for a high data rate, standardized "plug and play", low power, small footprint, science instrument data interface. Such an interface is required for enabling and reducing the cost of NASA's future Earth and Space Science Missions. NASA's New Millennium Program leveraged off of DoD's previous SFODB investment to flight validate and reduce non-recurring engineering for future hyperspectral imaging and other high rate spacecraft applications.

In July 1998, due to primarily sensor cost, schedule, and spacecraft accommodation issues, SFODB was de-manifested from the EO-1 mission. However, SFODB ground support equipment was developed with flight SFODB components and demonstrated at NASA's Goddard Space Flight Center (GSFC) on December 9, 1998.

Teamwork was essential for SFODB's development. The SFODB project includes: joint DoD/NASA funding and technical support; joint TRW/Honeywell internal research and development to fabricate the radiation-hardened component technologies; Orlando & Associates, Inc.'s oversight and IEEE 1393 compliance; Optical Networks' and the University of Arkansas' high speed optical transceivers; Broadband Communications Products demonstration and development of a low cost development system; and Litton Amecom's commercialization of flight components. Full SFODB functionality was demonstrated by a team of BCP, OAI, and TRW engineers. Here, we present SFODB's capabilities, an EO-1 example application, and the demonstrated results.

### TECHNOLOGY OVERVIEW

SFODB is a revolutionary, high-speed spacecraft bus architecture based upon the commercial, Asynchronous Transfer Mode (ATM) telecommunications standard. The highly reliable, deterministic network can simultaneously support command, telemetry, and multiple high bandwidth instruments over its fiber optic bus. SFODB's one gigabit per second data transfer rate represents a thousand-fold data rate increase over the flight proven SAE 1773 fiber optic protocol. The IEEE 1393 SFODB implements a redundant, cross strapped, ring-based architecture which includes one controller node and up to 127 transmit/receive nodes, as shown in Figure 1 below.

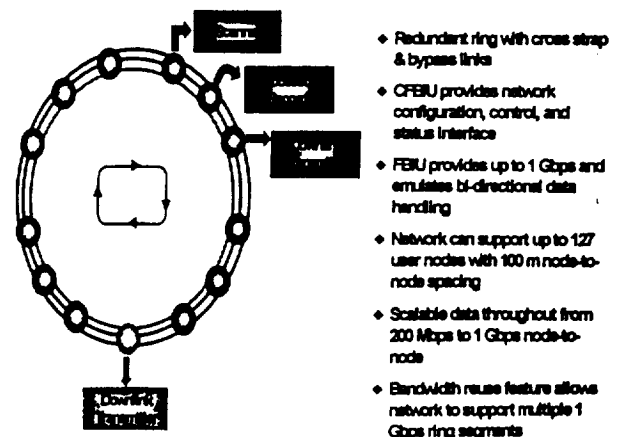

Figure 1. SFODB Fiber Optic Network

SFODB's low mass, low power, and reliable, high speed data transfer rate make it well-suited for hyperspectral imaging and other high speed applications. SFODB was designed to support bit error rates less than  $10^{-11}$  per node for non-solar flare environments and  $10^{-11}$  per node during the maximum solar flare. Its commercial, software configurable, ATM based protocol provides users extraordinary flexibility when designing their data handling architectures. Its ATM compatibility allows the spacecraft to bypass the traditional groundstation and route data directly to the user. The fiber optic cable contains 100/140 micron, multimode graded index fiber. SFODB's standard, plug and play interface attributes combine to significantly reduce spacecraft development time and cost. More detailed technical information about SFODB's capabilities and example applications may be found at the following websites:

OAI: <http://home.earthlink.net/~fjorlando/>  
 NASA/GSFC: <http://eol.gsfc.nasa.gov>

### BACKGROUND

The IEEE 1393 SFODB network, shown in Figure 1, was developed jointly by DoD and NASA. TRW and Honeywell were the industry partners responsible for designing and fabricating the original Serial SFODB multi-chip modules (MCMs), see Figure 2 below.

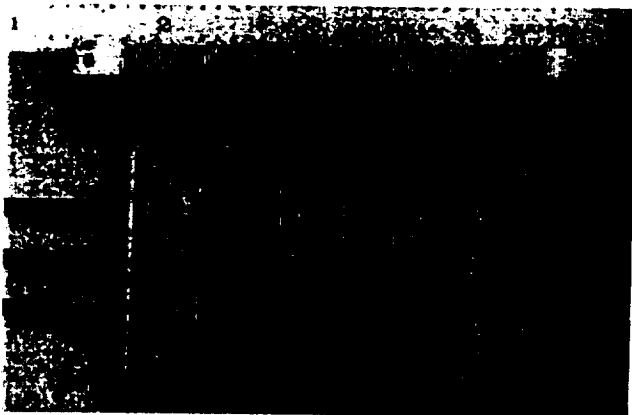

Figure 2. Serial SFODB Multi-chip Module  
 Serial SFODB controller node is illustrated above.

EO-1 chose SFODB to serve as a reliable, high rate, data transfer media between its science instruments and the Wideband Advanced Recorder Processor (WARP). The Advanced Land Imager (ALI), the Atmospheric Corrector (AC), and the Hyperspectral Imager (HSI) would all interface to their respective SFODB node and simultaneously transmit data to the WARP, as shown in Figure 3.

The SFODB technology is implemented using either a serial or parallel architecture. Parallel and serial implementations are functionally identical and transparent to the user. The original SFODB technology demonstration for EO-1 employed a serial SFODB

approach. When limited availability of critical high speed Gallium Arsenide (GaAs) integrated circuits caused Serial SFODB schedule delays (see Fig. 3), NASA baselined the Parallel SFODB architecture. The Parallel Fiber Optic Data Bus architecture satisfied NMP's critical NMP validation objectives. The next two sections briefly describe Serial and Parallel SFODB architectures.

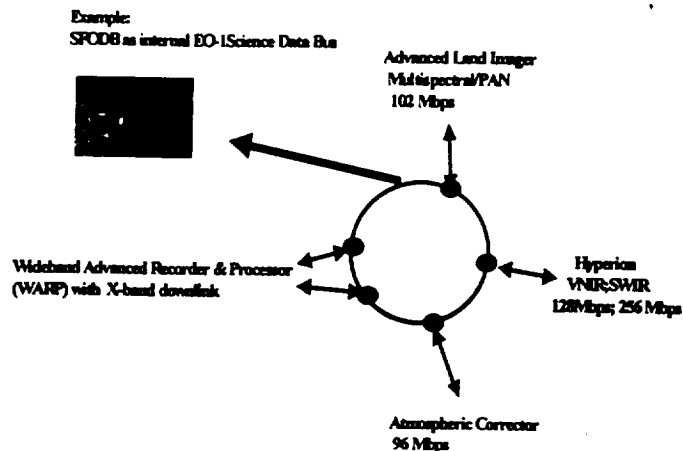

Figure 3. Example: EO-1 SFODB Application

### Serial SFODB Implementation

The Serial SFODB architecture implements the IEEE 1393 Spaceborne Fiber Optic Data Bus standard. The standard utilizes a redundant fiber optic ring which includes 1-primary link, 1-redundant link, 2-cross strapped links, and 2-bypass links. The software configurable, ATM based network is scalable and supports data rates from 200 Mbps up to 1 Gbps. The SFODB consists of two types of nodes, a control node (CFBIU) and up to 127 data nodes (FBIUs). Data is 8B/10B encoded to improve the BER performance to less than one error in  $10^{13}$  bits. The CFBIU serves as the configuration and control interface to the SFODB network. The FBIUs serve as the user's interface to the SFODB network. The SFODB network supports three types of protocol emulations: Connection Switch, Packet Switch, and Token Passing. The network can support all three modes simultaneously.

Figure 4 illustrates the high speed, GaAs integrated circuits (clock recovery unit, transmitter, 8B/10B encoder, 8B/10B decoder, transmitter, and receiver ASICs). Honeywell's most recent SFODB GaAs wafer fabrication was successfully completed by October 1998. Wafer-level testing verified a wafer lot yield, exceeding 17%, which supports the limited production requirements of spacecraft applications.

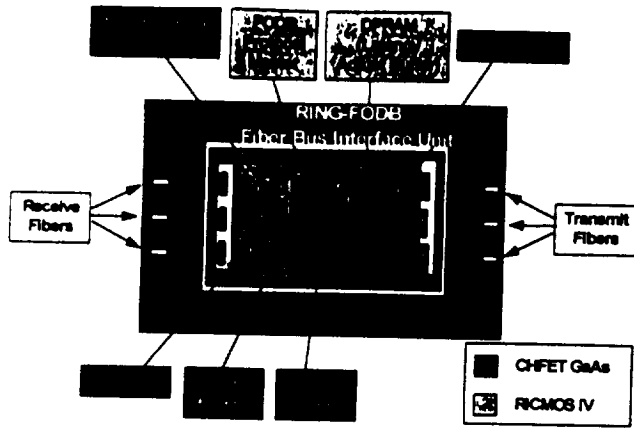

Figure 4. Serial SFODB ASIC Components

### Parallel SFODB Implementation

Parallel and serial implementations are functionally identical and transparent to the user. The Parallel SFODB network is scalable and supports data rates from DC up to 1 Gbps. Except for the physical layer, Parallel SFODB implements the complete IEEE 1393 protocol. Parallel SFODB excludes Serial SFODB's low yield GaAs components but shares the same RICMOS IV and dual-port RAM ASICs (see Figure 4). In addition, the Parallel SFODB implementation can easily accommodate new electronic and fiber-optic interface technologies as they become available, to achieve higher data throughput rates.

Parallel SFODB's simplest implementation replaces the Serial SFODB's primary, cross strap, and redundant fibers with a parallel, 12-channel, fiber optic ribbon cable. The 12-channel ribbon fiber consists of 8 data bits, 1 byte clock, a frame sync signal, and 2 backup channels which provide redundancy for the primary 10 channels (see Fig. 5).



### FBIU: FODB Bus Interface Unit

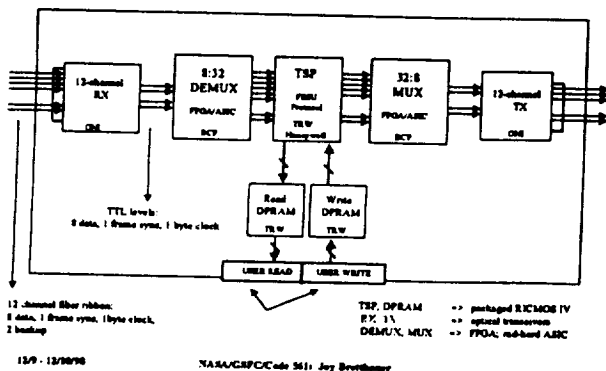

Figure 5. Parallel SFODB Block Diagram - FBIU

Parallel SFODB's physical layer was developed by Optivision (now Optical Networks, Inc) via NASA/GSFC small business innovative research (SBIR) grants. The

SBIR programs produced prototype, 12-channel fiber optic transmitter/receiver pairs (see Figure 8). All prototypes passed performance verification testing, vibration, and EO-1 level total dose and single event upset (SEU) radiation testing. Engineering and flight units are being fabricated. The 12-channel fiber optic ribbon cable assembly is a modified commercial product from GORE and USCONEC. NASA/GSFC also partnered with GORE and USCONEC to develop the 12-channel, fiber optic cable assemblies. NASA/GSFC analyzed the commercial product to identify failure modes, conducted outgassing and vibration testing, and recommended modifications necessary to support SFODB in EOS-PM missions.

Due to its byte-wide parallel physical layer, Parallel SFODB operates at about one eighth the clock rate as serial SFODB and maintains a 1 Gbps user-data throughput. This implementation uses standard, rather than very high speed and high risk, integrated circuit technology. Parallel FODB also eliminates the special coding and clock recovery functions necessary with a serial implementation. Its relatively low complexity and risk greatly reduces parallel FODB's non-recurring development cost and time.

Industry partners will use SFODB or its component technologies both in their production lines and in other fiber optic programs. Orlando and Associates, Inc. and Broadband Communications Products will produce and market the SFODB Development and Evaluation System. Space Photonics, Inc. will produce and market the high speed flight transmitters and receivers (formerly produced by ONI). TRW has designed SFODB technologies into several of their spacecraft programs. Litton Amecom is partnering with NASA/GSFC to design a "plug and play" Parallel SFODB flight module.

### Parallel SFODB Demonstration

On November 6, 1998, the first Parallel SFODB testbed, containing one controller node and one user node, was 100% functional and operated at 1 Gbps. To meet the SFODB project's demonstration goal (December 9, 1998), another user node was added to the system.

The Parallel SFODB Development and Evaluation System, illustrated in Figure 7, was successfully demonstrated at NASA's Goddard Space Flight Center on December 9, 1998. Protocol Verification using the Parallel SFODB Development and Evaluation System was completed and successfully verified full compliance to the SFODB IEEE 1393 standard.

The demonstrated system contained 1 Parallel SFODB controller node, two Parallel SFODB user nodes, a personal computer with customized-SFODB LabView software, fiber optic cable assemblies, and a National Instruments cable used to send and receive information to the fiber optic ring. User test data was entered, buffered,



inserted onto the fiber optic ring and verified via the Parallel SFODB Development and Evaluation System. The development system provides a user-friendly tool for flight processor development and verification. It also provides Earth Science Users a platform to test their instrument's interface and data compatibility with the SFODB network. The demonstration also showed SFODB's ability to replace costly multiplexing and demultiplexing flight hardware.

The Parallel SFODB's Development and Evaluation System utilizes the flight SFODB protocol and dual-port RAM ASICs. To reduce costs, the system also contained engineering test unit versions of the fiber optic cable assemblies, transceivers, field programmable gate arrays, and oscillator. The commercial grade engineering test components were not screened as strictly as the flight components and had some performance variations. The system performed exceptionally well and was demonstrated at a remarkable .8 Gbps (800 Mbps).

Although Litton Amecom is designing flight, "plug and play" Parallel SFODB modules, the current design can support flight missions. To support flight missions, known flight components (oscillator, a radiation-hardened ASIC, transceivers, and fiber optic cable assemblies) would replace the engineering test components. The personal computer interface would also be replaced with a flight processor and SFODB commands generated from the customized SFODB LabView software would be translated into flight software.

#### User's Data Input Interface

SFODB implements a simple, straightforward user interface. User data is placed on the SFODB ring via a 32 bit parallel data and clock interface (PFODB write port). For example, data transmission is achieved by connecting a clock signal and the output of an analog to digital converter to the PFODB write port (equivalent to one of the gray, on-board connectors illustrated in Fig. 8).

#### SUMMARY

SFODB's flexible, high rate architecture provides users enormous design flexibility. Its revolutionary, high-speed spacecraft bus architecture supports direct data downlinks to end-users. The highly reliable and deterministic SFODB network can simultaneously support command, telemetry, and multiple high bandwidth instruments over its fiber optic bus. SFODB's Development and Evaluation System will dramatically reduce flight development cost and time. Future efforts will produce SFODB testbeds for instrument developers and provide "plug and play" flight modules.

Test data is placed on the FODB ring and verified via COTS GSE

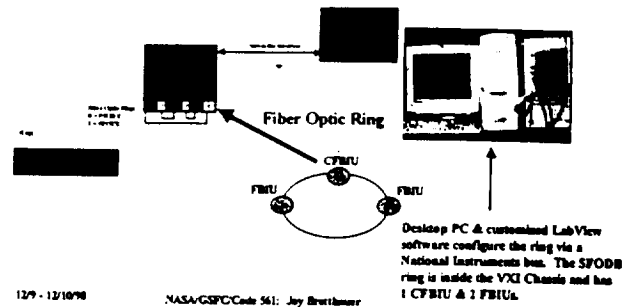

Figure 7. PFODB Demonstration Set-up

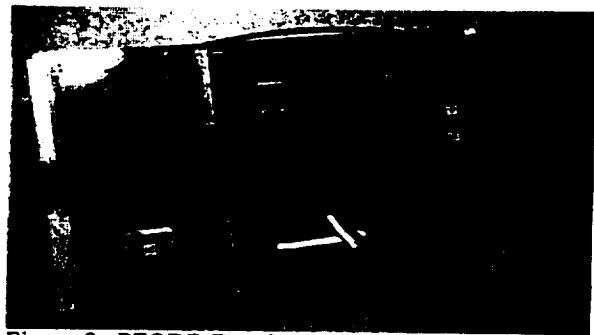

Figure 8. PFODB Development Board - FBIU

#### Acknowledgements

We wish to thank everyone who contributed to the overall success of this project. Special thanks go to: Bill Schneider; [TRW-Ron Smith, Arthur Claybon, and Hung Ngo]; [Honeywell SSEC-Gary Kirchner and team]; USCONEC; GORE; [Swales-Melanie Ott]; [NASA-Dennis Andrucyk, John Kolasinski, Philip Luers, Terry Smith, Evan Webb, George Jackson, Robert W. Stone, and Nicholas Speciale].

#### References

- [1] <http://eol.gsfc.nasa.gov>
- [2] <http://home.earthlink.net/~fjorlando/>
- [3] IEEE SFODB Working Group of the Bus Architecture Standards Committee, "P1393 Spaceborne Fiber Optic Data Bus (SFODB)," Institute of Electrical Engineers, Inc., New York, NY, August 1997.
- [4] Melanie N. Ott, Joy W. Bretthauer, "Twelve channel optical fiber connector assembly: from commercial off the shelf to space flight use," Photonics for Space Environments VI, Proceedings of SPIE Vol. 3440, 1998.

To: Joy.W.Bretthauer.1@gsfc.nasa.gov, Charles.R.McClain.1@gsfc.nasa.gov,  
Robert.T.Caffrey.1@gsfc.nasa.gov  
From: "James R. Frost" <James.R.Frost.1@gsfc.nasa.gov>  
Subject: Review of Presentation/Publication Packages  
Cc: Madeline Butler, Dick Freeman, JR Hedgpeth, Greg Larosa  
Bcc:

Reference(s):

Spaceborne Fiber Optic Data Base (SFODB), Author, Joy Bretthauer, Code 561  
Volume 4, The 1997 Prelaunch Radiometric Calibration of SeaWifs, Author, Robert T. Caffrey  
Package submitted by Dr. Charles R. McClain

Joy/Robert/Dr. McClain,

This morning I received your request(s) on NASA 1676 forms (NASA Scientific and Technical Document Availability Authorization (DAA)) for export control approval(s) on the above referenced papers intended for public disclosure. As each of the papers provide specific technical information related to remote sensing satellites and/or related instruments, I have determined that your packages would fall under the jurisdiction of the U.S. State Department, International Traffic In Arms Regulations(ITAR). As such, I would like to ask each of you to review and if appropriate, sign the applicable exemption on the attached NASA STI Public Disclosure (Export Control) Checklist. As you will see from this attachment, this checklist is in "draft" form, and we still expect to make minor changes, incorporating input from activities like your own before making this checklist final. We are confident that this checklist, as a replacement for the "draft" Public Domain Declaration will better share the concerns of the GSFC Export Control office, and will lead to more expedient Export Control approvals for GSFC Technical Documents in the near future.

Thanks for your assistance on these presentations, and we look forward to your input on this "draft" checklist. The Export Control office fax number is X6-1774 if you would prefer to fax a response back in lieu of responding via e-mail.

Thanks,

Jim Frost



## PUBLIC DOMAIN DECLARATION

**CAUTION: Export of technical data (information) with respect to the design, development, production, manufacture, assembly, operation, repair, testing, maintenance or modification of defense articles, i.e. all space flight hardware, ground tracking systems, launch vehicles to include sounding rockets and meteorological rockets, radiation hardened hardware and associated hardware and engineering units for listed items are controlled by the State Department, International Traffic in Arms Regulations (ITAR). Export of technical data(information) with respect to ground based sensors, detectors, National Security and Missile Technology items are controlled by the U.S. Commerce Department. Please contact the GSFC Export Control office if your export applies to the above or for further clarification of the U.S. State Department (ITAR) and the U.S. Department of Commerce Regulations. ( Failure to comply with the ITAR regulations and/or the Commerce Department regulations may subject one to fines of up to \$1 million dollars and/or up to 10 years imprisonment per violation)**

If your technical data does not apply with the above criteria, please select the numbered category below which best supports your declaration:

1. Public Domain - information which is published and which is generally accessible or available to the public
  - a. Through sales at news stands and bookstores;
  - b. Through subscriptions which are available without restriction to any individual who desires to obtain or purchase the published information;
  - c. Through second class mailing privileges granted by the U.S. government
  - d. At libraries open to the public or from which the public can obtain documents;
  - e. Through patents available at any patent office
  - f. Through unlimited distribution at a conference, meeting, seminar, trade show or exhibition, generally accessible to the public, in the United States,
  - g. Through fundamental research in science and engineering at accredited institutions of higher learning in the U.S. where the resulting information is ordinarily published and shared broadly in the scientific community. Fundamental research is defined to mean basic and applied research in science and engineering where the resulting information is ordinarily published and shared broadly within the scientific community, as distinguished from research the results of which are restricted for proprietary reasons or specific U.S. Government access and dissemination controls. University research will not be considered fundamental research if:

- (1) The University or its researchers accept other restrictions on publication of scientific and technical information resulting from the project or activity, or
  - (2) The research is funded by the U.S. Government and specific access and dissemination controls protecting information resulting from the research are applicable.
- h. Through public release (i.e., unlimited distribution in any form (e.g. not necessarily in published form) after approval by the cognizant U.S. government department and agency
  - i. Publicly Available Technology and Software- that technology and software that are already published or will be published; arise during, or result from fundamental research; are educational; or are included in certain patent applications (see 15 CFR 734)

Oppe M. Brettkauer  
Signature

1/7/99  
Date

h.  
Category No.