

To: Mr. Charles J. McLaughlin
Asst. Gen. Mgr.
Vought-Sikorsky Aircraft Div.
United Aircraft Corp.

NATIONAL ADVISORY COMMITTEE FOR AERONAUTICS

VOUGHT-SIKORSKY AIRCRAFT LIBRARY

THIS DOCUMENT AND EACH AND EVERY
PAGE HEREIN IS HEREBY RECLASSIFIED

FROM Conf. TO Unclass.

AS PER LETTER DATED NACA Dec 1961
Notice #122

SPECIAL REPORT No. 144

COMPARISON OF THREE EXIT-AREA CONTROL DEVICES
ON AN N.A.C.A. COWLING

By James G. McHugh
Langley Memorial Aeronautical Laboratory

May 1940

144

SR-144

COMPARISON OF THREE EXIT-AREA CONTROL DEVICES

ON AN N.A.C.A. COWLING

By James G. McHugh

SUMMARY

Adjustable cowling flaps, an adjustable-length cowling skirt, and a bottom opening with adjustable flap were tested as means of controlling the rate of cooling-air flow through an air-cooled radial-engine cowling. The devices were tested in the N.A.C.A. 20-foot tunnel on a model wing-nacelle-propeller combination, through an air-speed range of 20 to 80 miles per hour, and with the propeller blade angle set 23° at 0.75 of the tip radius. The resistance of the engine to air flow through the cowling was simulated by a perforated plate.

The results indicated that the adjustable cowling flap and the bottom opening with adjustable flap were about equally effective on the basis of pressure drop obtainable and that both were more effective means of increasing the pressure drop through the cowling than was the adjustable-length skirt. At conditions of equal cooling-air flow, the net efficiency obtained with the adjustable cowling flaps and the adjustable-length cowling skirt was about 1 percent greater than the net efficiency obtained with the bottom opening with adjustable flap.

INTRODUCTION

It is generally recognized that a means of controlling the cooling air flowing through the baffles of radial engines equipped with N.A.C.A. cowlings is necessary for obtaining maximum airplane performance. The controlling means, in conjunction with the entire cowling, should be capable of producing sufficient cooling air to fulfill certain ground operating requirements and yet be capable of limiting the flow to the needs of the engine for the cruising and the high-speed conditions of flight.

Adjustable flaps located around the circumference of a cowling are often employed as a means of controlling air flow; the mechanism, however, is complicated and the maintenance is difficult. Doors extending over small portions of the cowling circumference are sometimes employed to reduce mechanical complications. Requests for information have been received regarding the relative merits of doors for cowling-exit control.

Comparative tests were therefore made of a wing-nacelle-propeller combination equipped with three types of cowling exit opening: conventional adjustable flaps, adjustable-length skirt, and a special bottom opening with adjustable flap. Measurements were made of the net propulsive efficiency, based on the drag of a streamline nacelle-wing combination, and of the cooling-air flow.

APPARATUS AND METHODS

The N.A.C.A. 20-foot tunnel, in which these tests were conducted, is described in detail in reference 1. Sketches of the model are shown in figures 1 and 2. Photographs of the test set-ups are shown in figures 3 to 5.

The wing has a span of 15 feet, a chord of 7.2 feet, and is of N.A.C.A. 23019.5 airfoil section. All tests were run at zero angle of attack.

The nacelle used in the investigation was 20.3 inches in diameter and was fitted with an internal perforated plate to simulate the resistance of a radial engine to the air flow through the cowling. The resistance of the perforated plate was adjusted to give a value of conductance of 0.10. This quantity is proportional to the ratio of the engine orifice area to the frontal area of the cowling. (See reference 2.) With this value of conductance, the pressure drop across the engine orifice plate varied from a value of $\Delta p/q$ of 0.10 to a value of $\Delta p/q$ of 0.70 for different exit openings.

A three-blade propeller, 5.75 feet in diameter, was constructed from Curtiss propeller drawings nos. 88980 and 88981 and the blades were set at 23° at 0.75 of the tip radius. A small spinner was fitted to the propeller hub to improve the cooling characteristics of the cowlings.

The electric motor used to drive the propeller develops 15 horsepower at 1,150 rpm. It was mounted inside the wing, and the propeller was driven through an extension shaft.

Each cowling arrangement was tested at several different values of the cowling-exit area. For convenience, the test conditions are tabulated as follows.

Type of exit-area control	Cowling-exit condition	Exit area (sq in.)	Ratio of exit area to nacelle cross-sectional area
Controllable cowling flaps	Flap angle (deg):		
	0	15.9	0.049
	10	42.0	.130
	20	65.6	.203
	30	94.0	.291
Variable-length cowling skirt	Exit gap (in.):		
	0.25	15.9	.049
	.78	49.0	.152
Bottom opening with adjustable flap	1.50	94.0	.291
	Flap angle (deg):		
	0	26.7	.082
	9	31.3	.097
	20	39.2	.121
	30	46.0	.142
40	52.9	.164	
50	60.9	.189	

One test was made with the propeller removed, the exit sealed, and with a large nose fairing added to the nacelle (fig. 2) to establish a basis for computing the net efficiency.

RESULTS AND DISCUSSION

All data are reduced to standard nondimensional coefficients. The symbols and coefficients involved are defined as follows:

- q dynamic pressure of air ($1/2 \rho V^2$).
 ρ mass density of air.
 V velocity of air stream.
 n propeller revolution speed.
 D_c drag of streamline nacelle-wing combination taken from drag test at same value of q .
 B net force on thrust balance.
 D diameter of propeller.
 P power supplied to propeller.
 V/nD advance-diameter ratio of propeller.
 η_o net efficiency of combination $\left[\frac{(R + D_c)V}{P} \right]$.
 $\eta_{o\max}$ maximum η_o from plot of η_o against V/nD .
 Δp pressure drop across engine orifice plate.
 $\sqrt{\Delta p / \rho n^2 D^2}$ pressure coefficient.
 K_1 $\frac{\text{cowling-exit area}}{\text{nacelle cross-sectional area}}$.
 K conductance of engine $\left(\frac{Q}{FV\sqrt{\Delta p/q}} \right)$.
 Q quantity of cooling-air flow.
 F maximum cross-sectional area of nacelle.

Paired curves of η_o against V/nD at different exit conditions are shown for the adjustable cowling flaps, the adjustable-length cowling skirt, and the bottom opening with adjustable flap in figures 6, 7, and 8, respectively. These figures show a progressive decrease in $\eta_{o\max}$ with increase in cowling-exit area. This effect is largely due to the increase in cooling-air-flow drag with increase in cowling-exit area.

The variation of pressure coefficient $\sqrt{\Delta p / \rho n^2 D^2}$ with K_1 for six values of V/nD is shown for the adjustable cowling flaps, the adjustable-length cowling skirt, and the bottom opening with adjustable flap in figures 9, 10, and 11, respectively. The values therein given are average values; no measurements were made of the distribution of flow through the cowling.

Comparison of the results reveals that, with the particular dimensions chosen, the cowling flap and the bottom opening are approximately equal in merit on the basis of pressure drop obtainable and that both provide higher values of pressure drop than the adjustable-length cowling skirt. It is therefore possible that, for other arrangements in which the flap chord is longer, the adjustable cowling flap might yield greater values of pressure drop than either of the other two arrangements.

In order to make comparisons of $\eta_{o\max}$ for conditions of equal cooling-air flow, the values of $\eta_{o\max}$ and V/nD at $\eta_{o\max}$ for each arrangement tested were obtained from figures 6, 7, and 8. The corresponding values of

$\sqrt{\Delta p / \rho n^2 D^2}$ were obtained from figures 9, 10, and 11. For each arrangement, the value of $\Delta p/q$ obtained at the condition of $\eta_{o\max}$ was computed from the relation

$$\frac{\Delta p}{q} = \frac{2(\Delta p / \rho n^2 D^2)}{(V/nD)^2}$$

The results of this computation are given in figure 12, wherein $\eta_{o\max}$ is plotted as a function of $\Delta p/q$ for the three exit-area control devices. Throughout the range of values of $\Delta p/q$ at which comparisons can be made, the values of $\eta_{o\max}$ obtained with the bottom opening with adjustable flap are approximately 1 percent lower than those obtained with the adjustable cowling flap and the adjustable-length cowling skirt. In all cases, the value of $\eta_{o\max}$ decreases with increasing value of $\Delta p/q$, as would be expected. Throughout the greater portion of the range, the decrease in $\eta_{o\max}$ with increasing value of $\Delta p/q$ is mainly due to the increase in cooling-air-flow drag that occurs with increase in $\Delta p/q$. At high

values of $\Delta p/q$, however, the rapid decrease in $\eta_{o_{max}}$ is largely chargeable to the fact that large exit areas increase the form drag by disturbing the flow over the nacelle.

CONCLUDING REMARKS

The results indicate that the adjustable cowling flap and the bottom opening with adjustable flap are about equal in merit on the basis of pressure obtainable and that both are more effective than the adjustable-length cowling skirt.

For equal cooling-air flow, the maximum net efficiency obtained for the adjustable cowling flaps and for the adjustable-length cowling skirt was about 1 percent greater than that obtained for the bottom opening with adjustable flap.

No measurements were made of the distribution of flow through the cowling. Such measurements will be necessary before definite conclusions can be drawn concerning the relative cooling qualities of the arrangements tested.

Langley Memorial Aeronautical Laboratory,
National Advisory Committee for Aeronautics,
Langley Field, Va., March 12, 1940.

REFERENCES

1. Weick, Fred E., and Wood, Donald H.: The Twenty-Foot Propeller Research Tunnel of the National Advisory Committee for Aeronautics. T.R. No. 300, N.A.C.A., 1928.
2. Theodorsen, Theodore, Brevoort, M. J., and Stickle, George W.: Full-Scale Tests of N.A.C.A. Cowlings. T.R. No. 592, N.A.C.A., 1937.

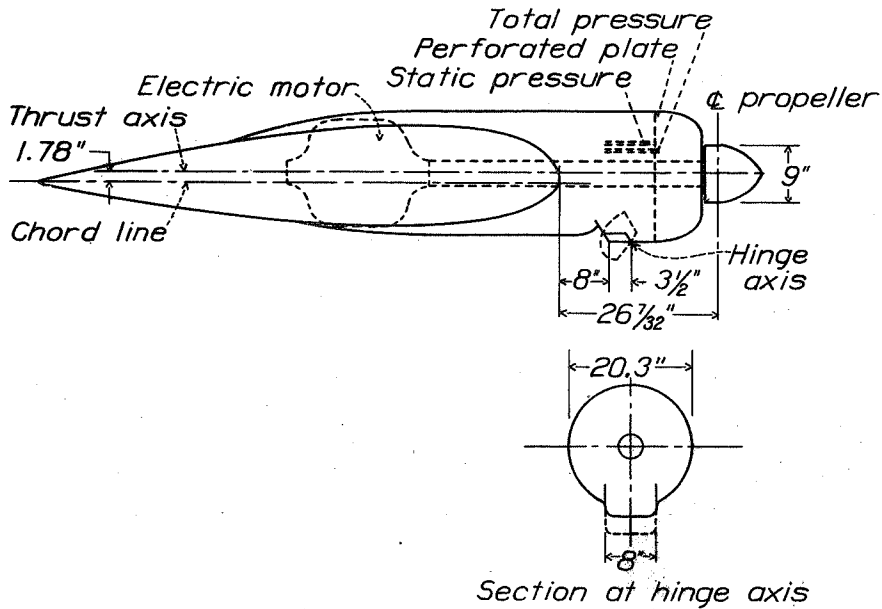

Figure 1.- Wing-nacelle combination with cowling arrangement for test of bottom opening with adjustable flap.

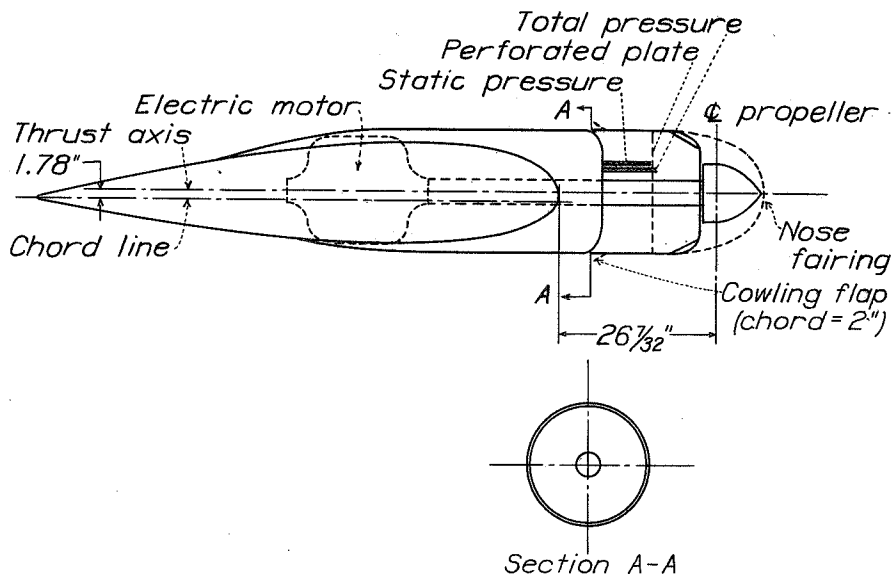

Figure 2.- Wing-nacelle combination with cowling arrangement for test of cowling flaps and adjustable-length cowling skirt.

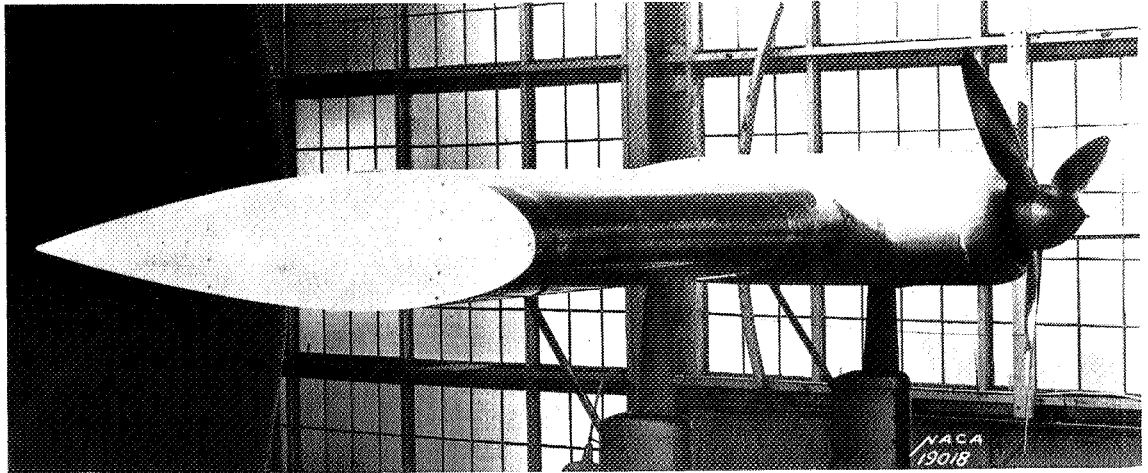

Figure 3.- Adjustable cowling flap test set-up.

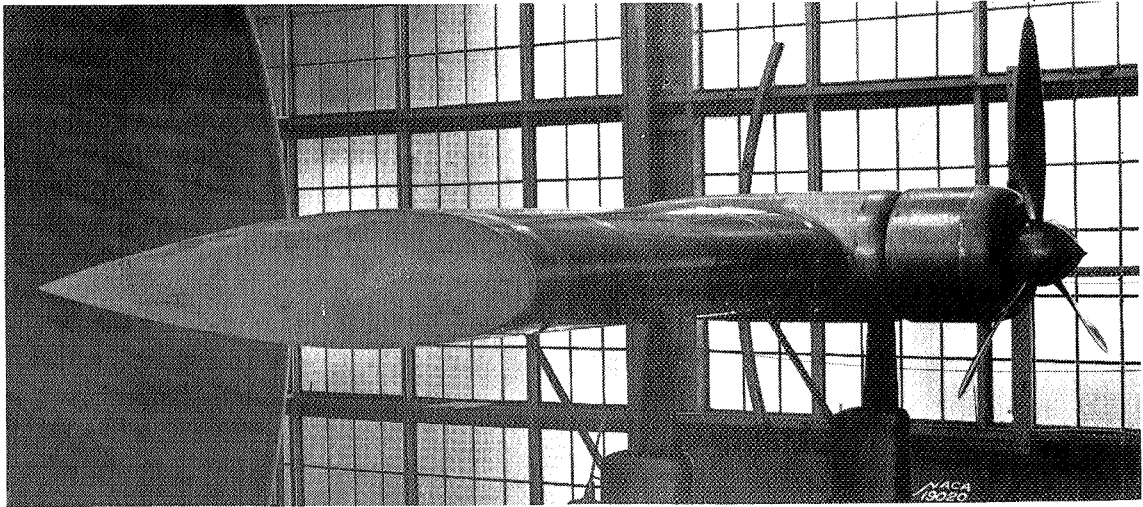

Figure 4.- Adjustable-length cowling skirt test set-up.

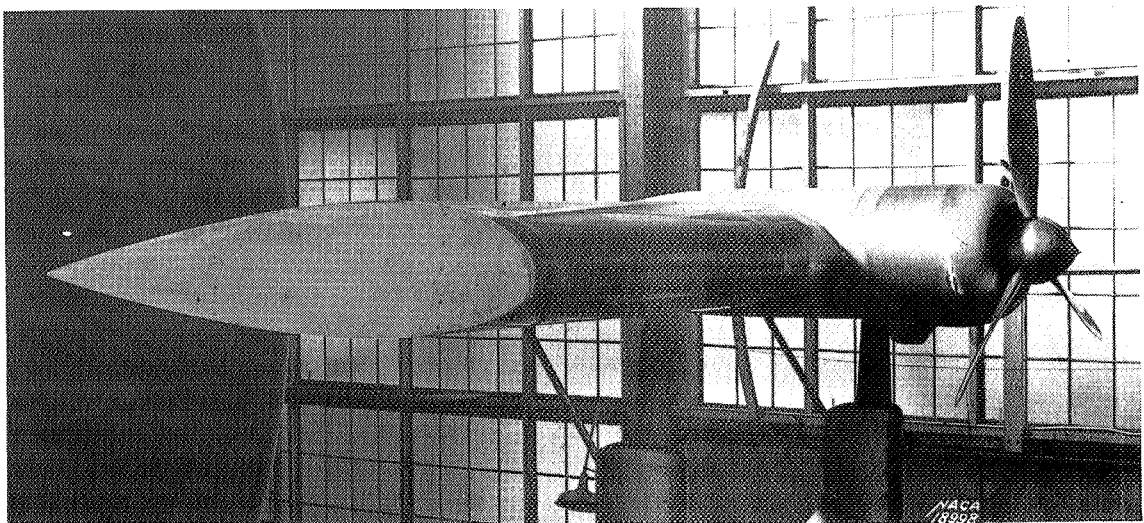

Figure 5.- Bottom opening with adjustable flap test set-up.

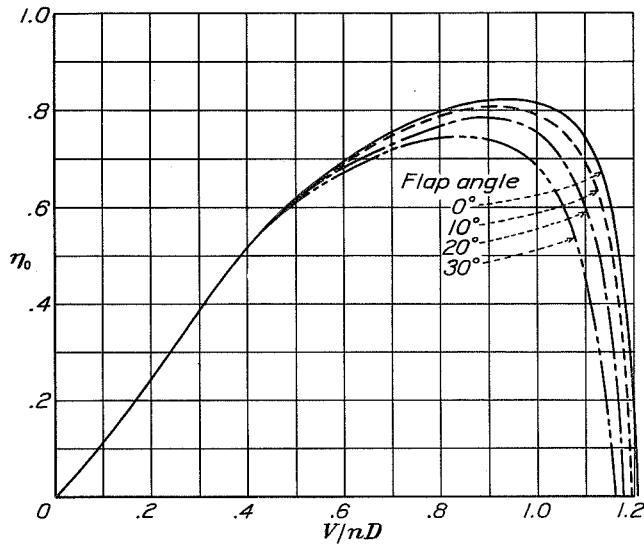

Figure 6.- Comparison of net efficiency obtained with various cowling flap angles. N.A.C.A. cowled nacelle with adjustable cowling flaps.

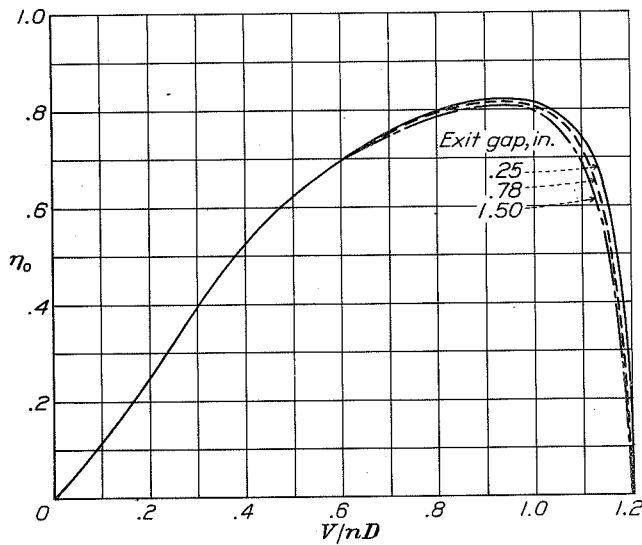

Figure 7.- Comparison of net efficiency obtained with various skirt lengths. N.A.C.A. cowled nacelle with adjustable-length skirt.

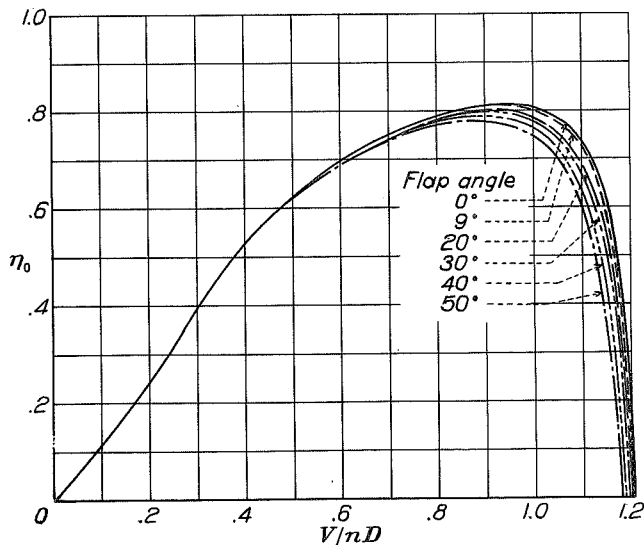

Figure 8.- Comparison of net efficiency obtained with various exit flap settings. Bottom opening with adjustable flap.

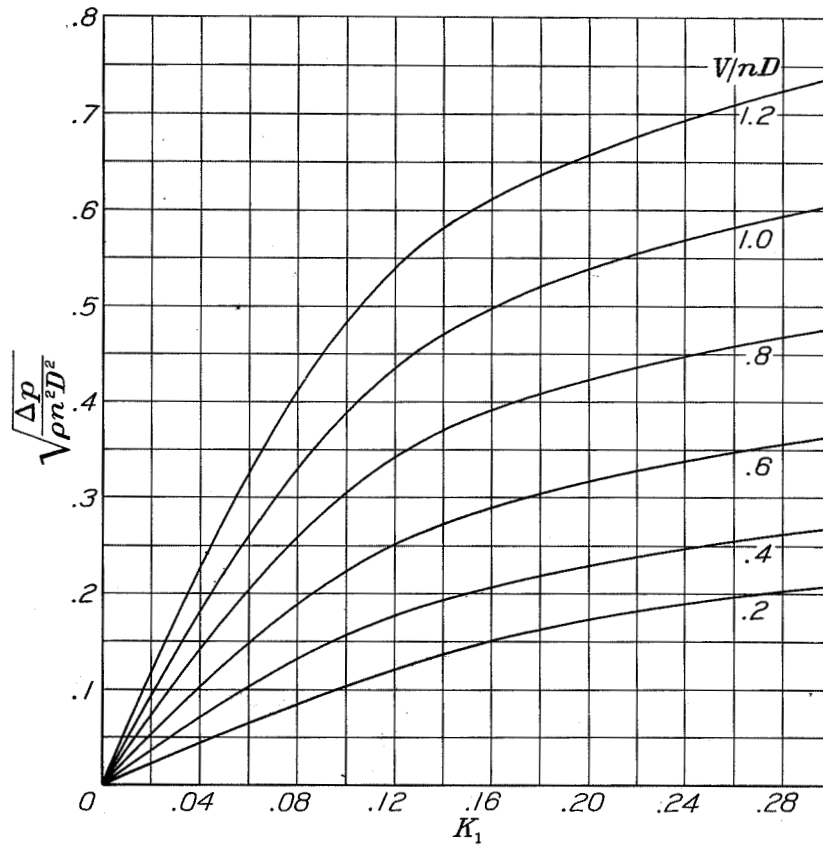

Figure 9.- Variation of pressure coefficient with exit area. Adjustable cowling flaps.

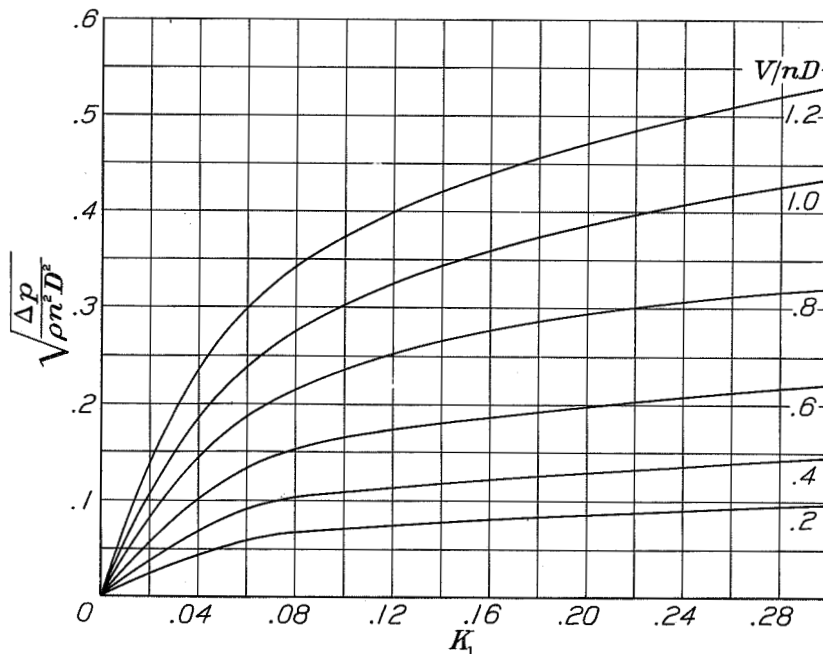

Figure 10.- Variation of pressure coefficient with exit area. Adjustable-length cowling skirt.

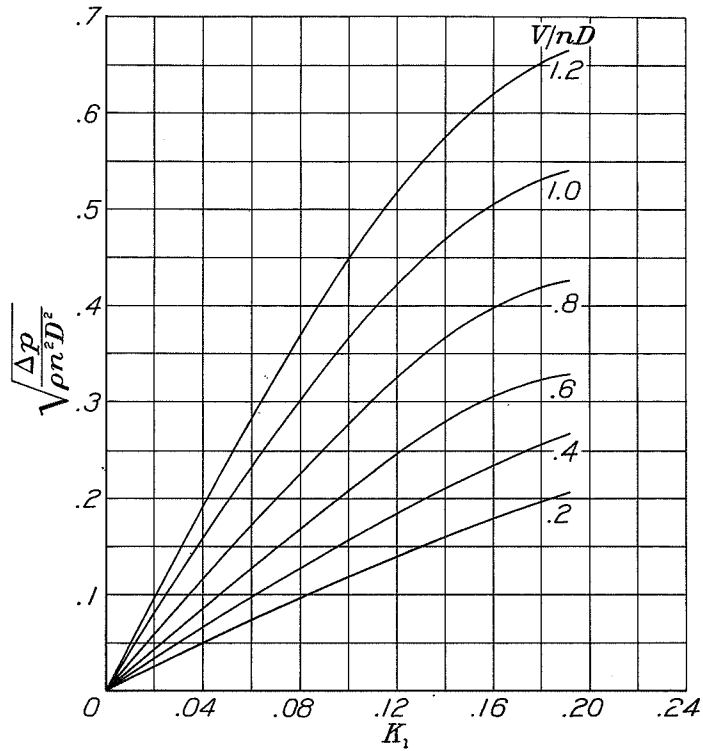

Figure 11.- Variation of pressure coefficient with exit area. Bottom opening with adjustable flap.

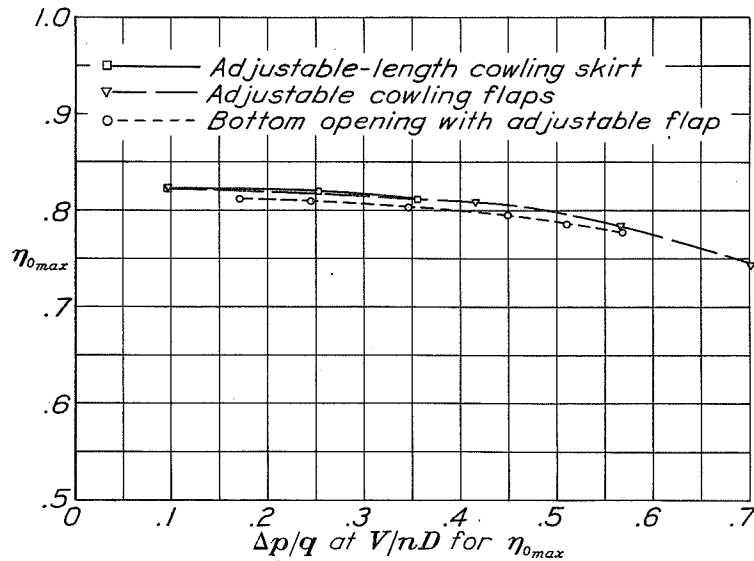

Figure 12.- Variation of η_{0max} with $\Delta p/q$ for various types of cowling exit-area control.