

# PIPER Continuous Adiabatic Demagnetization Refrigerator

Mark O. Kimball<sup>1</sup>, Peter. J. Shirron<sup>1</sup>, Edgar R. Canavan<sup>1</sup>, Bryan L. James<sup>1</sup>,  
Michael A. Sampson<sup>2</sup>, and Richard V. Letmate<sup>3</sup>

<sup>1</sup> NASA / Goddard Space Flight Center

<sup>2</sup> Stinger Ghaffarian Technologies, Inc. (SGT)

<sup>3</sup> ATA Aerospace

# Overview of PIPER Science



## Primordial Inflation Polarization Explorer

- Goal is to measure a polarization of the Cosmic Microwave Background if it exists
  - Theory predicts this to be a consequence of cosmological inflation shortly after the Big Bang
- Balloon-based mission
  - Open bucket Dewar attached to balloon contains thousands of liters of liquid helium
- Two Backshort-Under-Grid (BUG) superconducting transition-edge sensors detectors developed at NASA/GSFC measure signal ( $> 5000$  pixels)
- Polarization capability provided by grid of closely-spaced copper-coated tungsten wires placed in front of the detector arrays

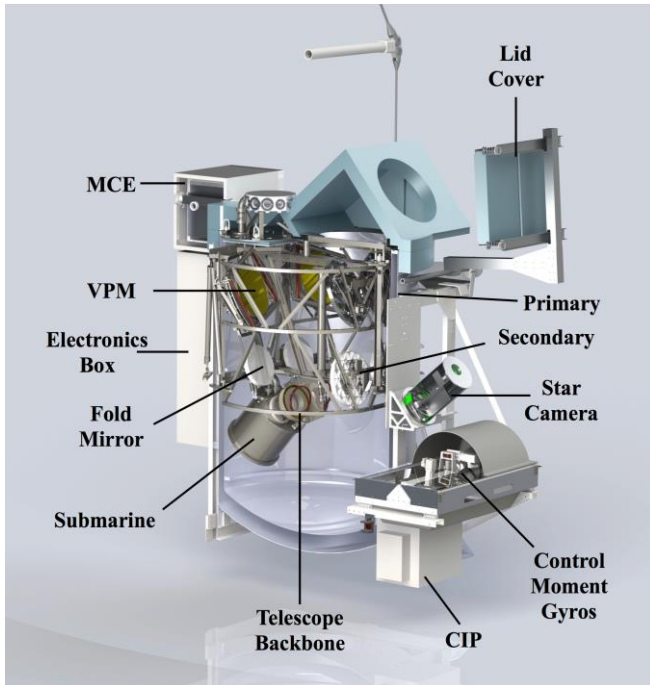

Credit: Natalie N. Gandilo et al., Image in poster presented at the 229<sup>th</sup> Meeting of the American Astronomical Society

# Overview of PIPER Detector

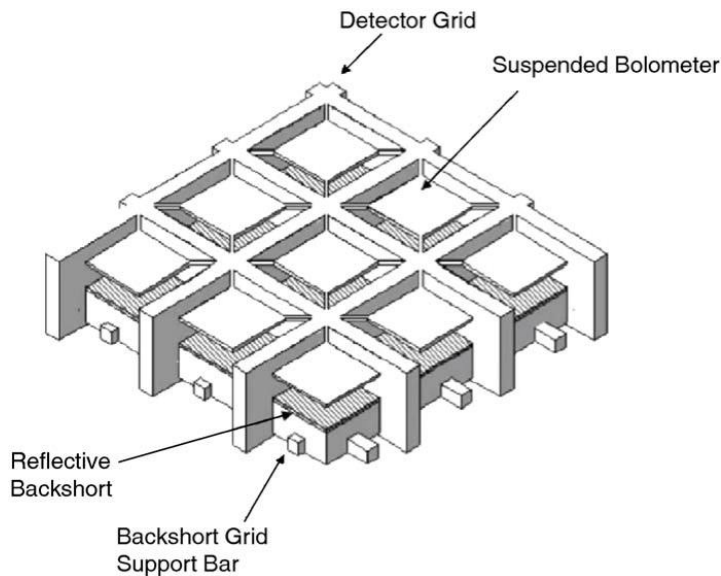
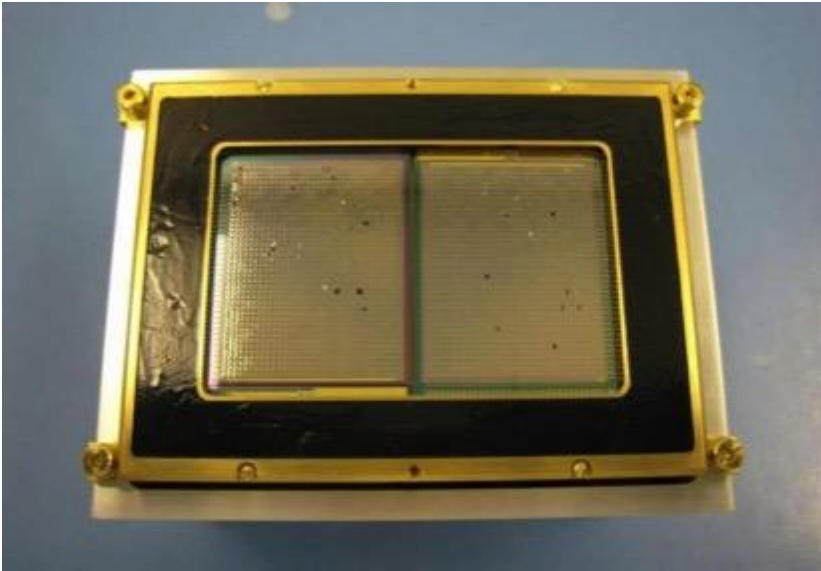

- Backshort-Under-Grid (BUG) Detector
- Developed in the 2000s at NASA/GSFC
  - First demonstrated in a 30-meter ground-based telescope in Spain → GIZMO
  - Bolometer absorbers connected to transition-edge sensors
  - Superconducting to normal transition relatively sharp == great thermometer if one can work at the transition temperature
  - Adiabatic Demagnetization Refrigerator cools sensors to the proper temperature range for operation

# Adiabatic Demagnetization Refrigeration

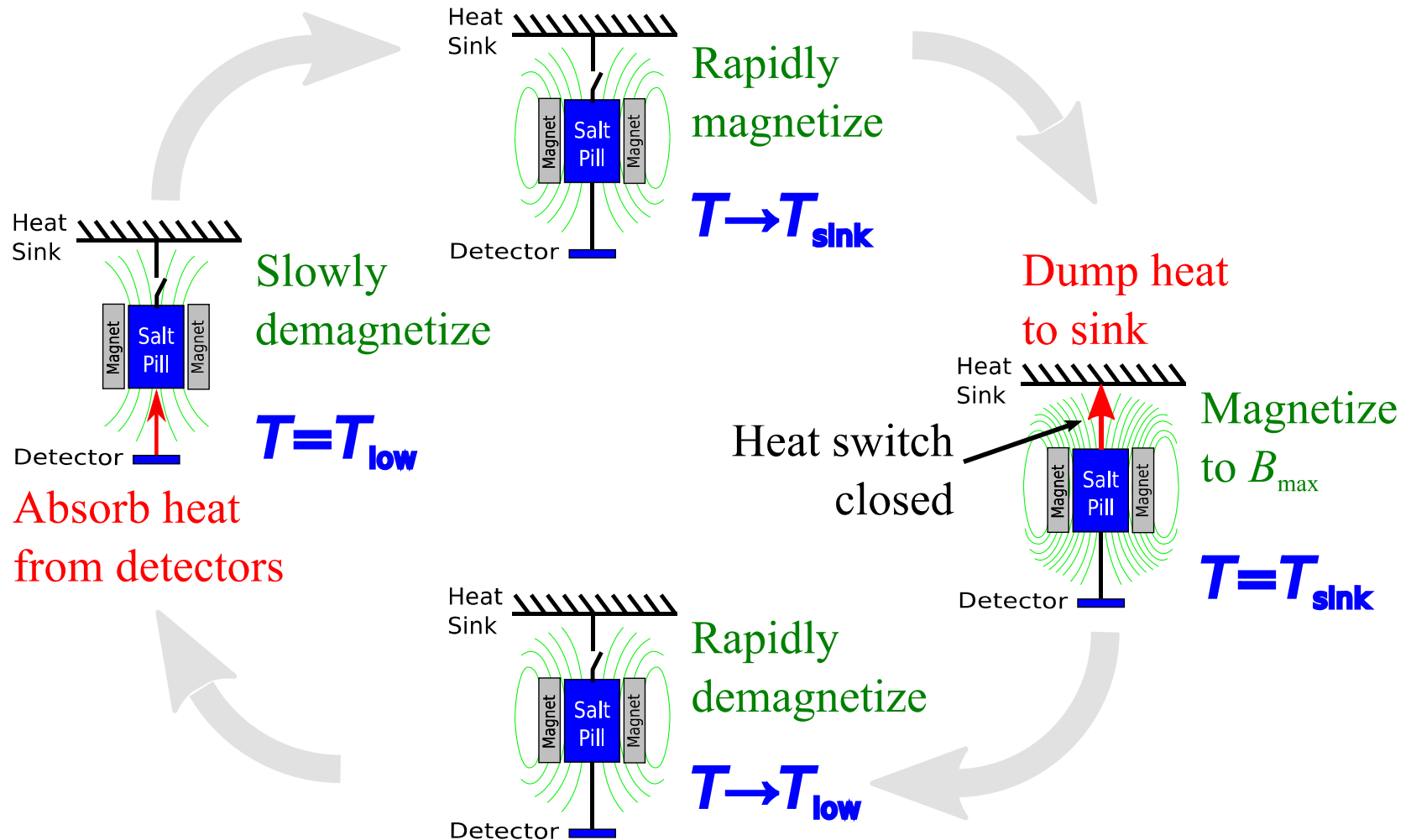

# ADR Multi-Stage System

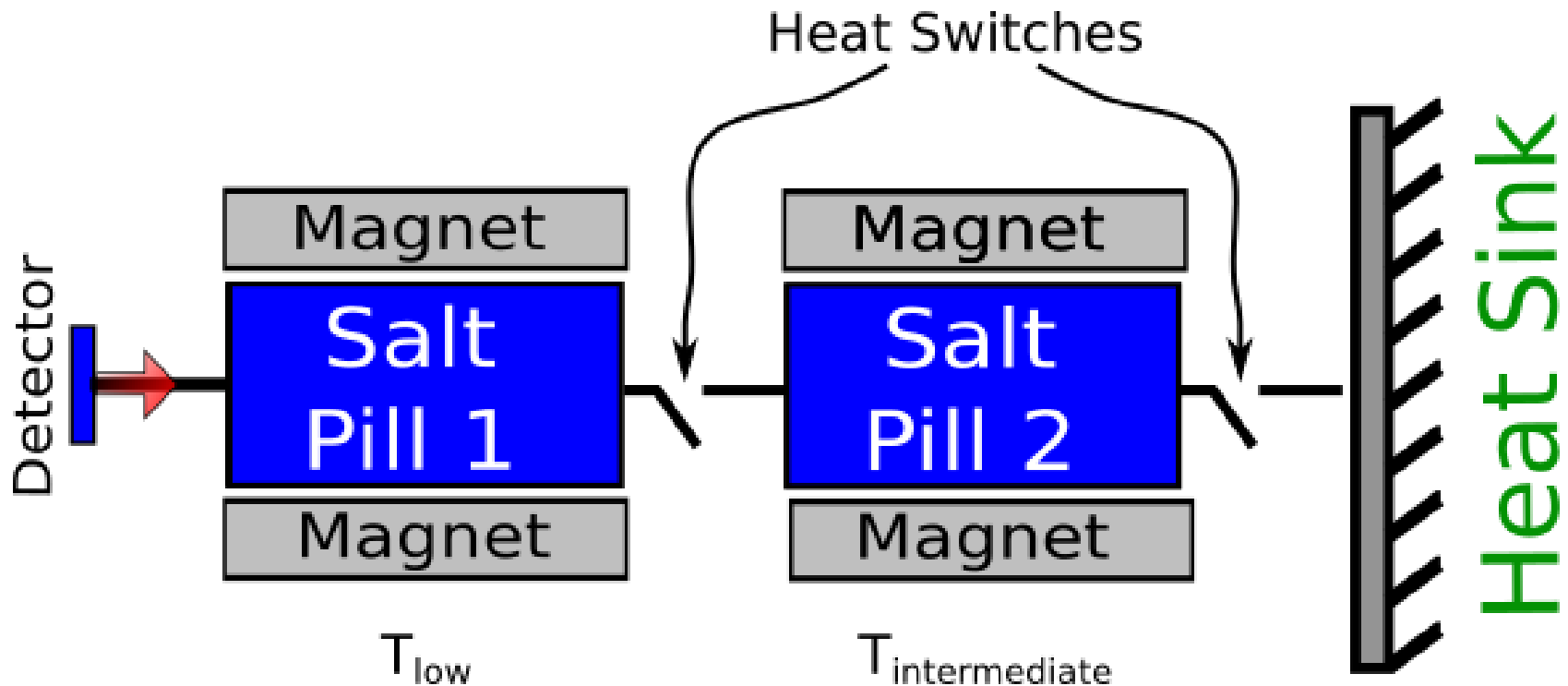

# Continuous ADR

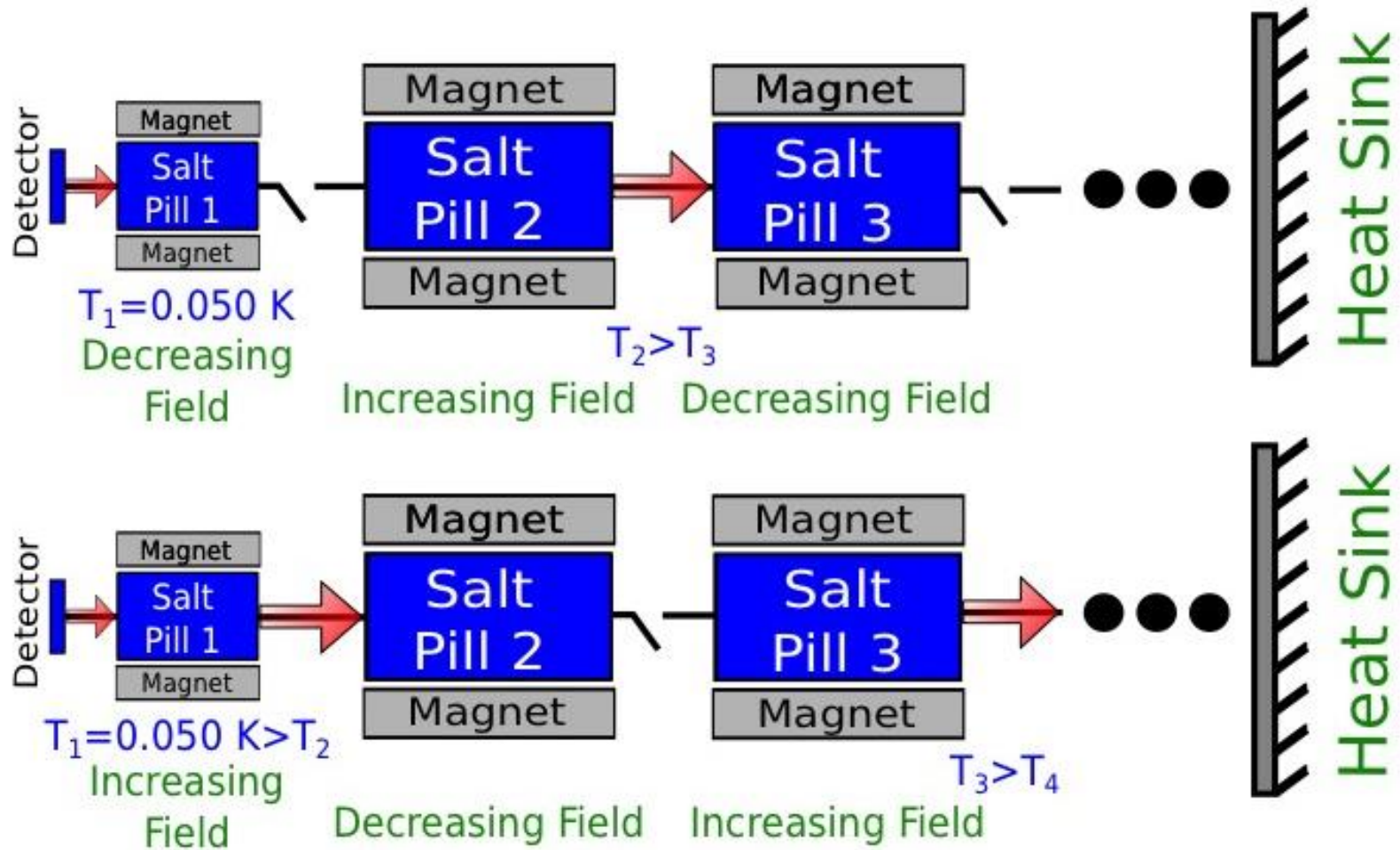

# CADR



## 4 Stages

- ① 45 g CPA [0.100 K]
- ② 100 g CPA [0.375 -> 0.09 K]
- ③ 100 g CPA [1.4 -> 0.275 K]
- ④ 82 g GGG [3 -> 1.2 K]

## Heat Switches

- ① Superconducting Switch (1 -> 2)
- ② Passive Gas-Gap (2 -> 3)
- ③ Passive Gas-Gap (3 -> 4)
- ④ Internal Passive Gas-Gap (4 -> H.S.)

# PIPER CADR

## 4 Stages

- ① 45 g CPA [0.100 K]
- ② 100 g CPA [0.375 -> 0.09 K]
- ③ 100 g CPA [1.4 -> 0.275 K]
- ④ 82 g GGG [3 -> 1.2 K]

## Heat Switches

- ① Superconducting Switch (1 -> 2)
- ② Passive Gas-Gap (2 -> 3)
- ③ Passive Gas-Gap (3 -> 4)
- ④ Internal Passive Gas-Gap (4 -> H.S.)

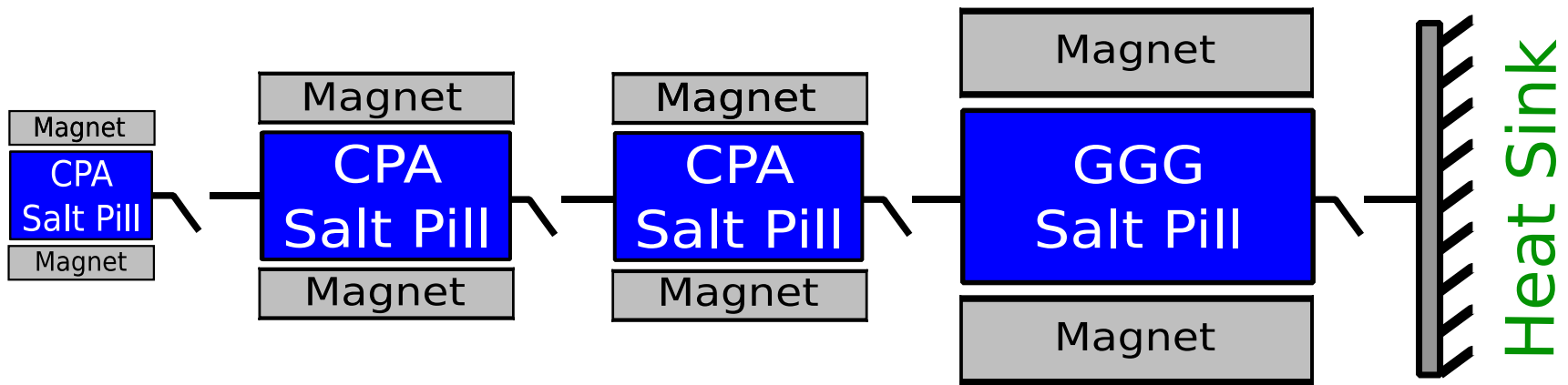



# Passive Gas-Gap Heat Switches



- Passively close when temperature of associated stage warms above some value, open
  - More thermodynamically efficient since no additional heat added to system
- Thin (0.127 mm) titanium outer shell
- Gold-plated copper innards consist of inter-digitated fins
- Getter typically sintered stainless pucks or the copper fins themselves

# Stage 4 Passive GGHS Internal to Stage

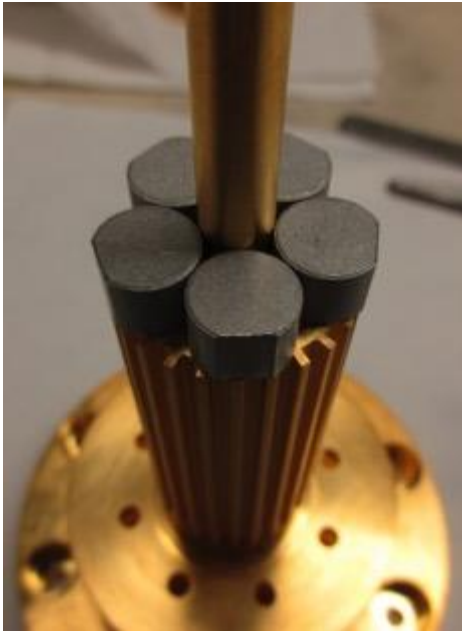

- One set of “fins” is the salt pill
- Other set the magnet itself
  - $\sim 0.8$  mm gap between adjacent pair of fins
- Sintered 300 CRES getters epoxied onto the pill provide attractive surface for He-3
  - If  $^3\text{He}$  between sets of fins, switch on
  - When  $^3\text{He}$  to CRES binding energy greater than some temperature, switch turns off
- Room-temperature fill level sets the transition temperature
  - 4 torr fill provides transition  $\sim 1.2$  K

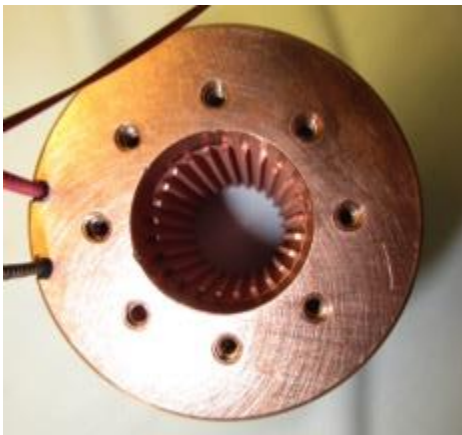

# Superconducting Heat Switch

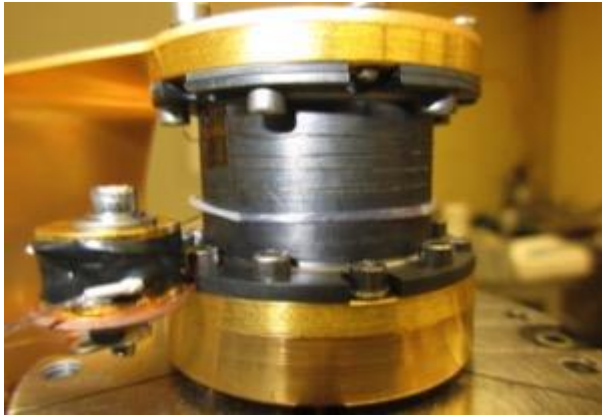

- Positioned between stages 1 and 2
- Two halves of switch separated by a length of lead wire
  - When lead in superconducting state, switch open
  - When lead in normal state, switch closed
  - Magnetic field from helmholtz coils switches state
- Quick switching time
- Works in a temperature regime where gas in a GGHS is absorbed fully

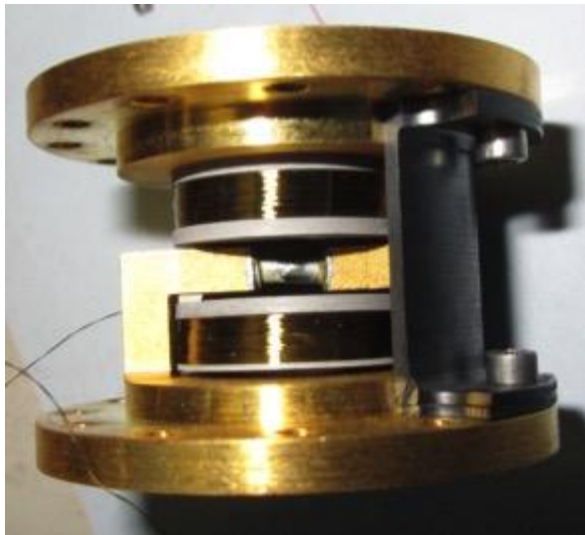

# S2,3 Salt Pill Suspensions

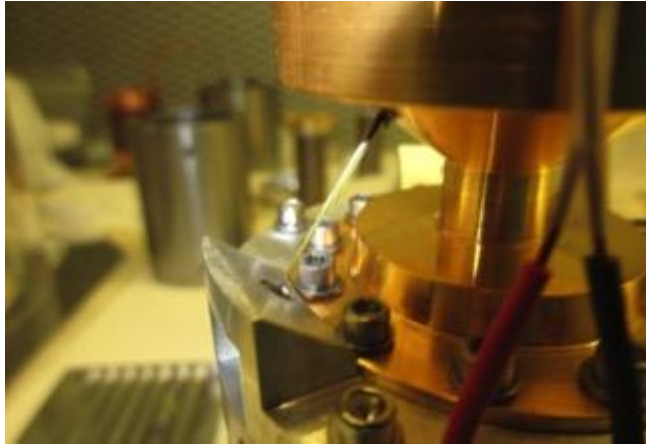

A total of 6 Kevlar bundles suspend the paramagnetic salt pill within the bore of a superconducting magnet

- Magnet temperature: 3 K
- Pill temperatures often below 1 K
- Kevlar assemblies made on the bench then installed
  - Button head screw on outside attachment point
  - “D-shaped” screw threaded through inner attachment point
  - Tensioned via a nut and locked with a second nut
- Estimated heat lead from 3 to 0.1 K: 4.4  $\mu\text{W}$

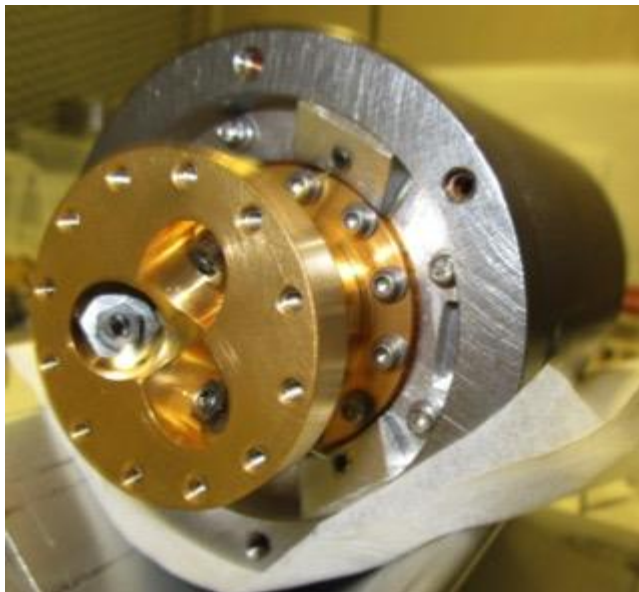

# S4 Salt Pill Suspension

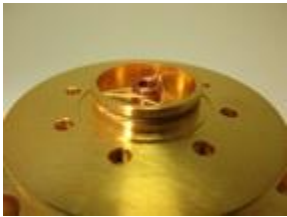

- 300 CRES bellows isolates one end
- Thin Vespel SP1 spool provides structural support
- Six Kevlar bundles suspend other end

# Plots of Temperatures and Currents

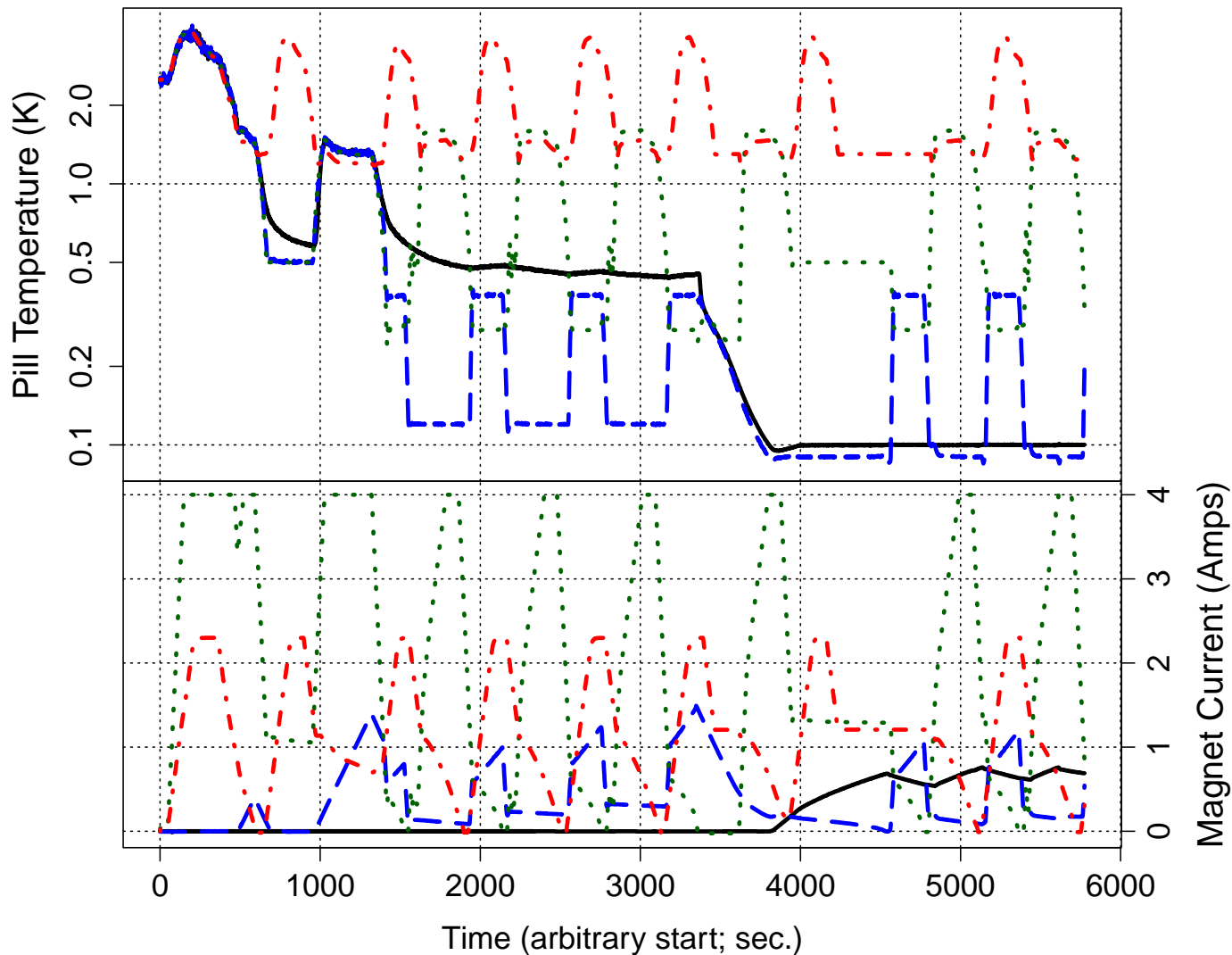

# Thermodynamic Plots

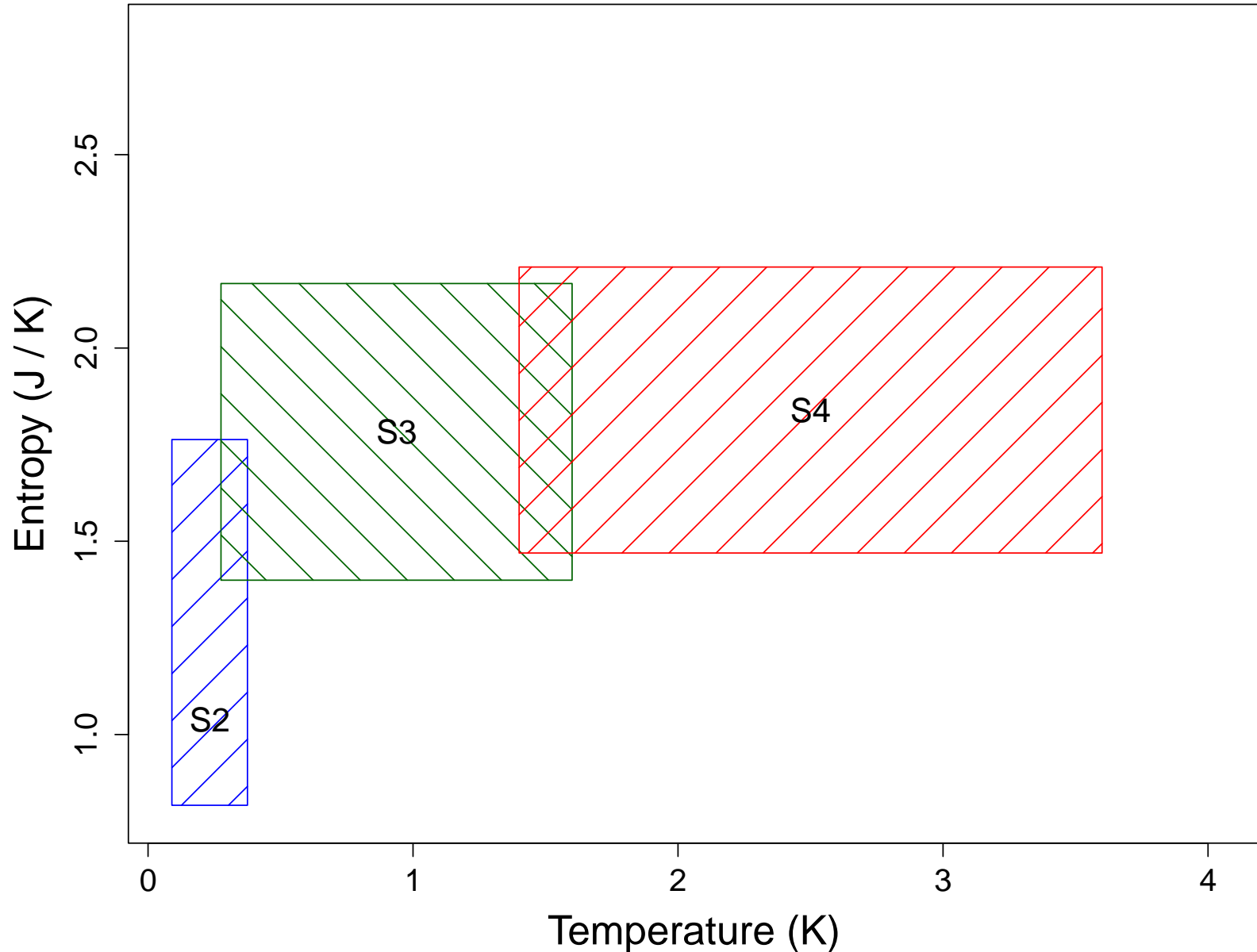

# Thermodynamic Plots

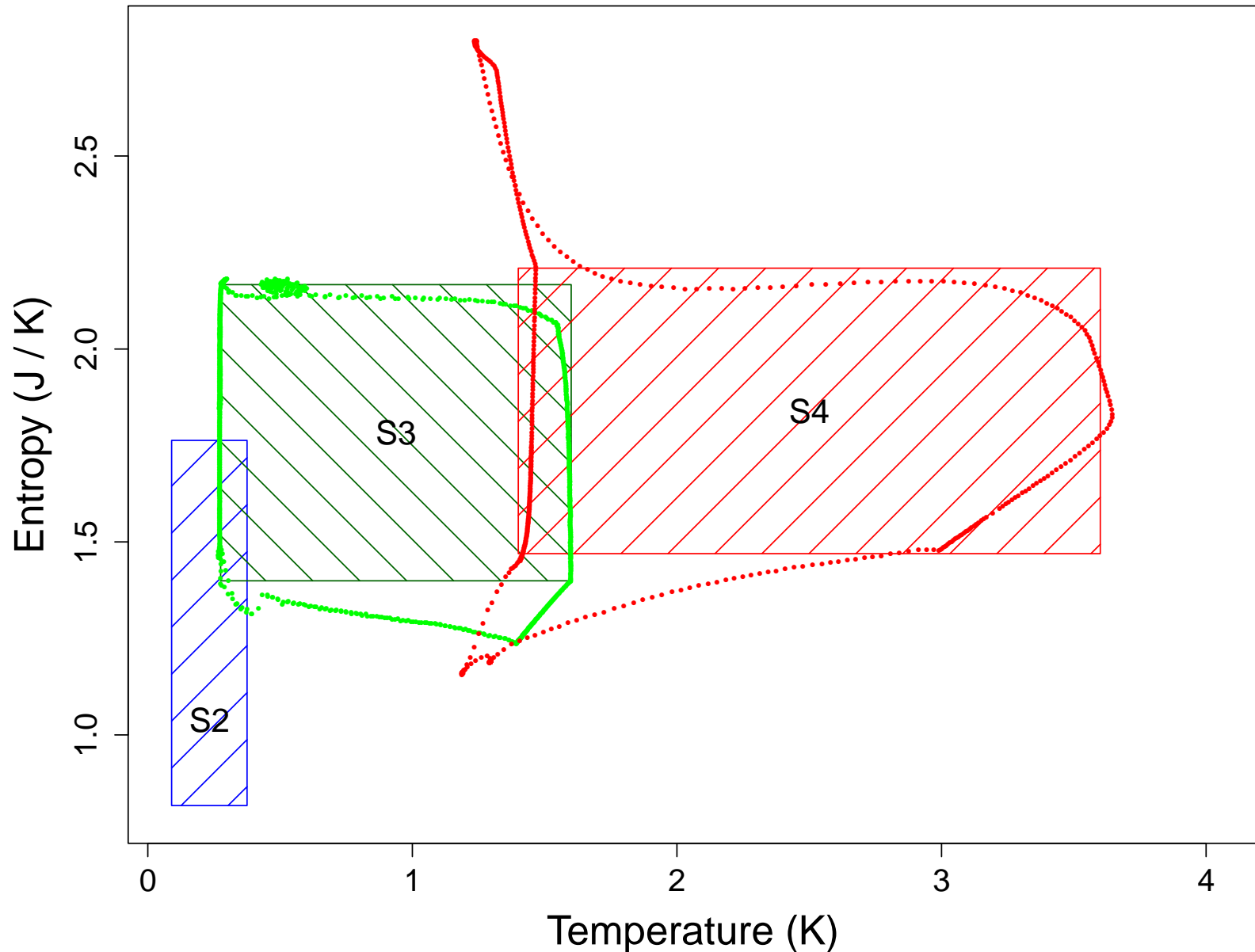



# Heat Lift etc.

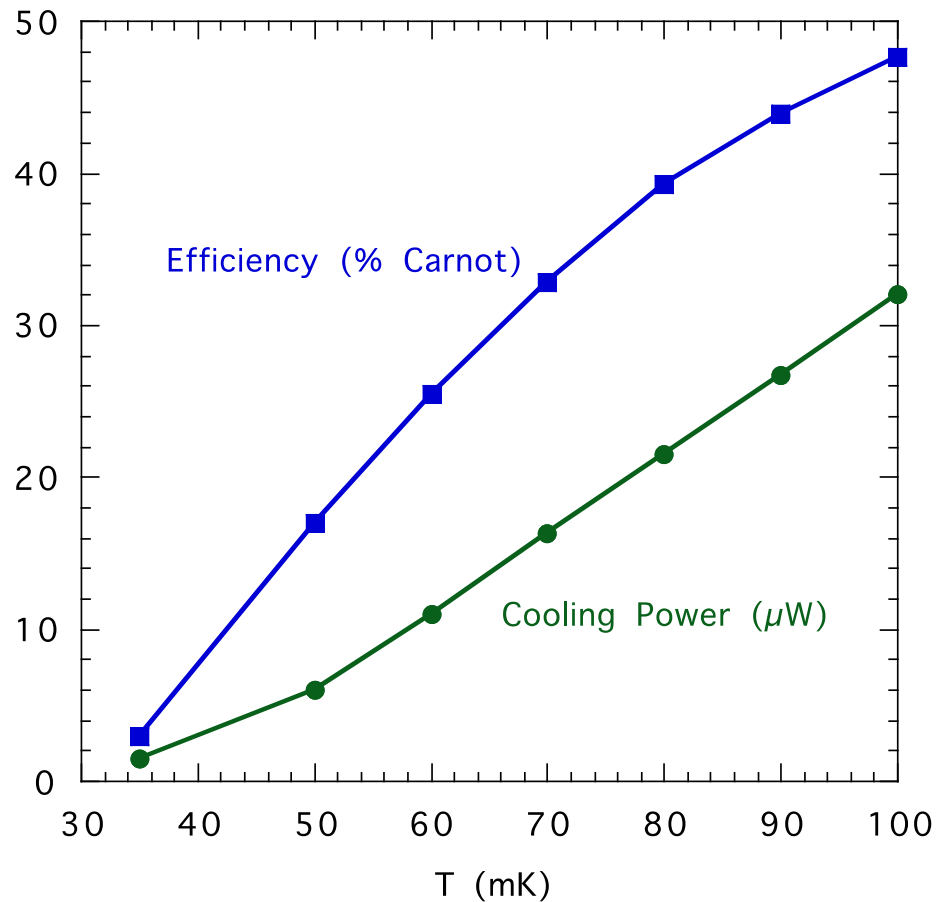

CADR was developed using research money provided by NASA/GSFC in the early 2000's

- Measured cooling powers and overall efficiency measured for that system
- Taking data on new system now and will compare the two systems
  - Expect new system to have a lower available cooling power due to stronger Kevlar suspensions

\* Cooling power in addition to parasitic heat loads

# Many Possibilities

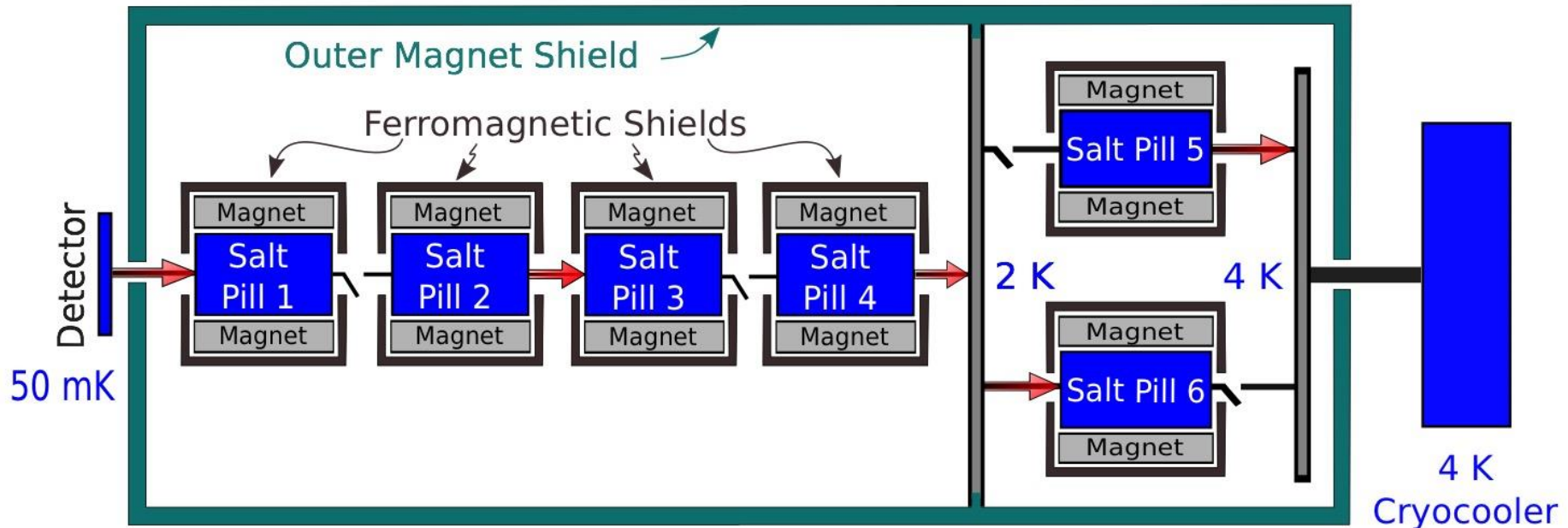

Two, or more, unique continuous temperatures possible

- Asynchronous CADR
- In this example, one is a 2 K, the other 0.050 K

# Summary

- 4-stage continuous ADR built for the PIPER balloon mission is in testing currently
- Demonstrated continuous operation at 80 mK with a total heat lift of  $> 30 \mu\text{W}$ 
  - Includes parasitic heat to coldest stage
  - Usable cooling power decreased by testing environment (vibrational heating from cooler)
  - Need to modify environment by either dampening cooler or moving to flight Dewar cooled via liquid helium
- Since the CADR has a higher cooling power for the same mass as a single-shot system, we believe this technology will be baselined for future missions